

FCC TEST REPORT

For

Shearwater Research Inc.

Teric

Model No.: 25004-01

Prepared For : Shearwater Research Inc.
Address : Unit 250 13155 Delf Place Richmond, BC , Canada

Prepared By : Shenzhen Anbotek Compliance Laboratory Limited
Address : 1/F, Building D, Sogood Science and Technology Park, Sanwei
community, Hangcheng Street, Bao'an District, Shenzhen, Guangdong,
China.518102
Tel: (86) 755-26066365 Fax: (86) 755-26014772

Report Number : SZAWW180122020-01
Date of Test : Jan. 22~31, 2018
Date of Report : Jan. 31, 2018

Contents

1. General Information.....	4
1.1. Client Information.....	4
1.2. Description of Device (EUT).....	4
1.3. Auxiliary Equipment Used During Test.....	4
1.4. Description of Test Modes.....	5
1.5. List of channels.....	5
1.6. Description Of Test Setup.....	6
1.7. Test Equipment List.....	7
1.8. Measurement Uncertainty.....	8
1.9. Description of Test Facility.....	8
2. Summary of Test Results.....	9
3. Conducted Emission Test.....	10
3.1. Test Standard and Limit.....	10
3.2. Test Setup.....	10
3.3. Test Procedure.....	10
3.4. Test Data.....	10
4. Radiation Spurious Emission and Band Edge.....	15
4.1. Test Standard and Limit.....	15
4.2. Test Setup.....	15
4.3. Test Procedure.....	16
4.4. Test Data.....	17
APPENDIX I -- TEST SETUP PHOTOGRAPH.....	21
APPENDIX II -- EXTERNAL PHOTOGRAPH.....	23
APPENDIX III -- INTERNAL PHOTOGRAPH.....	27

TEST REPORT

Applicant : Shearwater Research Inc.
Manufacturer : Shenzhen Welldy Technology Co., Limited
Product Name : Teric
Model No. : 25004-01
Trade Mark : N/A
Rating(s) : Input: DC 5V 1.5A
 : Output: DC 5V 1A

Test Standard(s) : FCC Part15 Subpart C 2017, Paragraph 15.209

Test Method(s) : ANSI C63.10: 2013

The device described above is tested by Shenzhen Anbotek Compliance Laboratory Limited to determine the maximum emission levels emanating from the device and the severe levels of the device can endure and its performance criterion. The measurement results are contained in this test report and Shenzhen Anbotek Compliance Laboratory Limited is assumed full of responsibility for the accuracy and completeness of these measurements. Also, this report shows that the EUT (Equipment Under Test) is technically compliant with the FCC Part 15 Subpart C requirements.

This report applies to above tested sample only and shall not be reproduced in part without written approval of Shenzhen Anbotek Compliance Laboratory Limited.

Date of Test : Jan. 22~31, 2018

Prepared by :



Winkey Wang

(Tested Engineer / Winkey Wang)

Reviewer :

Tangcy. T.

(Project Manager / Tangcy. T)

Approved & Authorized Signer :

Tom Chen

(Manager / Tom Chen)

1. General Information

1.1. Client Information

Applicant	:	Shearwater Research Inc.
Address	:	Unit 250 13155 Delf Place Richmond, BC , Canada
Manufacturer	:	Shenzhen Welldy Technology Co., Limited
Address	:	2F, Building 6, Sinpool Pioneer Park, Shangtang Intersection, Gongye Road, Longhua new District, Shenzhen

1.2. Description of Device (EUT)

Product Name	:	Teric	
Model No.	:	25004-01	
Trade Mark	:	N/A	
Test Power Supply	:	AC 120V, 60Hz for adapter/AC 240V, 60Hz for adapter	
Product Description	:	Operation Frequency:	110-205KHz
		Number of Channel:	20 Channels
		Modulation Type:	MSK
		Antenna Type:	Loop Antenna
		Antenna Gain(Peak):	0 dBi
Remark: 1) For a more detailed features description, please refer to the manufacturer's specifications or the User's Manual.			

1.3. Auxiliary Equipment Used During Test

Adapter	:	Manufacturer: ZTE M/N: STC-A2050I1000USBA-C S/N: 201202102100876 Input: 100-240V~50/60Hz 0.3A Output: DC 5V, 1000mA
With	:	Load

1.4. Description of Test Modes

To investigate the maximum EMI emission characteristics generated from EUT, the test system was pre-scanning tested based on the consideration of following EUT operation mode or test configuration mode which possibly have effect on EMI emission level. Each of these EUT operation mode(s) or test configuration mode(s) mentioned above was evaluated respectively.

Pretest Mode	Description
Mode 1	CH01
Mode 2	CH10
Mode 3	CH20
Mode 4	Keeping TX+Charging mode

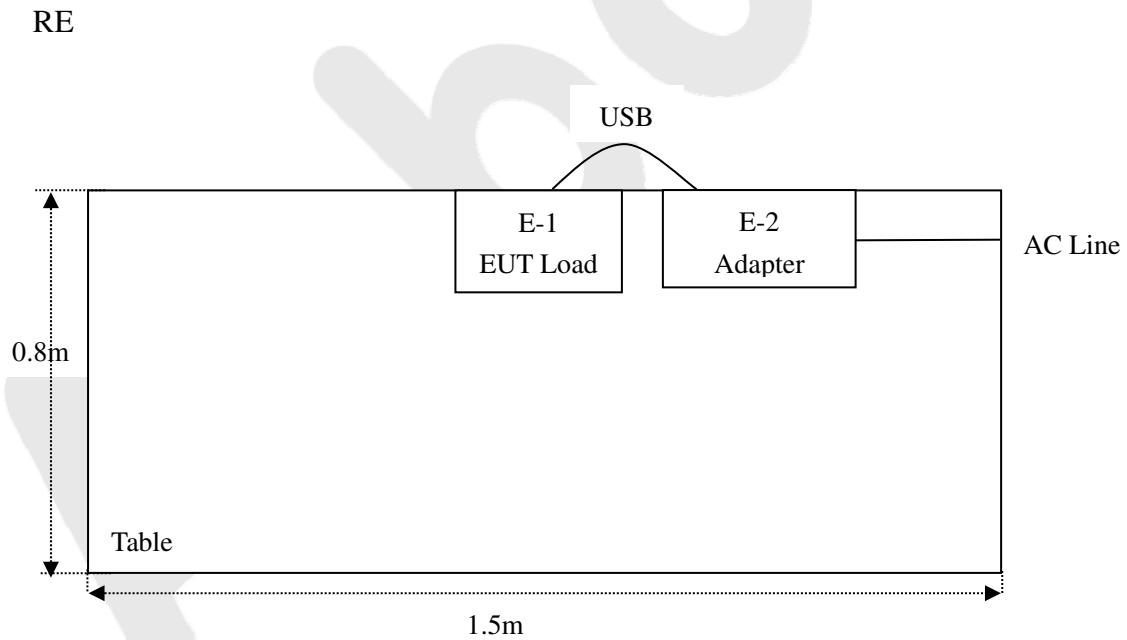
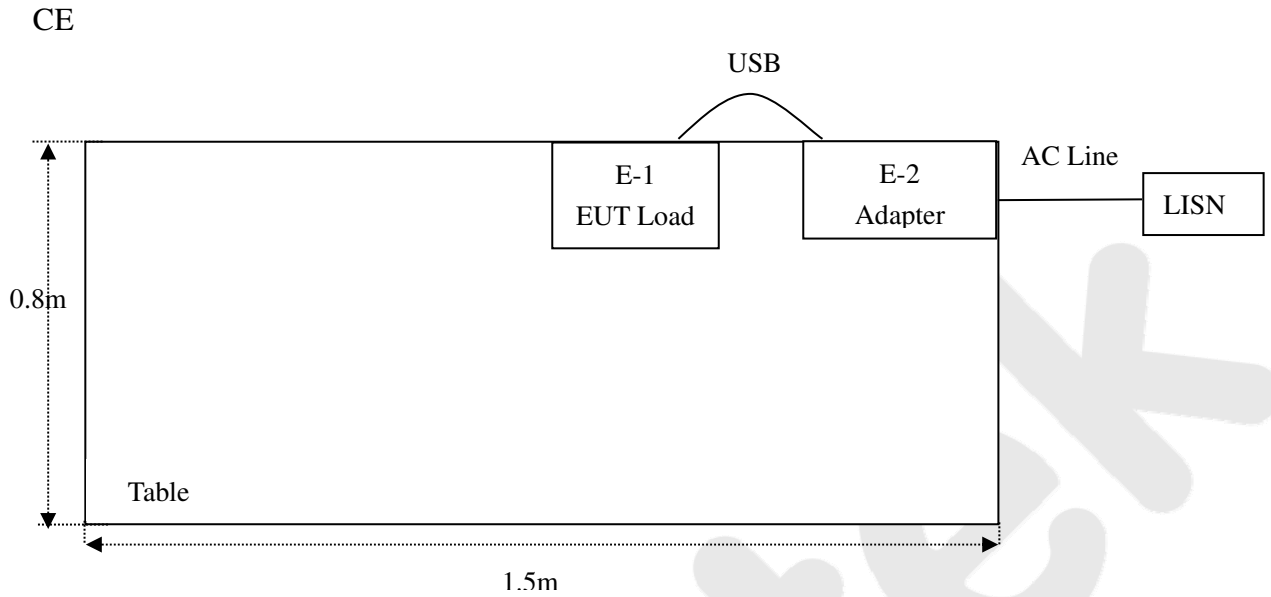
For Conducted Emission	
Final Test Mode	Description
Mode 4	Keeping TX+Charging mode

For Radiated Emission	
Final Test Mode	Description
Mode 1	CH01
Mode 2	CH10
Mode 3	CH20
Mode 4	Keeping TX+Charging mode

1.5. List of channels

Channel	Freq. (MHz)	Channel	Freq. (MHz)	Channel	Freq. (MHz)	Channel	Freq. (MHz)
1	0.110	6	0.135	11	0.160	16	0.185
2	0.115	7	0.140	12	0.165	17	0.190
3	0.120	8	0.145	13	0.170	18	0.195
4	0.125	9	0.150	14	0.175	19	0.200
5	0.130	10	0.155	15	0.180	20	0.205

1.6. Description Of Test Setup



1.7. Test Equipment List

Item	Equipment	Manufacturer	Model No.	Serial No.	Last Cal.	Cal. Interval
1.	L.I.S.N. Artificial Mains Network	Rohde & Schwarz	ENV216	100055	Nov. 17, 2017	1 Year
2.	EMI Test Receiver	Rohde & Schwarz	ESCI	100627	Nov. 17, 2017	1 Year
3.	RF Switching Unit	Compliance Direction	RSU-M2	38303	Nov. 17, 2017	1 Year
4.	Spectrum Analysis	Agilent	E4407B	US39390582	Nov. 17, 2017	1 Year
5.	Spectrum Analysis	Agilent	N9038A	MY53227295	Nov. 17, 2017	1 Year
6.	Preamplifier	SKET Electronic	BK1G18G3 0D	KD17503	Nov. 17, 2017	1 Year
7.	EMI Test Receiver	Rohde & Schwarz	ESPI	101604	Nov. 17, 2017	1 Year
8.	Double Ridged Horn Antenna	Instruments corporation	GTH-0118	351600	Nov. 20, 2017	1 Year
9.	Bilog Broadband Antenna	Schwarzbeck	VULB9163	VULB 9163-289	Nov. 20, 2017	1 Year
10.	Loop Antenna	Schwarzbeck	HFH2-Z2	100047	Nov. 17, 2017	1 Year
11.	Horn Antenna	Schwarzbeck	BBHA9170	9170-375	Nov. 17, 2017	1 Year
12.	Pre-amplifier	SONOMA	310N	186860	Nov. 17, 2017	1 Year
13.	EMI Test Software EZ-EMC	SHURPLE	N/A	N/A	N/A	N/A
14.	RF Test Control System	YIHENG	YH3000	2017430	Nov. 18, 2017	1 Year
15.	Power Sensor	DAER	RPR3006W	15I00041SN045	Nov. 17, 2017	1 Year
16.	Power Sensor	DAER	RPR3006W	15I00041SN046	Nov. 17, 2017	1 Year
17.	MXA Spectrum Analysis	Agilent	N9020A	MY51170037	Nov. 18, 2017	1 Year
18.	MXG RF Vector Signal Generator	Agilent	N5182A	MY48180656	Nov. 18, 2017	1 Year
19.	Signal Generator	Agilent	E4421B	MY41000743	Nov. 18, 2017	1 Year
20.	DC Power Supply	LW	TPR-6410D	349315	Nov. 01, 2017	1 Year
21.	Constant Temperature Humidity Chamber	Sertep	ZJ-HWHS8 0B	ZJ-17042804	Nov. 01, 2017	1 Year

1.8. Measurement Uncertainty

Radiation Uncertainty	:	Ur = 4.1 dB (Horizontal)
		Ur = 4.3 dB (Vertical)
Conduction Uncertainty	:	Uc = 3.4dB

1.9. Description of Test Facility

The test facility is recognized, certified, or accredited by the following organizations:

FCC-Registration No.: 184111

Shenzhen Anbotek Compliance Laboratory Limited, EMC Laboratory has been registered and fully described in a report filed with the (FCC) Federal Communications Commission. The acceptance letter from the FCC is maintained in our files. Registration No. 184111, July 31, 2017.

ISED-Registration No.: 8058A-1

Shenzhen Anbotek Compliance Laboratory Limited, EMC Laboratory has been registered and fully described in a report filed with the (ISED) Innovation, Science and Economic Development Canada. The acceptance letter from the ISED is maintained in our files. Registration 8058A-1, June 13, 2016.

Test Location

All Emissions tests were performed at Shenzhen Anbotek Compliance Laboratory Limited. at 1/F, Building D, Sogood Science and Technology Park, Sanwei community, Hangcheng Street, Bao'an District, Shenzhen, Guangdong, China.518102

2. Summary of Test Results

Standard Section	Test Item	Result
FCC Part 15, Paragraph 15.207	Conducted Emission Test	PASS
FCC Part 15, Paragraph 15.209(a)(f)	Spurious Emission	PASS

Anbotek

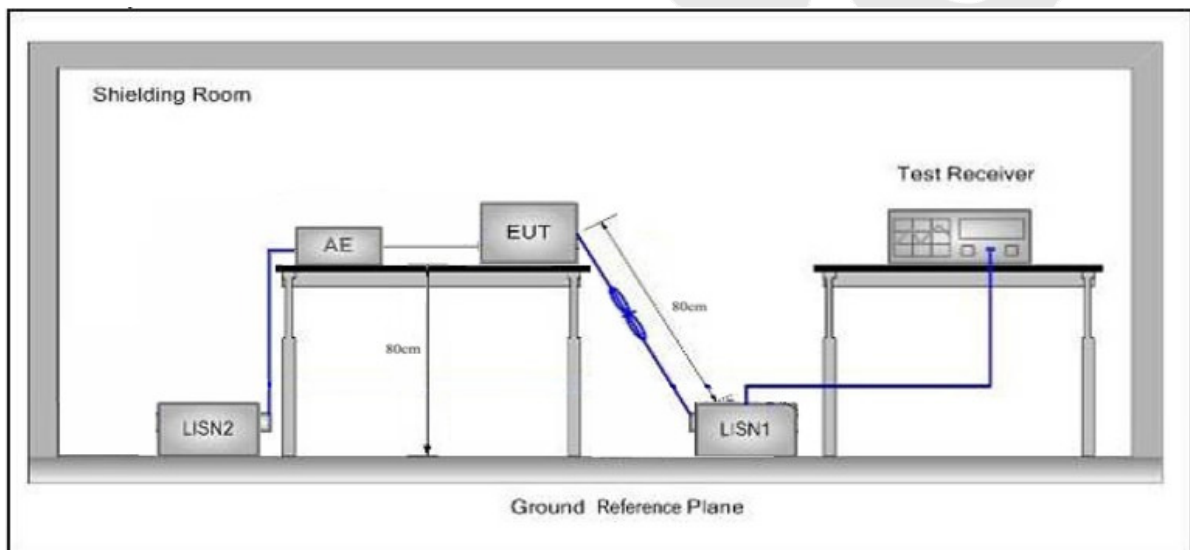
3. Conducted Emission Test

3.1. Test Standard and Limit

Test Standard	FCC Part15 Section 15.207		
Test Limit	Frequency	Maximum RF Line Voltage (dBuV)	
		Quasi-peak Level	Average Level
	150kHz~500kHz	66 ~ 56 *	56 ~ 46 *
	500kHz~5MHz	56	46
5MHz~30MHz	60	50	

Remark: (1) *Decreasing linearly with logarithm of the frequency.
(2) The lower limit shall apply at the transition frequency.

3.2. Test Setup



3.3. Test Procedure

The EUT system is connected to the power mains through a line impedance stabilization network (L.I.S.N.). This provides a 50ohm coupling impedance for the EUT system. Please refer the block diagram of the test setup and photographs. Both sides of AC line are checked to find out the maximum conducted emission. In order to find the maximum emission levels, the relative positions of equipment and all of the interface cables shall be changed according to FCC ANSI C63.10-2013 on Conducted Emission Measurement.

The bandwidth of test receiver (ESCI) set at 9kHz.

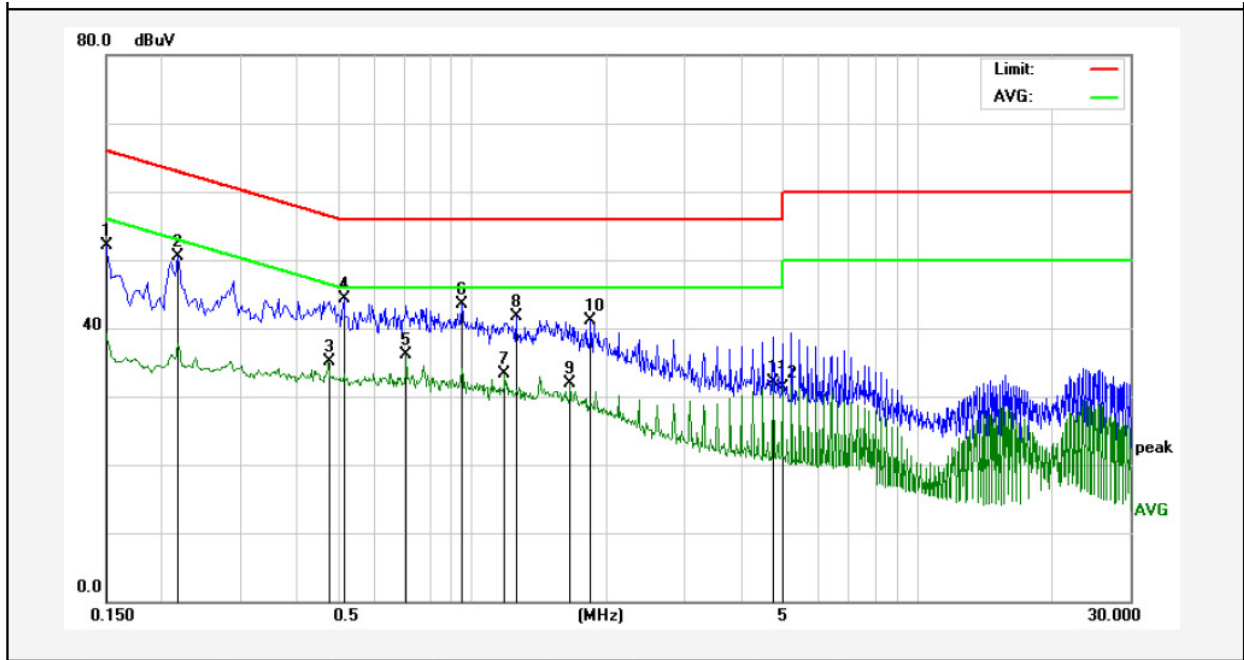
The frequency range from 150kHz to 30MHz is checked.

3.4. Test Data

Please to see the following pages

Conducted Emission Test Data

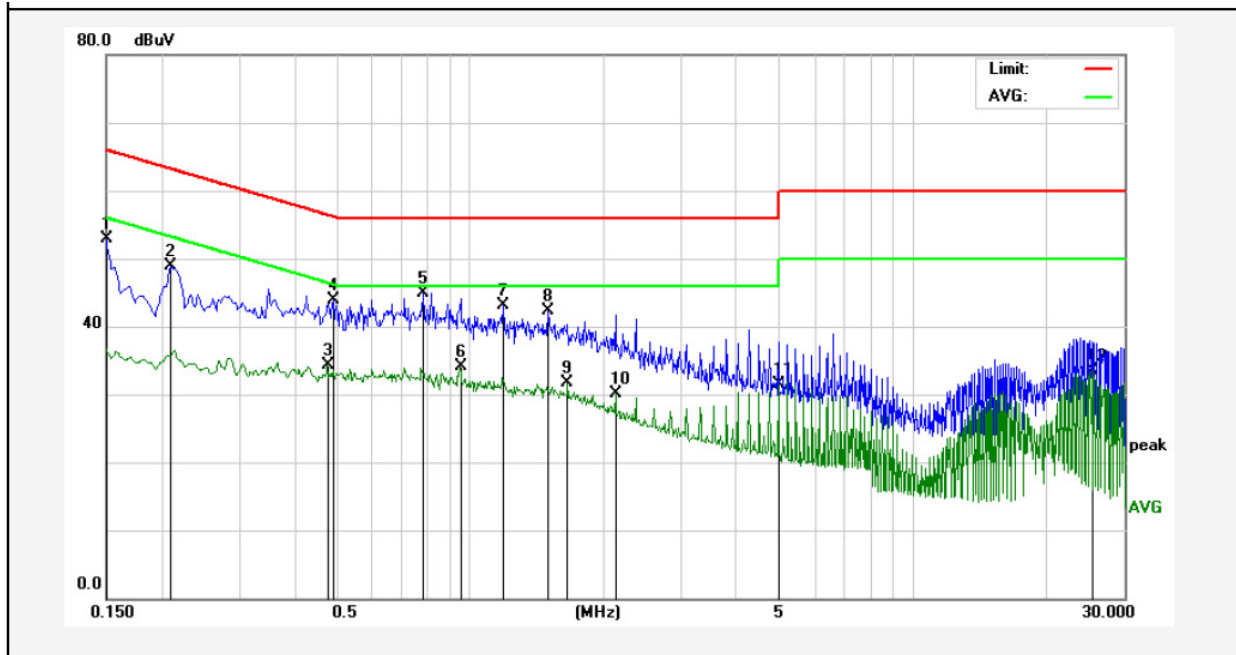
Test Site: 1# Shielded Room
 Operating Condition: Keeping TX+Charging mode
 Test Specification: AC 120V, 60Hz for adapter
 Comment: Live Line
 Tem.:25.4°C Hum.:54%



No.	Freq. (MHz)	Reading (dBuV)	Factor (dB)	Result (dBuV)	Limit dBuV	Over Limit (dB)	Detector	Remark
1	0.1500	34.14	17.90	52.04	65.99	-13.95	QP	
2	0.2180	32.54	17.90	50.44	62.89	-12.45	QP	
3	0.4740	17.20	17.97	35.17	46.44	-11.27	AVG	
4	0.5140	26.32	17.98	44.30	56.00	-11.70	QP	
5	0.7100	18.05	18.04	36.09	46.00	-9.91	AVG	
6	0.9460	25.38	18.11	43.49	56.00	-12.51	QP	
7	1.1820	15.21	18.12	33.33	46.00	-12.67	AVG	
8	1.2500	23.50	18.12	41.62	56.00	-14.38	QP	
9	1.6540	13.72	18.13	31.85	46.00	-14.15	AVG	
10	1.8420	22.90	18.14	41.04	56.00	-14.96	QP	
11	4.7300	13.83	18.20	32.03	46.00	-13.97	AVG	
12	4.9660	13.04	18.21	31.25	46.00	-14.75	AVG	

Conducted Emission Test Data

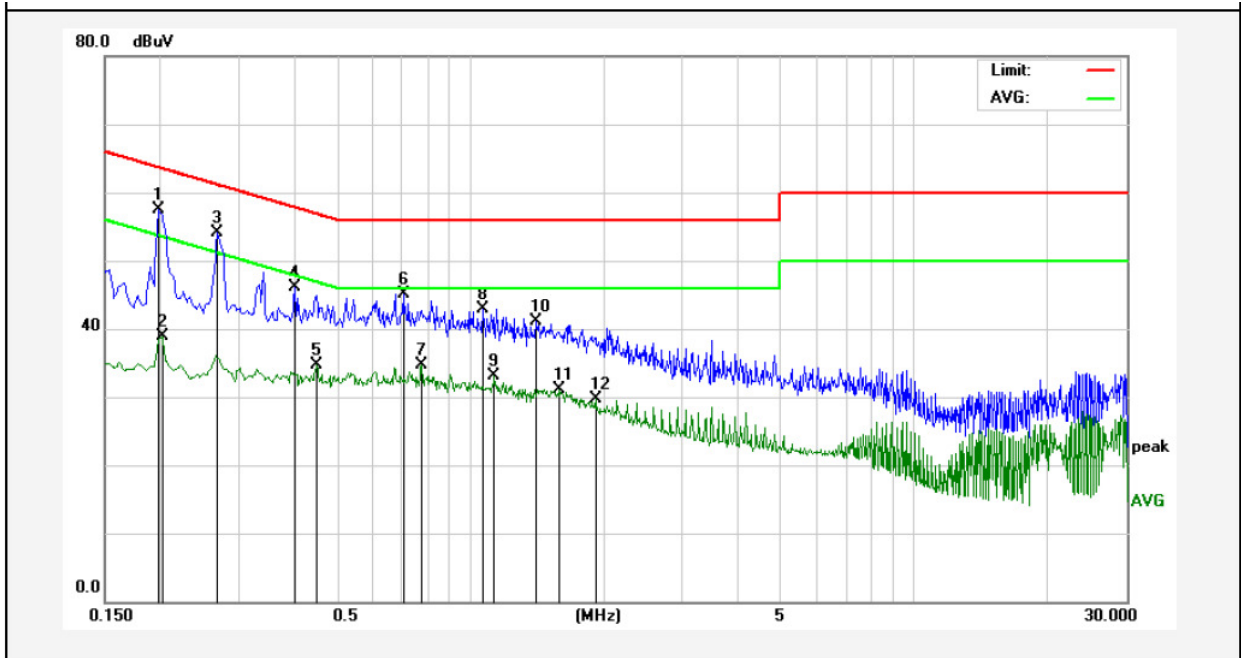
Test Site: 1# Shielded Room
 Operating Condition: Keeping TX+Charging mode
 Test Specification: AC 120V, 60Hz for adapter
 Comment: Neutral Line
 Tem.:25.4°C Hum.:54%



No.	Freq. (MHz)	Reading (dBuV)	Factor (dB)	Result (dBuV)	Limit dBuV	Over Limit (dB)	Detector	Remark
1	0.1500	34.92	17.90	52.82	65.99	-13.17	QP	
2	0.2100	30.98	17.90	48.88	63.20	-14.32	QP	
3	0.4740	16.41	17.97	34.38	46.44	-12.06	AVG	
4	0.4900	26.02	17.98	44.00	56.17	-12.17	QP	
5	0.7820	26.94	18.06	45.00	56.00	-11.00	QP	
6	0.9460	15.96	18.11	34.07	46.00	-11.93	AVG	
7	1.1860	24.89	18.12	43.01	56.00	-12.99	QP	
8	1.4980	24.10	18.13	42.23	56.00	-13.77	QP	
9	1.6540	13.61	18.13	31.74	46.00	-14.26	AVG	
10	2.1300	11.90	18.14	30.04	46.00	-15.96	AVG	
11	4.9660	13.28	18.21	31.49	46.00	-14.51	AVG	
12	25.4220	15.15	18.28	33.43	50.00	-16.57	AVG	

Conducted Emission Test Data

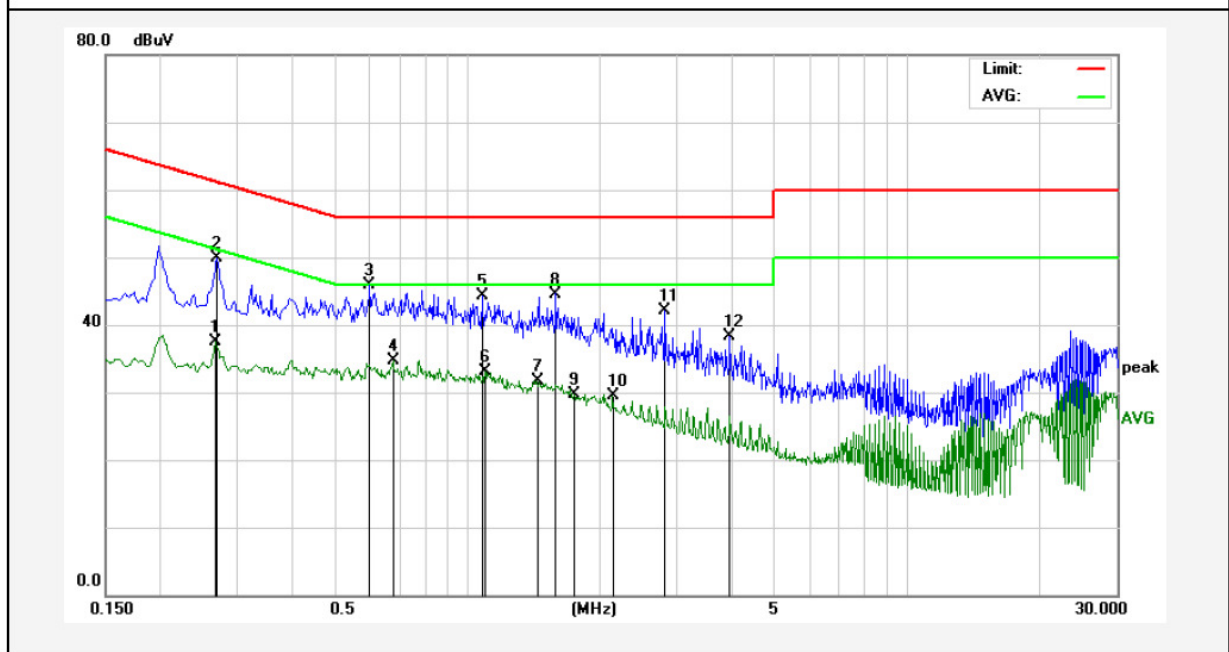
Test Site: 1# Shielded Room
 Operating Condition: Keeping TX+Charging mode
 Test Specification: AC 240V, 60Hz for adapter
 Comment: Live Line
 Tem.:25.4°C Hum.:54%



No.	Freq. (MHz)	Reading (dBuV)	Factor (dB)	Result (dBuV)	Limit dBuV	Over Limit (dB)	Detector	Remark
1	0.1980	39.67	17.90	57.57	63.69	-6.12	QP	
2	0.2020	20.94	17.90	38.84	53.52	-14.68	AVG	
3	0.2700	36.14	17.89	54.03	61.12	-7.09	QP	
4	0.4020	28.23	17.94	46.17	57.81	-11.64	QP	
5	0.4500	16.67	17.96	34.63	46.87	-12.24	AVG	
6	0.7060	27.14	18.04	45.18	56.00	-10.82	QP	
7	0.7780	16.63	18.06	34.69	46.00	-11.31	AVG	
8	1.0700	24.86	18.12	42.98	56.00	-13.02	QP	
9	1.1300	14.96	18.12	33.08	46.00	-12.92	AVG	
10	1.4100	23.05	18.13	41.18	56.00	-14.82	QP	
11	1.5900	12.92	18.13	31.05	46.00	-14.95	AVG	
12	1.9180	11.56	18.14	29.70	46.00	-16.30	AVG	

Conducted Emission Test Data

Test Site: 1# Shielded Room
 Operating Condition: Keeping TX+Charging mode
 Test Specification: AC 240V, 60Hz for adapter
 Comment: Neutral Line
 Tem.:25.4°C Hum.:54%



No.	Freq. (MHz)	Reading (dBuV)	Factor (dB)	Result (dBuV)	Limit dBuV	Over Limit (dB)	Detector	Remark
1	0.2660	19.56	17.89	37.45	51.24	-13.79	AVG	
2	0.2700	32.03	17.89	49.92	61.12	-11.20	QP	
3	0.5980	27.80	18.01	45.81	56.00	-10.19	QP	
4	0.6780	16.74	18.03	34.77	46.00	-11.23	AVG	
5	1.0780	26.12	18.12	44.24	56.00	-11.76	QP	
6	1.0940	14.94	18.12	33.06	46.00	-12.94	AVG	
7	1.4340	13.61	18.13	31.74	46.00	-14.26	AVG	
8	1.5900	26.47	18.13	44.60	56.00	-11.40	QP	
9	1.7460	11.51	18.13	29.64	46.00	-16.36	AVG	
10	2.1420	11.27	18.14	29.41	46.00	-16.59	AVG	
11	2.8179	23.86	18.16	42.02	56.00	-13.98	QP	
12	3.9460	20.03	18.18	38.21	56.00	-17.79	QP	

4. Radiation Spurious Emission and Band Edge

4.1. Test Standard and Limit

Test Standard	FCC Part15 C Section 15.209 and 15.205				
Test Limit	Frequency (MHz)	Field strength (microvolt/meter)	Limit (dBuV/m)	Remark	Measurement distance (m)
	0.009MHz~0.490MHz	2400/F(kHz)	-	-	300
	0.490MHz-1.705MHz	24000/F(kHz)	-	-	30
	1.705MHz-30MHz	30	-	-	30
	30MHz~88MHz	100	40.0	Quasi-peak	3
	88MHz~216MHz	150	43.5	Quasi-peak	3
	216MHz~960MHz	200	46.0	Quasi-peak	3
	960MHz~1000MHz	500	54.0	Quasi-peak	3
	Above 1000MHz	500	54.0	Average	3
-		74.0	Peak	3	

Remark:

(1)The lower limit shall apply at the transition frequency.

(2) 15.35(b), Unless otherwise specified, the limit on peak radio frequency emissions is 20dB above the maximum permitted average emission limit applicable to the equipment under test. This peak limit applies to the total peak emission level radiated by the device.

4.2. Test Setup

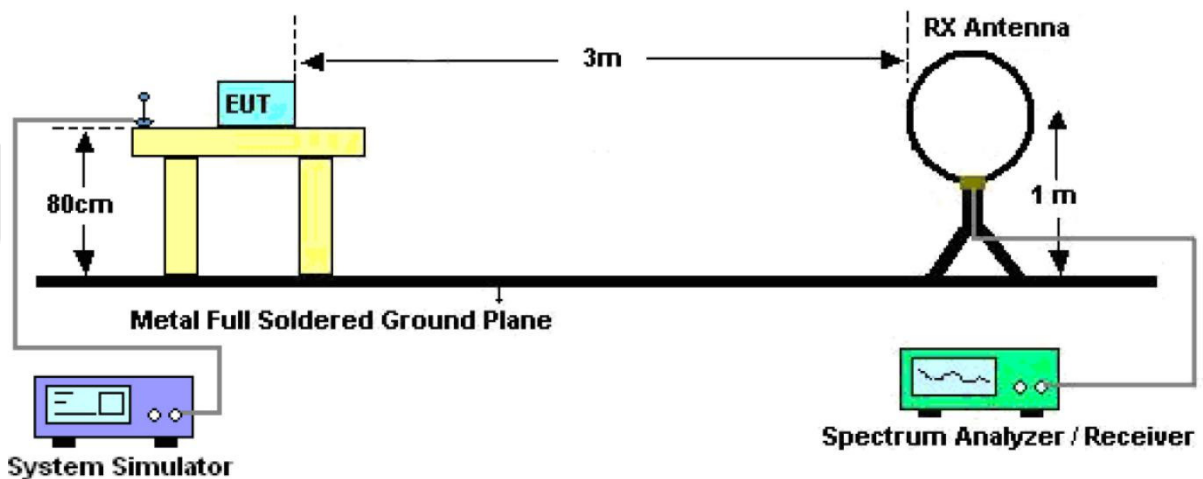


Figure 1. Below 30MHz

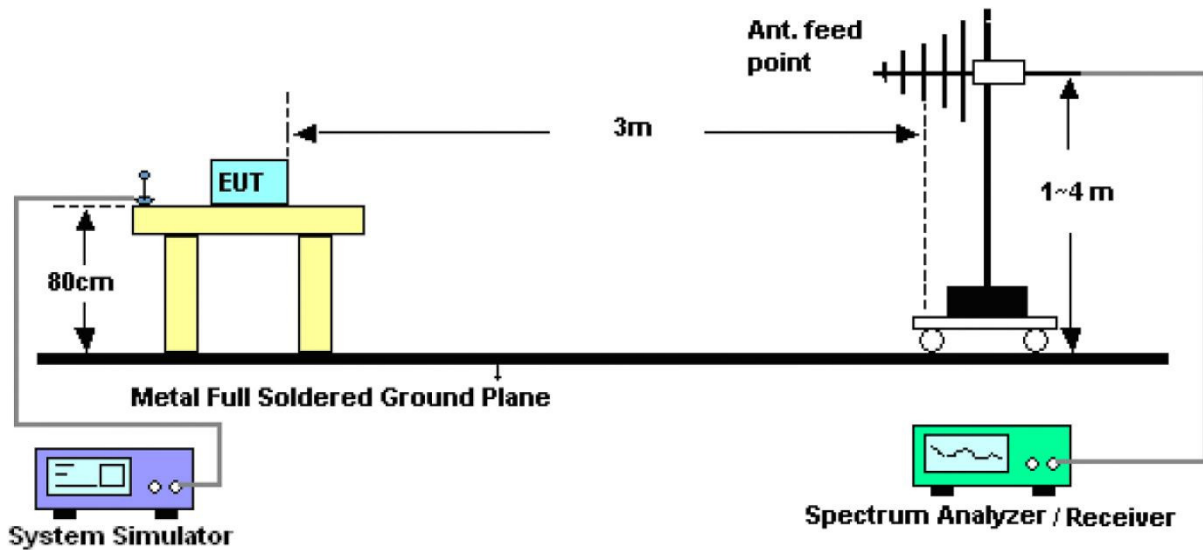


Figure 2. 30MHz to 1GHz

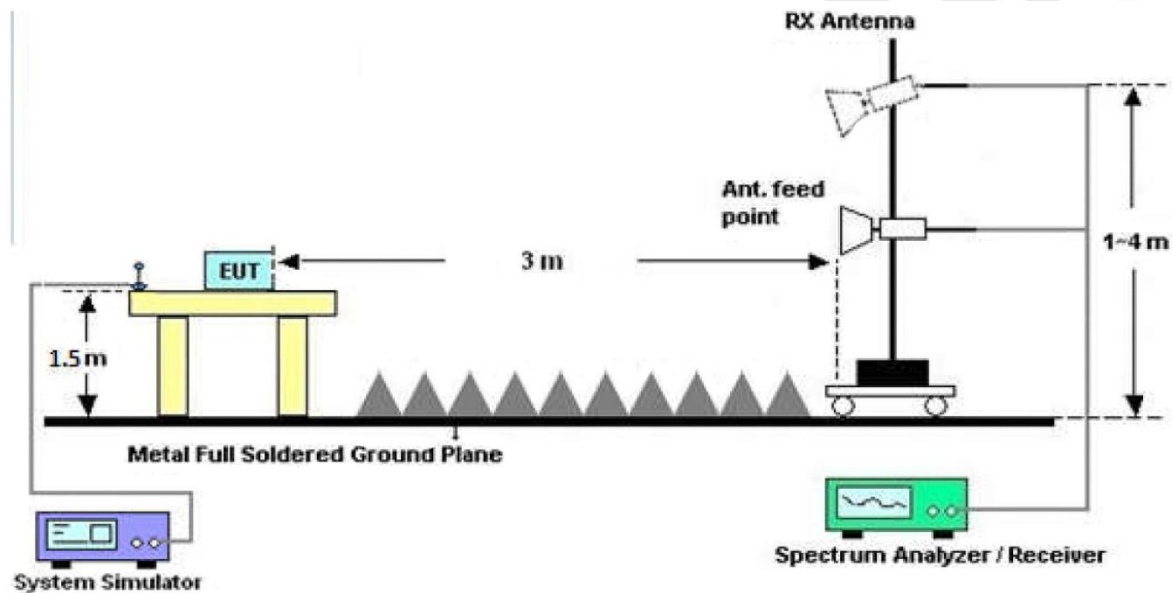


Figure 3. Above 1 GHz

4.3. Test Procedure

For below 1GHz: The EUT is placed on a turntable, which is 0.8m above the ground plane.

For above 1GHz: The EUT is placed on a turntable, which is 1.5m above the ground plane.

The turn table can rotate 360 degrees to determine the position of the maximum emission level. The EUT is set 3 meters away from the receiving antenna which is mounted on a antenna tower. The antenna can be moved up and down from 1 to 4 meters to find out the maximum emission level. Rotated the EUT through three orthogonal axes to determine the maximum emissions, both horizontal and vertical polarization of the antenna are set on test. The EUT is tested in 9*6*6 Chamber. The device is evaluated in xyz orientation.

For 9kHz to 150kHz, Set the spectrum analyzer as:

RBW = 200Hz, VBW =1kHz, Detector= Quasi-Peak, Trace mode= Max hold, Sweep- auto couple.

For 150kHz to 30MHz, Set the spectrum analyzer as:

RBW = 9KHz, VBW =30kHz, Detector= Quasi-Peak, Trace mode= Max hold, Sweep- auto couple.

For 30MHz to 1000MHz, Set the spectrum analyzer as:

RBW = 100kHz, VBW =300kHz, Detector= Quasi-Peak, Trace mode= Max hold, Sweep- auto couple.

4.4. Test Data

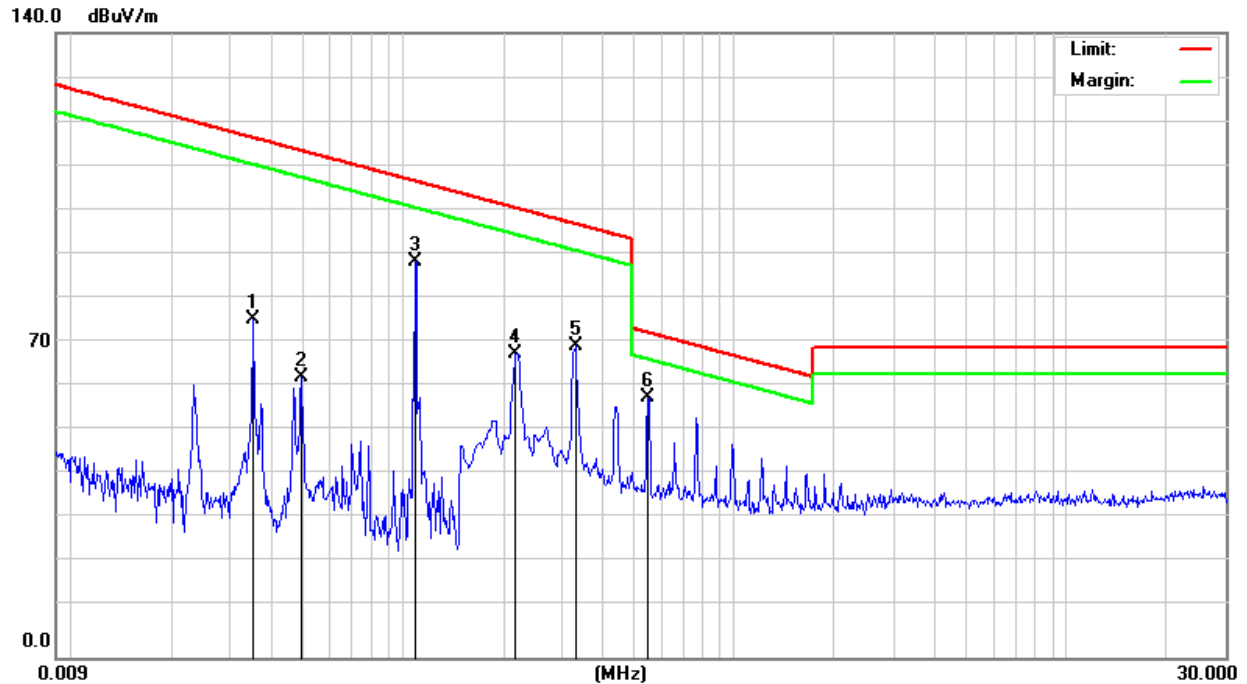
PASS

Anbotek

Test Results

(Between 9KHz – 30MHz)

Job No.:	SZAWW180122020-01		
Standard:	FCC PART15 C _3m	Power Source:	AC 120V, 60Hz for adapter
Test item:	Radiation Test	Temp.(C)/Hum.(%RH):	23.2(C)/53.4% RH
Test Mode:	Keeping TX+Charging mode	Distance:	3m

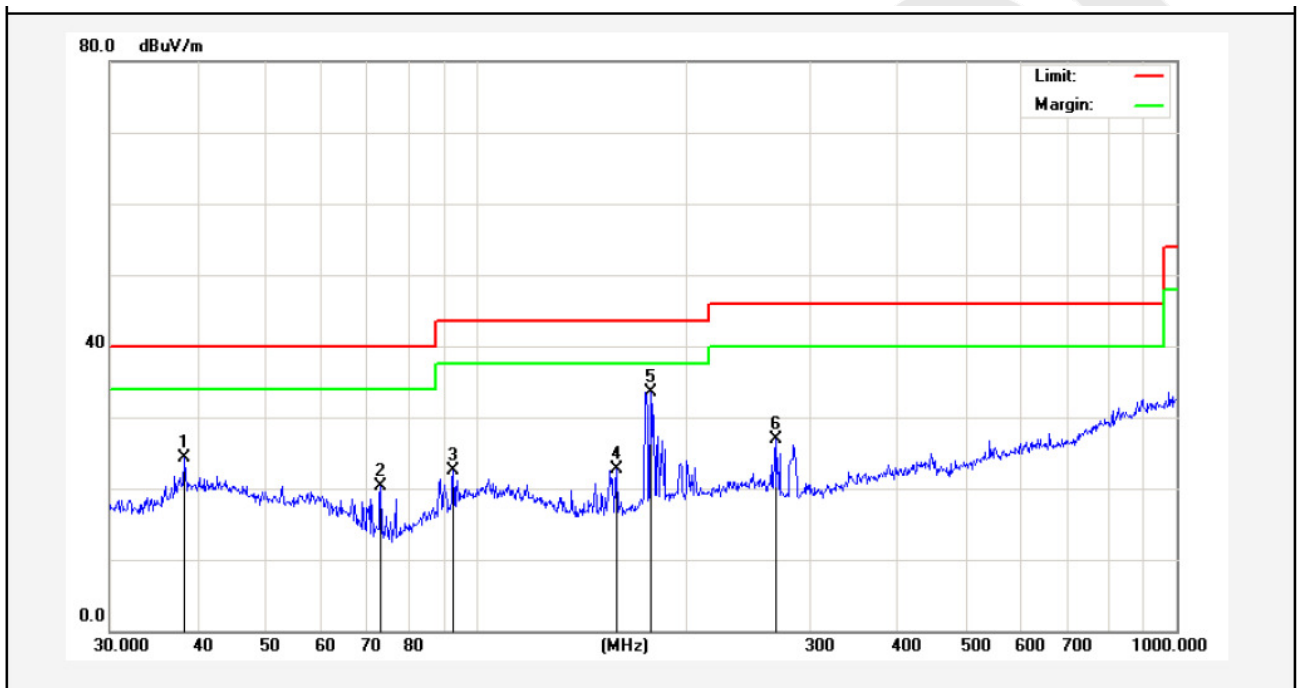


Frequency (MHz)	Read Level (dBuV)	Antenna Factor (dB/m)	Cable Loss (dB)	Preamp Factor (dB)	Level (dBuV/m)	Limit (dBuV/m)	Over Limit (dB)	Detector	degree (dgc)
0.0354	54.07	19.28	2.53	0	75.88	136.50	-60.62	Peak	15
0.0354	50.88	19.28	2.53	0	72.69	116.50	-43.81	AV	15
0.0495	41.09	19.28	2.53	0	62.90	133.60	-70.70	Peak	33
0.0495	39.54	19.28	2.53	0	61.35	113.60	-52.25	AV	33
0.1107	67.01	19.30	2.54	0	88.85	126.08	-37.23	Peak	124
0.1107	64.37	19.30	2.54	0	86.21	106.08	-19.87	AV	124
0.2180	46.26	19.38	2.55	0	68.19	120.79	-52.60	Peak	101
0.2180	44.80	19.38	2.55	0	66.73	100.79	-34.06	AV	101
0.3300	47.60	19.53	2.59	0	69.72	117.21	-47.49	Peak	324
0.3300	45.27	19.53	2.59	0	67.39	97.21	-29.82	AV	324
0.5460	35.30	20.34	2.60	0	58.24	72.86	-14.62	QP	0

Remark: According to FCC PART 15.209 (d), the emission limits for the frequency bands 9–90 kHz, 110–490 kHz and above 1000 MHz, Radiated emission limits in these three bands are based on measurements employing an average detector.

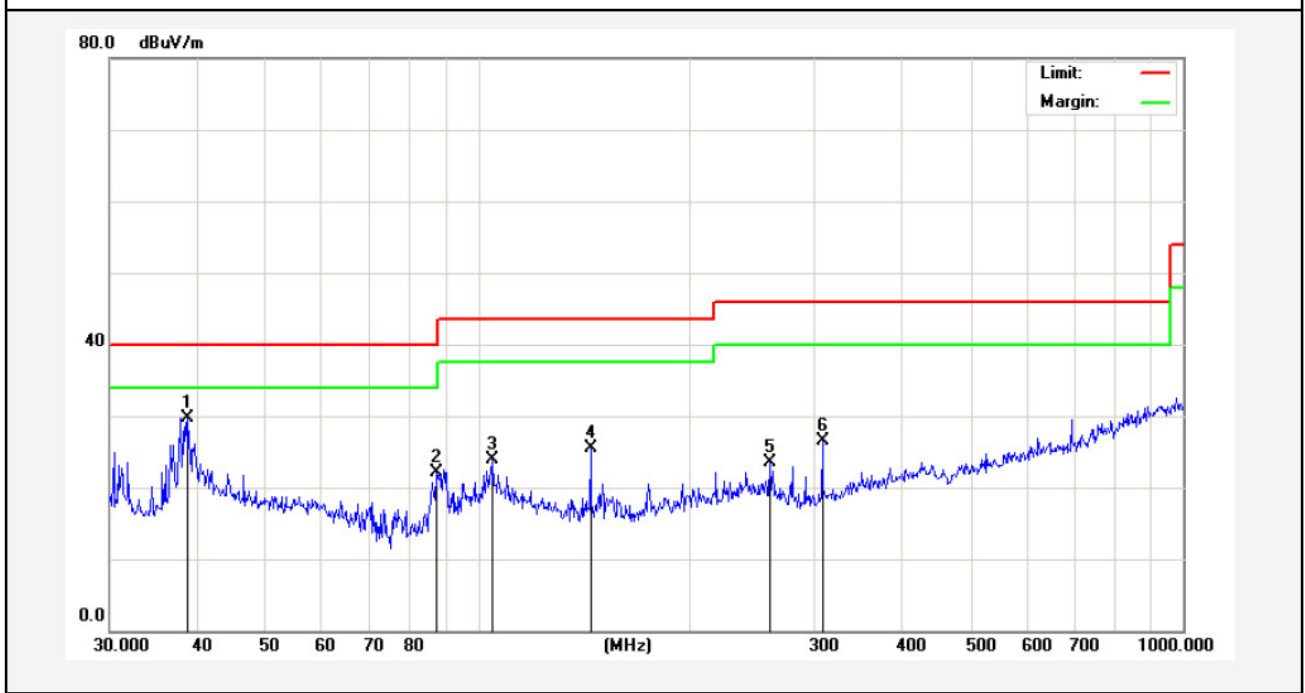
(Between 30MHz -1000 MHz)

Job No.:	SZAWW180122020-01	Polarization:	Horizontal
Standard:	FCC PART15 C _3m	Power Source:	AC 120V, 60Hz for adapter
Test item:	Radiation Test	Temp.(C)/Hum.(%RH):	23.2(C)/53.4%RH
Test Mode:	Keeping TX+Charging mode	Distance:	3m



No.	Freq. (MHz)	Reading (dBuV/m)	Factor (dB/m)	Result (dBuV/m)	Limit (dBuV)	Over Limit (dB)	Detector	Height (cm)	degree (deg)	Remark
1	38.3462	33.55	-9.26	24.29	40.00	-15.71	QP	300	66	
2	73.1025	35.65	-15.31	20.34	40.00	-19.66	QP	300	112	
3	92.7871	38.71	-16.13	22.58	43.50	-20.92	QP	300	147	
4	158.6677	37.53	-14.92	22.61	43.50	-20.89	QP	300	163	
5	177.5092	47.35	-13.78	33.57	43.50	-9.93	QP	300	215	
6	267.5455	39.32	-12.38	26.94	46.00	-19.06	QP	300	269	

Job No.:	SZAWW180122020-01	Plarization:	Vertical
Standard:	FCC PART15 C _3m	Power Source:	AC 120V, 60Hz for adapter
Test item:	Radiation Test	Temp.(C)/Hum.(%RH):	23.2(C)/53.4% RH
Test Mode:	Keeping TX+Charging mode	Distance:	3m



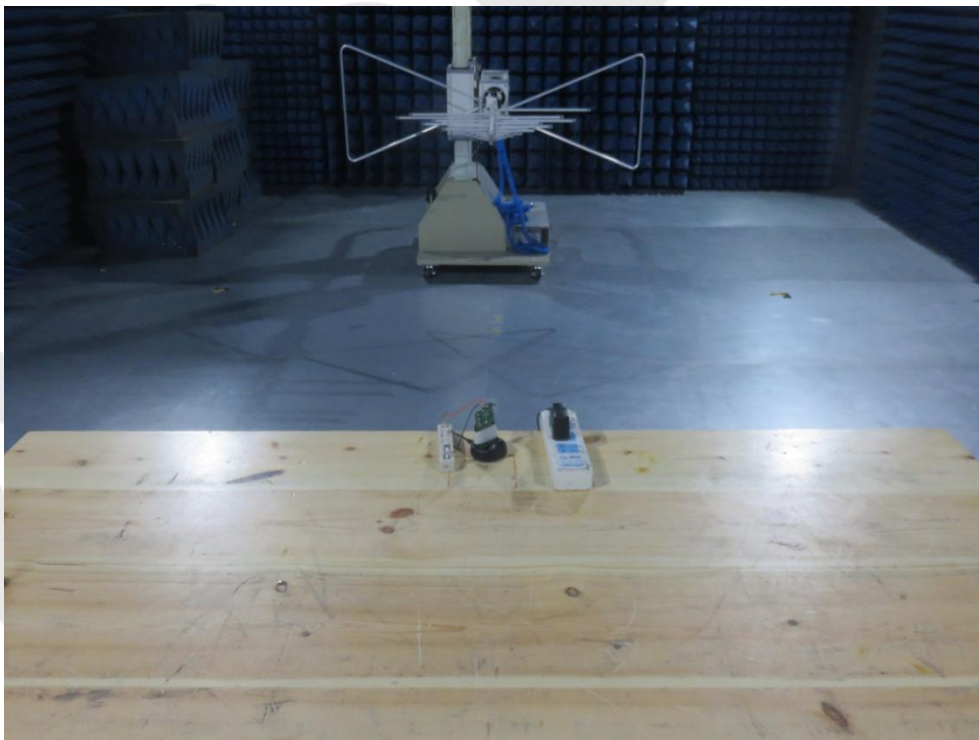
No.	Freq. (MHz)	Reading (dBuV/m)	Factor (dB/m)	Result (dBuV/m)	Limit (dBuV/)	Over Limit (dB)	Detector	Height (cm)	degree (deg)	Remark
1	38.7518	37.78	-8.05	29.73	40.00	-10.27	QP	300	16	
2	87.4177	33.67	-11.62	22.05	40.00	-17.95	QP	300	77	
3	104.9033	32.66	-8.70	23.96	43.50	-19.54	QP	300	147	
4	144.3348	37.03	-11.43	25.60	43.50	-17.90	QP	300	156	
5	259.2338	31.12	-7.59	23.53	46.00	-22.47	QP	300	210	
6	307.8313	35.09	-8.51	26.58	46.00	-19.42	QP	300	267	

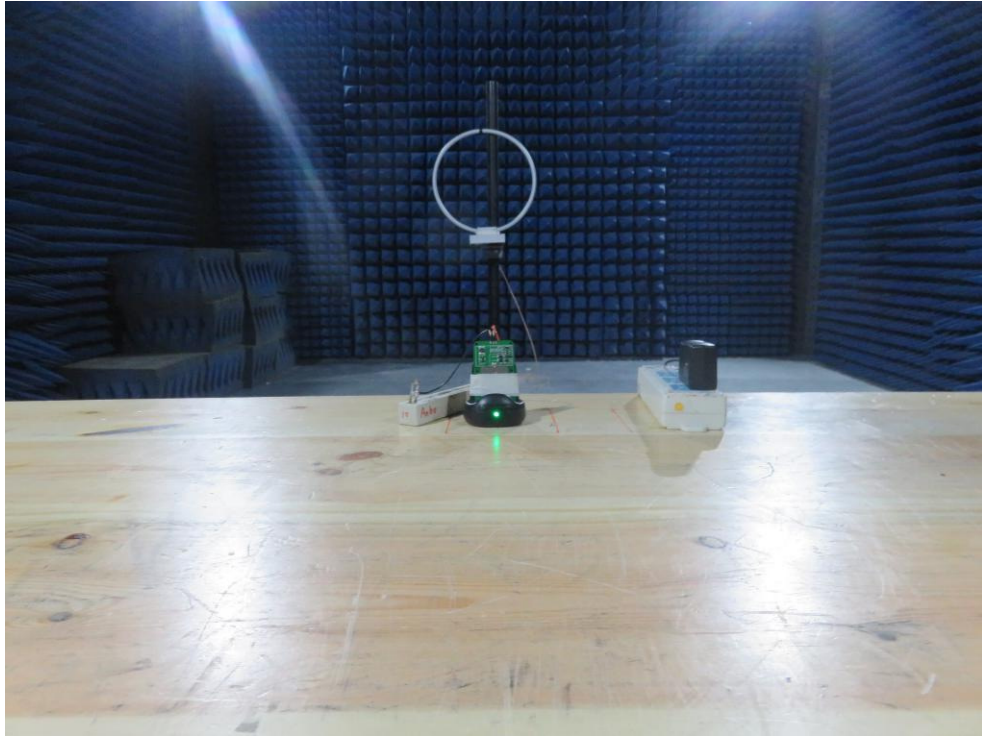
APPENDIX I -- TEST SETUP PHOTOGRAPH

Photo of Conducted Emission Measurement

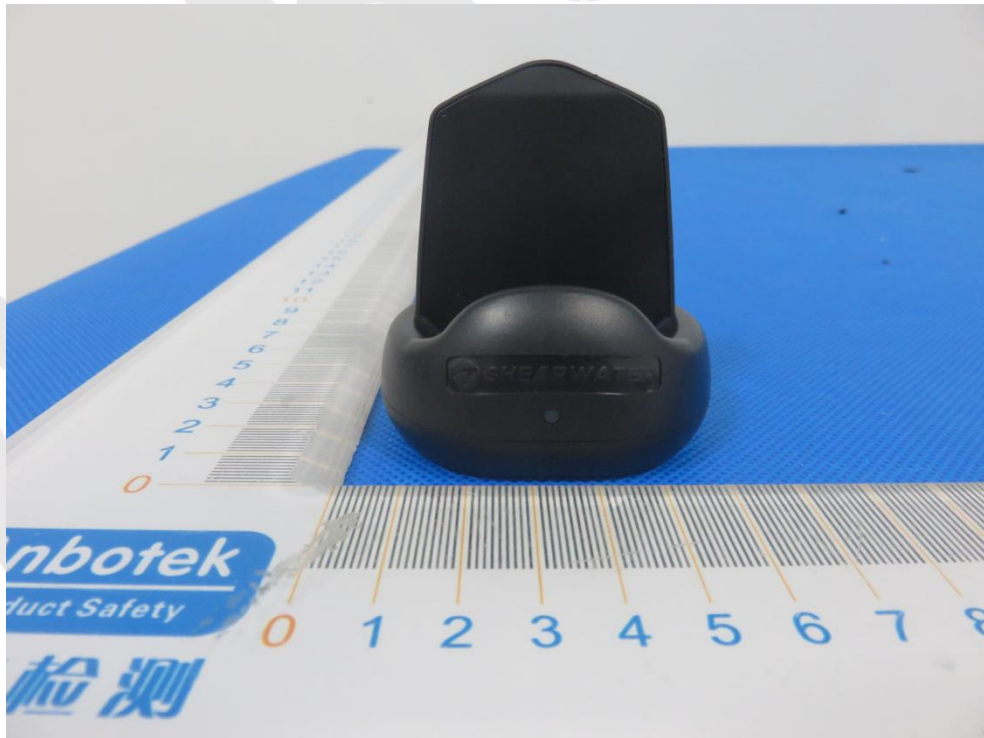


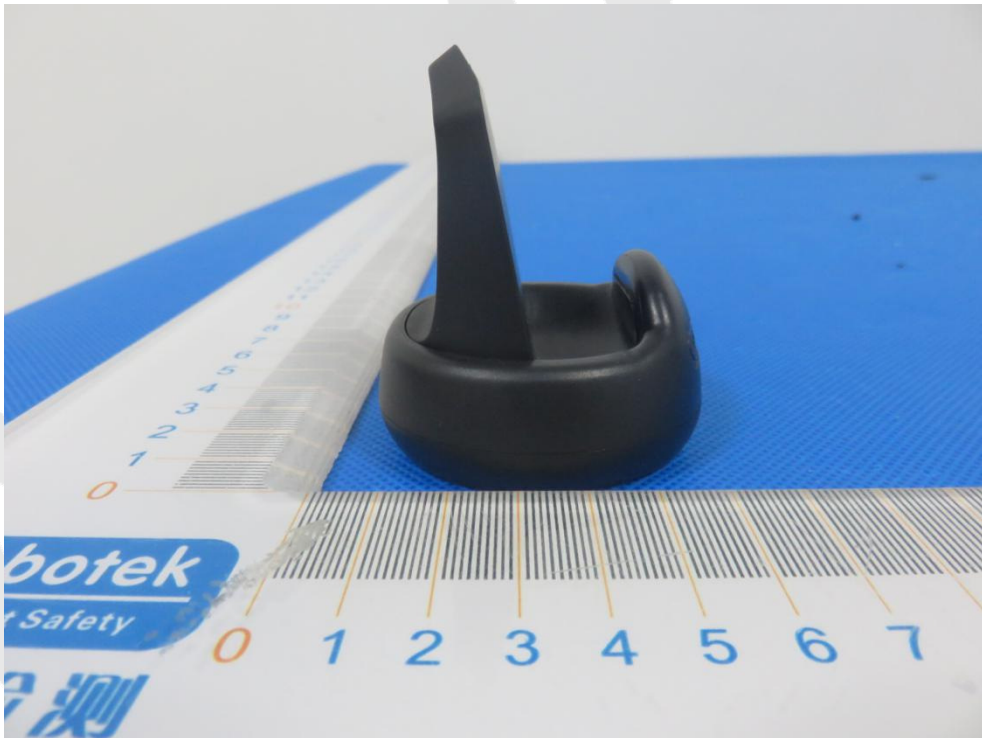
Photo of Radiation Emission Test

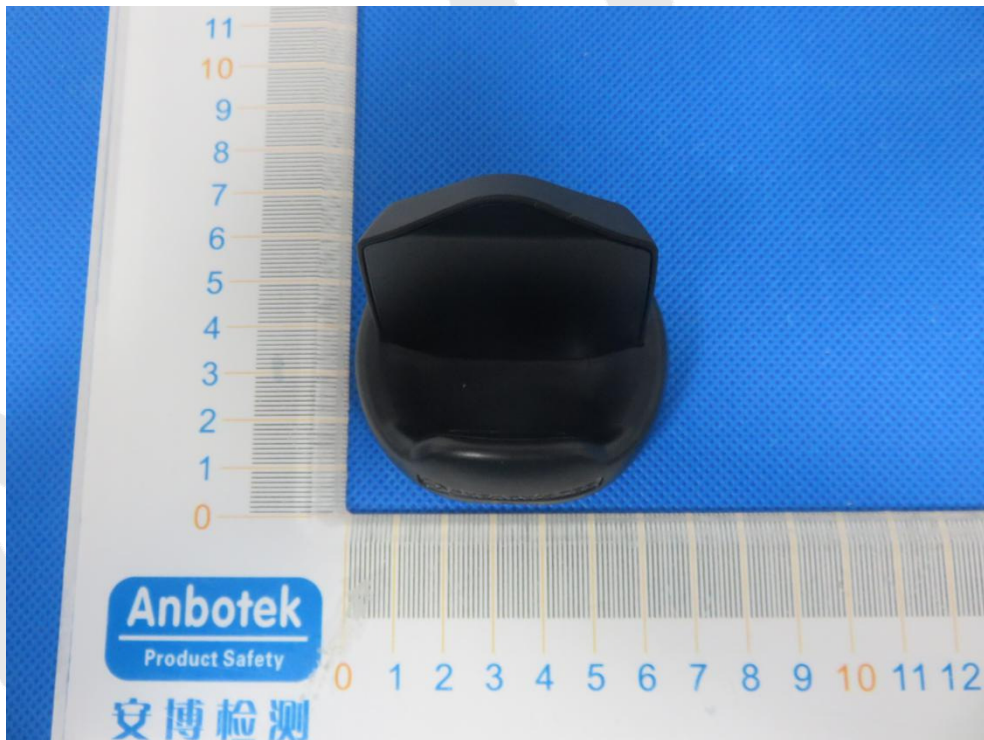
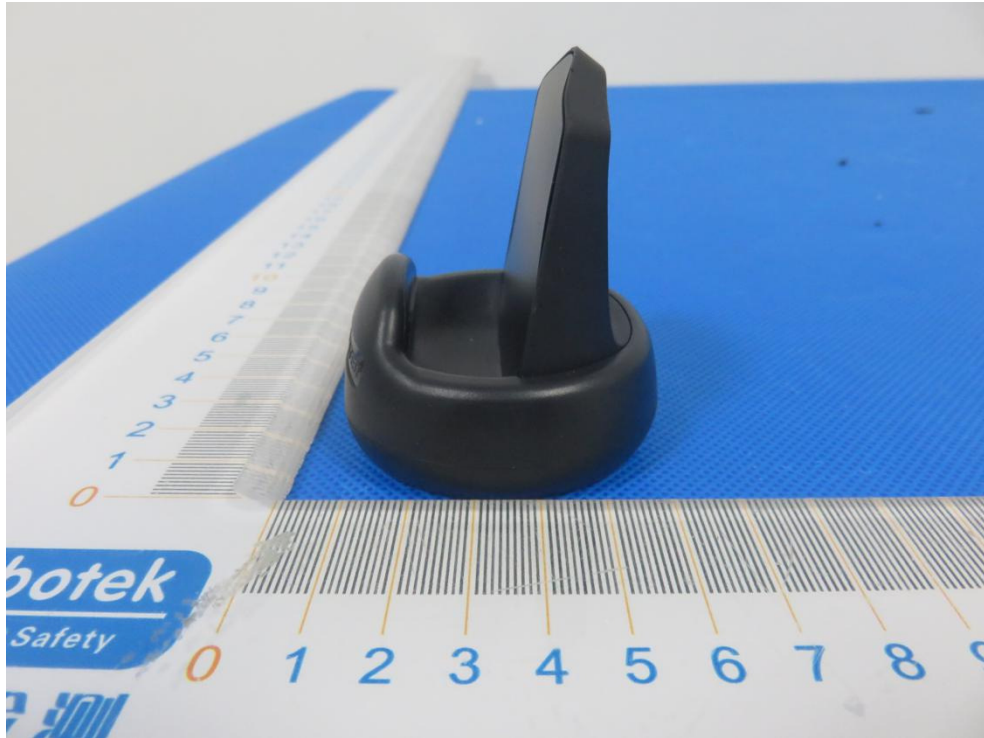


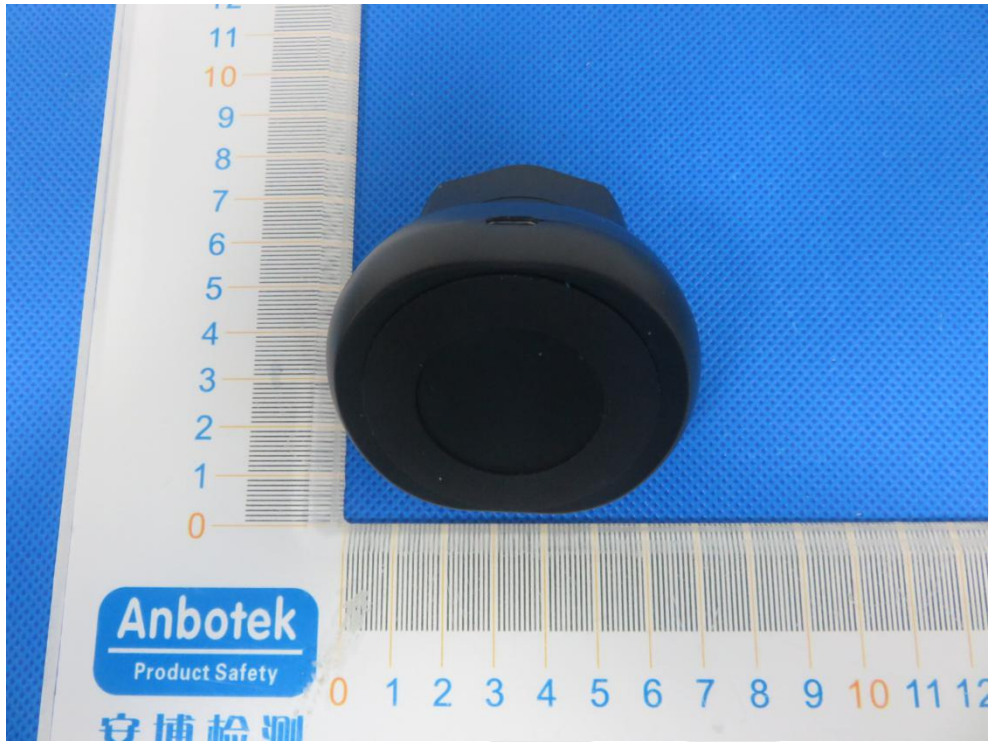


APPENDIX II -- EXTERNAL PHOTOGRAPH



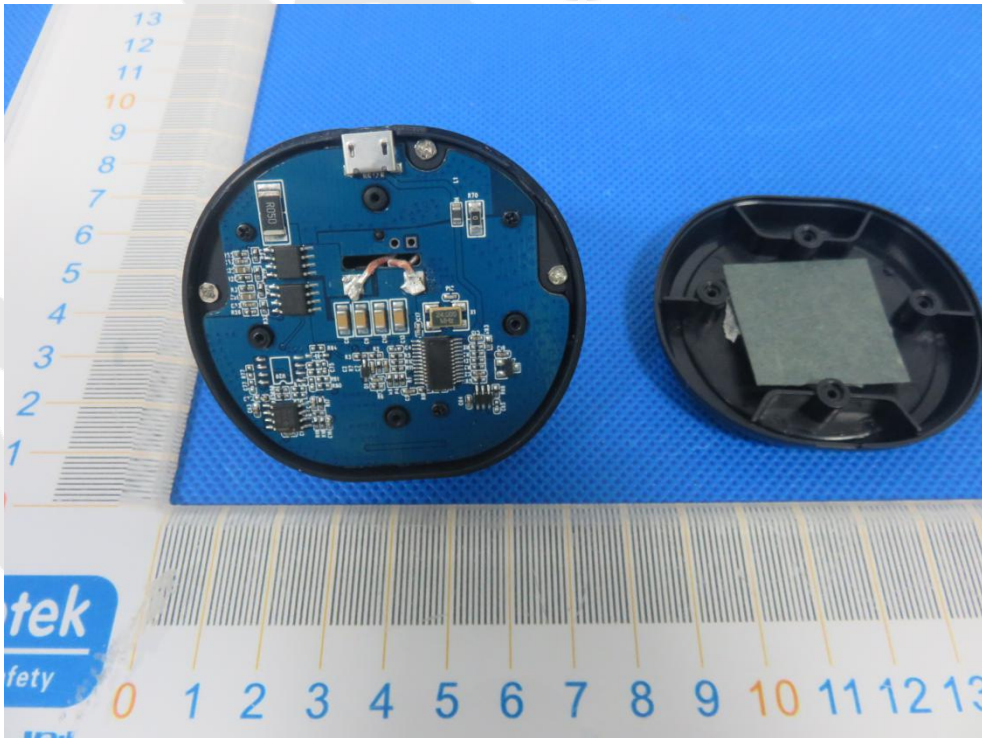


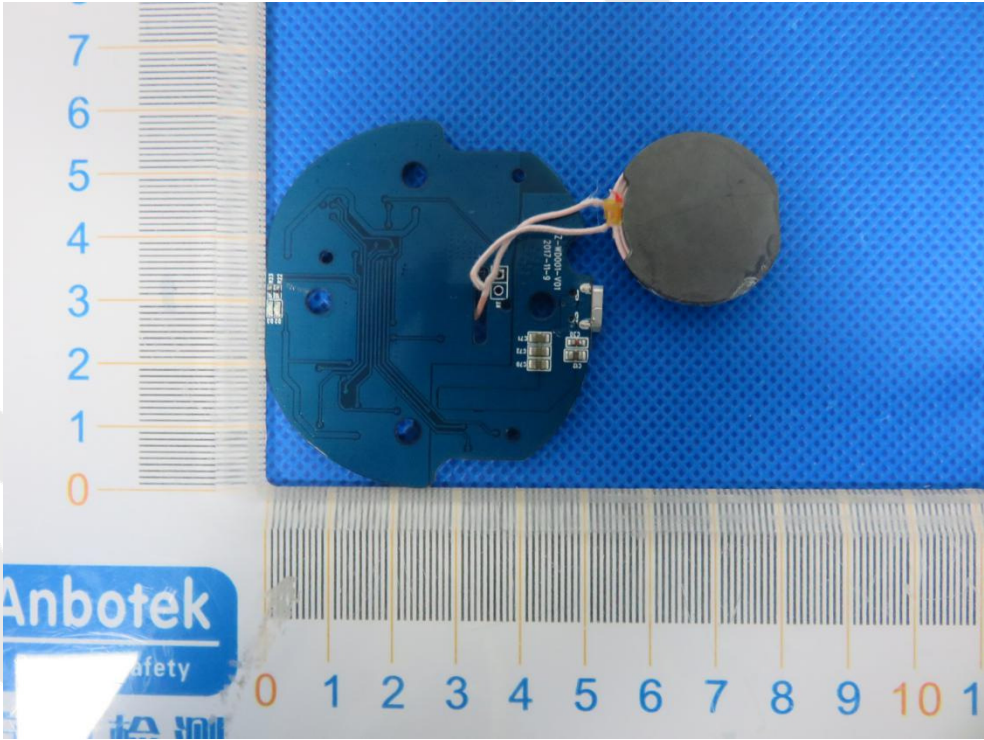
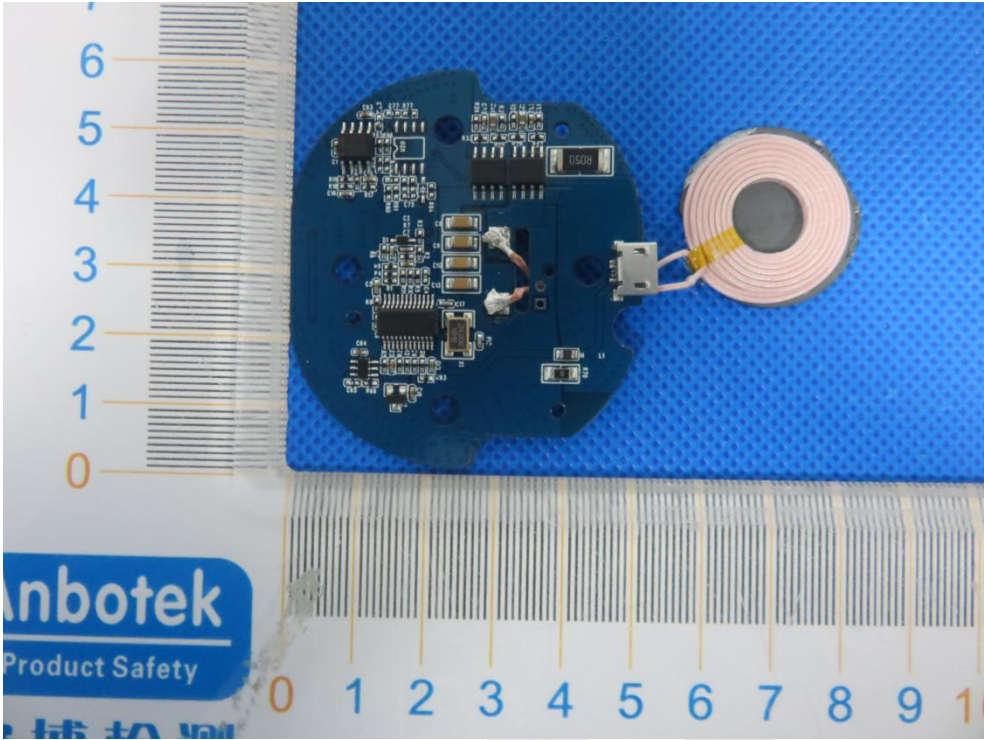


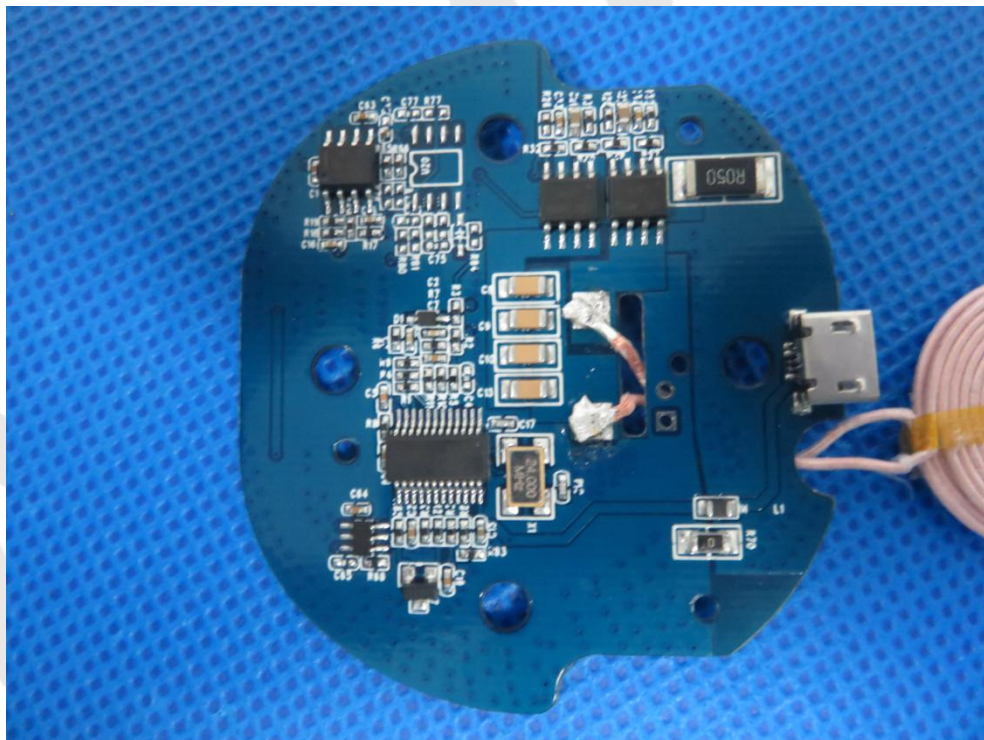
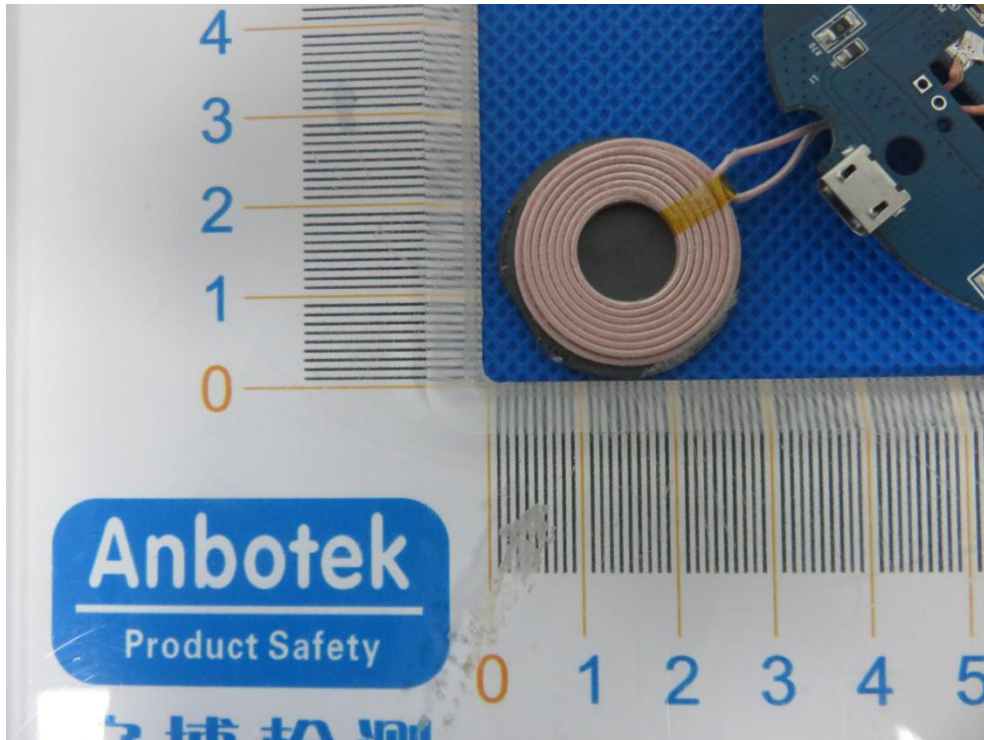


Anbotek

APPENDIX III -- INTERNAL PHOTOGRAPH







End of Report