



Chug, Inc.

Label Artwork and Location

We declare that:

Applicant: Chug, Inc.

Address: 7157 Shady Oak Road, Eden Prairie, MN 55344, USA

Date: 2022.11.24

Subject: Request for FCC ID: 2A023-TWS08

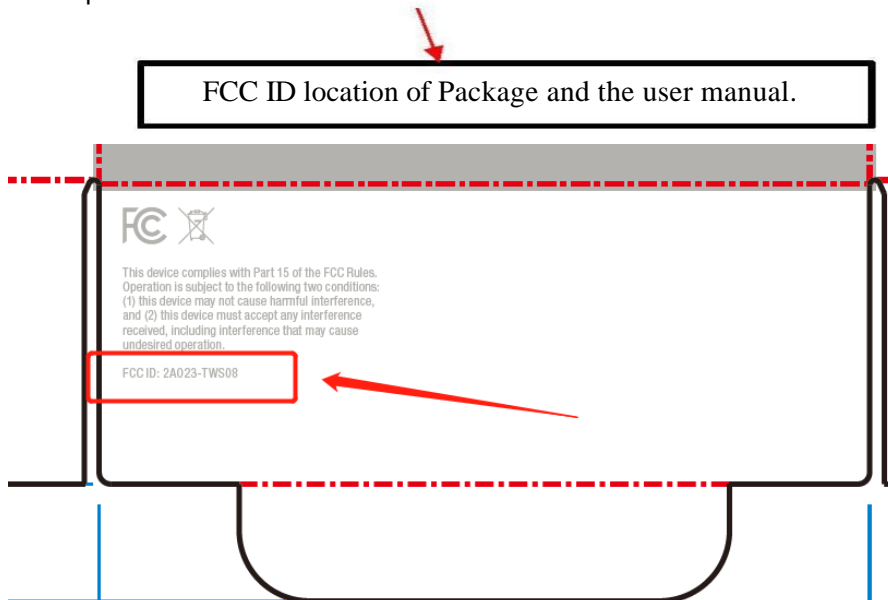

This application for FCC certification is for Bluetooth technology. The charging case only has the function of charging the earbuds, the earbuds with Bluetooth technology is the RF body. However, because the earbuds body area is too small, the FCC ID number is reflected in the package and user manual.

Moulded LOGO on the back of bottom charging

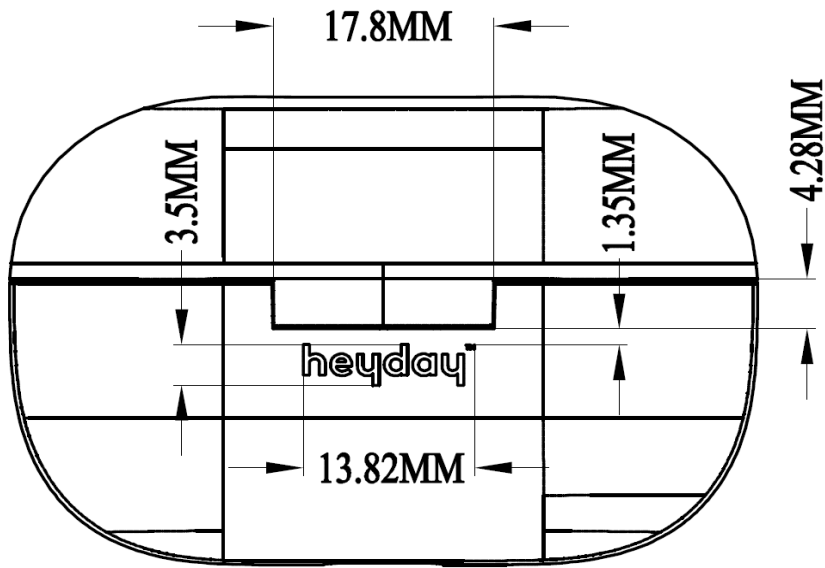

Laser Test on Top Case

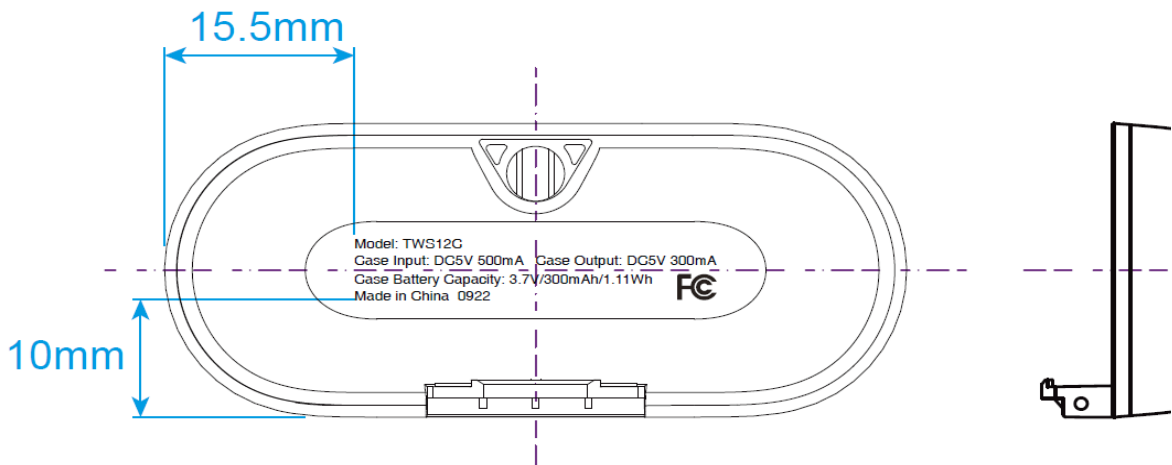

RL printed on earbud: glossy UV



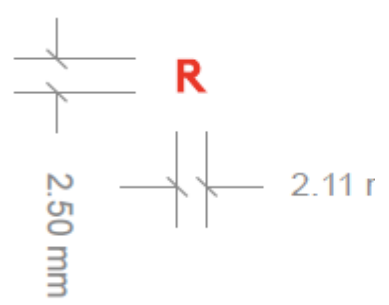
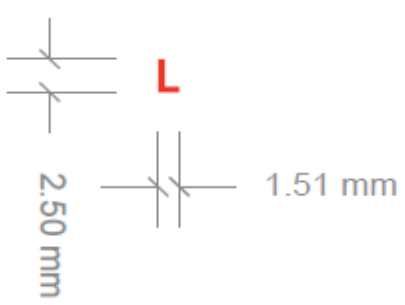
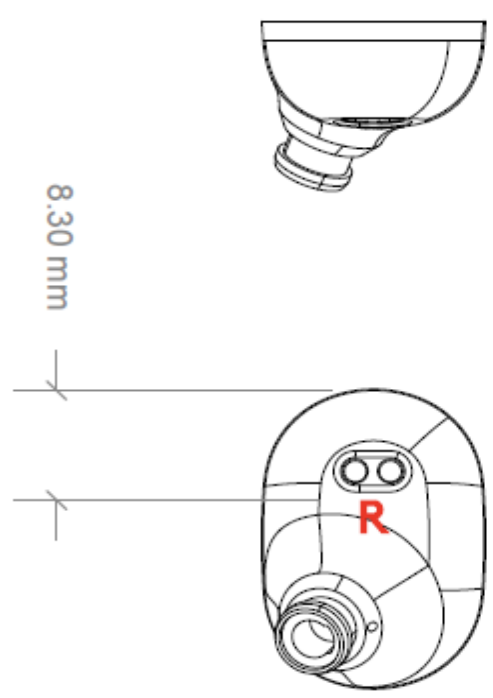
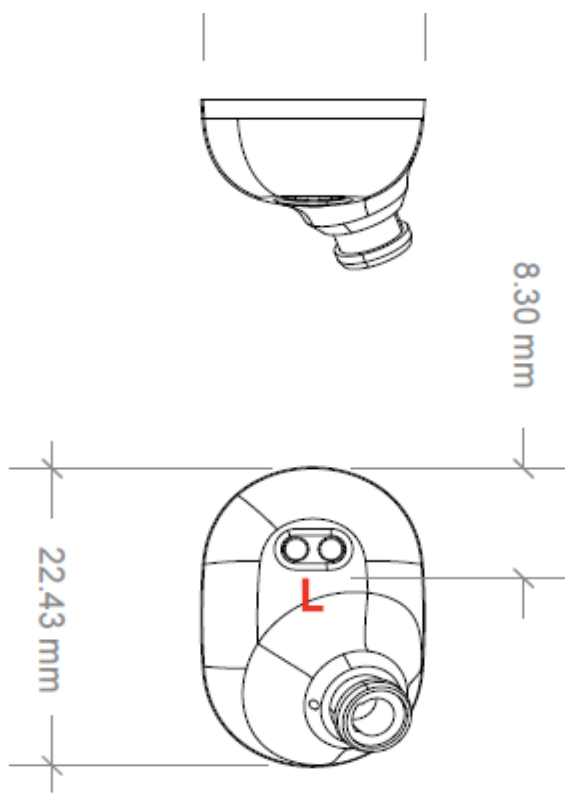

case

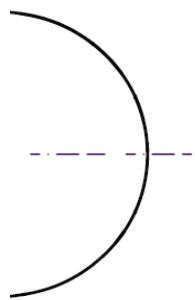
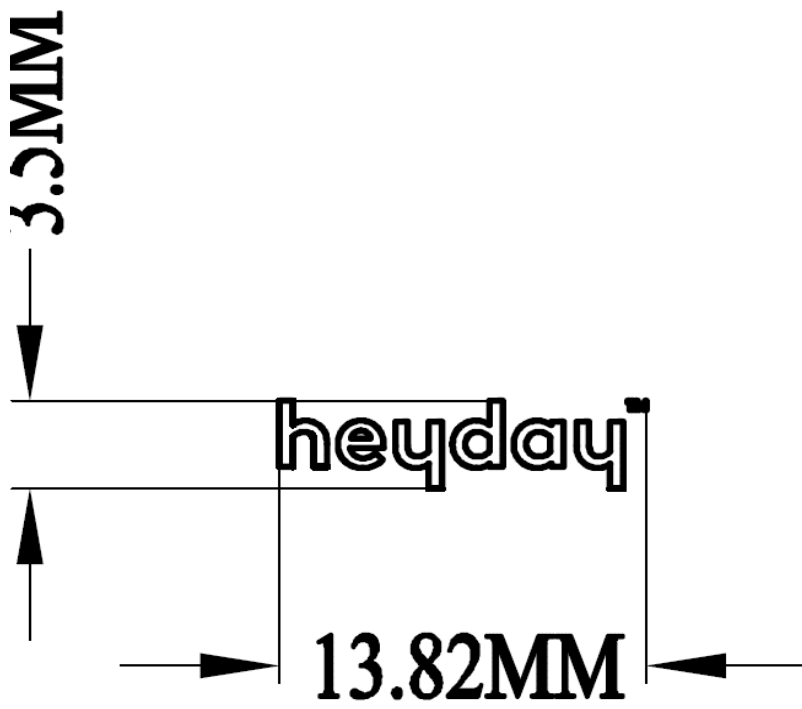

Model: TWS12C
Case Input: DC5V 500mA Case Output: DC5V 300mA
Case Battery Capacity: 3.7V/300mAh/1.11Wh
Made in China 0922

FC

29.4mm

5.4mm

Technical specifications and dimensions for the case. The specifications include Model: TWS12C, Case Input: DC5V 500mA, Case Output: DC5V 300mA, Case Battery Capacity: 3.7V/300mAh/1.11Wh, and Made in China 0922. The dimensions are 29.4mm and 5.4mm. A 'FC' logo is also present.

nm