

## TEST REPORT

Test report no.: 1-5025/17-02-19



Deutsche  
Akkreditierungsstelle  
D-PL-12076-01-01

### Testing laboratory

**CTC advanced GmbH**

Untertuerkheimer Strasse 6 – 10

66117 Saarbruecken / Germany

Phone: + 49 681 5 98 - 0

Fax: + 49 681 5 98 - 9075

Internet: <http://www.ctcadvanced.com>

e-mail: [mail@ctcadvanced.com](mailto:mail@ctcadvanced.com)

**Accredited Testing Laboratory:**

The testing laboratory (area of testing) is accredited according to DIN EN ISO/IEC 17025 (2005) by the Deutsche Akkreditierungsstelle GmbH (DAkkS)

The accreditation is valid for the scope of testing procedures as stated in the accreditation certificate with the registration number: D-PL-12076-01-01

### Applicant

**OVERLINE Systems**

21, Avenue Sophie Wallerstein

33510 Andernos les Bains / FRANCE

Phone: +33 5 57 70 21 21

Fax: -/-

Contact: Gérard Lombard

e-mail: [gerard@overline-systems.com](mailto:gerard@overline-systems.com)

Phone: +33 5 57 70 21 21

### Manufacturer

**OVERLINE Systems**

21, Avenue Sophie Wallerstein

33510 Andernos les Bains / FRANCE

### Test standard/s

47 CFR Part 15

Title 47 of the Code of Federal Regulations; Chapter I; Part 15 - Radio frequency devices

RSS - 247 Issue 2

Digital Transmission Systems (DTSs), Frequency Hopping Systems (FHSs) and Licence - Exempt Local Area Network (LE-LAN) Devices

RSS - Gen Issue 4

Spectrum Management and Telecommunications Radio Standards Specifications - General Requirements and Information for the Certification of Radio Apparatus

For further applied test standards please refer to section 3 of this test report.

### Test Item

**Kind of test item:** In ear transceiver

**Model name:** DE-NR INEAR

**FCC ID:** 2ANZJDENR1

**IC:** 23304-DENR1

**Frequency:** DTS band 2400 MHz to 2483.5 MHz

**Technology tested:** Bluetooth® + EDR

**Antenna:** Integrated antenna

**Power supply:** 3.7 V DC by CR1254 A3 battery

**Temperature range:** +5°C to +45°C



This test report is electronically signed and valid without handwritten signature. For verification of the electronic signatures, the public keys can be requested at the testing laboratory.

### Test report authorized:

Andreas Luckenbill  
Lab Manager  
Radio Communications & EMC

### Test performed:

Mihail Dorongovskij  
Lab Manager  
Radio Communications & EMC

## 1 Table of contents

1	Table of contents .....	2
2	General information .....	3
2.1	Notes and disclaimer .....	3
2.2	Application details.....	3
2.3	Test laboratories sub-contracted .....	3
3	Test standard/s and references .....	4
4	Test environment.....	5
5	Test item.....	5
5.1	General description.....	5
5.2	Additional information .....	5
6	Description of the test setup.....	6
6.1	Shielded semi anechoic chamber.....	7
6.2	Shielded fully anechoic chamber .....	8
6.3	Radiated measurements > 18 GHz.....	9
6.4	Conducted measurements C.BER system.....	10
7	Sequence of testing .....	11
7.1	Sequence of testing radiated spurious 9 kHz to 30 MHz.....	11
7.2	Sequence of testing radiated spurious 30 MHz to 1 GHz.....	12
7.3	Sequence of testing radiated spurious 1 GHz to 18 GHz .....	13
7.4	Sequence of testing radiated spurious above 18 GHz .....	14
8	Measurement uncertainty .....	15
9	Summary of measurement results .....	16
10	Additional comments.....	17
11	Measurement results .....	18
11.1	Antenna gain .....	18
11.2	Carrier frequency separation.....	19
11.3	Number of hopping channels .....	21
11.4	Time of occupancy (dwell time) .....	23
11.5	Spectrum bandwidth of a FHSS system.....	24
11.6	Maximum output power.....	31
11.7	Detailed spurious emissions @ the band edge - conducted .....	37
11.8	Band edge compliance radiated.....	44
11.9	Spurious emissions conducted .....	48
11.10	Spurious emissions radiated below 30 MHz .....	56
11.11	Spurious emissions radiated 30 MHz to 1 GHz.....	59
11.12	Spurious emissions radiated above 1 GHz .....	64
12	Observations .....	69
Annex A	Glossary.....	70
Annex B	Document history .....	71
Annex C	Accreditation Certificate .....	71

## 2 General information

### 2.1 Notes and disclaimer

The test results of this test report relate exclusively to the test item specified in this test report. CTC advanced GmbH does not assume responsibility for any conclusions and generalizations drawn from the test results with regard to other specimens or samples of the type of the equipment represented by the test item.

The test report may only be reproduced or published in full. Reproduction or publication of extracts from the report requires the prior written approval of CTC advanced GmbH.

The testing service provided by CTC advanced GmbH has been rendered under the current "General Terms and Conditions for CTC advanced GmbH".

CTC advanced GmbH will not be liable for any loss or damage resulting from false, inaccurate, inappropriate or incomplete product information provided by the customer.

Under no circumstances does the CTC advanced GmbH test report include any endorsement or warranty regarding the functionality, quality or performance of any other product or service provided.

Under no circumstances does the CTC advanced GmbH test report include or imply any product or service warranties from CTC advanced GmbH, including, without limitation, any implied warranties of merchantability, fitness for purpose, or non-infringement, all of which are expressly disclaimed by CTC advanced GmbH.

All rights and remedies regarding vendor's products and services for which CTC advanced GmbH has prepared this test report shall be provided by the party offering such products or services and not by CTC advanced GmbH. In no case this test report can be considered as a Letter of Approval.

This test report is electronically signed and valid without handwritten signature. For verification of the electronic signatures, the public keys can be requested at the testing laboratory.

### 2.2 Application details

Date of receipt of order:	2017-09-04
Date of receipt of test item:	2017-10-09
Start of test:	2017-10-09
End of test:	2017-10-13
Person(s) present during the test:	Mr. Andreas Keller

### 2.3 Test laboratories sub-contracted

None

### 3 Test standard/s and references

Test standard	Date	Description
47 CFR Part 15	-/-	Title 47 of the Code of Federal Regulations; Chapter I; Part 15 - Radio frequency devices
RSS - 247 Issue 2	February 2017	Digital Transmission Systems (DTSs), Frequency Hopping Systems (FHSs) and Licence - Exempt Local Area Network (LE-LAN) Devices
RSS - Gen Issue 4	November 2014	Spectrum Management and Telecommunications Radio Standards Specifications - General Requirements and Information for the Certification of Radio Apparatus

Guidance	Version	Description
ANSI C63.4-2014	-/-	American national standard for methods of measurement of radio-noise emissions from low-voltage electrical and electronic equipment in the range of 9 kHz to 40 GHz
ANSI C63.10-2013	-/-	American national standard of procedures for compliance testing of unlicensed wireless devices

## 4 Test environment

Temperature	: T <sub>nom</sub> T <sub>max</sub> T <sub>min</sub>	+22 °C during room temperature tests No tests under extreme environmental conditions required. No tests under extreme environmental conditions required.
Relative humidity content	:	55 %
Barometric pressure	:	1021 hpa
Power supply	: V <sub>nom</sub> V <sub>max</sub> V <sub>min</sub>	3.7 V DC by external power supply or CR1254 A3 battery No tests under extreme environmental conditions required. No tests under extreme environmental conditions required.

## 5 Test item

### 5.1 General description

Kind of test item	:	In ear transceiver
Type identification	:	DE-NR-001
HMN	:	-/-
PMN	:	Digitear
HVIN	:	DE-NR INEAR
FVIN	:	v1.0
S/N serial number	:	Radiated units: BT address: 70B3D528FD0D BT address: 70B3D528FD11 Conducted unit: BT address: 70B3D528FD13
HW hardware status	:	Hardware: in-ear 5.3-1c, Schematic: InEar6c_5m_v2.scm
SW software status	:	v1.0
Frequency band	:	DTS band 2400 MHz to 2483.5 MHz
Type of radio transmission	:	FHSS
Use of frequency spectrum	:	
Type of modulation	:	GFSK, Pi/4 QPSK, 8 DPSK
Number of channels	:	79
Antenna	:	Integrated antenna
Power supply	:	3.7 V DC by CR1254 A3 battery
Temperature range	:	+5°C to +45°C

### 5.2 Additional information

The content of the following annexes is defined in the QA. It may be that not all of the listed annexes are necessary for this report, thus some values in between may be missing.

Test setup- and EUT-photos are included in test report: 1-5025/17-02-39\_AnnexA  
1-5025/17-02-39\_AnnexB  
1-5025/17-02-39\_AnnexD

## 6 Description of the test setup

Typically, the calibrations of the test apparatus are commissioned to and performed by an accredited calibration laboratory. The calibration intervals are determined in accordance with the DIN EN ISO/IEC 17025. In addition to the external calibrations, the laboratory executes comparison measurements with other calibrated test systems or effective verifications. Weekly chamber inspections and range calibrations are performed. Where possible, RF generating and signaling equipment as well as measuring receivers and analyzers are connected to an external high-precision 10 MHz reference (GPS-based or rubidium frequency standard).

In order to simplify the identification of the equipment used at some special tests, some items of test equipment and ancillaries can be provided with an identifier or number in the equipment list below (Lab/Item).

### **Agenda:** Kind of Calibration

k	calibration / calibrated	EK	limited calibration
ne	not required (k, ev, izw, zw not required)	zw	cyclical maintenance (external cyclical maintenance)
ev	periodic self verification	izw	internal cyclical maintenance
Ve	long-term stability recognized	g	blocked for accredited testing
vlk!	Attention: extended calibration interval		
NK!	Attention: not calibrated	*)	next calibration ordered / currently in progress

## 6.1 Shielded semi anechoic chamber

The radiated measurements are performed in vertical and horizontal plane in the frequency range from 30 MHz to 1 GHz in semi-anechoic chambers. The EUT is positioned on a non-conductive support with a height of 0.80 m above a conductive ground plane that covers the whole chamber. The receiving antennas are conform to specifications ANSI C63. These antennas can be moved over the height range between 1.0 m and 4.0 m in order to search for maximum field strength emitted from EUT. The measurement distances between EUT and receiving antennas are indicated in the test setups for the various frequency ranges. For each measurement, the EUT is rotated in all three axes until the maximum field strength is received. The wanted and unwanted emissions are received by spectrum analyzers where the detector modes and resolution bandwidths over various frequency ranges are set according to requirement ANSI C63.

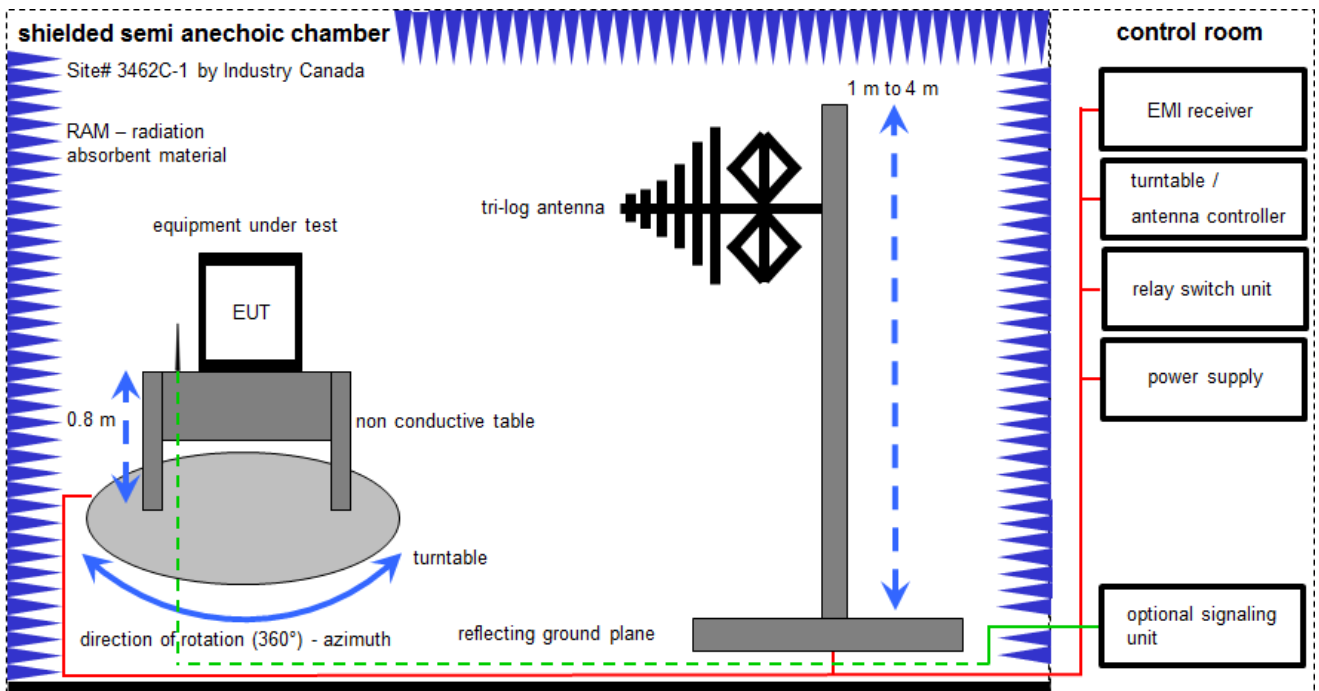

Measurement distance: tri-log antenna 10 meter

$$FS = UR + CL + AF$$

(FS-field strength; UR-voltage at the receiver; CL-loss of the cable; AF-antenna factor)

Example calculation:

$$FS [dB\mu V/m] = 12.35 [dB\mu V/m] + 1.90 [dB] + 16.80 [dB/m] = 31.05 [dB\mu V/m] (35.69 \mu V/m)$$

### Equipment table:

No.	Lab / Item	Equipment	Type	Manufacturer	Serial No.	INV. No.	Kind of Calibration	Last Calibration	Next Calibration
1	A	Switch-Unit	3488A	HP	2719A14505	300000368	ev	-/-	-/-
2	A	Meßkabine 1	HF-Absorberhalle	MWB AG 300023		300000551	ne	-/-	-/-
3	A	EMI Test Receiver	ESCI 3	R&S	100083	300003312	k	01.02.2017	31.01.2018
4	A	Antenna Tower	Model 2175	ETS-Lindgren	64762	300003745	izw	-/-	-/-
5	A	Positioning Controller	Model 2090	ETS-Lindgren	64672	300003746	izw	-/-	-/-
6	A	Turntable Interface-Box	Model 105637	ETS-Lindgren	44583	300003747	izw	-/-	-/-
7	A	TRILOG Broadband Test-Antenna 30 MHz - 3 GHz	VULB9163	Schwarzbeck	295	300003787	k	25.04.2016	25.04.2018
8	A	Bluetooth Tester	CBT35	R&S	100635	300003907	k	01.02.2016	01.02.2018

## 6.2 Shielded fully anechoic chamber

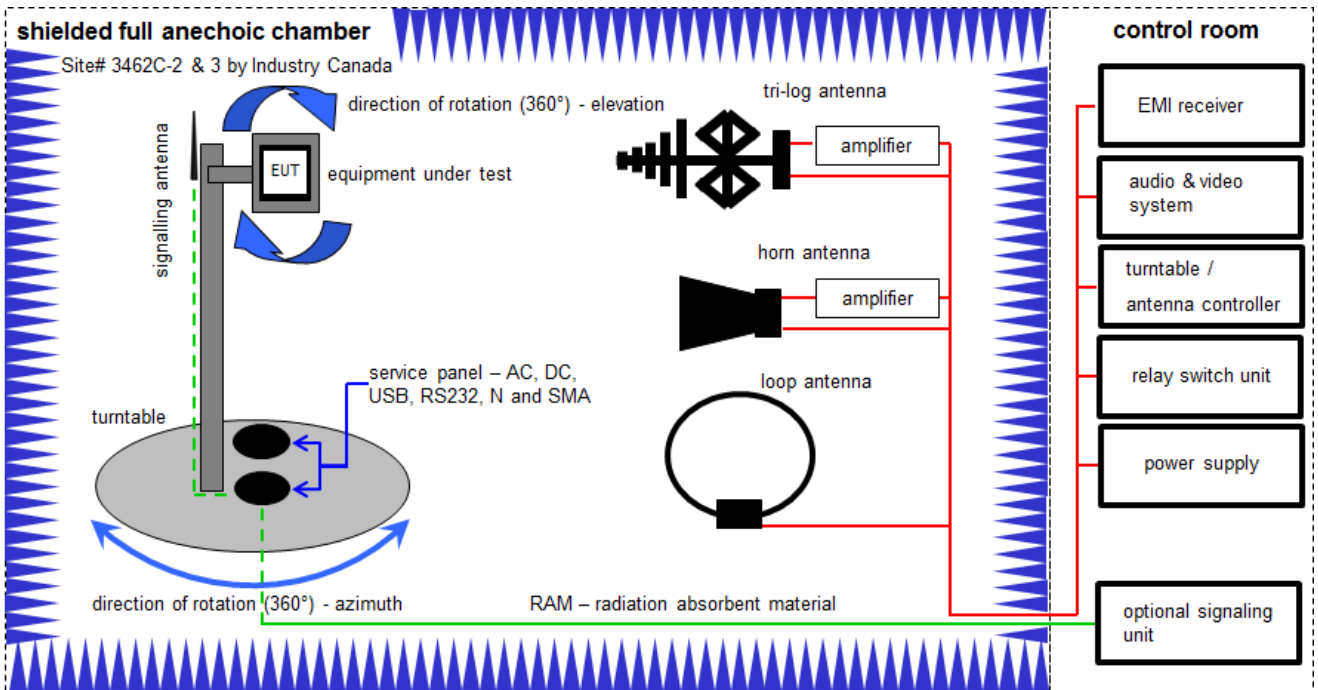

Measurement distance: tri-log antenna and horn antenna 3 meter; loop antenna 3 meter / 1 meter

$$FS = UR + CA + AF$$

(FS-field strength; UR-voltage at the receiver; CA-loss of the signal path; AF-antenna factor)

Example calculation:

$$FS [dB\mu V/m] = 40.0 [dB\mu V/m] + (-35.8) [dB] + 32.9 [dB/m] = 37.1 [dB\mu V/m] (71.61 \mu V/m)$$

### Equipment table:

No.	Lab / Item	Equipment	Type	Manufacturer	Serial No.	INV. No.	Kind of Calibration	Last Calibration	Next Calibration
1	C	Active Loop Antenna 9 kHz to 30 MHz	6502	EMCO	2210	300001015	k	07.07.2017	06.07.2019
2	A, B, C	Anechoic chamber	FAC 3/5m	MWB / TDK	87400/02	300000996	ev	-/-	-/-
3	A	Double-Ridged Waveguide Horn Antenna 1-18.0GHz	3115	EMCO	9107-3697	300001605	vIKI!	14.02.2017	13.02.2019
4	A, B, C	Switch / Control Unit	3488A	HP	*	300000199	ne	-/-	-/-
5	A	Band Reject filter	WRCG2400/2483-2375/2505-50/10SS	Wainwright	11	300003351	ev	-/-	-/-
6	A, B, C	EMI Test Receiver 20Hz- 26,5GHz	ESU26	R&S	100037	300003555	k	31.01.2017	30.01.2018
7	A	Highpass Filter	WHK1.1/15G-10SS	Wainwright	3	300003255	ev	-/-	-/-
8	A	Highpass Filter	WHKX7.0/18G-8SS	Wainwright	19	300003790	ne	-/-	-/-
9	A, B	TRILOG Broadband Test-Antenna 30 MHz - 3 GHz	VULB9163	Schwarzbeck	371	300003854	vIKI!	29.10.2014	29.10.2017
10	A	High Pass Filter	VHF-3500+	Mini Circuits	-/-	400000193	ne	-/-	-/-
11	A	Broadband Amplifier 0.5-18 GHz	CBLU5184540	CERNEX	22049	300004481	ev	-/-	-/-
12	A, B, C	4U RF Switch Platform	L4491A	Agilent Technologies	MY50000037	300004509	ne	-/-	-/-
13	A, B, C	NEXIO EMV-Software	BAT EMC V3.16.0.49	EMCO	-/-	300004682	ne	-/-	-/-
14	A, B, C	PC	ExOne	F+W	-/-	300004703	ne	-/-	-/-
15	A, B, C	Bluetooth Tester	CBT35	R&S	100635	300003907	k	01.02.2016	01.02.2018



### 6.3 Radiated measurements > 18 GHz

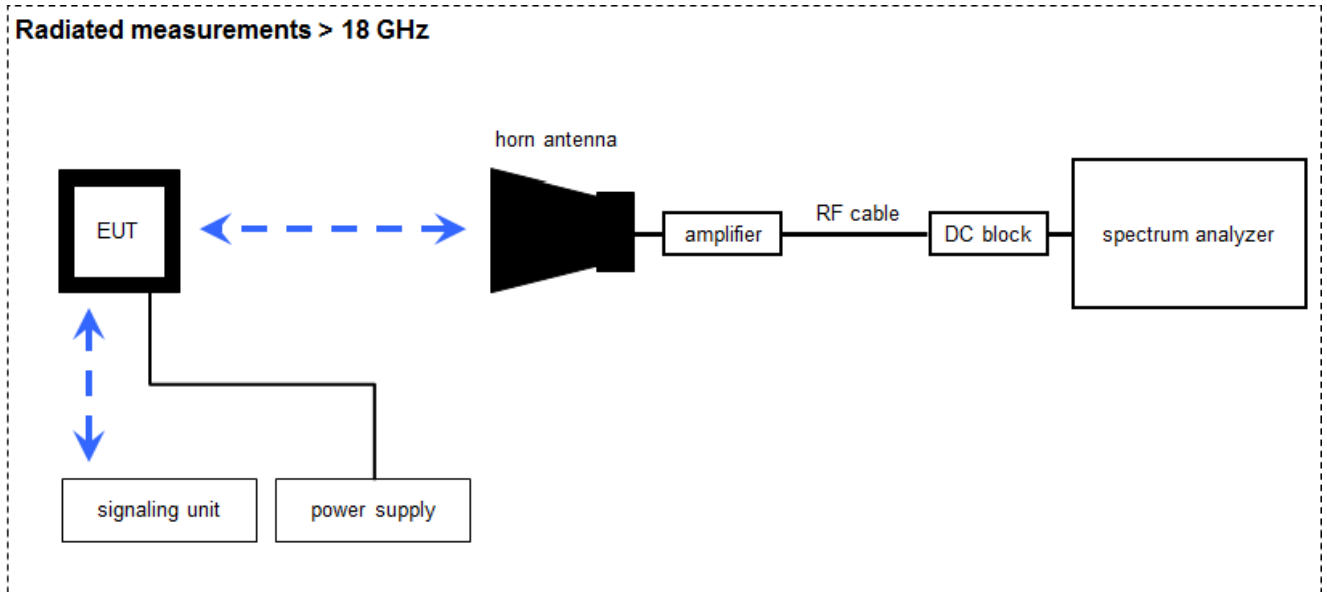

Measurement distance: horn antenna 50 cm

$$FS = UR + CA + AF$$

(FS-field strength; UR-voltage at the receiver; CA-loss signal path & distance correction; AF-antenna factor)

Example calculation:

$$FS [dB\mu V/m] = 40.0 [dB\mu V/m] + (-60.1) [dB] + 36.74 [dB/m] = 16.64 [dB\mu V/m] (6.79 \mu V/m)$$

#### Equipment table:

No.	Lab / Item	Equipment	Type	Manufacturer	Serial No.	INV. No.	Kind of Calibration	Last Calibration	Next Calibration
1	A	Horn Antenna 18,0-40,0 GHz	LHAF180	Microw.Devel	39180-103-022	300001748	k	22.05.2015	22.05.2018
2	A	Signal Analyzer 40 GHz	FSV40	R&S	101042	300004517	k	27.01.2017	26.01.2018
3	A	Microwave System Amplifier, 0.5-26.5 GHz	83017A	HP	00419	300002268	ev	-/-	-/-
4	A	RF-Cable	ST18/SMAm/SMAm/48	Huber & Suhner	Batch no. 600918	400001182	ev	-/-	-/-
5	A	RF-Cable	ST18/SMAm/SMAm/48	Huber & Suhner	Batch no. 127377	400001183	ev	-/-	-/-
6	A	DC-Blocker 0.1-40 GHz	8141A	Inmet	-/-	400001185	ev	-/-	-/-
7	A	Bluetooth Tester	CBT35	R&S	100635	300003907	k	01.02.2016	01.02.2018

## 6.4 Conducted measurements C.BER system

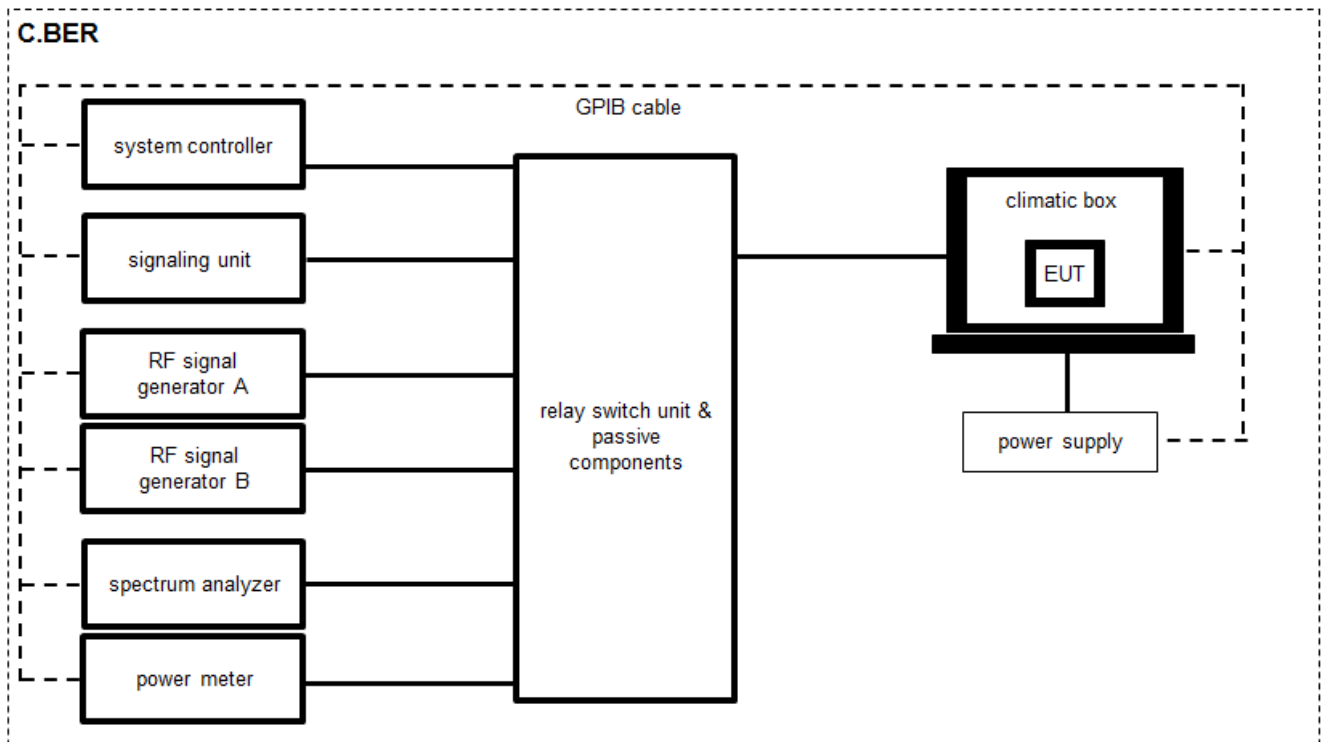

OP = AV + CA  
(OP-output power; AV-analyzer value; CA-loss signal path)

Example calculation:

OP [dBm] = 6.0 [dBm] + 11.7 [dB] = 17.7 [dBm] (58.88 mW)

**Equipment table:**

No.	Lab / Item	Equipment	Type	Manufacturer	Serial No.	INV. No.	Kind of Calibration	Last Calibration	Next Calibration
1	A	Switch / Control Unit	3488A	HP		300001691	ne	-/-	-/-
2	A	Signal Analyzer 20Hz-26,5GHz-150 to + 30 DBM	FSIQ26	R&S	835111/0004	300002678	vKI!	30.01.2017	29.01.2019
3	A	Frequency Standard (Rubidium Frequency Standard)	MFS (Rubidium)	R&S (Datum)	002	300002681	vKI!	27.01.2017	26.01.2019
4	A	Directional Coupler	101020010	Krytar	70215	300002840	ev	-/-	-/-
5	A	DC-Blocker	8143	Inmet Corp.	none	300002842	ne	-/-	-/-
6	A	Powersplitter	6005-3	Inmet Corp.	-/-	300002841	ev	-/-	-/-
7	A	CBT (Bluetooth Tester + EDR Signalling)	CBT 1153.9000K35, CBT-B55, CBT-K55	R&S	100313	300003516	vKI!	22.09.2016	22.09.2018
8	A	RF-Cable	ST18/SMAm/SMAm/ 48	Huber & Suhner	Batch no. 699866	400001189	ev	-/-	-/-
9	A	RF-Cable	ST18/SMAm/SMAm/ 48	Huber & Suhner	Batch no. 14844	400001190	ev	-/-	-/-

## 7 Sequence of testing

### 7.1 Sequence of testing radiated spurious 9 kHz to 30 MHz

#### Setup

- The equipment is set up to simulate normal operation mode as described in the user manual or defined by the manufacturer.
- If the EUT is a tabletop system, it is placed on a table with 0.8 m height.
- If the EUT is a floor standing device, it is placed directly on the turn table.
- Auxiliary equipment and cables are positioned to simulate normal operation conditions as described in ANSI C 63.4.
- The AC power port of the EUT (if available) is connected to a power outlet below the turntable.
- Measurement distance is 3 m (see ANSI C 63.4) – see test details.
- EUT is set into operation.

#### Premeasurement\*

- The turntable rotates from 0° to 315° using 45° steps.
- The antenna height is 1 m.
- At each turntable position the analyzer sweeps with positive-peak detector to find the maximum of all emissions.

#### Final measurement

- Identified emissions during the pre-measurement are maximized by the software by rotating the turntable from 0° to 360°.
- The final measurement is done in the position (turntable and elevation) causing the highest emissions with quasi-peak (as described in ANSI C 63.4).
- Final levels, frequency, measuring time, bandwidth, turntable position, correction factor, margin to the limit and limit will be recorded. A plot with the graph of the premeasurement and the limit is stored.

\*)Note: The sequence will be repeated three times with different EUT orientations.

## 7.2 Sequence of testing radiated spurious 30 MHz to 1 GHz

### Setup

- The equipment is set up to simulate normal operation mode as described in the user manual or defined by the manufacturer.
- If the EUT is a tabletop system, a table with 0.8 m height is used, which is placed on the ground plane.
- If the EUT is a floor standing device, it is placed on the ground plane with insulation between both.
- Auxiliary equipment and cables are positioned to simulate normal operation conditions as described in ANSI C 63.4.
- The AC power port of the EUT (if available) is connected to a power outlet below the turntable.
- Measurement distance is 10 m or 3 m (see ANSI C 63.4) – see test details.
- EUT is set into operation.

### Premeasurement

- The turntable rotates from 0° to 315° using 45° steps.
- The antenna is polarized vertical and horizontal.
- The antenna height changes from 1 m to 3 m.
- At each turntable position, antenna polarization and height the analyzer sweeps three times in peak to find the maximum of all emissions.

### Final measurement

- The final measurement is performed for at least six highest peaks according to the requirements of the ANSI C63.4.
- Based on antenna and turntable positions at which the peak values are measured the software maximize the peaks by changing turntable position  $\pm 45^\circ$  and antenna height between 1 and 4 m.
- The final measurement is done with quasi-peak detector (as described in ANSI C 63.4).
- Final levels, frequency, measuring time, bandwidth, antenna height, antenna polarization, turntable angle, correction factor, margin to the limit and limit are recorded. A plot with the graph of the premeasurement with marked maximum final results and the limit is stored.

### 7.3 Sequence of testing radiated spurious 1 GHz to 18 GHz

#### Setup

- The equipment is set up to simulate normal operation mode as described in the user manual or defined by the manufacturer.
- If the EUT is a tabletop system, a 2-axis positioner with 1.5 m height is used.
- If the EUT is a floor standing device, it is placed directly on the turn table.
- Auxiliary equipment and cables are positioned to simulate normal operation conditions as described in ANSI C 63.4.
- The AC power port of the EUT (if available) is connected to a power outlet below the turntable.
- Measurement distance is 3 m (see ANSI C 63.4) – see test details.
- EUT is set into operation.

#### Premeasurement

- The turntable rotates from 0° to 315° using 45° steps.
- The antenna is polarized vertical and horizontal.
- The antenna height is 1.5 m.
- At each turntable position and antenna polarization the analyzer sweeps with positive peak detector to find the maximum of all emissions.

#### Final measurement

- The final measurement is performed for at least six highest peaks according to the requirements of the ANSI C63.4.
- Based on antenna and turntable positions at which the peak values are measured the software maximizes the peaks by rotating the turntable from 0° to 360°. This measurement is repeated for different EUT-table positions (0° to 150° in 30°-steps) and for both antenna polarizations.
- The final measurement is done in the position (turntable, EUT-table and antenna polarization) causing the highest emissions with Peak and RMS detector (as described in ANSI C 63.4).
- Final levels, frequency, measuring time, bandwidth, turntable position, EUT-table position, antenna polarization, correction factor, margin to the limit and limit are recorded. A plot with the graph of the premeasurement with marked maximum final results and the limit is stored.

## 7.4 Sequence of testing radiated spurious above 18 GHz

### Setup

- The equipment is set up to simulate normal operation mode as described in the user manual or defined by the manufacturer.
- Auxiliary equipment and cables are positioned to simulate normal operation conditions as described in ANSI C 63.4.
- The AC power port of the EUT (if available) is connected to a power outlet.
- The measurement distance is as appropriate (e.g. 0.5 m).
- The EUT is set into operation.

### Premeasurement

- The test antenna is handheld and moved carefully over the EUT to cover the EUT's whole sphere and different polarizations of the antenna.

### Final measurement

- The final measurement is performed at the position and antenna orientation causing the highest emissions with Peak and RMS detector (as described in ANSI C 63.4).
- Final levels, frequency, measuring time, bandwidth, correction factor, margin to the limit and limit are recorded. A plot with the graph of the premeasurement and the limit is stored.

## 8 Measurement uncertainty

Measurement uncertainty	
Test case	Uncertainty
Antenna gain	± 3 dB
Carrier frequency separation	± 21.5 kHz
Number of hopping channels	-/-
Time of occupancy	According BT Core specification
Spectrum bandwidth	± 21.5 kHz absolute; ± 15.0 kHz relative
Maximum output power	± 1 dB
Detailed conducted spurious emissions @ the band edge	± 1 dB
Band edge compliance radiated	± 3 dB
Spurious emissions conducted	± 3 dB
Spurious emissions radiated below 30 MHz	± 3 dB
Spurious emissions radiated 30 MHz to 1 GHz	± 3 dB
Spurious emissions radiated 1 GHz to 12.75 GHz	± 3.7 dB
Spurious emissions radiated above 12.75 GHz	± 4.5 dB
Spurious emissions conducted below 30 MHz (AC conducted)	± 2.6 dB

## 9 Summary of measurement results

<input checked="" type="checkbox"/>	No deviations from the technical specifications were ascertained
<input type="checkbox"/>	There were deviations from the technical specifications ascertained
<input type="checkbox"/>	This test report is only a partial test report. The content and verdict of the performed test cases are listed below.

TC Identifier	Description	Verdict	Date	Remark
RF-Testing	CFR Part 15 RSS - 247, Issue 2	See table!	2017-11-08	-/-

Test specification clause	Test case	Temperature conditions	Power source voltages	Mode	C	NC	NA	NP	Remark
§15.247(b)(4) RSS - 247 / 4.(f)(ii)	Antenna gain	Nominal	Nominal	GFSK	<input checked="" type="checkbox"/>	<input type="checkbox"/>	<input type="checkbox"/>	<input type="checkbox"/>	-/-
§15.247(a)(1) RSS - 247 / 5.1.(b)	Carrier frequency separation	Nominal	Nominal	GFSK	<input checked="" type="checkbox"/>	<input type="checkbox"/>	<input type="checkbox"/>	<input type="checkbox"/>	-/-
§15.247(a)(1) RSS - 247 / 5.1 (d)	Number of hopping channels	Nominal	Nominal	GFSK	<input checked="" type="checkbox"/>	<input type="checkbox"/>	<input type="checkbox"/>	<input type="checkbox"/>	-/-
§15.247(a)(1) (iii) RSS - 247 / 5.1 (c)	Time of occupancy (dwell time)	Nominal	Nominal	GFSK Pi/4 DQPSK 8 DPSK	<input checked="" type="checkbox"/>	<input type="checkbox"/>	<input type="checkbox"/>	<input type="checkbox"/>	-/-
§15.247(a)(1) RSS - 247 / 5.1 (a)	Spectrum bandwidth of a FHSS system bandwidth	Nominal	Nominal	GFSK Pi/4 DQPSK 8 DPSK	<input checked="" type="checkbox"/> <input checked="" type="checkbox"/> <input checked="" type="checkbox"/>	<input type="checkbox"/> <input type="checkbox"/> <input type="checkbox"/>	<input type="checkbox"/> <input type="checkbox"/> <input type="checkbox"/>	<input type="checkbox"/> <input type="checkbox"/> <input type="checkbox"/>	-/-
§15.247(b)(1) RSS - 247 / 5.4 (b)	Maximum output power	Nominal	Nominal	GFSK Pi/4 DQPSK 8 DPSK	<input checked="" type="checkbox"/> <input checked="" type="checkbox"/> <input checked="" type="checkbox"/>	<input type="checkbox"/> <input type="checkbox"/> <input type="checkbox"/>	<input type="checkbox"/> <input type="checkbox"/> <input type="checkbox"/>	<input type="checkbox"/> <input type="checkbox"/> <input type="checkbox"/>	-/-
§15.247(d) RSS - 247 / 5.5	Detailed spurious emissions @ the band edge - conducted	Nominal	Nominal	GFSK Pi/4 DQPSK 8 DPSK	<input checked="" type="checkbox"/> <input checked="" type="checkbox"/> <input checked="" type="checkbox"/>	<input type="checkbox"/> <input type="checkbox"/> <input type="checkbox"/>	<input type="checkbox"/> <input type="checkbox"/> <input type="checkbox"/>	<input type="checkbox"/> <input type="checkbox"/> <input type="checkbox"/>	-/-
§15.205 RSS - 247 / 5.5 RSS - Gen	Band edge compliance radiated	Nominal	Nominal	GFSK Pi/4 DQPSK 8 DPSK	<input checked="" type="checkbox"/> <input checked="" type="checkbox"/> <input checked="" type="checkbox"/>	<input type="checkbox"/> <input type="checkbox"/> <input type="checkbox"/>	<input type="checkbox"/> <input type="checkbox"/> <input type="checkbox"/>	<input type="checkbox"/> <input type="checkbox"/> <input type="checkbox"/>	-/-
§15.247(d) RSS - 247 / 5.5	Spurious emissions conducted	Nominal	Nominal	GFSK Pi/4 DQPSK 8 DPSK	<input checked="" type="checkbox"/> <input checked="" type="checkbox"/> <input checked="" type="checkbox"/>	<input type="checkbox"/> <input type="checkbox"/> <input type="checkbox"/>	<input type="checkbox"/> <input type="checkbox"/> <input type="checkbox"/>	<input type="checkbox"/> <input type="checkbox"/> <input type="checkbox"/>	-/-
§15.209(a) RSS - Gen	Spurious emissions radiated below 30 MHz	Nominal	Nominal	GFSK	<input checked="" type="checkbox"/>	<input type="checkbox"/>	<input type="checkbox"/>	<input type="checkbox"/>	-/-
§15.247(d) RSS - 247 / 5.5 §15.109 RSS - Gen	Spurious emissions radiated 30 MHz to 1 GHz	Nominal	Nominal	GFSK RX mode	<input checked="" type="checkbox"/>	<input type="checkbox"/>	<input type="checkbox"/>	<input type="checkbox"/>	-/-
§15.247(d) RSS - 247 / 5.5 §15.109 RSS - Gen	Spurious emissions radiated above 1 GHz	Nominal	Nominal	GFSK RX mode	<input checked="" type="checkbox"/>	<input type="checkbox"/>	<input type="checkbox"/>	<input type="checkbox"/>	-/-
§15.107(a) §15.207	Conducted emissions below 30 MHz (AC conducted)	Nominal	Nominal	GFSK RX mode	<input type="checkbox"/>	<input type="checkbox"/>	<input checked="" type="checkbox"/>	<input type="checkbox"/>	Only battery powered

**Notes:**

<b>C</b> Compliant	<b>NC</b> Not compliant	<b>NA</b> Not applicable	<b>NP</b> Not performed
--------------------	-------------------------	--------------------------	-------------------------



## 10 Additional comments

The Bluetooth® word mark and logos are owned by the Bluetooth SIG Inc. and any use of such marks by CTC advanced GmbH is under license.

Reference documents: Customer\_Questionnaire

Special test descriptions: None

Configuration descriptions: TX tests: were performed with x-DH5 packets and static PRBS pattern payload.  
RX/Standby tests: BT test mode enabled, scan enabled, TX Idle

Test mode:

- Bluetooth Test mode loop back enabled (EUT is controlled over CBT/CMU/CMW)
- Special software is used.  
EUT is transmitting pseudo random data by itself

Antennas and transmit operating modes:

- Operating mode 1 (single antenna)
  - Equipment with 1 antenna,
  - Equipment with 2 diversity antennas operating in switched diversity mode by which at any moment in time only 1 antenna is used,
  - Smart antenna system with 2 or more transmit/receive chains, but operating in a mode where only 1 transmit/receive chain is used)

## 11 Measurement results

### 11.1 Antenna gain

**Measurement:**

The antenna gain of the complete system is calculated by the difference of radiated power in EIRP and the conducted power of the module. For normal Bluetooth® devices, the GFSK modulation is used.

Measurement parameters	
Detector	Peak
Sweep time	Auto
Resolution bandwidth	3 MHz
Video bandwidth	3 MHz
Span	5 MHz
Trace mode	Max hold
Test setup	See sub clause 6.2 B (radiated) See sub clause 6.4 A (conducted)
Measurement uncertainty	See sub clause 8

**Limits:**

FCC	IC
6 dBi / > 6 dBi output power and power density reduction required	

**Results:**

T <sub>nom</sub>	V <sub>nom</sub>	lowest channel 2402 MHz	middle channel 2441 MHz	highest channel 2480 MHz
Conducted power [dBm] Measured with GFSK modulation		7.3	8.6	8.6
Radiated power [dBm] Measured with GFSK modulation		-1.6	-2.2	-0.5
Gain [dBi] Calculated		-8.9	-10.8	-9.1

## 11.2 Carrier frequency separation

**Description:**

Measurement of the carrier frequency separation of a hopping system. The carrier frequency separation is constant for all modulation-modes. We use GFSK-modulation to show compliance. EUT in hopping mode.

Measurement parameters	
Detector	Peak
Sweep time	Auto
Resolution bandwidth	100 kHz
Video bandwidth	300 kHz
Span	4 MHz
Trace mode	Max hold
Test setup	See sub clause 6.4 A
Measurement uncertainty	See sub clause 8

**Limits:**

FCC	IC
Carrier frequency separation	
Minimum 25 kHz or two-thirds of the 20 dB bandwidth of the hopping system whichever is greater.	

**Result:**

Carrier frequency separation	~ 1 MHz
------------------------------	---------

**Plot:**

**Plot 1: Carrier frequency separation (GFSK modulation)**

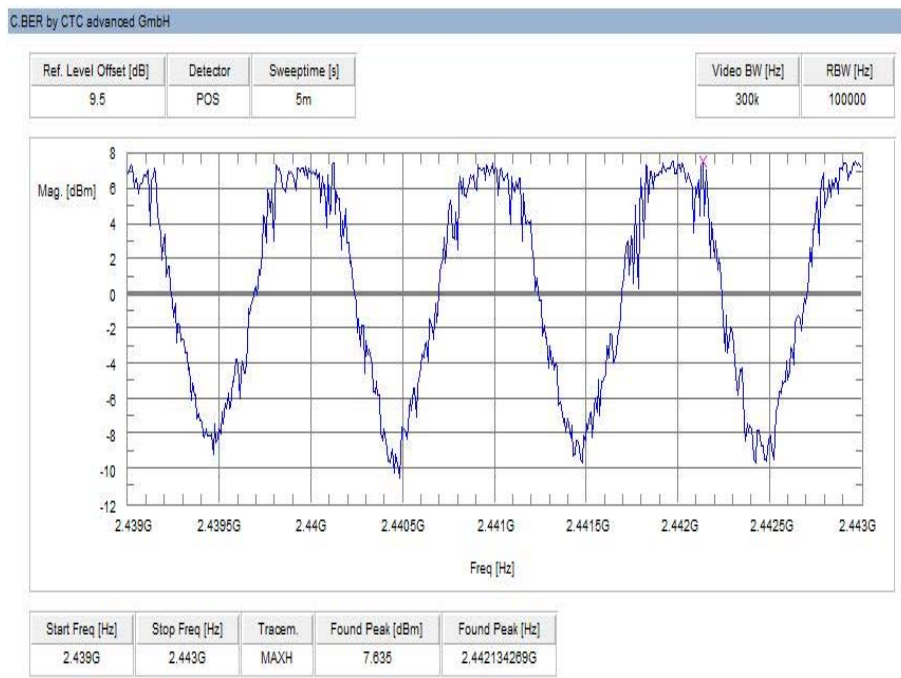

### 11.3 Number of hopping channels

**Description:**

Measurement of the total number of used hopping channels. The number of hopping channels is constant for all modulation-modes. We use GFSK-modulation to show compliance. EUT in hopping mode.

Measurement parameters	
Detector	Peak
Sweep time	Auto
Resolution bandwidth	500 kHz
Video bandwidth	500 kHz
Span	Plot 1: 2400 – 2445 MHz Plot 2: 2445 – 2485 MHz
Trace mode	Max hold
Test setup	See sub clause 6.4 A
Measurement uncertainty	See sub clause 8

**Limits:**

FCC	IC
Number of hopping channels	
At least 15 non overlapping hopping channels	

**Result:**

Number of hopping channels	79
----------------------------	----

**Plots:**

**Plot 1:** Number of hopping channels (GFSK modulation)

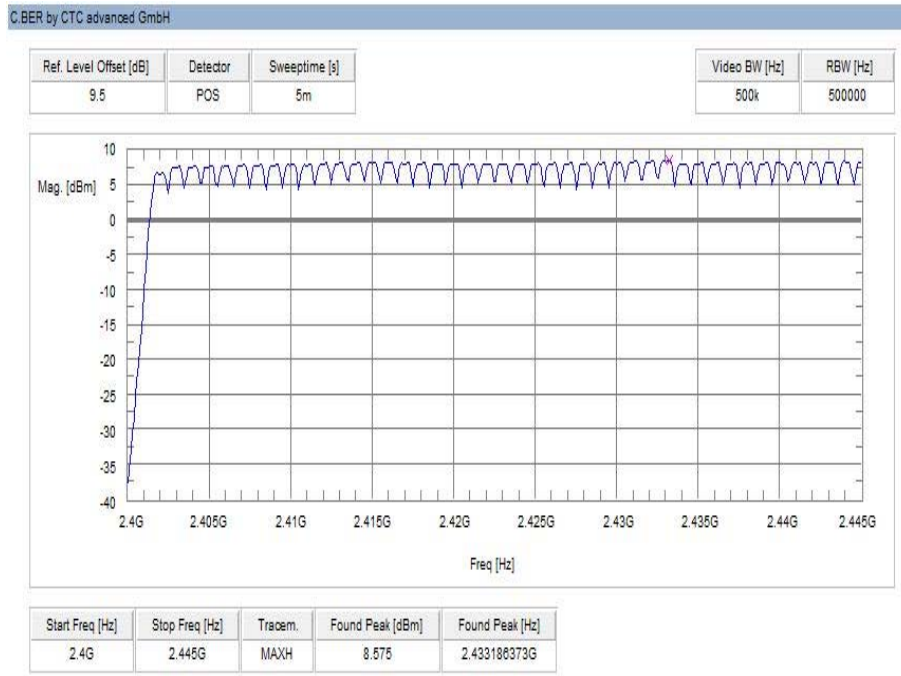

**Plot 2:** Number of hopping channels (GFSK modulation)

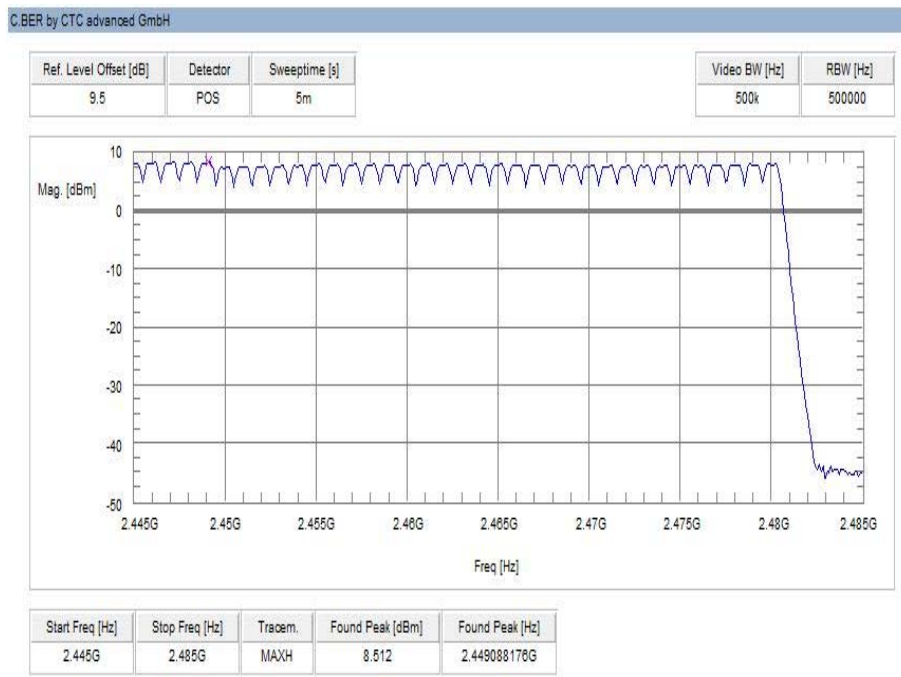

## 11.4 Time of occupancy (dwell time)

### Measurement:

For Bluetooth® devices no measurements mandatory depending on the fixed requirements according to the Bluetooth® Core Specifications!

### For Bluetooth® devices:

The channel staying time of 0.4 s within a 31.6 second period in data mode is constant for Bluetooth® devices and independent from the packet type (packet length). The calculation for a 31.6 second period is as follows:

Channel staying time = time slot length \* hop rate / number of hopping channels \* 31.6 s

Example for a DH1 packet (with a maximum length of one time slot)  
Channel staying time =  $625 \mu\text{s} * 1600 * 1/\text{s} / 79 * 31.6 \text{ s} = 0.4 \text{ s}$  (in a 31.6 s period)

For multi-slot packets the hopping is reduced according to the length of the packet.

Example for a DH3 packet (with a maximum length of three time slots)  
Channel staying time =  $3 * 625 \mu\text{s} * 1600/3 * 1/\text{s} / 79 * 31.6 \text{ s} = 0.4 \text{ s}$  (in a 31.6 s period)

Example for a DH5 packet (with a maximum length of five time slots)  
Channel staying time =  $5 * 625 \mu\text{s} * 1600/5 * 1/\text{s} / 79 * 31.6 \text{ s} = 0.4 \text{ s}$  (in a 31.6 s period)

This is according to the Bluetooth® Core Specification V2.0 & V2.1 & V3.0 & V4.0 (+ critical errata) for all Bluetooth® devices and all modulations.

### The following table shows the relations:

Packet Size	Pulse Width [ms] *	Max. number of transmissions per channel in 31.6 sec
DH1	0.366	640
DH3	1.622	214
DH5	2.870	128

\* according Bluetooth® specification

### Results:

Packet Size	Pulse Width [ms]*	Max. number of transmissions in 31.6 sec	Time of occupancy (dwell time) [Pulse width * Number of transmissions]
DH1	0.366	640	234.2 ms
DH3	1.622	214	347.1 ms
DH5	2.870	128	367.4 ms

### Limits:

FCC	IC
Time of occupancy (dwell time)	
The frequency hopping operation shall have an average time of occupancy on any frequency not exceeding 0.4 seconds within a duration in seconds equal to the number of hopping frequencies multiplied by 0.4.	

## 11.5 Spectrum bandwidth of a FHSS system

### Description:

Measurement of the 20dB bandwidth and 99% bandwidth of the modulated signal. The measurement is performed according to the "Measurement Guidelines" (DA 00-705, March 30, 2000). EUT in single channel mode.

Measurement parameters	
Detector	Peak
Sweep time	Auto
Resolution bandwidth	30 kHz
Video bandwidth	100 kHz
Span	3 MHz
Trace mode	Max hold
Test setup	See sub clause 6.4 A
Measurement uncertainty	See sub clause 8

### Limits:

FCC	IC
Spectrum bandwidth of a FHSS system	
GFSK < 1500 kHz Pi/4 DQPSK < 1500 kHz 8DPSK < 1500 kHz	



**Results:**

Modulation Frequency	20 dB bandwidth [kHz]		
	2402 MHz	2441 MHz	2480 MHz
GFSK	938	938	946
Pi/4 DQPSK	1259	1259	1234
8DPSK	1267	1267	1299

**Results:**

Modulation Frequency	99 % bandwidth [kHz]		
	2402 MHz	2441 MHz	2480 MHz
GFSK	882	850	866
Pi/4 DQPSK	1170	1170	1162
8DPSK	1170	1186	1194

**Plots:**

**Plot 1:** lowest channel – 2402 MHz, GFSK modulation

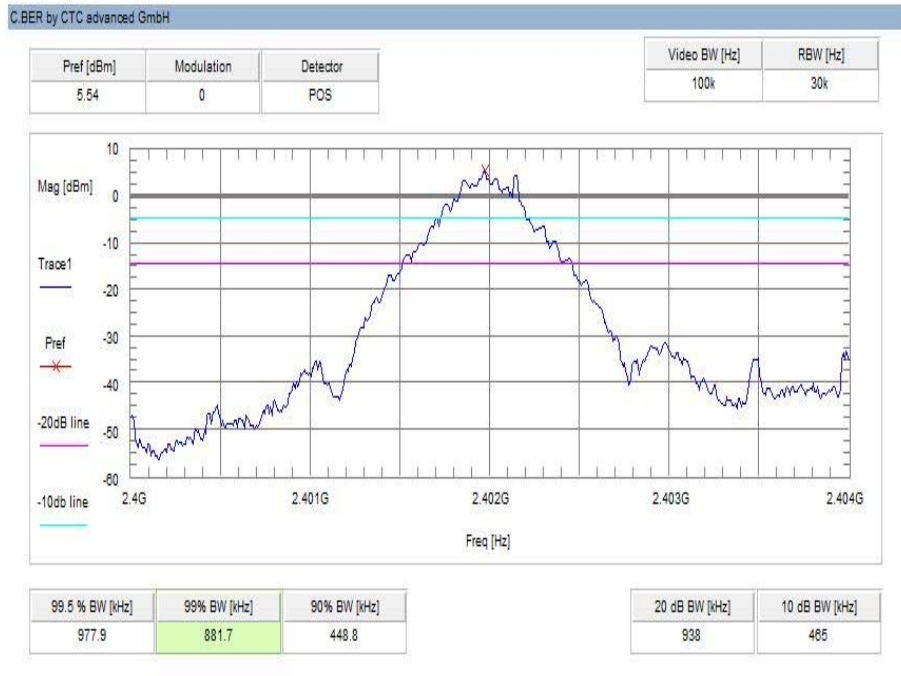

**Plot 2:** middle channel – 2441 MHz, GFSK modulation

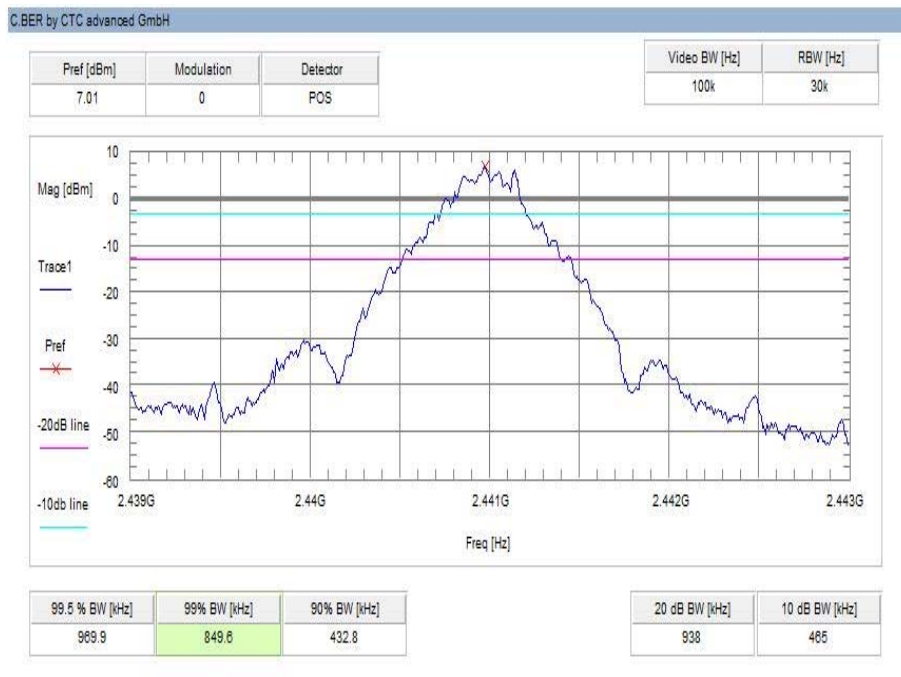

**Plot 3:** highest channel – 2480 MHz, GFSK modulation

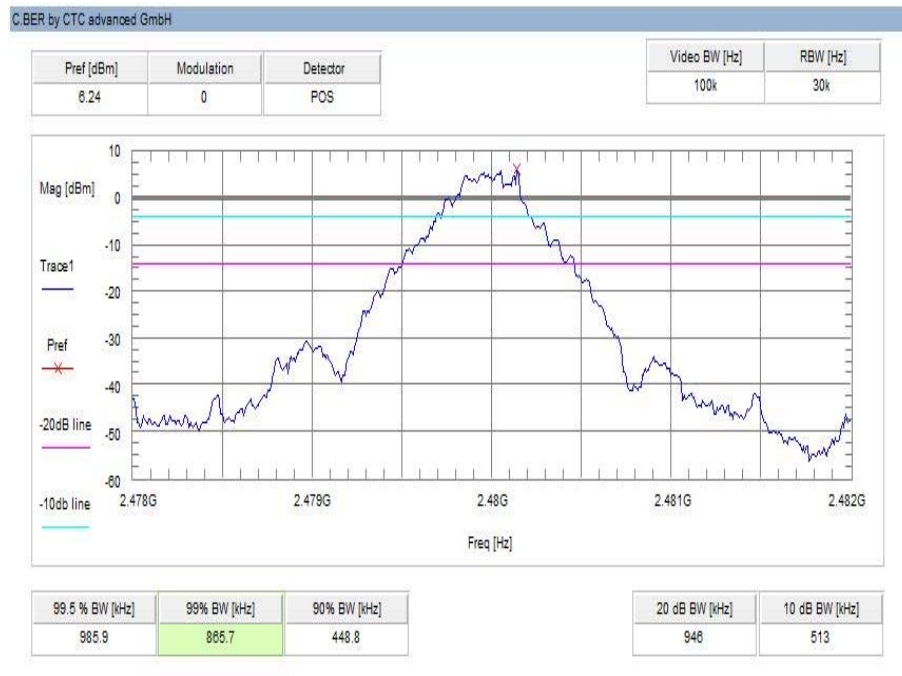

**Plot 4:** lowest channel – 2402 MHz, Pi / DQPSK modulation

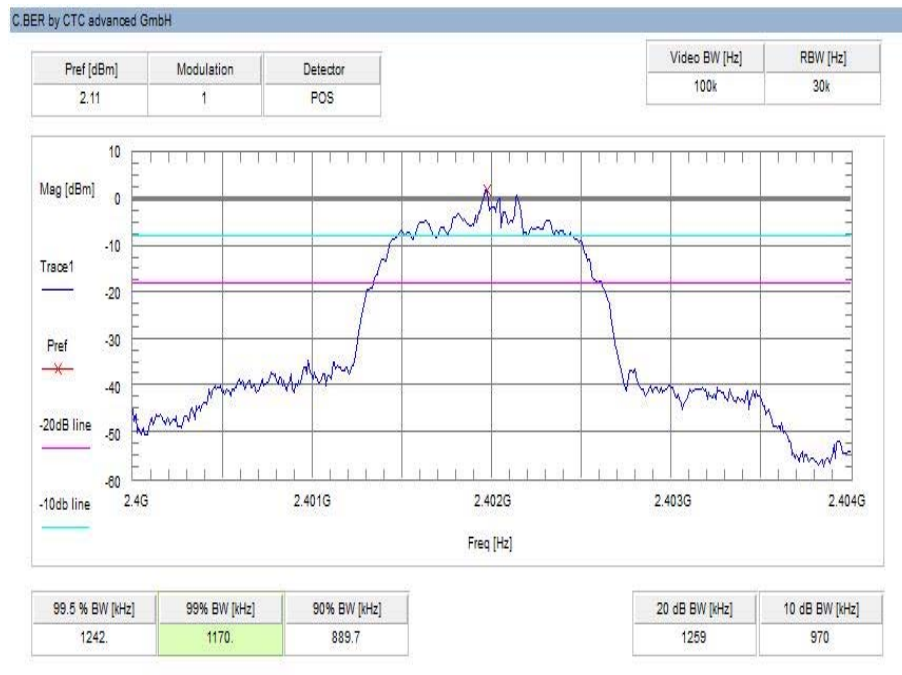

**Plot 5:** middle channel – 2441 MHz, Pi / DQPSK modulation

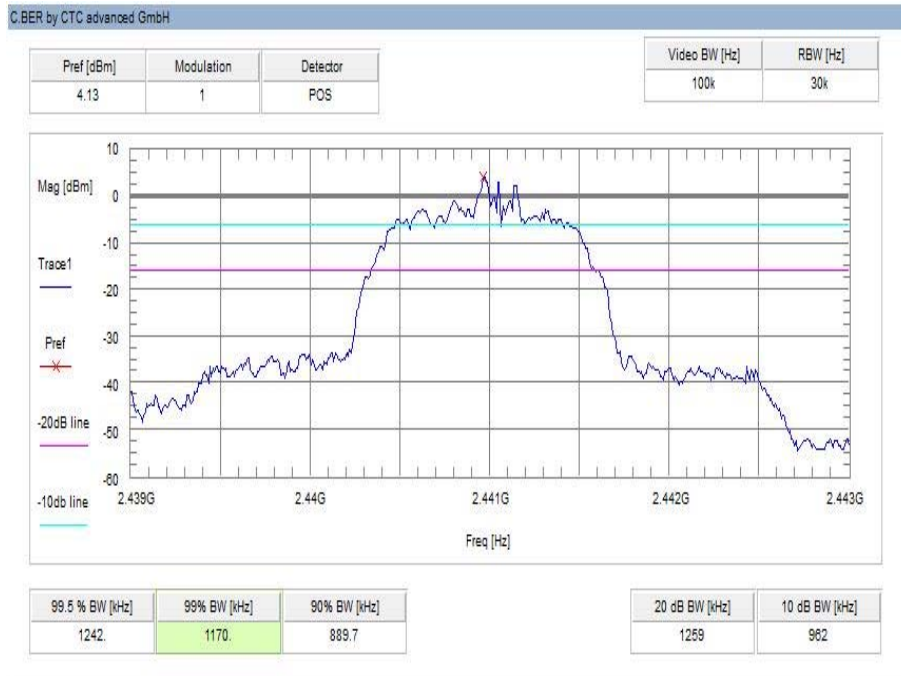

**Plot 6:** highest channel – 2480 MHz, Pi / DQPSK modulation

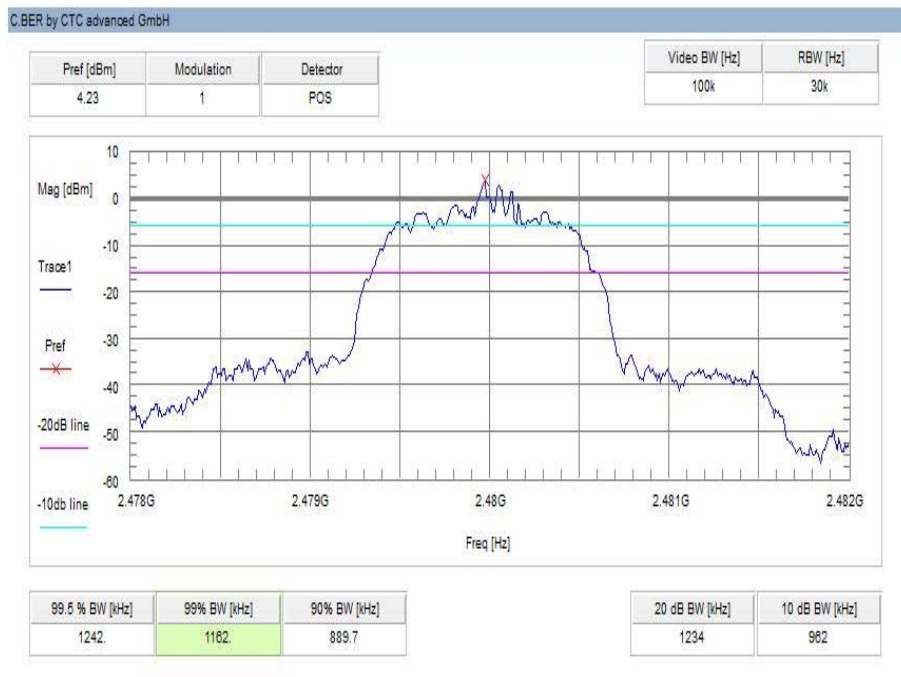

**Plot 7:** lowest channel – 2402 MHz, 8 DPSK modulation

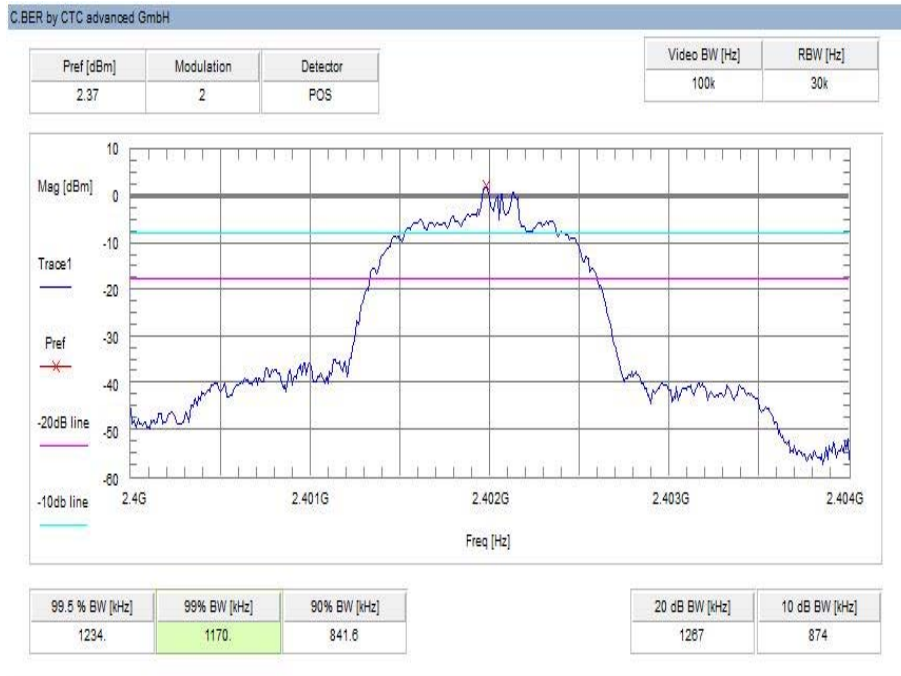

**Plot 8:** middle channel – 2441 MHz, 8 DPSK modulation

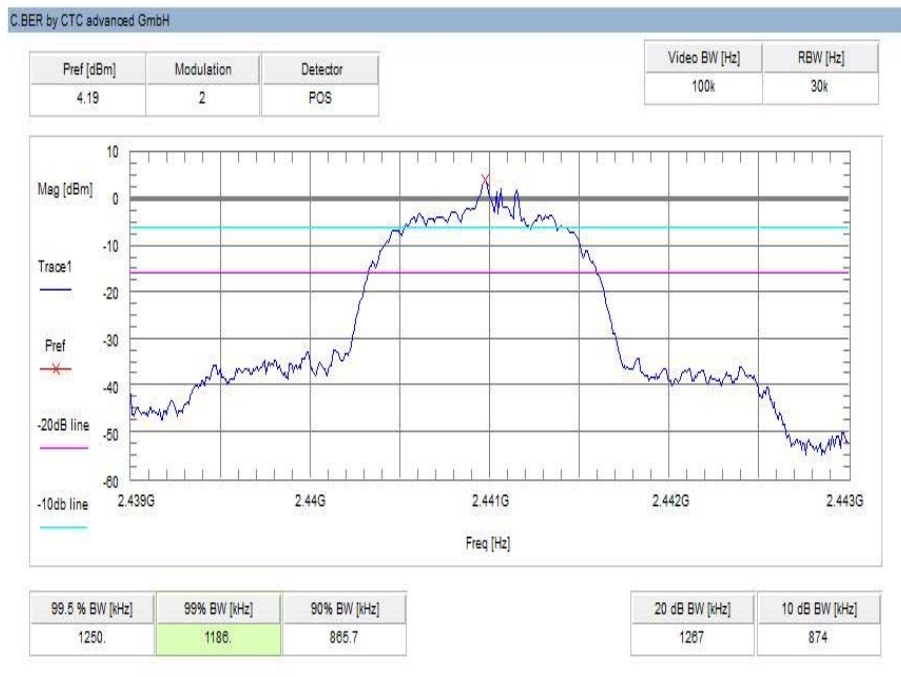

**Plot 9:** highest channel – 2480 MHz, 8 DPSK modulation



## 11.6 Maximum output power

### Description:

Measurement of the maximum output power conducted and radiated. EUT in single channel mode. The measurement is performed according to the ANSI C63.10.

Measurement parameters	
Detector	Peak
Sweep time	Auto
Resolution bandwidth	3 MHz
Video bandwidth	10 MHz
Span	6 MHz
Trace mode	Max hold
Test setup	See sub clause 6.4 A
Measurement uncertainty	See sub clause 8

### Limits:

FCC	IC
Maximum output power	
[Conducted: 0.125 W – antenna gain max. 6 dBi] Systems using more than 75 hopping channels: Conducted: 1.0 W – antenna gain max. 6 dBi	

### Results:

Modulation	Maximum output power conducted [dBm]		
	2402 MHz	2441 MHz	2480 MHz
Frequency			
GFSK	7.3	8.6	8.6
Pi/4 DQPSK	5.0	6.8	6.8
8 DPSK	5.4	7.2	7.2

**Plots:**

**Plot 1:** lowest channel – 2402 MHz, GFSK modulation

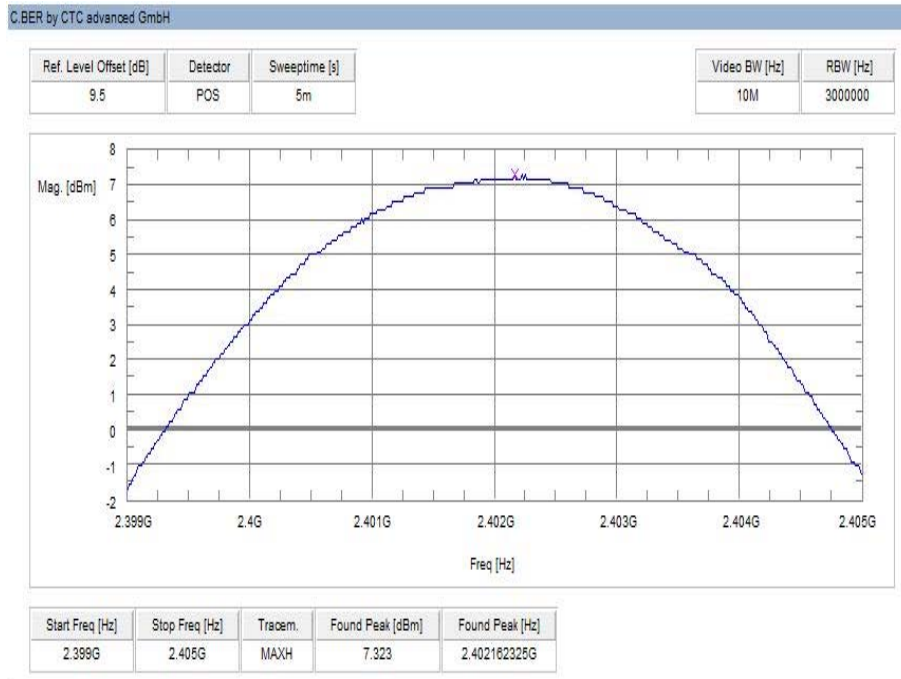

**Plot 2:** middle channel – 2441 MHz, GFSK modulation

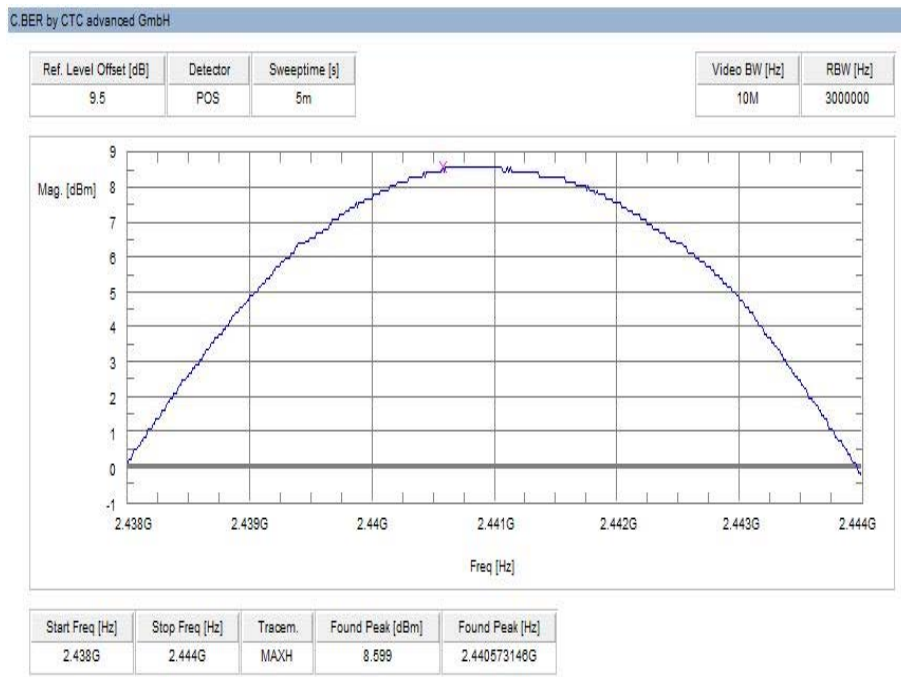



**Plot 3:** highest channel – 2480 MHz, GFSK modulation

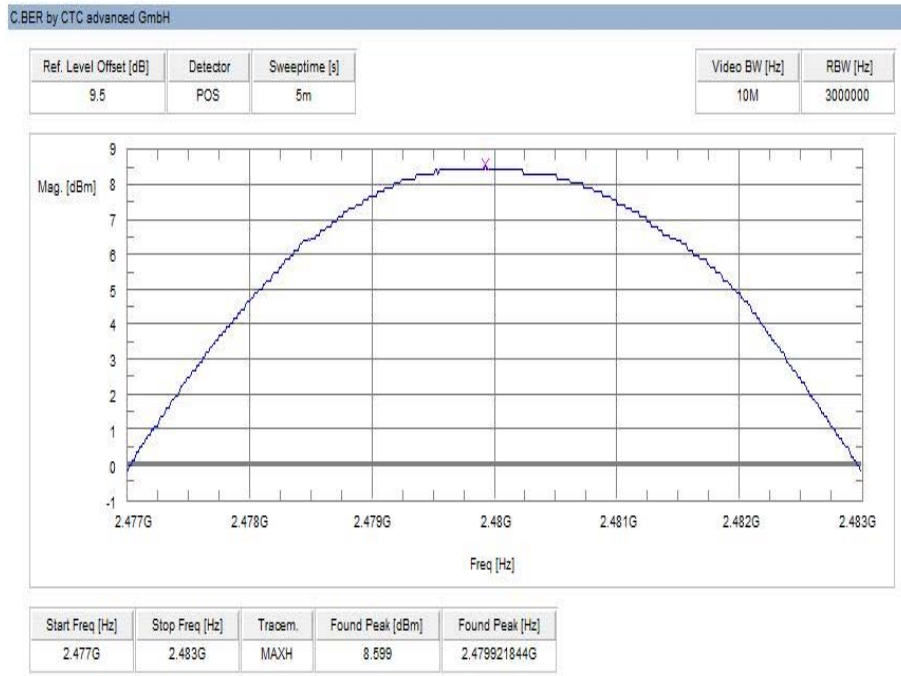

**Plot 4:** lowest channel – 2402 MHz, Pi / DQPSK modulation

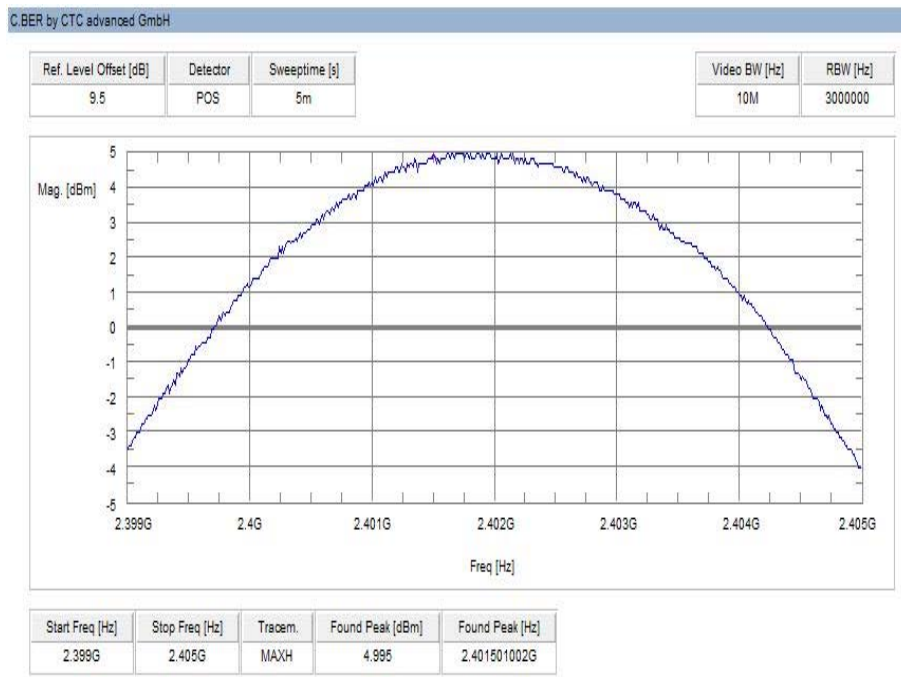

**Plot 5:** middle channel – 2441 MHz, Pi / DQPSK modulation

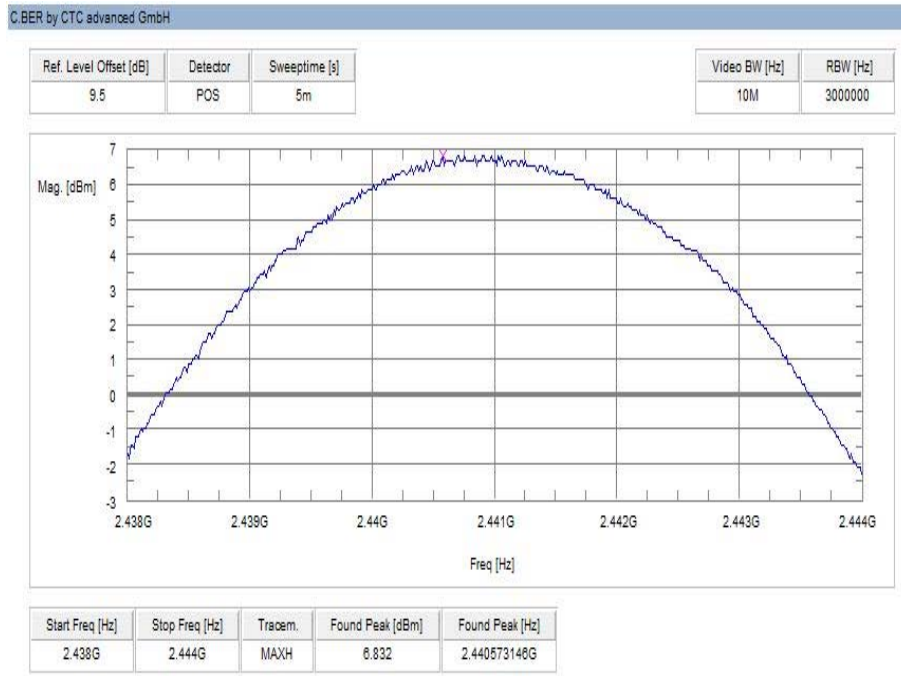

**Plot 6:** highest channel – 2480 MHz, Pi / DQPSK modulation

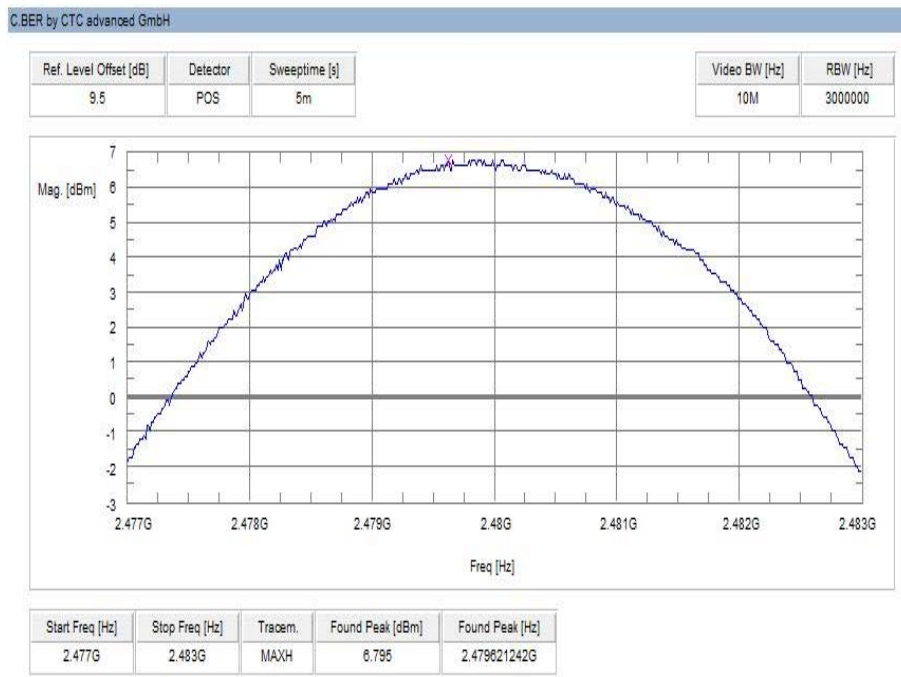

**Plot 7:** lowest channel – 2402 MHz, 8 DPSK modulation

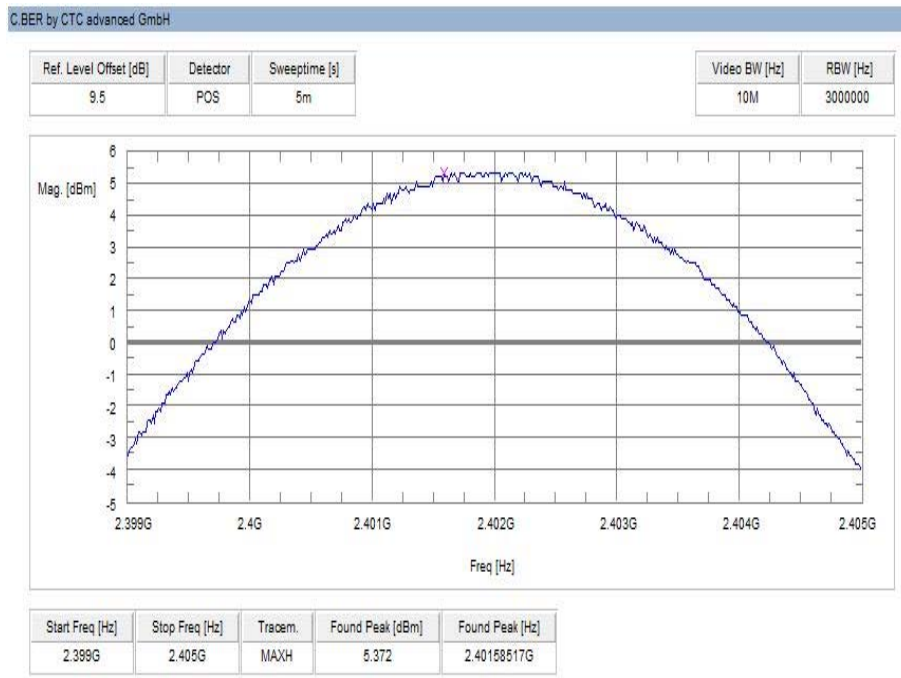

**Plot 8:** middle channel – 2441 MHz, 8 DPSK modulation

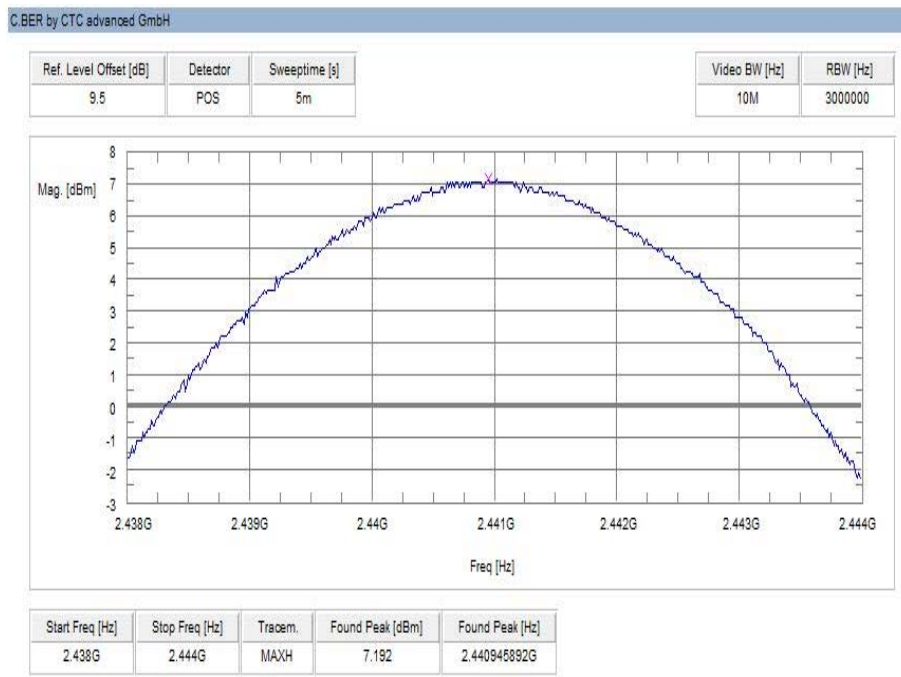

**Plot 9:** highest channel – 2480 MHz, 8 DPSK modulation

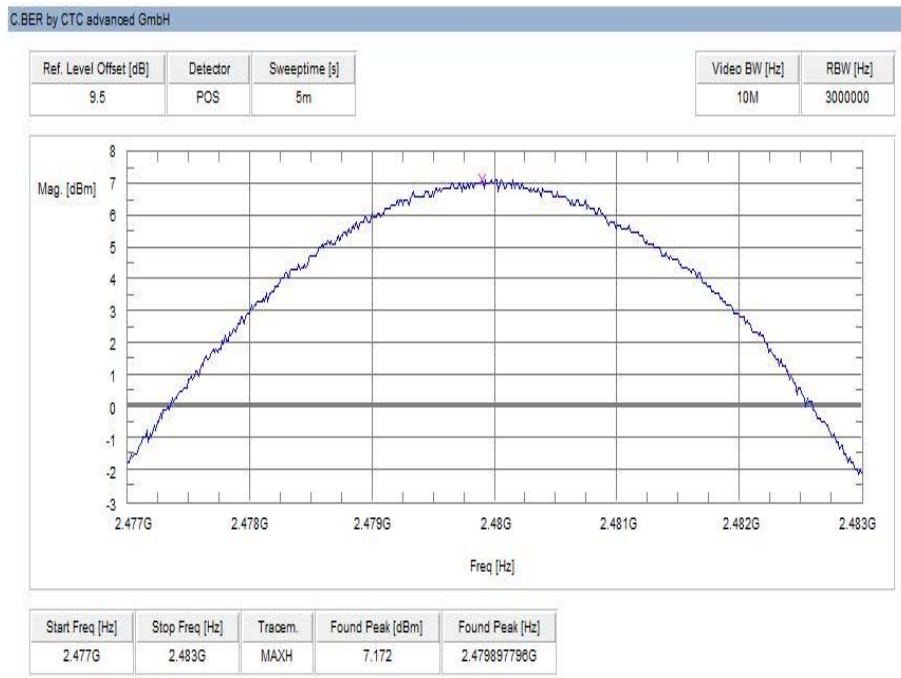

## 11.7 Detailed spurious emissions @ the band edge - conducted

### Description:

Measurement of the conducted band edge compliance. EUT is measured at the lower and upper band edge in single channel and hopping mode. The measurement is repeated for all modulations.

Measurement parameters	
Detector	Peak
Sweep time	Auto
Resolution bandwidth	100 kHz
Video bandwidth	300 kHz / 500 kHz
Span	Lower Band Edge: 2395 – 2405 MHz Upper Band Edge: 2478 – 2489 MHz
Trace mode	Max hold
Test setup	See sub clause 6.4 A
Measurement uncertainty	See sub clause 8

### Limits:

FCC	IC
<p>In any 100 kHz bandwidth outside the frequency band in which the spread spectrum or digitally modulated intentional radiator is operating, the radio frequency power that is produced by the intentional radiator shall be at least 20 dB below that in the 100 kHz bandwidth within the band that contains the highest level of the desired power, based on either an RF conducted or a radiated measurement. Attenuation below the general limits specified in Section 15.209(a) is not required.</p>	

### Results:

Scenario Modulation	Spurious band edge conducted [dB]		
	GFSK	Pi/4 DQPSK	8DPSK
Lower band edge – hopping off	> 20 dB	> 20 dB	> 20 dB
Lower band edge – hopping on	> 20 dB	> 20 dB	> 20 dB
Upper band edge – hopping off	> 20 dB	> 20 dB	> 20 dB
Upper band edge – hopping on	> 20 dB	> 20 dB	> 20 dB

**Plots:**

**Plot 1:** Lower band edge – hopping on, GFSK modulation

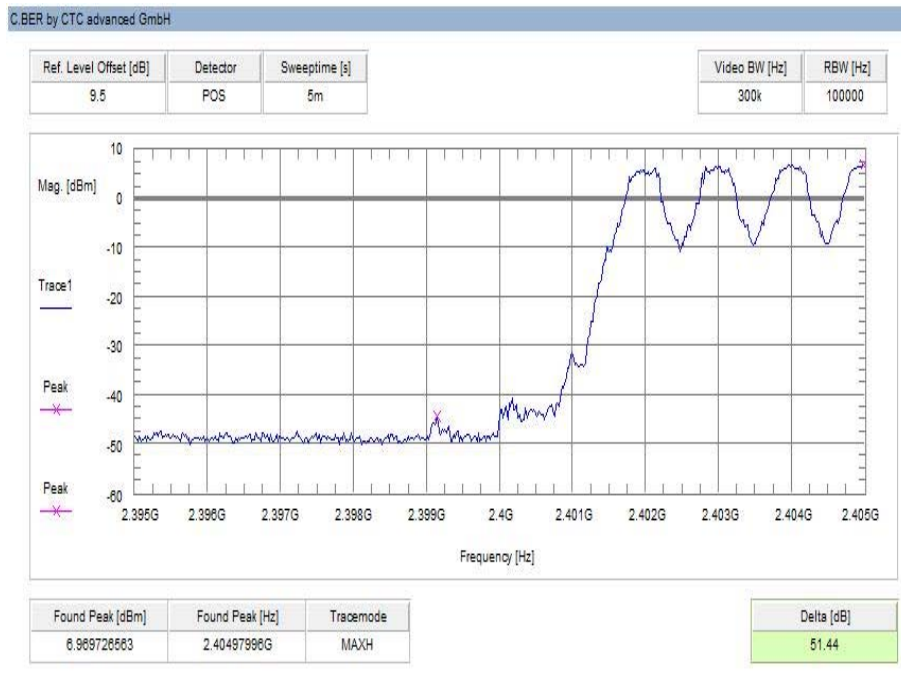

**Plot 2:** Upper band edge – hopping on, GFSK modulation

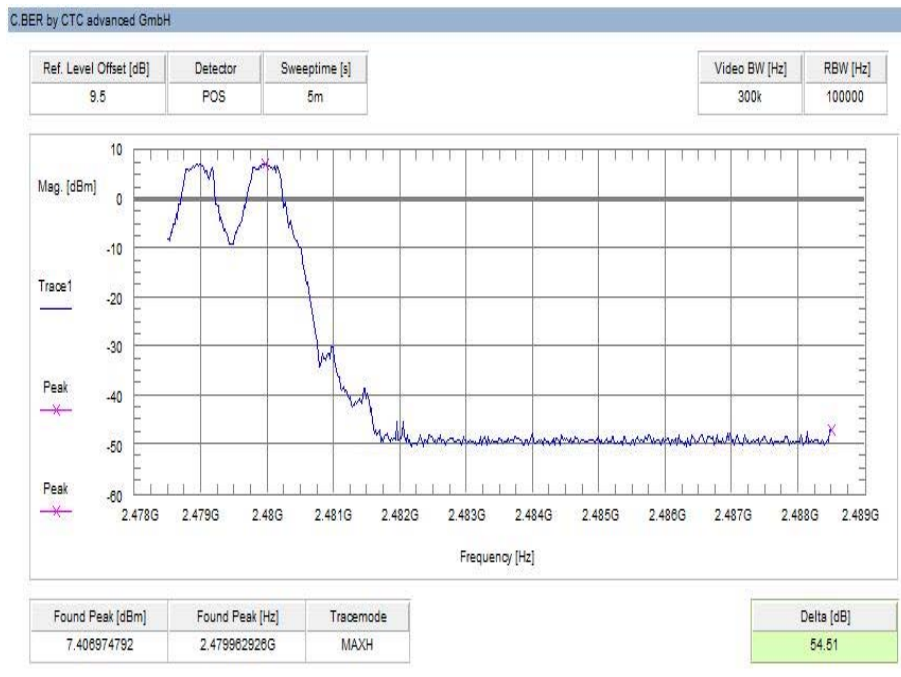

**Plot 3:** Lower band edge – hopping off, GFSK modulation

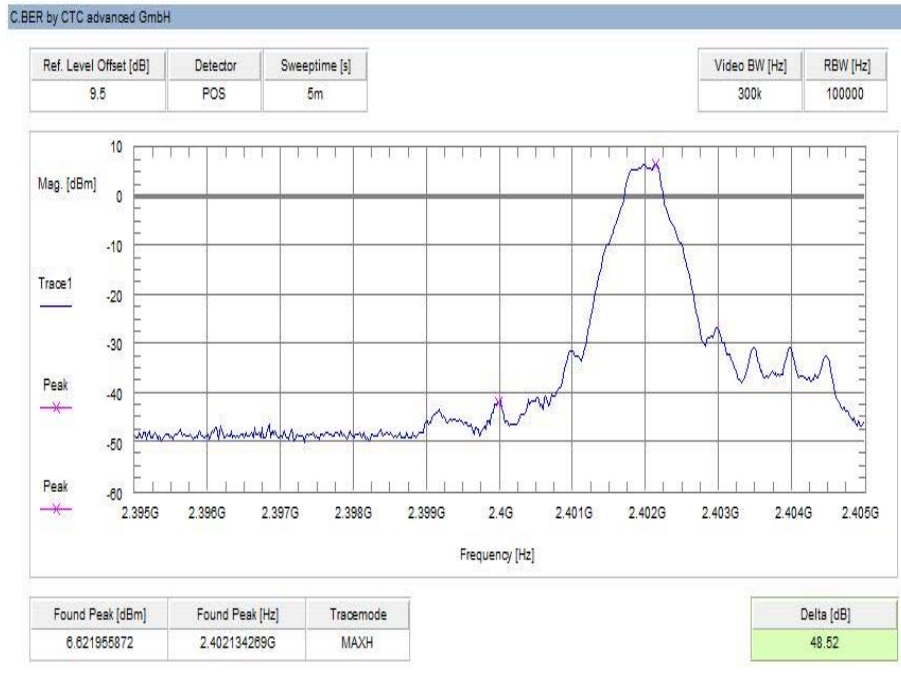

**Plot 4:** Upper band edge – hopping off, GFSK modulation

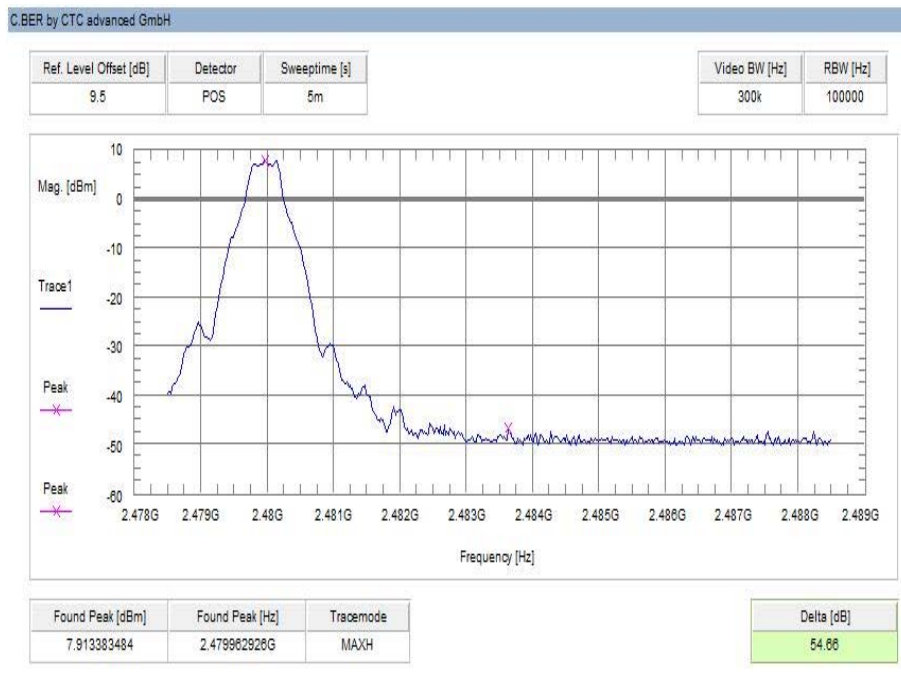

**Plot 5:** Lower band edge – hopping on, Pi/4 DQPSK modulation

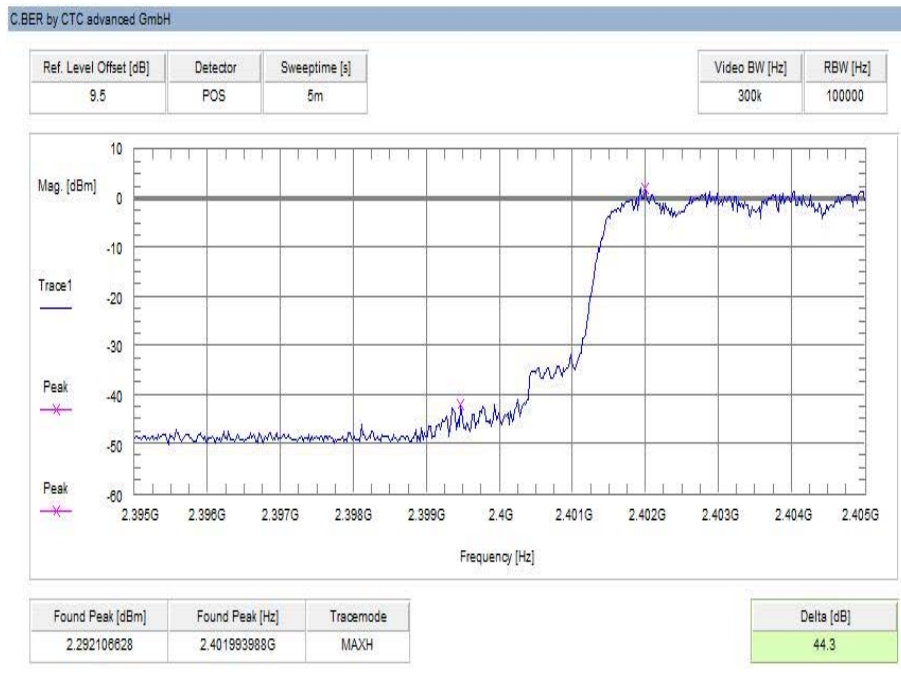

**Plot 6:** Upper band edge – hopping on, Pi/4 DQPSK modulation

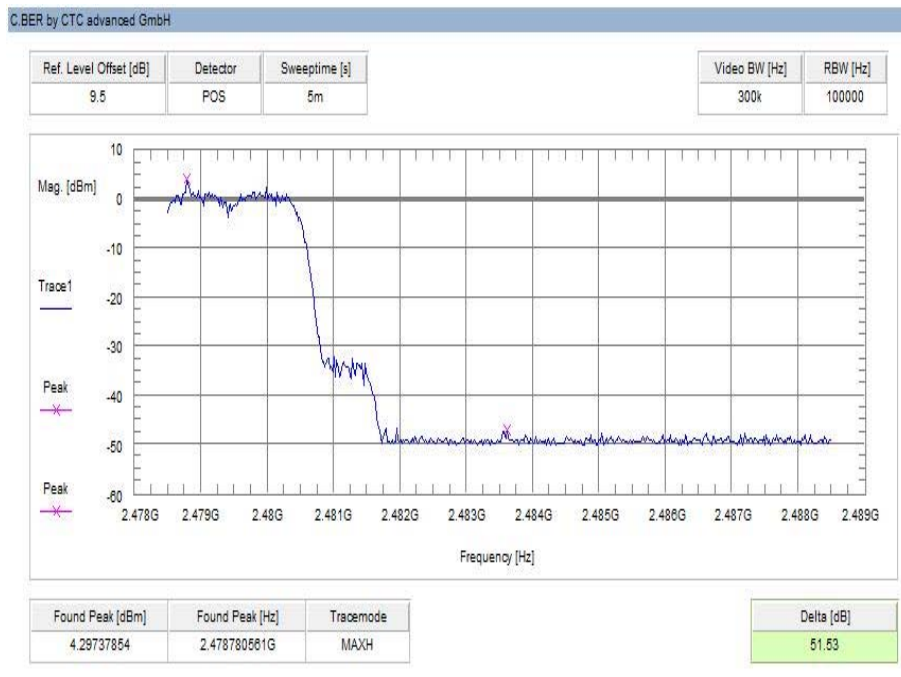



**Plot 7: Lower band edge – hopping off, Pi/4 DQPSK modulation**

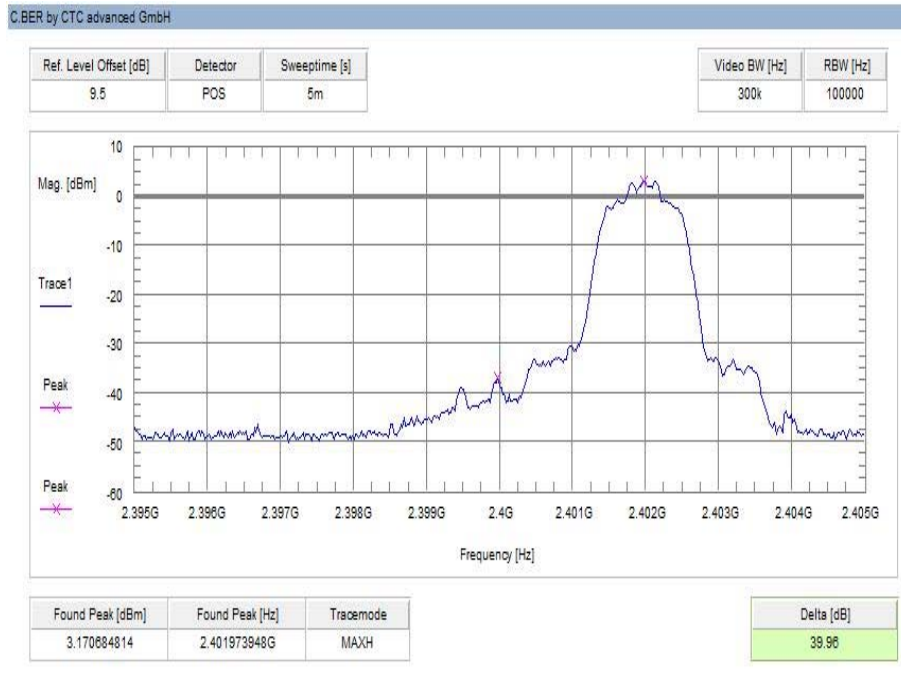

**Plot 8: Upper band edge – hopping off, Pi/4 DQPSK modulation**

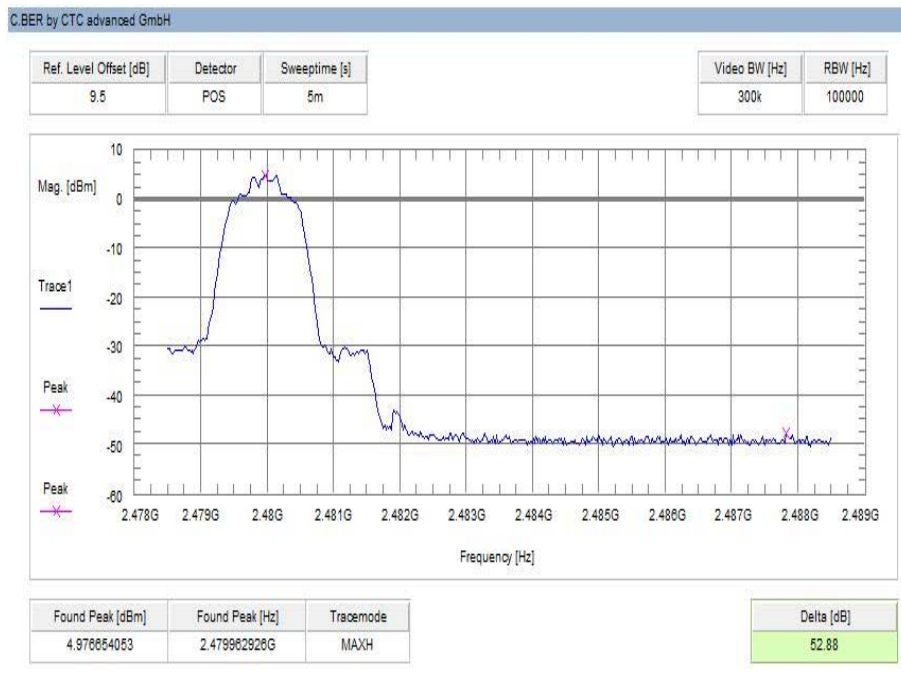

**Plot 9:** Lower band edge – hopping on, 8DPSK modulation

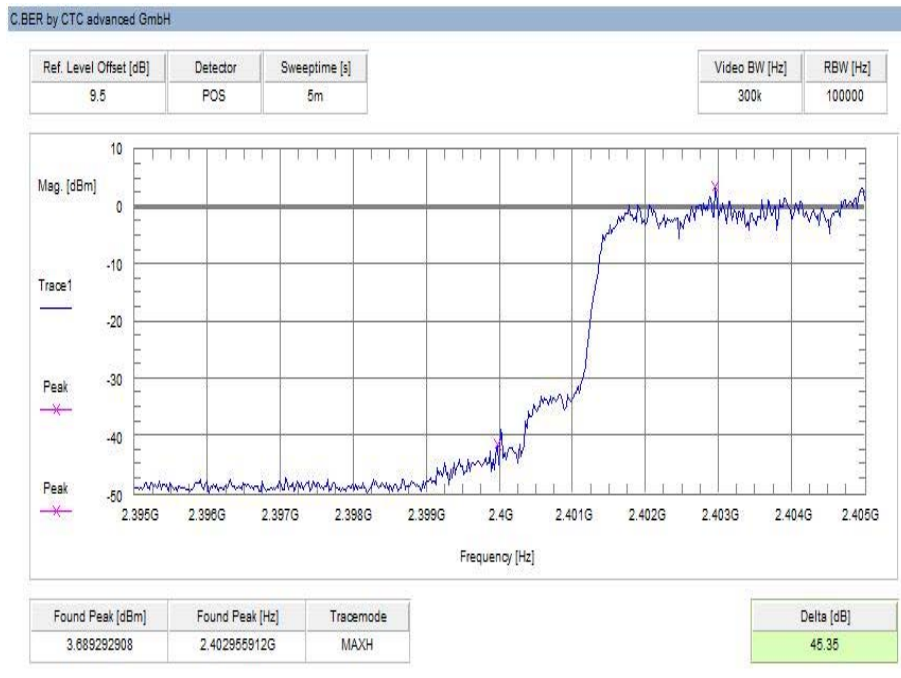

**Plot 10:** Upper band edge – hopping on, 8DPSK modulation

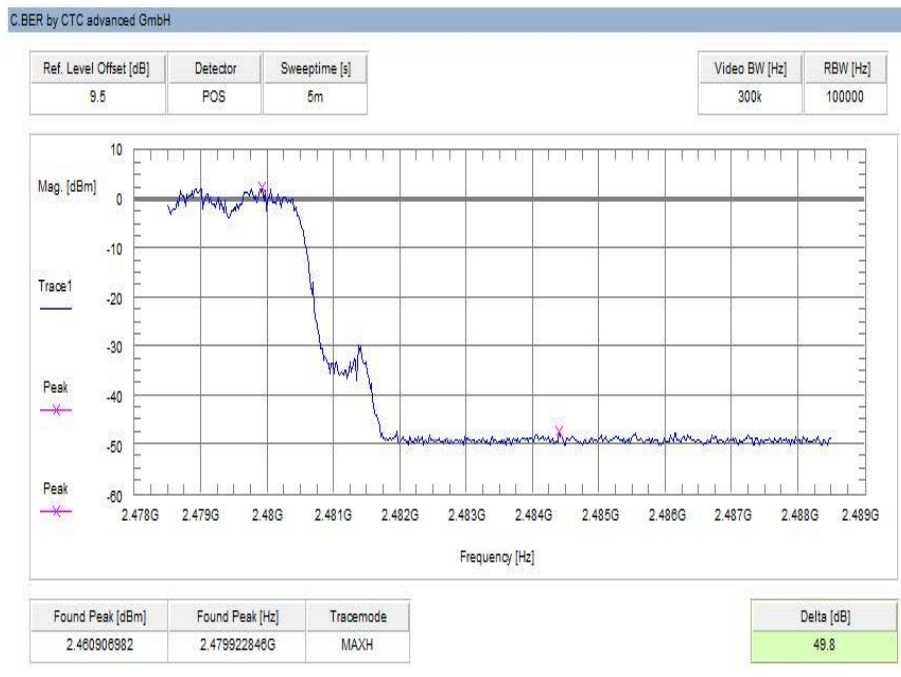

**Plot 11:** Lower band edge – hopping off, 8DPSK modulation

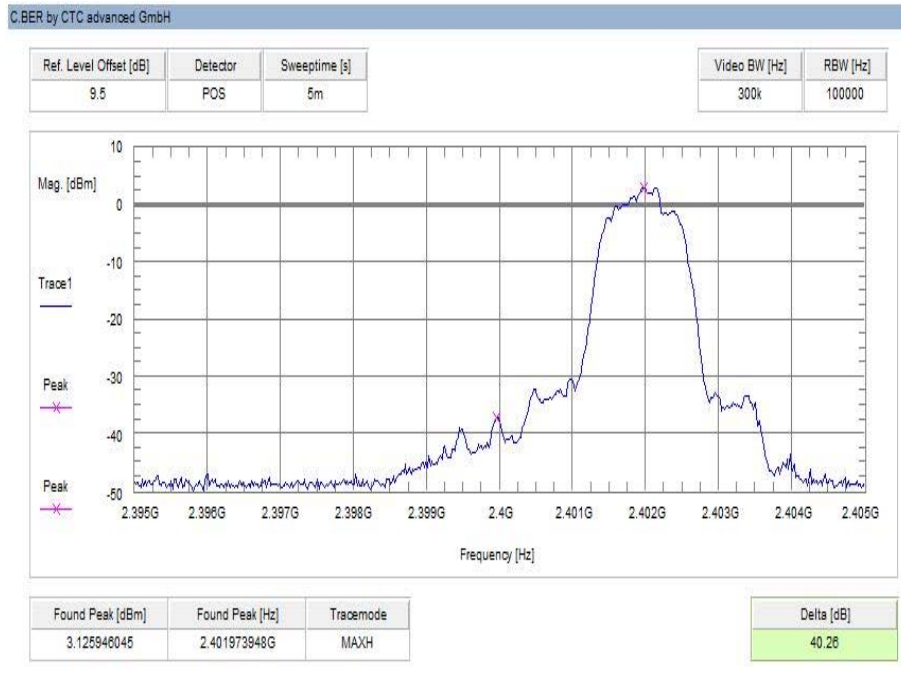

**Plot 12:** Upper band edge – hopping off, 8DPSK modulation

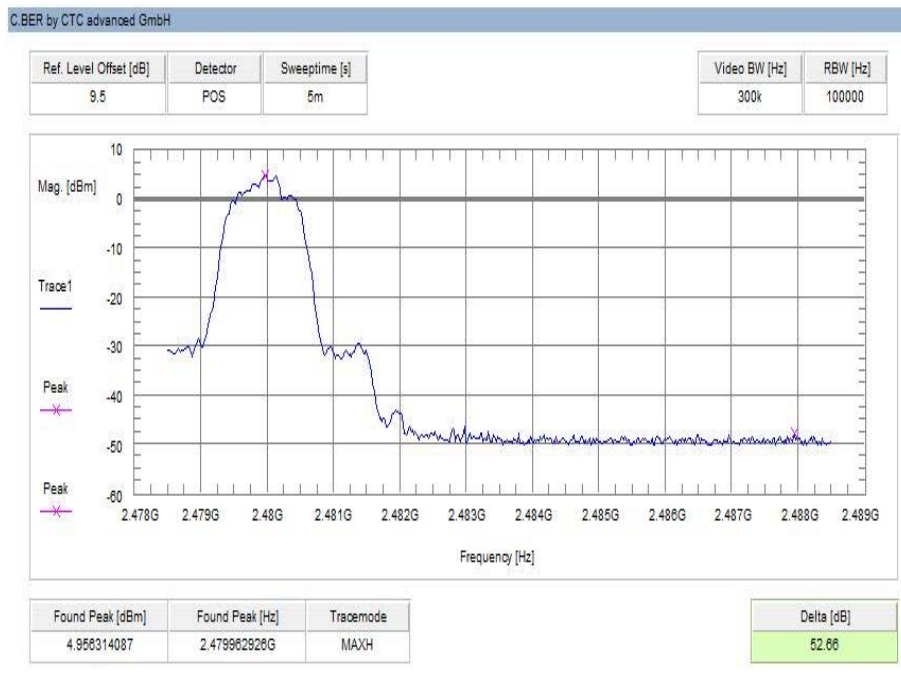

## 11.8 Band edge compliance radiated

### Description:

Measurement of the radiated band edge compliance. The EUT is turned in the position that results in the maximum level at the band edge. Then a sweep over the corresponding restricted band is performed. The EUT is set to single channel mode and the transmit channel is channel 00 for the lower restricted band and channel 78 for the upper restricted band. The measurement is repeated for all modulations. Measurement distance is 3m.

Measurement parameters	
Detector	Peak / RMS
Sweep time	Auto
Resolution bandwidth	1 MHz
Video bandwidth	3 MHz
Span	Lower Band: 2370 – 2400 MHz Upper Band: 2480 – 2500 MHz
Trace mode	Max hold
Test setup	See sub clause 6.2 B
Measurement uncertainty	See sub clause 8

### Limits:

FCC	IC
Band edge compliance radiated	
<p>In any 100 kHz bandwidth outside the frequency band in which the spread spectrum or digitally modulated intentional radiator is operating, the radio frequency power that is produced by the intentional radiator shall be at least 20 dB below that in the 100 kHz bandwidth within the band that contains the highest level of the desired power, based on either an RF conducted or a radiated measurement. Attenuation below the general limits specified in Section 15.209(a) is not required. In addition, radiated emissions which fall in the restricted bands, as defined in Section 15.205(a), must also comply with the radiated emission limits specified in Section 15.209(a) (see Section 5.205(c)).</p>	
54 dBµV/m AVG 74 dBµV/m Peak	

### Results:

Scenario	Band edge compliance radiated [dBµV/m]		
	GFSK	Pi/4 DQPSK	8DPSK
Modulation			
Lower restricted band	< 54 AVG / < 74 PP	< 54 AVG / < 74 PP	< 54 AVG / < 74 PP
Upper restricted band	< 54 AVG / < 74 PP	< 54 AVG / < 74 PP	< 54 AVG / < 74 PP

**Plots:**

**Plot 1:** Lower band edge, GFSK modulation, vertical & horizontal polarization

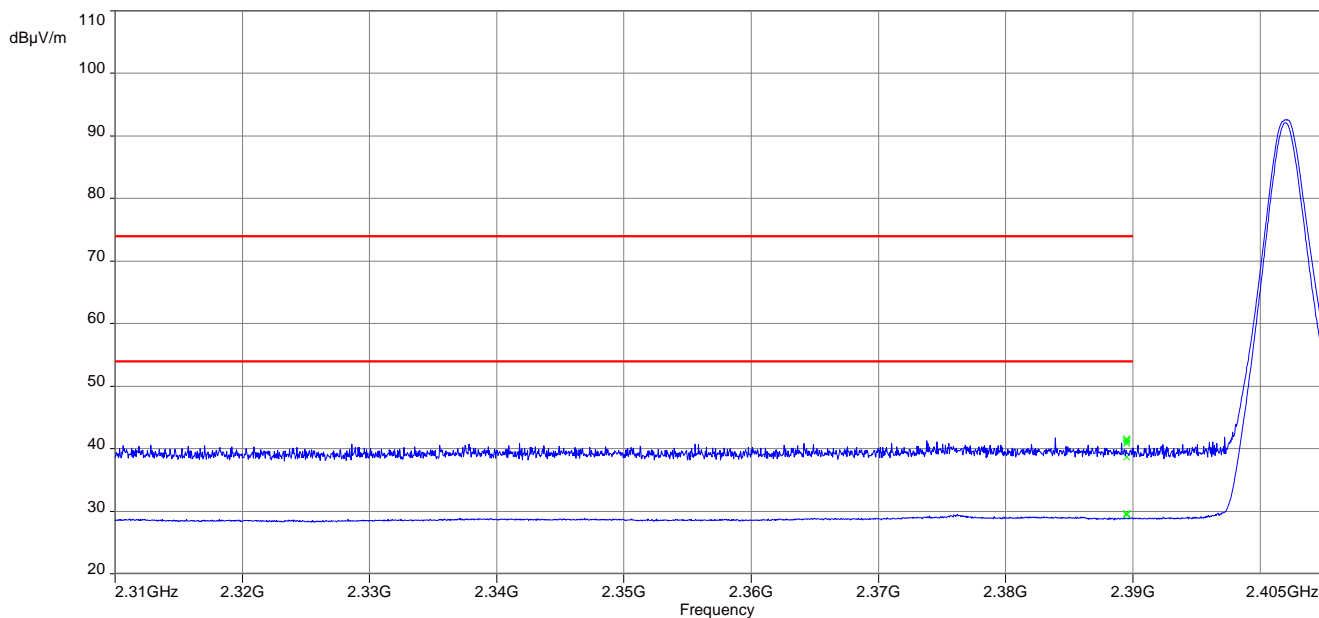

**Plot 2:** Upper band edge, GFSK modulation, vertical & horizontal polarization

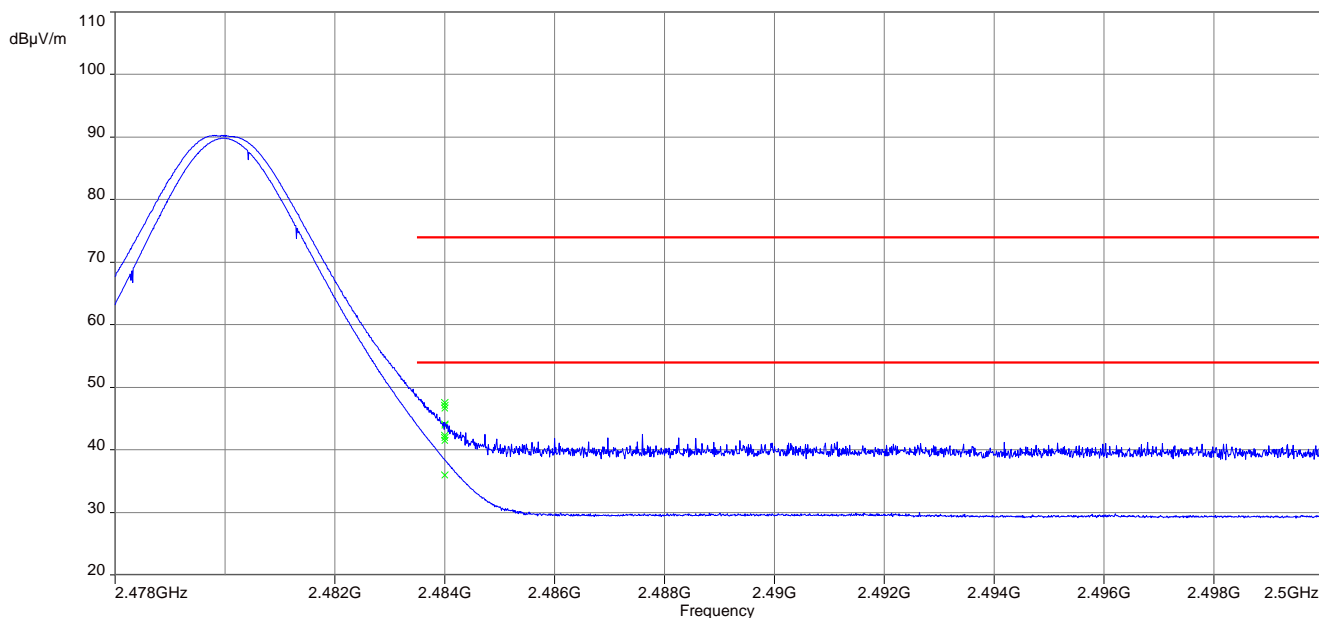

**Plot 3:** Lower band edge, Pi/4 DQPSK modulation, vertical & horizontal polarization

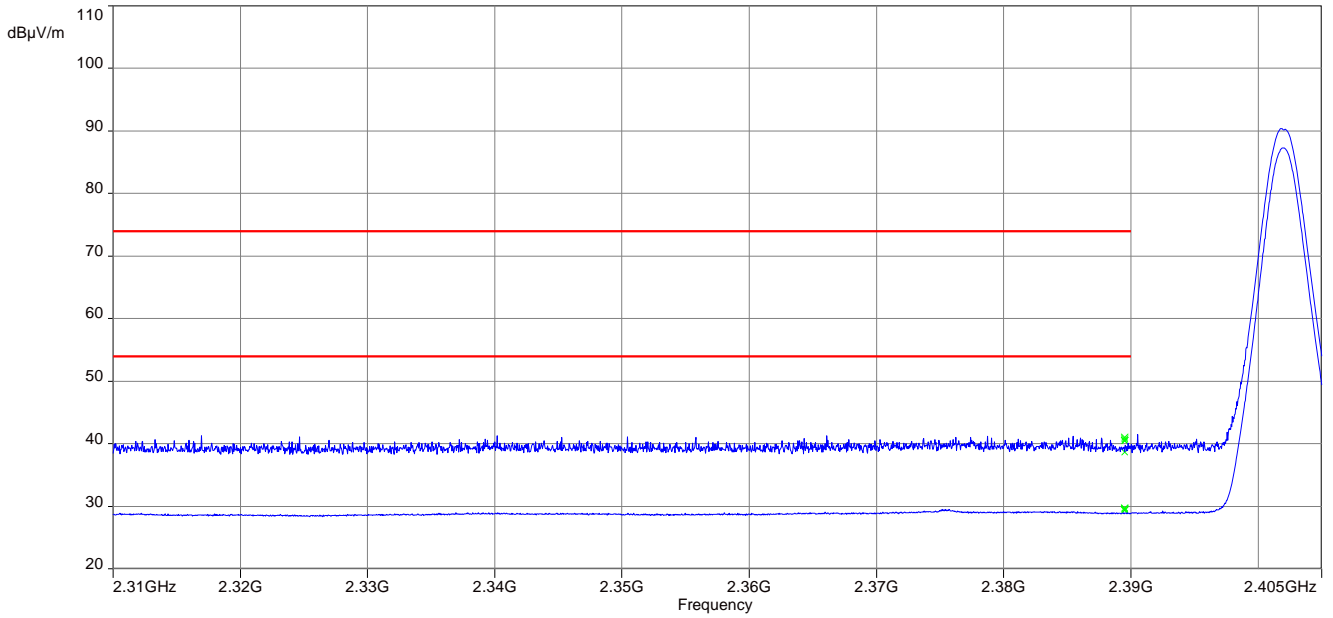

**Plot 4:** Upper band edge, Pi/4 DQPSK modulation, vertical & horizontal polarization

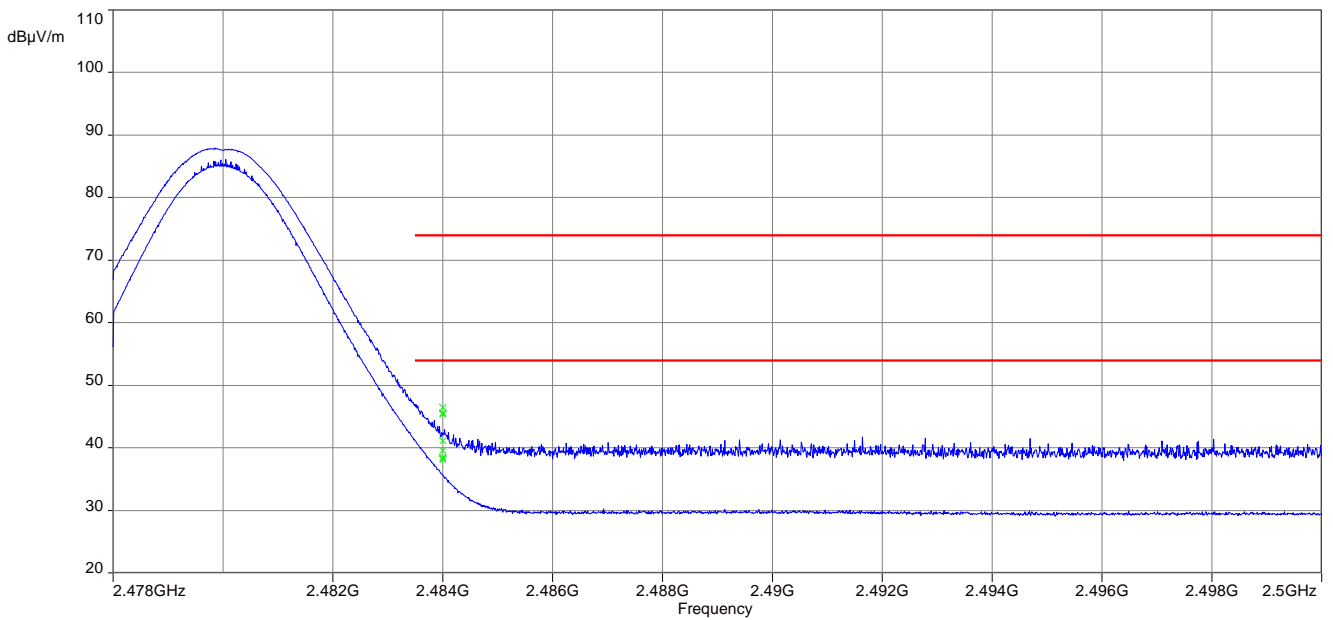

**Plot 5:** Lower band edge, 8 DPSK modulation, vertical & horizontal polarization

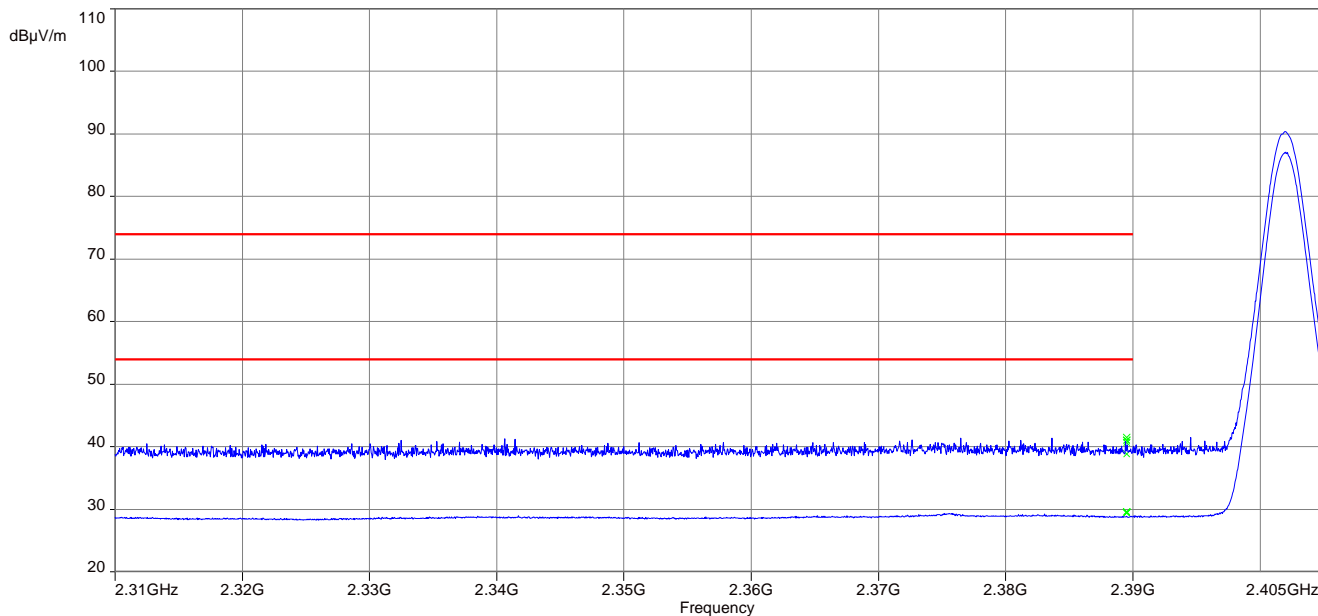

**Plot 6:** Upper band edge, 8 DPSK modulation, vertical & horizontal polarization

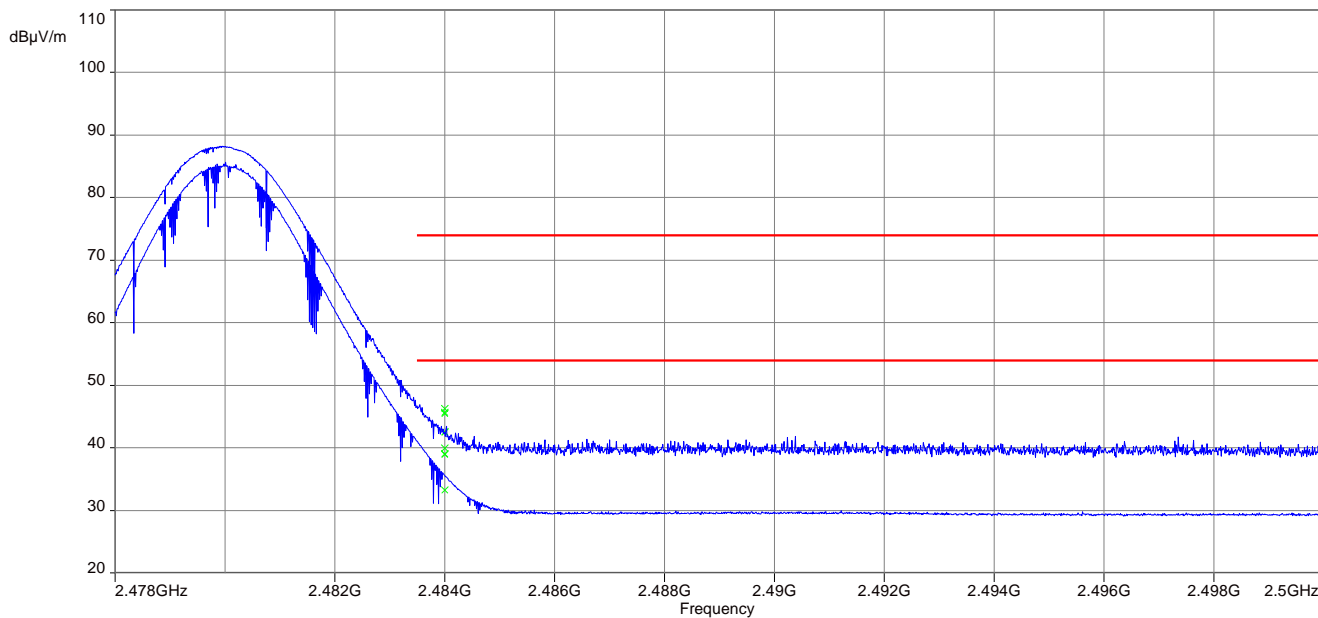

## 11.9 Spurious emissions conducted

### Description:

Measurement of the conducted spurious emissions in transmit mode. The EUT is set to single channel mode and the transmit channel is channel 00, channel 39 and channel 78. The measurement is repeated for all modulations.

Measurement parameters	
Detector	Peak
Sweep time	Auto
Resolution bandwidth	100 kHz
Video bandwidth	300 kHz
Span	9 kHz to 25 GHz
Trace mode	Max hold
Test setup	See sub clause 6.4 A
Measurement uncertainty	See sub clause 8

### Limits:

FCC	IC
TX spurious emissions conducted	
<p>In any 100 kHz bandwidth outside the frequency band in which the spread spectrum or digitally modulated intentional radiator is operating, the radio frequency power that is produced by the intentional radiator shall be at least 20 dB below that in the 100 kHz bandwidth within the band that contains the highest level of the desired power, based on either an RF conducted or a radiated measurement. Attenuation below the general limits specified in Section 15.209(a) is not required</p>	



**Results:**

TX spurious emissions conducted					
GFSK - mode					
f [MHz]		amplitude of emission [dBm]	limit max. allowed emission power	actual attenuation below frequency of operation [dB]	results
2402		6.5	30 dBm		Operating frequency
All detected emissions are below the -20 dBc criteria. Please take a look at the plot!			-20 dBc		compliant
2441		7.4	30 dBm		Operating frequency
All detected emissions are below the -20 dBc criteria. Please take a look at the plot!			-20 dBc		compliant
2480		7.8	30 dBm		Operating frequency
All detected emissions are below the -20 dBc criteria. Please take a look at the plot!			-20 dBc		compliant

**Results:**

TX spurious emissions conducted					
Pi/4-DQPSK - mode					
f [MHz]		amplitude of emission [dBm]	limit max. allowed emission power	actual attenuation below frequency of operation [dB]	results
2402		3.0	30 dBm		Operating frequency
All detected emissions are below the -20 dBc criteria. Please take a look at the plot!			-20 dBc		compliant
2441		4.7	30 dBm		Operating frequency
All detected emissions are below the -20 dBc criteria. Please take a look at the plot!			-20 dBc		compliant
2480		4.7	30 dBm		Operating frequency
All detected emissions are below the -20 dBc criteria. Please take a look at the plot!			-20 dBc		compliant

**Results:**

TX spurious emissions conducted					
8DPSK - mode					
f [MHz]		amplitude of emission [dBm]	limit max. allowed emission power	actual attenuation below frequency of operation [dB]	results
2402		3.0	30 dBm		Operating frequency
All detected emissions are below the -20 dBc criteria. Please take a look at the plot!			-20 dBc		compliant
2441		4.6	30 dBm		Operating frequency
All detected emissions are below the -20 dBc criteria. Please take a look at the plot!			-20 dBc		compliant
2480		4.7	30 dBm		Operating frequency
All detected emissions are below the -20 dBc criteria. Please take a look at the plot!			-20 dBc		compliant

**Plots:**

**Plot 1: lowest channel – 2402 MHz, GFSK modulation**

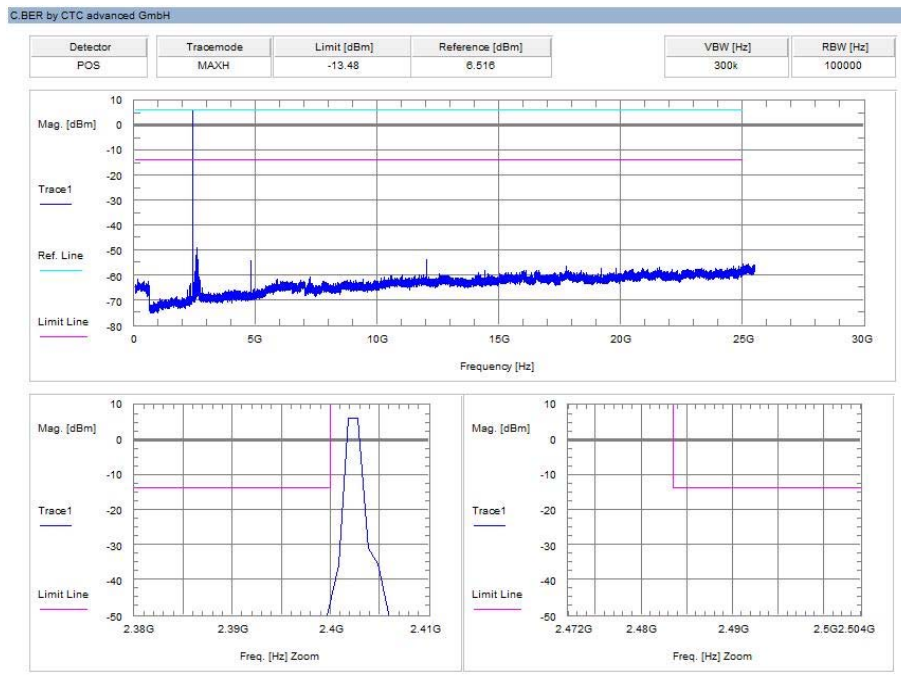

**Plot 2: middle channel – 2441 MHz, GFSK modulation**

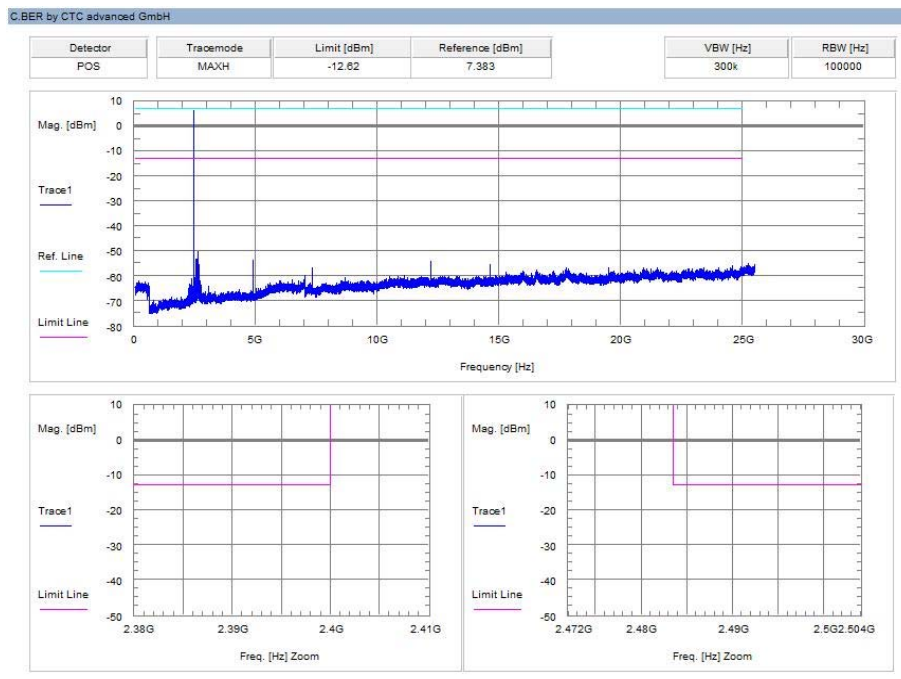

**Plot 3: highest channel – 2480 MHz, GFSK modulation**

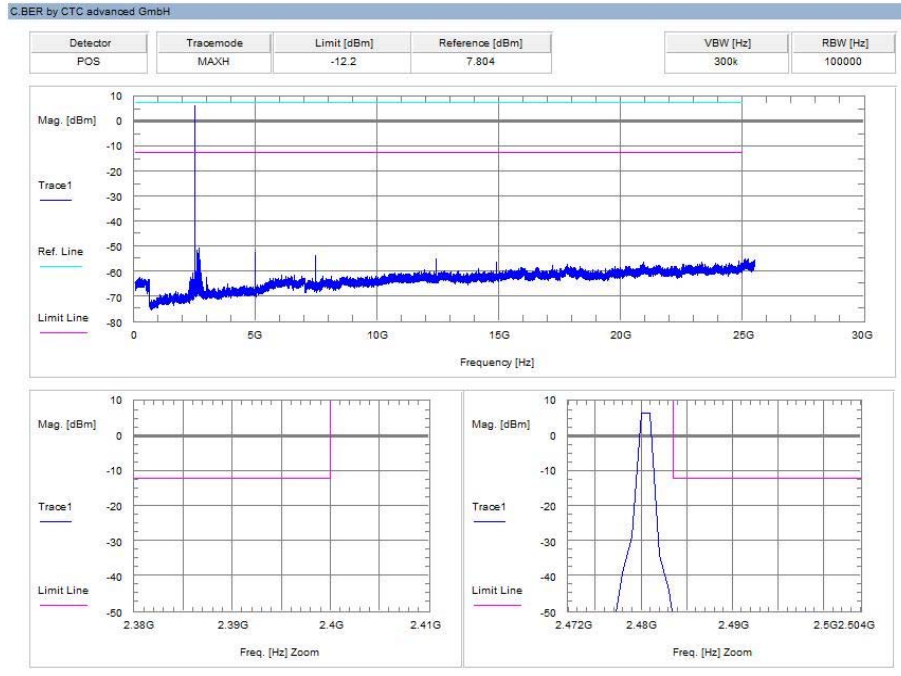

**Plot 4: lowest channel – 2402 MHz, Pi / DQPSK modulation**

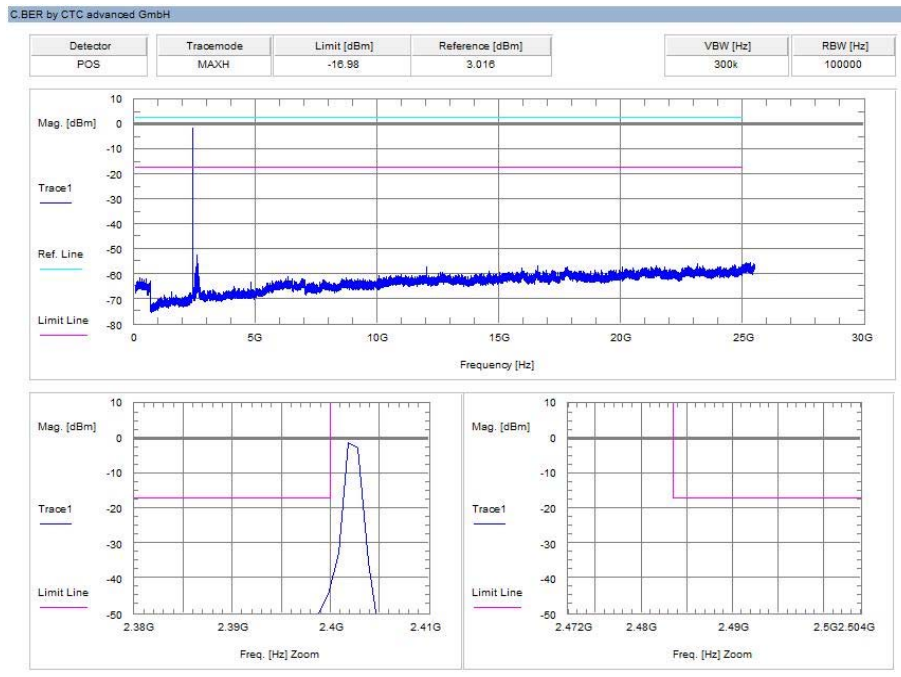

**Plot 5:** middle channel – 2441 MHz, Pi / DQPSK modulation

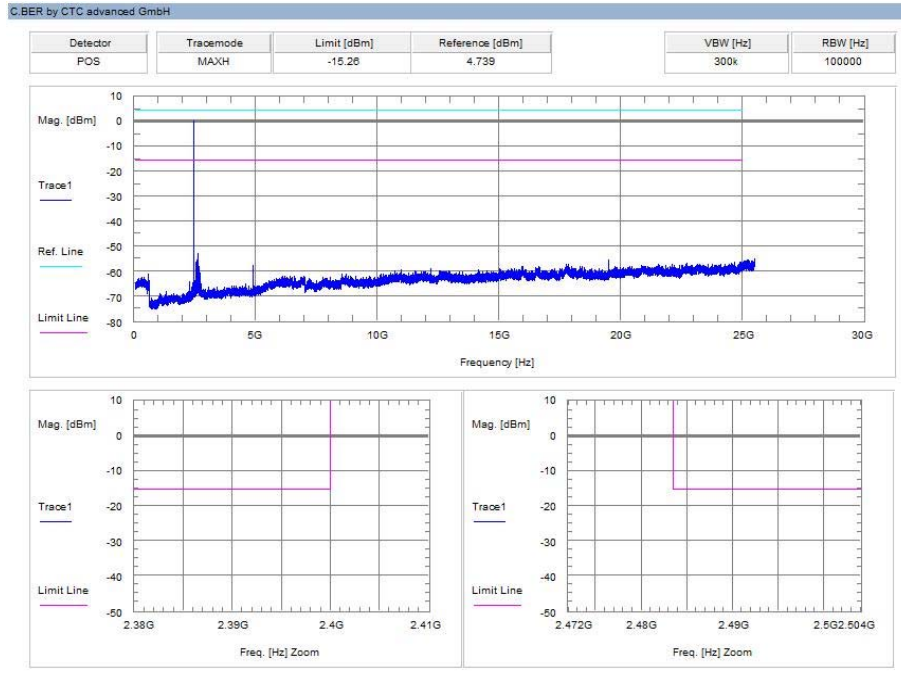

**Plot 6:** highest channel – 2480 MHz, Pi / DQPSK modulation

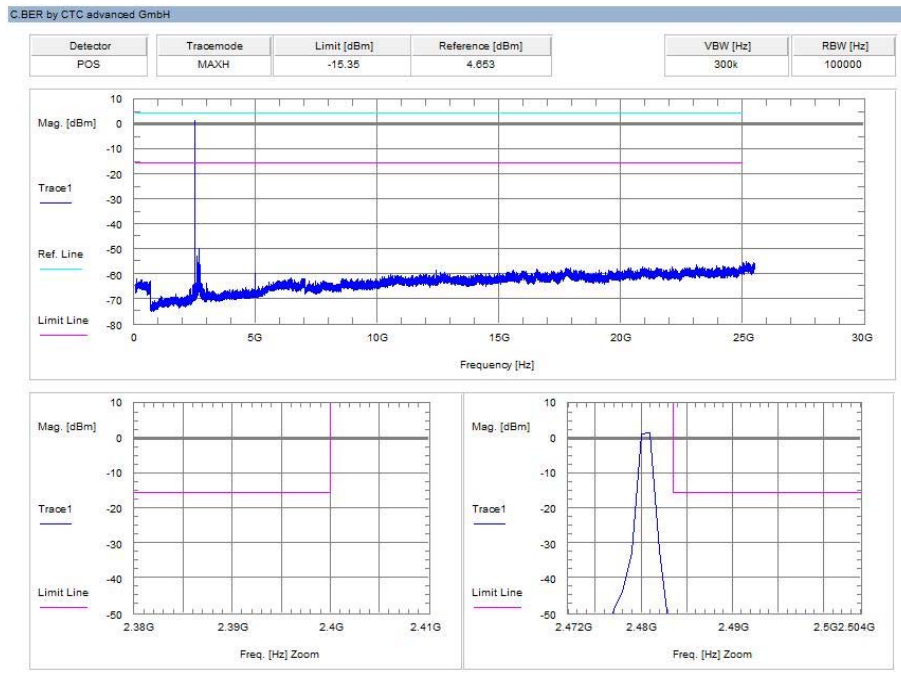

**Plot 7:** lowest channel – 2402 MHz, 8 DPSK modulation

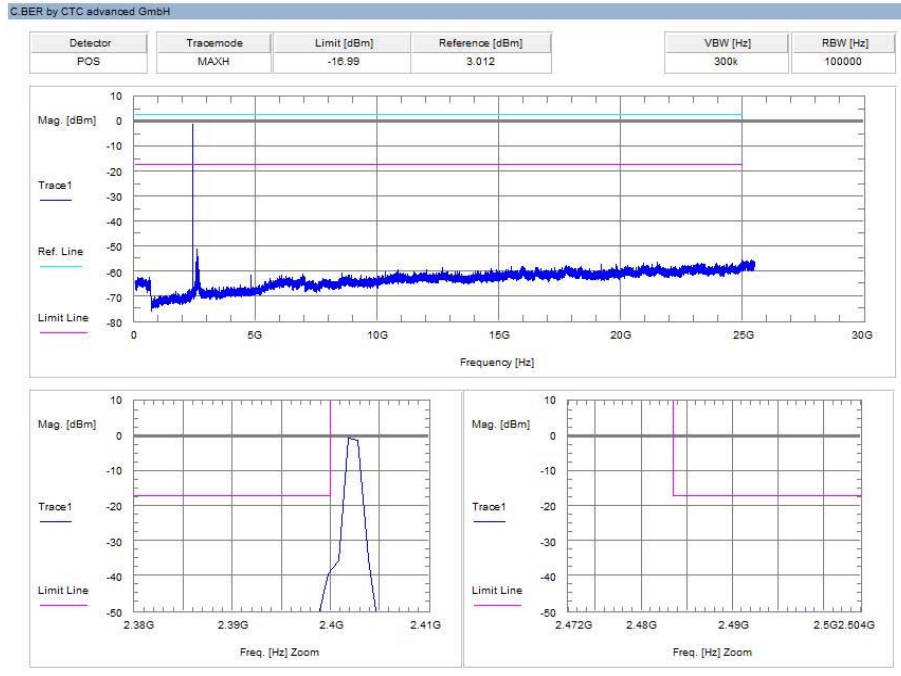

**Plot 8:** middle channel – 2441 MHz, 8 DPSK modulation

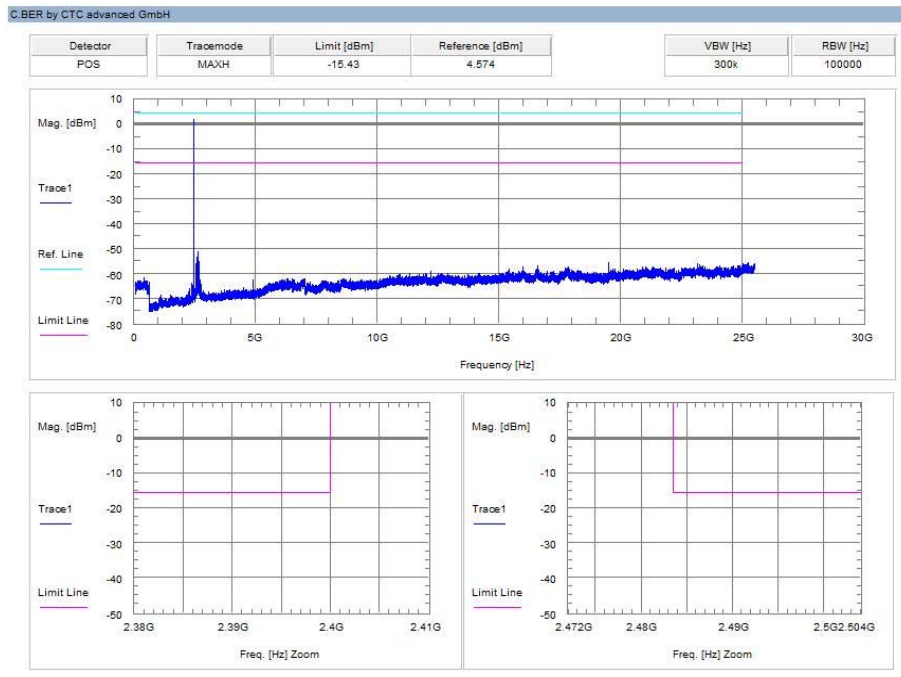

**Plot 9:** highest channel – 2480 MHz, 8 DPSK modulation

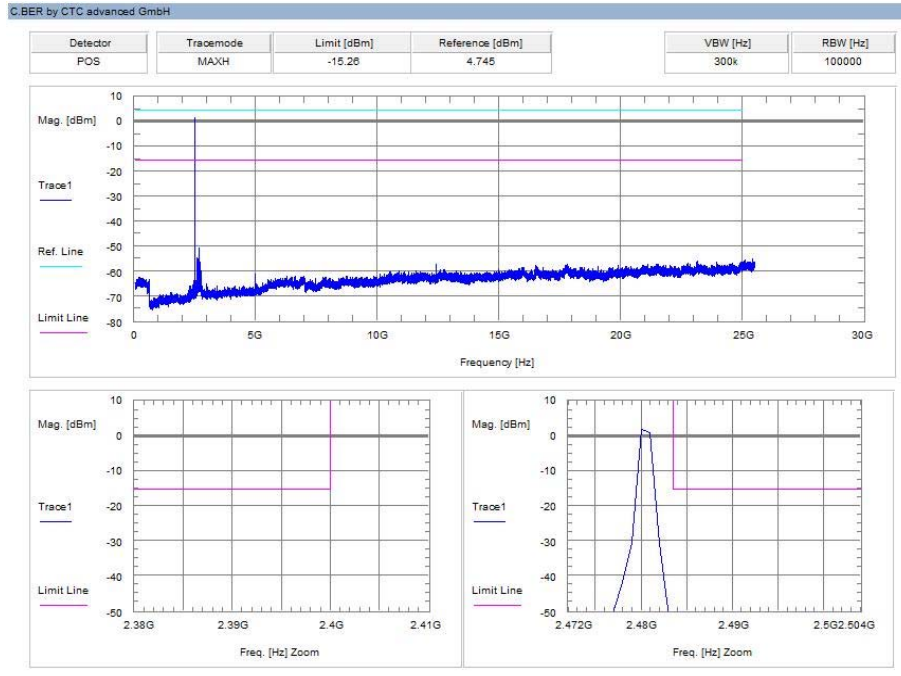

### 11.10 Spurious emissions radiated below 30 MHz

**Description:**

Measurement of the radiated spurious emissions in transmit mode below 30 MHz. The EUT is set to single channel mode and the transmit channels are 00; 39 and 78. The measurement is performed in the mode with the highest output power. The limits are recalculated to a measurement distance of 3 m according the ANSI C63.10.

Measurement parameters	
Detector	Peak / Quasi peak
Sweep time	Auto
Resolution bandwidth	F < 150 kHz: 200 Hz F > 150 kHz: 9 kHz
Video bandwidth	F < 150 kHz: 1 kHz F > 150 kHz: 100 kHz
Span	9 kHz to 30 MHz
Trace mode	Max hold
Test setup	See sub clause 6.2 C
Measurement uncertainty	See sub clause 8

**Limits:**

FCC		IC
TX spurious emissions radiated below 30 MHz		
Frequency (MHz)	Field strength (dBµV/m)	Measurement distance
0.009 – 0.490	2400/F(kHz)	300
0.490 – 1.705	24000/F(kHz)	30
1.705 – 30.0	30	30

**Results:**

TX spurious emissions radiated below 30 MHz [dBµV/m]		
F [MHz]	Detector	Level [dBµV/m]
All detected emissions are more than 20 dB below the limit.		



**Plots:**

**Plot 1:** 9 kHz to 30 MHz, channel 00, transmit mode

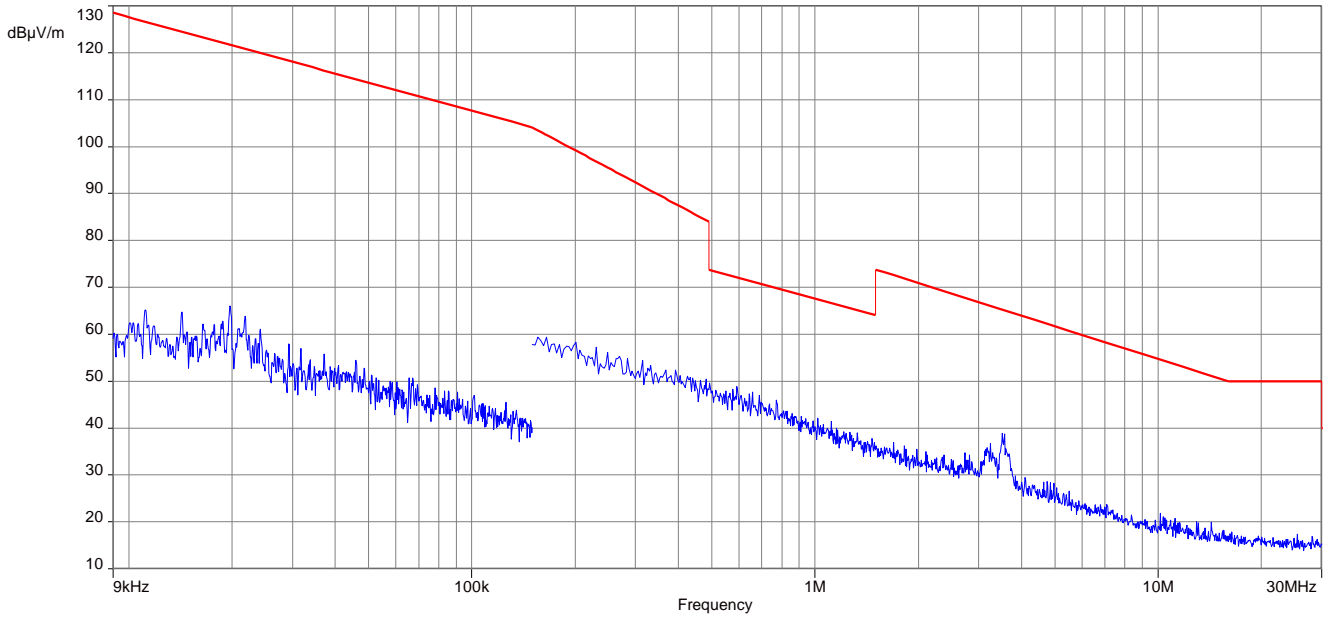

**Plot 2:** 9 kHz to 30 MHz, channel 39, transmit mode

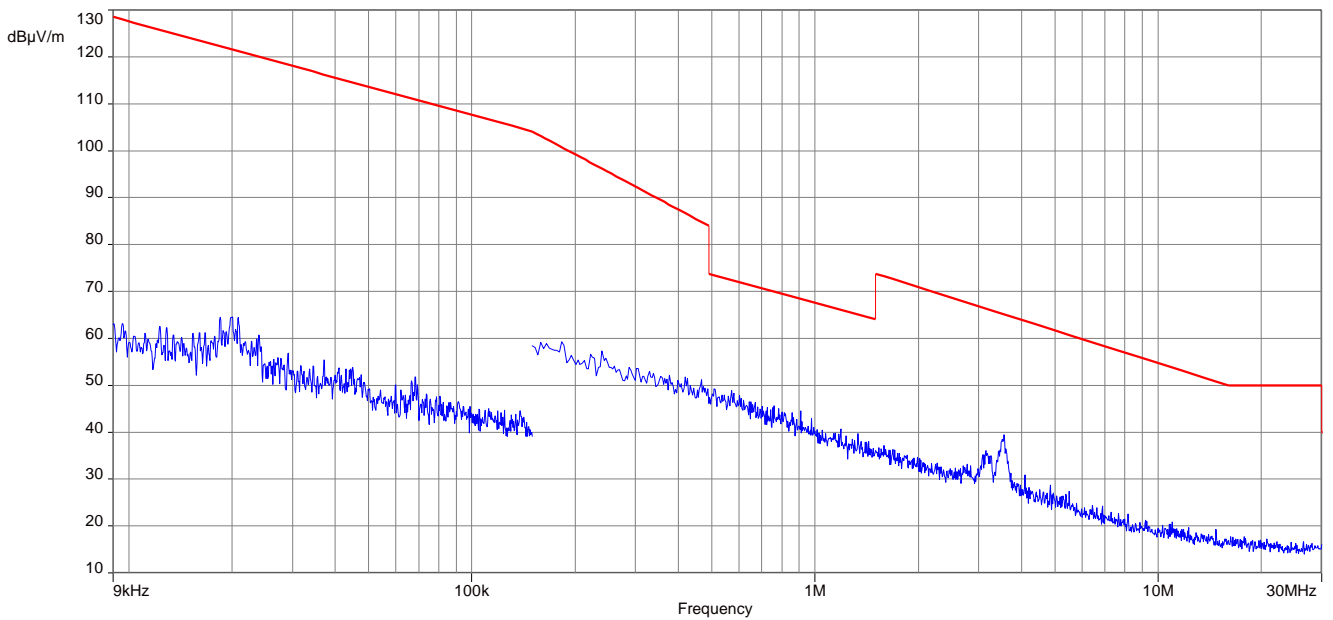

**Plot 3:** 9 kHz to 30 MHz, channel 78, transmit mode

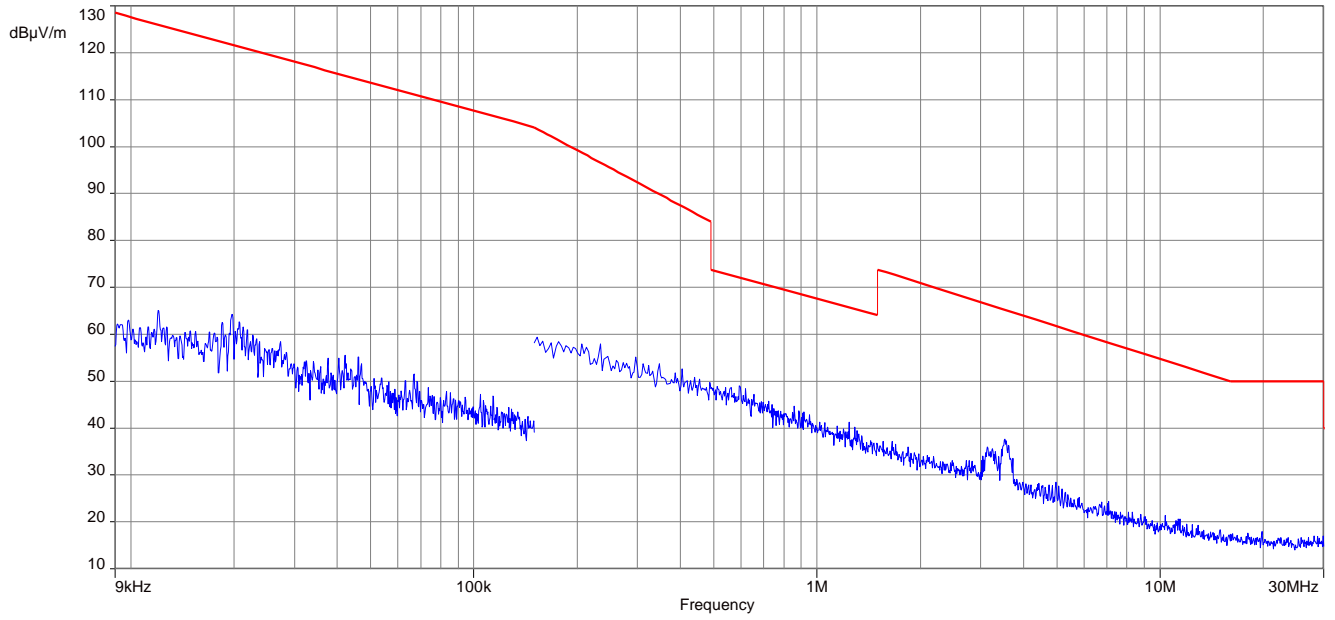

### 11.11 Spurious emissions radiated 30 MHz to 1 GHz

**Description:**

Measurement of the radiated spurious emissions in transmit mode. The EUT is set to single channel mode and the transmit channel is channel 00, channel 39 and channel 78. The measurement is performed in the mode with the highest output power.

Measurement parameters	
Detector	Peak / Quasi Peak
Sweep time	Auto
Resolution bandwidth	120 kHz
Video bandwidth	3 x RBW
Span	30 MHz to 1 GHz
Trace mode	Max hold
Measured modulation	<input checked="" type="checkbox"/> GFSK <input type="checkbox"/> Pi/4 DQPSK <input type="checkbox"/> 8DPSK
Test setup	See sub clause 6.1 A
Measurement uncertainty	See sub clause 8

The modulation with the highest output power was used to perform the transmitter spurious emissions. If spurious were detected a re-measurement was performed on the detected frequency with each modulation.

**Limits:**

FCC		IC	
TX spurious emissions radiated			
In any 100 kHz bandwidth outside the frequency band in which the spread spectrum or digitally modulated intentional radiator is operating, the radio frequency power that is produced by the intentional radiator shall be at least 20 dB below that in the 100 kHz bandwidth within the band that contains the highest level of the desired power, based on either an RF conducted or a radiated measurement. Attenuation below the general limits specified in Section 15.209(a) is not required. In addition, radiated emissions which fall in the restricted bands, as defined in §15.205(a), must also comply with the radiated emission limits specified in §15.209(a) (see §15.205(c)).			
§15.209			
Frequency (MHz)	Field strength (dBµV/m)	Measurement distance	
30 - 88	30.0	10	
88 – 216	33.5	10	
216 – 960	36.0	10	
Above 960	54.0	3	

**Plots:** Transmit mode

**Plot 1:** 30 MHz to 1 GHz, TX mode, channel 00, vertical & horizontal polarization

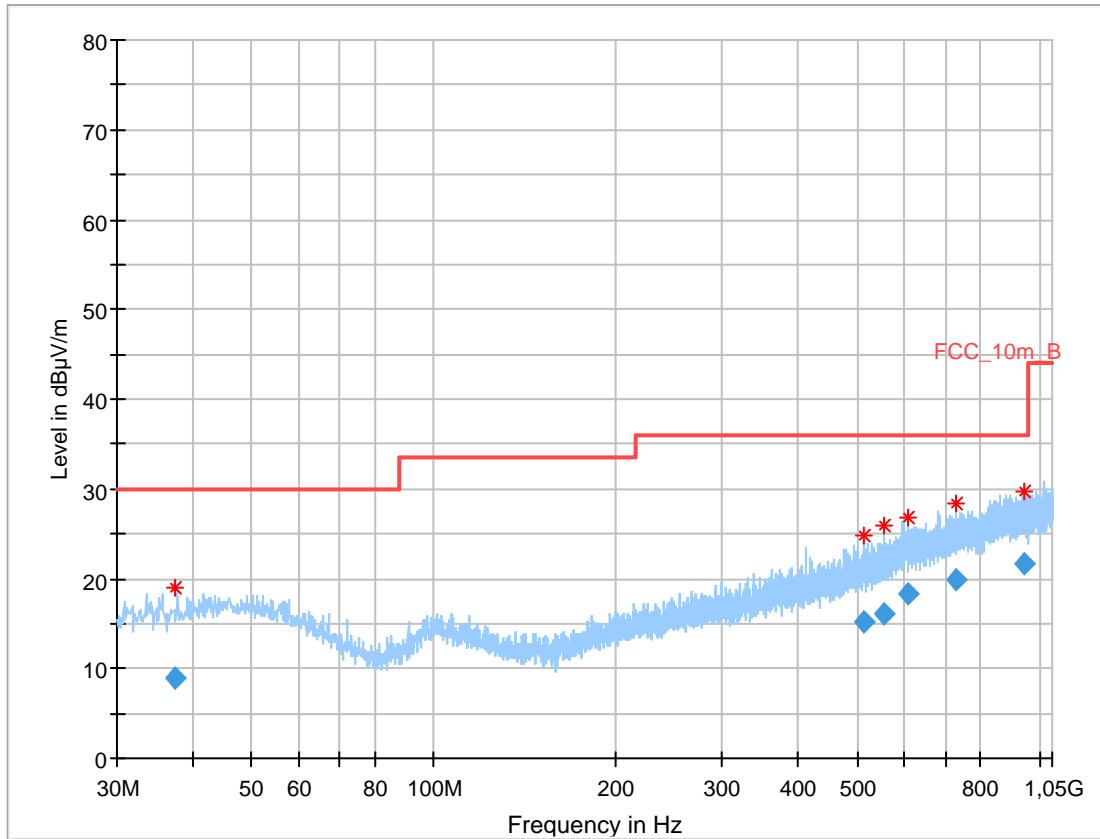

**Final results:**

Frequency (MHz)	QuasiPeak (dBµV/m)	Limit (dBµV/m)	Margin (dB)	Meas. Time (ms)	Bandwidth (kHz)	Height (cm)	Pol	Azimuth (deg)	Corr. (dB)
37.541	9.05	30.0	20.95	1000	120	170.0	V	270.0	12.9
514.446	15.28	36.0	20.72	1000	120	101.0	V	90.0	18.9
552.383	16.04	36.0	19.96	1000	120	101.0	V	90.0	19.4
605.685	18.24	36.0	17.76	1000	120	170.0	V	0.0	20.8
729.168	19.79	36.0	16.21	1000	120	170.0	V	270.0	22.2
942.796	21.74	36.0	14.26	1000	120	98.0	V	0.0	24.3

**Plot 2:** 30 MHz to 1 GHz, TX mode, channel 39, vertical & horizontal polarization

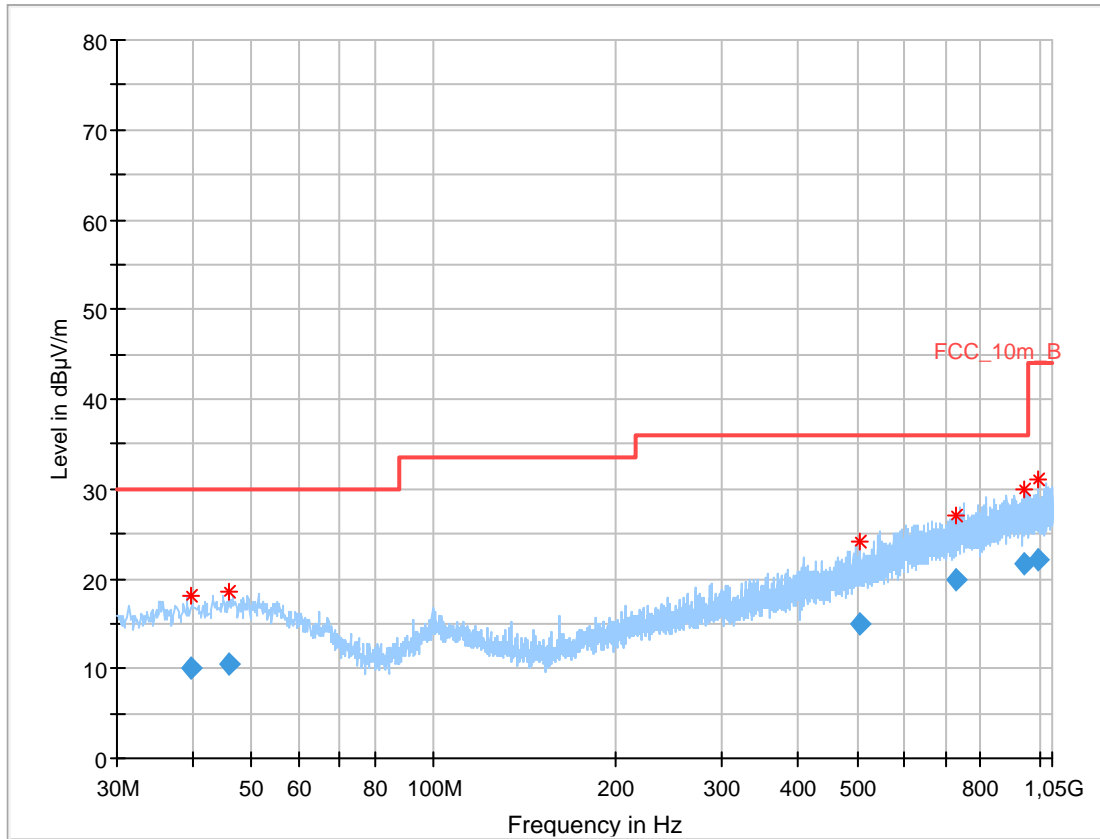

**Final results:**

Frequency (MHz)	QuasiPeak (dBµV/m)	Limit (dBµV/m)	Margin (dB)	Meas. Time (ms)	Bandwidth (kHz)	Height (cm)	Pol	Azimuth (deg)	Corr. (dB)
39.725	10.04	30.0	19.96	1000	120	101.0	V	270.0	13.2
46.063	10.42	30.0	19.58	1000	120	170.0	H	180.0	13.7
504.168	15.00	36.0	21.00	1000	120	98.0	H	90.0	18.8
731.325	19.79	36.0	16.21	1000	120	170.0	H	90.0	22.3
942.109	21.68	36.0	14.32	1000	120	170.0	H	0.0	24.3
995.511	22.23	44.0	21.77	1000	120	170.0	V	270.0	24.8

**Plot 3:** 30 MHz to 1 GHz, TX mode, channel 78, vertical & horizontal polarization

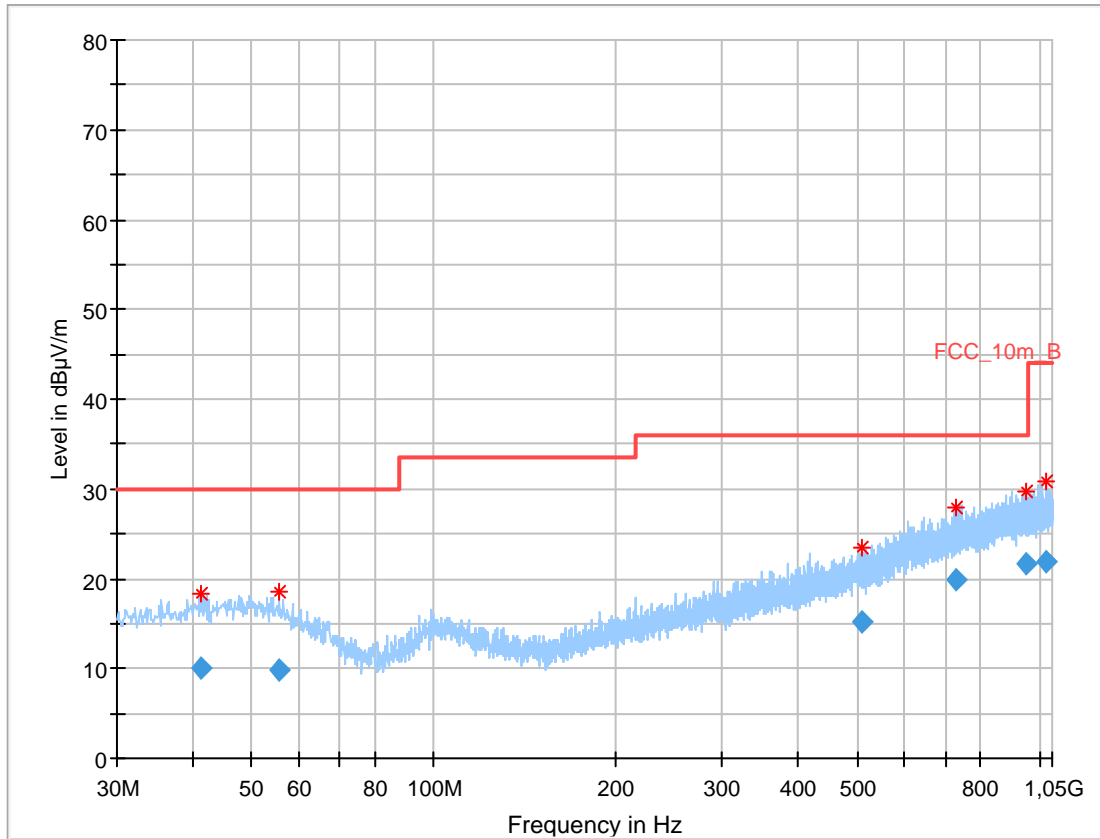

**Final results:**

Frequency (MHz)	QuasiPeak (dBµV/m)	Limit (dBµV/m)	Margin (dB)	Meas. Time (ms)	Bandwidth (kHz)	Height (cm)	Pol	Azimuth (deg)	Corr. (dB)
41.313	10.05	30.0	19.95	1000	120	170.0	V	0.0	13.3
55.451	9.84	30.0	20.16	1000	120	170.0	V	0.0	13.0
510.914	15.28	36.0	20.72	1000	120	98.0	V	180.0	18.8
729.962	19.83	36.0	16.17	1000	120	170.0	H	180.0	22.3
947.539	21.73	36.0	14.27	1000	120	170.0	H	90.0	24.3
1024.327	21.89	44.0	22.11	1000	120	170.0	H	180.0	25.3

**Plots:** Receiver mode

**Plot 1:** 30 MHz to 1 GHz, RX / idle – mode, vertical & horizontal polarization

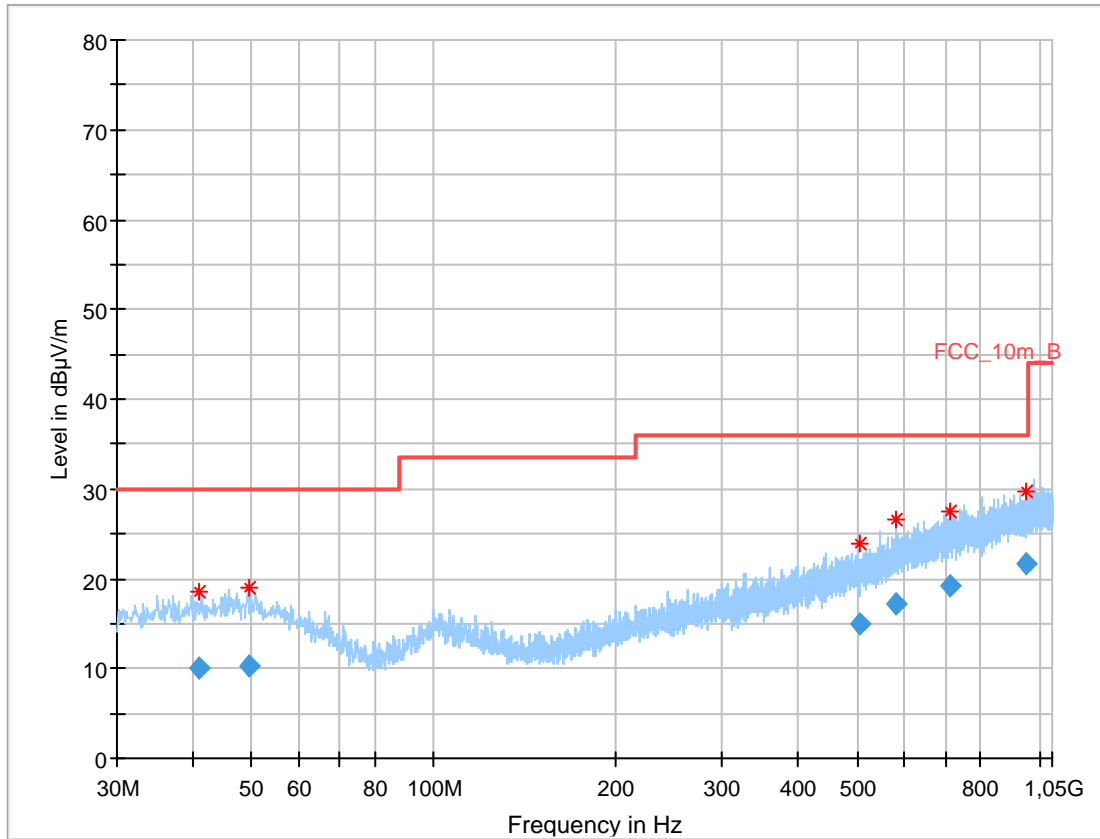

**Final results:**

Frequency (MHz)	QuasiPeak (dBµV/m)	Limit (dBµV/m)	Margin (dB)	Meas. Time (ms)	Bandwidth (kHz)	Height (cm)	Pol	Azimuth (deg)	Corr. (dB)
41.053	10.13	30.0	19.87	1000	120	101.0	H	0.0	13.3
49.583	10.35	30.0	19.65	1000	120	98.0	V	180.0	13.7
503.909	14.97	36.0	21.03	1000	120	170.0	H	270.0	18.8
581.466	17.24	36.0	18.76	1000	120	170.0	V	270.0	20.2
710.290	19.31	36.0	16.69	1000	120	101.0	H	90.0	21.8
949.605	21.73	36.0	14.27	1000	120	170.0	V	270.0	24.3

## 11.12 Spurious emissions radiated above 1 GHz

### Description:

Measurement of the radiated spurious emissions in transmit mode. The EUT is set to single channel mode and the transmit channel is channel 00, channel 39 and channel 78. The measurement is performed in the mode with the highest output power.

Measurement parameters	
Detector	Peak / RMS
Sweep time	Auto
Resolution bandwidth	1 MHz
Video bandwidth	3 x RBW
Span	1 GHz to 26 GHz
Trace mode	Max hold
Measured modulation	<input checked="" type="checkbox"/> GFSK <input type="checkbox"/> Pi/4 DQPSK <input type="checkbox"/> 8DPSK
Test setup	See sub clause 6.2 A (1 GHz - 18 GHz) See sub clause 6.3 A (18 GHz - 26 GHz)
Measurement uncertainty	See sub clause 8

The modulation with the highest output power was used to perform the transmitter spurious emissions. If spurious were detected a re-measurement was performed on the detected frequency with each modulation.

### Limits:

FCC		IC	
TX spurious emissions radiated			
In any 100 kHz bandwidth outside the frequency band in which the spread spectrum or digitally modulated intentional radiator is operating, the radio frequency power that is produced by the intentional radiator shall be at least 20 dB below that in the 100 kHz bandwidth within the band that contains the highest level of the desired power, based on either an RF conducted or a radiated measurement. Attenuation below the general limits specified in Section 15.209(a) is not required. In addition, radiated emissions which fall in the restricted bands, as defined in §15.205(a), must also comply with the radiated emission limits specified in §15.209(a) (see §15.205(c)).			
§15.209			
Frequency (MHz)	Field strength (dBµV/m)	Measurement distance	
Above 960	54.0	3	



**Results:** Transmitter mode

TX spurious emissions radiated [dBµV/m]								
2402 MHz			2441 MHz			2480 MHz		
F [MHz]	Detector	Level [dBµV/m]	F [MHz]	Detector	Level [dBµV/m]	F [MHz]	Detector	Level [dBµV/m]
4804	Peak	56.0	4882	Peak	53.5	4960	Peak	55.4
	AVG	25.9*		AVG	23.4*		AVG	25.3*
-/-	Peak	-/-	-/-	Peak	-/-	7440	Peak	46.6
	AVG	-/-		AVG	-/-		AVG	-/-
-/-	Peak	-/-	-/-	Peak	-/-	12401	Peak	48.3
	AVG	-/-		AVG	-/-		AVG	-/-

\*) Average emission adjusting factor:

$$F = 20 * \log (\text{dwell time} / 100 \text{ ms})$$

The dwell time of the longest possible Bluetooth transmission (DH5-packet) is 3.125 ms.

In a period of 100 ms, we have a maximum of 1 transmission and that implies a correction factor for spurious measurement emissions:

$$F = 20 * \log (1 * 3.125 / 100) = -30.1 \text{ dB}$$

**Results:** Receiver mode

RX spurious emissions radiated [dBµV/m]		
F [MHz]	Detector	Level [dBµV/m]
All detected emissions are more than 20 dB below the limit.		
-/-	Peak	-/-
	AVG	-/-

**Note:** The limit was recalculated with 20 dB / decade (Part 15.31) for all radiated spurious emissions 30 MHz to 1 GHz from 3 meter limit to a 10 meter distance. (40dB/decade for emissions < 30MHz)

**Plots:** Transmitter mode

**Plot 1:** 1 GHz to 18 GHz, TX mode, channel 00, vertical & horizontal polarization

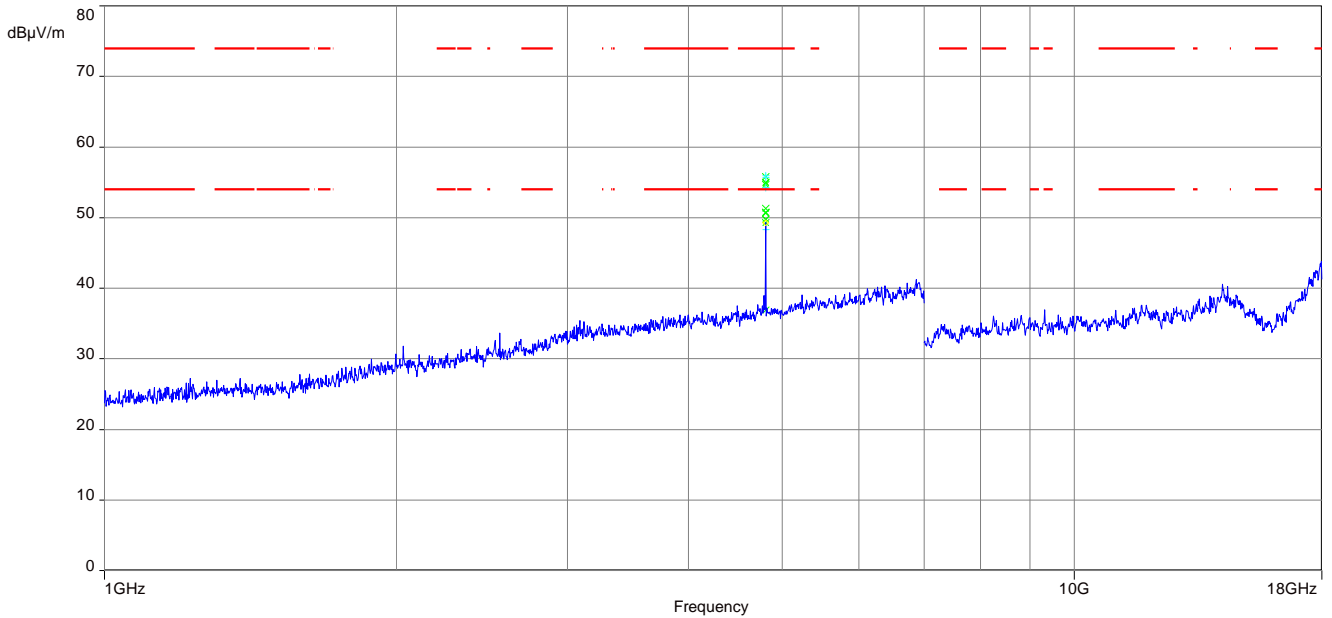

The carrier signal is notched with a 2.4 GHz band rejection filter.

**Plot 2:** 18 GHz to 26 GHz, TX mode, channel 00, vertical & horizontal polarization

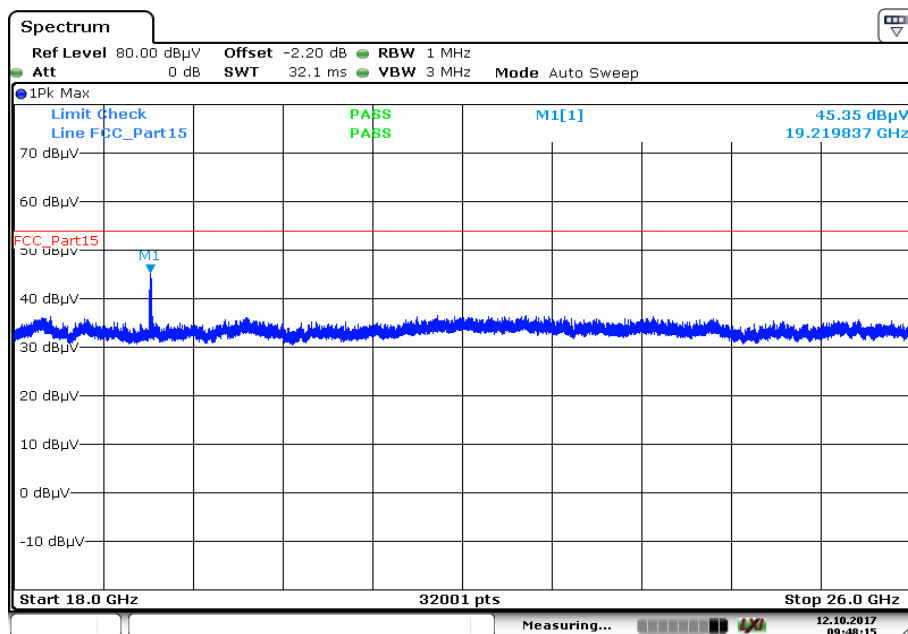

Date: 12.OCT.2017 09:48:15

**Plot 3:** 1 GHz to 18 GHz, TX mode, channel 39, vertical & horizontal polarization

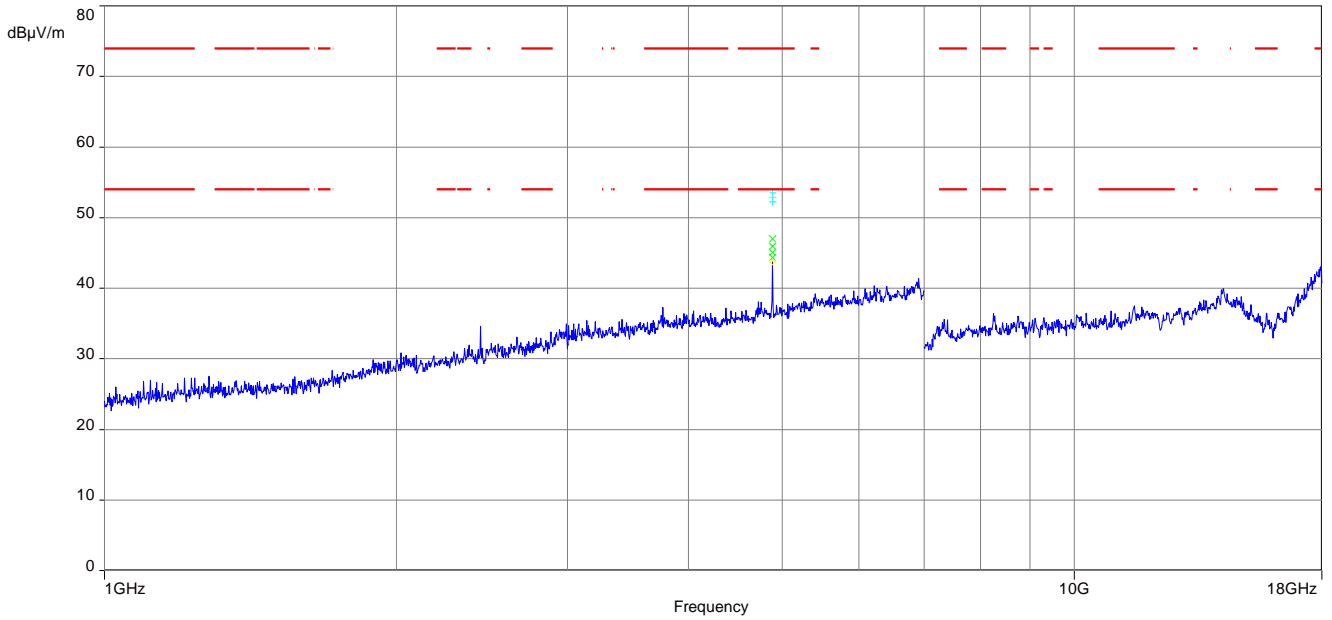

The carrier signal is notched with a 2.4 GHz band rejection filter.

**Plot 4:** 18 GHz to 26 GHz, TX mode, channel 39, vertical & horizontal polarization

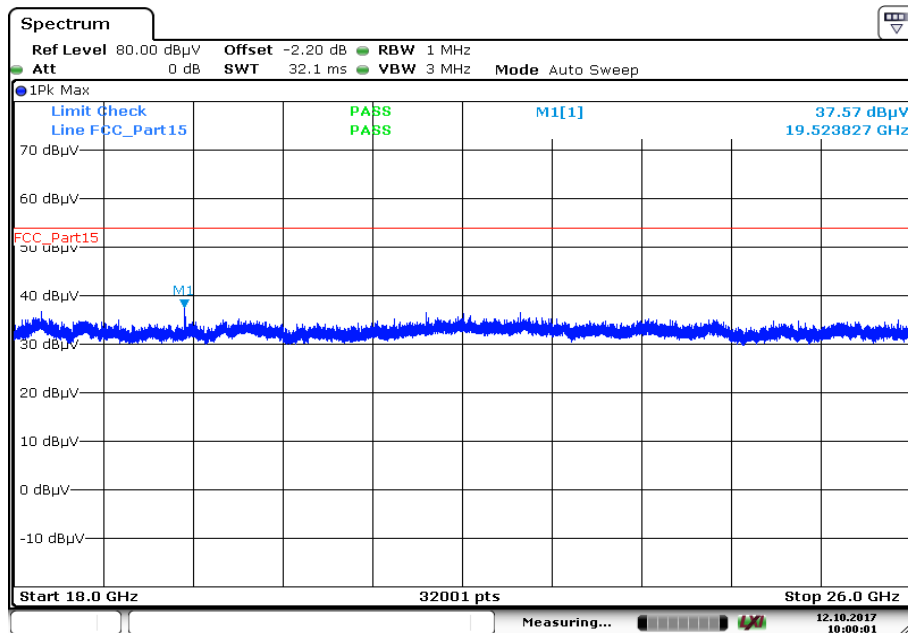

Date: 12.OCT.2017 10:00:01

**Plot 5:** 1 GHz to 18 GHz, TX mode, channel 78, vertical & horizontal polarization

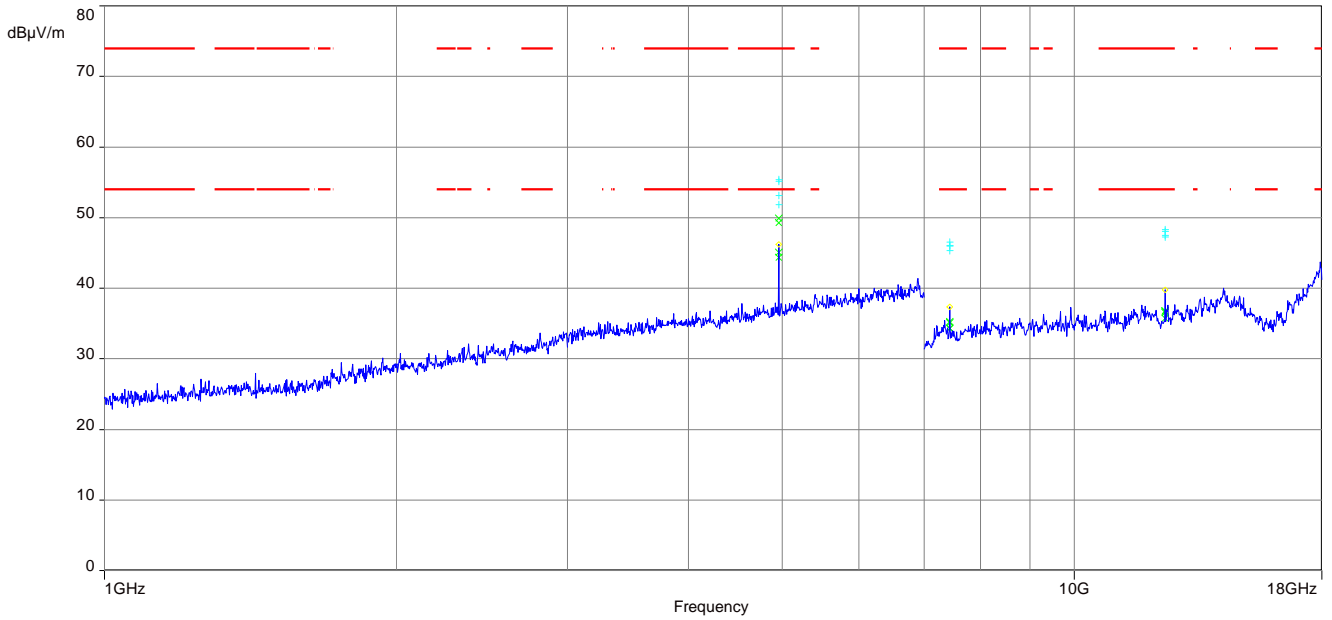

The carrier signal is notched with a 2.4 GHz band rejection filter.

**Plot 6:** 18 GHz to 26 GHz, TX mode, channel 78, vertical & horizontal polarization

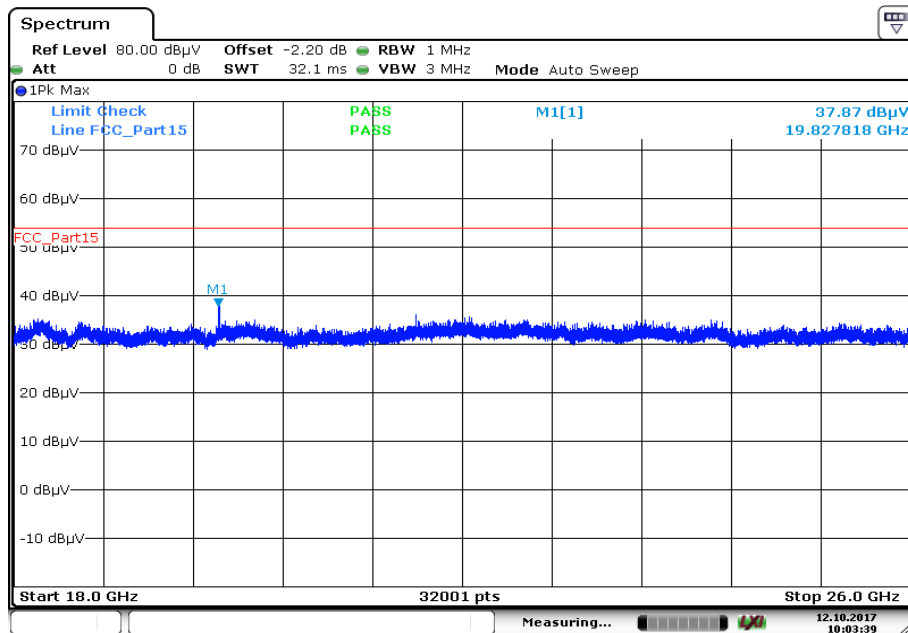

Date: 12.OCT.2017 10:03:39

**Plots:** Receiver mode

**Plot 1:** 1 GHz to 18 GHz, RX / idle – mode, vertical & horizontal polarization

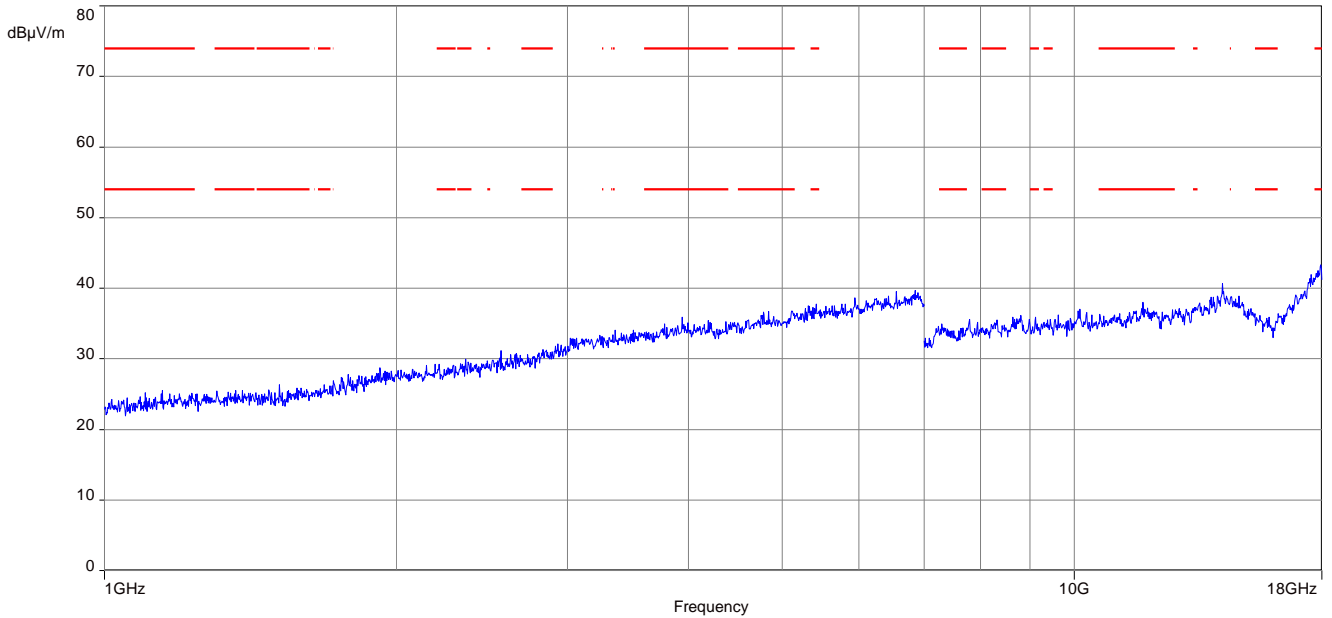

**Plot 2:** 18 GHz to 26 GHz, RX / idle – mode, vertical & horizontal polarization

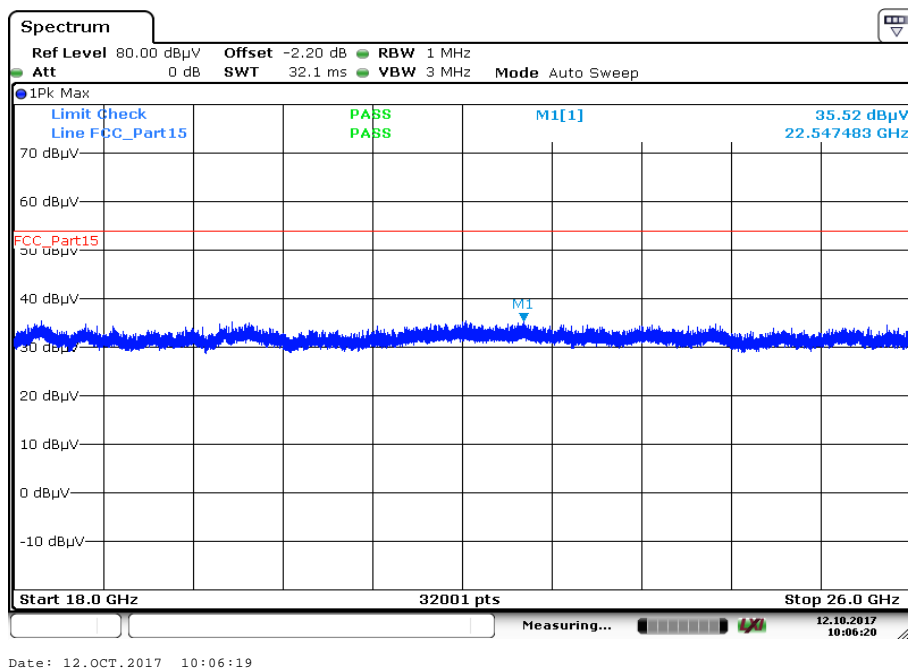

Date: 12.OCT.2017 10:06:19

## 12 Observations

No observations except those reported with the single test cases have been made.

## Annex A Glossary

<b>EUT</b>	Equipment under test
<b>DUT</b>	Device under test
<b>UUT</b>	Unit under test
<b>GUE</b>	GNSS User Equipment
<b>ETSI</b>	European Telecommunications Standards Institute
<b>EN</b>	European Standard
<b>FCC</b>	Federal Communications Commission
<b>FCC ID</b>	Company Identifier at FCC
<b>IC</b>	Industry Canada
<b>PMN</b>	Product marketing name
<b>HMN</b>	Host marketing name
<b>HVIN</b>	Hardware version identification number
<b>FVIN</b>	Firmware version identification number
<b>EMC</b>	Electromagnetic Compatibility
<b>HW</b>	Hardware
<b>SW</b>	Software
<b>Inv. No.</b>	Inventory number
<b>S/N or SN</b>	Serial number
<b>C</b>	Compliant
<b>NC</b>	Not compliant
<b>NA</b>	Not applicable
<b>NP</b>	Not performed
<b>PP</b>	Positive peak
<b>QP</b>	Quasi peak
<b>AVG</b>	Average
<b>OC</b>	Operating channel
<b>OCW</b>	Operating channel bandwidth
<b>OBW</b>	Occupied bandwidth
<b>OOB</b>	Out of band
<b>DFS</b>	Dynamic frequency selection
<b>CAC</b>	Channel availability check
<b>OP</b>	Occupancy period
<b>NOP</b>	Non occupancy period
<b>DC</b>	Duty cycle
<b>PER</b>	Packet error rate
<b>CW</b>	Clean wave
<b>MC</b>	Modulated carrier
<b>WLAN</b>	Wireless local area network
<b>RLAN</b>	Radio local area network
<b>DSSS</b>	Dynamic sequence spread spectrum
<b>OFDM</b>	Orthogonal frequency division multiplexing
<b>FHSS</b>	Frequency hopping spread spectrum
<b>GNSS</b>	Global Navigation Satellite System
<b>C/N<sub>0</sub></b>	Carrier to noise-density ratio, expressed in dB-Hz

**Annex B Document history**

Version	Applied changes	Date of release
-/-	Initial release	2017-11-08

**Annex C Accreditation Certificate**

first page	last page
 <p><b>DAkKS</b> Deutsche Akkreditierungsstelle</p> <p>Deutsche Akkreditierungsstelle GmbH Bellehene gemäß § 8 Absatz 1 AkkStelleG i.V.m. § 1 Absatz 1 AkkStelleGBV Unterzeichnerin der Multilateralen Abkommen von EA, ILAC und IAF zur gegenseitigen Anerkennung</p> <p><b>Akkreditierung</b> </p> <p>Die Deutsche Akkreditierungsstelle GmbH bestätigt hiermit, dass das Prüflaboratorium <b>CTC advanced GmbH</b> Untertürkheimer Straße 6-10, 66117 Saarbrücken</p> <p>die Kompetenz nach DIN EN ISO/IEC 17025:2005 besitzt, Prüfungen in folgenden Bereichen durchzuführen:</p> <p><b>Funk</b> Mobilfunk (GSM / DCS) + OTA Elektromagnetische Verträglichkeit (EMV) Produktsicherheit SAR / EMF Umwelt Smart Card Technology Bluetooth® Automotive Wi-Fi-Services Kanadische Anforderungen US-Anforderungen Akustik Near Field Communication (NFC)</p> <p>Die Akkreditierungsurkunde gilt nur in Verbindung mit dem Bescheid vom 25.11.2016 mit der Akkreditierungsnummer D-PL-12076-01 und ist gültig bis 17.01.2018. Sie besteht aus diesem Deckblatt, der Rückseite des Deckblatts und der folgenden Anlage mit insgesamt 63 Seiten.</p> <p>Registrierungsnummer der Urkunde: D-PL-12076-01-01</p> <p>Frankfurt, 25.11.2016 Im Auftrag Dipl.-Ing. Jörg Kall Eigner Abteilungsleiter</p>	 <p>Deutsche Akkreditierungsstelle GmbH</p> <p>Standort Berlin Spittelmarkt 10 10117 Berlin</p> <p>Standort Frankfurt am Main Europa-Allee 52 60327 Frankfurt am Main</p> <p>Standort Braunschweig Bundesallee 100 38116 Braunschweig</p> <p>Die auszugsweise Veröffentlichung der Akkreditierungsurkunde bedarf der vorherigen schriftlichen Zustimmung der Deutsche Akkreditierungsstelle GmbH (DAKKS). Ausgenommen davon ist die separate Weiterverbreitung des Deckblattes durch die umeitig genannte Konformitätsbewertungsstelle in unveränderter Form.</p> <p>Es darf nicht der Anschein erweckt werden, dass sich die Akkreditierung auch auf Bereiche erstreckt, die über den durch die DAKKS bestätigten Akkreditierungsbereich hinausgehen.</p> <p>Die Akkreditierung erfolgte gemäß des Gesetzes über die Akkreditierungsstelle (AkkStelleG) vom 31. Juli 2009 (BGBl. I S. 2625) sowie der Verordnung (EG) Nr. 765/2008 des Europäischen Parlaments und des Rates vom 9. Juli 2008 über die Vorschriften für die Akkreditierung und Marktüberwachung im Zusammenhang mit der Vermarktung von Produkten (Abl. L 218 vom 9. Juli 2008, S. 30). Die DAKKS ist Unterzeichnerin der Multilateralen Abkommen zur gegenseitigen Anerkennung der European co-operation for Accreditation (EA), des International Accreditation Forum (IAF) und der International Laboratory Accreditation Cooperation (ILAC). Die Unterzeichner dieser Abkommen erkennen ihre Akkreditierungen gegenseitig an.</p> <p>Der aktuelle Stand der Mitgliedschaft kann folgenden Webseiten entnommen werden: EA: <a href="http://www.european-accreditation.org">www.european-accreditation.org</a> ILAC: <a href="http://www.ilac.org">www.ilac.org</a> IAF: <a href="http://www.iaf.eu">www.iaf.eu</a></p>

**Note: The current certificate including annex is published on the website (link see below) of the Accreditation Body DAKKS or may be received by CTC advanced GmbH on request**

<http://www.dakks.de/as/ast/d/D-PL-12076-01-01.pdf>

<http://www.dakks.de/as/ast/d/D-PL-12076-01-02.pdf>