

FCC Radio Test Report

FCC ID: 2ANYB-SCORE5

Original Grant

Report No. : TB-FCC169858
Applicant : Advanced Technologies Group, LLC
Equipment Under Test (EUT)
EUT Name : SCORE 5
Model No. : ATG 508
Serial Model No. : N/A
Brand Name : **SCORE 5**
Receipt Date : 2019-10-24
Test Date : 2019-10-24 to 2019-11-15
Issue Date : 2019-11-19
Standards : FCC Part 15, Subpart E (15.407)
Test Method : ANSI C63.10: 2013
Conclusions : **PASS**

In the configuration tested, the EUT complied with the standards specified above,
The EUT technically complies with the FCC and IC requirements

Test/Witness Engineer : *Galen*

Approved & Authorized : *Rayhai*

This report details the results of the testing carried out on one sample. The results contained in this test report do not relate to other samples of the same product. The manufacturer should ensure that all products in series production are in conformity with the product sample detailed in the report.

Contents

CONTENTS.....2

1. GENERAL INFORMATION ABOUT EUT5

1.1 Client Information.....5

1.2 General Description of EUT (Equipment Under Test)5

1.3 Block Diagram Showing the Configuration of System Tested.....6

1.4 Description of Support Units6

1.5 Description of Test Mode.....7

1.6 Description of Test Software Setting8

1.7 Test Facility.....9

2. TEST SUMMARY10

3. TEST EQUIPMENT11

4. CONDUCTED EMISSION TEST12

4.1 Test Standard and Limit.....12

4.2 Test Setup.....12

4.3 Test Procedure.....13

4.4 EUT Operating Mode13

4.5 Test Data.....13

5. RADIATED EMISSION TEST14

5.1 Test Standard and Limit.....14

5.2 Test Setup.....15

5.3 Test Procedure.....16

5.4 EUT Operating Condition17

5.5 Test Data.....17

6. BAND EDGE EMISSIONS18

6.1 Test Standard and Limit.....18

6.2 Test Setup.....18

6.3 Test Procedure.....19

6.4 EUT Operating Condition19

6.5 Test Data.....19

7. BANDWIDTH TEST20

7.1 Test Standard and Limit.....20

7.2 Test Setup.....20

7.3 Test Procedure.....20

7.4 EUT Operating Condition21

7.5 Test Data.....21

8. OUTPUT POWER TEST22

8.1 Test Standard and Limit.....22

8.2 Test Setup.....22

8.3 Test Procedure.....22

8.4 EUT Operating Condition	22
8.5 Test Date.....	22
9. POWER SPECTRAL DENSITY TEST	23
9.1 Test Standard and Limit.....	23
9.2 Test Setup.....	23
9.3 Test Procedure.....	23
9.4 EUT Operating Condition	24
9.5 Test Data.....	24
10. FREQUENCY STABILITY MEASUREMENT	25
10.1 Test Standard and Limit	25
10.2 Test Setup.....	25
10.3 Test Procedure.....	25
10.4 EUT Operating Condition	25
10.5 Test Data.....	26
11. ANTENNA REQUIREMENT.....	27
11.1 Standard Requirement.....	27
11.2 Antenna Connected Construction	27
11.3 Result.....	27
ATTACHMENT A-- CONDUCTED EMISSION TEST DATA	28
REMARK: ALL MODES AND CHANNELS HAVE BEEN TESTED AND ONLY LISTED WIFI LINK MODE THAT IS WORST DATA	29
ATTACHMENT B-- RADIATED EMISSION TEST DATA	30
ATTACHMENT C-- BAND EDGE EMISSIONS TEST DATA	44
ATTACHMENT D-- BANDWIDTH TEST DATA.....	74
ATTACHMENT E-- OUTPUT POWER TEST DATA.....	86
ATTACHMENT F-- POWER SPECTRAL DENSITY TEST DATA.....	93

Revision History

Report No.	Version	Description	Issued Date
TB-FCC169858	Rev.01	Initial issue of report	2019-11-19

1. General Information about EUT

1.1 Client Information

Applicant : Advanced Technologies Group, LLC
Address : 1601 48th St #220, West Des Moines, IA 50266, USA
Manufacturer : Shenzhen Ployer Electronics Co., Ltd
Address : Building 8, Dongfang Jianfu Yusheng Industrial Park, Gushu, Xixiang, Baoan District, Shenzhen, 518000, China.

1.2 General Description of EUT (Equipment Under Test)

EUT Name	:	SCORE 5	
Models No.	:	ATG 508	
Model Difference	:	N/A	
Product Description	:	Operation Frequency:	U-NII-1: 5180MHz~5240MHz U-NII-3: 5745MHz~5825MHz
		RF Output Power:	U-NII-1-802.11 a:6.42dBm(Max) U-NII-3-802.11 a:6.57dBm(Max)
		Antenna Gain:	1.13dBi FPC Antenna for 5G WiFi
		Modulation Type:	802.11a: OFDM (QPSK, BPSK, 16QAM) 802.11n: OFDM (QPSK, BPSK, 16QAM, 64QAM)
		Bit Rate of Transmitter:	802.11a: 6/9/12/18/24/36/48/54 Mbps 802.11n: up to 150Mbps
Power Supply	:	DC Voltage Supply from AC/DC Adapter DC Voltage supplied by Li-ion battery.	
Power Rating	:	Input: DC 5V 2A DC 3.7V 4000mAh by Li-ion battery	
Software Version	:	V01	
Hardware Version	:	V02	
Connecting I/O Port(S)	:	Please refer to the User's Manual	
Note: More detailed features description, please refer to the manufacturer's specifications or the User's Manual.			

Note:

(1) This Test Report is FCC Part 15, Subpart E(15.407) for 802.11a/n/ac, the test procedure follows the FCC KDB 789033 D02 General UNII Test Procedures New Rules V02r01.

(2) Channel List:

5G Band 5150~5250 MHz (U-NII-1)				
Frequency Band	Channel No.	Frequency	Channel No.	Frequency
5180~5240 MHz U-NII-1	36	5180 MHz	44	5220 MHz
	38	5190 MHz	46	5230 MHz
	40	5200 MHz	48	5240 MHz
	42	5210 MHz		
Remark: For 20 MHz Bandwidth, use channel 36, 40, 48. For 40 MHz Bandwidth, use channel 38, 46.				
5G Band 5745~5825 MHz(U-NII-3)				
Frequency Band	Channel No.	Frequency	Channel No.	Frequency
5745~5825 MHz U-NII-3	149	5745 MHz	157	5785 MHz
	151	5755 MHz	159	5795 MHz
	153	5765 MHz	161	5805 MHz
	155	5775 MHz	165	5825 MHz
Remark: For 20 MHz Bandwidth, use channel 149, 157, 165. For 40 MHz Bandwidth, use channel 151, 159.				

1.3 Block Diagram Showing the Configuration of System Tested TX Mode

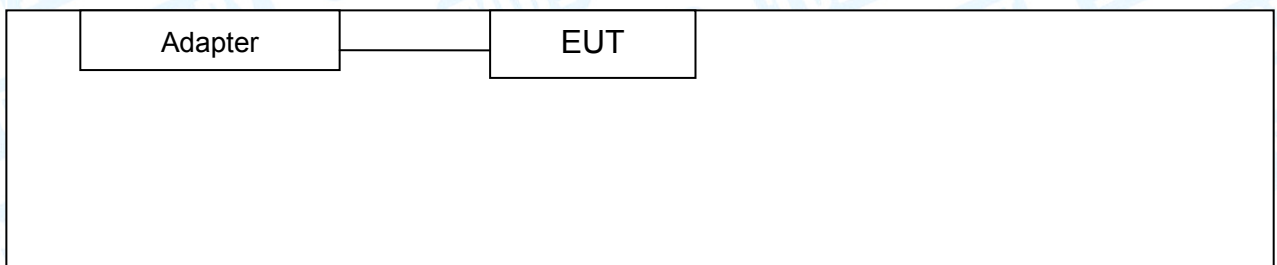

1.4 Description of Support Units

Equipment Information				
Name	Model	FCC ID/VOC	Manufacturer	Used “√”
Adapter	CS-1201000	----	----	√
Cable Information				
Number	Shielded Type	Ferrite Core	Length	Note
10307	----	√	----	

1.5 Description of Test Mode

To investigate the maximum EMI emission characteristics generates from EUT, the test system was pre-scanning tested base on the consideration of following EUT operation mode or test configuration mode which possible have effect on EMI emission level. Each of these EUT operation mode(s) or test configuration mode(s) mentioned follow was evaluated respectively.

For Conducted Test		
Final Test Mode	Description	
Mode 1	TX 802.11a Mode	
For Radiated Test		
Test Band	Final Test Mode	Description
U-NII-1	Mode1	TX Mode 802.11a Mode Channel 36/40/48
	Mode 2	TX Mode 802.11n(HT20) Mode Channel 36/40/48
	Mode 3	TX Mode 802.11n(HT40) Mode Channel 38/46
U-NII-3	Mode 4	TX Mode 802.11a Mode Channel 149/157/165
	Mode 5	TX Mode 802.11n(HT20) Mode Channel 149/157/165
	Mode 6	TX Mode 802.11n(HT40) Mode Channel 151/159

Note:

- (1) For all test, we have verified the construction and function in typical operation. And all the test modes were carried out with the EUT in transmitting operation in maximum power with all kinds of data rate.

According to ANSI C63.10 standards, the measurements are performed at the highest, middle, lowest available channels, and the worst case data rate as follows:

802.11a Mode: OFDM (6 Mbps)

802.11n (HT20) Mode: MCS 8

802.11n (HT40) Mode: MCS 8

- (2) During the testing procedure, the continuously transmitting with the maximum power mode was programmed by the customer.
- (3) The EUT is considered a mobile unit; in normal use it was positioned on X-plane. The worst case was found positioned on X-plane. Therefore only the test data of this X-plane was used for radiated emission measurement test.

1.6 Description of Test Software Setting

During testing channel & Power controlling software provided by the customer was used to control the operating channel as well as the output power level. The RF output power selection is for the setting of RF output power expected by the customer and is going to be fixed on the firmware of the final end product power parameters of WLAN.

Test Software Version	RFTestTool.exe		
U-NII-1			
Mode:	5180MHz	5200MHz	5240MHz
IEEE 802.11a	60	60	60
IEEE 802.11n (HT20)	65	65	65
Mode:	5190MHz	5230MHz	
IEEE 802.11n (HT40)	65	65	
U-NII-3			
Mode:	5745MHz	5785MHz	5825MHz
IEEE 802.11a	48	48	48
IEEE 802.11n (HT20)	50	50	50
Mode:	5755MHz	5795MHz	
IEEE 802.11n (HT40)	50	50	

1.7 Test Facility

The testing was performed by the Shenzhen Toby Technology Co., Ltd., in their facilities located at:1A/F., Bldg.6, Yusheng Industrial Zone, The National Road No.107 Xixiang Section 467, Xixiang, Bao'an, Shenzhen, Guangdong, China.

At the time of testing, the following bodies accredited the Laboratory:

CNAS (L5813)

The Laboratory has been accredited by CNAS to ISO/IEC 17025: 2005 General Requirements for the Competence of Testing and Calibration Laboratories for the competence in the field of testing. And the Registration No.: CNAS L5813.

A2LA Certificate No.: 4750.01

The laboratory has been accredited by American Association for Laboratory Accreditation(A2LA) to ISO/IEC 17025: 2005 General Requirements for the Competence of Testing and Calibration Laboratories for the technical competence in the field of Electrical Testing. And the A2LA Certificate No.: 4750.01.

FCC Accredited Test Site Number: 854351.

IC Registration No.: (11950A-1)

The Laboratory has been registered by Certification and Engineering Bureau of Industry Canada for radio equipment testing. The site registration: Site# 11950A-1.

2. Test Summary

FCC Part 15 Subpart E(15.407)/RSS-210: 2010				
Standard Section		Test Item	Judgment	Remark
FCC	IC			
15.203	/	Antenna Requirement	PASS	N/A
15.207	RSS-GEN 7.2.4	Conducted Emission	PASS	N/A
15.407(b)	RSS-GEN 7.2.2	Band Edge Emissions	PASS	N/A
15.407(a)	RSS-24 A.9.2	26dB Bandwidth&99% Bandwidth	PASS	N/A
15.407(e)	RSS-210 A.9.2	6dB Bandwidth(only for UNII-3)	PASS	N/A
15.407(a)	RSS-210 A.9.2	Peak Output Power	PASS	N/A
15.407(a)	RSS-210 A.9.2	Power Spectral Density	PASS	N/A
15.407(b)	RSS-210 A.9.2	Transmitter Radiated Spurious Emission	PASS	N/A
15.407(a)	RSS-210 A.9.2	Peak Excursion	PASS	N/A
15.407(g)	RSS-210 A.9.2	Frequency Stability	PASS	N/A

Note: "/" for no requirement for this test item.
N/A is an abbreviation for Not Applicable.

3. Test Equipment

Conducted Emission Test					
Equipment	Manufacturer	Model No.	Serial No.	Last Cal.	Cal. Due Date
EMI Test Receiver	Rohde & Schwarz	ESCI	100321	Jul. 13, 2019	Jul. 12, 2020
RF Switching Unit	Compliance Direction Systems Inc	RSU-A4	34403	Jul. 13, 2019	Jul. 12, 2020
AMN	SCHWARZBECK	NNBL 8226-2	8226-2/164	Jul. 13, 2019	Jul. 12, 2020
LISN	Rohde & Schwarz	ENV216	101131	Jul. 13, 2019	Jul. 12, 2020
Radiation Emission Test					
Equipment	Manufacturer	Model No.	Serial No.	Last Cal.	Cal. Due Date
Spectrum Analyzer	Agilent	E4407B	MY45106456	Jul. 13, 2019	Jul. 12, 2020
EMI Test Receiver	Rohde & Schwarz	ESPI	100010/007	Jul. 13, 2019	Jul. 12, 2020
Bilog Antenna	ETS-LINDGREN	3142E	00117537	Jan. 27, 2019	Jan. 26, 2020
Bilog Antenna	ETS-LINDGREN	3142E	00117542	Jan. 27, 2019	Jan. 26, 2020
Horn Antenna	ETS-LINDGREN	3117	00143207	Mar.03, 2019	Mar. 02, 2020
Horn Antenna	ETS-LINDGREN	3117	00143209	Mar.03, 2019	Mar. 02, 2020
Loop Antenna	SCHWARZBECK	FMZB 1519 B	1519B-059	Jan. 27, 2019	Jan. 26, 2020
Pre-amplifier	Sonoma	310N	185903	Mar.04, 2019	Mar. 03, 2020
Pre-amplifier	HP	8449B	3008A00849	Mar.03, 2019	Mar. 02, 2020
Cable	HUBER+SUHNER	100	SUCOFLEX	Mar.03, 2019	Mar. 02, 2020
Positioning Controller	ETS-LINDGREN	2090	N/A	N/A	N/A
Antenna Conducted Emission					
Equipment	Manufacturer	Model No.	Serial No.	Last Cal.	Cal. Due Date
Spectrum Analyzer	Agilent	E4407B	MY45106456	Jul. 13, 2019	Jul. 12, 2020
Spectrum Analyzer	Rohde & Schwarz	ESCI	100010/007	Jul. 13, 2019	Jul. 12, 2020
MXA Signal Analyzer	Agilent	N9020A	MY49100060	Sep. 16, 2019	Sep. 17, 2020
Vector Signal Generator	Agilent	N5182A	MY50141294	Sep. 16, 2019	Sep. 17, 2020
Analog Signal Generator	Agilent	N5181A	MY50141953	Sep. 16, 2019	Sep. 17, 2020
RF Power Sensor	DARE!! Instruments	RadiPowerRPR3006W	17I00015SNO26	Sep. 16, 2019	Sep. 17, 2020
	DARE!! Instruments	RadiPowerRPR3006W	17I00015SNO29	Sep. 16, 2019	Sep. 17, 2020
	DARE!! Instruments	RadiPowerRPR3006W	17I00015SNO31	Sep. 16, 2019	Sep. 17, 2020
	DARE!! Instruments	RadiPowerRPR3006W	17I00015SNO33	Sep. 16, 2019	Sep. 17, 2020

4. Conducted Emission Test

4.1 Test Standard and Limit

- 4.1.1 Test Standard
 FCC Part 15.207
- 4.1.2 Test Limit

Conducted Emission Test Limit

Frequency	Maximum RF Line Voltage (dB μ V)	
	Quasi-peak Level	Average Level
150kHz~500kHz	66 ~ 56 *	56 ~ 46 *
500kHz~5MHz	56	46
5MHz~30MHz	60	50

Notes:

- (1) *Decreasing linearly with logarithm of the frequency.
- (2) The lower limit shall apply at the transition frequencies.
- (3) The limit decrease in line with the logarithm of the frequency in the range of 0.15 to 0.50MHz.

4.2 Test Setup

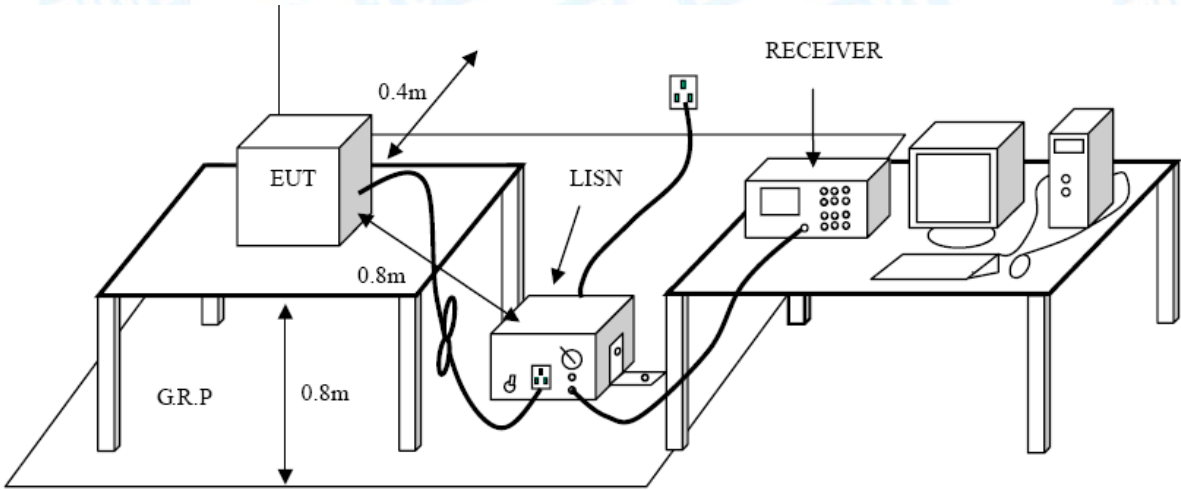

4.3 Test Procedure

The EUT was placed 0.8 meters from the horizontal ground plane with EUT being connected to the power mains through a line impedance stabilization network (LISN). All other support equipments powered from additional LISN(s). The LISN provide 50 Ohm/50uH of coupling impedance for the measuring instrument.

Interconnecting cables that hang closer than 40 cm to the ground plane shall be folded back and forth in the center forming a bundle 30 to 40 cm long.

I/O cables that are not connected to a peripheral shall be bundled in the center. The end of the cable may be terminated, if required, using the correct terminating impedance. The overall length shall not exceed 1 m.

LISN at least 80 cm from nearest part of EUT chassis.

The bandwidth of EMI test receiver is set at 9kHz, and the test frequency band is from 0.15MHz to 30MHz.

4.4 EUT Operating Mode

Please refer to the description of test mode.

4.5 Test Data

Please refer to the Attachment A.

5. Radiated Emission Test

5.1 Test Standard and Limit

5.1.1 Test Standard
FCC Part 15.209

5.1.2 Test Limit

Radiated Emission Limits (9kHz~1000MHz)

Frequency (MHz)	Field Strength (microvolt/meter)	Measurement Distance (meters)
0.009~0.490	2400/F(KHz)	300
0.490~1.705	24000/F(KHz)	30
1.705~30.0	30	30
30~88	100	3
88~216	150	3
216~960	200	3
Above 960	500	3

Radiated Emission Limit (Above 1000MHz)

Frequency (MHz)	Distance Meters(at 3m)	
	Peak	Average
Above 1000	74	54

Note:

- (1) The tighter limit applies at the band edges.
- (2) Emission Level(dBuV/m)=20log Emission Level(uV/m)

Limits of unwanted emission out of the restricted bands

Frequency (MHz)	EIRP Limits (dBm)	Equivalent Field Strength at 3m (dBuV/m)
5150~5250	-27	68.2
5250~5350	-27	68.2
5470~5725	-27	68.2
5725~5825	-27(Note 2)	68.2
	10(Note 2)	105.3
	15.6(Note 2)	110.9
	27(Note 2)	122.2

NOTE:

1, The following formula is used to convert the equipment isotropic radiated power (eirp) to field strength:

$$E = \frac{1000000\sqrt{30P}}{3} \text{ uV/m, where P is the eirp (Watts)}$$

2, According to FCC 16-24, All emissions shall be limited to a level of -27 dBm/MHz at 75 MHz or more above or below the band edge increasing linearly to 10 dBm/MHz at 25 MHz above or below the band edge, and from 25MHz above or below the band edge increasing linearly to a level of 15.6 dBm/MHz at 5 MHz above or below the band edge, and from 5 MHz above or below the band edge increasing linearly to a level of 27dBm/MHz at the band edge.

5.2 Test Setup

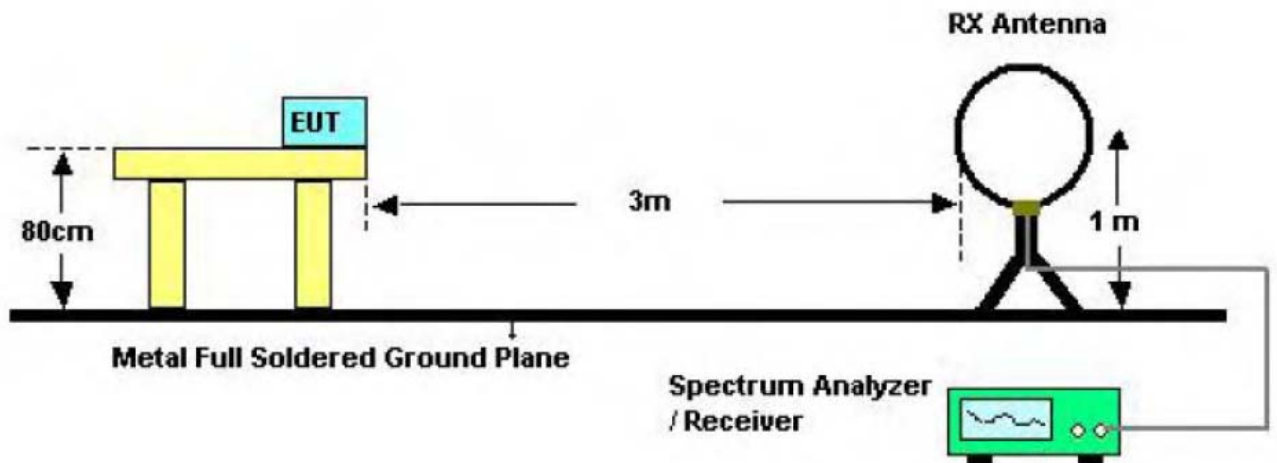

Below 30MHz Test Setup

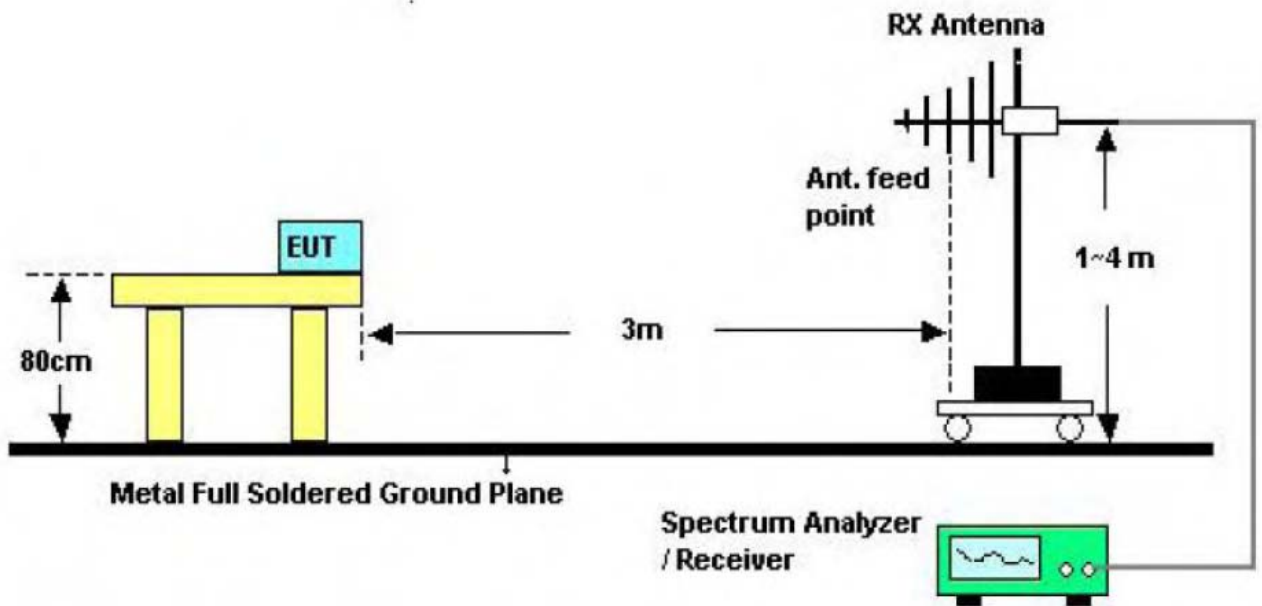

Below 1000MHz Test Setup

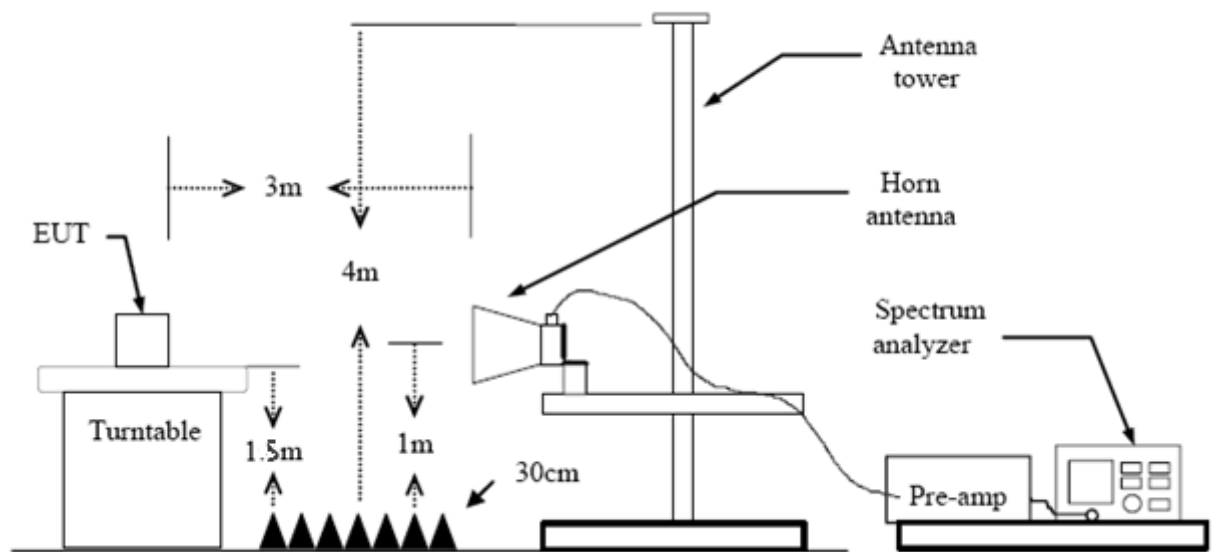

Above 1GHz Test Setup

5.3 Test Procedure

- (1) The measuring distance of 3m shall be used for measurements at frequency up to 1GHz. The EUT was placed on a rotating 0.8m high above the ground, the table was rotated 360 degrees to determine the position of the highest radiation.
- (2) Measurements at frequency above 1GHz. The EUT was placed on a rotating 1.5m high above the ground. RF absorbers covered the ground plane with a minimum area of 3.0m by

3.0m between the EUT and measurement receiver antenna. The RF absorber shall not exceed 30cm in high above the conducting floor. The table was rotated 360 degrees to determine the position of the highest radiation.

- (3) The Test antenna shall vary between 1m and 4m, Both Horizontal and Vertical antenna are set to make measurement.
- (4) The initial step in collecting conducted emission data is a spectrum analyzer peak detector mode pre-scanning the measurement frequency range. Significant peaks are then marked and then Quasi Peak detector mode re-measured.
- (5) If the Peak Mode measured value compliance with and lower than Quasi Peak Mode Limit Bellow 1 GHz, the EUT shall be deemed to meet QP Limits and then no additional QP Mode measurement performed. But the Peak Value and average value both need to comply with applicable limit above 1 GHz.
- (6) Testing frequency range below 1GHz the measuring instrument use VBW=120 kHz with Quasi-peak detection.
- (7) Testing frequency range above 1GHz the measuring instrument use RBW=1 MHz and VBW=3 MHz with Peak Detector for Peak Values, and use RBW=1 MHz and VBW=10 Hz with Peak Detector for Average Values.
- (8) For the actual test configuration, please see the test setup photo.

5.4 EUT Operating Condition

The Equipment Under Test was set to Continual Transmitting in maximum power.

5.5 Test Data

Remark: During testing above 1GHz the measuring instrument use RBW=1 MHz and VBW=3 MHz with Peak Detector for Peak Values, and use RBW=1 MHz and VBW=10 Hz with Peak Detector for Average Values.

Please refer to the Attachment B.

6. Band Edge Emissions

6.1 Test Standard and Limit

6.1.1 Test Standard
FCC Part 15.407(b)

6.1.2 Test Limit

Limits of unwanted emission out of the restricted bands

Frequency (MHz)	EIRP Limits (dBm)	Equivalent Field Strength at 3m (dBuV/m)
5150~5250	-27	68.2
5725~5825	-27(Note 2)	68.2
	10(Note 2)	105.3
	15.6(Note 2)	110.9
	27(Note 2)	122.2

NOTE:

1, The following formula is used to convert the equipment isotropic radiated power (eirp) to field strength:

$$E = \frac{1000000\sqrt{30P}}{3} \text{ uV/m, where P is the eirp (Watts)}$$

2, According to FCC 16-24, All emissions shall be limited to a level of -27 dBm/MHz at 75 MHz or more above or below the band edge increasing linearly to 10 dBm/MHz at 25 MHz above or below the band edge, and from 25MHz above or below the band edge increasing linearly to a level of 15.6 dBm/MHz at 5 MHz above or below the band edge, and from 5 MHz above or below the band edge increasing linearly to a level of 27dBm/MHz at the band edge.

6.2 Test Setup

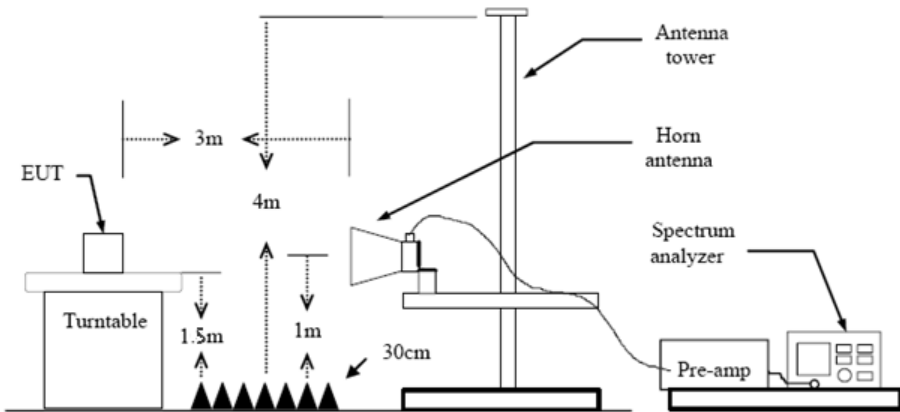

6.3 Test Procedure

- (1) The measuring distance of 3m shall be used for measurements at frequency up to 1GHz. The EUT was placed on a rotating 0.8m high above the ground, the table was rotated 360 degrees to determine the position of the highest radiation.
- (2) Measurements at frequency above 1GHz. The EUT was placed on a rotating 1.5m high above the ground. RF absorbers covered the ground plane with a minimum area of 3.0m by 3.0m between the EUT and measurement receiver antenna. The RF absorber shall not exceed 30cm in high above the conducting floor. The table was rotated 360 degrees to determine the position of the highest radiation.
- (3) The Test antenna shall vary between 1m and 4m, Both Horizontal and Vertical antenna are set to make measurement.
- (4) The initial step in collecting conducted emission data is a spectrum analyzer peak detector mode pre-scanning the measurement frequency range. Significant peaks are then marked and then Quasi Peak detector mode re-measured.
- (5) If the Peak Mode measured value compliance with and lower than Quasi Peak Mode Limit Bellow 1 GHz, the EUT shall be deemed to meet QP Limits and then no additional QP Mode measurement performed. But the Peak Value and average value both need to comply with applicable limit above 1 GHz.
- (6) Testing frequency range below 1GHz the measuring instrument use VBW=120 kHz with Quasi-peak detection.
- (7) Testing frequency range above 1GHz the measuring instrument use RBW=1 MHz and VBW=3 MHz with Peak Detector for Peak Values, and use RBW=1 MHz and VBW=10 Hz with Peak Detector for Average Values.
- (8) For the actual test configuration, please see the test setup photo.

6.4 EUT Operating Condition

The Equipment Under Test was set to Continual Transmitting in maximum power.

6.5 Test Data

Please refer to the Attachment C.

7. Bandwidth Test

7.1 Test Standard and Limit

- 7.1.1 Test Standard
FCC Part 15.407
- 7.1.2 Test Limit

FCC Part 15 Subpart C(15.407)/RSS-210		
Test Item	Limit	Frequency Range (MHz)
26 Bandwidth	N/A	5150~5250
6 dB Bandwidth	>500kHz	5725~5850

7.2 Test Setup

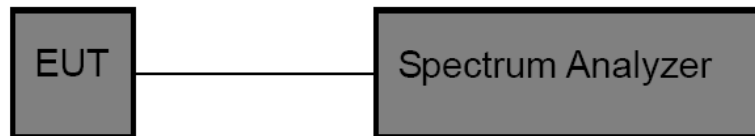

7.3 Test Procedure

- (1) The EUT was directly connected to the spectrum analyzer and antenna output port as show in the block diagram above.
- (2) The setting of the spectrum analyser as below:

26dB Bandwidth Test	
Spectrum Parameters	Setting
Attenuation	Auto
Span	>26 dB Bandwidth
RBW	Approximately 1% of the emission bandwidth
VBW	VBW>RBW
Detector	Peak
Trace	Max Hold
Sweep Time	Auto

6dB Bandwidth Test	
Spectrum Parameters	Setting
Attenuation	Auto
Span	>6 dB Bandwidth
RBW	100 kHz
VBW	VBW>=3*RBW
Detector	Peak
Trace	Max Hold
Sweep Time	Auto
99% Occupied Bandwidth Test	
Spectrum Parameters	Setting
Attenuation	Auto
RBW	1% to 5% of the OBW
VBW	≥ 3RBW
Detector	Peak
Trace	Max Hold

7.4 EUT Operating Condition

The EUT was set to continuously transmitting in each mode and low, Middle and high channel for the test.

7.5 Test Data

Please refer to the Attachment D.

8. Output Power Test

8.1 Test Standard and Limit

8.1.1 Test Standard

FCC Part 15.407 (a)

8.1.2 Test Limit

FCC Part 15 Subpart E(15.407)/RSS-210		
Test Item	Limit	Frequency Range(MHz)
Conducted Output Power	Fixed: 1 Watt (30dBm) Mobile and Portable: 250mW (24dBm)	5150~5250
	1 Watt (30dBm)	5725~5850

8.2 Test Setup

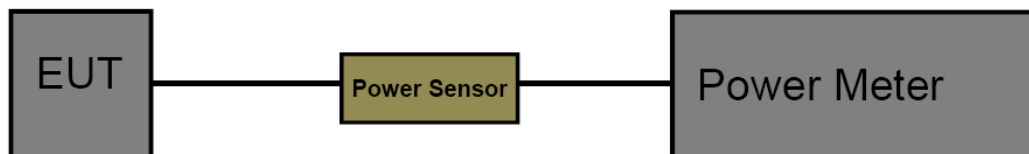

8.3 Test Procedure

The measurement is according to section 3 of KDB 789033 D02 General UNII Test Procedures New Rules V02r01.

The EUT was connected to RF power meter via a broadband power sensor as show the block above.

8.4 EUT Operating Condition

The EUT was set to continuously transmitting in the max power during the test.

8.5 Test Date

Please refer to the Attachment E.

9. Power Spectral Density Test

9.1 Test Standard and Limit

9.1.1 Test Standard

FCC Part 15.407 (a)

9.1.2 Test Limit

FCC Part 15 Subpart E(15.407)		
Test Item	Limit	Frequency Range(MHz)
Power Spectral Density	Other than Mobile and Portable : 17dBm/MHz Mobile and Portable : 11dBm/MHz	5150~5250
	30dBm/500kHz	5725~5850

9.2 Test Setup

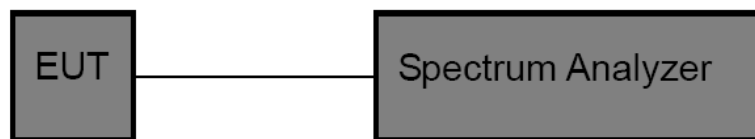

9.3 Test Procedure

The EUT was directly connected to the Spectrum Analyzer and antenna output port as show in the block diagram above. The measurement is according to KDB 789033 D02 General UNII Test Procedures New Rules V02r01.

- (1) The EUT was directly connected to the spectrum analyzer and antenna output port as show in the block diagram above.
- (2) Set analyser centre frequency to transmitting frequency.
- (3) Set the span to encompass the entire emissions bandwidth (EBW)(alternatively, the entire 99% OBW) of the signal.
- (4) Set the RBW to: 1 MHz
- (5) Set the VBW to: 3 MHz
- (6) Detector: RMS
- (7) Trace: Max Hold
- (7) Sweep time: auto
- (8) Trace average at least 100 traces in power averaging.
- (9) User the peak marker function to determine the maximum amplitude level within the RBW.
Apply correction to the result if different RBW is used.

9.4 EUT Operating Condition

The EUT was set to continuously transmitting in each mode and low, Middle and high channel for the test.

9.5 Test Data

Please refer to the Attachment F.

10. Frequency Stability Measurement

10.1 Test Standard and Limit

10.1.1 Test Standard

FCC Part 15.407

10.1.2 Test Limit

FCC Part 15 Subpart C(15.407)		
Test Item	Limit	Frequency Range(MHz)
Peak Excursion Measurement	Specified in the user's manual, the transmitter center frequency tolerance shall be ± 20 ppm maximum for the 5 GHz band (IEEE 802.11n specification)	5150~5250
		5725~5850

10.2 Test Setup

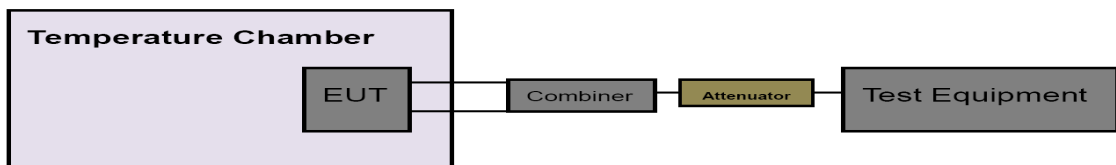

10.3 Test Procedure

The EUT was directly connected to the Spectrum Analyzer and antenna output port as show in the block diagram above.

- (1) The EUT was directly connected to the spectrum analyzer and antenna output port as show in the block diagram above.
- (2) Set analyser centre frequency to transmitting frequency.
- (3) Set the span to encompass the entire emissions bandwidth (EBW) of the signal.
- (4) Set the RBW to: 10 kHz, VBW=10 kHz with peak detector and maxhold settings.
- (5) The test extreme voltage is to change the primary supply voltage from 85 to 115 percent of the nominal value.
- (6) Extreme temperature is 0°C~50°C

10.4 EUT Operating Condition

The EUT was set to continuously transmitting in continuously un-modulation transmitting mode.

10.5 Test Data

Please refer to the Attachment G.

11. Antenna Requirement

11.1 Standard Requirement

11.1.1 Standard

FCC Part 15.203

11.1.2 Requirement

An intentional radiator shall be designed to ensure that no antenna other than that furnished by the responsible party shall be used with the device. The use of a permanently attached antenna or of an antenna that uses a unique coupling to the intentional radiator shall be considered sufficient to comply with the provisions of this Section. The manufacturer may design the unit so that a broken antenna can be replaced by the user, but the use of a standard antenna jack or electrical connector is prohibited.

11.2 Antenna Connected Construction

The directional gains of the antenna used for transmitting is 1.13dBi, and the antenna de-signed with permanent attachment and no consideration of replacement. Please see the EUT photo for details.

11.3 Result

The EUT antenna is a FPC Antenna. It complies with the standard requirement.

Antenna Type
<input checked="" type="checkbox"/> Permanent attached antenna
<input type="checkbox"/> Unique connector antenna
<input type="checkbox"/> Professional installation antenna

Attachment A-- Conducted Emission Test Data

Temperature:	25 °C	Relative Humidity:	55%
Test Voltage:	AC 120V/60 Hz		
Terminal:	Line		
Test Mode:	TX 802.11a Mode CH36		
Remark:	Only worse case is reported		

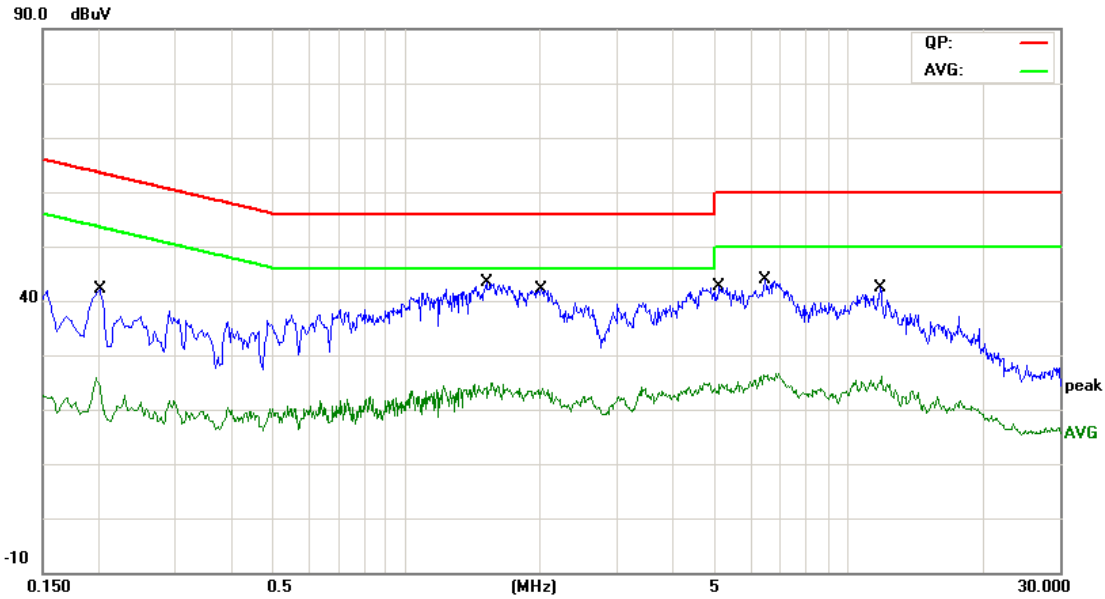

No.	Mk.	Freq. MHz	Reading Level dBuV	Correct Factor dB	Measure- ment dBuV	Limit dBuV	Over dB	Detector
1		0.2020	37.46	0.00	37.46	63.52	-26.06	QP
2		0.2020	22.34	0.00	22.34	53.52	-31.18	AVG
3	*	1.5180	38.00	0.00	38.00	56.00	-18.00	QP
4		1.5180	22.55	0.00	22.55	46.00	-23.45	AVG
5		2.0180	36.61	0.00	36.61	56.00	-19.39	QP
6		2.0180	21.35	0.00	21.35	46.00	-24.65	AVG
7		5.0939	35.65	0.00	35.65	60.00	-24.35	QP
8		5.0939	22.50	0.00	22.50	50.00	-27.50	AVG
9		6.4620	36.22	0.00	36.22	60.00	-23.78	QP
10		6.4620	24.75	0.00	24.75	50.00	-25.25	AVG
11		11.8060	32.77	0.00	32.77	60.00	-27.23	QP
12		11.8060	23.60	0.00	23.60	50.00	-26.40	AVG

*:Maximum data x:Over limit !:over margin

Emission Level= Read Level+ Correct Factor

Temperature:	25 °C	Relative Humidity:	55%
Test Voltage:	AC 120V/60 Hz		
Terminal:	Neutral		
Test Mode:	TX 802.11a Mode CH36		
Remark:	Only worse case is reported		

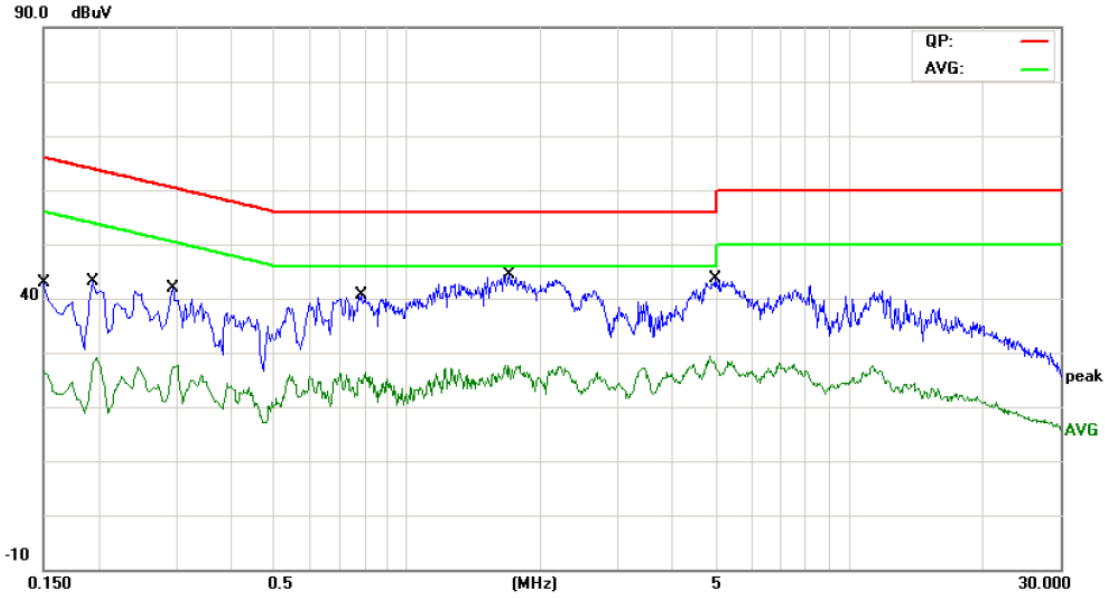

No.	Mk.	Freq. MHz	Reading Level dBuV	Correct Factor dB	Measure- ment dBuV	Limit dBuV	Over dB	Detector
1		0.1500	27.05	9.60	36.65	65.99	-29.34	QP
2		0.1500	15.95	9.60	25.55	55.99	-30.44	AVG
3		0.1940	29.49	9.57	39.06	63.86	-24.80	QP
4		0.1940	17.47	9.57	27.04	53.86	-26.82	AVG
5		0.2940	27.36	9.70	37.06	60.41	-23.35	QP
6		0.2940	17.74	9.70	27.44	50.41	-22.97	AVG
7		0.7860	27.23	9.76	36.99	56.00	-19.01	QP
8		0.7860	14.91	9.76	24.67	46.00	-21.33	AVG
9	*	1.7060	29.61	9.84	39.45	56.00	-16.55	QP
10		1.7060	16.13	9.84	25.97	46.00	-20.03	AVG
11		4.9580	27.85	9.82	37.67	56.00	-18.33	QP
12		4.9580	17.34	9.82	27.16	46.00	-18.84	AVG

*:Maximum data x:Over limit !:over margin

Emission Level= Read Level+ Correct Factor

Remark: All modes and channels have been tested and only listed WiFi link mode that is worst data

Attachment B-- Radiated Emission Test Data

9 KHz~30 MHz

From 9 KHz to 30 MHz: Conclusion: PASS

Note: The amplitude of spurious emissions which are attenuated by more than 20dB below the permissible value has no need to be reported.

30MHz~1GHz

Temperature:	25 °C	Relative Humidity:	55%
Test Voltage:	AC 120V/60Hz		
Ant. Pol.	Horizontal		
Test Mode:	TX 802.11a Mode 5180MHz (U-NII-1)		
Remark:	Only worse case is reported		

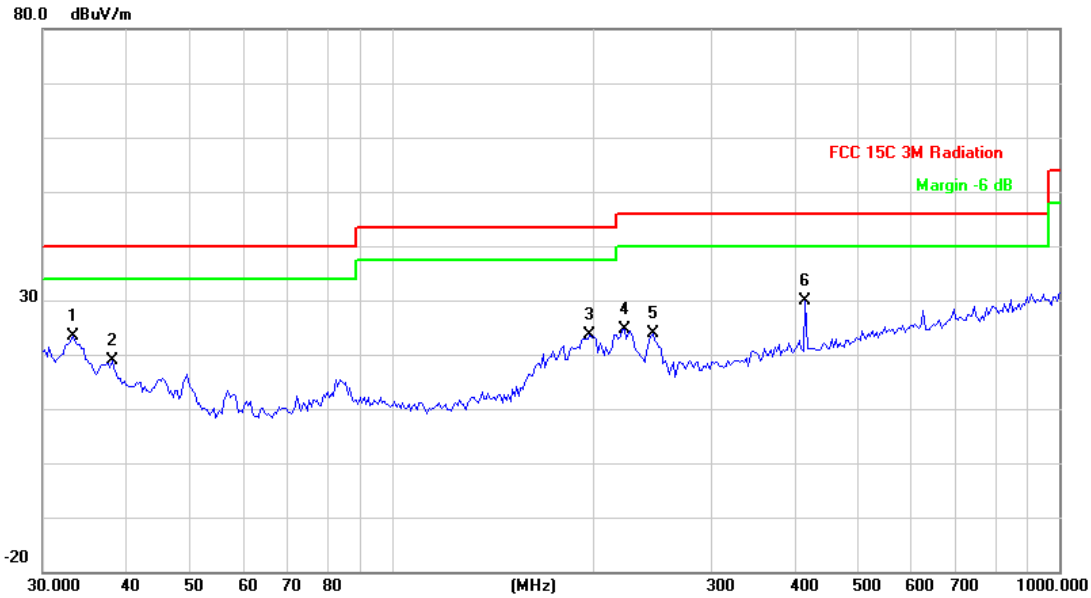

No.	Mk.	Freq. MHz	Reading Level dBuV	Correct Factor dB/m	Measurement dBuV/m	Limit dBuV/m	Over dB	Detector
1		33.3279	39.02	-15.52	23.50	40.00	-16.50	QP
2		38.0783	37.04	-18.26	18.78	40.00	-21.22	QP
3		197.8928	43.50	-19.87	23.63	43.50	-19.87	QP
4		222.9502	43.24	-18.60	24.64	46.00	-21.36	QP
5		245.9509	41.03	-17.27	23.76	46.00	-22.24	QP
6	*	416.1791	41.91	-11.99	29.92	46.00	-16.08	QP

*:Maximum data x:Over limit !:over margin

Emission Level= Read Level+ Correct Factor

Temperature:	25 °C	Relative Humidity:	55%
Test Voltage:	AC 120V/60Hz		
Ant. Pol.	Vertical		
Test Mode:	TX 802.11a Mode 5180MHz (U-NII-1)		
Remark:	Only worse case is reported		

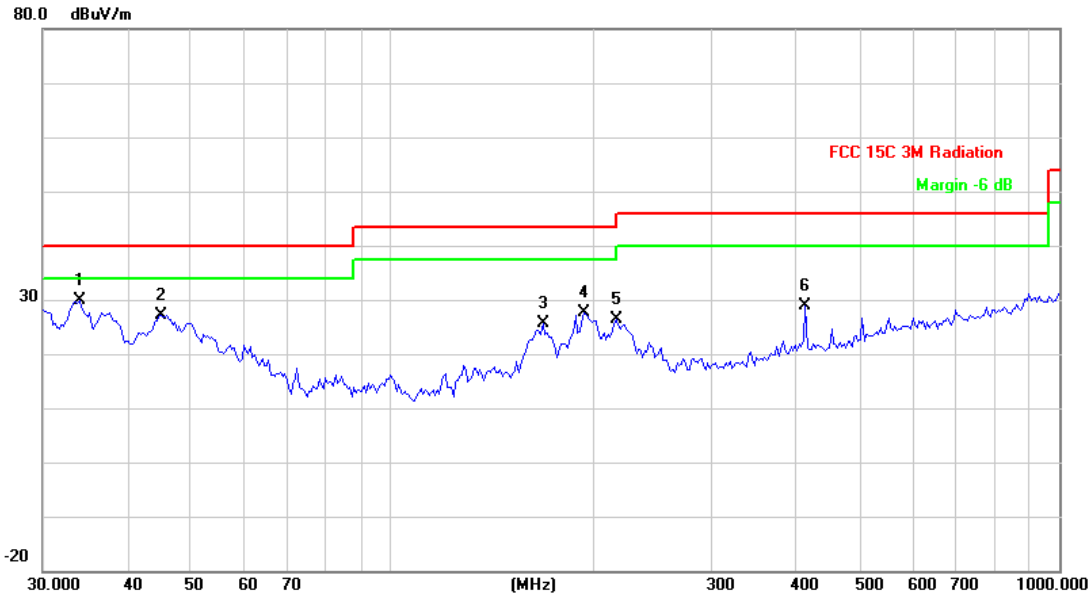

No.	Mk.	Freq. MHz	Reading Level dBuV	Correct Factor dB/m	Measure- ment dBuV/m	Limit dBuV/m	Over dB	Detector
1	*	34.0365	45.88	-16.06	29.82	40.00	-10.18	QP
2		45.0583	48.93	-21.68	27.25	40.00	-12.75	QP
3		168.4138	46.21	-20.55	25.66	43.50	-17.84	QP
4		193.7728	47.41	-19.82	27.59	43.50	-15.91	QP
5		216.7828	45.29	-18.94	26.35	46.00	-19.65	QP
6		416.1791	40.81	-11.99	28.82	46.00	-17.18	QP

*:Maximum data x:Over limit !:over margin

Emission Level= Read Level+ Correct Factor

Above 1GHz
5180MHz-5250MHz(U-NII-1)

Temperature:	25 °C	Relative Humidity:	55%
Test Voltage:	AC 120V/60Hz		
Ant. Pol.	Horizontal		
Test Mode:	TX 802.11a Mode 5180MHz (U-NII-1)		
Remark:	No report for the emission which more than 10 dB below the prescribed limit. Only worse case is reported.		

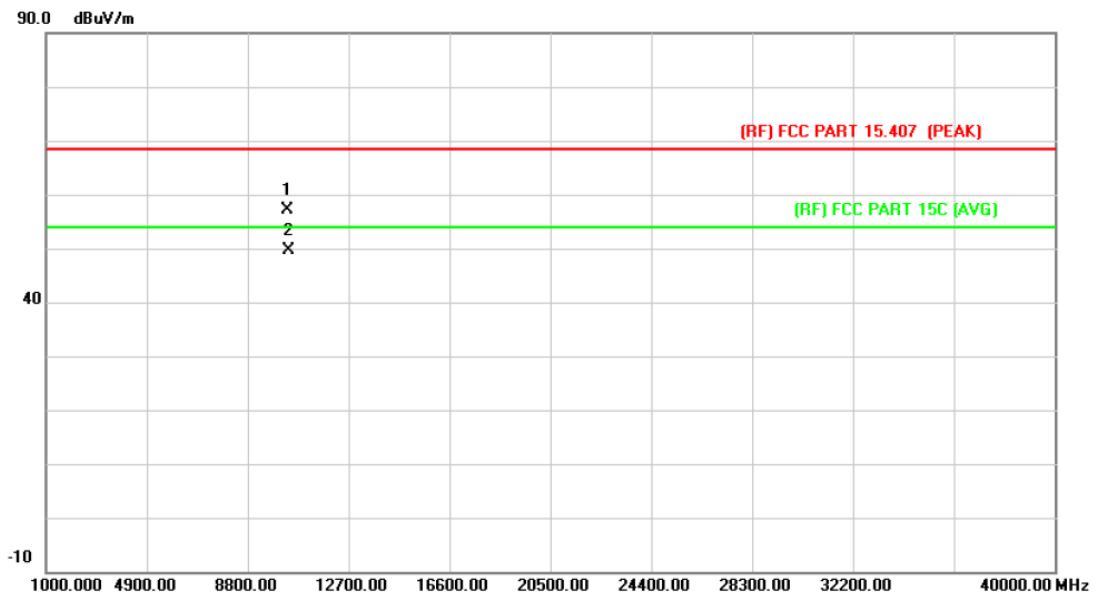

No.	Mk.	Freq. MHz	Reading Level dBuV	Correct Factor dB/m	Measure- ment dBuV/m	Limit dBuV/m	Over dB	Detector
1		10359.788	36.70	20.50	57.20	68.30	-11.10	peak
2	*	10360.225	29.02	20.50	49.52	54.00	-4.48	AVG

Emission Level= Read Level+ Correct Factor

Temperature:	25 °C	Relative Humidity:	55%
Test Voltage:	AC 120V/60Hz		
Ant. Pol.	Vertical		
Test Mode:	TX 802.11a Mode 5180MHz (U-NII-1)		
Remark:	No report for the emission which more than 10 dB below the prescribed limit. Only worse case is reported.		

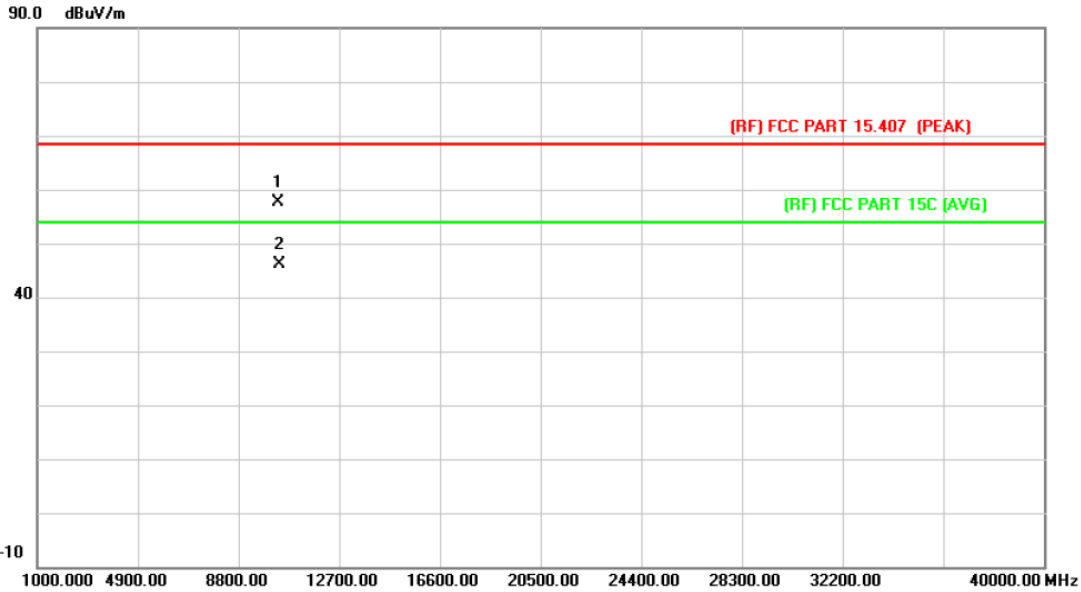

No.	Mk.	Freq. MHz	Reading Level dBuV	Correct Factor dB/m	Measure- ment dBuV/m	Limit dBuV/m	Over dB	Detector
1		10359.650	37.11	20.50	57.61	68.30	-10.69	peak
2	*	10360.295	25.64	20.50	46.14	54.00	-7.86	AVG

Emission Level= Read Level+ Correct Factor

Temperature:	25 °C	Relative Humidity:	55%
Test Voltage:	AC 120V/60Hz		
Ant. Pol.	Horizontal		
Test Mode:	TX 802.11a Mode 5200MHz (U-NII-1)		
Remark:	No report for the emission which more than 10 dB below the prescribed limit.		

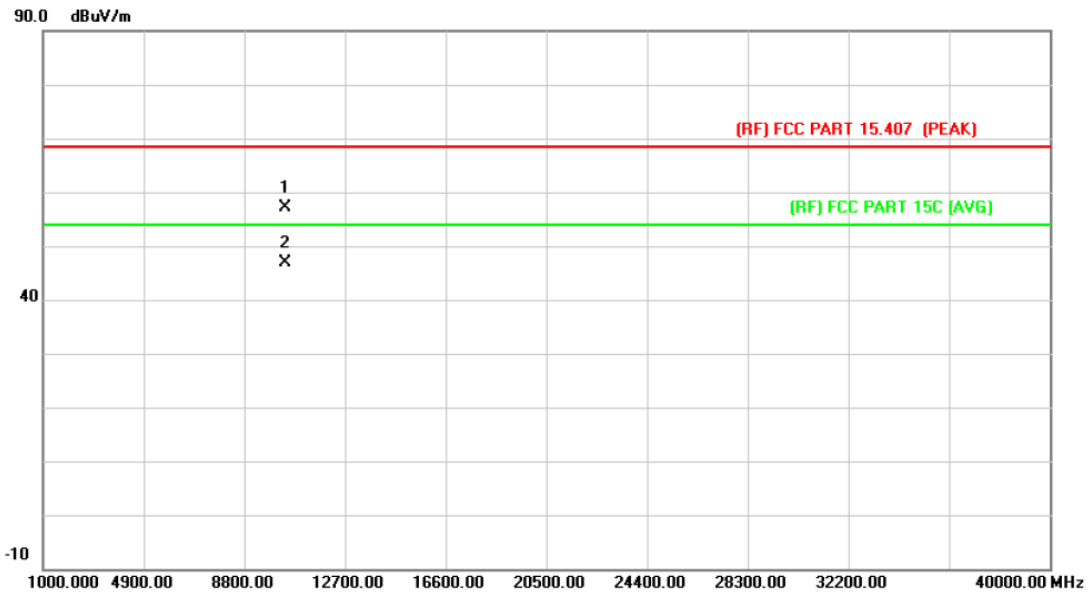

No.	Mk.	Freq. MHz	Reading Level dBuV	Correct Factor dB/m	Measure- ment dBuV/m	Limit dBuV/m	Over dB	Detector
1		10399.507	36.59	20.56	57.15	68.30	-11.15	peak
2	*	10400.198	26.29	20.56	46.85	54.00	-7.15	AVG

Emission Level= Read Level+ Correct Factor

Temperature:	25 °C	Relative Humidity:	55%
Test Voltage:	AC 120V/60Hz		
Ant. Pol.	Vertical		
Test Mode:	TX 802.11a Mode 5200MHz (U-NII-1)		
Remark:	No report for the emission which more than 10 dB below the prescribed limit.		

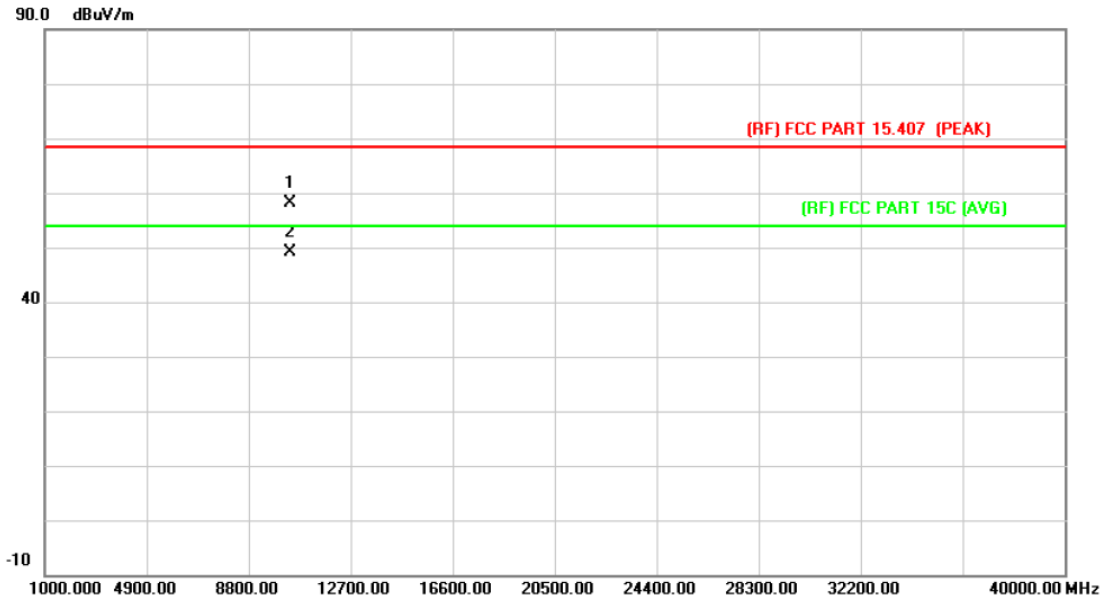

No.	Mk.	Freq. MHz	Reading Level dBuV	Correct Factor dB/m	Measure- ment dBuV/m	Limit dBuV/m	Over dB	Detector
1		10399.985	37.49	20.56	58.05	68.30	-10.25	peak
2	*	10400.442	28.69	20.56	49.25	54.00	-4.75	AVG

Emission Level= Read Level+ Correct Factor

Temperature:	25 °C	Relative Humidity:	55%
Test Voltage:	AC 120V/60Hz		
Ant. Pol.	Horizontal		
Test Mode:	TX 802.11a Mode 5240MHz (U-NII-1)		
Remark:	No report for the emission which more than 10 dB below the prescribed limit.		

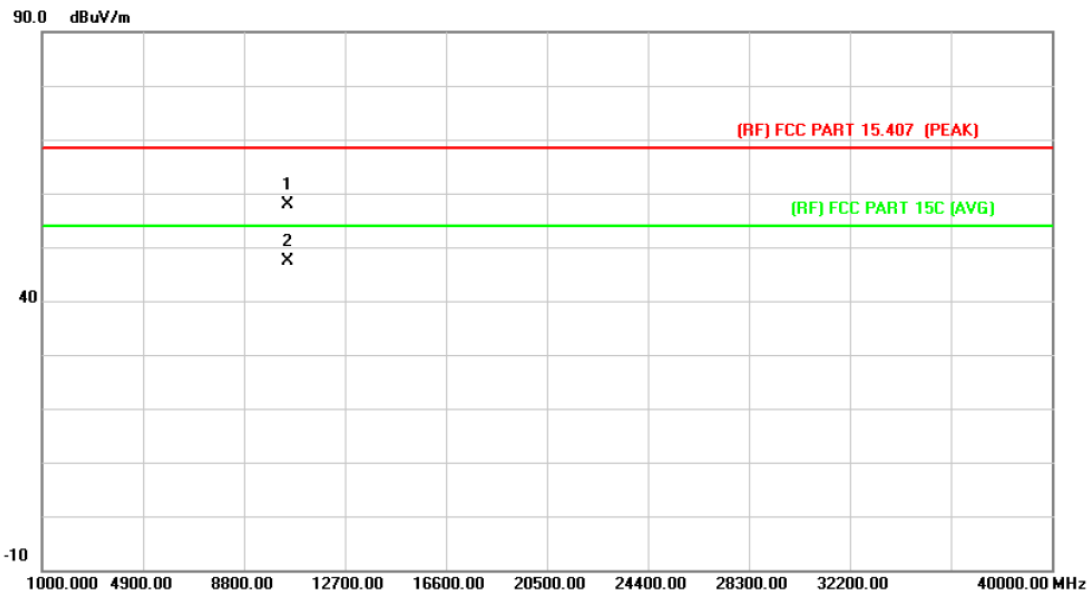

No.	Mk.	Freq. MHz	Reading Level dBuV	Correct Factor dB/m	Measure- ment dBuV/m	Limit dBuV/m	Over dB	Detector
1		10479.708	37.28	20.68	57.96	68.30	-10.34	peak
2	*	10479.728	26.76	20.68	47.44	54.00	-6.56	AVG

Emission Level= Read Level+ Correct Factor

Temperature:	25 °C	Relative Humidity:	55%
Test Voltage:	AC 120V/60Hz		
Ant. Pol.	Vertical		
Test Mode:	TX 802.11a Mode 5240MHz (U-NII-1)		
Remark:	No report for the emission which more than 10 dB below the prescribed limit.		

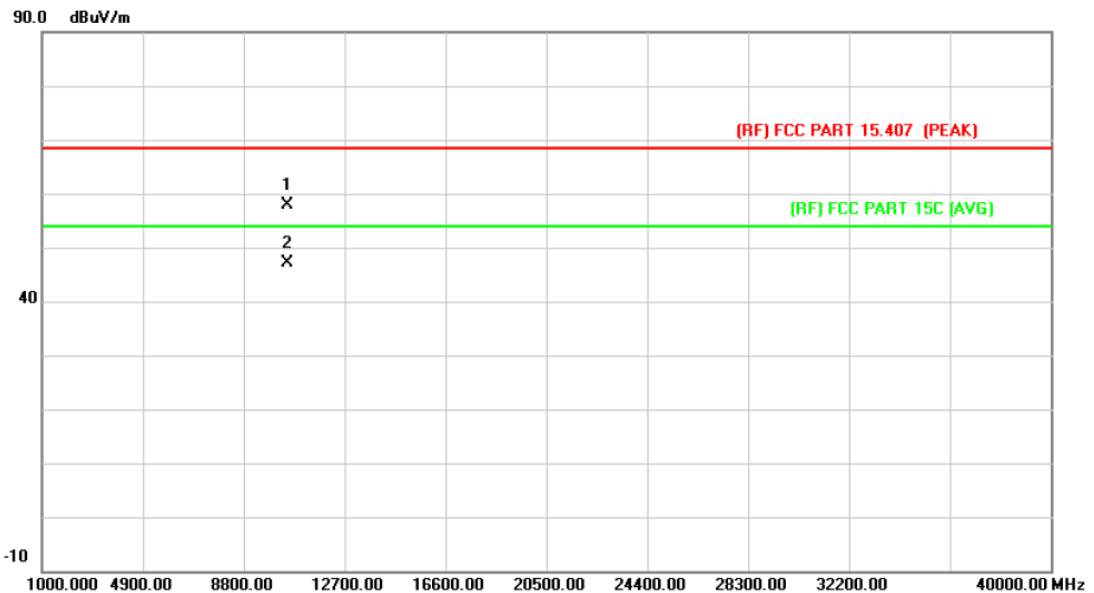

No.	Mk.	Freq. MHz	Reading Level dBuV	Correct Factor dB/m	Measure- ment dBuV/m	Limit dBuV/m	Over dB	Detector
1		10480.365	37.19	20.68	57.87	68.30	-10.43	peak
2	*	10480.365	26.45	20.68	47.13	54.00	-6.87	AVG

Emission Level= Read Level+ Correct Factor

Note:

1. Emission Level= Read Level+ Correct Factor
2. The emission levels of other frequencies are very lower than the limit and not show in test report.
3. Measurements were conducted from 1 GHz to the 10th harmonic of highest fundamental frequency.
4. Data of measurement shown "----" in the above table mean that the reading of emissions is attenuated more than 20 dB below the limits or the field strength is too small to be measured.
5. All modes are tested, showing only the worst patterns in the report.

Test Mode: U-NII 3 & 802.11a Mode

5745MHz-5825MHz(U-NII-3)

Temperature:	25 °C	Relative Humidity:	55%
Test Voltage:	AC 120V/60Hz		
Ant. Pol.	Horizontal		
Test Mode:	TX 802.11a Mode 5745MHz (U-NII-3)		
Remark:	No report for the emission which more than 10 dB below the prescribed limit.		

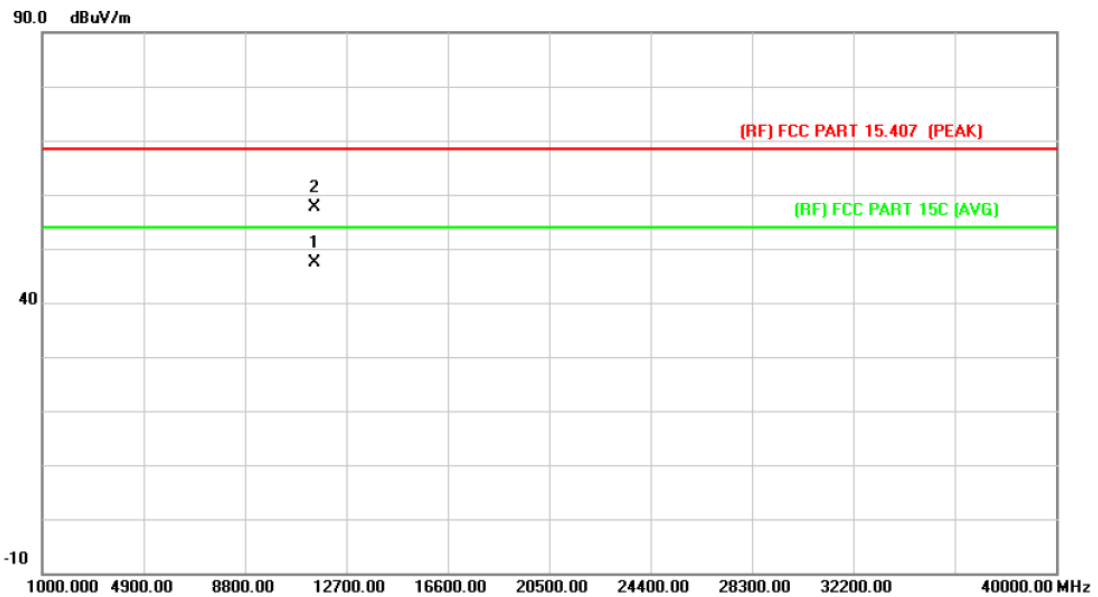

No.	Mk.	Freq.	Reading Level	Correct Factor	Measurement	Limit	Over	Detector
		MHz	dBuV	dB/m	dBuV/m	dBuV/m	dB	
1	*	11490.003	25.65	21.81	47.46	54.00	-6.54	AVG
2		11490.038	35.93	21.81	57.74	68.30	-10.56	peak

Emission Level= Read Level+ Correct Factor

Temperature:	25 °C	Relative Humidity:	55%
Test Voltage:	AC 120V/60Hz		
Ant. Pol.	Vertical		
Test Mode:	TX 802.11a Mode 5745MHz (U-NII-3)		
Remark:	No report for the emission which more than 10 dB below the prescribed limit.		

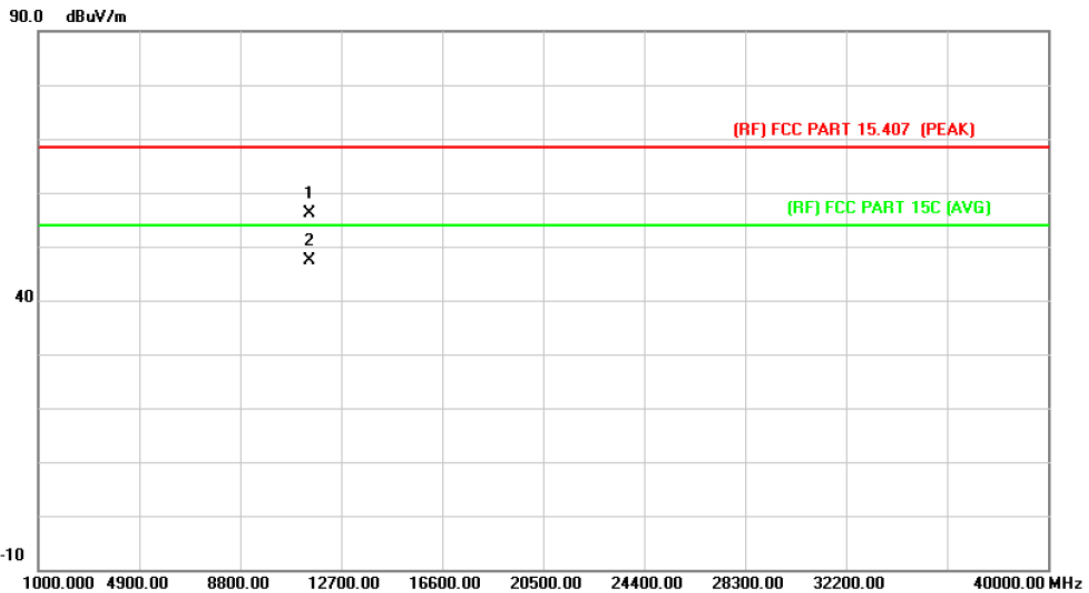

No.	Mk.	Freq. MHz	Reading Level dBuV	Correct Factor dB/m	Measure- ment dBuV/m	Limit dBuV/m	Over dB	Detector
1		11489.975	34.38	21.81	56.19	68.30	-12.11	peak
2	*	11489.975	25.51	21.81	47.32	54.00	-6.68	AVG

Emission Level= Read Level+ Correct Factor

Temperature:	25 °C	Relative Humidity:	55%
Test Voltage:	AC 120V/60Hz		
Ant. Pol.	Horizontal		
Test Mode:	TX 802.11a Mode 5785MHz (U-NII-3)		
Remark:	No report for the emission which more than 10 dB below the prescribed limit.		

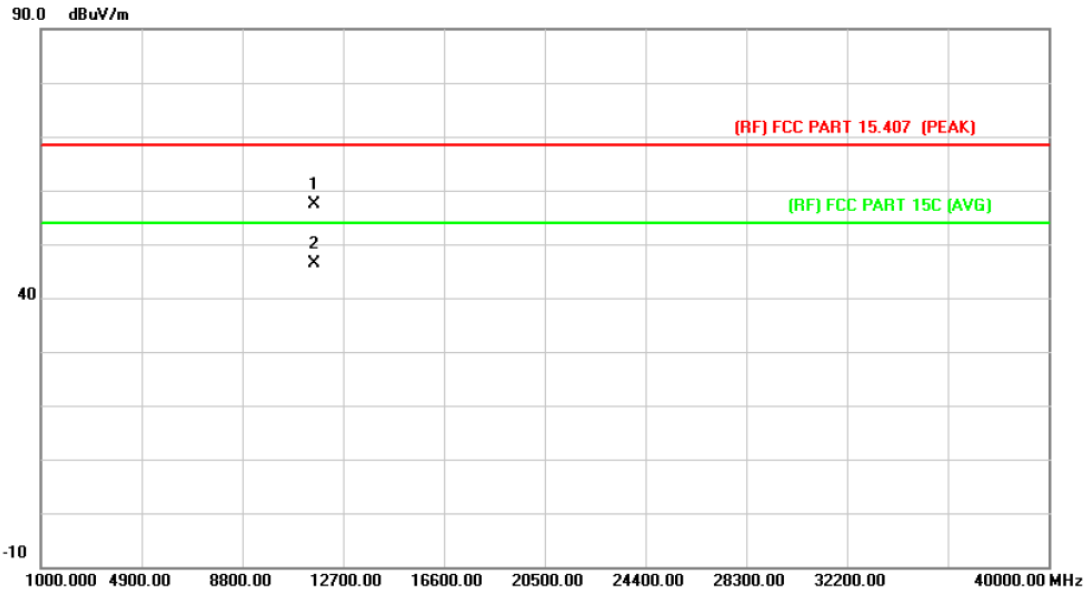

No.	Mk.	Freq. MHz	Reading Level dBuV	Correct Factor dB/m	Measure- ment dBuV/m	Limit dBuV/m	Over dB	Detector
1		11569.892	35.59	21.88	57.47	68.30	-10.83	peak
2	*	11569.987	24.48	21.88	46.36	54.00	-7.64	AVG

Emission Level= Read Level+ Correct Factor

Temperature:	25 °C	Relative Humidity:	55%
Test Voltage:	AC 120V/60Hz		
Ant. Pol.	Vertical		
Test Mode:	TX 802.11a Mode 5785MHz (U-NII-3)		
Remark:	No report for the emission which more than 10 dB below the prescribed limit.		

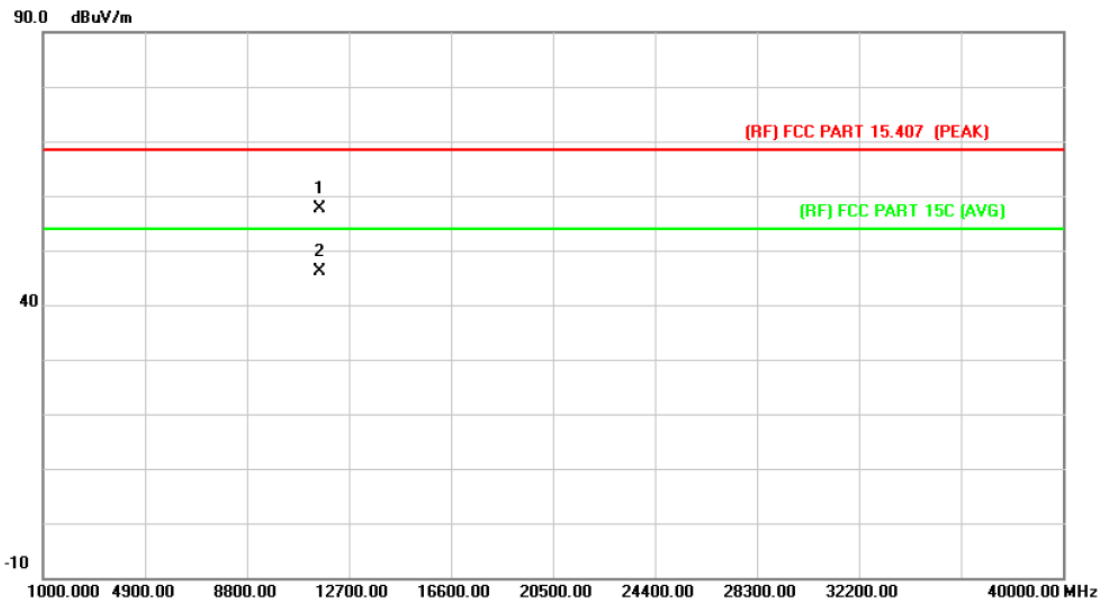

No.	Mk.	Freq. MHz	Reading Level dBuV	Correct Factor dB/m	Measure- ment dBuV/m	Limit dBuV/m	Over dB	Detector
1		11569.532	35.76	21.88	57.64	68.30	-10.66	peak
2	*	11570.272	24.25	21.88	46.13	54.00	-7.87	AVG

Emission Level= Read Level+ Correct Factor

Temperature:	25 °C	Relative Humidity:	55%
Test Voltage:	AC 120V/60Hz		
Ant. Pol.	Horizontal		
Test Mode:	TX 802.11a Mode 5825MHz (U-NII-3)		
Remark:	No report for the emission which more than 10 dB below the prescribed limit.		

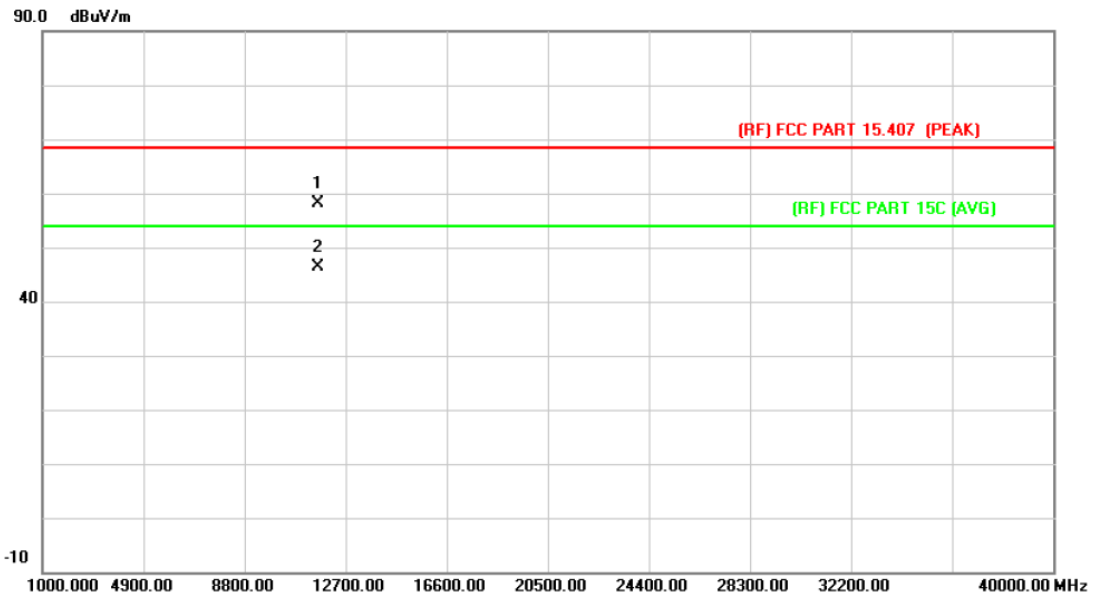

No.	Mk.	Freq. MHz	Reading Level dBuV	Correct Factor dB/m	Measure- ment dBuV/m	Limit dBuV/m	Over dB	Detector
1		11649.917	36.21	21.96	58.17	68.30	-10.13	peak
2	*	11650.275	24.31	21.96	46.27	54.00	-7.73	AVG

Emission Level= Read Level+ Correct Factor

Temperature:	25 °C	Relative Humidity:	55%
Test Voltage:	AC 120V/60Hz		
Ant. Pol.	Vertical		
Test Mode:	TX 802.11a Mode 5825MHz (U-NII-3)		
Remark:	No report for the emission which more than 10 dB below the prescribed limit.		

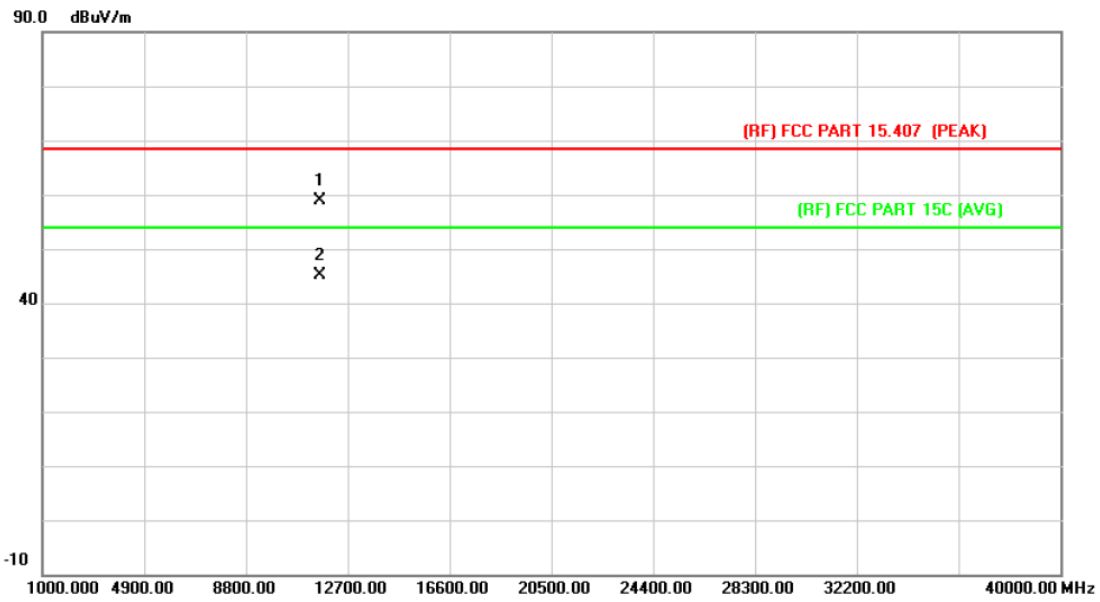

No.	Mk.	Freq. MHz	Reading Level dBuV	Correct Factor dB/m	Measure- ment dBuV/m	Limit dBuV/m	Over dB	Detector
1		11649.555	36.96	21.96	58.92	68.30	-9.38	peak
2	*	11649.795	23.23	21.96	45.19	54.00	-8.81	AVG

Emission Level= Read Level+ Correct Factor

Note:

6. Emission Level= Read Level+ Correct Factor
7. The emission levels of other frequencies are very lower than the limit and not show in test report.
8. Measurements were conducted from 1 GHz to the 10th harmonic of highest fundamental frequency.
9. Data of measurement shown “---“in the above table mean that the reading of emissions is attenuated more than 20 dB below the limits or the field strength is too small to be measured.
10. All modes are tested, showing only the worst patterns in the report.

Attachment C-- Band Edge Emissions Test Data

(1) Radiation Test a/n(20)

Temperature:	25 °C	Relative Humidity:	55%
Test Voltage:	AC 120V/60Hz		
Ant. Pol.	Horizontal		
Test Mode:	TX 802.11a Mode 5180 MHz (U-NII-1)		
Remark:	TX 802.11a Mode 5180~5240 MHz (U-NII-1) Low		

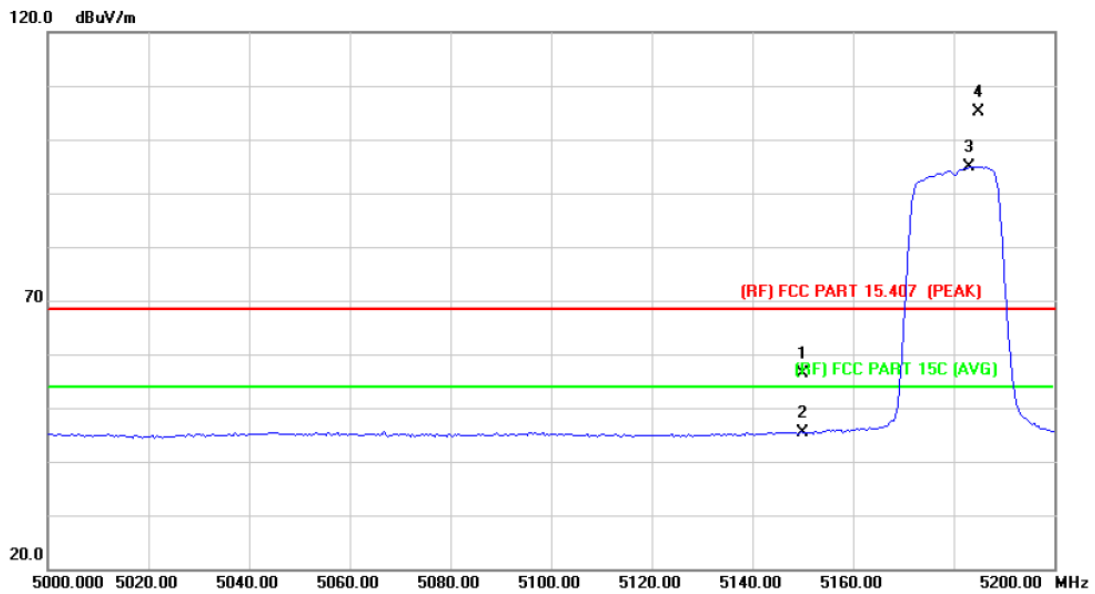

No.	Mk.	Freq. MHz	Reading Level dBuV	Correct Factor dB/m	Measure- ment dBuV/m	Limit dBuV/m	Over dB	Detector
1		5150.000	39.67	16.61	56.28	68.30	-12.02	peak
2		5150.000	28.77	16.61	45.38	54.00	-8.62	AVG
3	*	5183.200	78.19	16.65	94.84	Fundamental Frequency		AVG
4	X	5184.800	88.44	16.65	105.09	Fundamental Frequency		peak

Emission Level= Read Level+ Correct Factor

Temperature:	25 °C	Relative Humidity:	55%
Test Voltage:	AC 120V/60Hz		
Ant. Pol.	Vertical		
Test Mode:	TX 802.11a Mode 5180 MHz (U-NII-1)		
Remark:	TX 802.11a Mode 5180~5240 MHz (U-NII-1) CH Low		

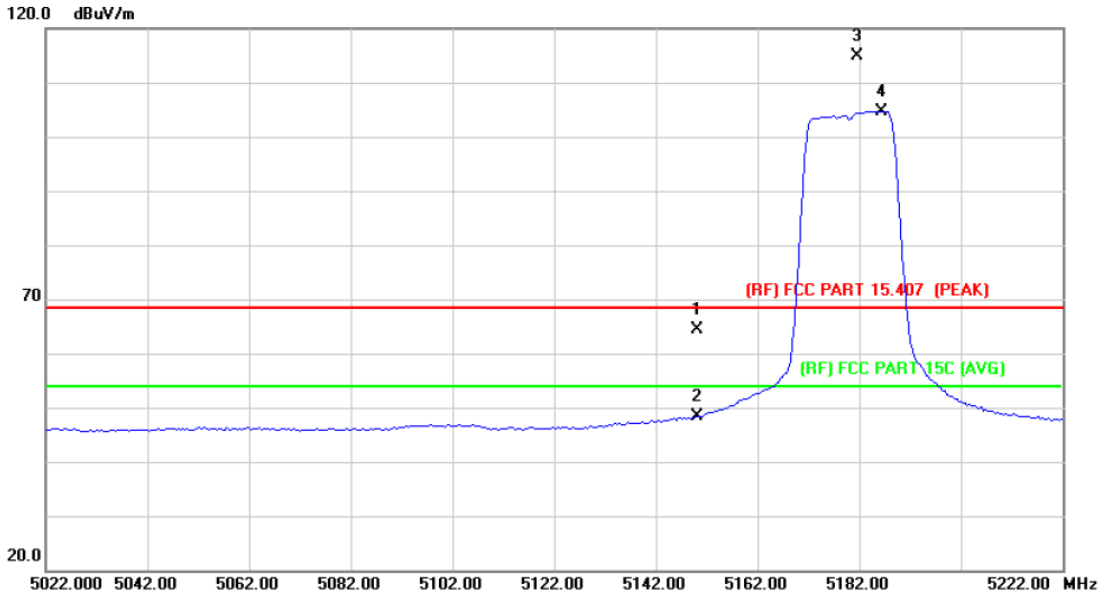

No.	Mk.	Freq.	Reading Level	Correct Factor	Measurement	Limit	Over	
		MHz	dBuV	dB/m	dBuV/m	dBuV/m	dB	Detector
1		5150.000	47.83	16.61	64.44	68.30	-3.86	peak
2		5150.000	31.67	16.61	48.28	54.00	-5.72	AVG
3	X	5181.600	98.27	16.64	114.91			Fundamental Frequency peak
4	*	5186.400	88.02	16.65	104.67			Fundamental Frequency AVG

Emission Level= Read Level+ Correct Factor

Temperature:	25 °C	Relative Humidity:	55%
Test Voltage:	AC 120V/60Hz		
Ant. Pol.	Horizontal		
Test Mode:	TX 802.11a Mode 5240 MHz (U-NII-1)		
Remark:	TX 802.11a Mode 5180~5240 MHz (U-NII-1) High		

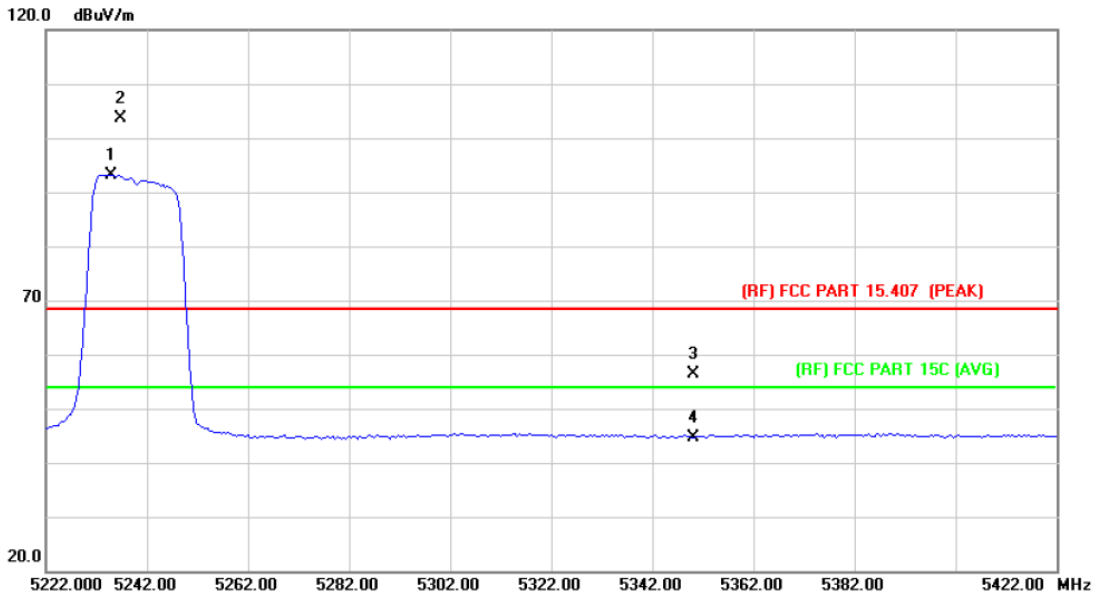

No.	Mk.	Freq. MHz	Reading Level dBuV	Correct Factor dB/m	Measure- ment dBuV/m	Limit dBuV/m	Over dB	Detector
1	*	5234.800	76.43	16.70	93.13	Fundamental Frequency		AVG
2	X	5236.800	86.99	16.70	103.69	Fundamental Frequency		peak
3		5350.000	39.56	16.83	56.39	68.30	-11.91	peak
4		5350.000	27.89	16.83	44.72	54.00	-9.28	AVG

Emission Level= Read Level+ Correct Factor

Temperature:	25 °C	Relative Humidity:	55%
Test Voltage:	AC 120V/60Hz		
Ant. Pol.	Vertical		
Test Mode:	TX 802.11a Mode 5240 MHz (U-NII-1)		
Remark:	TX 802.11a Mode 5180~5240 MHz (U-NII-1) CH High		

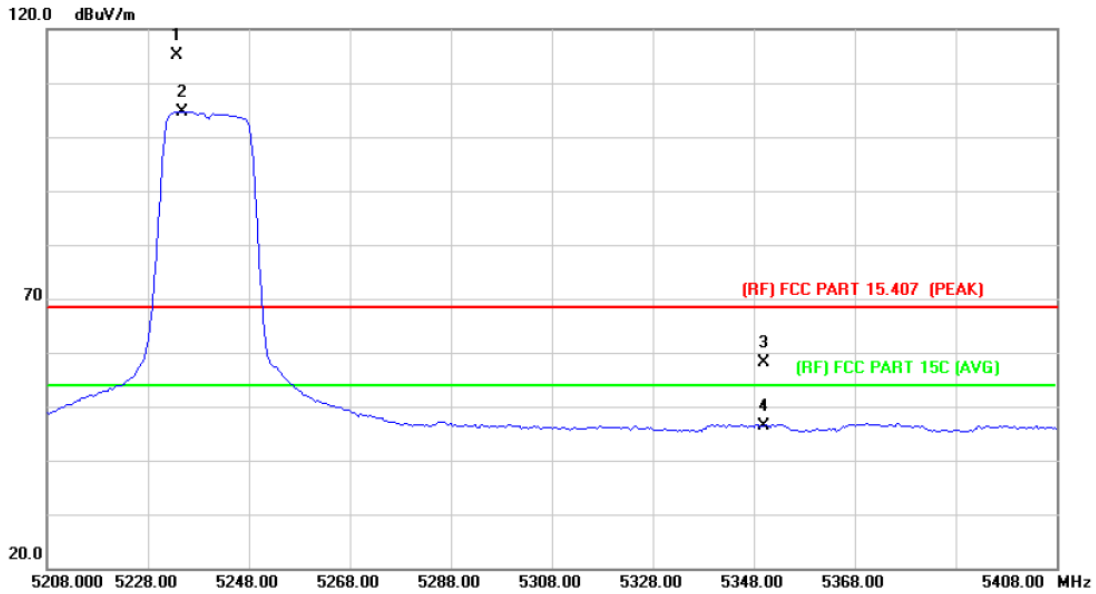

No.	Mk.	Freq. MHz	Reading Level dBuV	Correct Factor dB/m	Measure- ment dBuV/m	Limit dBuV/m	Over dB	Detector
1	X	5233.600	98.36	16.70	115.06	Fundamental Frequency		peak
2	*	5234.800	87.95	16.70	104.65	Fundamental Frequency		AVG
3		5350.000	41.22	16.83	58.05	68.30	-10.25	peak
4		5350.000	29.64	16.83	46.47	54.00	-7.53	AVG

Emission Level= Read Level+ Correct Factor

Temperature:	25 °C	Relative Humidity:	55%
Test Voltage:	AC 120V/60Hz		
Ant. Pol.	Horizontal		
Test Mode:	TX 802.11n(HT20) Mode 5180 MHz (U-NII-1)		
Remark:			

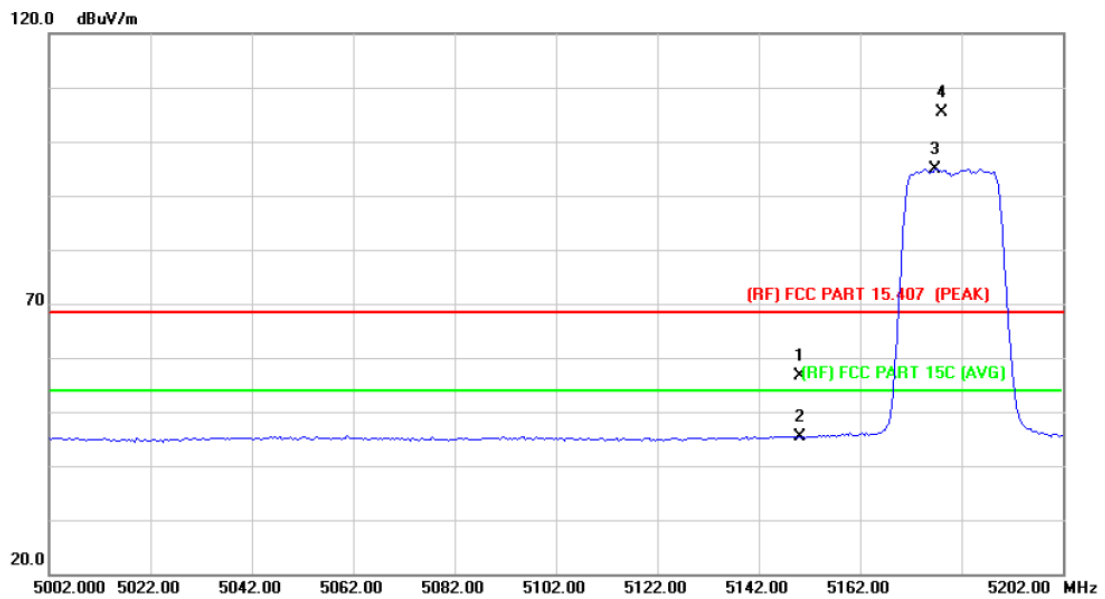

No.	Mk.	Freq.	Reading Level	Correct Factor	Measurement	Limit	Over	Detector
		MHz	dBuV	dB/m	dBuV/m	dBuV/m	dB	
1		5150.000	39.97	16.61	56.58	68.30	-11.72	peak
2		5150.000	28.70	16.61	45.31	54.00	-8.69	AVG
3	*	5176.800	78.22	16.64	94.86	Fundamental Frequency		AVG
4	X	5178.000	88.75	16.65	105.40	Fundamental Frequency		peak

Emission Level= Read Level+ Correct Factor

Temperature:	25 °C	Relative Humidity:	55%
Test Voltage:	AC 120V/60Hz		
Ant. Pol.	Vertical		
Test Mode:	TX 802.11n(HT20) Mode 5180 MHz (U-NII-1)		
Remark:			

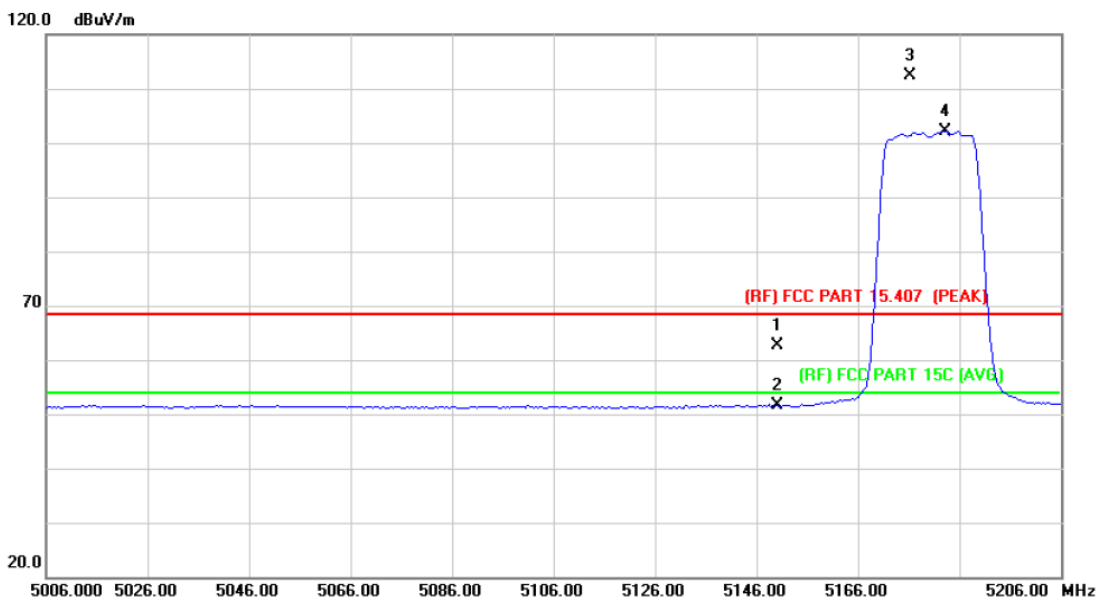

No.	Mk.	Freq. MHz	Reading Level dBuV	Correct Factor dB/m	Measure- ment dBuV/m	Limit dBuV/m	Over dB	Detector
1		5150.000	46.14	16.61	62.75	68.30	-5.55	peak
2		5150.000	34.94	16.61	51.55	54.00	-2.45	AVG
3	X	5176.400	95.67	16.64	112.31	Fundamental Frequency		peak
4	*	5183.200	85.48	16.65	102.13	Fundamental Frequency		AVG

Emission Level= Read Level+ Correct Factor

Temperature:	25 °C	Relative Humidity:	55%
Test Voltage:	AC 120V/60Hz		
Ant. Pol.	Horizontal		
Test Mode:	TX 802.11n(HT20) Mode 5240 MHz (U-NII-1)		
Remark:			

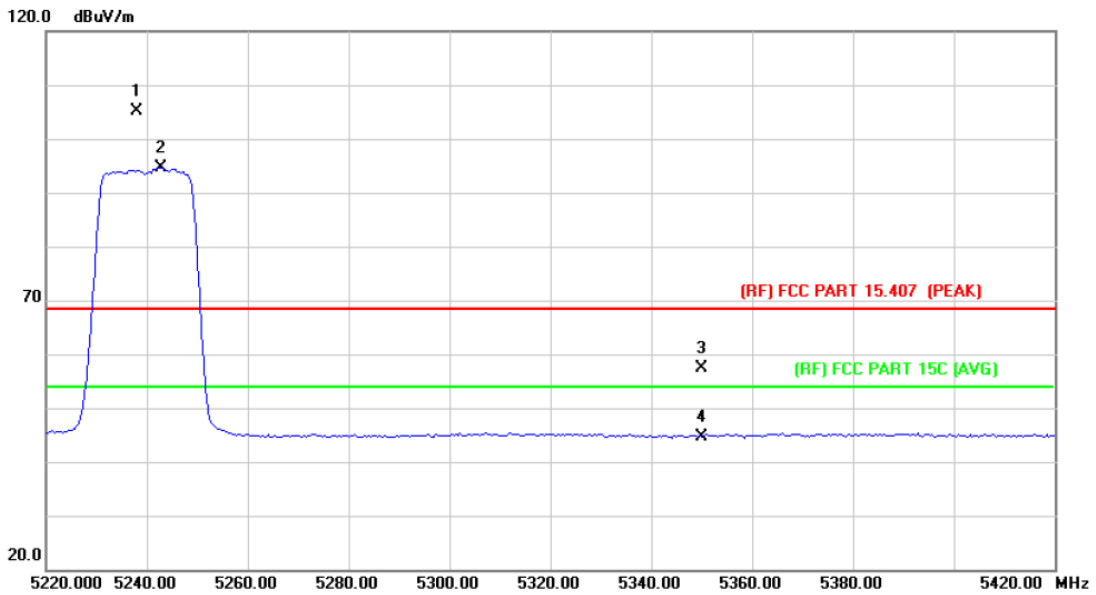

No.	Mk.	Freq. MHz	Reading Level dBuV	Correct Factor dB/m	Measure- ment dBuV/m	Limit dBuV/m	Over dB	Detector
1	X	5238.000	88.40	16.70	105.10	Fundamental Frequency		peak
2	*	5242.800	77.87	16.72	94.59	Fundamental Frequency		AVG
3		5350.000	40.53	16.83	57.36	68.30	-10.94	peak
4		5350.000	27.79	16.83	44.62	54.00	-9.38	AVG

Emission Level= Read Level+ Correct Factor

Temperature:	25 °C	Relative Humidity:	55%
Test Voltage:	AC 120V/60Hz		
Ant. Pol.	Vertical		
Test Mode:	TX 802.11n(HT20) Mode 5240 MHz (U-NII-1)		
Remark:			

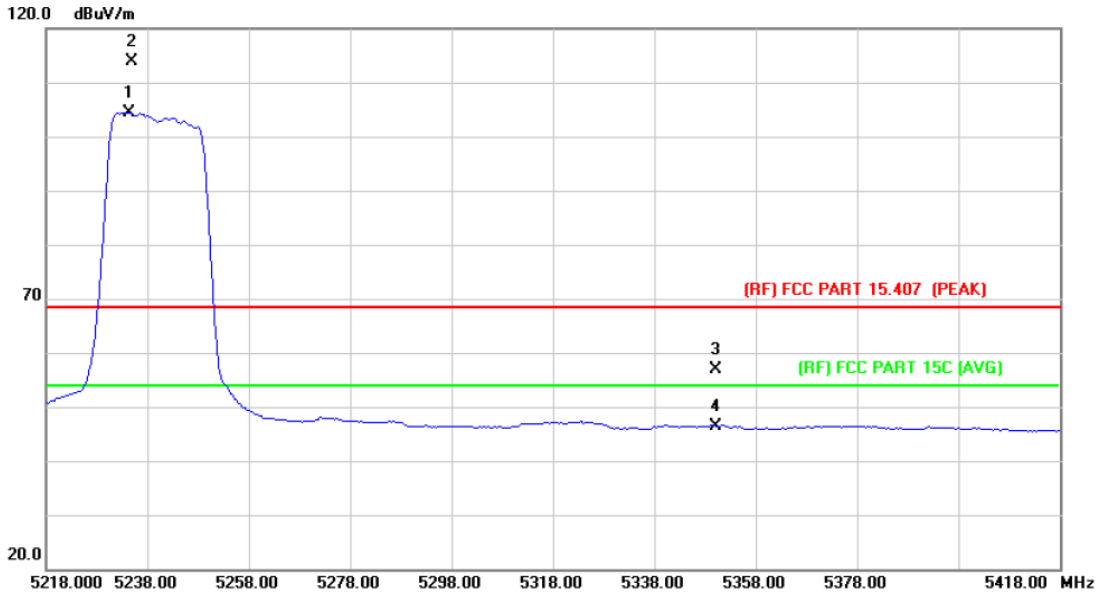

No.	Mk.	Freq. MHz	Reading Level dBuV	Correct Factor dB/m	Measure- ment dBuV/m	Limit dBuV/m	Over dB	Detector
1	*	5234.400	87.79	16.70	104.49	Fundamental Frequency		AVG
2	X	5234.800	97.24	16.70	113.94	Fundamental Frequency		peak
3		5350.000	39.96	16.83	56.79	68.30	-11.51	peak
4		5350.000	29.58	16.83	46.41	54.00	-7.59	AVG

Emission Level= Read Level+ Correct Factor

Temperature:	25 °C	Relative Humidity:	55%
Test Voltage:	AC 120V/60Hz		
Ant. Pol.	Horizontal		
Test Mode:	TX 802.11a Mode 5745 MHz (U-NII-3)		
Remark:	N/A		

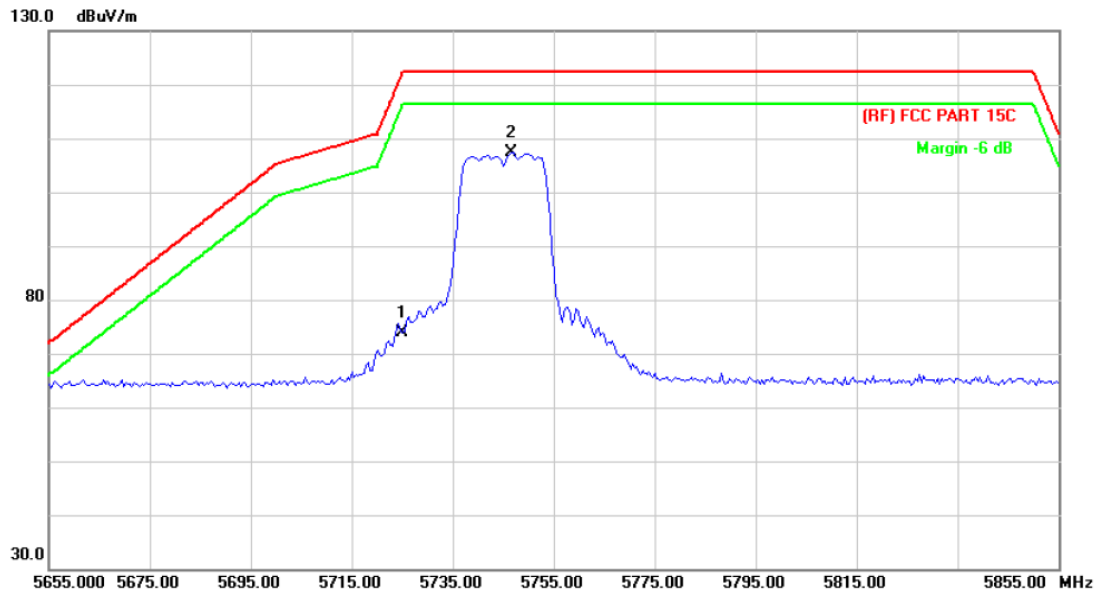

No.	Mk.	Freq. MHz	Reading Level dBuV	Correct Factor dB/m	Measure- ment dBuV/m	Limit dBuV/m	Over dB	Detector
1		5725.000	56.07	17.82	73.89	122.30	-48.41	peak
2	*	5746.600	89.42	17.90	107.32	122.30	-14.98	peak

Emission Level= Read Level+ Correct Factor

Temperature:	25 °C	Relative Humidity:	55%
Test Voltage:	AC 120V/60Hz		
Ant. Pol.	Vertical		
Test Mode:	TX 802.11a Mode 5745 MHz (U-NII-3)		
Remark:	N/A		

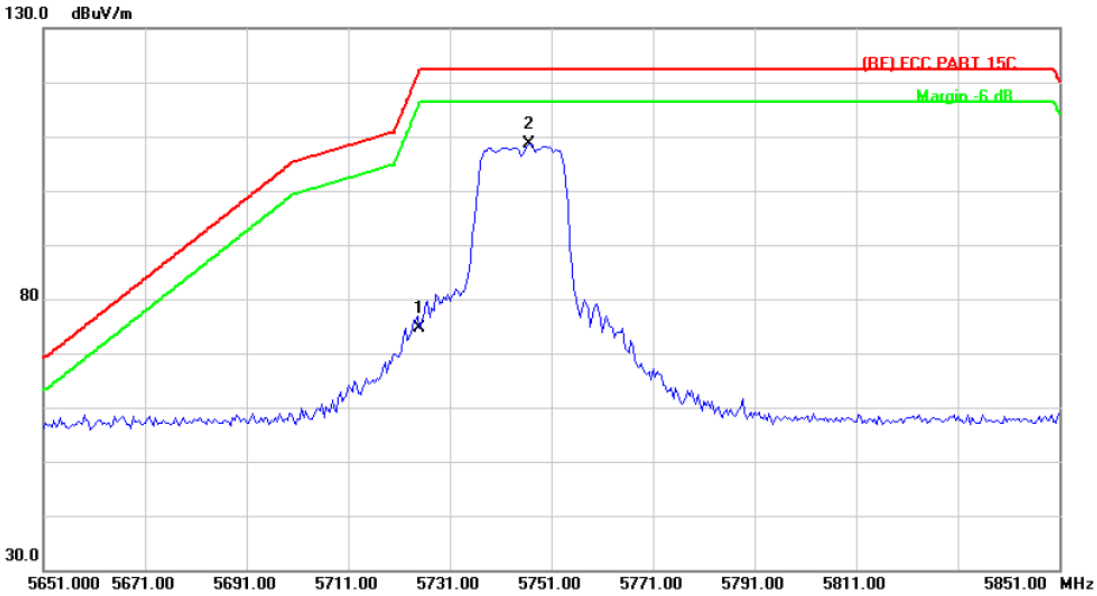

No.	Mk.	Freq. MHz	Reading Level dBuV	Correct Factor dB/m	Measure- ment dBuV/m	Limit dBuV/m	Over dB	Detector
1		5725.000	56.85	17.82	74.67	122.30	-47.63	peak
2	*	5746.600	90.67	17.90	108.57	122.30	-13.73	peak

Emission Level= Read Level+ Correct Factor

Temperature:	25 °C	Relative Humidity:	55%
Test Voltage:	AC 120V/60Hz		
Ant. Pol.	Horizontal		
Test Mode:	TX 802.11a Mode 5825 MHz (U-NII-3)		
Remark:	N/A		

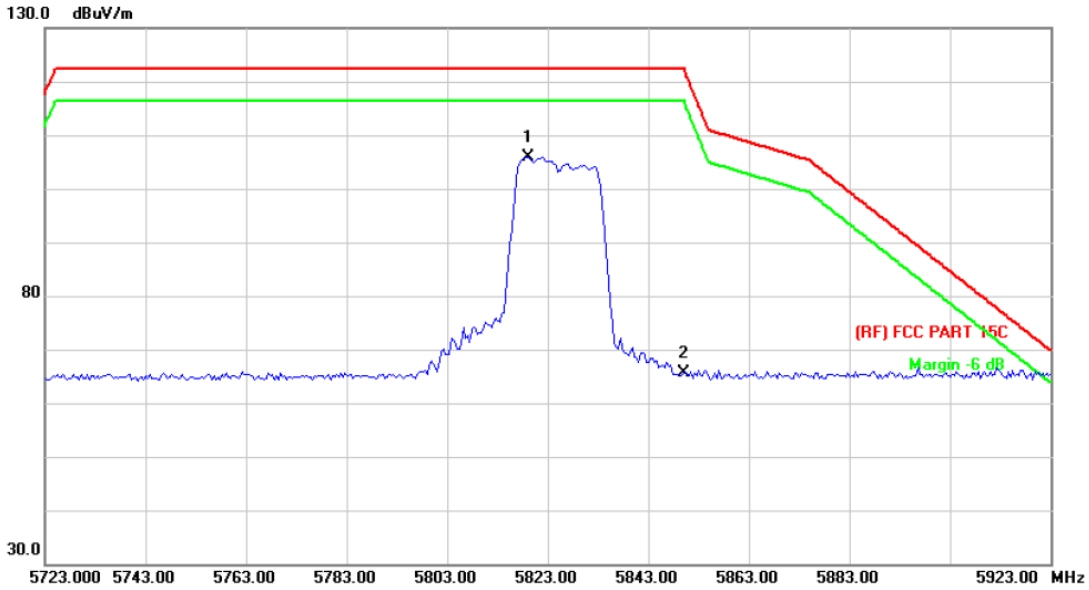

No.	Mk.	Freq. MHz	Reading Level dBuV	Correct Factor dB/m	Measure- ment dBuV/m	Limit dBuV/m	Over dB	Detector
1	*	5819.000	87.78	18.16	105.94	122.30	-16.36	peak
2		5850.000	47.47	18.28	65.75	122.30	-56.55	peak

Emission Level= Read Level+ Correct Factor

Temperature:	25 °C	Relative Humidity:	55%
Test Voltage:	AC 120V/60Hz		
Ant. Pol.	Vertical		
Test Mode:	TX 802.11a Mode 5825 MHz (U-NII-3)		
Remark:	N/A		

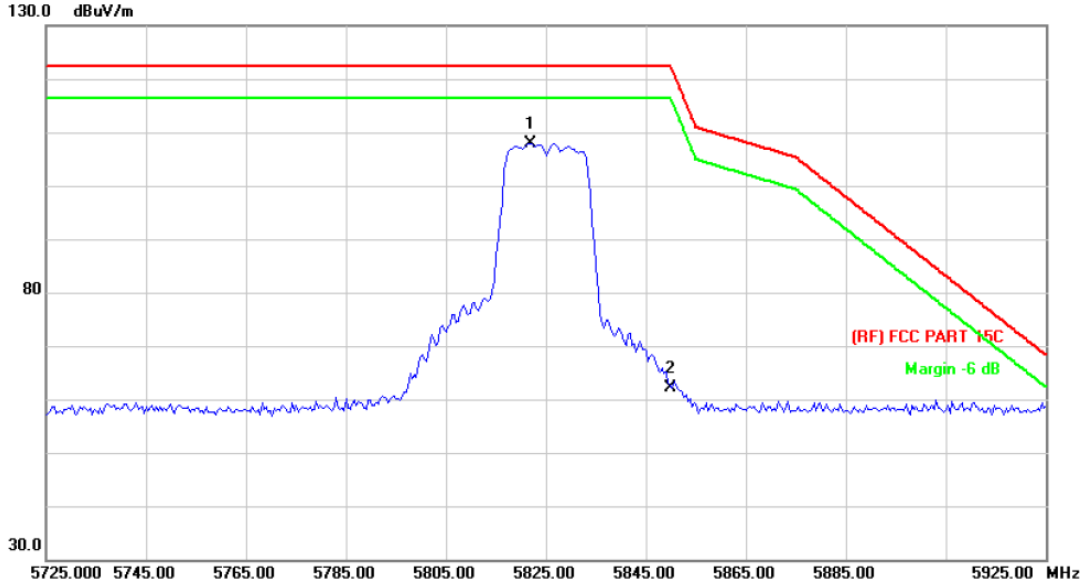

No.	Mk.	Freq. MHz	Reading Level dBuV	Correct Factor dB/m	Measure- ment dBuV/m	Limit dBuV/m	Over dB	Detector
1	*	5821.800	89.62	18.17	107.79	122.30	-14.51	peak
2		5850.000	43.79	18.28	62.07	122.30	-60.23	peak

Emission Level= Read Level+ Correct Factor

Temperature:	25 °C	Relative Humidity:	55%
Test Voltage:	AC 120V/60Hz		
Ant. Pol.	Horizontal		
Test Mode:	TX 802.11n(20) Mode 5745 MHz (U-NII-3)		
Remark:	N/A		

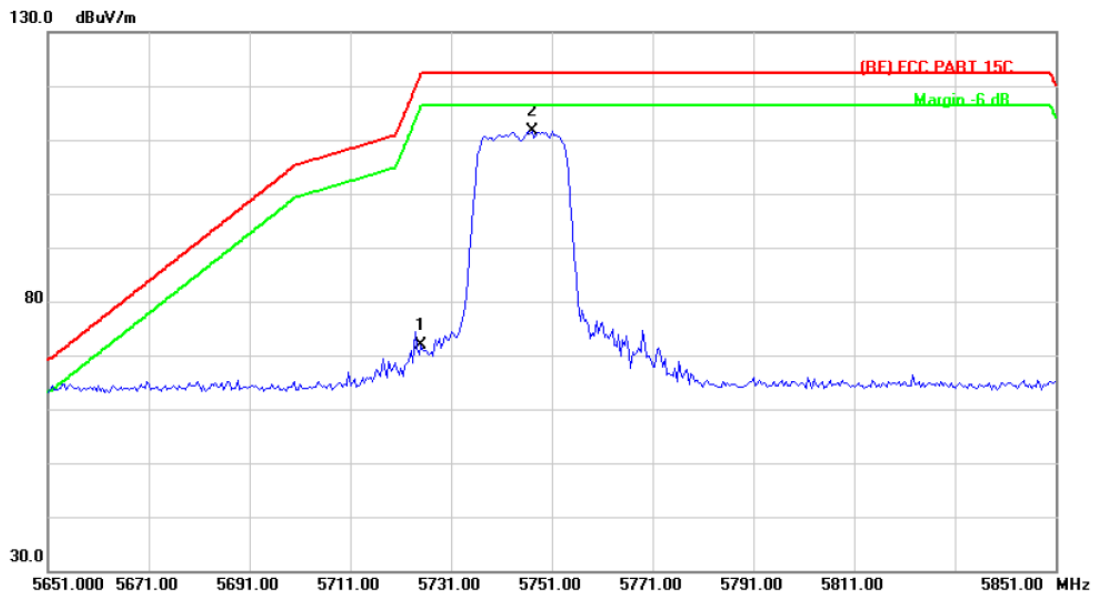

No.	Mk.	Freq. MHz	Reading Level dBuV	Correct Factor dB/m	Measure- ment dBuV/m	Limit dBuV/m	Over dB	Detector
1		5725.000	54.13	17.82	71.95	122.30	-50.35	peak
2	*	5747.000	93.80	17.90	111.70	122.30	-10.60	peak

Emission Level= Read Level+ Correct Factor

Temperature:	25 °C	Relative Humidity:	55%
Test Voltage:	AC 120V/60Hz		
Ant. Pol.	Vertical		
Test Mode:	TX 802.11n(20) Mode 5745 MHz (U-NII-3)		
Remark:	N/A		

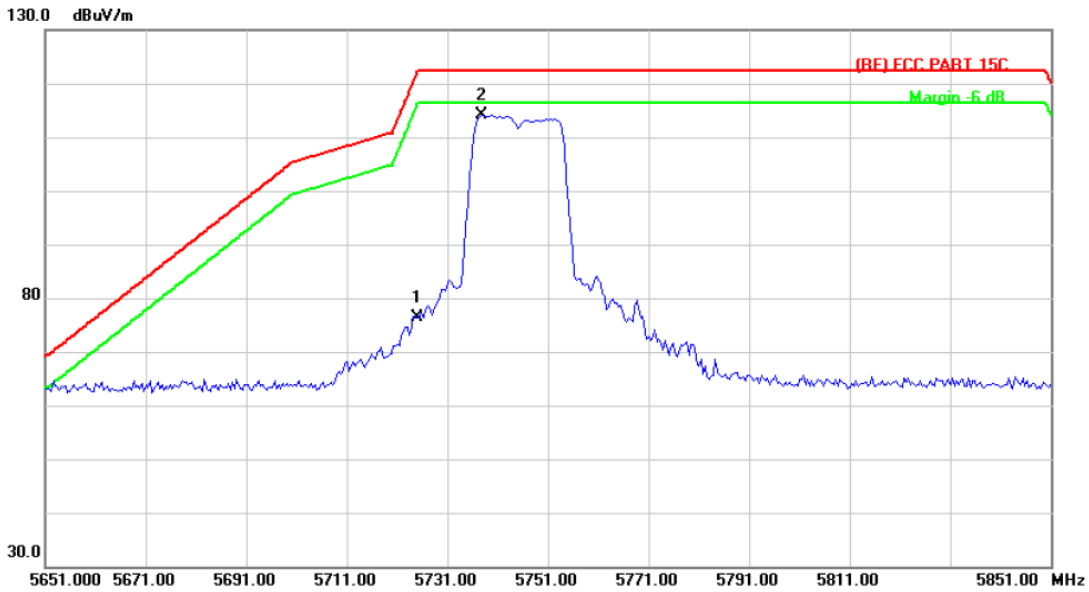

No.	Mk.	Freq. MHz	Reading Level dBuV	Correct Factor dB/m	Measure- ment dBuV/m	Limit dBuV/m	Over dB	Detector
1		5725.000	58.49	17.82	76.31	122.30	-45.99	peak
2	*	5737.800	96.31	17.87	114.18	122.30	-8.12	peak

Emission Level= Read Level+ Correct Factor

Temperature:	25 °C	Relative Humidity:	55%
Test Voltage:	AC 120V/60Hz		
Ant. Pol.	Horizontal		
Test Mode:	TX 802.11n(20) Mode 5825 MHz (U-NII-3)		
Remark:	N/A		

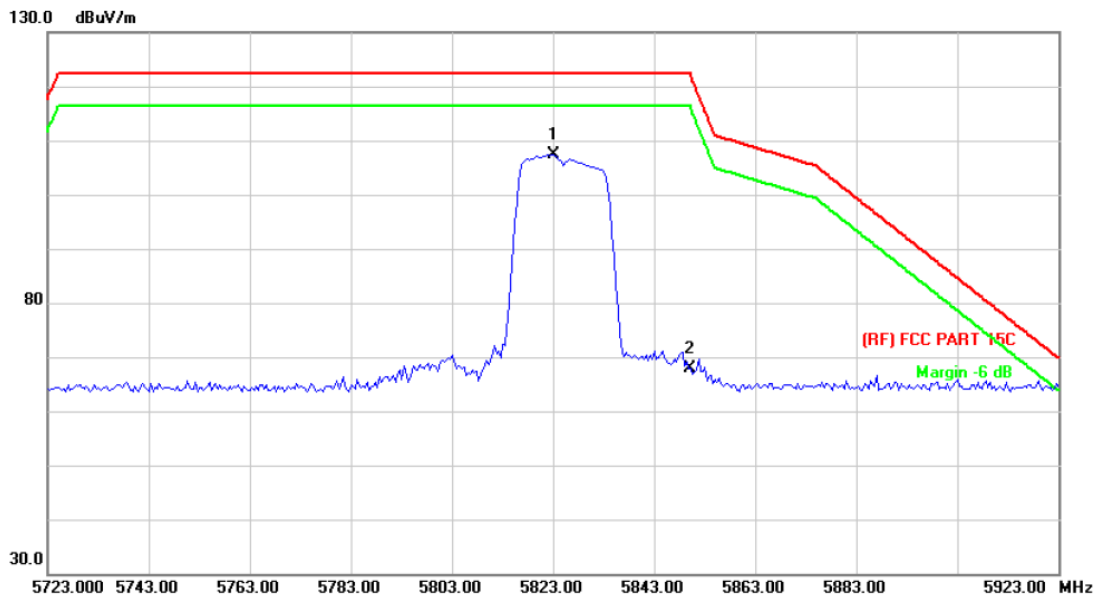

No.	Mk.	Freq. MHz	Reading Level dBuV	Correct Factor dB/m	Measure- ment dBuV/m	Limit dBuV/m	Over dB	Detector
1	*	5823.000	89.22	18.17	107.39	122.30	-14.91	peak
2		5850.000	49.56	18.28	67.84	122.30	-54.46	peak

Emission Level= Read Level+ Correct Factor

Temperature:	25 °C	Relative Humidity:	55%
Test Voltage:	AC 120V/60Hz		
Ant. Pol.	Vertical		
Test Mode:	TX 802.11n(20) Mode 5825 MHz (U-NII-3)		
Remark:	N/A		

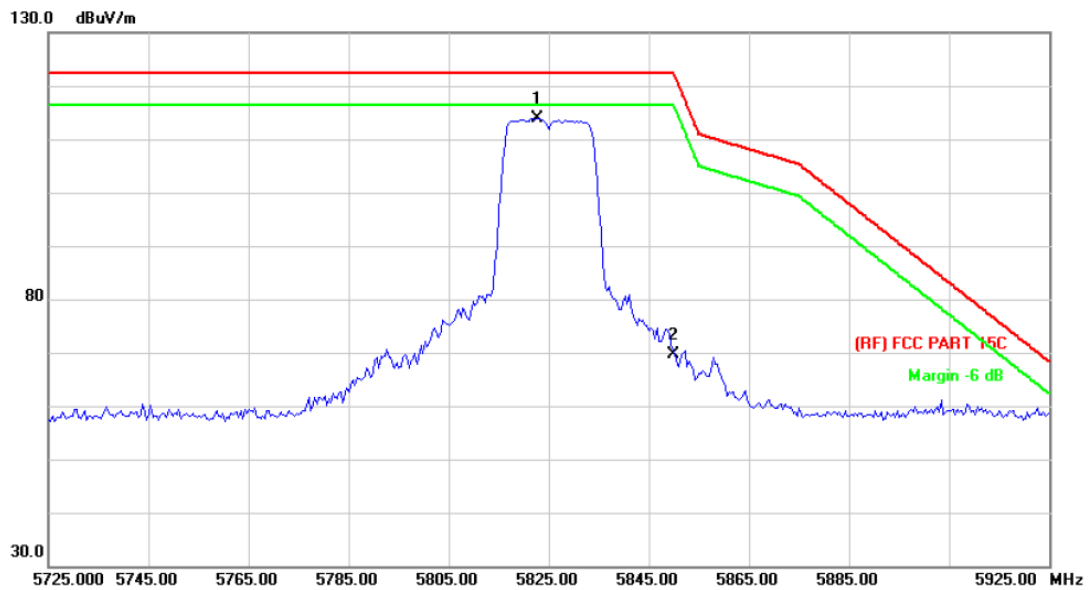

No.	Mk.	Freq. MHz	Reading Level dBuV	Correct Factor dB/m	Measure- ment dBuV/m	Limit dBuV/m	Over dB	Detector
1	*	5822.600	95.69	18.17	113.86	122.30	-8.44	peak
2		5850.000	51.27	18.28	69.55	122.30	-52.75	peak

Emission Level= Read Level+ Correct Factor

n(40)

Temperature:	25 °C	Relative Humidity:	55%
Test Voltage:	AC 120V/60Hz		
Ant. Pol.	Horizontal		
Test Mode:	TX 802.11n (40) Mode 5190 MHz (U-NII-1)		
Remark:	TX 802.11n (40) Mode 5190~5230 MHz (U-NII-1) CH Low		

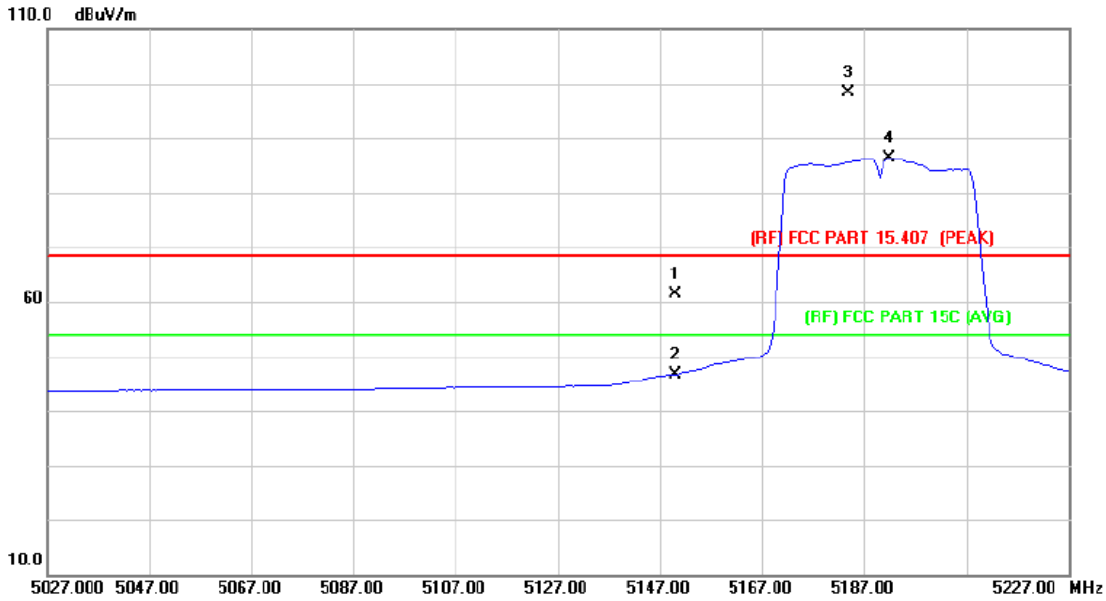

No.	Mk.	Freq. MHz	Reading Level dBuV	Correct Factor dB/m	Measure- ment dBuV/m	Limit dBuV/m	Over dB	Detector
1		5150.000	48.93	12.41	61.34	68.30	-6.96	peak
2		5150.000	34.28	12.41	46.69	54.00	-7.31	AVG
3	X	5184.000	86.01	12.48	98.49	Fundamental Frequency		peak
4	*	5192.000	73.86	12.48	86.34	Fundamental Frequency		AVG

Emission Level= Read Level+ Correct Factor

Temperature:	25 °C	Relative Humidity:	55%
Test Voltage:	AC 120V/60Hz		
Ant. Pol.	Vertical		
Test Mode:	TX 802.11n (40) Mode 5190 MHz (U-NII-1)		
Remark:	TX 802.11n (40) Mode 5190~5230 MHz (U-NII-1) CH Low		

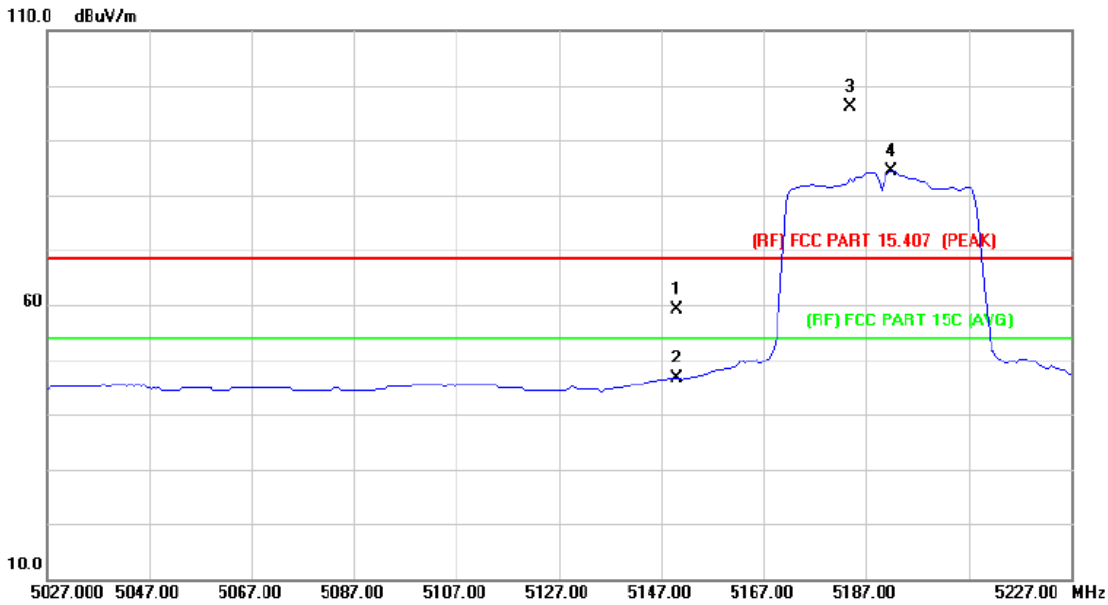

No.	Mk.	Freq.	Reading Level	Correct Factor	Measurement	Limit	Over	Detector
		MHz	dBuV	dB/m	dBuV/m	dBuV/m	dB	
1		5150.000	46.82	12.41	59.23	68.30	-9.07	peak
2		5150.000	34.30	12.41	46.71	54.00	-7.29	AVG
3	X	5184.000	83.67	12.48	96.15	Fundamental Frequency		peak
4	*	5192.000	71.86	12.48	84.34	Fundamental Frequency		AVG

Emission Level= Read Level+ Correct Factor

Temperature:	25 °C	Relative Humidity:	55%
Test Voltage:	AC 120V/60Hz		
Ant. Pol.	Horizontal		
Test Mode:	TX 802.11n (40) Mode 5230 MHz (U-NII-1)		
Remark:	TX 802.11n (40) Mode 5190~5230 MHz (U-NII-1) CH High		

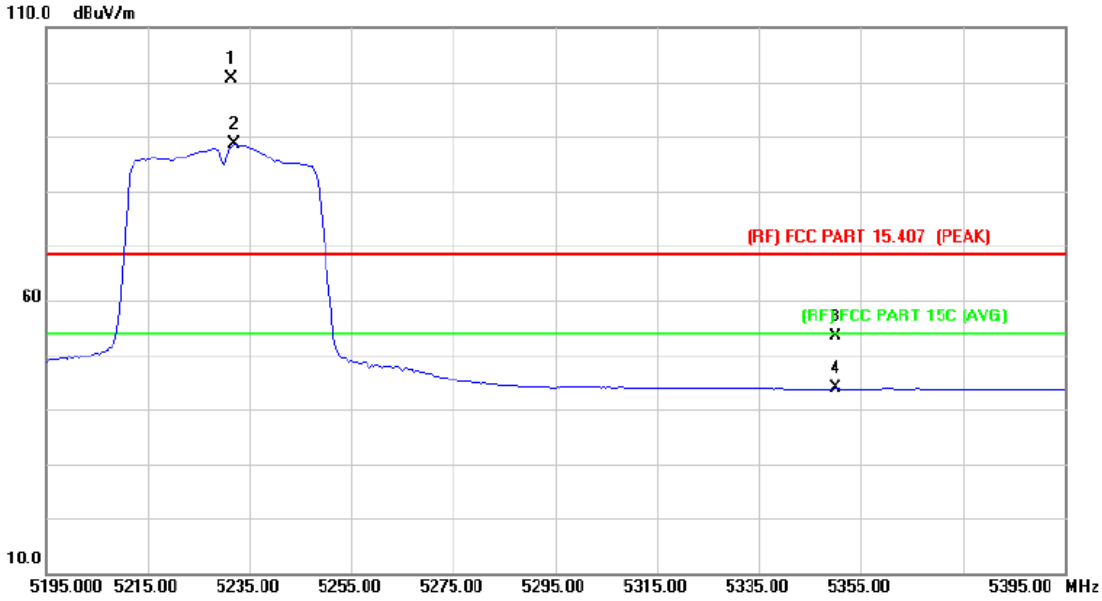

No.	Mk.	Freq. MHz	Reading Level dBuV	Correct Factor dB/m	Measure- ment dBuV/m	Limit dBuV/m	Over dB	Detector
1	X	5231.500	88.07	12.56	100.63	Fundamental Frequency		peak
2	*	5232.000	76.01	12.56	88.57	Fundamental Frequency		AVG
3		5350.000	40.52	12.78	53.30	68.30	-15.00	peak
4		5350.000	30.99	12.78	43.77	54.00	-10.23	AVG

Emission Level= Read Level+ Correct Factor

Temperature:	25 °C	Relative Humidity:	55%
Test Voltage:	AC 120V/60Hz		
Ant. Pol.	Vertical		
Test Mode:	TX 802.11n (40) Mode 5230 MHz (U-NII-1)		
Remark:	TX 802.11n (40) Mode 5190~5230 MHz (U-NII-1) CH High		

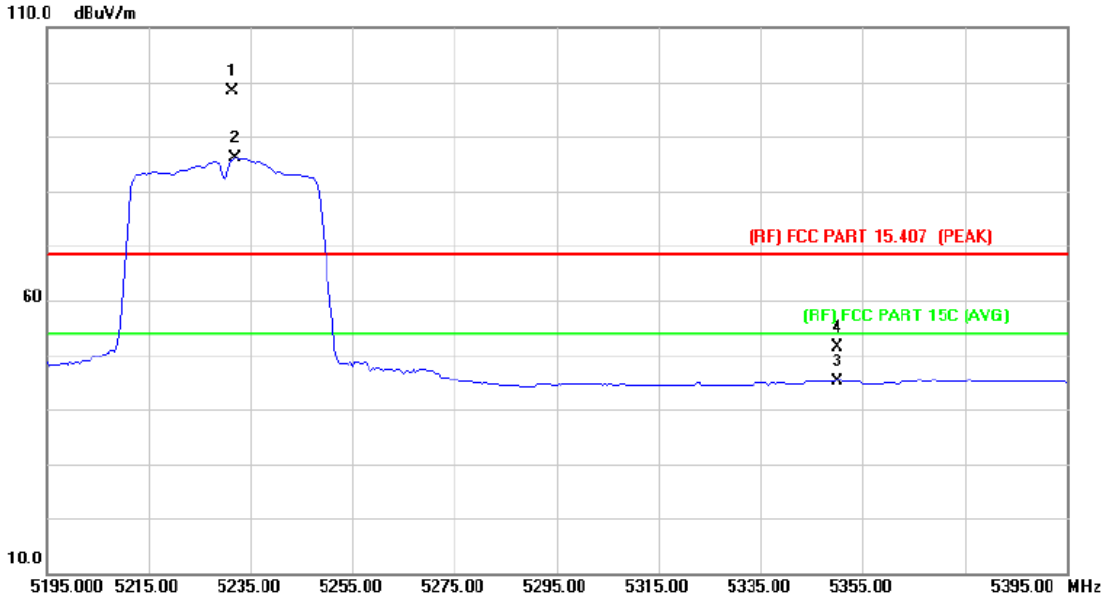

No.	Mk.	Freq. MHz	Reading Level dBuV	Correct Factor dB/m	Measure- ment dBuV/m	Limit dBuV/m	Over dB	Detector
1	*	5231.500	85.90	12.56	98.46	Fundamental Frequency		peak
2	X	5232.000	73.51	12.56	86.07	Fundamental Frequency		AVG
3		5350.000	32.38	12.78	45.16	54.00	-8.84	AVG
4		5350.000	38.53	12.78	51.31	68.30	-16.99	Peak

Emission Level= Read Level+ Correct Factor

Temperature:	25 °C	Relative Humidity:	55%
Test Voltage:	AC 120V/60Hz		
Ant. Pol.	Horizontal		
Test Mode:	TX 802.11n(40) Mode 5755MHz (U-NII-3)		
Remark:	N/A		

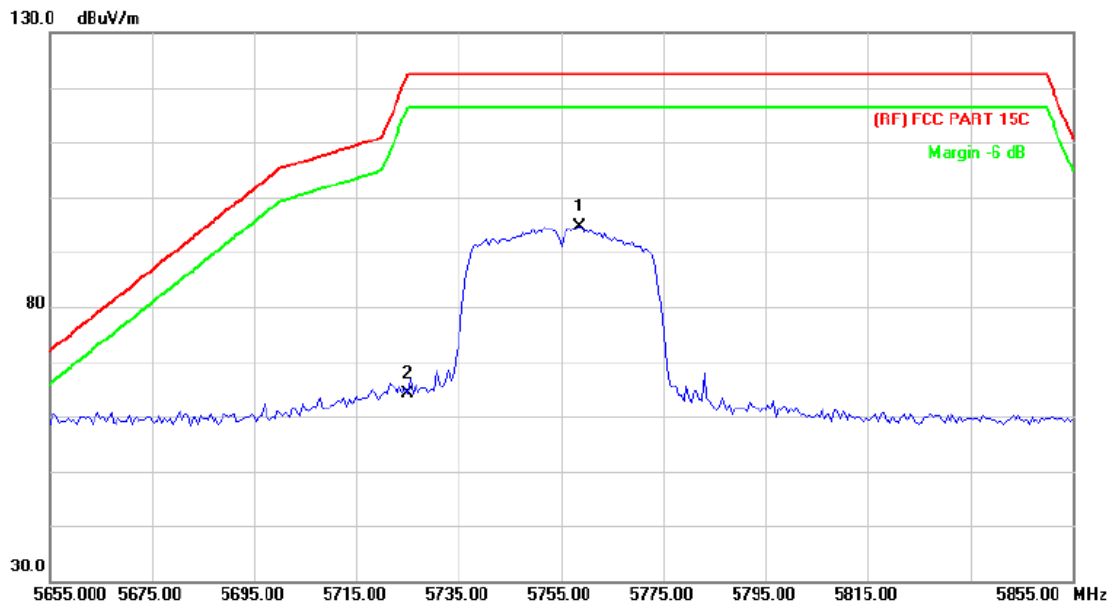

No.	Mk.	Freq. MHz	Reading Level dBuV	Correct Factor dB/m	Measure- ment dBuV/m	Limit dBuV/m	Over dB	Detector
1	*	5758.500	81.17	13.40	94.57	122.30	-27.73	peak
2		5725.000	50.75	13.36	64.11	122.30	-58.19	peak

Emission Level= Read Level+ Correct Factor

Temperature:	25 °C	Relative Humidity:	55%
Test Voltage:	AC 120V/60Hz		
Ant. Pol.	Vertical		
Test Mode:	TX 802.11n(40) Mode 5755MHz (U-NII-3)		
Remark:	N/A		

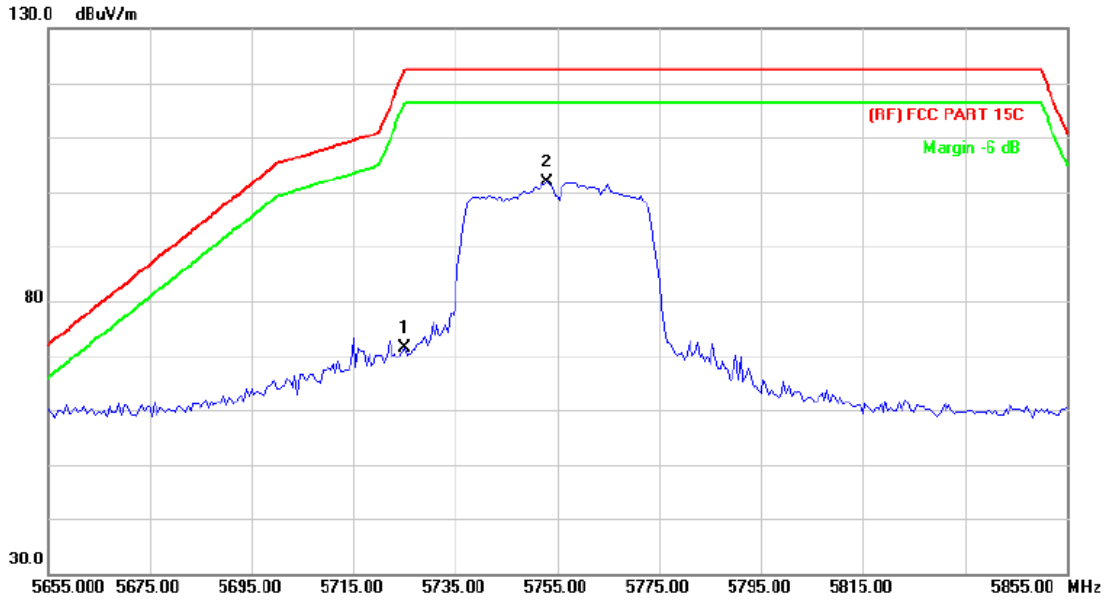

No.	Mk.	Freq.	Reading Level	Correct Factor	Measurement	Limit	Over	Detector
		MHz	dBuV	dB/m	dBuV/m	dBuV/m	dB	
1		5725.000	57.91	13.36	71.27	122.30	-51.03	peak
2	*	5753.000	88.44	13.40	101.84	122.30	-20.46	peak

Emission Level= Read Level+ Correct Factor

Temperature:	25 °C	Relative Humidity:	55%
Test Voltage:	AC 120V/60Hz		
Ant. Pol.	Horizontal		
Test Mode:	TX 802.11n(40) Mode 5795 MHz (U-NII-3)		
Remark:	N/A		

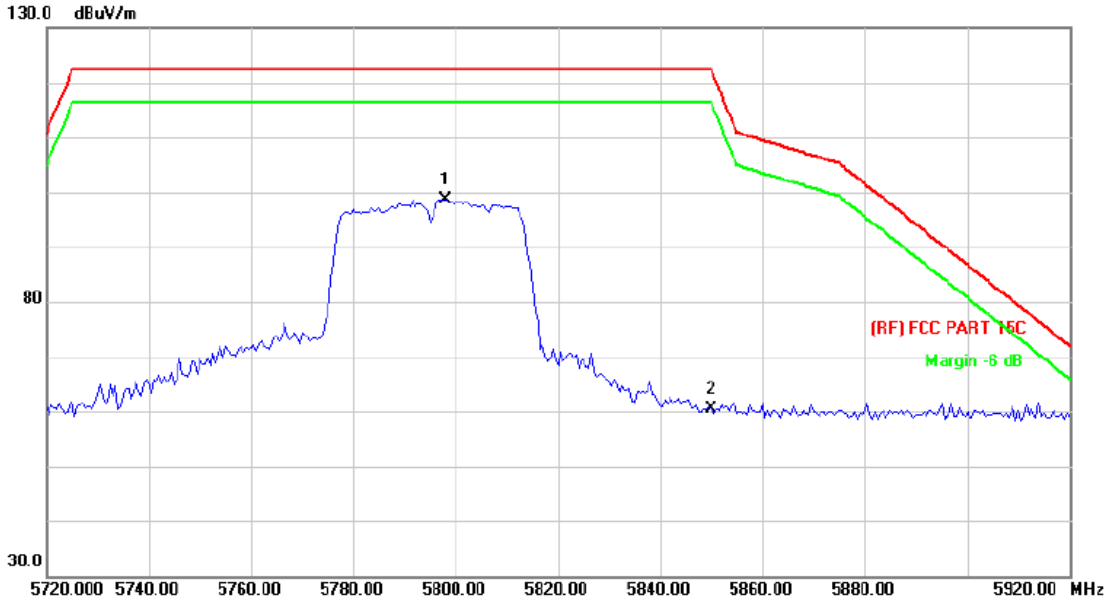

No.	Mk.	Freq. MHz	Reading Level dBuV	Correct Factor dB/m	Measure- ment dBuV/m	Limit dBuV/m	Over dB	Detector
1	*	5798.000	85.25	13.46	98.71	122.30	-23.59	peak
2		5850.000	46.93	13.54	60.47	122.30	-61.83	peak

Emission Level= Read Level+ Correct Factor

Temperature:	25 °C	Relative Humidity:	55%
Test Voltage:	AC 120V/60Hz		
Ant. Pol.	Vertical		
Test Mode:	TX 802.11n(40) Mode 5795 MHz (U-NII-3)		
Remark:	N/A		

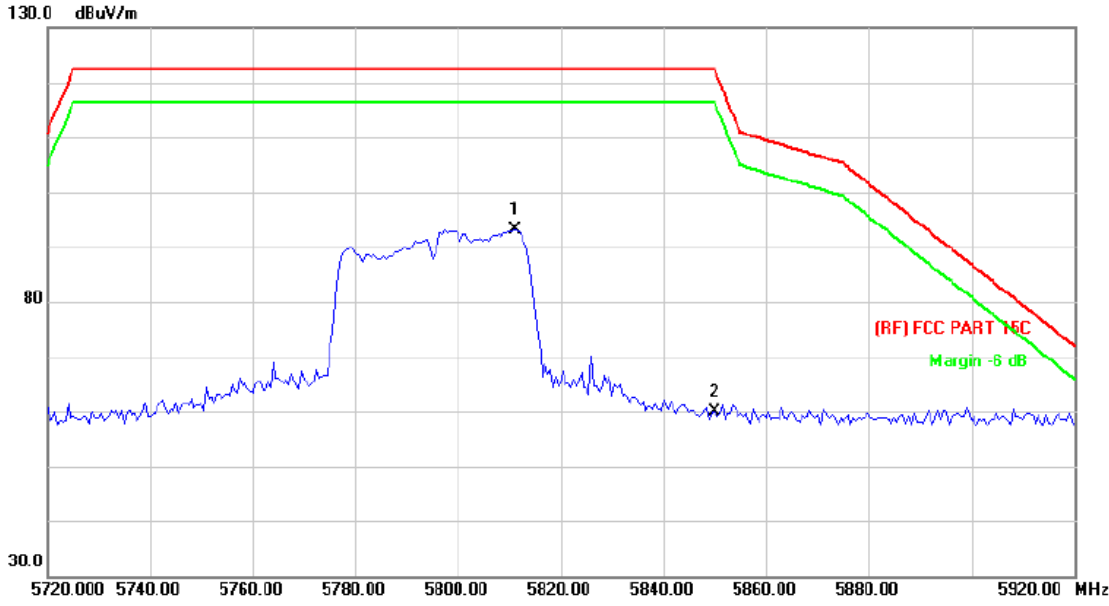

No.	Mk.	Freq.	Reading Level	Correct Factor	Measurement	Limit	Over	Detector
		MHz	dBuV	dB/m	dBuV/m	dBuV/m	dB	
1	*	5811.000	79.66	13.48	93.14	122.30	-29.16	peak
2		5850.000	46.22	13.54	59.76	122.30	-62.54	peak

Emission Level= Read Level+ Correct Factor

(2) Conducted Test

Temperature:	25 °C	Relative Humidity:	55%
Test Voltage:	AC 120V/60Hz		
Test Mode:	TX 802.11a mode(U-NII-1) / 5180 ~ 5240MHz CH Low-5180MHz TX 802.11a mode(U-NII-1) / 5180 ~ 5240MHz CH High-5240MHz		
Remark:	The EUT is programed in continuously transmitting mode		

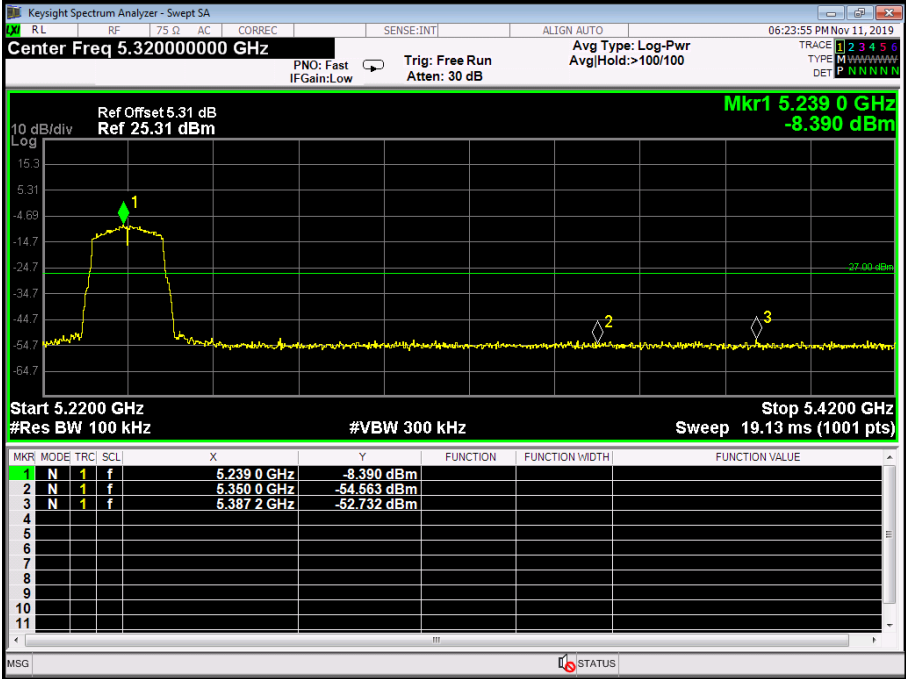
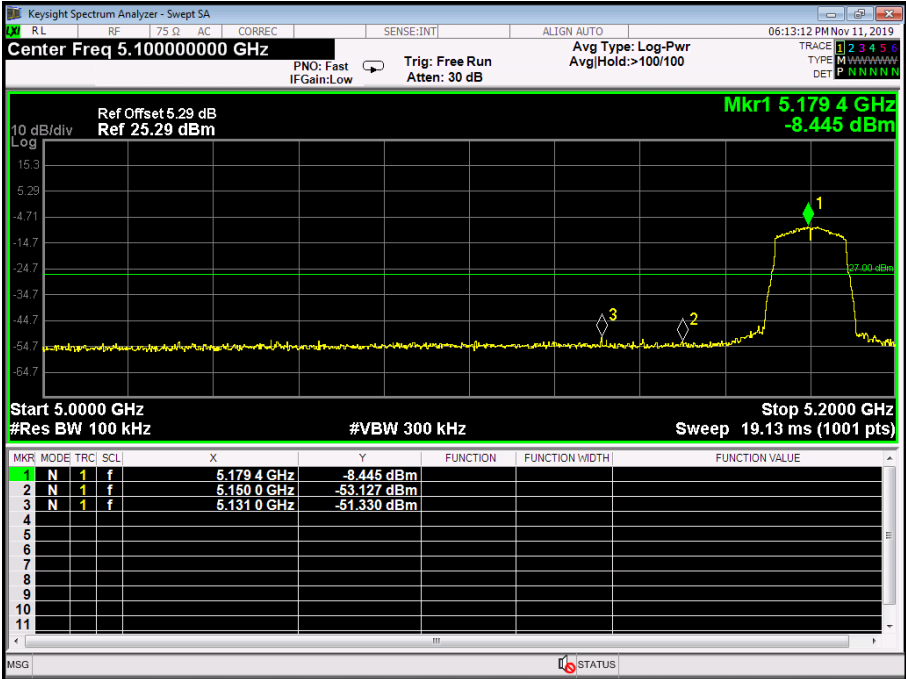

Temperature:	25 °C	Relative Humidity:	55%
Test Voltage:	AC 120V/60Hz		
Test Mode:	TX 802.11n(20) mode(U-NII-1) / 5180 ~ 5240MHz CH Low-5180MHz TX 802.11n(20) mode(U-NII-1) / 5180 ~ 5240MHz CH High-5240MHz		
Remark:	The EUT is programed in continuously transmitting mode		

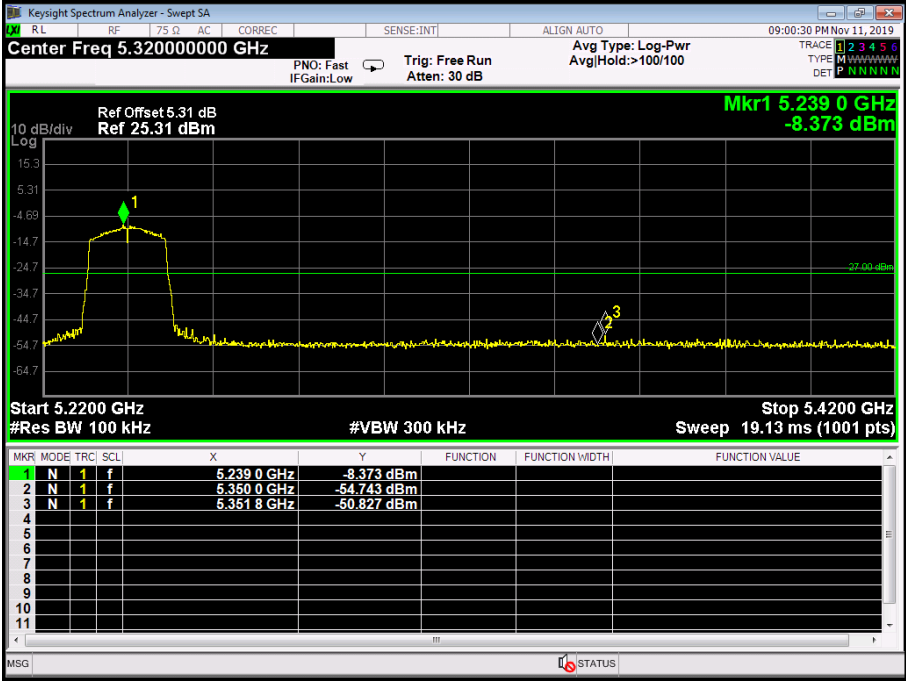
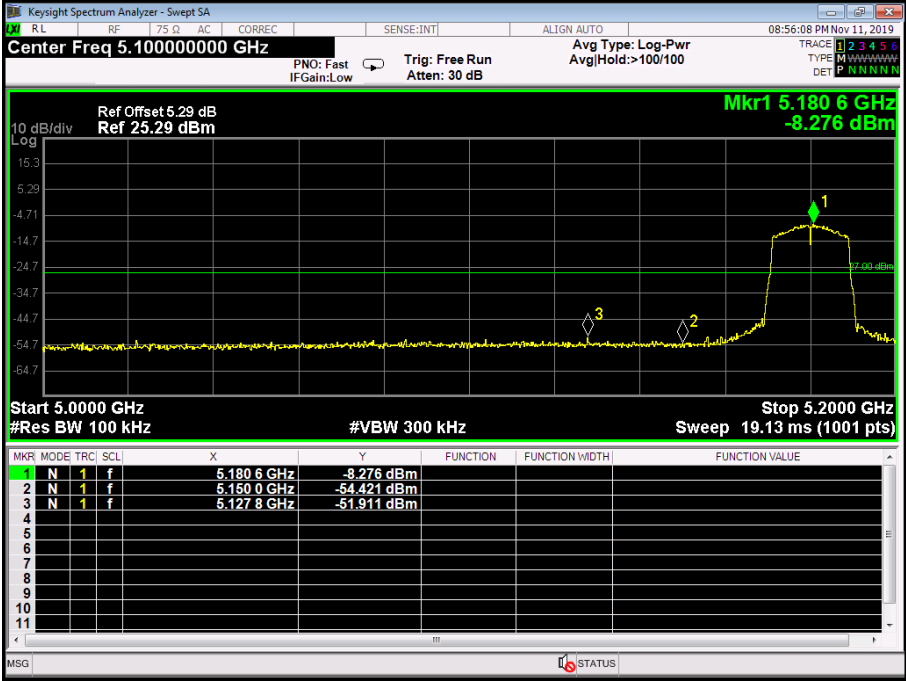

Temperature:	25 °C	Relative Humidity:	55%
Test Voltage:	AC 120V/60Hz		
Test Mode:	TX 802.11a Mode 5745MHz /5825MHz (U-NII-3)		
Remark:	The EUT is programed in continuously transmitting mode		

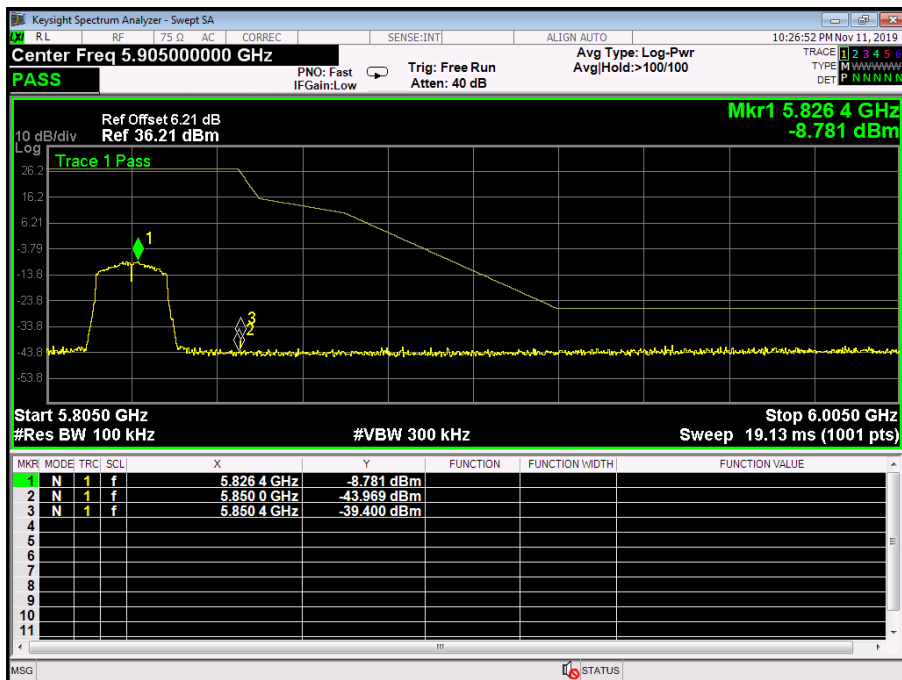
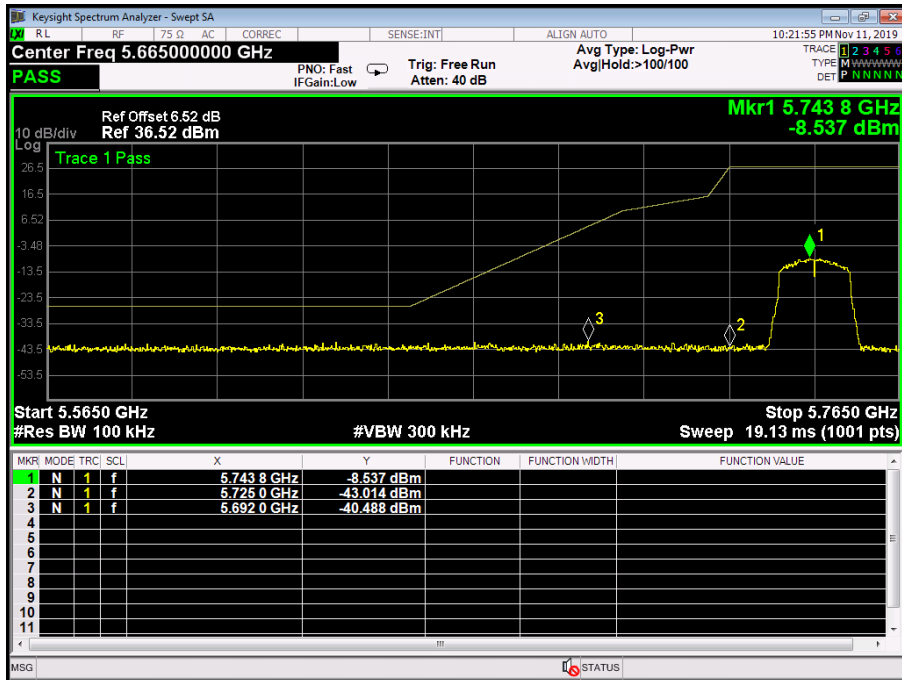

Temperature:	25 °C	Relative Humidity:	55%
Test Voltage:	AC 120V/60Hz		
Test Mode:	TX 802.11n(20) Mode 5745MHz /5825MHz (U-NII-3)		
Remark:	The EUT is programed in continuously transmitting mode		

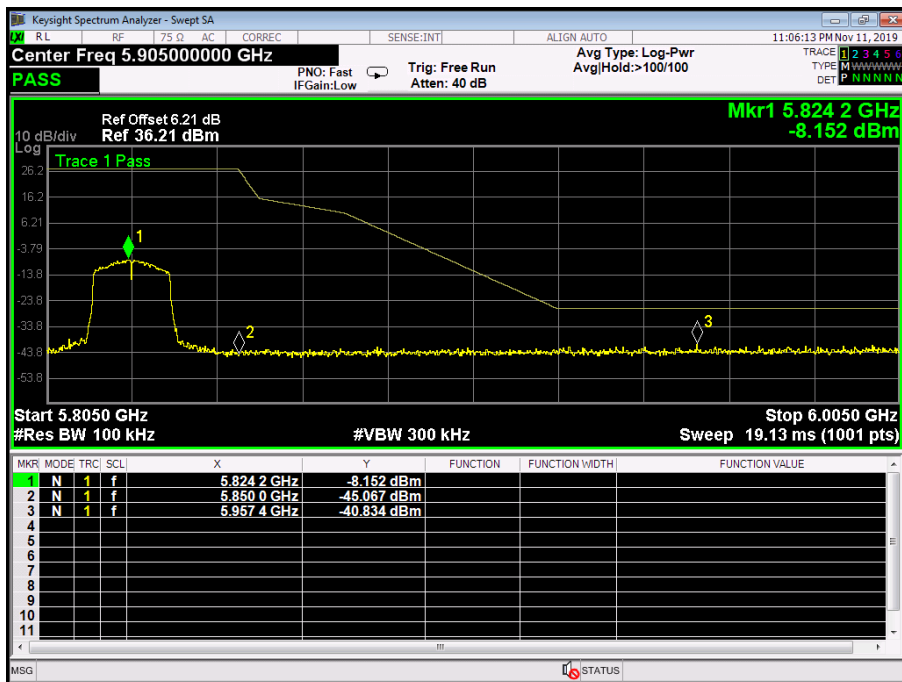
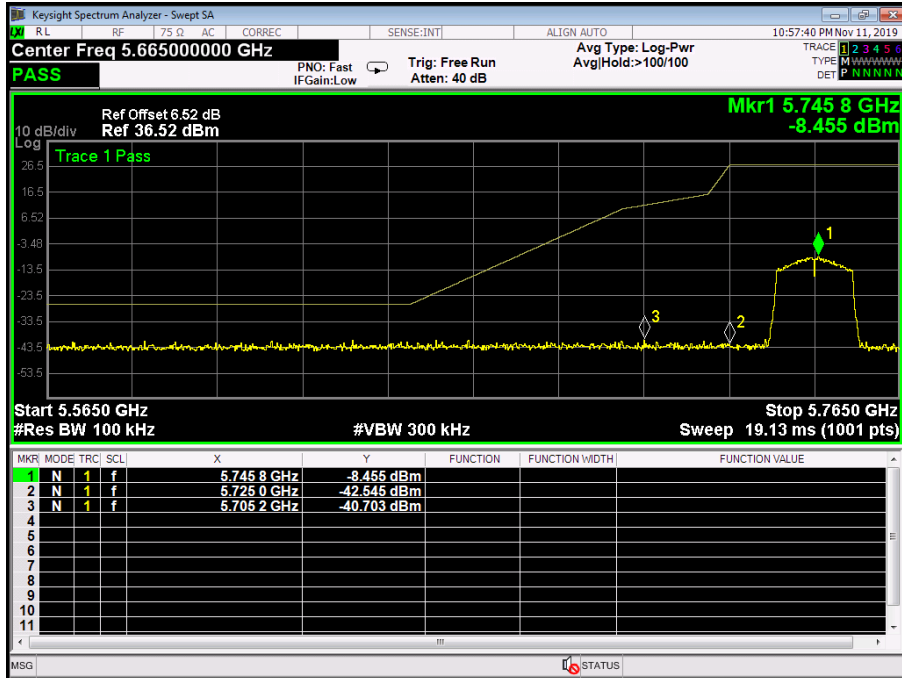

Temperature:	25 °C	Relative Humidity:	55%
Test Voltage:	AC 120V/60Hz		
Test Mode:	TX 802.11n(40) mode(U-NII-1) / 5190 ~ 5230MHz CH Low-5190MHz TX 802.11n(40) mode(U-NII-1) / 5190 ~ 5230MHz CH High-5230MHz		
Remark:	The EUT is programed in continuously transmitting mode		

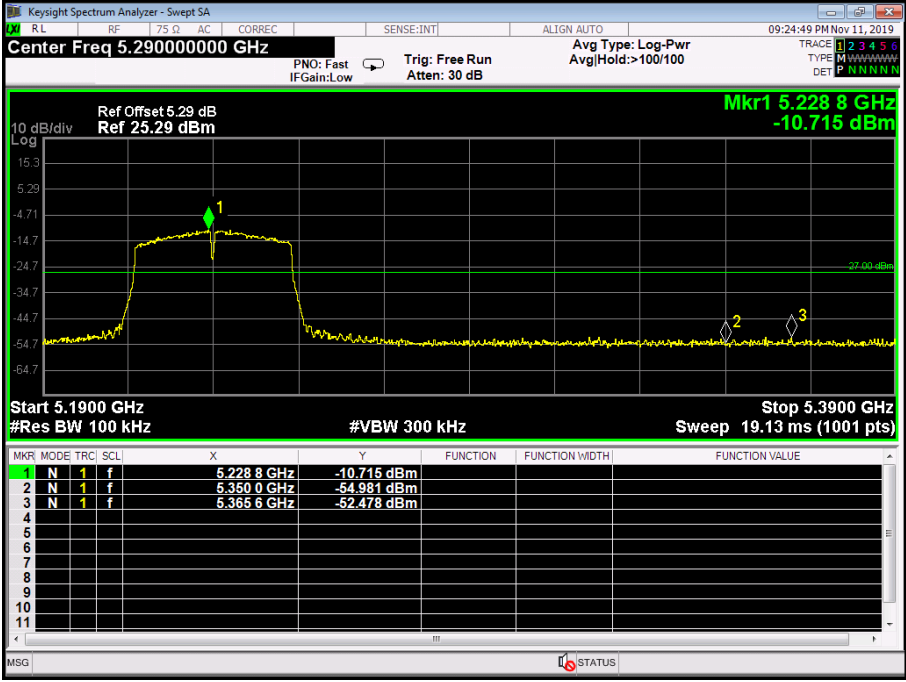
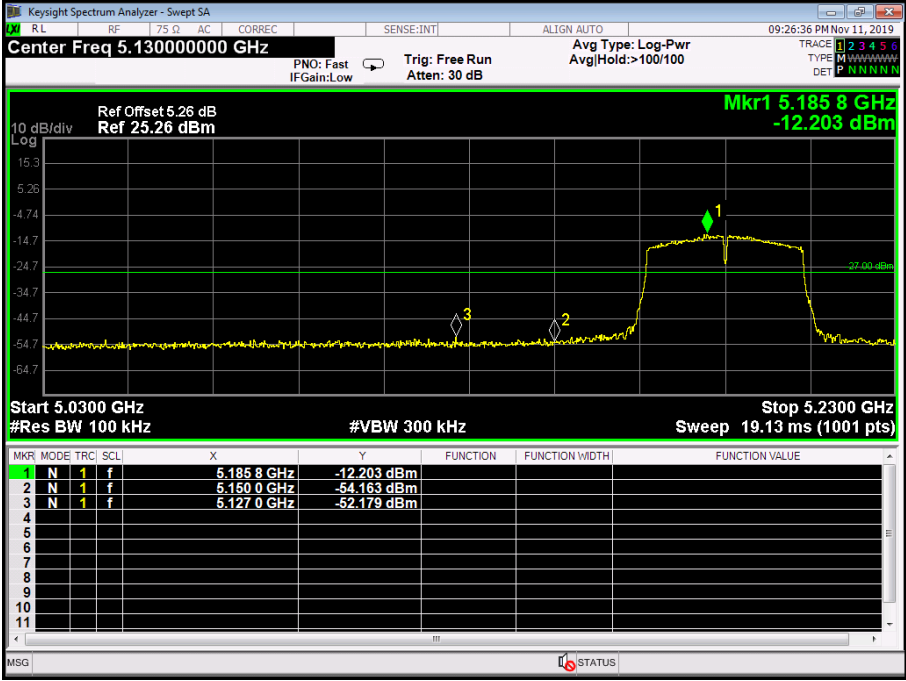

Temperature:	25 °C	Relative Humidity:	55%
Test Voltage:	AC 120V/60Hz		
Test Mode:	TX 802.11 n(40) Mode 5755MHz/5795 (U-NII-3)		
Remark:	The EUT is programed in continuously transmitting mode		

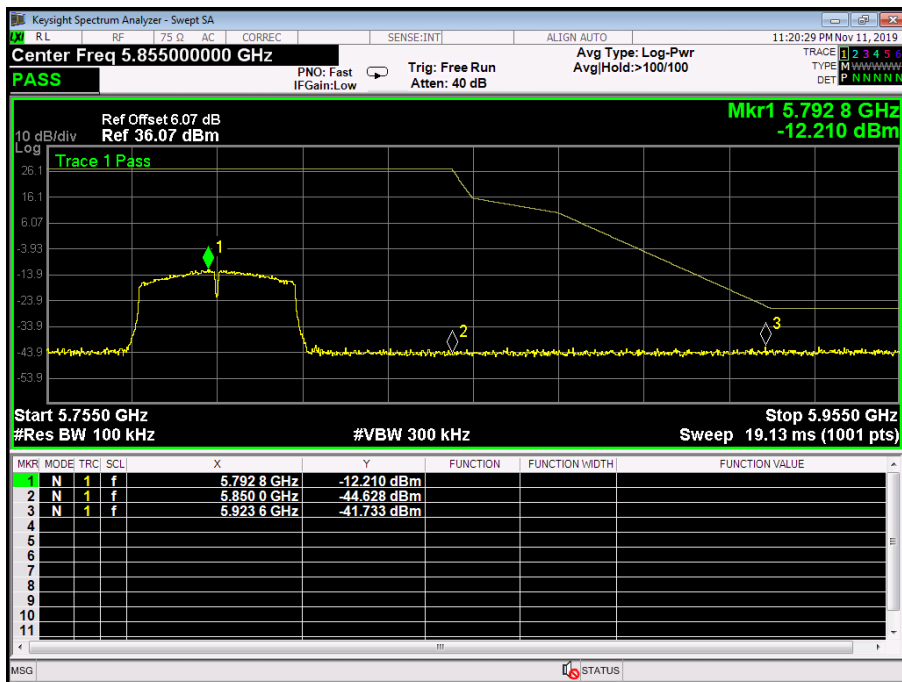
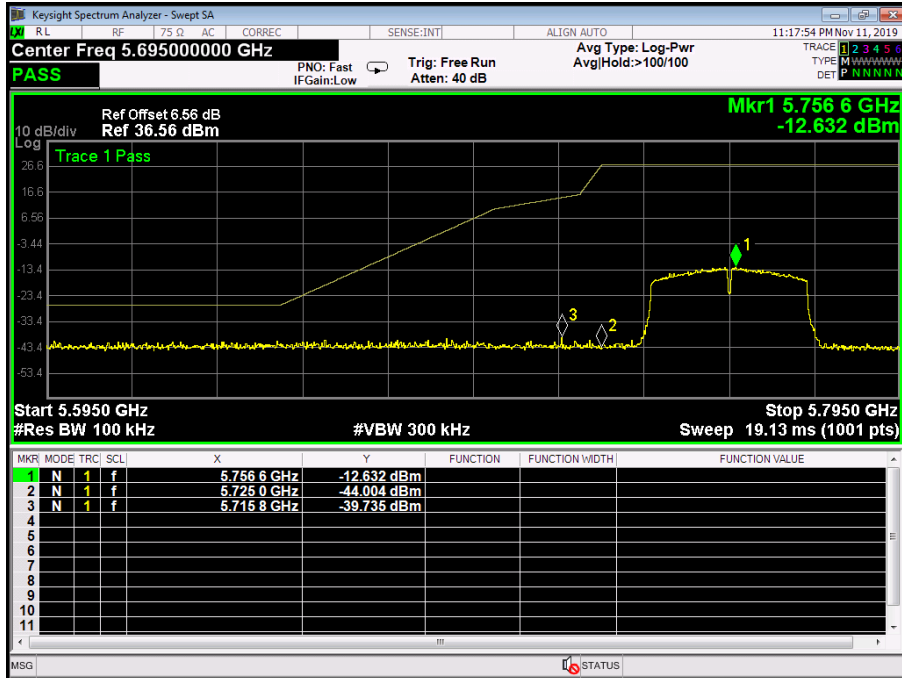

Attachment D-- Bandwidth Test Data

Temperature:	25 °C	Relative Humidity:	55%
Test Voltage:	AC 120V/60Hz		
Test Mode:	TX 802.11a Mode (U-NII-1)		
Channel	Frequency (MHz)	26dB Bandwidth (MHz)	99% Bandwidth (MHz)
36	5180	19.89	16.505
40	5200	19.93	16.512
48	5240	19.88	16.526
802.11a Mode			
5180 MHz			

802.11a Mode

5200 MHz

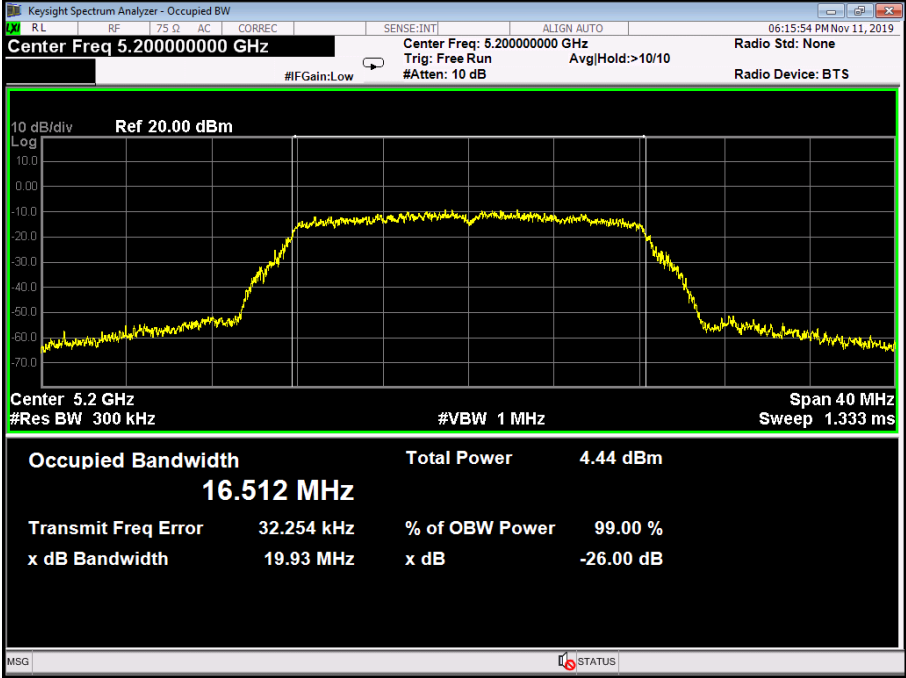

802.11a Mode

5240 MHz

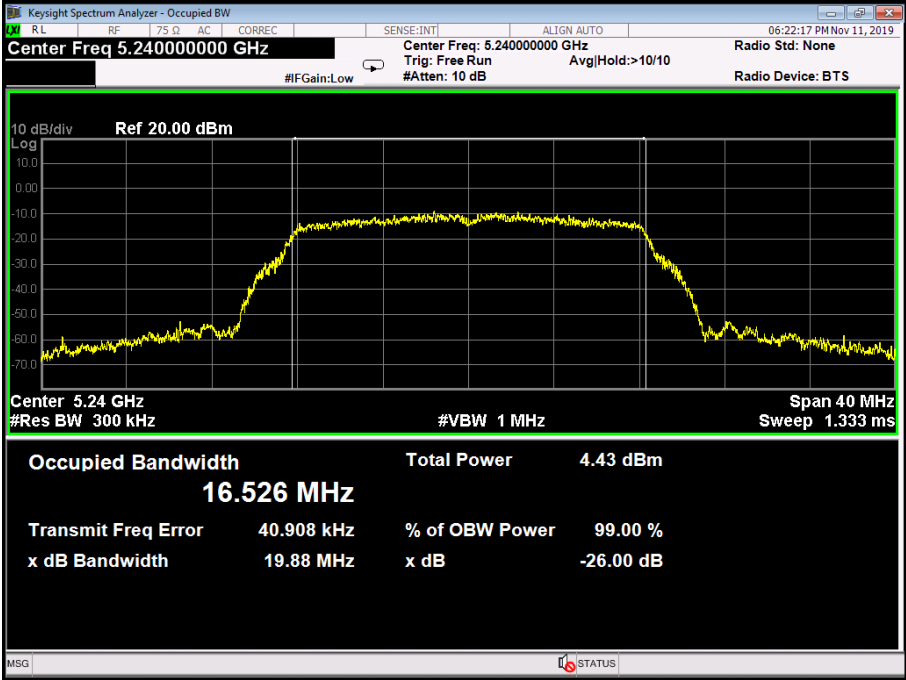

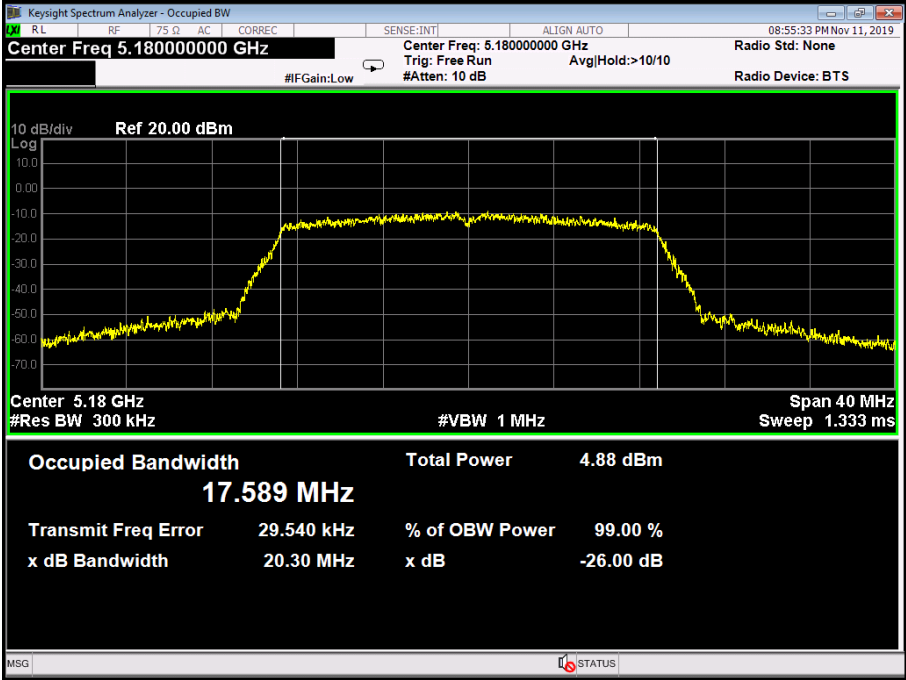
Temperature:	25 °C	Relative Humidity:	55%
Test Voltage:	AC 120V/60Hz		
Test Mode:	TX 802.11n(HT20) Mode (U-NII-1)		
Channel	Frequency (MHz)	26dB Bandwidth (MHz)	99% Bandwidth (MHz)
36	5180	20.30	17.589
40	5200	20.19	17.600
48	5240	20.21	17.543
802.11n(HT20) Mode			
5180 MHz			
			

802.11n(HT20) Mode
5200 MHz

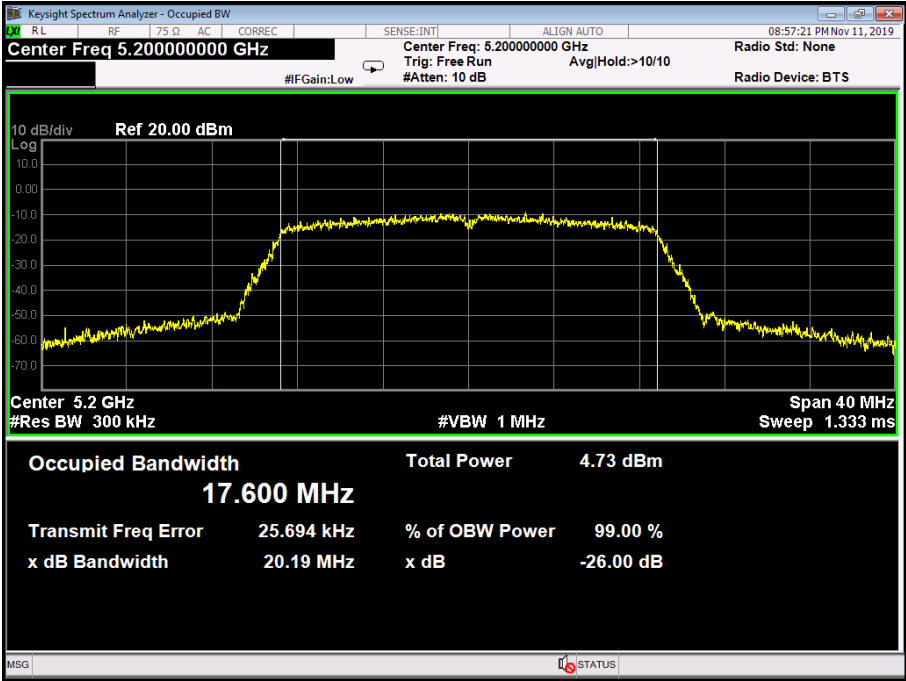

802.11n(HT20) Mode
5240 MHz

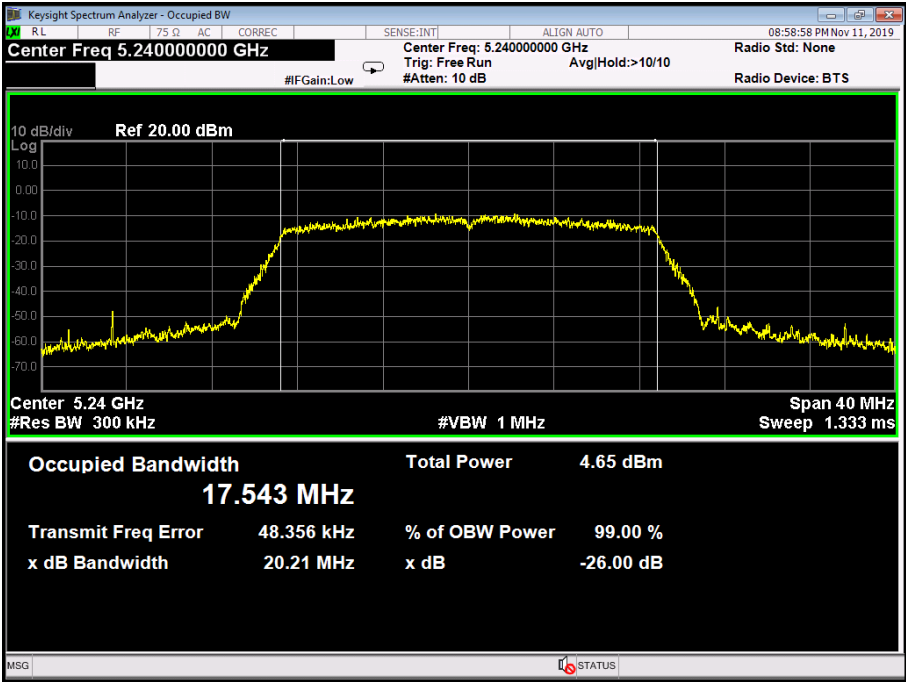

Temperature:	25 °C	Relative Humidity:	55%
Test Voltage:	AC 120V/60Hz		
Test Mode:	TX 802.11N(HT40) Mode (U-NII-1)		
Channel	Frequency (MHz)	26dB Bandwidth (MHz)	99% Bandwidth (MHz)
38	5190	40.25	35.865
46	5230	39.36	35.843
802.11N(HT40) Mode			
5190 MHz			
<p>Keysight Spectrum Analyzer - Occupied BW</p> <p>Center Freq: 5.19000000 GHz</p> <p>Occupied Bandwidth: 35.865 MHz</p> <p>Total Power: 3.62 dBm</p> <p>Transmit Freq Error: 55.464 kHz</p> <p>% of OBW Power: 99.00 %</p> <p>x dB Bandwidth: 40.25 MHz</p> <p>x dB: -26.00 dB</p>			

802.11N(HT40) Mode

5230 MHz

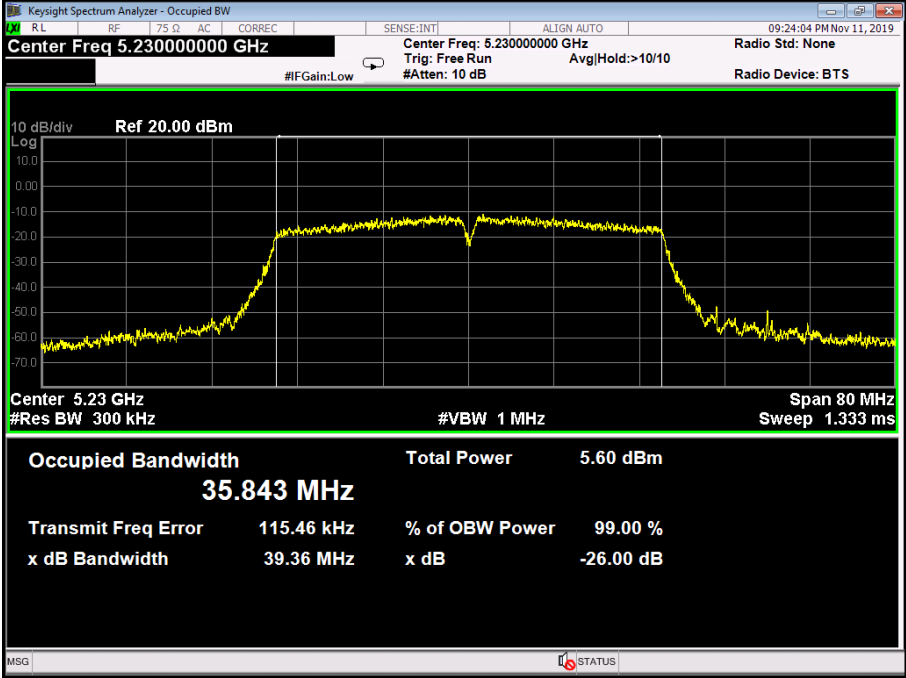

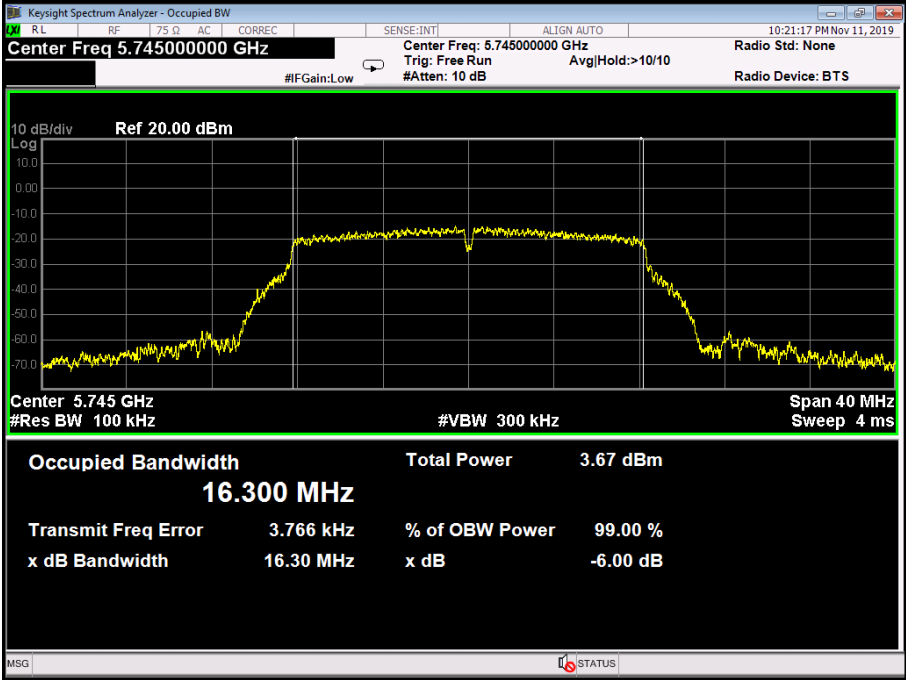
Temperature:	25 °C	Relative Humidity:	55%
Test Voltage:	AC 120V/60Hz		
Test Mode:	TX 802.11a Mode (U-NII-3)		
Channel	Frequency (MHz)	6dB Bandwidth (MHz)	99% Bandwidth (MHz)
149	5745	16.30	16.300
157	5785	16.34	16.325
165	5825	16.33	16.330
802.11a Mode			
5745 MHz			
			

802.11a Mode

5785 MHz

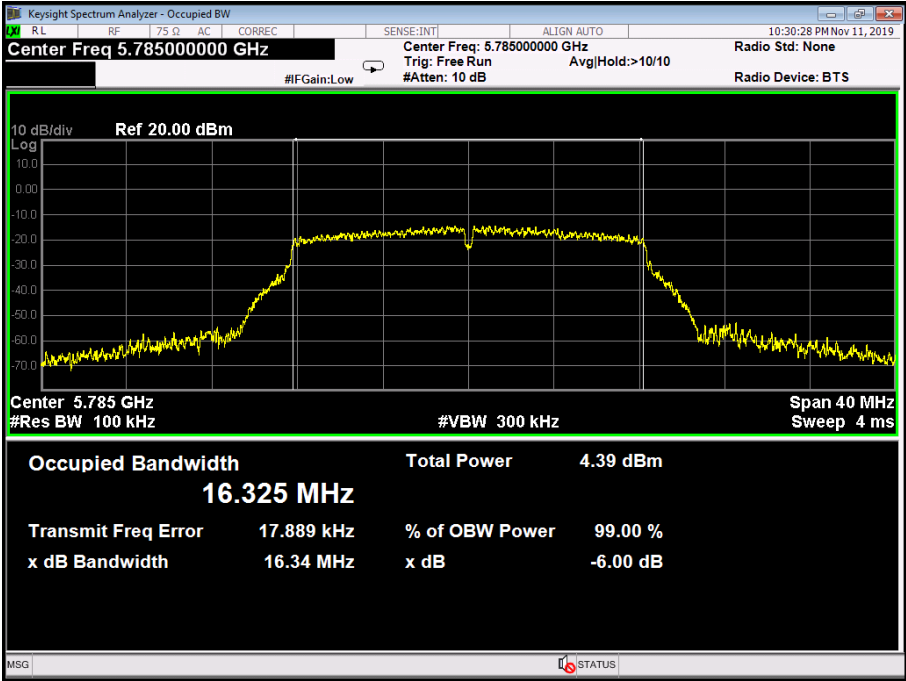

802.11a Mode

5825 MHz

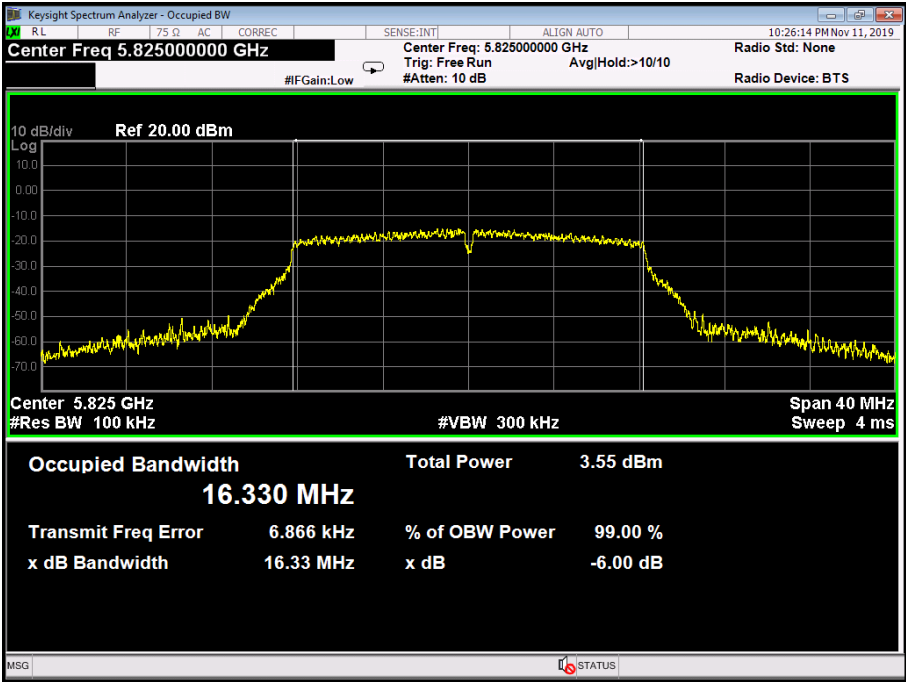

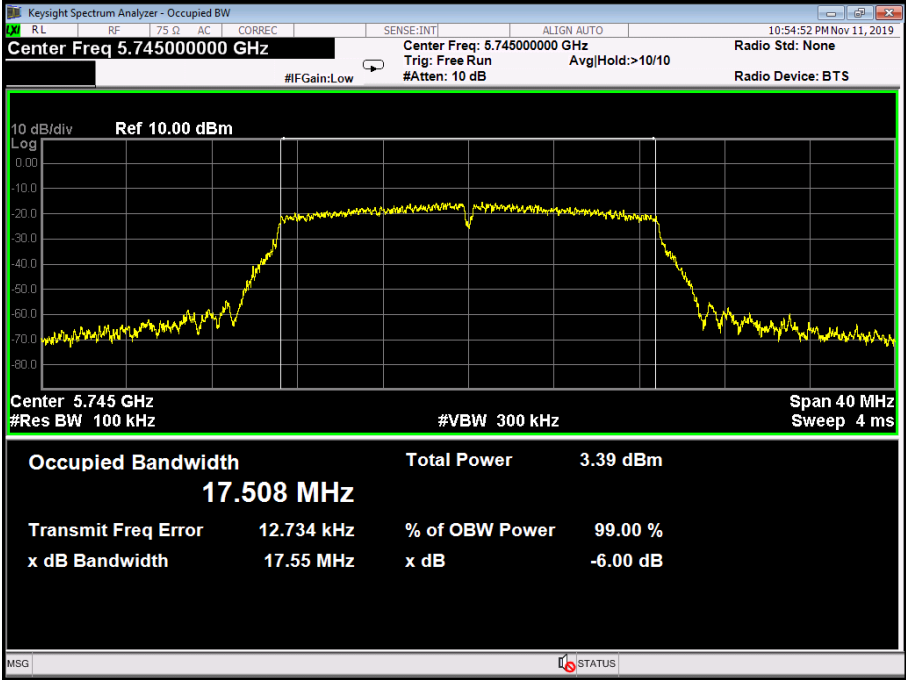
Temperature:	25 °C	Relative Humidity:	55%
Test Voltage:	AC 120V/60Hz		
Test Mode:	TX 802.11n(20) Mode (U-NII-3)		
Channel	Frequency (MHz)	6dB Bandwidth (MHz)	99% Bandwidth (MHz)
149	5745	17.55	17.508
157	5785	17.33	17.510
165	5825	17.54	17.530
802.11n(HT20) Mode			
5745 MHz			
 <p>Keysight Spectrum Analyzer - Occupied BW</p> <p>Center Freq 5.745000000 GHz</p> <p>Center Freq: 5.745000000 GHz</p> <p>Trig: Free Run</p> <p>#Atten: 10 dB</p> <p>Avg/Hold: >10/10</p> <p>Radio Std: None</p> <p>Radio Device: BTS</p> <p>10 dB/div</p> <p>Ref 10.00 dBm</p> <p>Center 5.745 GHz</p> <p>#Res BW 100 kHz</p> <p>#VBW 300 kHz</p> <p>Span 40 MHz</p> <p>Sweep 4 ms</p> <p>Occupied Bandwidth 17.508 MHz</p> <p>Total Power 3.39 dBm</p> <p>Transmit Freq Error 12.734 kHz</p> <p>% of OBW Power 99.00 %</p> <p>x dB Bandwidth 17.55 MHz</p> <p>x dB -6.00 dB</p>			

802.11n(HT20) Mode

5785 MHz

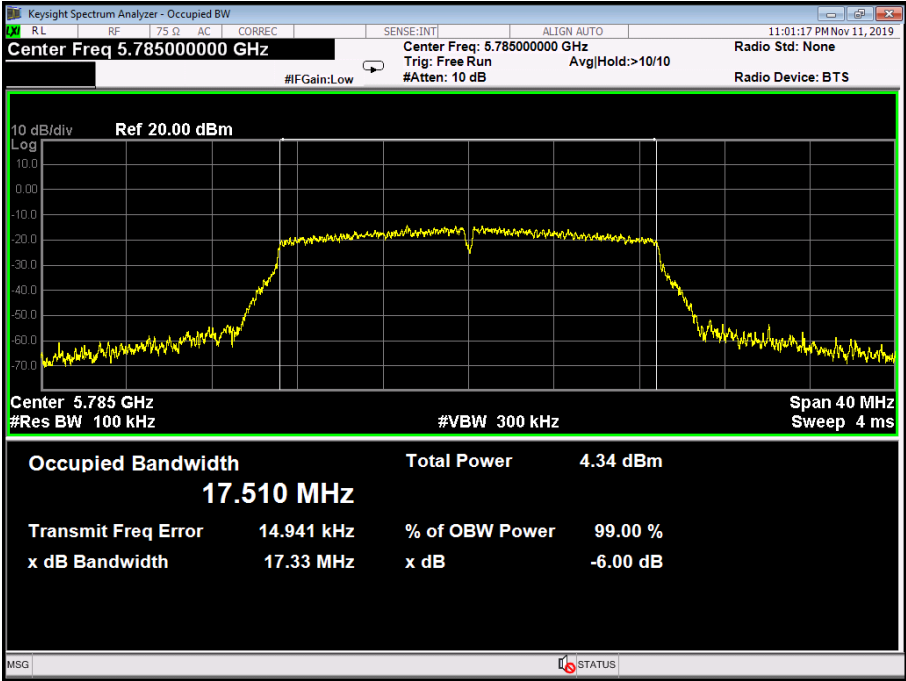

802.11n(HT20) Mode

5825 MHz

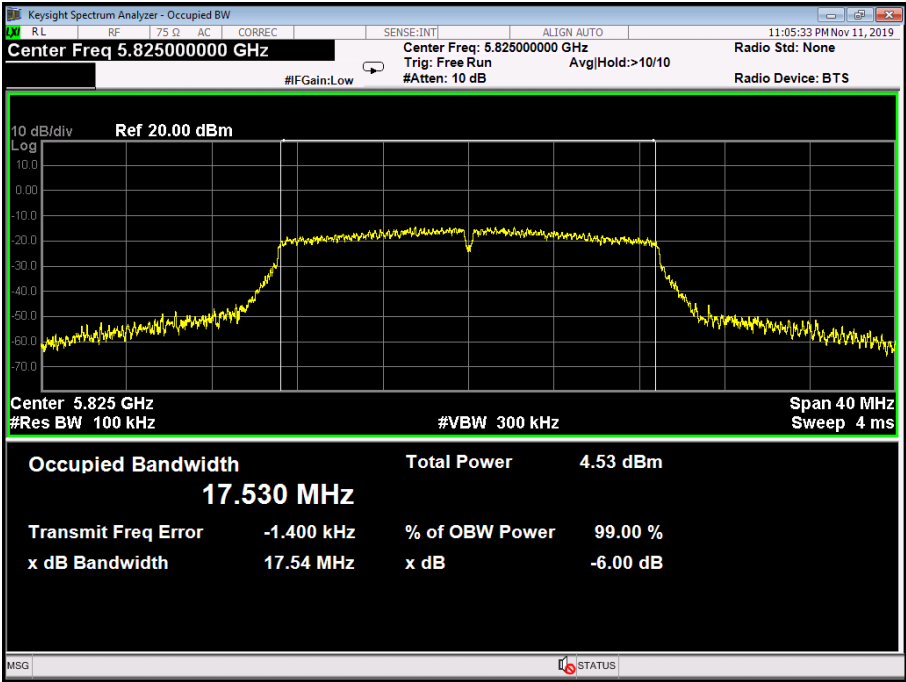

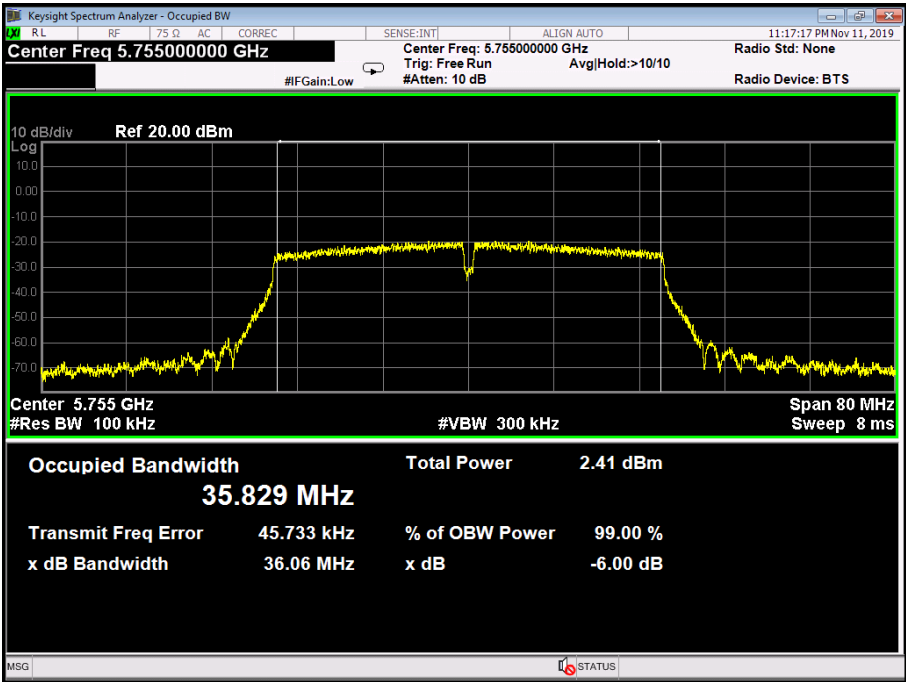
Temperature:	25 °C	Relative Humidity:	55%
Test Voltage:	AC 120V/60Hz		
Test Mode:	TX 802.11n(40) Mode (U-NII-3)		
Channel	Frequency (MHz)	6dB Bandwidth (MHz)	99% Bandwidth (MHz)
151	5755	36.06	35.829
159	5795	35.67	35.778
802.11n(HT40) Mode			
5755 MHz			
			

802.11n(HT40) Mode

5795 MHz

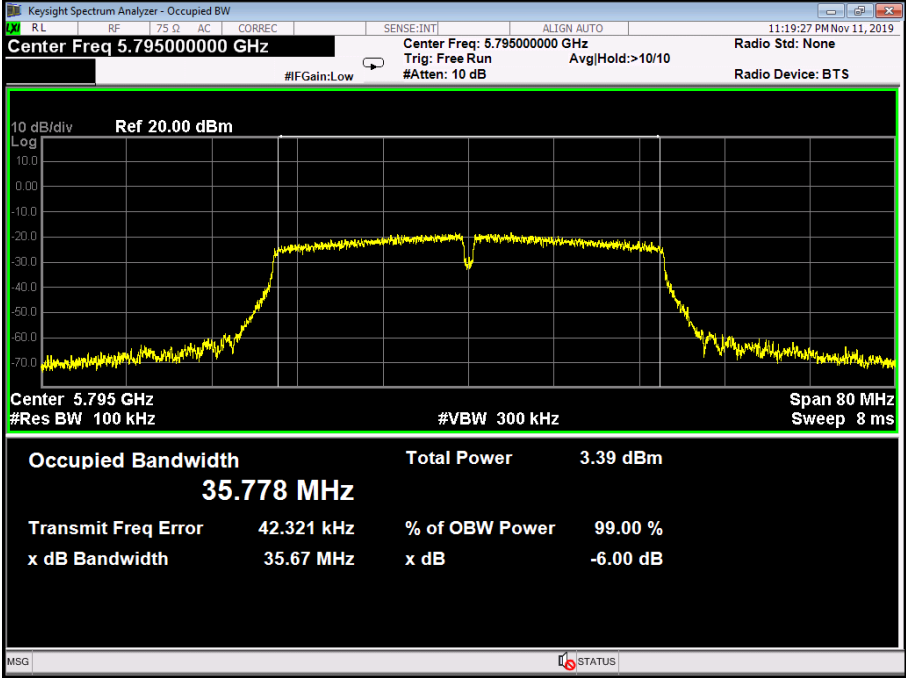

Attachment E-- Output Power Test Data

Temperature:	25 °C	Relative Humidity:	55%		
Test Voltage:	AC 120V/60Hz				
U-NII-1					
Test Mode	Frequency (MHz)	Test Data			Limit (dBm)
		Conducted Power (dBm)	Duty Factor (dB)	Total Power (dBm)	
802.11a	5180	6.41	0	6.41	24
	5200	6.42	0	6.42	
	5240	6.19	0	6.19	
802.11n (HT20)	5180	6.40	0	6.40	
	5200	6.16	0	6.16	
	5240	6.14	0	6.14	
802.11n (HT40)	5190	6.33	0	6.33	
	5230	6.20	0	6.20	
Result: PASS					

Temperature:	25 °C	Relative Humidity:	55%		
Test Voltage:	AC 120V/60Hz				
U-NII-3					
Test Mode	Frequency (MHz)	Test Data			Limit (dBm)
		Conducted Power (dBm)	Duty Factor (dB)	Total Power (dBm)	
802.11a	5745	6.57	0	6.57	30
	5785	6.16	0	6.16	
	5825	6.09	0	6.09	
802.11n (HT20)	5745	6.21	0	6.21	
	5785	6.13	0	6.13	
	5825	6.14	0	6.14	
802.11n (HT40)	5755	6.18	0	6.18	
	5795	6.10	0	6.10	
Result: PASS					

Test Mode		Duty cycle
U-NII-1	802.11 a	>98%
	802.11 n(HT20)	
	802.11 n(HT40)	
U-NII-3	802.11 a	
	802.11 n(HT20)	
	802.11 n(HT40)	

U-NII-1 802.11 a 5200 MHz

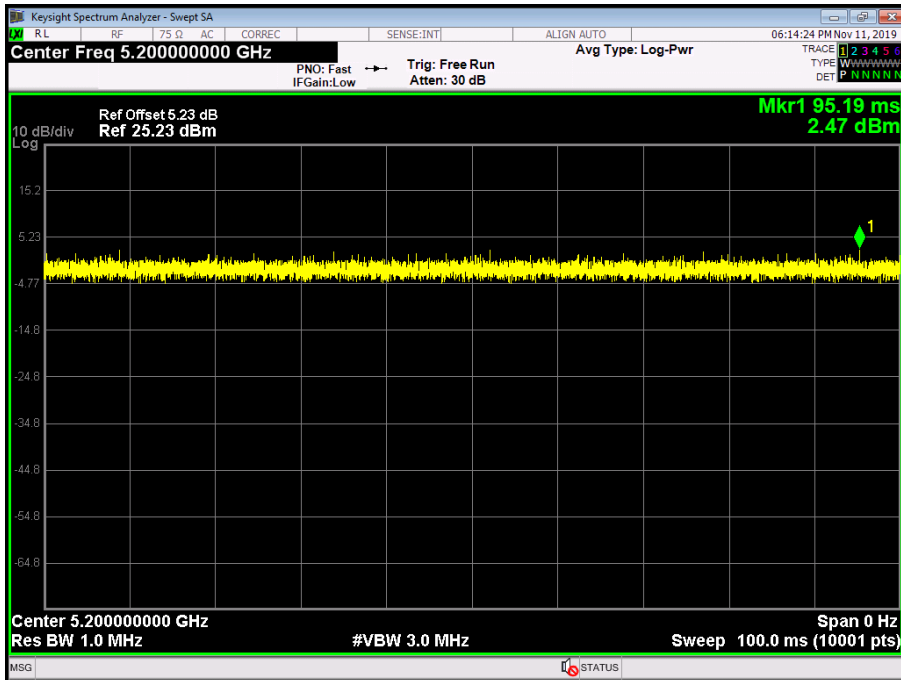

U-NII-1 802.11n(HT20) 5200 MHz

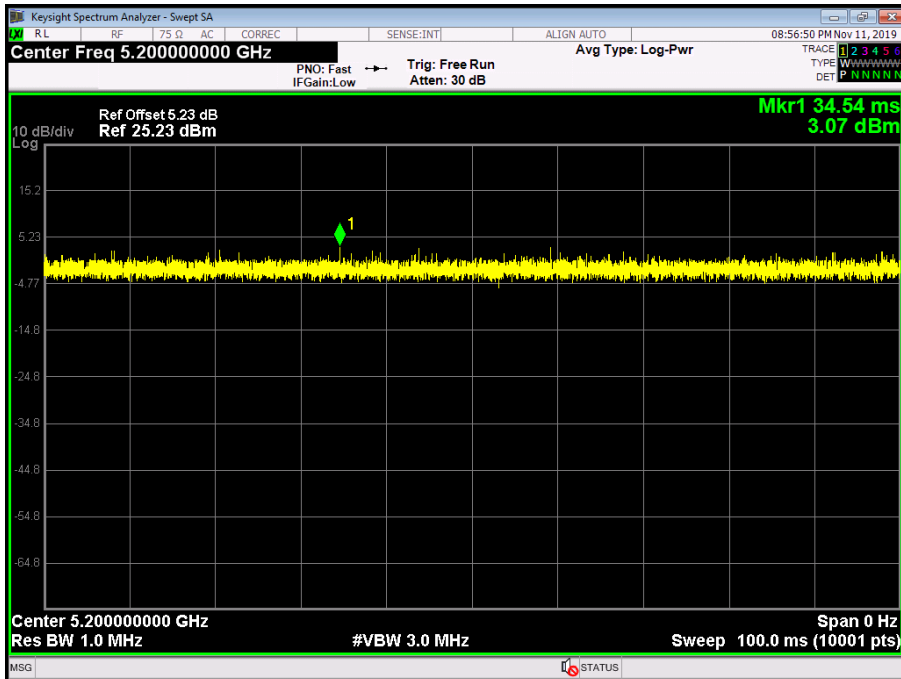

U-NII-1 802.11 n(HT40) 5190 MHz

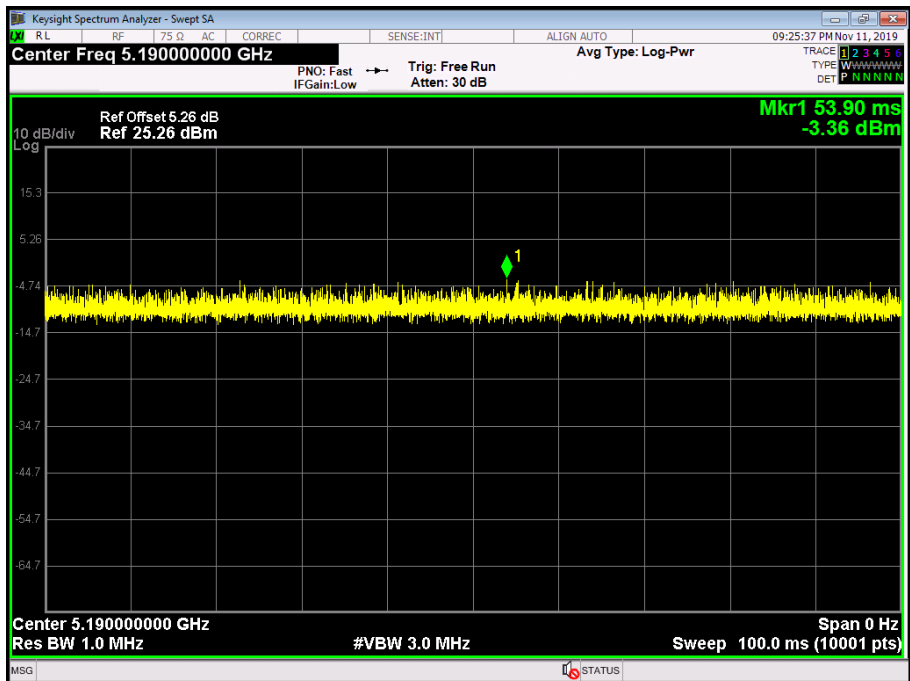

U-NII-3 802.11 a 5785 MHz

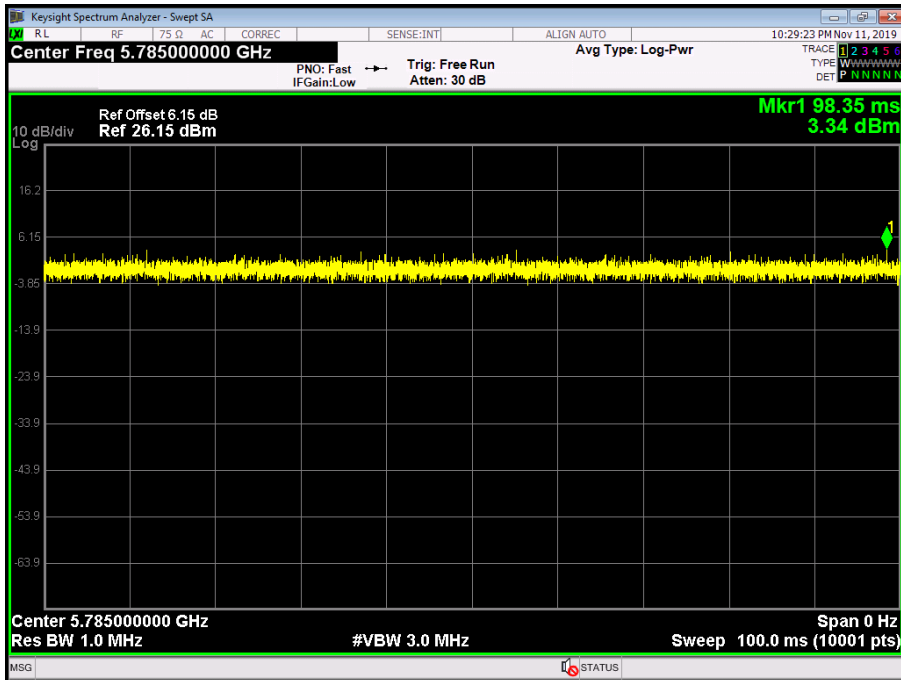

U-NII-3 802.11n(HT20) 5785 MHz

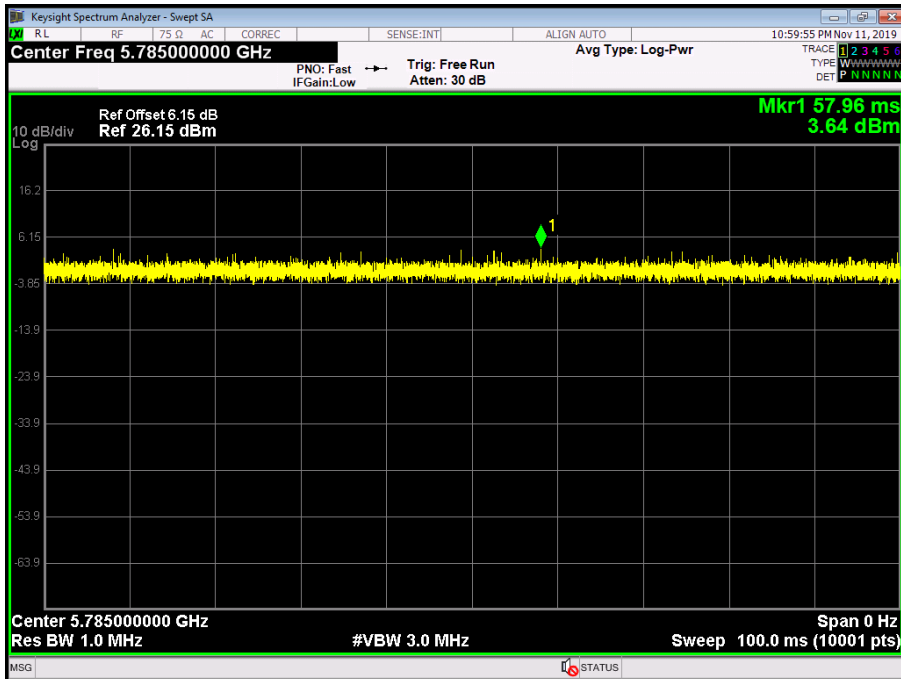

U-NII-3 802.11 n(HT40) 5755 MHz

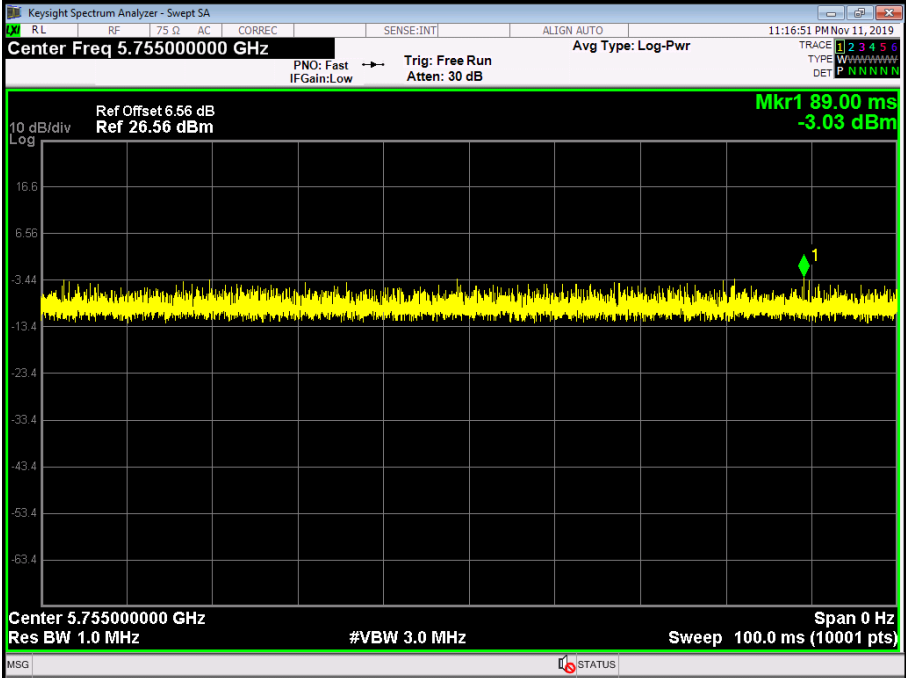

Attachment F-- Power Spectral Density Test Data

Temperature:	25 °C	Relative Humidity:	55%
Test Voltage:	AC 120V/60Hz		
U-NII-1			
Test Mode	Frequency (MHz)	Test Data	Limit (dBm/MHz)
		Power Density (dBm/MHz)	
802.11a	5180	2.618	11
	5200	2.333	
	5240	1.912	
802.11n (HT20)	5180	2.081	
	5200	1.885	
	5240	2.148	
802.11n (HT40)	5190	-2.053	
	5230	0.306	
Result: PASS			
Test plots please refer to below pages:			

802.11 a 5180 MHz

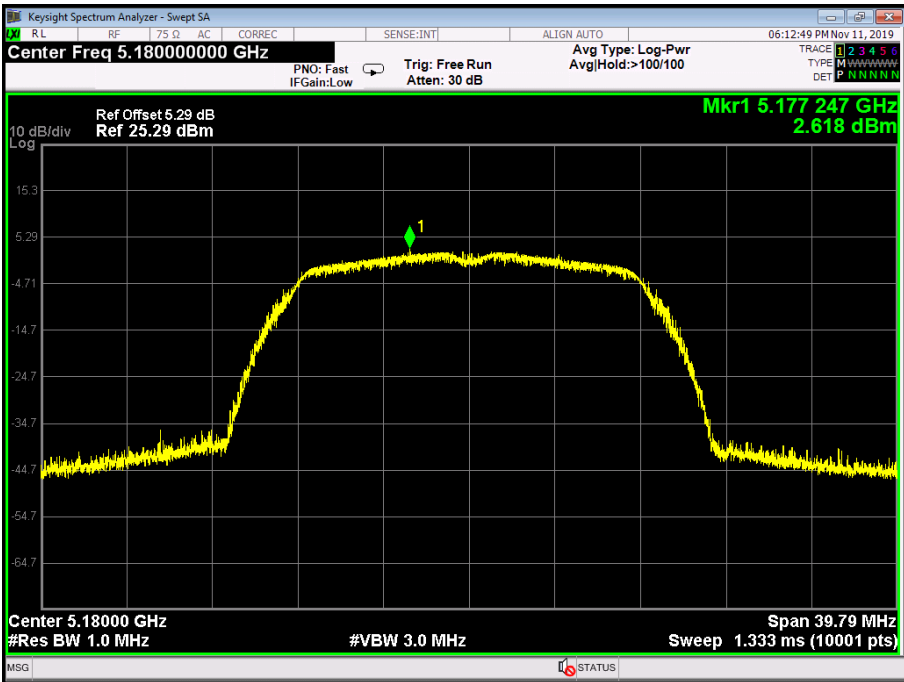

802.11 a 5200 MHz

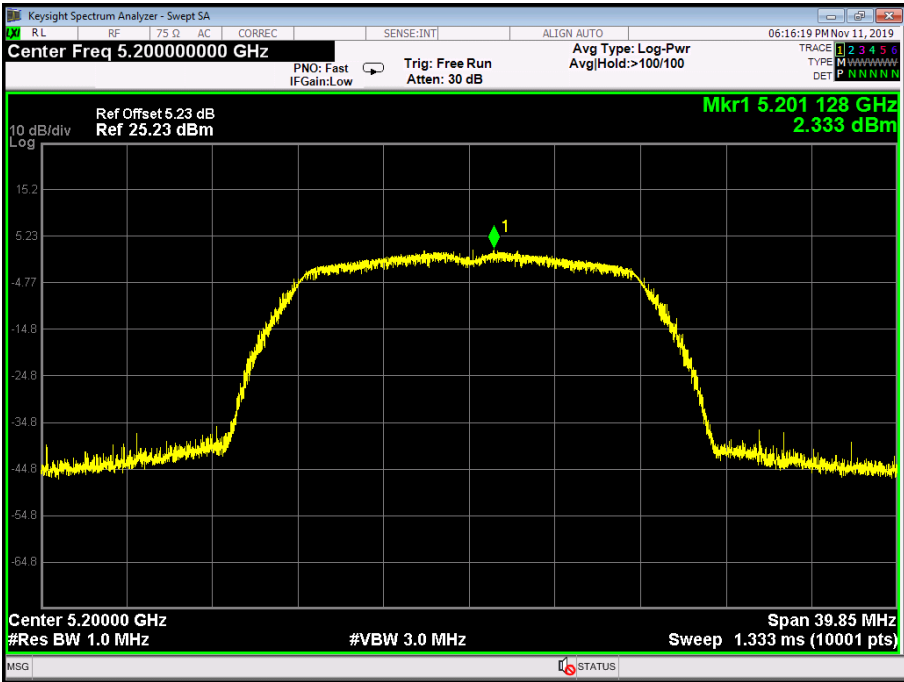

802.11 a 5240 MHz

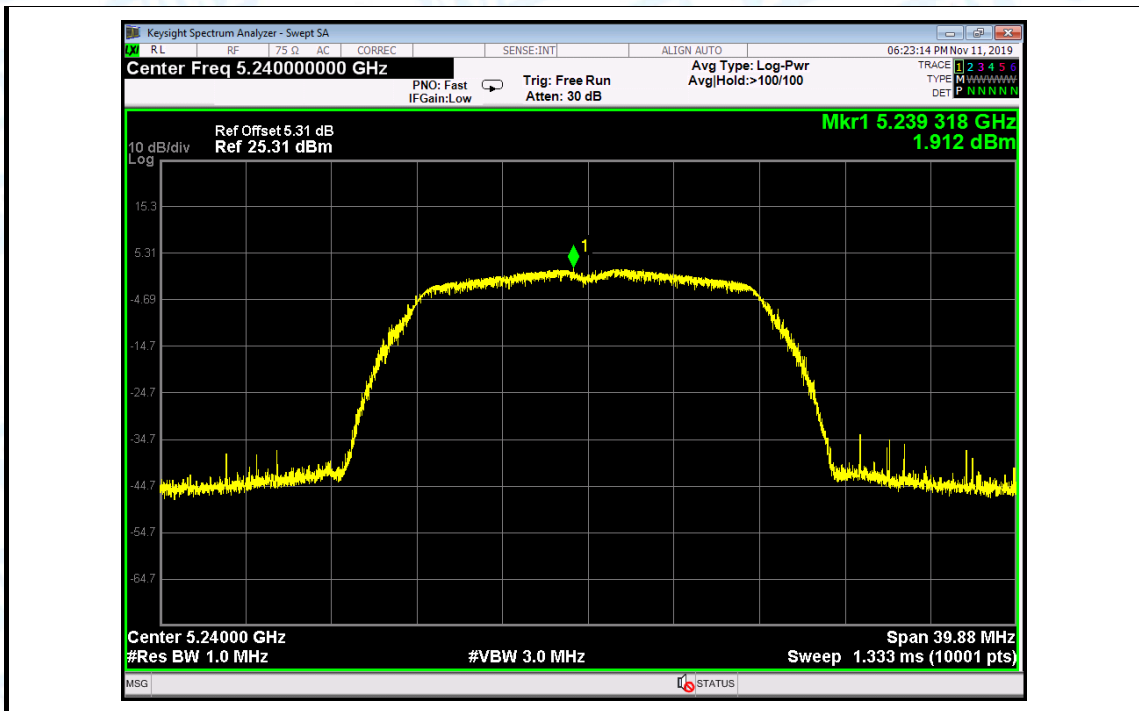

802.11 n(20) 5180 MHz

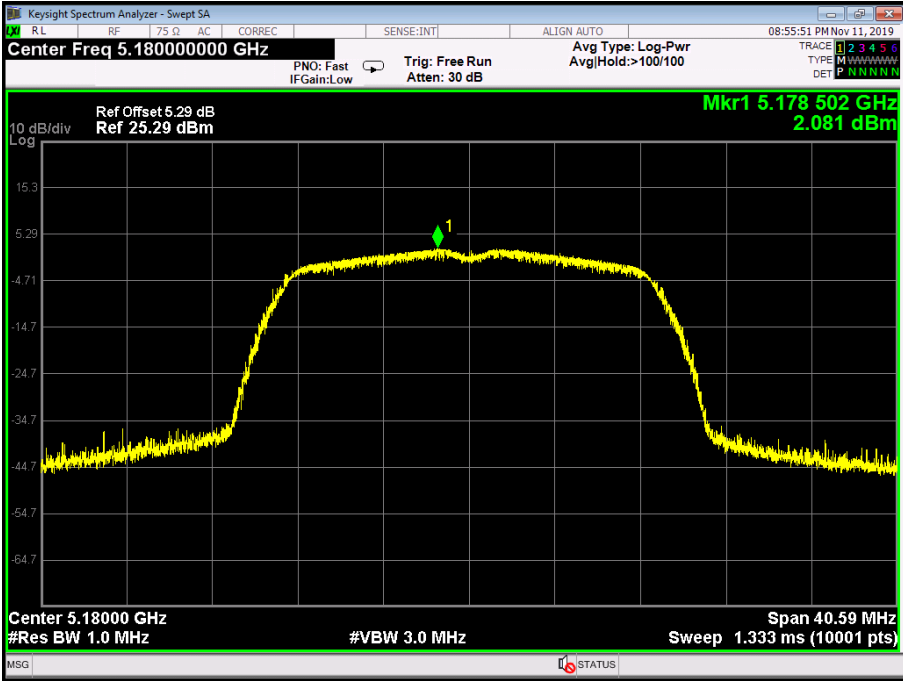

802.11 n(20) 5200 MHz

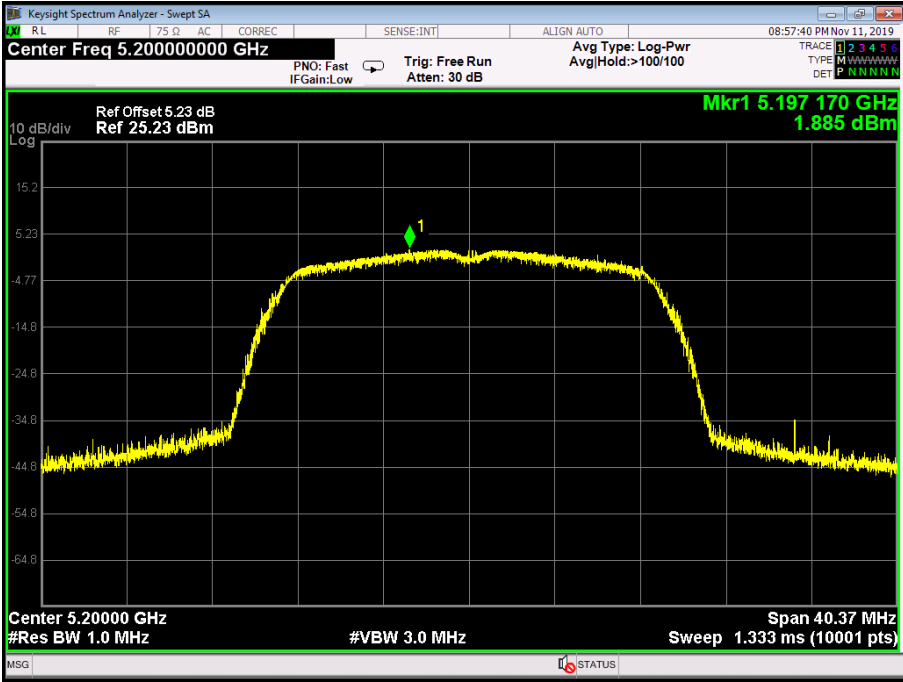

802.11 n(20) 5240 MHz

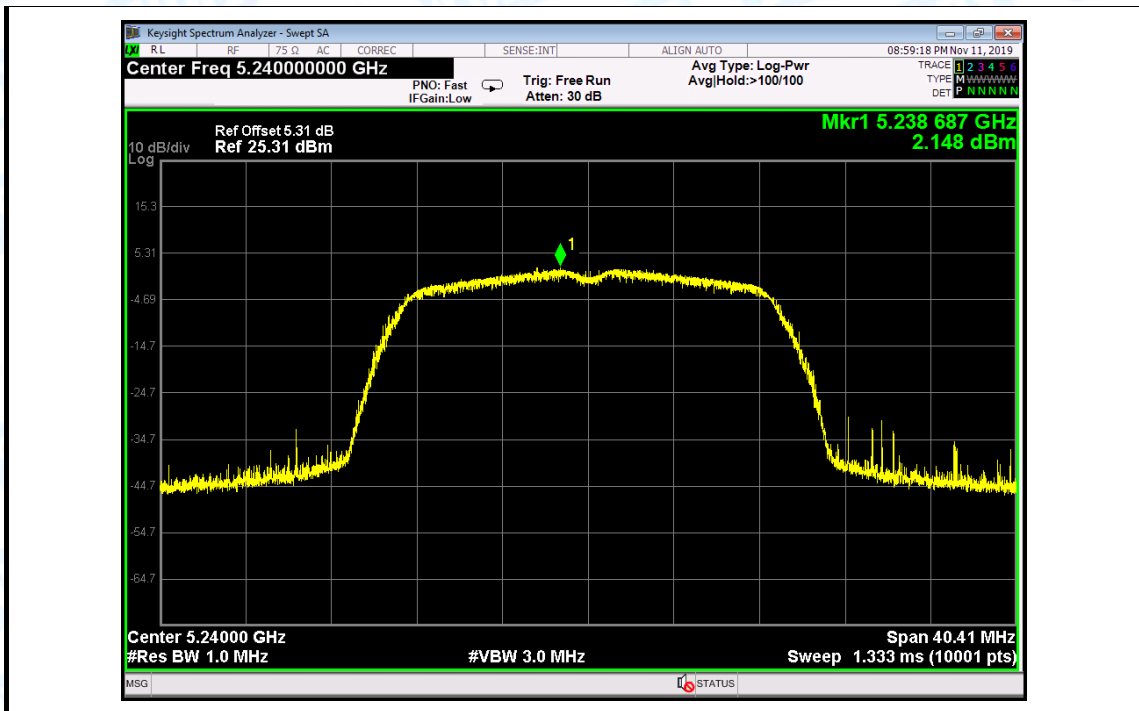

802.11 n(40) 5190 MHz

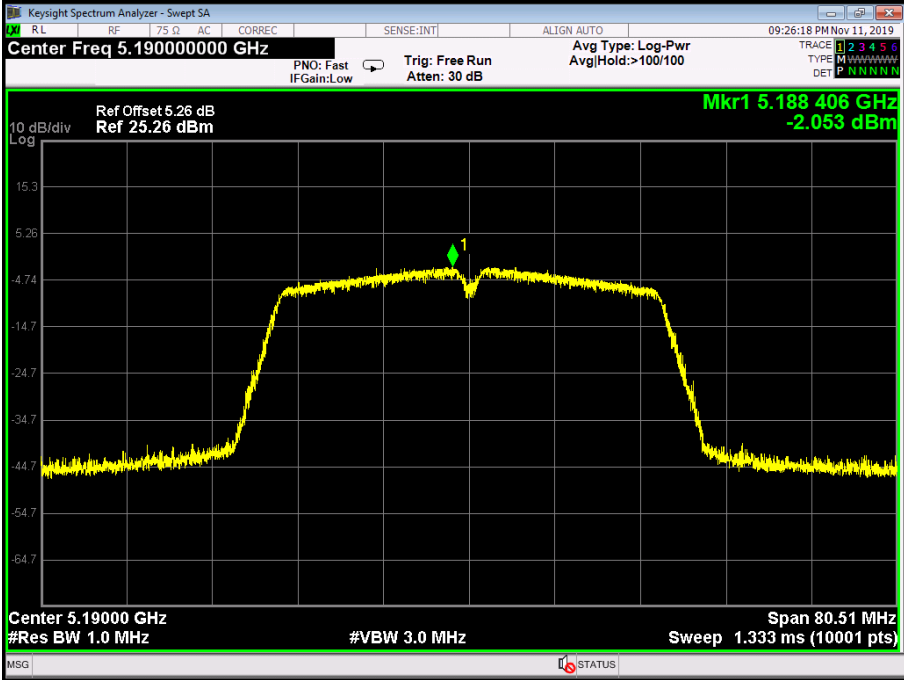

802.11 n(40) 5230 MHz

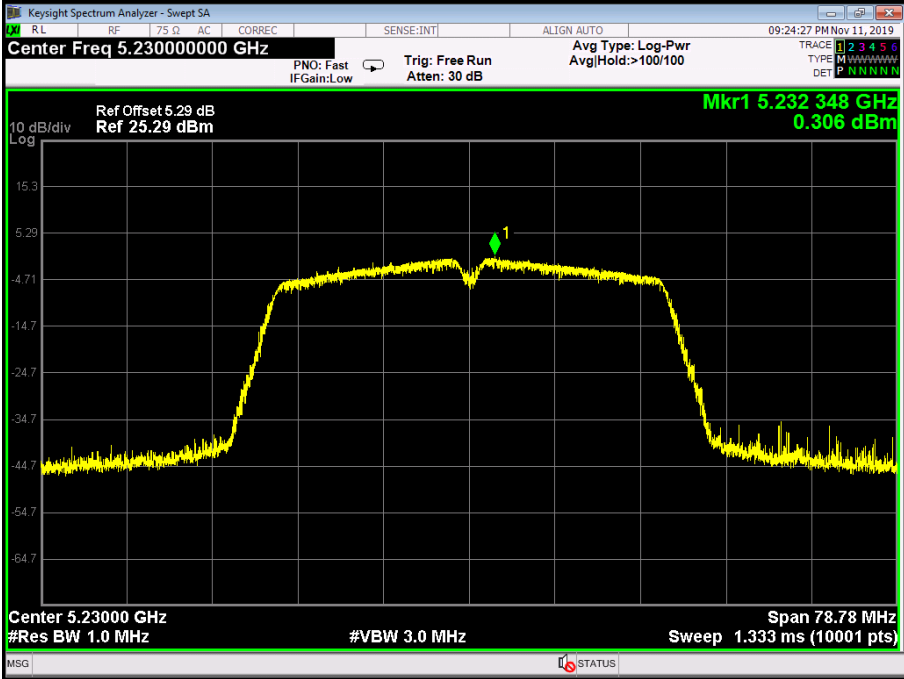

Temperature:	25 °C	Relative Humidity:	55%
Test Voltage:	AC 120V/60Hz		
U-NII-3			
Test Mode	Frequency (MHz)	Test Data	Limit (dBm/500kHz)
		Power Density (dBm/500kHz)	
802.11a	5745	-1.049	30
	5785	-0.739	
	5825	-1.636	
802.11n (HT20)	5745	-1.089	
	5785	-0.573	
	5825	-0.270	
802.11n (HT40)	5755	-4.901	
	5795	-4.805	
Result: PASS			
Test plots please refer to below pages:			

802.11 a 5745 MHz

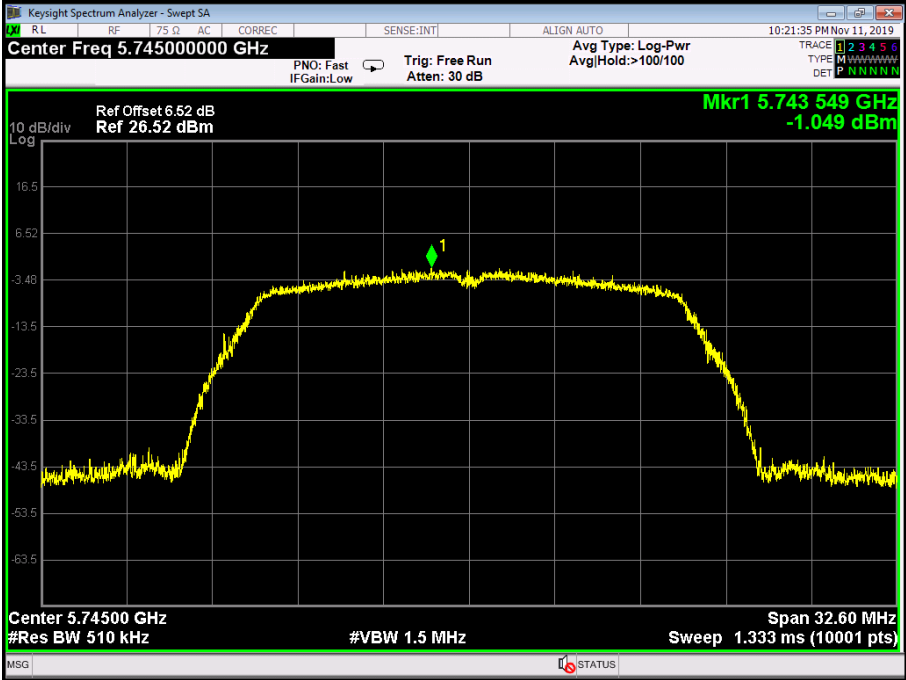

802.11 a 5785 MHz

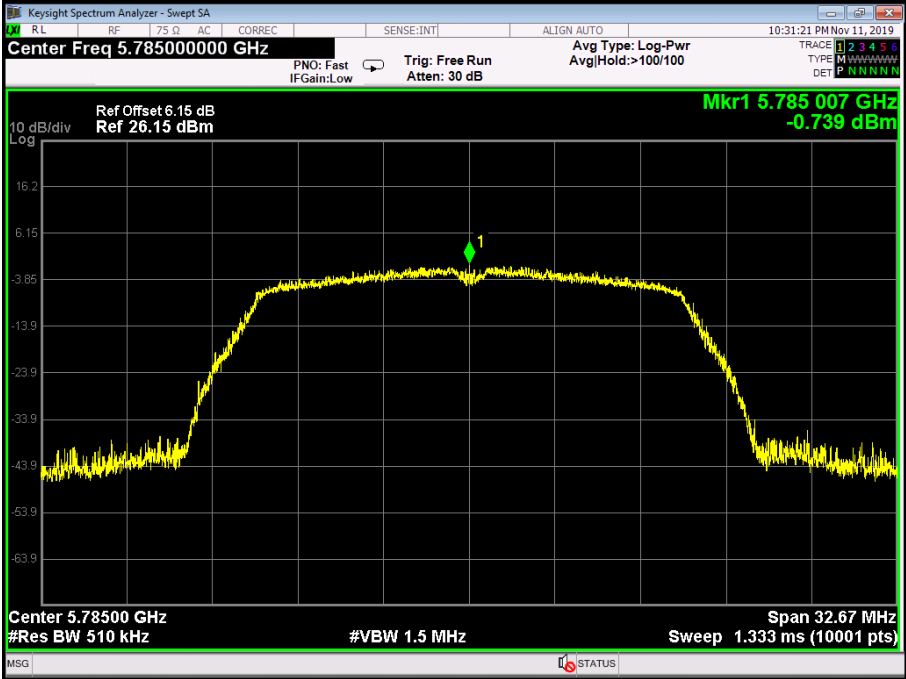

802.11 a 5825 MHz



802.11 n(20) 5745 MHz

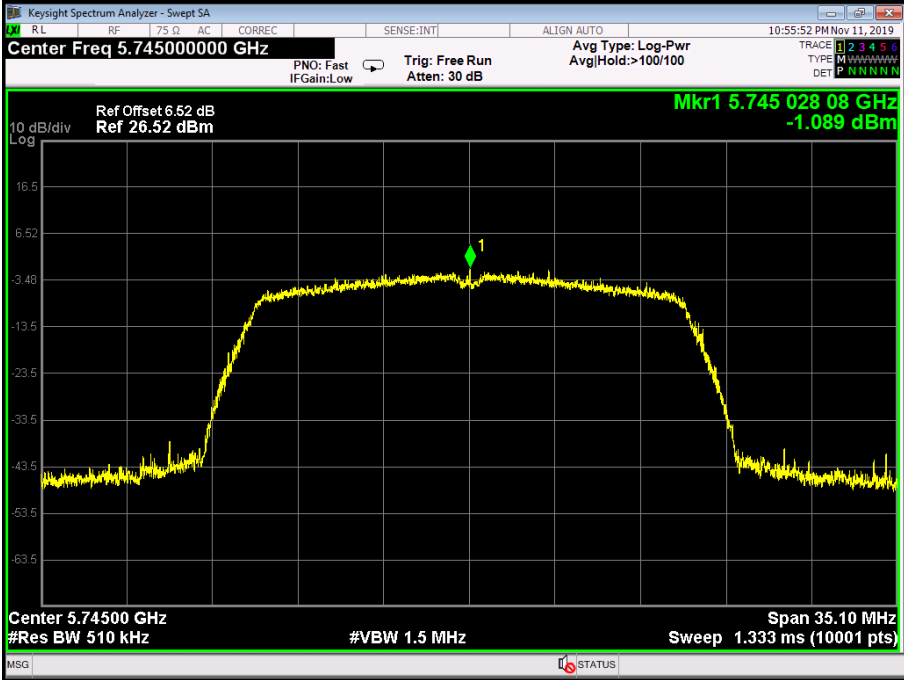

802.11 n(20) 5785 MHz

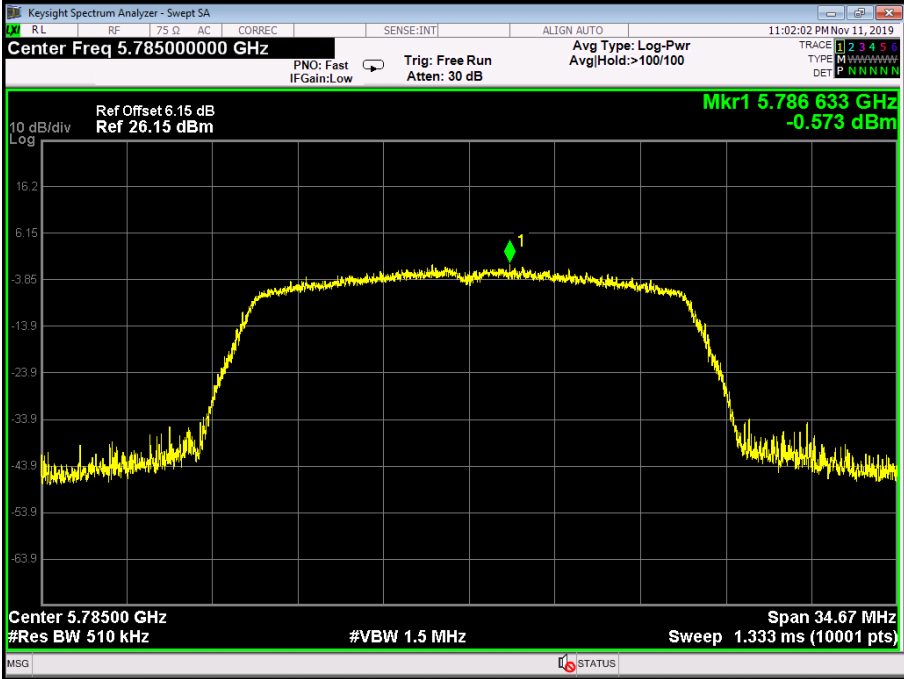

802.11 n(20) 5825 MHz

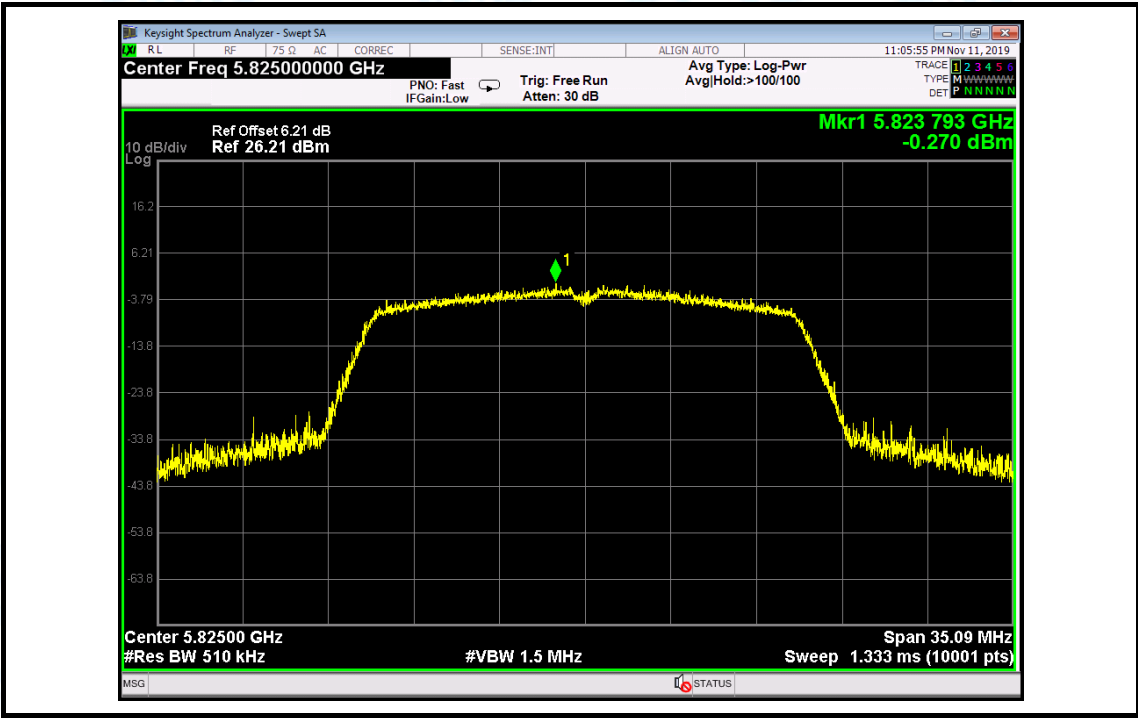

802.11 n(40) 5755 MHz

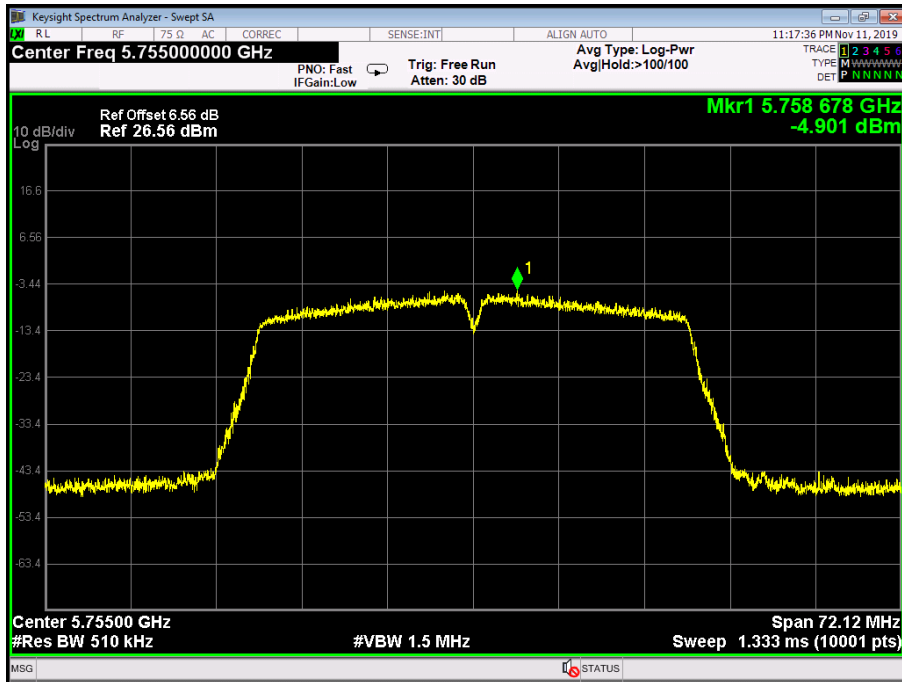

802.11 n(40) 5795 MHz

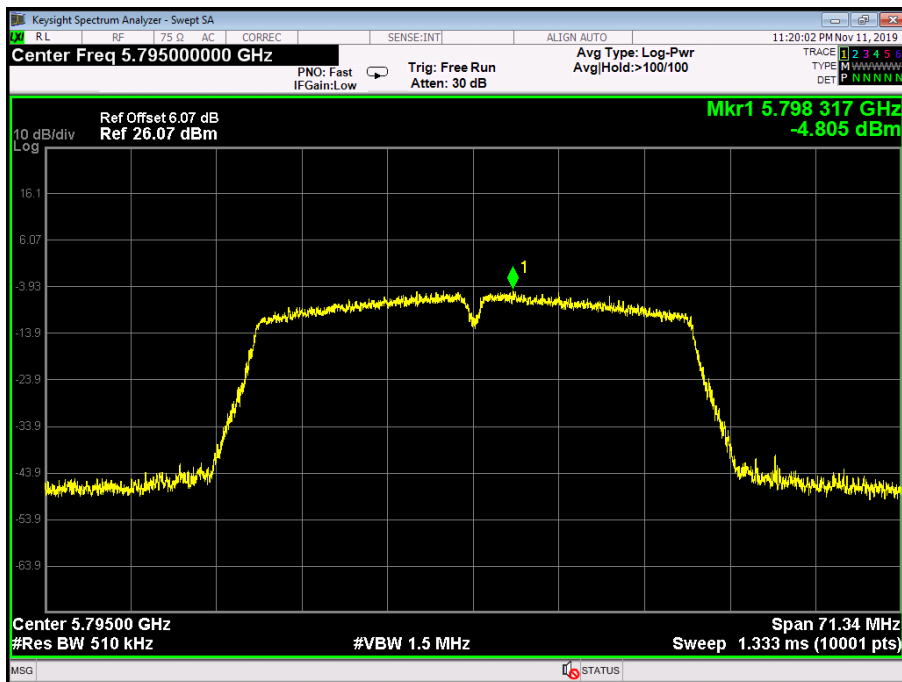

Attachment G-- Frequency Stability Measurement Test Data

801.11a U-NII-1: 5745 MHz	
Voltage vs. Frequency Stability	
Voltage (V)	Measurement Frequency (MHz)
132	5744.9658
120	5745.0000
108	5744.9523
Max. Deviation (MHz)	0.0477
Max. Deviation (ppm)	8.30
Temperature vs. Frequency Stability	
Temperature (°C)	Measurement Frequency (MHz)
0	5744.9632
10	5744.9724
20	5744.9569
30	5744.9658
40	5744.9515
50	5744.9768
Max. Deviation (MHz)	0.0485
Max. Deviation (ppm)	8.44
Limit (ppm)	20
Result	Pass

Remark: Worst case at 802.11a Mode 5745MHz.

-----END OF REPORT-----