

FCC Radio Test Report

FCC ID: 2ANYB-SCORE7

Original Grant

Report No. : TB-FCC169868
Applicant : Advanced Technologies Group, LLC
Equipment Under Test (EUT)
EUT Name : SCORE 7
Model No. : ATG 708
Series Model No. : ---
Brand Name : SCORE 7
Receipt Date : 2019-10-24
Test Date : 2019-10-25 to 2019-11-20
Issue Date : 2019-11-21
Standards : FCC Part 15, Subpart E 15.407
Test Method : ANSI C63.10: 2013
Conclusions : **PASS**

In the configuration tested, the EUT complied with the standards specified above,
The EUT technically complies with the FCC and IC requirements

Test/Witness Engineer :  Jack Deng

Test/Witness Engineer :  Ivan Su

Approved & Authorized :  Ray Lai



This report details the results of the testing carried out on one sample. The results contained in this test report do not relate to other samples of the same product. The manufacturer should ensure that all products in series production are in conformity with the product sample detailed in the report.

Contents

- CONTENTS..... 2**
- 1. GENERAL INFORMATION ABOUT EUT 5**
 - 1.1 Client Information..... 5
 - 1.2 General Description of EUT (Equipment Under Test) 5
 - 1.3 Block Diagram Showing the Configuration of System Tested..... 6
 - 1.4 Description of Support Units 6
 - 1.5 Description of Test Mode..... 7
 - 1.6 Description of Test Software Setting 7
 - 1.7 Test Facility..... 9
- 2. TEST SUMMARY 10**
- 3. TEST EQUIPMENT 11**
- 4. CONDUCTED EMISSION TEST 12**
 - 4.1 Test Standard and Limit..... 12
 - 4.2 Test Setup..... 12
 - 4.3 Test Procedure..... 13
 - 4.4 EUT Operating Mode 13
 - 4.5 Test Data..... 13
- 5. RADIATED EMISSION TEST 14**
 - 5.1 Test Standard and Limit..... 14
 - 5.2 Test Setup..... 15
 - 5.3 Test Procedure..... 17
 - 5.4 EUT Operating Condition 17
 - 5.5 Test Data..... 17
- 6. BAND EDGE EMISSIONS 18**
 - 6.1 Test Standard and Limit..... 18
 - 6.2 Test Setup..... 18
 - 6.3 Test Procedure..... 19
 - 6.4 EUT Operating Condition 19
 - 6.5 Test Data..... 19
- 7. BANDWIDTH TEST 20**
 - 7.1 Test Standard and Limit..... 20
 - 7.2 Test Setup..... 20
 - 7.3 Test Procedure..... 20
 - 7.4 EUT Operating Condition 21
 - 7.5 Test Data..... 21
- 8. OUTPUT POWER TEST 22**
 - 8.1 Test Standard and Limit..... 22
 - 8.2 Test Setup..... 22
 - 8.3 Test Procedure..... 22

8.4 EUT Operating Condition	22
8.5 Test Date.....	22
9. POWER SPECTRAL DENSITY TEST	23
9.1 Test Standard and Limit.....	23
9.2 Test Setup.....	23
9.3 Test Procedure.....	23
9.4 EUT Operating Condition	24
9.5 Test Data.....	24
10. FREQUENCY STABILITY MEASUREMENT	25
10.1 Test Standard and Limit	25
10.2 Test Setup.....	25
10.3 Test Procedure.....	25
10.4 EUT Operating Condition	25
11. ANTENNA REQUIREMENT.....	26
11.1 Standard Requirement.....	26
11.2 Antenna Connected Construction.....	26
11.3 Result.....	26
ATTACHMENT A-- CONDUCTED EMISSION TEST DATA	27
ATTACHMENT B-- RADIATED EMISSION TEST DATA	29
ATTACHMENT C-- RESTRICTED BANDS REQUIREMENT AND BAND-EDGE TEST DATA	63
ATTACHMENT D--BANDWIDTH TEST DATA.....	93
ATTACHMENT E--AVG OUTPUT POWER TEST DATA	105
ATTACHMENT F-- POWER SPECTRAL DENSITY TEST DATA.....	111
ATTACHMENT G----FREQUENCY STABILITY MEASUREMENT DATA.....	119

1. General Information about EUT

1.1 Client Information

Applicant	:	Advanced Technologies Group, LLC
Address	:	1601 48th St #220, West Des Moines, IA 50266, USA
Manufacturer	:	Shenzhen Ployer Electronics Co., Ltd
Address	:	Building 8, Dongfang Jianfu Yusheng Industrial Park, Gushu, Xixiang, Baoan District, Shenzhen, 518000, China.

1.2 General Description of EUT (Equipment Under Test)

EUT Name	:	SCORE 7
Models No.	:	ATG 708
Model Difference	:	N/A
Product Description	:	Operation Frequency: U-NII-1: 5180MHz~5240MHz; U-NII-3: 5745MHz~5825MHz
	:	RF Output Power: U-NII-1-802.11 a:6.44dBm(Max) U-NII-3-802.11 a:6.52dBm(Max)
	:	Antenna Gain: 1.34dBi PIFA Antenna for 5G WiFi
	:	Modulation Type: 802.11a: OFDM (QPSK, BPSK, 16QAM) 802.11n: OFDM (QPSK, BPSK, 16QAM, 64QAM)
	:	Bit Rate of Transmitter: 802.11a: 6/9/12/18/24/36/48/54 Mbps 802.11n: up to 150Mbps
Power Rating	:	Input: DC 4V 1.5A Output: DC 5V 200Ma DC 3.7V by 4000mAh Li-ion battery
Software Version	:	V01
Hardware Version	:	V02
Connecting I/O Port(S)	:	Please refer to the User's Manual

Note:

- (1) This Test Report is FCC Part 15, Subpart E(15.407) for 802.11a/n, the test procedure follows the KDB 789033 D02 General U-NII Test Procedures New Rules v02r01. More detailed features description, please refer to the manufacturer's specifications or the User's Manual.

(2) Channel List:

5G Band 5150~5250 MHz (U-NII-1)				
Frequency Band	Channel No.	Frequency	Channel No.	Frequency
5180~5240 MHz Band 1	36	5180 MHz	44	5220 MHz
	38	5190 MHz	46	5230 MHz
	40	5200 MHz	48	5240 MHz
	42	5210 MHz		
Remark: For 20 MHz Bandwidth, use channel 36, 40, 44, 48. For 40 MHz Bandwidth, use channel 38, 46.				
5G Band 5745~5825 MHz(U-NII-3)				
Frequency Band	Channel No.	Frequency	Channel No.	Frequency
5745~5825 MHz Band 4	149	5745 MHz	157	5785 MHz
	151	5755 MHz	159	5795 MHz
	153	5765 MHz	161	5805 MHz
	155	5775 MHz	165	5825 MHz
Remark: For 20 MHz Bandwidth, use channel 149, 153, 157, 161, 165. For 40 MHz Bandwidth, use channel 151, 159.				

1.3 Block Diagram Showing the Configuration of System Tested

TX mode

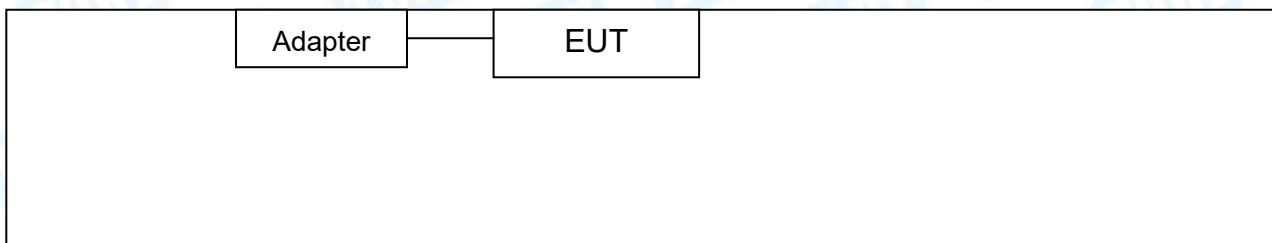

1.4 Description of Support Units

Name	Model	S/N	Manufacturer	Used “√”
Adapter	/	/	baishiyuan	√

1.5 Description of Test Mode

To investigate the maximum EMI emission characteristics generated from EUT, the test system was pre-scanning tested based on the consideration of following EUT operation mode or test configuration mode which possibly have effect on EMI emission level. Each of these EUT operation mode(s) or test configuration mode(s) mentioned follows was evaluated respectively.

For Conducted Test		
Final Test Mode	Description	
Mode 1	TX 802.11a Mode	
For Radiated Test		
Test Band	Final Test Mode	Description
U-NII-1	Mode 2	TX Mode 802.11a Mode Channel 36/40/48
	Mode 3	TX Mode 802.11n(HT20) Mode Channel 36/40/48
	Mode 4	TX Mode 802.11n(HT40) Mode Channel 38/46
U-NII-3	Mode 8	TX Mode 802.11a Mode Channel 149/157/165
	Mode 9	TX Mode 802.11n(HT20) Mode Channel 149/157/165
	Mode 10	TX Mode 802.11n(HT40) Mode Channel 151/159

Note:

- (1) For all test, we have verified the construction and function in typical operation. And all the test modes were carried out with the EUT in transmitting operation in maximum power with all kinds of data rate.

According to ANSI C63.10 standards, the measurements are performed at the highest, middle, lowest available channels, and the worst case data rate as follows:

802.11a Mode: OFDM (6 Mbps)

802.11n (HT20) Mode: MCS 8

802.11n (HT40) Mode: MCS 8

- (2) During the testing procedure, the continuously transmitting with the maximum power mode was programmed by the customer.
- (3) The EUT is considered a mobile unit; in normal use it was positioned on X-plane. The worst case was found positioned on X-plane. Therefore only the test data of this X-plane was used for radiated emission measurement test.

1.6 Description of Test Software Setting

During testing channel & Power controlling software provided by the customer was used to control the operating channel as well as the output power level. The RF output power selection is for the setting of RF output power expected by the customer and is going to be fixed on the firmware of the final end product power parameters of WLAN.

Test Software: RF TEST		
Test Mode: Continuously transmitting		
U-NII-1		
Mode	Frequency (MHz)	Parameters
		ANT.
802.11a	5180	60
	5200	60
	5240	60
802.11n (HT20)	5180	65
	5200	65
	5240	65
802.11n (HT40)	5190	65
	5230	65
U-NII-3		
Mode	Frequency (MHz)	Parameters
		ANT.
802.11a	5745	48
	5785	48
	5825	48
802.11n (HT20)	5745	50
	5785	50
	5825	50
802.11n (HT40)	5755	50
	5795	50

1.7 Test Facility

The testing was performed by the Shenzhen Toby Technology Co., Ltd., in their facilities located at:1A/F., Bldg.6, Yusheng Industrial Zone, The National Road No.107 Xixiang Section 467, Xixiang, Bao'an, Shenzhen, Guangdong, China.

At the time of testing, the following bodies accredited the Laboratory:

CNAS (L5813)

The Laboratory has been accredited by CNAS to ISO/IEC 17025: 2005 General Requirements for the Competence of Testing and Calibration Laboratories for the competence in the field of testing. And the Registration No.: CNAS L5813.

A2LA Certificate No.: 4750.01

The laboratory has been accredited by American Association for Laboratory Accreditation(A2LA) to ISO/IEC 17025: 2005 General Requirements for the Competence of Testing and Calibration Laboratories for the technical competence in the field of Electrical Testing. And the A2LA Certificate No.: 4750.01.FCC Accredited Test Site Number: 854351.

IC Registration No.: (11950A-1)

The Laboratory has been registered by Certification and Engineering Bureau of Industry Canada for radio equipment testing. The site registration: Site# 11950A-1.

2. Test Summary

FCC Part 15 Subpart E(15.407)			
Standard Section	Test Item	Judgment	Remark
FCC			
15.203	Antenna Requirement	PASS	N/A
15.207	Conducted Emission	PASS	N/A
15.407(b)	Band Edge Emissions	PASS	N/A
15.407(a)	26dB Bandwidth&99% Bandwidth	PASS	N/A
15.407(e)	6dB Bandwidth(only for UNII-3)	PASS	N/A
15.407(a)	AVG Output Power	PASS	N/A
15.407(a)	Power Spectral Density	PASS	N/A
15.407(b)	Transmitter Radiated Spurious Emission	PASS	N/A
15.407(a)	Peak Excursion	PASS	N/A
15.407(g)	Frequency Stability	PASS	N/A

Note: "/" for no requirement for this test item.
N/A is an abbreviation for Not Applicable.

3. Test Equipment

Conducted Emission Test					
Equipment	Manufacturer	Model No.	Serial No.	Last Cal.	Cal. Due Date
EMI Test Receiver	Rohde & Schwarz	ESCI	100321	Jul. 13, 2019	Jul. 12, 2020
RF Switching Unit	Compliance Direction Systems Inc	RSU-A4	34403	Jul. 13, 2019	Jul. 12, 2020
AMN	SCHWARZBECK	NNBL 8226-2	8226-2/164	Jul. 13, 2019	Jul. 12, 2020
LISN	Rohde & Schwarz	ENV216	101131	Jul. 13, 2019	Jul. 12, 2020
Radiation Emission Test					
Equipment	Manufacturer	Model No.	Serial No.	Last Cal.	Cal. Due Date
Spectrum Analyzer	Agilent	E4407B	MY45106456	Jul. 13, 2019	Jul. 12, 2020
EMI Test Receiver	Rohde & Schwarz	ESPI	100010/007	Jul. 13, 2019	Jul. 12, 2020
Spectrum Analyzer	Rohde & Schwarz	FSVR	1311.006K40-10 0945-DH	Feb. 10, 2019	Feb. 09, 2020
Bilog Antenna	ETS-LINDGREN	3142E	00117537	Jan. 27, 2019	Jan. 26, 2020
Bilog Antenna	ETS-LINDGREN	3142E	00117542	Jan. 27, 2019	Jan. 26, 2020
Horn Antenna	ETS-LINDGREN	3117	00143207	Mar.03, 2019	Mar. 02, 2020
Horn Antenna	ETS-LINDGREN	3117	00143209	Mar.03, 2019	Mar. 02, 2020
Horn Antenna	ETS-LINDGREN	BBHA 9170	BBHA9170582	Mar.03, 2019	Mar. 02, 2020
Loop Antenna	SCHWARZBECK	FMZB 1519 B	1519B-059	Jul. 13, 2019	Jul. 12, 2020
Pre-amplifier	Sonoma	310N	185903	Mar.04, 2019	Mar. 03, 2020
Pre-amplifier	HP	8449B	3008A00849	Mar.03, 2019	Mar. 02, 2020
Pre-amplifier	EMCI	EMC02325	980217	Mar.03, 2019	Mar. 02, 2020
Cable	HUBER+SUHNER	100	SUCOFLEX	Mar.03, 2019	Mar. 02, 2020
Positioning Controller	ETS-LINDGREN	2090	N/A	N/A	N/A
Antenna Conducted Emission					
Equipment	Manufacturer	Model No.	Serial No.	Last Cal.	Cal. Due Date
Spectrum Analyzer	Agilent	E4407B	MY45106456	Jul. 13, 2019	Jul. 12, 2020
Spectrum Analyzer	Rohde & Schwarz	ESCI	100010/007	Jul. 13, 2019	Jul. 12, 2020
MXA Signal Analyzer	Agilent	N9020A	MY49100060	Sep. 16, 2019	Sep. 15, 2020
Vector Signal Generator	Agilent	N5182A	MY50141294	Sep. 16, 2019	Sep. 15, 2020
Analog Signal Generator	Agilent	N5181A	MY50141953	Sep. 16, 2019	Sep. 15, 2020
RF Power Sensor	DARE!! Instruments	RadiPowerRPR3006W	17100015SNO26	Sep. 16, 2019	Sep. 15, 2020
	DARE!! Instruments	RadiPowerRPR3006W	17100015SNO29	Sep. 16, 2019	Sep. 15, 2020
	DARE!! Instruments	RadiPowerRPR3006W	17100015SNO31	Sep. 16, 2019	Sep. 15, 2020
	DARE!! Instruments	RadiPowerRPR3006W	17100015SNO33	Sep. 16, 2019	Sep. 15, 2020

4. Conducted Emission Test

4.1 Test Standard and Limit

4.1.1 Test Standard
FCC Part 15.207

4.1.2 Test Limit

Conducted Emission Test Limit

Frequency	Maximum RF Line Voltage (dB μ V)	
	Quasi-peak Level	Average Level
150kHz~500kHz	66 ~ 56 *	56 ~ 46 *
500kHz~5MHz	56	46
5MHz~30MHz	60	50

Notes:

- (1) *Decreasing linearly with logarithm of the frequency.
- (2) The lower limit shall apply at the transition frequencies.
- (3) The limit decrease in line with the logarithm of the frequency in the range of 0.15 to 0.50MHz.

4.2 Test Setup

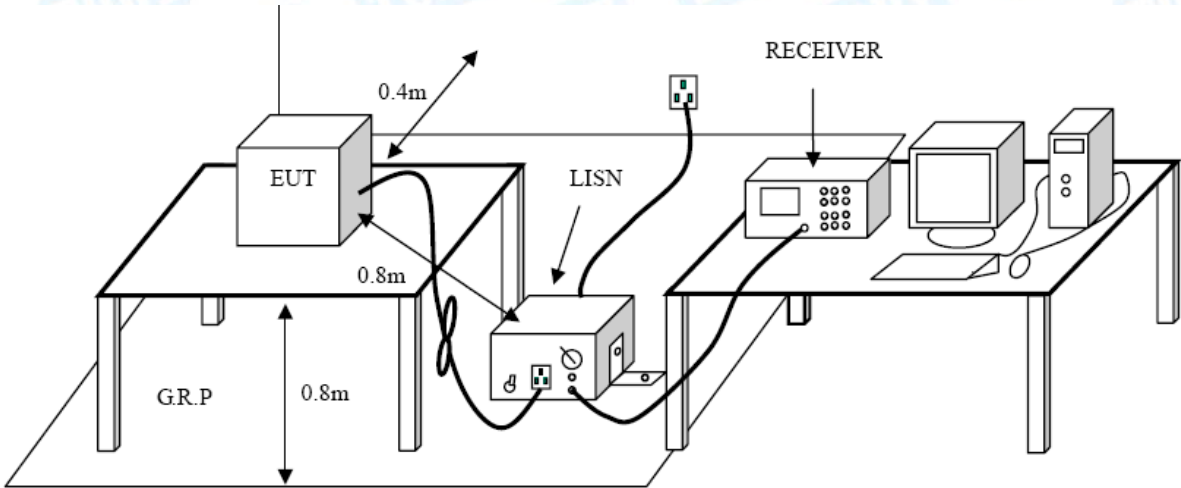

4.3 Test Procedure

The EUT was placed 0.8 meters from the horizontal ground plane with EUT being connected to the power mains through a line impedance stabilization network (LISN). All other support equipments powered from additional LISN(s). The LISN provide 50 Ohm/50uH of coupling impedance for the measuring instrument.

Interconnecting cables that hang closer than 40 cm to the ground plane shall be folded back and forth in the center forming a bundle 30 to 40 cm long.

I/O cables that are not connected to a peripheral shall be bundled in the center. The end of the cable may be terminated, if required, using the correct terminating impedance. The overall length shall not exceed 1 m.

LISN at least 80 cm from nearest part of EUT chassis.

The bandwidth of EMI test receiver is set at 9kHz, and the test frequency band is from 0.15MHz to 30MHz.

4.4 EUT Operating Mode

Please refer to the description of test mode.

4.5 Test Data

Please refer to the Attachment A.

5. Radiated Emission Test

5.1 Test Standard and Limit

5.1.1 Test Standard

FCC Part 15.209

5.1.2 Test Limit

Radiated Emission Limits (9kHz~1000MHz)

Frequency (MHz)	Field Strength (microvolt/meter)	Measurement Distance (meters)
0.009~0.490	2400/F(KHz)	300
0.490~1.705	24000/F(KHz)	30
1.705~30.0	30	30
30~88	100	3
88~216	150	3
216~960	200	3
Above 960	500	3

Radiated Emission Limit (Above 1000MHz)

Frequency (MHz)	Distance of 3m (dBuV/m)	
	Peak	Average
Above 1000	74	54

Note:

- (1) The tighter limit applies at the band edges.
- (2) Emission Level(dBuV/m)=20log Emission Level(uV/m)

Limits of unwanted emission out of the restricted bands

Frequency (MHz)	EIRP Limits (dBm)	Equivalent Field Strength at 3m (dBuV/m)
5150~5250	-27	68.3
5250~5350	-27	68.3
5470~5725	-27	68.3
5725~5825	-27(Note 2)	68.3
	10(Note 2)	105.3
	15.6(Note 2)	110.9
	27(Note 2)	122.3

NOTE:

1, The following formula is used to convert the equipment isotropic radiated power (eirp) to field strength:

$$E = \frac{1000000\sqrt{30P}}{3} \text{ uV/m, where P is the eirp (Watts)}$$

2, According to FCC 16-24, All emissions shall be limited to a level of -27 dBm/MHz at 75 MHz or more above or below the band edge increasing linearly to 10 dBm/MHz at 25 MHz above or below the band edge, and from 25MHz above or below the band edge increasing linearly to a level of 15.6 dBm/MHz at 5 MHz above or below the band edge, and from 5 MHz above or below the band edge increasing linearly to a level of 27dBm/MHz at the band edge.

5.2 Test Setup

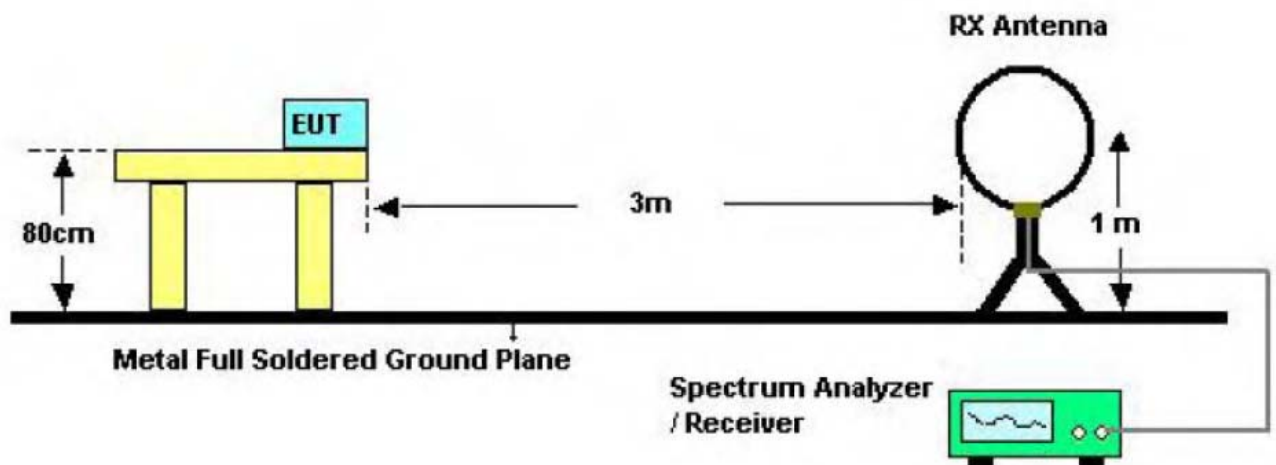

Below 30MHz Test Setup

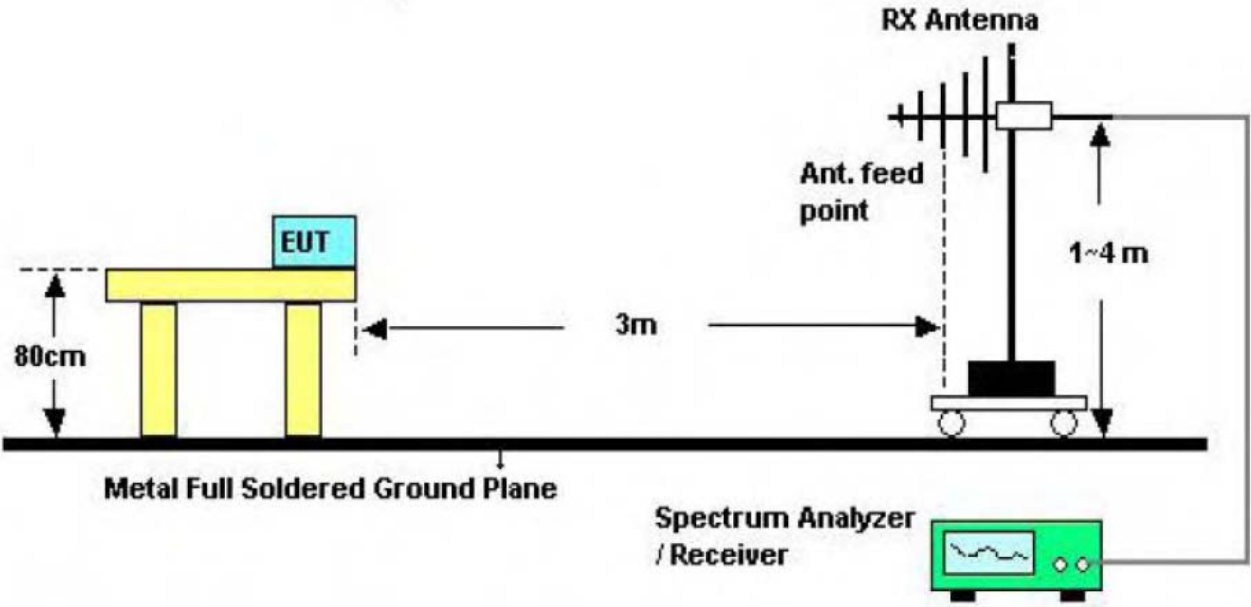

Below 1000MHz Test Setup

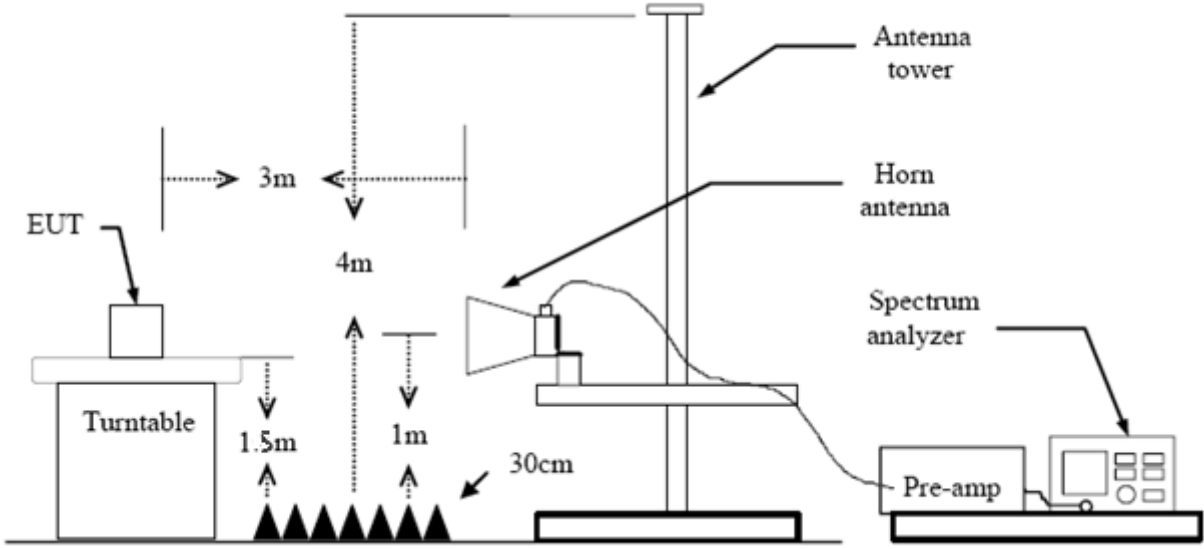

Above 1GHz Test Setup

5.3 Test Procedure

- (1) The measuring distance of 3m shall be used for measurements at frequency up to 1GHz. The EUT was placed on a rotating 0.8m high above the ground, the table was rotated 360 degrees to determine the position of the highest radiation.
- (2) Measurements at frequency above 1GHz. The EUT was placed on a rotating 1.5m high above the ground. RF absorbers covered the ground plane with a minimum area of 3.0m by 3.0m between the EUT and measurement receiver antenna. The RF absorber shall not exceed 30cm in high above the conducting floor. The table was rotated 360 degrees to determine the position of the highest radiation.
- (3) The Test antenna shall vary between 1m and 4m, Both Horizontal and Vertical antenna are set to make measurement.
- (4) The initial step in collecting conducted emission data is a spectrum analyzer peak detector mode pre-scanning the measurement frequency range. Significant peaks are then marked and then Quasi Peak detector mode re-measured.
- (5) If the Peak Mode measured value compliance with and lower than Quasi Peak Mode Limit Bellow 1 GHz, the EUT shall be deemed to meet QP Limits and then no additional QP Mode measurement performed. But the Peak Value and average value both need to comply with applicable limit above 1 GHz.
- (6) Testing frequency range below 1GHz the measuring instrument use VBW=120 kHz with Quasi-peak detection.
- (7) Testing frequency range above 1GHz the measuring instrument use RBW=1 MHz and VBW=3 MHz with Peak Detector for Peak Values, and use RBW=1 MHz and VBW=10 Hz with Peak Detector for Average Values.
- (8) For the actual test configuration, please see the test setup photo.

5.4 EUT Operating Condition

The Equipment Under Test was set to Continual Transmitting in maximum power.

5.5 Test Data

Remark: During testing above 1GHz the measuring instrument use RBW=1 MHz and VBW=3 MHz with Peak Detector for Peak Values, and use RBW=1 MHz and VBW=10 Hz with Peak Detector for Average Values.

Please refer to the Attachment B.

6. Band Edge Emissions

6.1 Test Standard and Limit

6.1.1 Test Standard
 FCC Part 15.407(b)

6.1.2 Test Limit

Limits of unwanted emission out of the restricted bands

Frequency (MHz)	EIRP Limits (dBm)	Equivalent Field Strength at 3m (dBuV/m)
5150~5250	-27	68.3
5250~5350	-27	68.3
5470~5725	-27	68.3
5725~5825	-27(Note 2)	68.3
	10(Note 2)	105.3
	15.6(Note 2)	110.9
	27(Note 2)	122.3

NOTE:

1, The following formula is used to convert the equipment isotropic radiated power (eirp) to field strength:

$$E = \frac{1000000\sqrt{30P}}{3} \text{ uV/m, where P is the eirp (Watts)}$$

2, According to FCC 16-24, All emissions shall be limited to a level of -27 dBm/MHz at 75 MHz or more above or below the band edge increasing linearly to 10 dBm/MHz at 25 MHz above or below the band edge, and from 25MHz above or below the band edge increasing linearly to a level of 15.6 dBm/MHz at 5 MHz above or below the band edge, and from 5 MHz above or below the band edge increasing linearly to a level of 27dBm/MHz at the band edge.

6.2 Test Setup

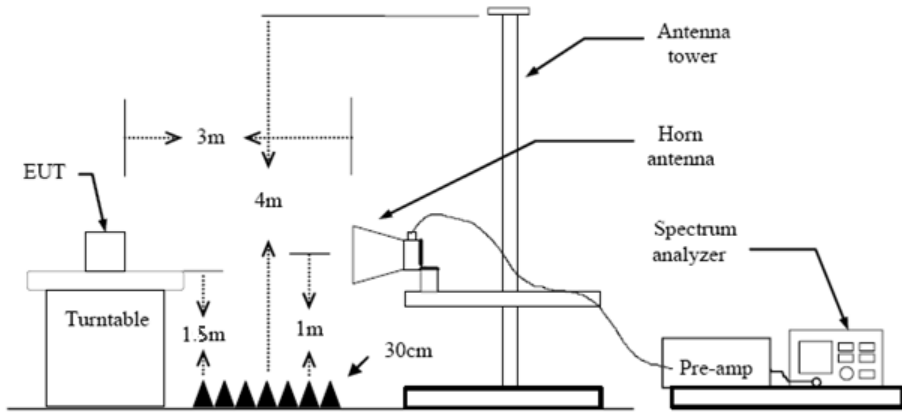

6.3 Test Procedure

- (1) The measuring distance of 3m shall be used for measurements at frequency up to 1GHz. The EUT was placed on a rotating 0.8m high above the ground, the table was rotated 360 degrees to determine the position of the highest radiation.
- (2) Measurements at frequency above 1GHz. The EUT was placed on a rotating 1.5m high above the ground. RF absorbers covered the ground plane with a minimum area of 3.0m by 3.0m between the EUT and measurement receiver antenna. The RF absorber shall not exceed 30cm in high above the conducting floor. The table was rotated 360 degrees to determine the position of the highest radiation.
- (3) The Test antenna shall vary between 1m and 4m, Both Horizontal and Vertical antenna are set to make measurement.
- (4) The initial step in collecting conducted emission data is a spectrum analyzer peak detector mode pre-scanning the measurement frequency range. Significant peaks are then marked and then Quasi Peak detector mode re-measured.
- (5) If the Peak Mode measured value compliance with and lower than Quasi Peak Mode Limit Bellow 1 GHz, the EUT shall be deemed to meet QP Limits and then no additional QP Mode measurement performed. But the Peak Value and average value both need to comply with applicable limit above 1 GHz.
- (6) Testing frequency range below 1GHz the measuring instrument use VBW=120 kHz with Quasi-peak detection.
- (7) Testing frequency range above 1GHz the measuring instrument use RBW=1 MHz and VBW=3 MHz with Peak Detector for Peak Values, and use RBW=1 MHz and VBW=10 Hz with Peak Detector for Average Values.
- (8) For the actual test configuration, please see the test setup photo.

6.4 EUT Operating Condition

The Equipment Under Test was set to Continual Transmitting in maximum power.

6.5 Test Data

Please refer to the Attachment C.

7. Bandwidth Test

7.1 Test Standard and Limit

- 7.1.1 Test Standard
FCC Part 15.407
- 7.1.2 Test Limit

FCC Part 15 Subpart C(15.407)/RSS-210		
Test Item	Limit	Frequency Range (MHz)
26 Bandwidth	N/A	5150~5250
		5250~5350
		5500~5700
6 dB Bandwidth	>500kHz	5725~5850

7.2 Test Setup

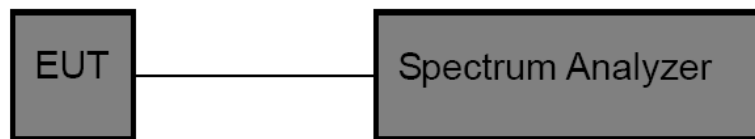

7.3 Test Procedure

- (1) The EUT was directly connected to the spectrum analyzer and antenna output port as show in the block diagram above.
- (2) The setting of the spectrum analyser as below:

26dB Bandwidth Test	
Spectrum Parameters	Setting
Attenuation	Auto
Span	>26 dB Bandwidth
RBW	Approximately 1% of the emission bandwidth
VBW	VBW>RBW
Detector	Peak
Trace	Max Hold
Sweep Time	Auto

6dB Bandwidth Test	
Spectrum Parameters	Setting
Attenuation	Auto
Span	>6 dB Bandwidth
RBW	100 kHz
VBW	VBW>=3*RBW
Detector	Peak
Trace	Max Hold
Sweep Time	Auto
99% Occupied Bandwidth Test	
Spectrum Parameters	Setting
Attenuation	Auto
RBW	1% to 5% of the OBW
VBW	≥ 3RBW
Detector	Peak
Trace	Max Hold

7.4 EUT Operating Condition

The EUT was set to continuously transmitting in each mode and low, Middle and high channel for the test.

7.5 Test Data

Please refer to the Attachment D.

8. Output Power Test

8.1 Test Standard and Limit

8.1.1 Test Standard

FCC Part 15.407 (a)

8.1.2 Test Limit

FCC Part 15 Subpart E(15.407)/RSS-210		
Test Item	Limit	Frequency Range(MHz)
Conducted Output Power	Fixed: 1 Watt (30dBm) Mobile and Portable: 250mW (24dBm)	5150~5250
	250mW (24dBm)	5250~5350
	250mW (24dBm)	5500~5700
	1 Watt (30dBm)	5725~5850

8.2 Test Setup

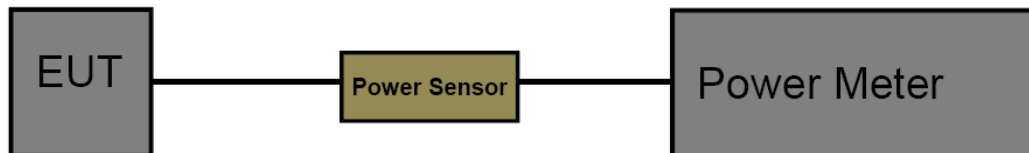

8.3 Test Procedure

The measurement is according to section 3 of KDB 789033 D02 General U-NII Test Procedures New Rules v02r01.

The EUT was connected to RF power meter via a broadband power sensor as show the block above.

8.4 EUT Operating Condition

The EUT was set to continuously transmitting in the max power during the test.

8.5 Test Date

Please refer to the Attachment E.

9. Power Spectral Density Test

9.1 Test Standard and Limit

- 9.1.1 Test Standard
 FCC Part 15.407 (a)
- 9.1.2 Test Limit

FCC Part 15 Subpart E(15.407)		
Test Item	Limit	Frequency Range(MHz)
Power Spectral Density	Other than Mobile and Portable : 17dBm/MHz Mobile and Portable : 11dBm/MHz	5150~5250
	11dBm/MHz	5250~5350
	11dBm/MHz	5500~5700
	30dBm/500kHz	5725~5850

9.2 Test Setup

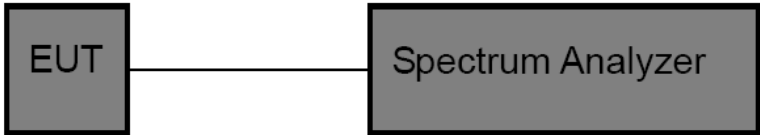

9.3 Test Procedure

The EUT was directly connected to the Spectrum Analyzer and antenna output port as show in the block diagram above. The measurement is according to KDB 789033 D02 General U-NII Test Procedures New Rules v02r01.

- (1) The EUT was directly connected to the spectrum analyzer and antenna output port as show in the block diagram above.
- (2) Set analyser centre frequency to transmitting frequency.
- (3) Set the span to encompass the entire emissions bandwidth (EBW)(alternatively, the entire 99% OBW) of the signal.
- (4) Set the RBW to: 1 MHz
- (5) Set the VBW to: 3 MHz
- (6) Detector: RMS
- (7) Trace: Max Hold
- (7) Sweep time: auto
- (8) Trace average at least 100 traces in power averaging.

- (9) Use the peak marker function to determine the maximum amplitude level within the RBW. Apply correction to the result if different RBW is used.

9.4 EUT Operating Condition

The EUT was set to continuously transmitting in each mode and low, Middle and high channel for the test.

9.5 Test Data

Please refer to the Attachment F.

10. Frequency Stability Measurement

10.1 Test Standard and Limit

- 10.1.1 Test Standard
FCC Part 15.407
- 10.1.2 Test Limit

FCC Part 15 Subpart C(15.407)		
Test Item	Limit	Frequency Range(MHz)
Peak Excursion Measurement	Specified in the user's manual, the transmitter center frequency tolerance shall be ± 20 ppm maximum for the 5 GHz band (IEEE 802.11n specification)	5150~5250
		5250~5350
		5500~5700
		5725~5850

10.2 Test Setup

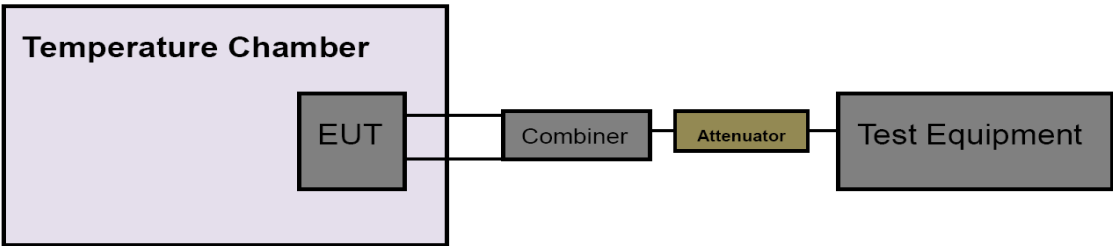

10.3 Test Procedure

The EUT was directly connected to the Spectrum Analyzer and antenna output port as show in the block diagram above.

- (1) The EUT was directly connected to the spectrum analyzer and antenna output port as show in the block diagram above.
- (2) Set analyser centre frequency to transmitting frequency.
- (3) Set the span to encompass the entire emissions bandwidth (EBW) of the signal.
- (4) Set the RBW to: 10 kHz, VBW=10 kHz with peak detector and maxhold settings.
- (5) The test extreme voltage is to change the primary supply voltage from 85 to 115 percent of the nominal value.
- (6) Extreme temperature is 0°C~50°C

10.4 EUT Operating Condition

The EUT was set to continuously transmitting in continuously un-modulation transmitting mode. Please refer to the Attachment G.

11. Antenna Requirement

11.1 Standard Requirement

11.1.1 Standard

FCC Part 15.203

11.1.2 Requirement

An intentional radiator shall be designed to ensure that no antenna other than that furnished by the responsible party shall be used with the device. The use of a permanently attached antenna or of an antenna that uses a unique coupling to the intentional radiator shall be considered sufficient to comply with the provisions of this Section. The manufacturer may design the unit so that a broken antenna can be replaced by the user, but the use of a standard antenna jack or electrical connector is prohibited.

11.2 Antenna Connected Construction

The gains of the antenna used for transmitting is 1.34 dBi, and the antenna de-signed with permanent attachment and no consideration of replacement. Please see the EUT photo for details.

11.3 Result

The EUT antennas are PIFA Antenna. It complies with the standard requirement.

Antenna Type
<input type="checkbox"/> Permanent attached antenna
<input checked="" type="checkbox"/> Unique connector antenna
<input type="checkbox"/> Professional installation antenna

Attachment A-- Conducted Emission Test Data

Remark: All channels have been tested and Shows only the worst channels.

Temperature:	25 °C	Relative Humidity:	55%
Test Voltage:	AC 120V/60 Hz		
Terminal:	Line		
Test Mode:	TX 802.11a Mode CH36		
Remark:	Only worse case is reported		

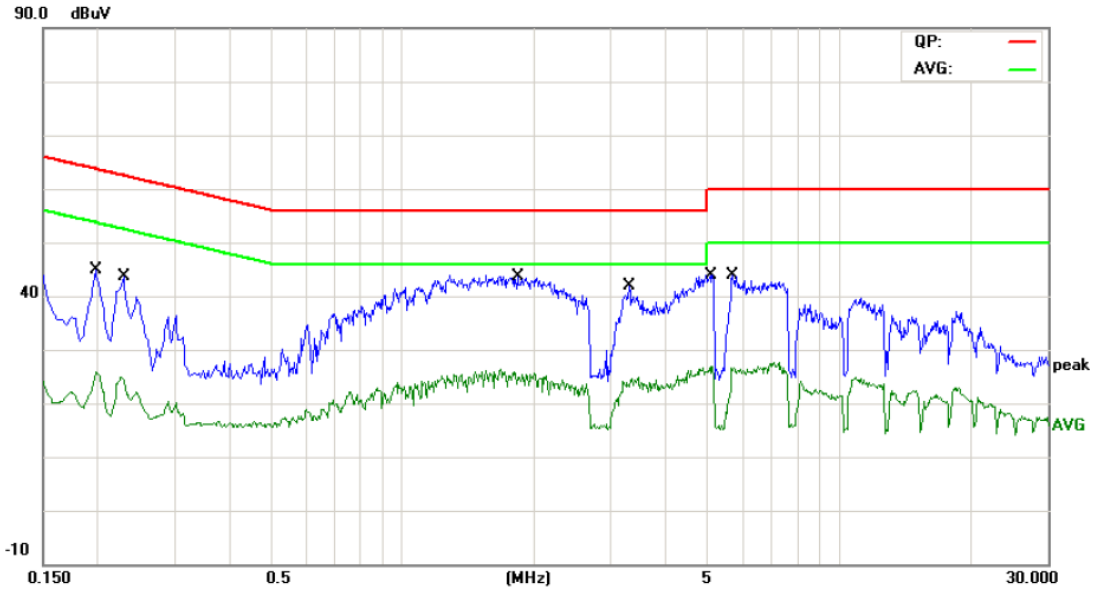

No.	Mk.	Freq. MHz	Reading Level dBuV	Correct Factor dB	Measure- ment dBuV	Limit dBuV	Over dB	Detector
1		0.1980	30.54	9.78	40.32	63.69	-23.37	QP
2		0.1980	13.55	9.78	23.33	53.69	-30.36	AVG
3		0.2300	27.13	9.79	36.92	62.45	-25.53	QP
4		0.2300	13.70	9.79	23.49	52.45	-28.96	AVG
5	*	1.8380	27.75	9.85	37.60	56.00	-18.40	QP
6		1.8380	13.92	9.85	23.77	46.00	-22.23	AVG
7		3.2940	24.06	9.85	33.91	56.00	-22.09	QP
8		3.2940	12.61	9.85	22.46	46.00	-23.54	AVG
9		5.0660	27.46	9.86	37.32	60.00	-22.68	QP
10		5.0660	15.53	9.86	25.39	50.00	-24.61	AVG
11		5.6860	27.50	9.85	37.35	60.00	-22.65	QP
12		5.6860	15.46	9.85	25.31	50.00	-24.69	AVG

*:Maximum data x:Over limit !:over margin

Emission Level= Read Level+ Correct Factor

Temperature:	25 °C	Relative Humidity:	55%
Test Voltage:	AC 120V/60 Hz		
Terminal:	Neutral		
Test Mode:	TX 802.11a Mode CH36		
Remark:	Only worse case is reported		

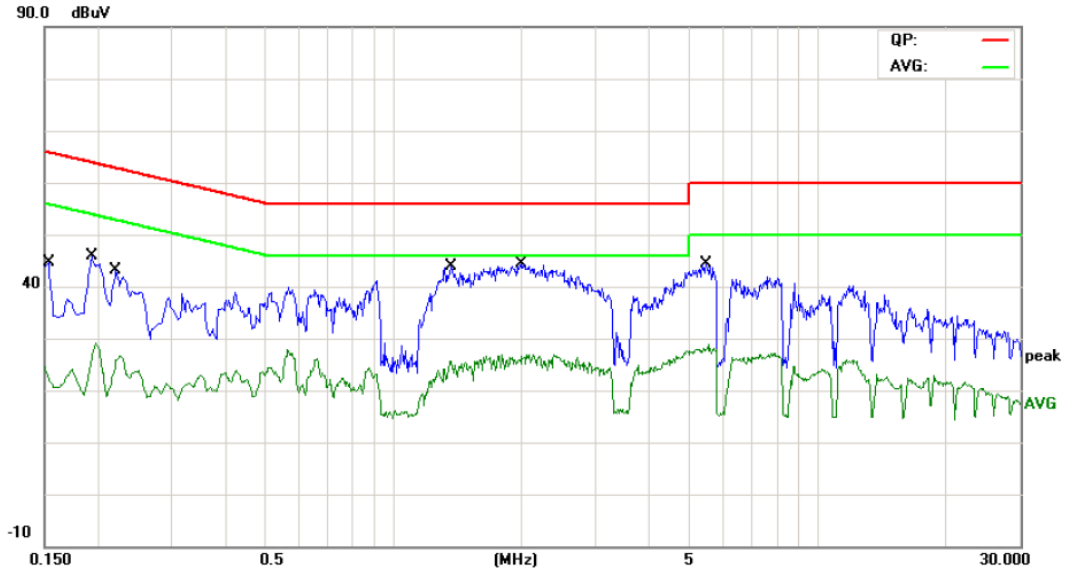

No.	Mk.	Freq. MHz	Reading Level dBuV	Correct Factor dB	Measure- ment dBuV	Limit dBuV	Over dB	Detector
1		0.1539	22.55	9.60	32.15	65.78	-33.63	QP
2		0.1539	9.31	9.60	18.91	55.78	-36.87	AVG
3		0.1940	30.88	9.57	40.45	63.86	-23.41	QP
4		0.1940	16.45	9.57	26.02	53.86	-27.84	AVG
5		0.2220	28.08	9.62	37.70	62.74	-25.04	QP
6		0.2220	15.50	9.62	25.12	52.74	-27.62	AVG
7	*	1.3700	29.56	9.73	39.29	56.00	-16.71	QP
8		1.3700	14.71	9.73	24.44	46.00	-21.56	AVG
9		1.9980	29.20	9.86	39.06	56.00	-16.94	QP
10		1.9980	15.24	9.86	25.10	46.00	-20.90	AVG
11		5.4500	27.90	9.83	37.73	60.00	-22.27	QP
12		5.4500	17.37	9.83	27.20	50.00	-22.80	AVG

*:Maximum data x:Over limit !:over margin

Emission Level= Read Level+ Correct Factor

Attachment B-- Radiated Emission Test Data

9 KHz~30 MHz

From 9 KHz to 30 MHz: Conclusion: PASS

Note: The amplitude of spurious emissions which are attenuated by more than 20dB below the permissible value has no need to be reported.

30MHz~1GHz

Temperature:	25 °C	Relative Humidity:	55%
Test Voltage:	AC 120V/60Hz		
Ant. Pol.	Horizontal		
Test Mode:	TX 802.11a Mode 5180MHz (U-NII-1)		
Remark:	Only worse case is reported		

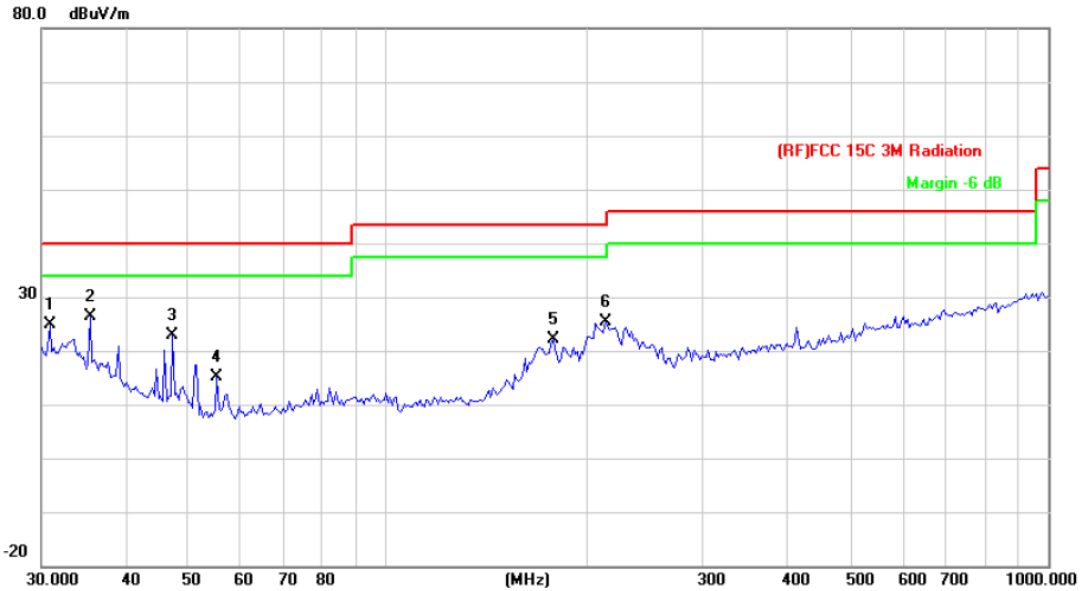

No.	Mk.	Freq. MHz	Reading Level dBuV	Correct Factor dB/m	Measurement dBuV/m	Limit dBuV/m	Over dB	Detector
1		30.8535	38.54	-13.64	24.90	40.00	-15.10	QP
2	*	35.4993	43.48	-17.03	26.45	40.00	-13.55	QP
3		47.3255	45.39	-22.45	22.94	40.00	-17.06	QP
4		55.2207	39.03	-23.92	15.11	40.00	-24.89	QP
5		178.1327	42.31	-20.20	22.11	43.50	-21.39	QP
6		213.7634	44.46	-19.11	25.35	43.50	-18.15	QP

*:Maximum data x:Over limit !:over margin

Emission Level= Read Level+ Correct Factor

Temperature:	25 °C	Relative Humidity:	55%
Test Voltage:	AC 120V/60Hz		
Ant. Pol.	Vertical		
Test Mode:	TX 802.11a Mode 5180MHz (U-NII-1)		
Remark:	Only worse case is reported.		

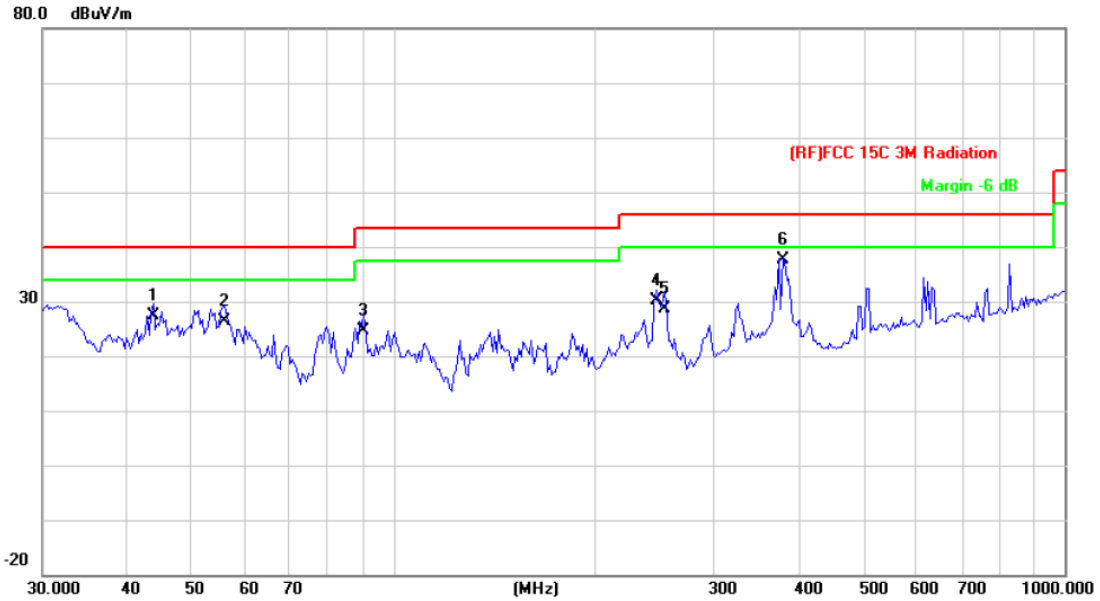

No.	Mk.	Freq. MHz	Reading Level dBuV	Correct Factor dB/m	Measure- ment dBuV/m	Limit dBuV/m	Over dB	Detector
1		43.8119	48.41	-21.07	27.34	40.00	-12.66	QP
2		56.0007	50.33	-24.01	26.32	40.00	-13.68	QP
3		90.2205	46.59	-22.01	24.58	43.50	-18.92	QP
4		245.9507	47.51	-17.27	30.24	46.00	-15.76	QP
5		252.9482	45.62	-16.98	28.64	46.00	-17.36	QP
6	*	379.9141	50.53	-13.01	37.52	46.00	-8.48	QP

*:Maximum data x:Over limit !:over margin

Emission Level= Read Level+ Correct Factor

5180MHz-5250MHz(U-NII-1)

Temperature:	25 °C	Relative Humidity:	55%
Test Voltage:	AC 120V/60Hz		
Ant. Pol.	Horizontal		
Test Mode:	TX 802.11a Mode 5180MHz (U-NII-1)		
Remark:	No report for the emission which more than 20 dB below the prescribed limit. Only worse case is reported.		

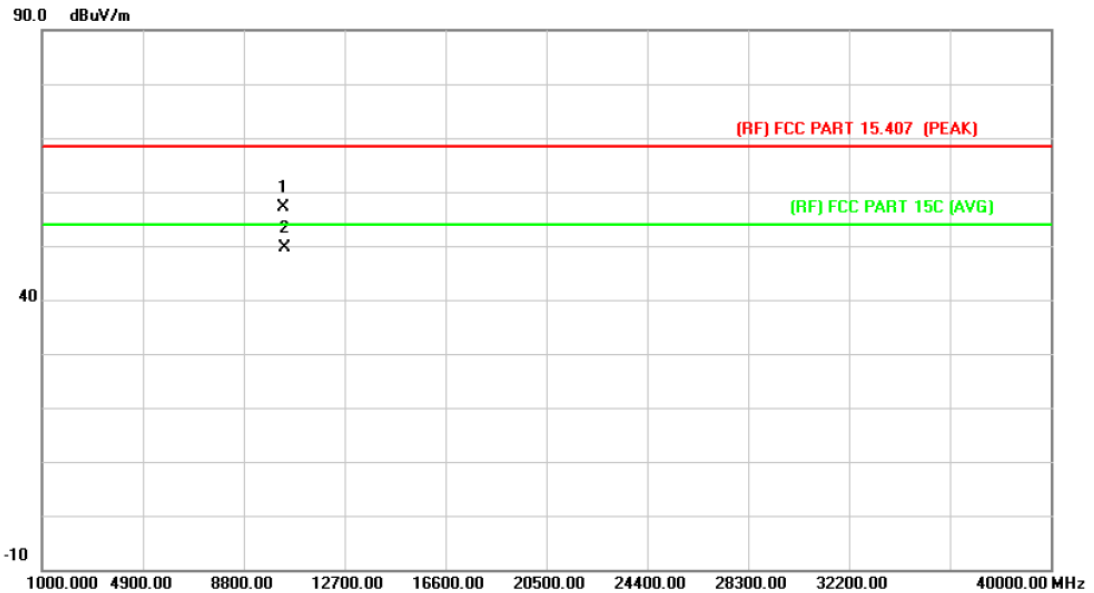

No.	Mk.	Freq. MHz	Reading Level dBuV	Correct Factor dB/m	Measure- ment dBuV/m	Limit dBuV/m	Over dB	Detector
1		10359.788	36.70	20.50	57.20	68.30	-11.10	peak
2	*	10360.225	29.02	20.50	49.52	54.00	-4.48	AVG

Emission Level= Read Level+ Correct Factor

Temperature:	25 °C	Relative Humidity:	55%
Test Voltage:	AC 120V/60Hz		
Ant. Pol.	Vertical		
Test Mode:	TX 802.11a Mode 5180MHz (U-NII-1)		
Remark:	No report for the emission which more than 20 dB below the prescribed limit. Only worse case is reported.		

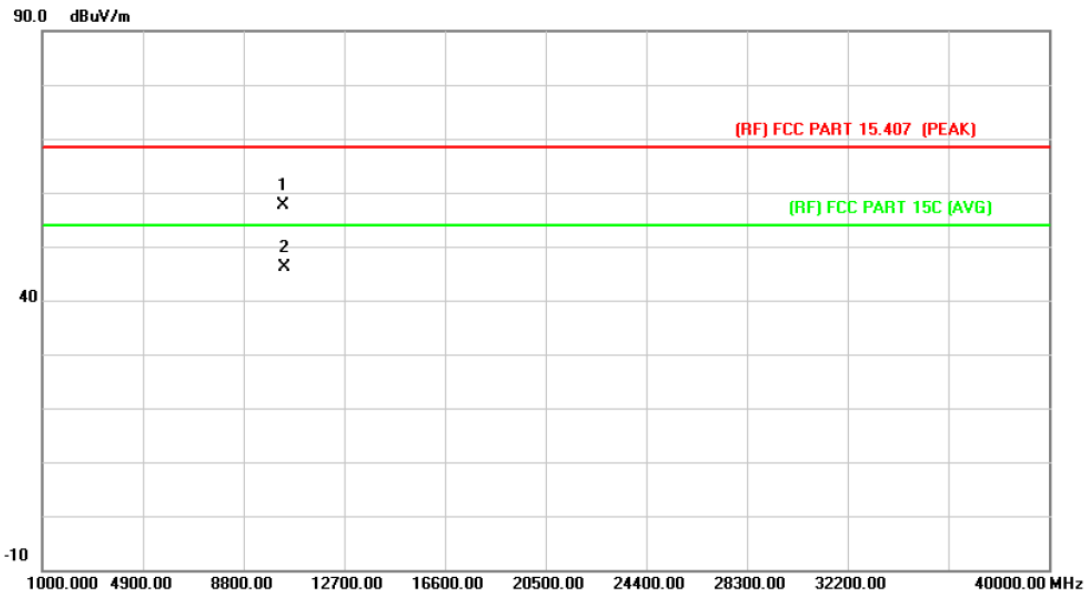

No.	Mk.	Freq.	Reading Level	Correct Factor	Measurement	Limit	Over	
		MHz	dBuV	dB/m	dBuV/m	dBuV/m	dB	Detector
1		10359.650	37.11	20.50	57.61	68.30	-10.69	peak
2	*	10360.295	25.64	20.50	46.14	54.00	-7.86	AVG

Emission Level= Read Level+ Correct Factor

Temperature:	25 °C	Relative Humidity:	55%
Test Voltage:	AC 120V/60Hz		
Ant. Pol.	Horizontal		
Test Mode:	TX 802.11a Mode 5200MHz (U-NII-1)		
Remark:	No report for the emission which more than 20 dB below the prescribed limit.		

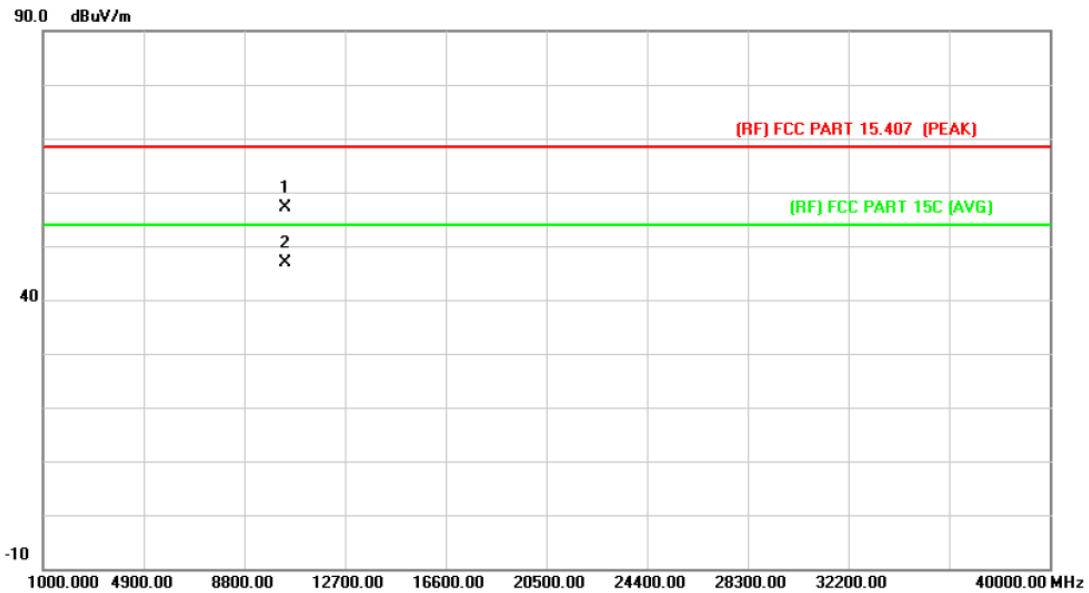

No.	Mk.	Freq. MHz	Reading Level dBuV	Correct Factor dB/m	Measure- ment dBuV/m	Limit dBuV/m	Over dB	Detector
1		10399.507	36.59	20.56	57.15	68.30	-11.15	peak
2	*	10400.198	26.29	20.56	46.85	54.00	-7.15	AVG

Emission Level= Read Level+ Correct Factor

Temperature:	25 °C	Relative Humidity:	55%
Test Voltage:	AC 120V/60Hz		
Ant. Pol.	Vertical		
Test Mode:	TX 802.11a Mode 5200MHz (U-NII-1)		
Remark:	No report for the emission which more than 20 dB below the prescribed limit.		

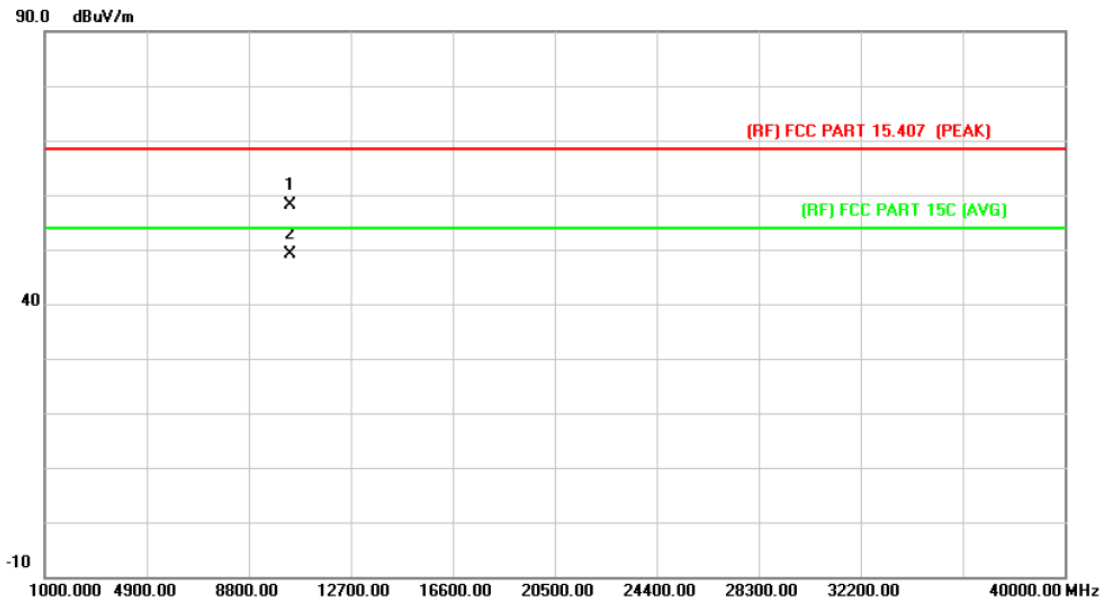

No.	Mk.	Freq. MHz	Reading Level dBuV	Correct Factor dB/m	Measure- ment dBuV/m	Limit dBuV/m	Over dB	Detector
1		10399.985	37.49	20.56	58.05	68.30	-10.25	peak
2	*	10400.442	28.69	20.56	49.25	54.00	-4.75	AVG

Emission Level= Read Level+ Correct Factor

Temperature:	25 °C	Relative Humidity:	55%
Test Voltage:	AC 120V/60Hz		
Ant. Pol.	Horizontal		
Test Mode:	TX 802.11a Mode 5240MHz (U-NII-1)		
Remark:	No report for the emission which more than 20 dB below the prescribed limit.		

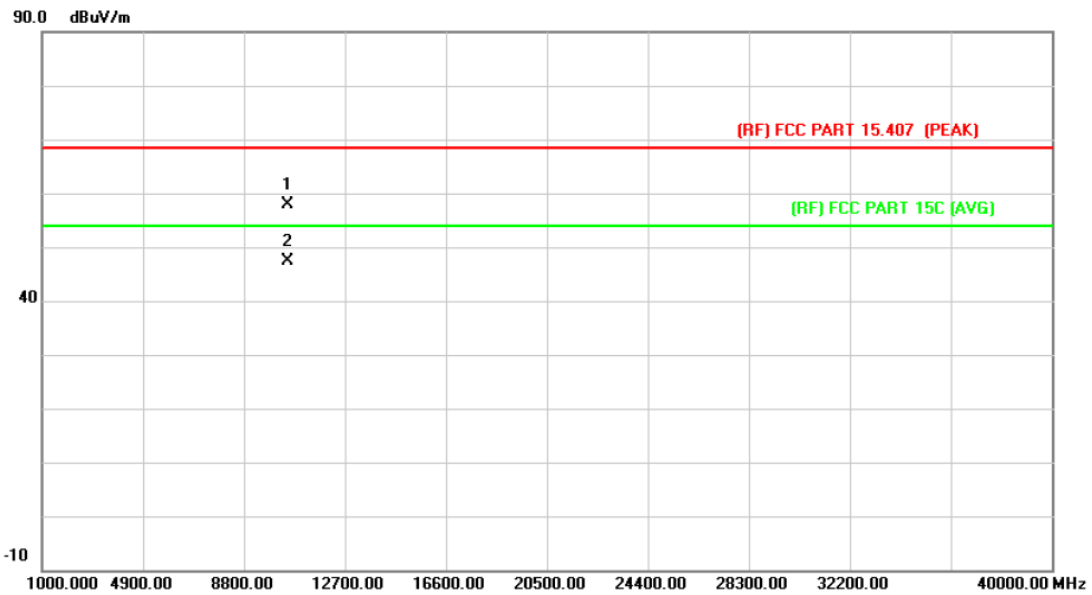

No.	Mk.	Freq. MHz	Reading Level dBuV	Correct Factor dB/m	Measure- ment dBuV/m	Limit dBuV/m	Over dB	Detector
1		10479.708	37.28	20.68	57.96	68.30	-10.34	peak
2	*	10479.728	26.76	20.68	47.44	54.00	-6.56	AVG

Emission Level= Read Level+ Correct Factor

Temperature:	25 °C	Relative Humidity:	55%
Test Voltage:	AC 120V/60Hz		
Ant. Pol.	Vertical		
Test Mode:	TX 802.11a Mode 5240MHz (U-NII-1)		
Remark:	No report for the emission which more than 20 dB below the prescribed limit.		

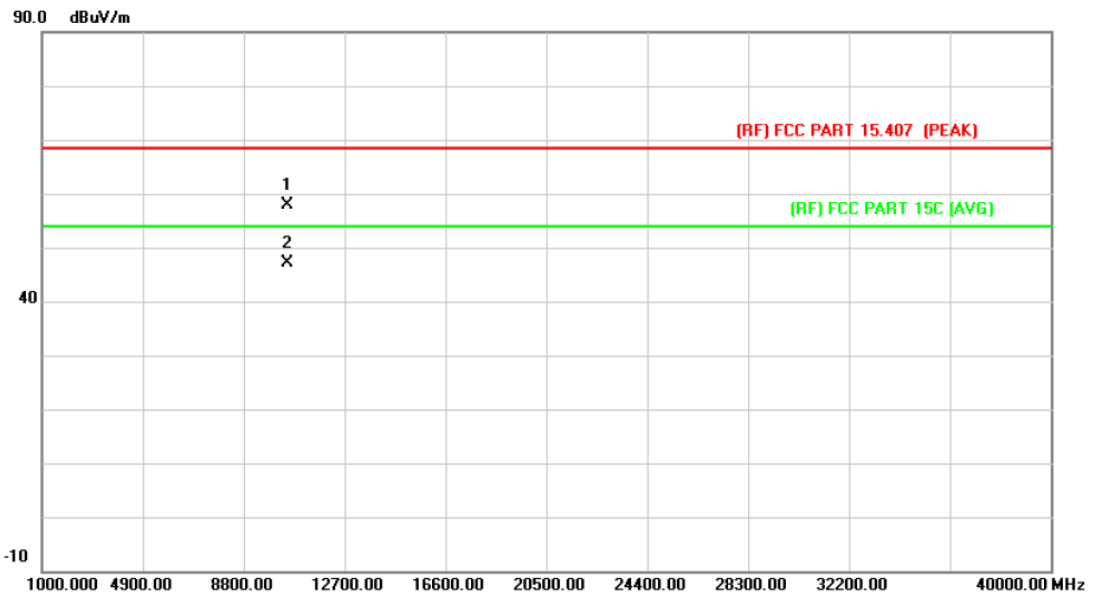

No.	Mk.	Freq. MHz	Reading Level dBuV	Correct Factor dB/m	Measure- ment dBuV/m	Limit dBuV/m	Over dB	Detector
1		10480.365	37.19	20.68	57.87	68.30	-10.43	peak
2	*	10480.365	26.45	20.68	47.13	54.00	-6.87	AVG

Emission Level= Read Level+ Correct Factor

Temperature:	25 °C	Relative Humidity:	55%
Test Voltage:	AC 120V/60Hz		
Ant. Pol.	Horizontal		
Test Mode:	TX 802.11n(HT20) Mode 5180MHz (U-NII-1)		
Remark:	No report for the emission which more than 20 dB below the prescribed limit.		

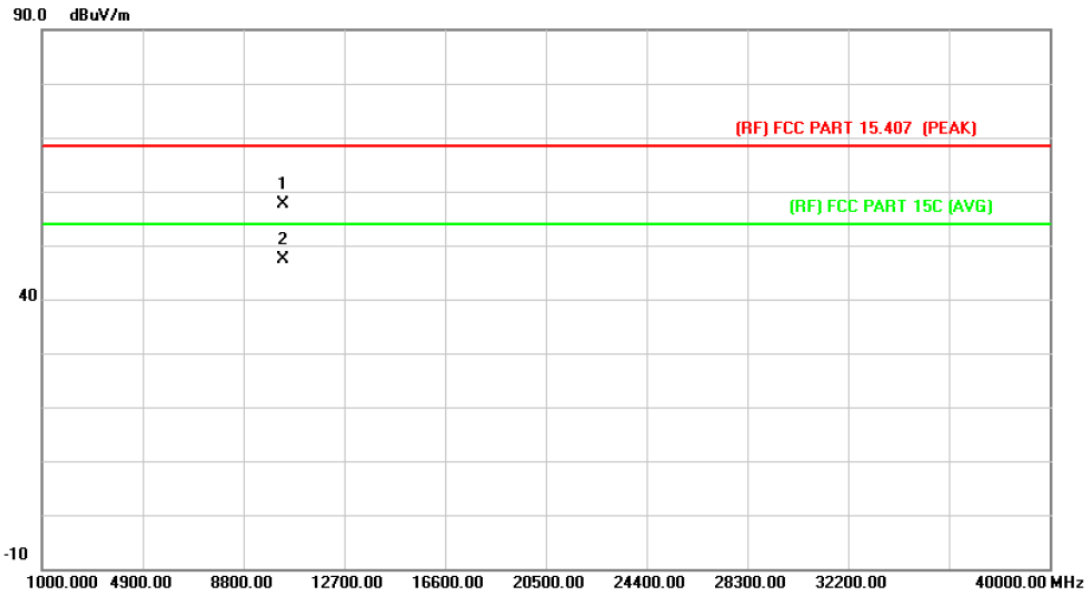

No.	Mk.	Freq. MHz	Reading Level dBuV	Correct Factor dB/m	Measure- ment dBuV/m	Limit dBuV/m	Over dB	Detector
1		10359.548	37.15	20.50	57.65	68.30	-10.65	peak
2	*	10359.640	26.91	20.50	47.41	54.00	-6.59	AVG

Emission Level= Read Level+ Correct Factor

Temperature:	25 °C	Relative Humidity:	55%
Test Voltage:	AC 120V/60Hz		
Ant. Pol.	Vertical		
Test Mode:	TX 802.11n(HT20) Mode 5180MHz (U-NII-1)		
Remark:	No report for the emission which more than 20 dB below the prescribed limit.		

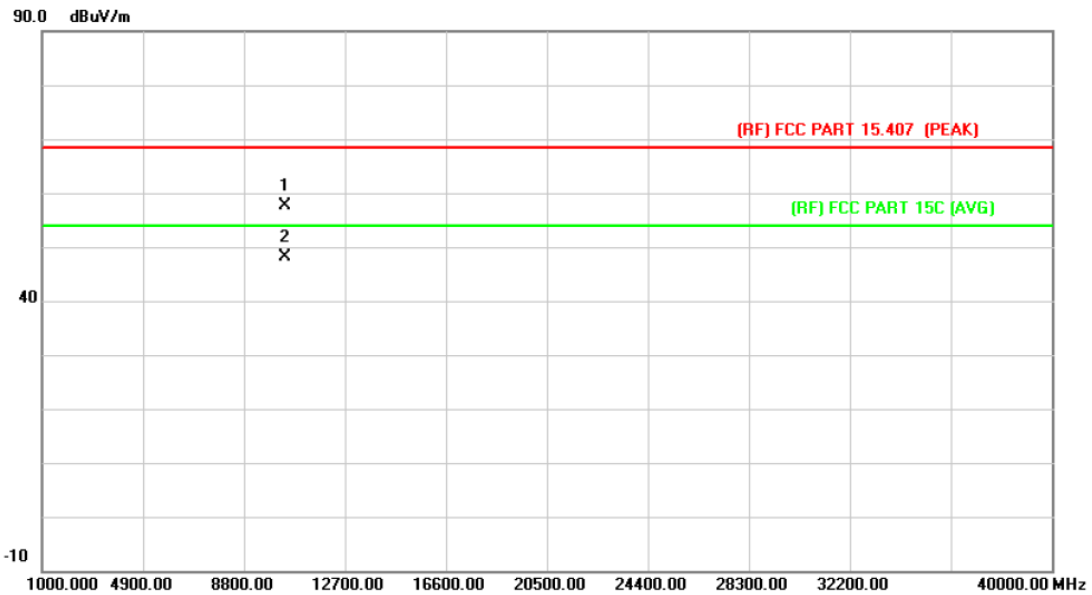

No.	Mk.	Freq. MHz	Reading Level dBuV	Correct Factor dB/m	Measure- ment dBuV/m	Limit dBuV/m	Over dB	Detector
1		10360.058	37.14	20.50	57.64	68.30	-10.66	peak
2	*	10360.353	27.69	20.50	48.19	54.00	-5.81	AVG

Emission Level= Read Level+ Correct Factor

Temperature:	25 °C	Relative Humidity:	55%
Test Voltage:	AC 120V/60Hz		
Ant. Pol.	Horizontal		
Test Mode:	TX 802.11n(HT20) Mode 5200MHz (U-NII-1)		
Remark:	No report for the emission which more than 20 dB below the prescribed limit.		

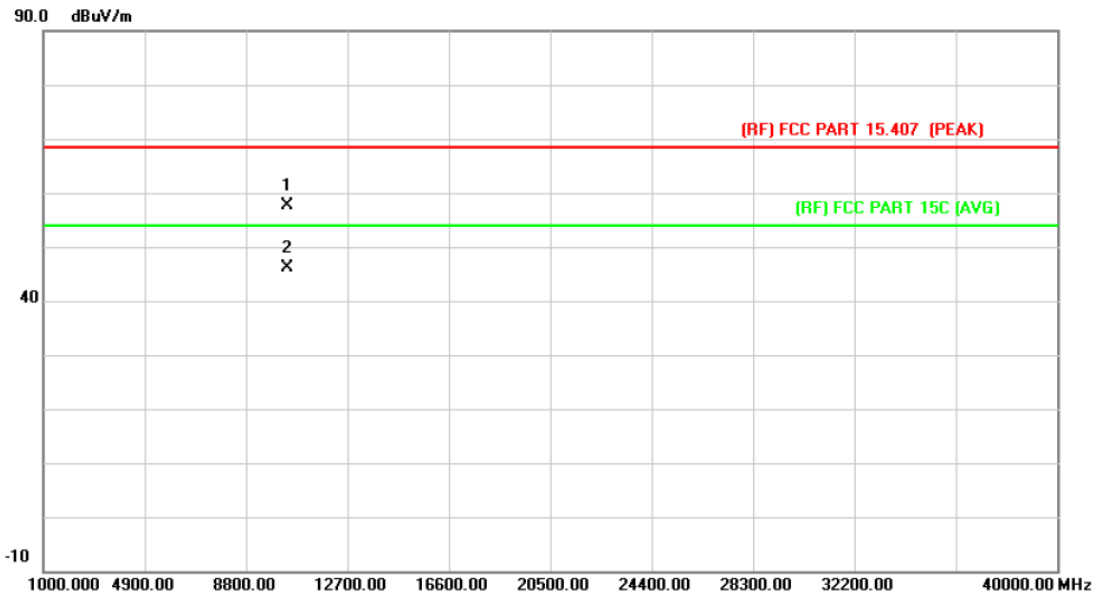

No.	Mk.	Freq. MHz	Reading Level dBuV	Correct Factor dB/m	Measure- ment dBuV/m	Limit dBuV/m	Over dB	Detector
1		10399.728	37.11	20.56	57.67	68.30	-10.63	peak
2	*	10399.813	25.63	20.56	46.19	54.00	-7.81	AVG

Emission Level= Read Level+ Correct Factor

Temperature:	25 °C	Relative Humidity:	55%
Test Voltage:	AC 120V/60Hz		
Ant. Pol.	Vertical		
Test Mode:	TX 802.11n(HT20) Mode 5200MHz (U-NII-1)		
Remark:	No report for the emission which more than 20 dB below the prescribed limit.		

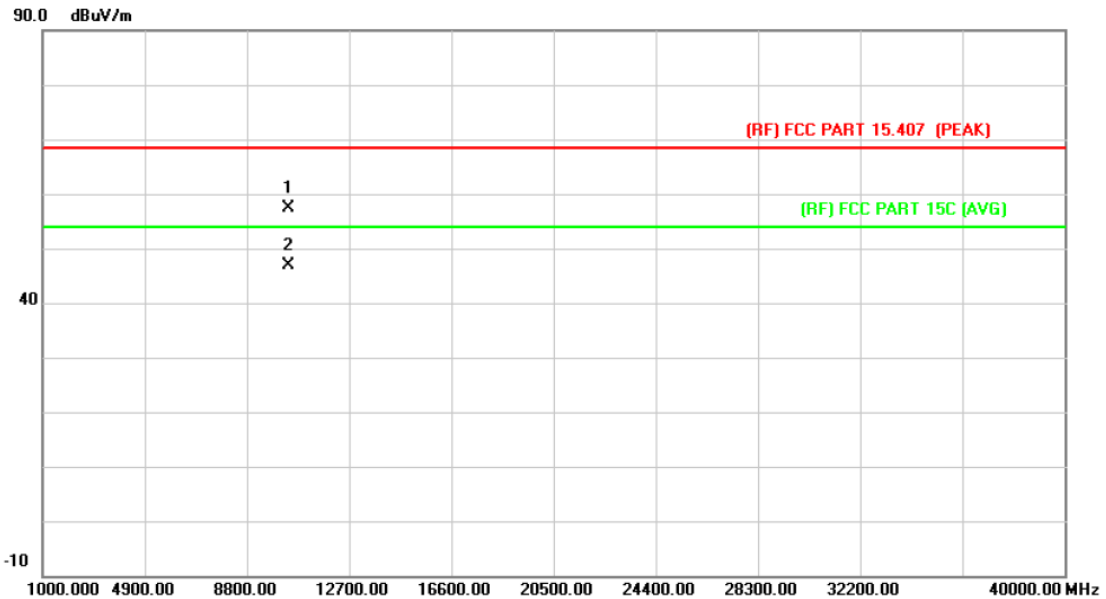

No.	Mk.	Freq. MHz	Reading Level dBuV	Correct Factor dB/m	Measure- ment dBuV/m	Limit dBuV/m	Over dB	Detector
1		10400.200	36.94	20.56	57.50	68.30	-10.80	peak
2	*	10400.430	26.32	20.56	46.88	54.00	-7.12	AVG

Emission Level= Read Level+ Correct Factor

Temperature:	25 °C	Relative Humidity:	55%
Test Voltage:	AC 120V/60Hz		
Ant. Pol.	Horizontal		
Test Mode:	TX 802.11n(HT20) Mode 5240MHz (U-NII-1)		
Remark:	No report for the emission which more than 20 dB below the prescribed limit.		

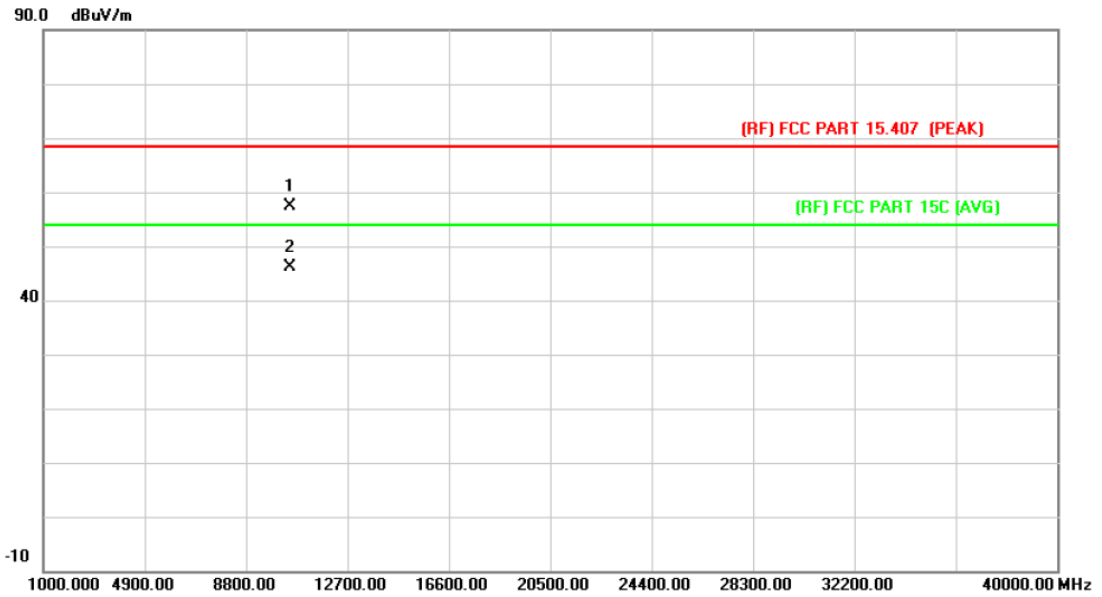

No.	Mk.	Freq. MHz	Reading Level dBuV	Correct Factor dB/m	Measure- ment dBuV/m	Limit dBuV/m	Over dB	Detector
1		10479.683	36.70	20.68	57.38	68.30	-10.92	peak
2	*	10479.813	25.51	20.68	46.19	54.00	-7.81	AVG

Emission Level= Read Level+ Correct Factor

Temperature:	25 °C	Relative Humidity:	55%
Test Voltage:	AC 120V/60Hz		
Ant. Pol.	Vertical		
Test Mode:	TX 802.11n(HT20) Mode 5240MHz (U-NII-1)		
Remark:	No report for the emission which more than 20 dB below the prescribed limit.		

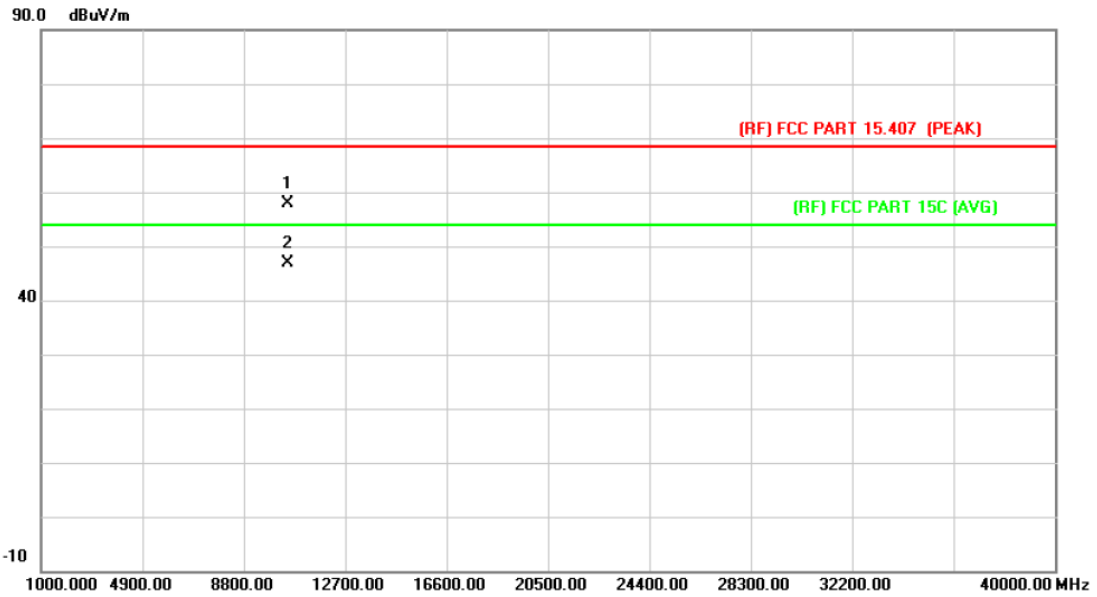

No.	Mk.	Freq. MHz	Reading Level dBuV	Correct Factor dB/m	Measure- ment dBuV/m	Limit dBuV/m	Over dB	Detector
1		10479.647	37.23	20.68	57.91	68.30	-10.39	peak
2	*	10479.970	26.10	20.68	46.78	54.00	-7.22	AVG

Emission Level= Read Level+ Correct Factor

Temperature:	25 °C	Relative Humidity:	55%
Test Voltage:	AC 120V/60Hz		
Ant. Pol.	Horizontal		
Test Mode:	TX 802.11n(HT40) Mode 5190MHz (U-NII-1)		
Remark:	No report for the emission which more than 20 dB below the prescribed limit.		

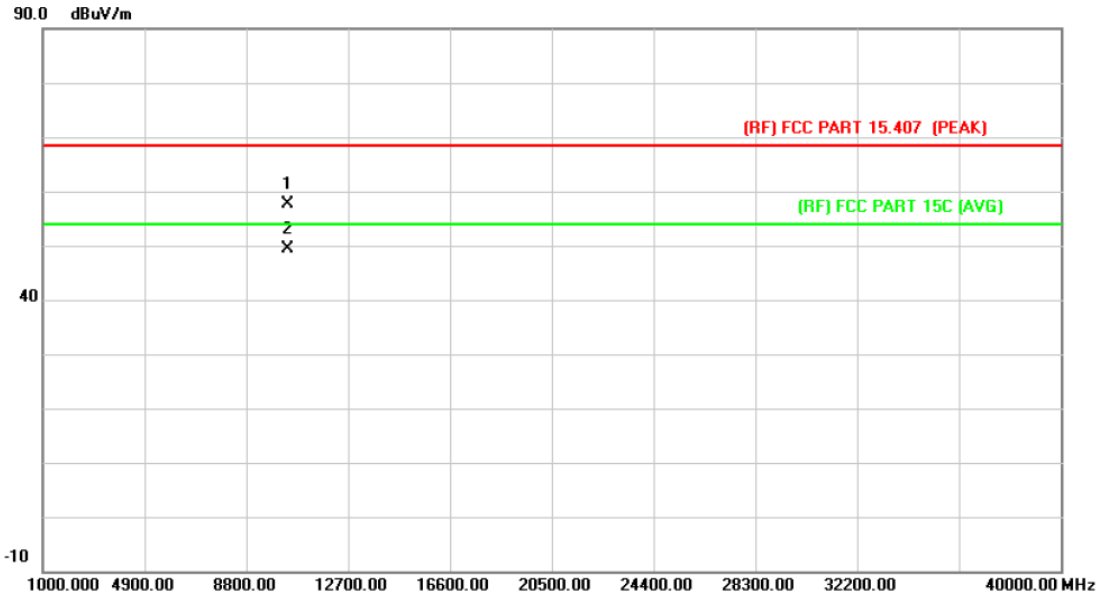

No.	Mk.	Freq. MHz	Reading Level dBuV	Correct Factor dB/m	Measure- ment dBuV/m	Limit dBuV/m	Over dB	Detector
1		10379.625	37.14	20.53	57.67	68.30	-10.63	peak
2	*	10380.365	28.74	20.53	49.27	54.00	-4.73	AVG

Emission Level= Read Level+ Correct Factor

Temperature:	25 °C	Relative Humidity:	55%
Test Voltage:	AC 120V/60Hz		
Ant. Pol.	Vertical		
Test Mode:	TX 802.11n(HT40) Mode 5190MHz (U-NII-1)		
Remark:	No report for the emission which more than 20 dB below the prescribed limit.		

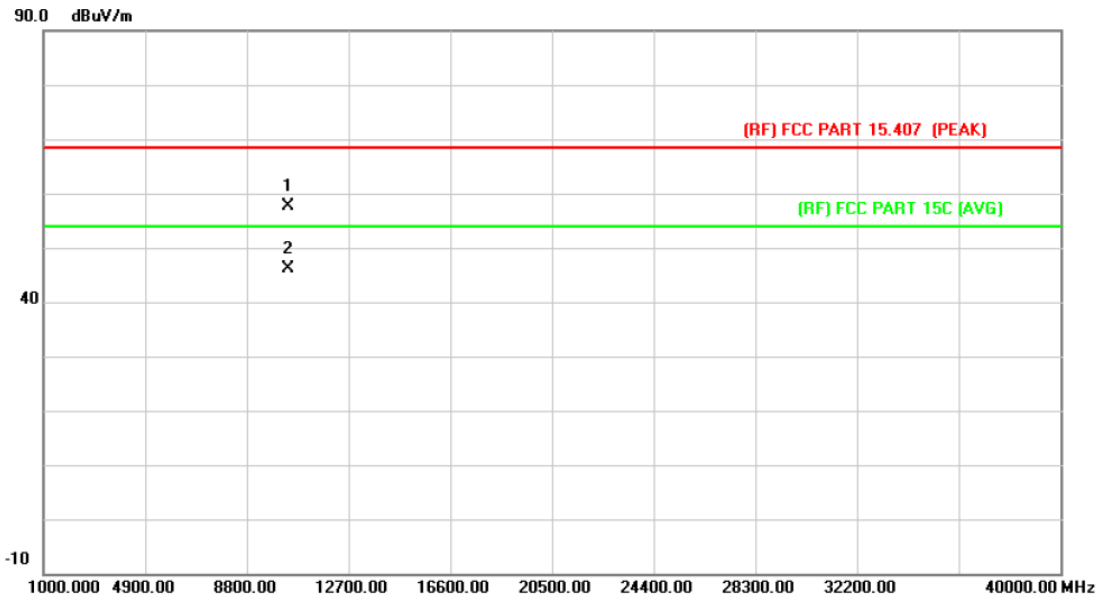

No.	Mk.	Freq. MHz	Reading Level dBuV	Correct Factor dB/m	Measure- ment dBuV/m	Limit dBuV/m	Over dB	Detector
1		10379.625	37.22	20.53	57.75	68.30	-10.55	peak
2	*	10379.782	25.68	20.53	46.21	54.00	-7.79	AVG

Emission Level= Read Level+ Correct Factor

Temperature:	25 °C	Relative Humidity:	55%
Test Voltage:	AC 120V/60Hz		
Ant. Pol.	Horizontal		
Test Mode:	TX 802.11n(HT40) Mode 5230MHz (U-NII-1)		
Remark:	No report for the emission which more than 20 dB below the prescribed limit.		

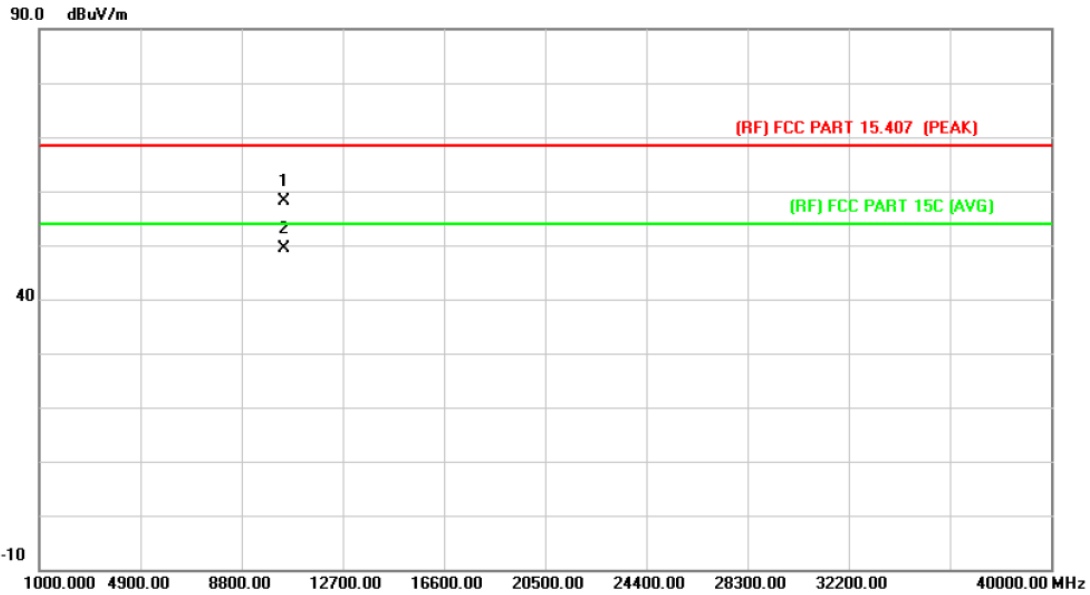

No.	Mk.	Freq. MHz	Reading Level dBuV	Correct Factor dB/m	Measure- ment dBuV/m	Limit dBuV/m	Over dB	Detector
1		10460.083	37.57	20.65	58.22	68.30	-10.08	peak
2	*	10460.380	28.62	20.65	49.27	54.00	-4.73	AVG

Emission Level= Read Level+ Correct Factor

Temperature:	25 °C	Relative Humidity:	55%
Test Voltage:	AC 120V/60Hz		
Ant. Pol.	Vertical		
Test Mode:	TX 802.11n(HT40) Mode 5230MHz (U-NII-1)		
Remark:	No report for the emission which more than 20 dB below the prescribed limit.		

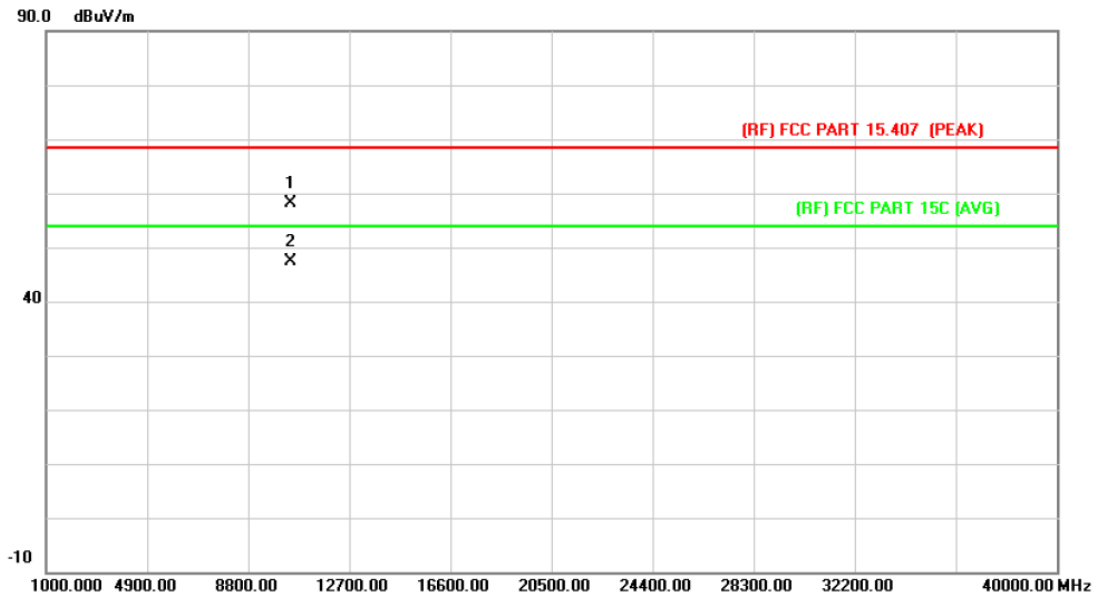

No.	Mk.	Freq.	Reading Level	Correct Factor	Measurement	Limit	Over	
		MHz	dBuV	dB/m	dBuV/m	dBuV/m	dB	Detector
1		10460.075	37.39	20.65	58.04	68.30	-10.26	peak
2	*	10460.267	26.61	20.65	47.26	54.00	-6.74	AVG

Emission Level= Read Level+ Correct Factor

5745MHz-5825MHz(U-NII-3)

Temperature:	25 °C	Relative Humidity:	55%
Test Voltage:	AC 120V/60Hz		
Ant. Pol.	Horizontal		
Test Mode:	TX 802.11a Mode 5745MHz (U-NII-3)		
Remark:	No report for the emission which more than 20 dB below the prescribed limit.		

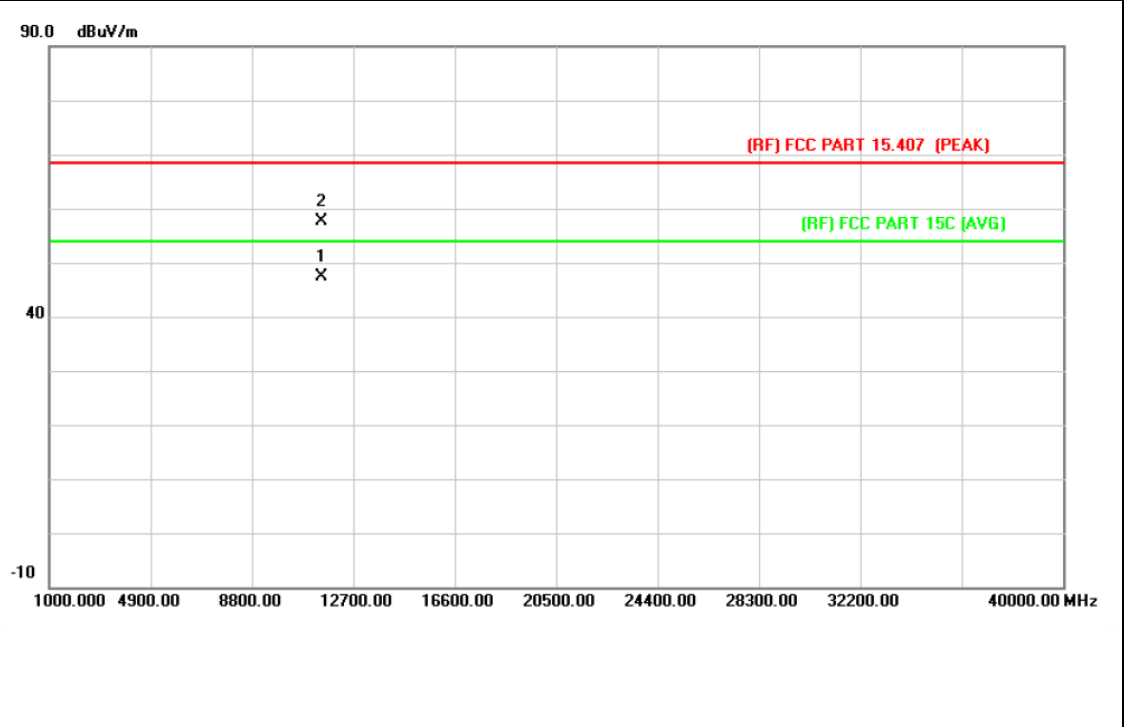

No.	Mk.	Freq. MHz	Reading Level dBuV	Correct Factor dB/m	Measure- ment dBuV/m	Limit dBuV/m	Over dB	Detector
1	*	11490.003	25.65	21.81	47.46	54.00	-6.54	AVG
2		11490.038	35.93	21.81	57.74	68.30	-10.56	peak

Emission Level= Read Level+ Correct Factor

Temperature:	25 °C	Relative Humidity:	55%
Test Voltage:	AC 120V/60Hz		
Ant. Pol.	Vertical		
Test Mode:	TX 802.11a Mode 5745MHz (U-NII-3)		
Remark:	No report for the emission which more than 20 dB below the prescribed limit.		

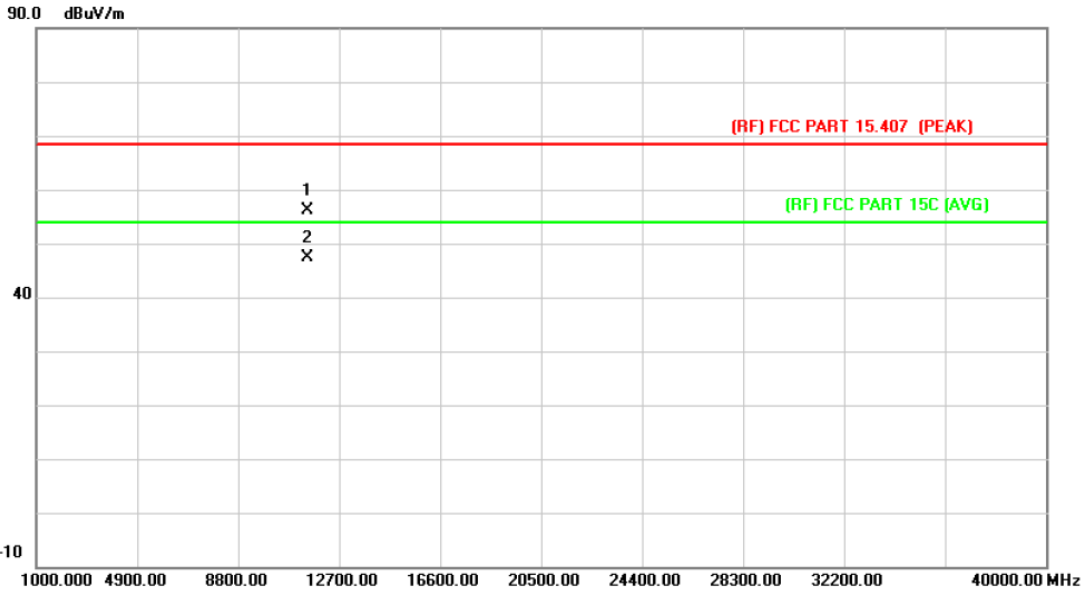

No.	Mk.	Freq. MHz	Reading Level dBuV	Correct Factor dB/m	Measure- ment dBuV/m	Limit dBuV/m	Over dB	Detector
1		11489.975	34.38	21.81	56.19	68.30	-12.11	peak
2	*	11489.975	25.51	21.81	47.32	54.00	-6.68	AVG

Emission Level= Read Level+ Correct Factor

Temperature:	25 °C	Relative Humidity:	55%
Test Voltage:	AC 120V/60Hz		
Ant. Pol.	Horizontal		
Test Mode:	TX 802.11a Mode 5785MHz (U-NII-3)		
Remark:	No report for the emission which more than 20 dB below the prescribed limit.		

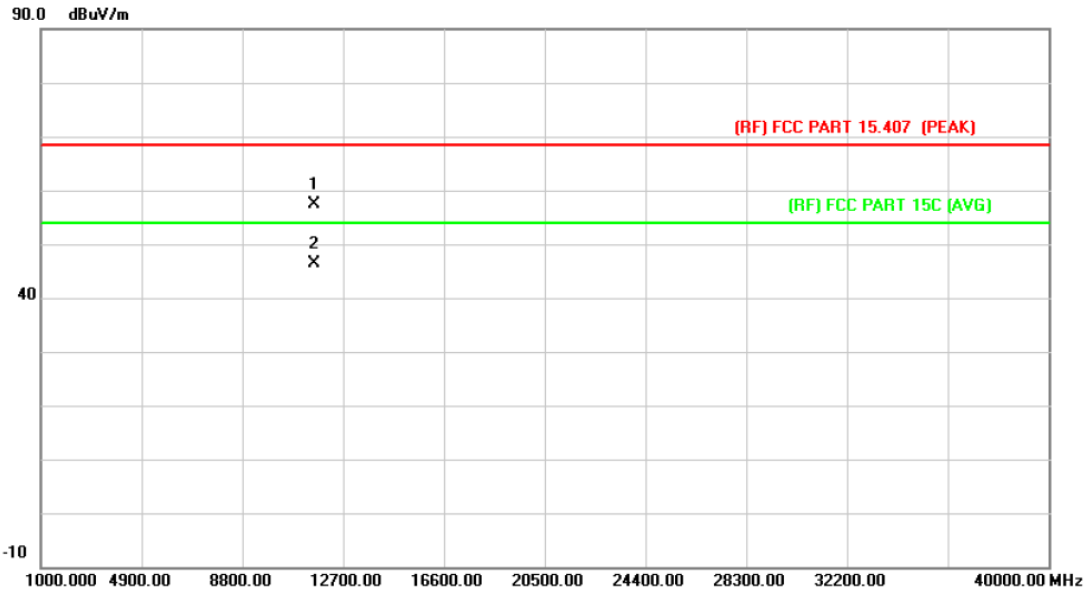

No.	Mk.	Freq. MHz	Reading Level dBuV	Correct Factor dB/m	Measure- ment dBuV/m	Limit dBuV/m	Over dB	Detector
1		11569.892	35.59	21.88	57.47	68.30	-10.83	peak
2	*	11569.987	24.48	21.88	46.36	54.00	-7.64	AVG

Emission Level= Read Level+ Correct Factor

Temperature:	25 °C	Relative Humidity:	55%
Test Voltage:	AC 120V/60Hz		
Ant. Pol.	Vertical		
Test Mode:	TX 802.11a Mode 5785MHz (U-NII-3)		
Remark:	No report for the emission which more than 20 dB below the prescribed limit.		

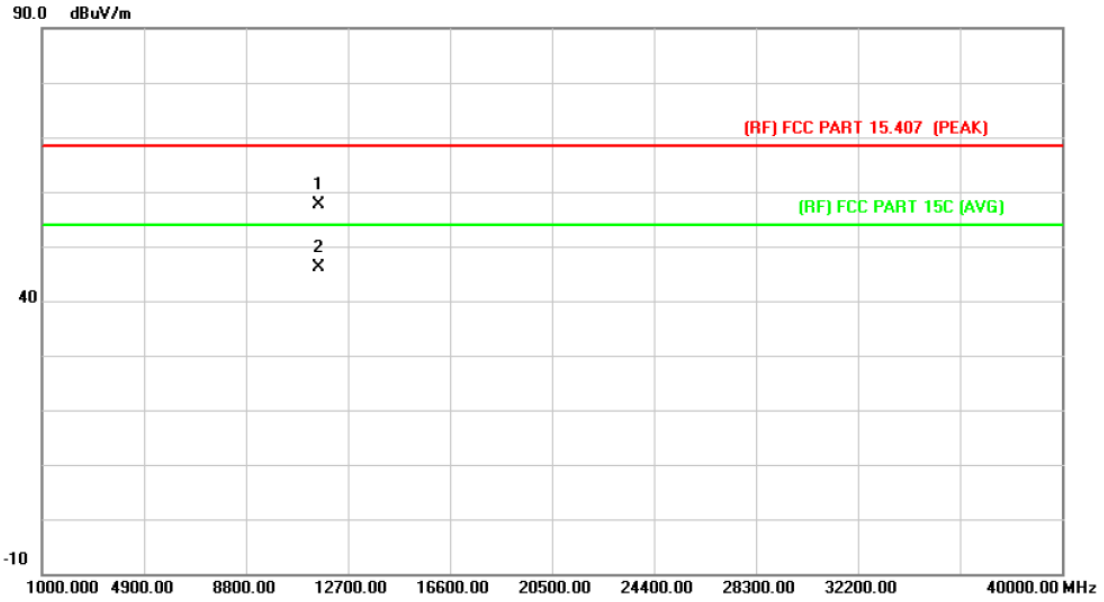

No.	Mk.	Freq. MHz	Reading Level dBuV	Correct Factor dB/m	Measure- ment dBuV/m	Limit dBuV/m	Over dB	Detector
1		11569.532	35.76	21.88	57.64	68.30	-10.66	peak
2	*	11570.272	24.25	21.88	46.13	54.00	-7.87	AVG

Emission Level= Read Level+ Correct Factor

Temperature:	25 °C	Relative Humidity:	55%
Test Voltage:	AC 120V/60Hz		
Ant. Pol.	Horizontal		
Test Mode:	TX 802.11a Mode 5825MHz (U-NII-3)		
Remark:	No report for the emission which more than 20 dB below the prescribed limit.		

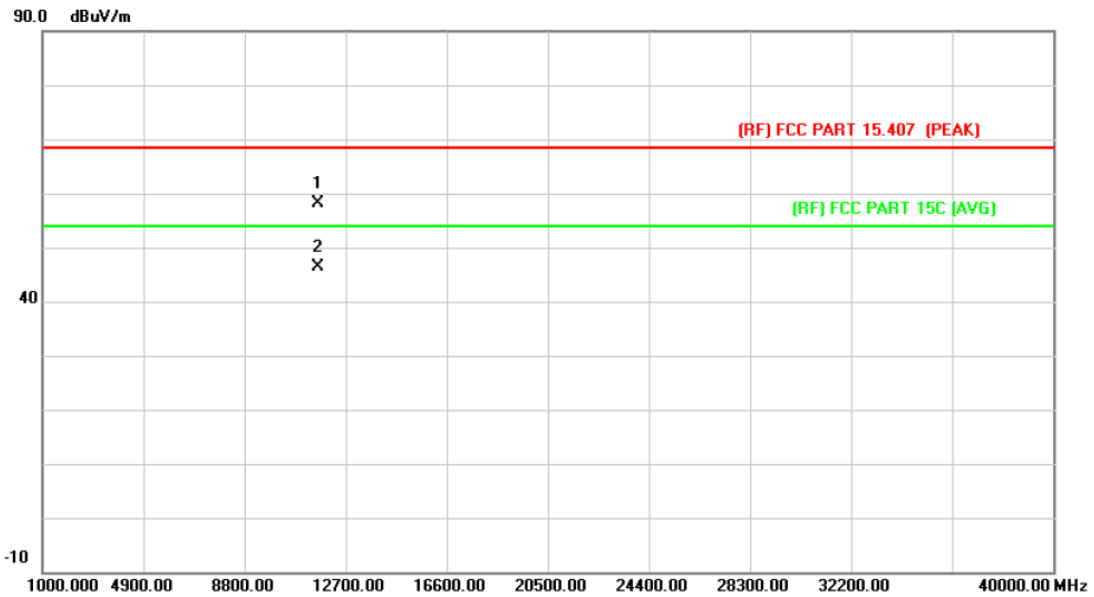

No.	Mk.	Freq. MHz	Reading Level dBuV	Correct Factor dB/m	Measure- ment dBuV/m	Limit dBuV/m	Over dB	Detector
1		11649.917	36.21	21.96	58.17	68.30	-10.13	peak
2	*	11650.275	24.31	21.96	46.27	54.00	-7.73	AVG

Emission Level= Read Level+ Correct Factor

Temperature:	25 °C	Relative Humidity:	55%
Test Voltage:	AC 120V/60Hz		
Ant. Pol.	Vertical		
Test Mode:	TX 802.11a Mode 5825MHz (U-NII-3)		
Remark:	No report for the emission which more than 20 dB below the prescribed limit.		

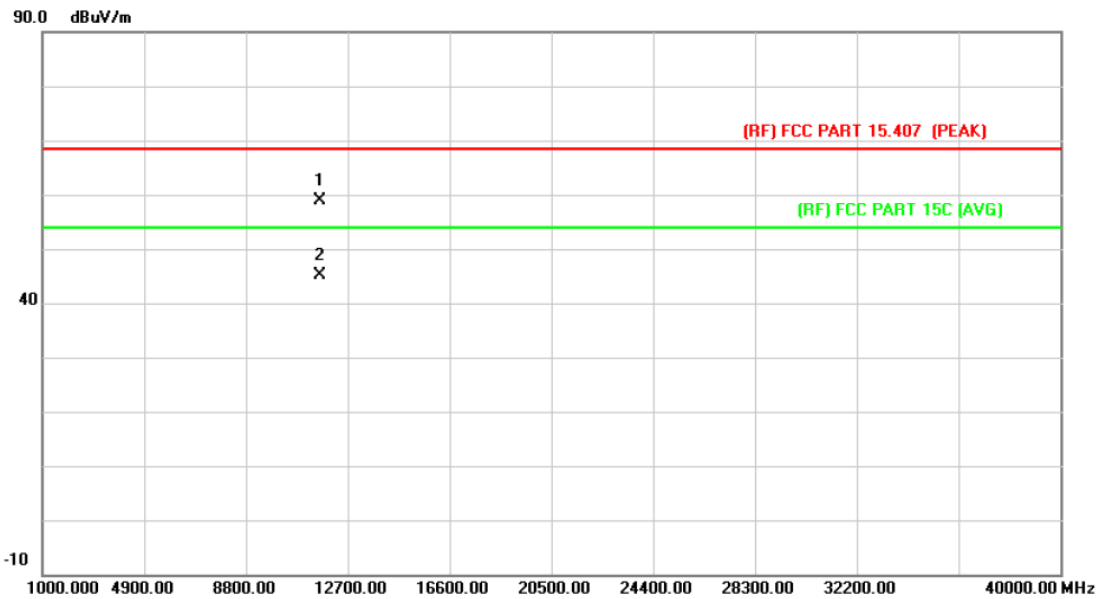

No.	Mk.	Freq. MHz	Reading Level dBuV	Correct Factor dB/m	Measure- ment dBuV/m	Limit dBuV/m	Over dB	Detector
1		11649.555	36.96	21.96	58.92	68.30	-9.38	peak
2	*	11649.795	23.23	21.96	45.19	54.00	-8.81	AVG

Emission Level= Read Level+ Correct Factor

Temperature:	25 °C	Relative Humidity:	55%
Test Voltage:	AC 120V/60Hz		
Ant. Pol.	Horizontal		
Test Mode:	TX 802.11n(HT20) Mode 5745MHz (U-NII-3)		
Remark:	No report for the emission which more than 20 dB below the prescribed limit.		

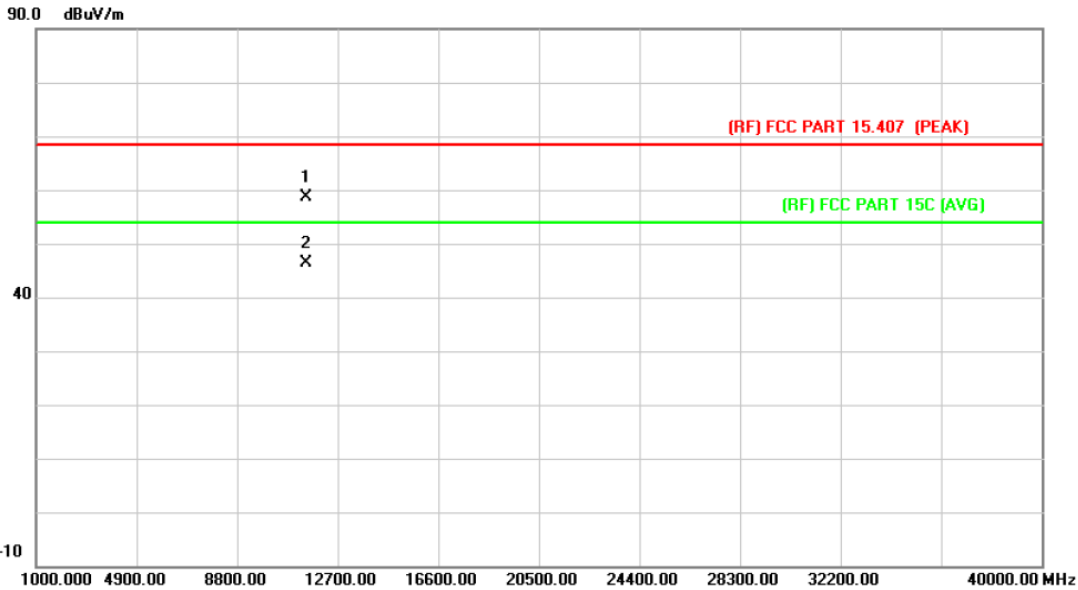

No.	Mk.	Freq. MHz	Reading Level dBuV	Correct Factor dB/m	Measure- ment dBuV/m	Limit dBuV/m	Over dB	Detector
1		11489.663	36.84	21.81	58.65	68.30	-9.65	peak
2	*	11489.743	24.48	21.81	46.29	54.00	-7.71	AVG

Emission Level= Read Level+ Correct Factor

Temperature:	25 °C	Relative Humidity:	55%
Test Voltage:	AC 120V/60Hz		
Ant. Pol.	Vertical		
Test Mode:	TX 802.11n(HT20) Mode 5745MHz (U-NII-3)		
Remark:	No report for the emission which more than 20 dB below the prescribed limit.		

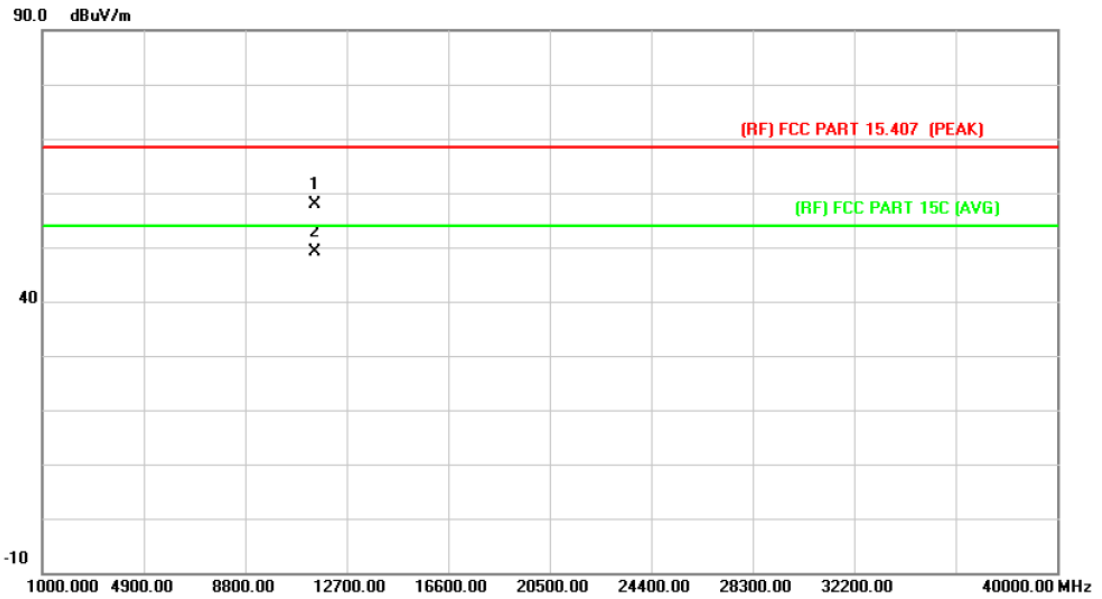

No.	Mk.	Freq. MHz	Reading Level dBuV	Correct Factor dB/m	Measure- ment dBuV/m	Limit dBuV/m	Over dB	Detector
1		11489.517	36.13	21.81	57.94	68.30	-10.36	peak
2	*	11490.073	27.40	21.81	49.21	54.00	-4.79	AVG

Emission Level= Read Level+ Correct Factor

Temperature:	25 °C	Relative Humidity:	55%
Test Voltage:	AC 120V/60Hz		
Ant. Pol.	Horizontal		
Test Mode:	TX 802.11n(HT20) Mode 5785MHz (U-NII-3)		
Remark:	No report for the emission which more than 20 dB below the prescribed limit.		

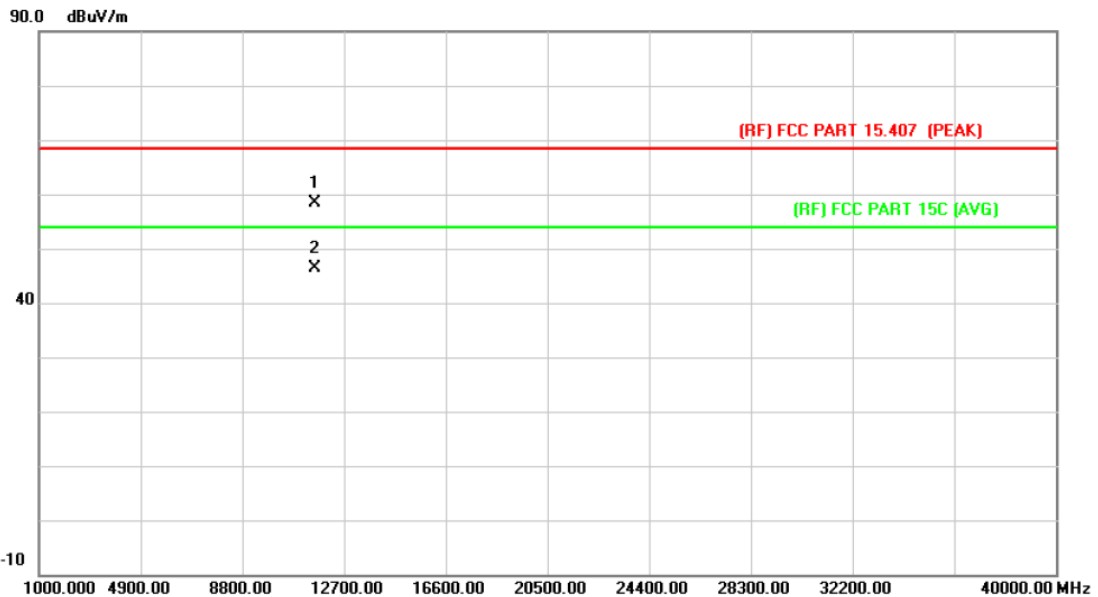

No.	Mk.	Freq. MHz	Reading Level dBuV	Correct Factor dB/m	Measure- ment dBuV/m	Limit dBuV/m	Over dB	Detector
1		11569.972	36.44	21.88	58.32	68.30	-9.98	peak
2	*	11570.445	24.43	21.88	46.31	54.00	-7.69	AVG

Emission Level= Read Level+ Correct Factor

Temperature:	25 °C	Relative Humidity:	55%
Test Voltage:	AC 120V/60Hz		
Ant. Pol.	Vertical		
Test Mode:	TX 802.11n(HT20) Mode 5785MHz (U-NII-3)		
Remark:	No report for the emission which more than 20 dB below the prescribed limit.		

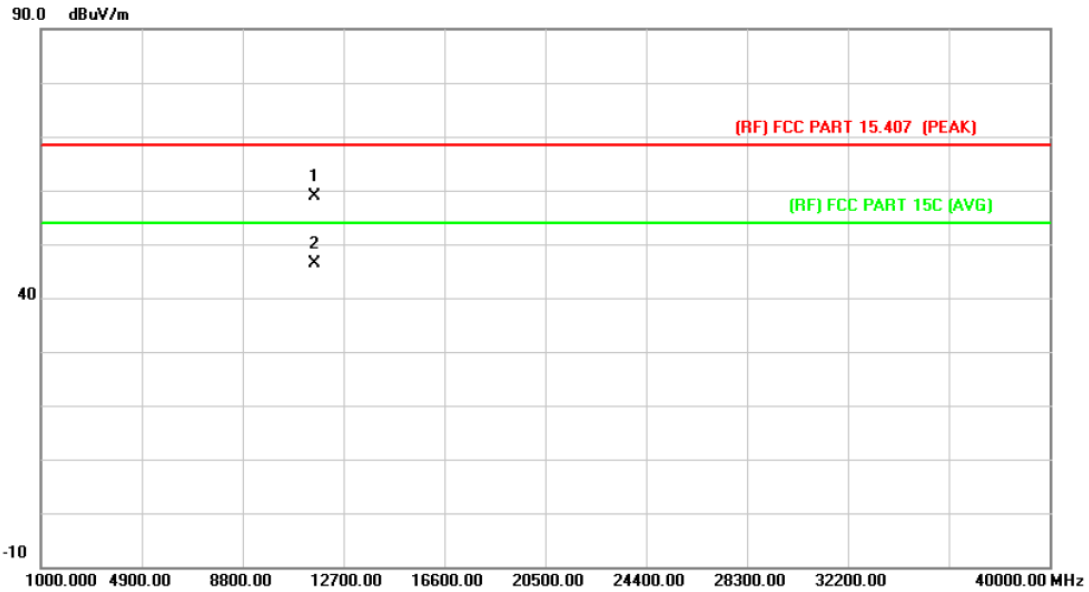

No.	Mk.	Freq. MHz	Reading Level dBuV	Correct Factor dB/m	Measure- ment dBuV/m	Limit dBuV/m	Over dB	Detector
1		11569.630	36.94	21.88	58.82	68.30	-9.48	peak
2	*	11570.105	24.41	21.88	46.29	54.00	-7.71	AVG

Emission Level= Read Level+ Correct Factor

Temperature:	25 °C	Relative Humidity:	55%
Test Voltage:	AC 120V/60Hz		
Ant. Pol.	Horizontal		
Test Mode:	TX 802.11n(HT20) Mode 5825MHz (U-NII-3)		
Remark:	No report for the emission which more than 20 dB below the prescribed limit.		

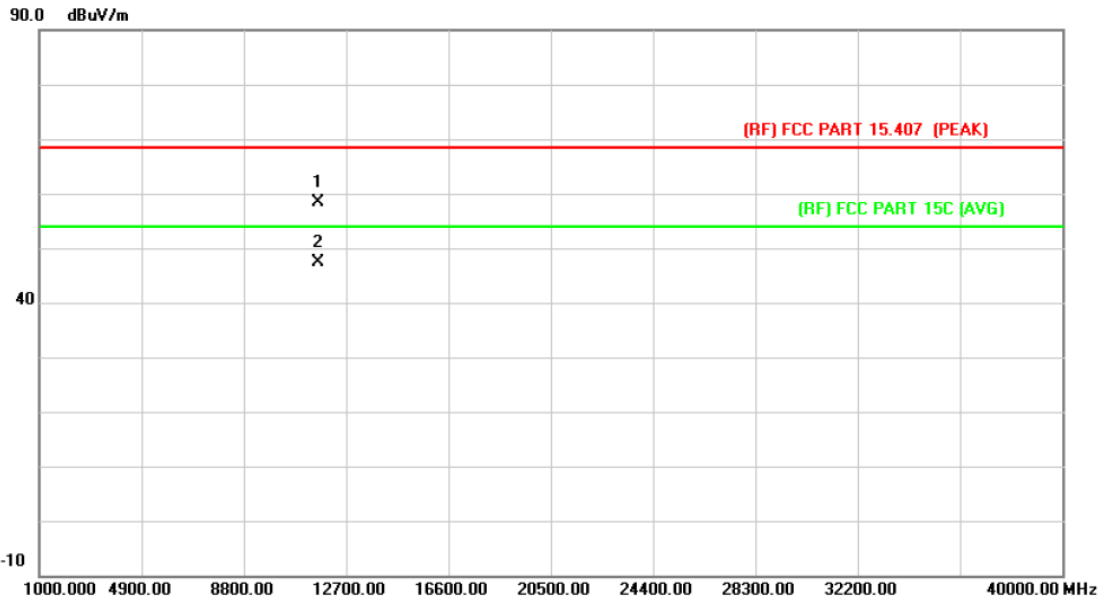

No.	Mk.	Freq. MHz	Reading Level dBuV	Correct Factor dB/m	Measure- ment dBuV/m	Limit dBuV/m	Over dB	Detector
1		11650.103	36.49	21.96	58.45	68.30	-9.85	peak
2	*	11650.145	25.32	21.96	47.28	54.00	-6.72	AVG

Emission Level= Read Level+ Correct Factor

Temperature:	25 °C	Relative Humidity:	55%
Test Voltage:	AC 120V/60Hz		
Ant. Pol.	Vertical		
Test Mode:	TX 802.11n(HT20) Mode 5825MHz (U-NII-3)		
Remark:	No report for the emission which more than 20 dB below the prescribed limit.		

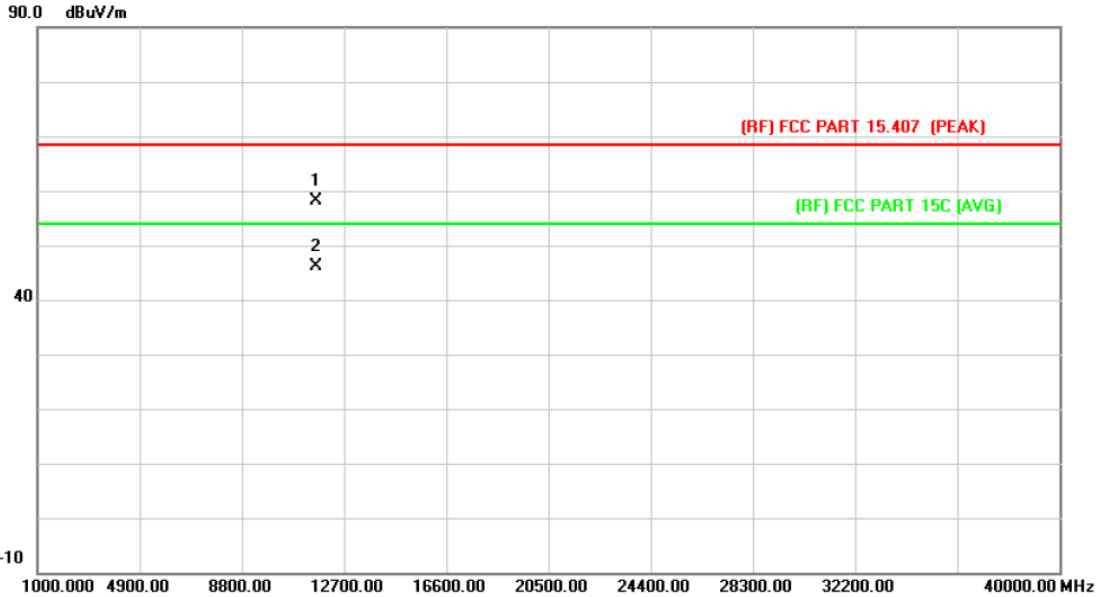

No.	Mk.	Freq. MHz	Reading Level dBuV	Correct Factor dB/m	Measure- ment dBuV/m	Limit dBuV/m	Over dB	Detector
1		11649.965	36.10	21.96	58.06	68.30	-10.24	peak
2	*	11650.423	24.17	21.96	46.13	54.00	-7.87	AVG

Emission Level= Read Level+ Correct Factor

Temperature:	25 °C	Relative Humidity:	55%
Test Voltage:	AC 120V/60Hz		
Ant. Pol.	Horizontal		
Test Mode:	TX 802.11n(HT40) Mode 5755MHz (U-NII-3)		
Remark:	No report for the emission which more than 20 dB below the prescribed limit.		

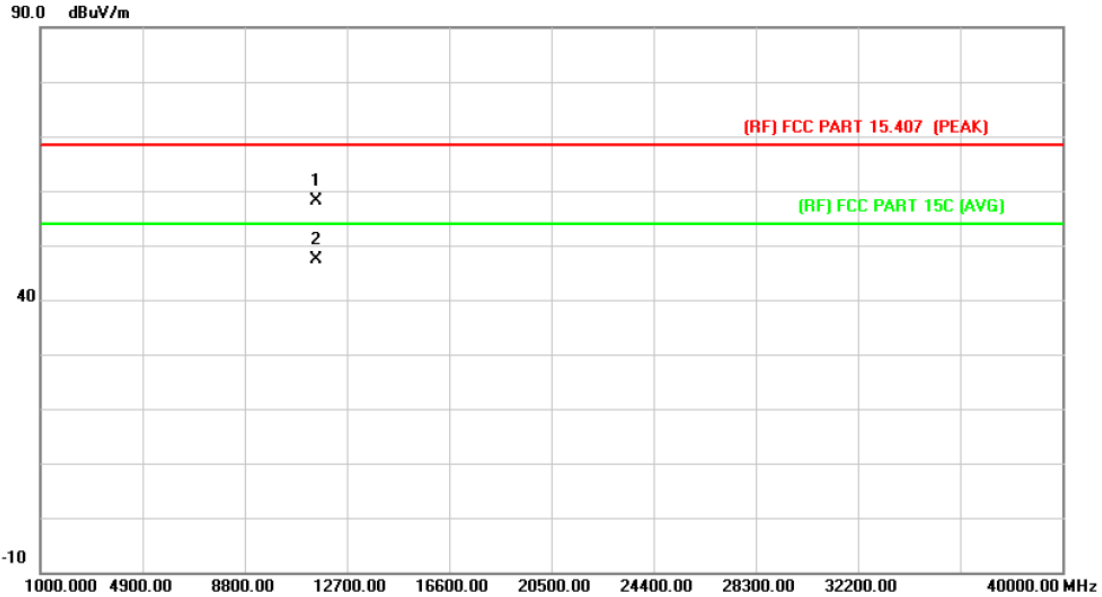

No.	Mk.	Freq. MHz	Reading Level dBuV	Correct Factor dB/m	Measure- ment dBuV/m	Limit dBuV/m	Over dB	Detector
1		11509.692	36.22	21.82	58.04	68.30	-10.26	peak
2	*	11510.280	25.57	21.82	47.39	54.00	-6.61	AVG

Emission Level= Read Level+ Correct Factor

Temperature:	25 °C	Relative Humidity:	55%
Test Voltage:	AC 120V/60Hz		
Ant. Pol.	Vertical		
Test Mode:	TX 802.11n(HT40) Mode 5755MHz (U-NII-3)		
Remark:	No report for the emission which more than 20 dB below the prescribed limit.		

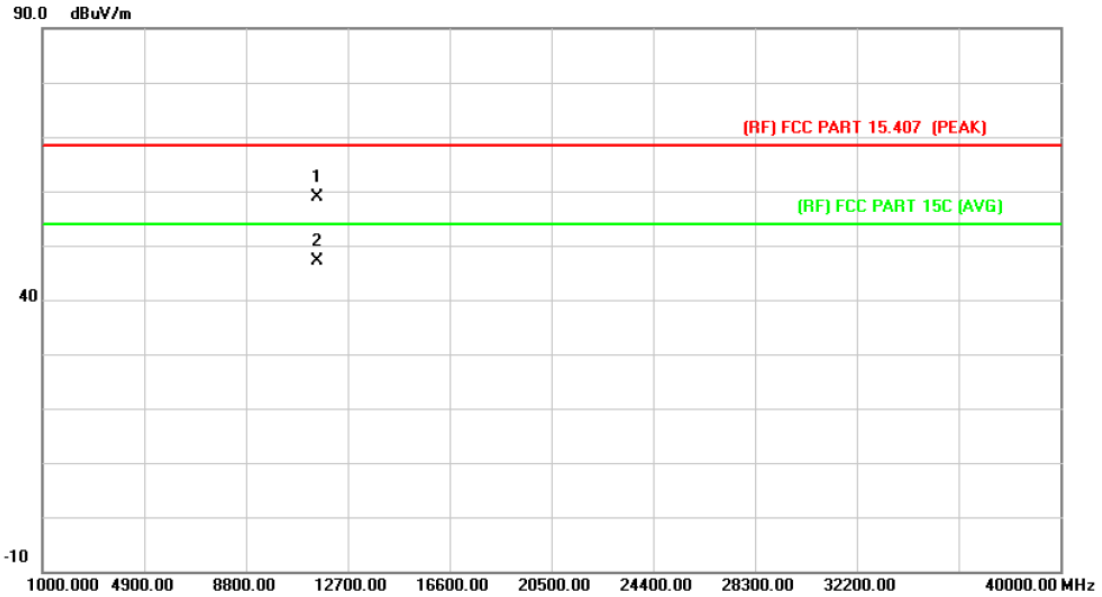

No.	Mk.	Freq. MHz	Reading Level dBuV	Correct Factor dB/m	Measure- ment dBuV/m	Limit dBuV/m	Over dB	Detector
1		11509.583	37.07	21.82	58.89	68.30	-9.41	peak
2	*	11509.970	25.31	21.82	47.13	54.00	-6.87	AVG

Emission Level= Read Level+ Correct Factor

Temperature:	25 °C	Relative Humidity:	55%
Test Voltage:	AC 120V/60Hz		
Ant. Pol.	Horizontal		
Test Mode:	TX 802.11n(HT40) Mode 5795MHz (U-NII-3)		
Remark:	No report for the emission which more than 20 dB below the prescribed limit.		

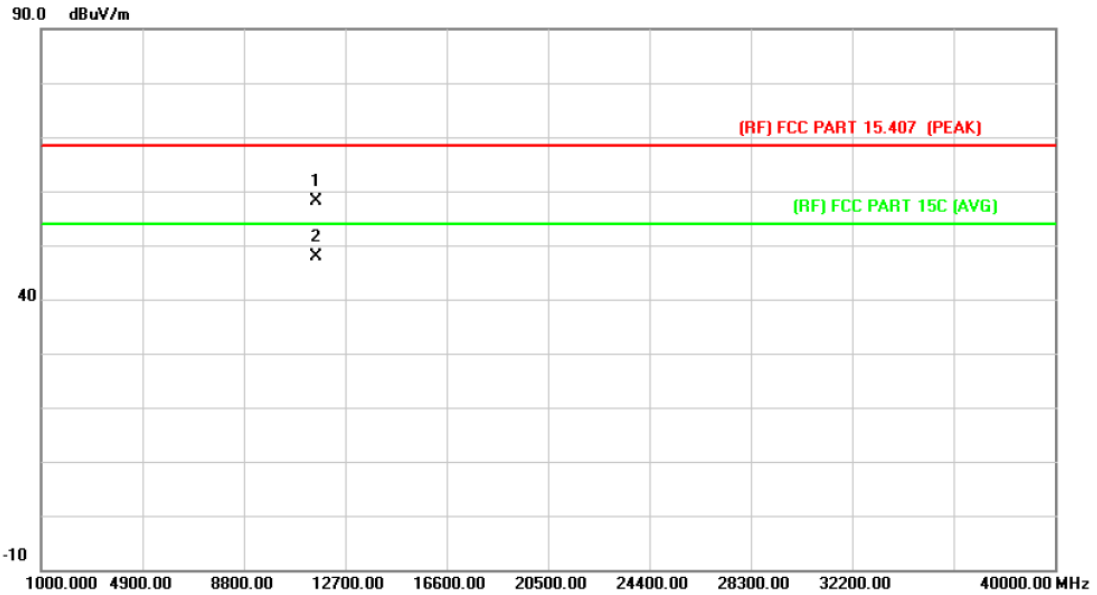

No.	Mk.	Freq. MHz	Reading Level dBuV	Correct Factor dB/m	Measure- ment dBuV/m	Limit dBuV/m	Over dB	Detector
1		11590.000	36.14	21.90	58.04	68.30	-10.26	peak
2	*	11590.415	26.05	21.90	47.95	54.00	-6.05	AVG

Emission Level= Read Level+ Correct Factor

Temperature:	25 °C	Relative Humidity:	55%
Test Voltage:	AC 120V/60Hz		
Ant. Pol.	Vertical		
Test Mode:	TX 802.11n(HT40) Mode 5795MHz (U-NII-3)		
Remark:	No report for the emission which more than 20 dB below the prescribed limit.		

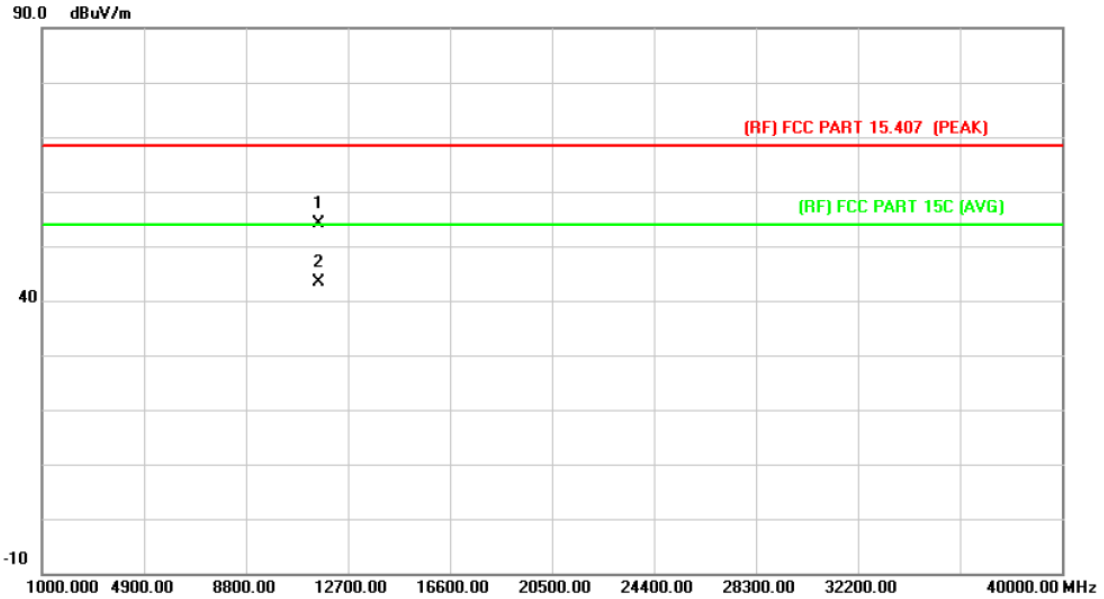

No.	Mk.	Freq. MHz	Reading Level dBuV	Correct Factor dB/m	Measure- ment dBuV/m	Limit dBuV/m	Over dB	Detector
1		11589.690	32.26	21.90	54.16	68.30	-14.14	peak
2	*	11589.780	21.39	21.90	43.29	54.00	-10.71	AVG

Emission Level= Read Level+ Correct Factor

Attachment C-- Restricted Bands Requirement and Band-edge Test Data

(1) Radiation Test

Temperature:	25 °C	Relative Humidity:	55%
Test Voltage:	AC 120V/60Hz		
Ant. Pol.	Horizontal		
Test Mode:	TX 802.11a Mode 5180 MHz (U-NII-1)		
Remark:			

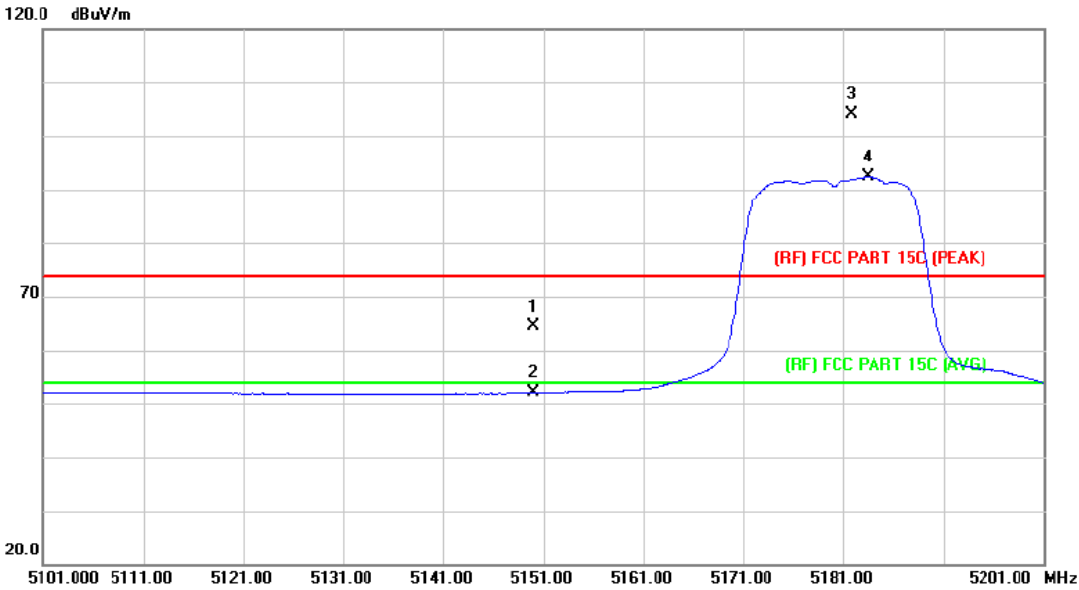

No.	Mk.	Freq. MHz	Reading Level dBuV	Correct Factor dB/m	Measure- ment dBuV/m	Limit dBuV/m	Over dB	Detector
1		5150.000	47.20	17.21	64.41	74.00	-9.59	peak
2		5150.000	34.90	17.21	52.11	54.00	-1.89	AVG
3	X	5181.800	87.02	17.14	104.16	Fundamental Frequency		peak
4	*	5183.500	75.23	17.14	92.37	Fundamental Frequency		AVG

Emission Level= Read Level+ Correct Factor

Temperature:	25 °C	Relative Humidity:	55%
Test Voltage:	AC 120V/60Hz		
Ant. Pol.	Vertical		
Test Mode:	TX 802.11a Mode 5180 MHz (U-NII-1)		
Remark:			

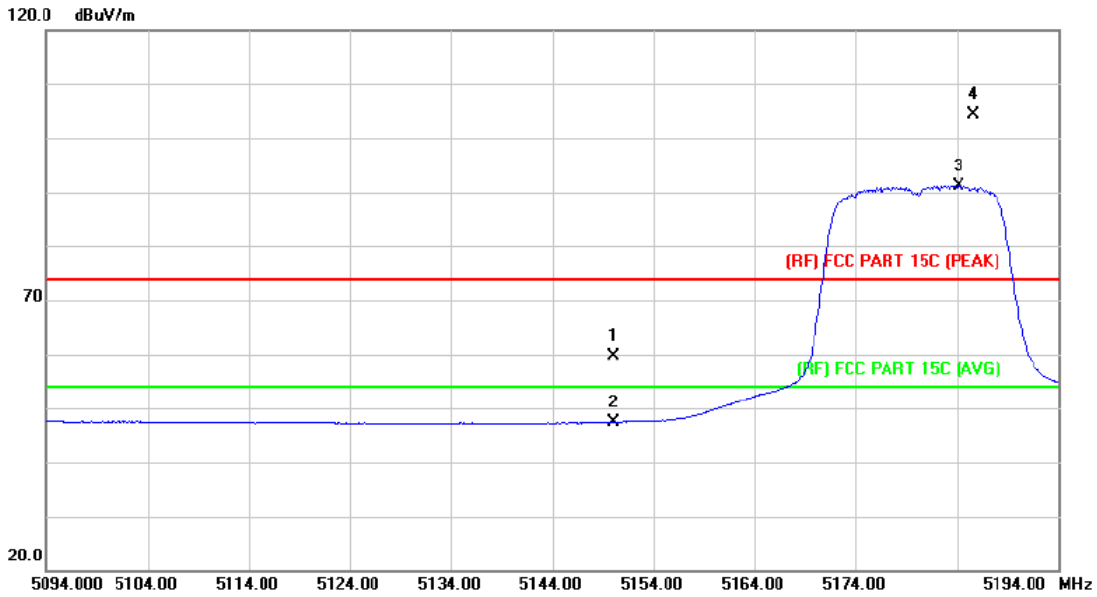

No.	Mk.	Freq. MHz	Reading Level dBuV	Correct Factor dB/m	Measure- ment dBuV/m	Limit dBuV/m	Over dB	Detector
1		5150.000	42.33	17.21	59.54	74.00	-14.46	peak
2		5150.000	30.20	17.21	47.41	54.00	-6.59	AVG
3	*	5184.200	74.11	17.14	91.25	Fundamental Frequency		AVG
4	X	5185.600	87.21	17.13	104.34	Fundamental Frequency		peak

Emission Level= Read Level+ Correct Factor

Temperature:	25 °C	Relative Humidity:	55%
Test Voltage:	AC 120V/60Hz		
Ant. Pol.	Horizontal		
Test Mode:	TX 802.11a Mode 5240 MHz (U-NII-1)		
Remark:			

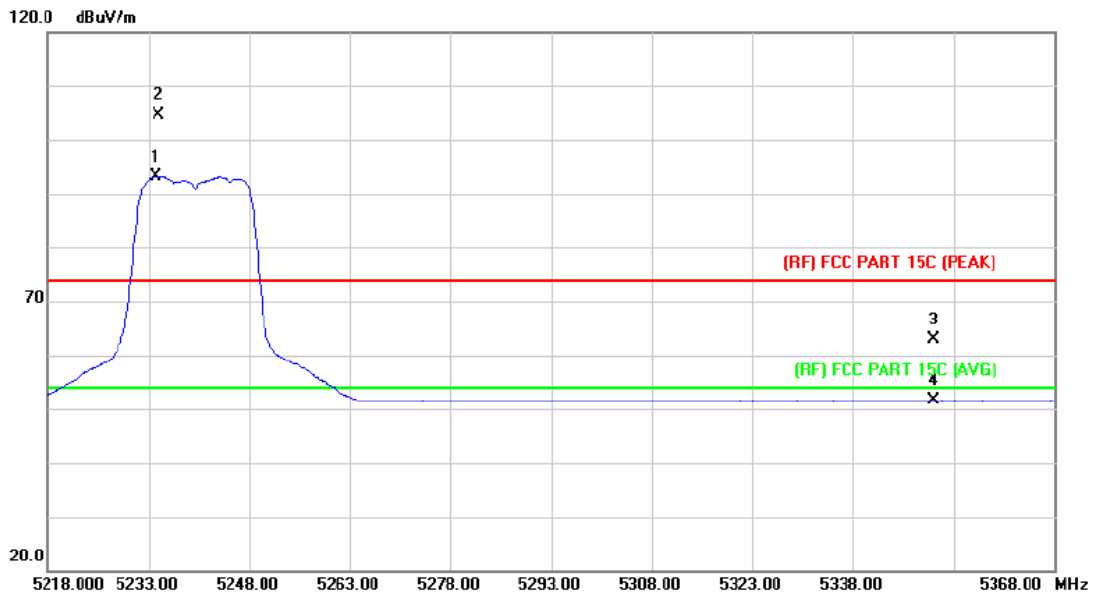

No.	Mk.	Freq. MHz	Reading Level dBuV	Correct Factor dB/m	Measure- ment dBuV/m	Limit dBuV/m	Over dB	Detector
1	*	5234.050	76.16	17.02	93.18	Fundamental Frequency		AVG
2	X	5234.500	87.64	17.02	104.66	Fundamental Frequency		peak
3		5350.000	46.04	16.77	62.81	74.00	-11.19	peak
4		5350.000	34.74	16.77	51.51	54.00	-2.49	AVG

Emission Level= Read Level+ Correct Factor

Temperature:	25 °C	Relative Humidity:	55%
Test Voltage:	AC 120V/60Hz		
Ant. Pol.	Vertical		
Test Mode:	TX 802.11a Mode 5240 MHz (U-NII-1)		
Remark:			

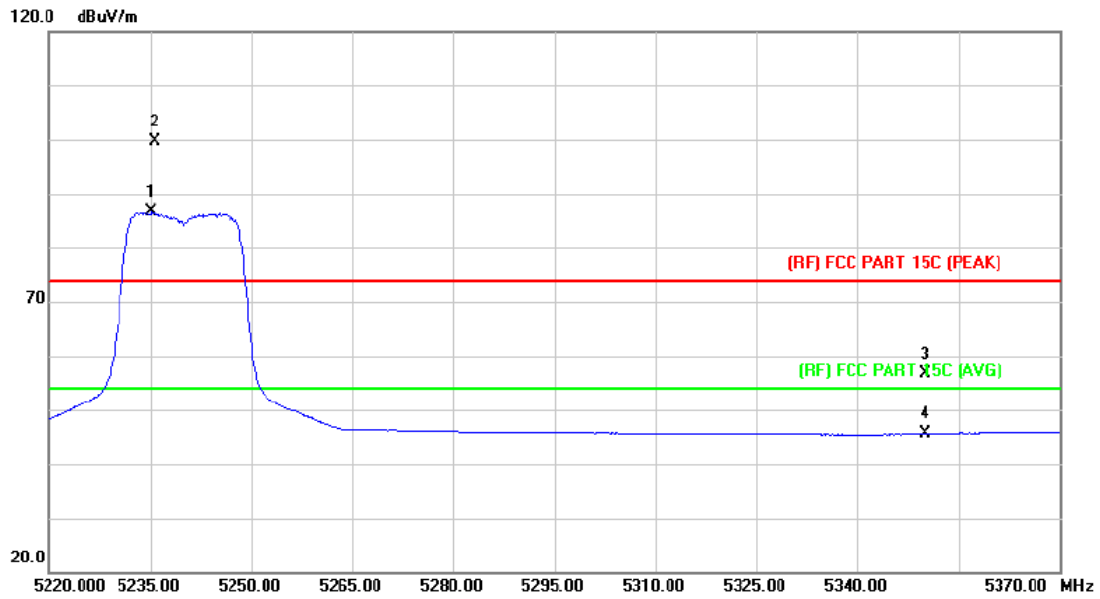

No.	Mk.	Freq. MHz	Reading Level dBuV	Correct Factor dB/m	Measure- ment dBuV/m	Limit dBuV/m	Over dB	Detector
1	*	5235.150	69.52	17.02	86.54	Fundamental Frequency		AVG
2	X	5235.600	82.58	17.02	99.60	Fundamental Frequency		peak
3		5350.000	39.86	16.77	56.63	74.00	-17.37	peak
4		5350.000	28.86	16.77	45.63	54.00	-8.37	AVG

Emission Level= Read Level+ Correct Factor

Temperature:	25 °C	Relative Humidity:	55%
Test Voltage:	AC 120V/60Hz		
Ant. Pol.	Horizontal		
Test Mode:	TX 802.11n(HT20) Mode 5180 MHz (U-NII-1)		
Remark:			

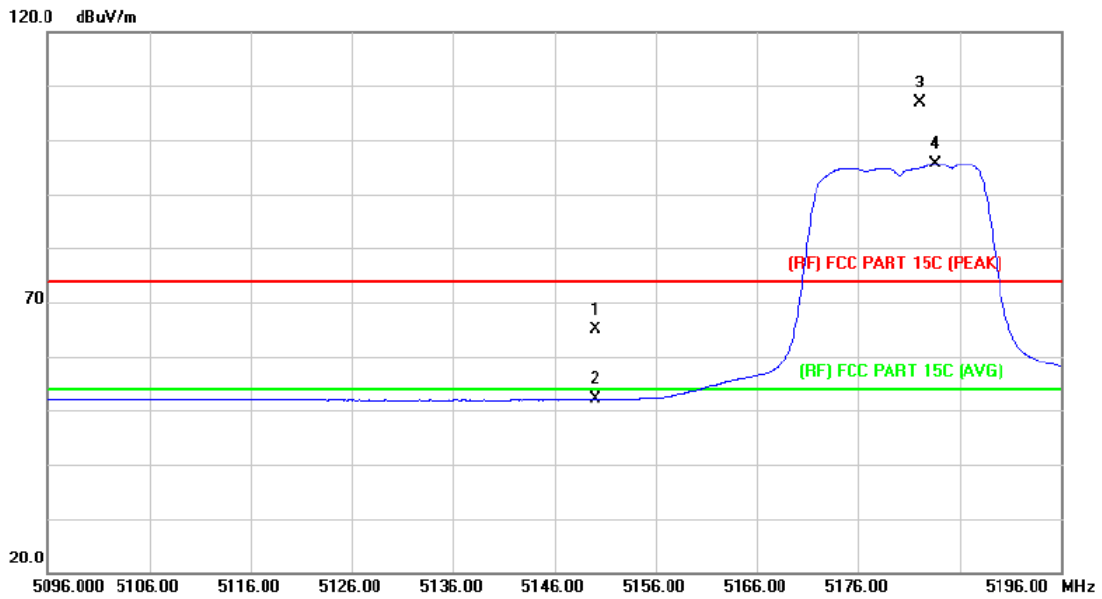

No.	Mk.	Freq. MHz	Reading Level dBuV	Correct Factor dB/m	Measure- ment dBuV/m	Limit dBuV/m	Over dB	Detector
1		5150.000	47.68	17.21	64.89	74.00	-9.11	peak
2		5150.000	34.94	17.21	52.15	54.00	-1.85	AVG
3	X	5182.000	89.76	17.14	106.90	Fundamental Frequency		peak
4	*	5183.600	78.37	17.14	95.51	Fundamental Frequency		AVG

Emission Level= Read Level+ Correct Factor

Temperature:	25 °C	Relative Humidity:	55%
Test Voltage:	AC 120V/60Hz		
Ant. Pol.	Vertical		
Test Mode:	TX 802.11n(HT20) Mode 5180 MHz (U-NII-1)		
Remark:			

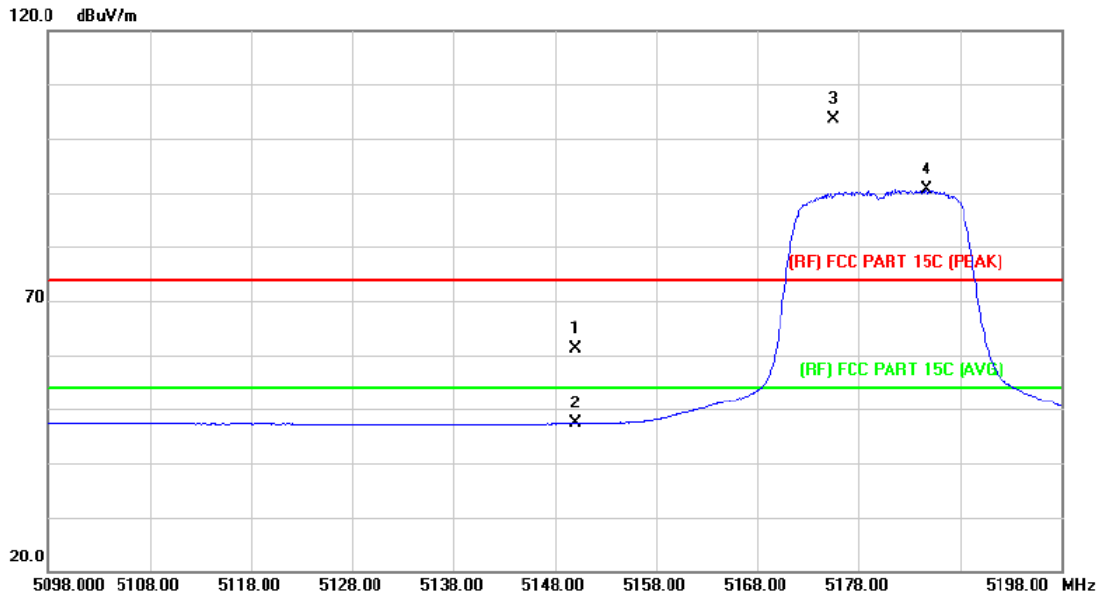

No.	Mk.	Freq. MHz	Reading Level dBuV	Correct Factor dB/m	Measure- ment dBuV/m	Limit dBuV/m	Over dB	Detector
1		5150.000	43.95	17.21	61.16	74.00	-12.84	peak
2		5150.000	30.11	17.21	47.32	54.00	-6.68	AVG
3	X	5175.500	86.40	17.15	103.55	Fundamental Frequency		peak
4	*	5184.700	73.45	17.13	90.58	Fundamental Frequency		AVG

Emission Level= Read Level+ Correct Factor

Temperature:	25 °C	Relative Humidity:	55%
Test Voltage:	AC 120V/60Hz		
Ant. Pol.	Horizontal		
Test Mode:	TX 802.11n(HT20) Mode 5240 MHz (U-NII-1)		
Remark:			

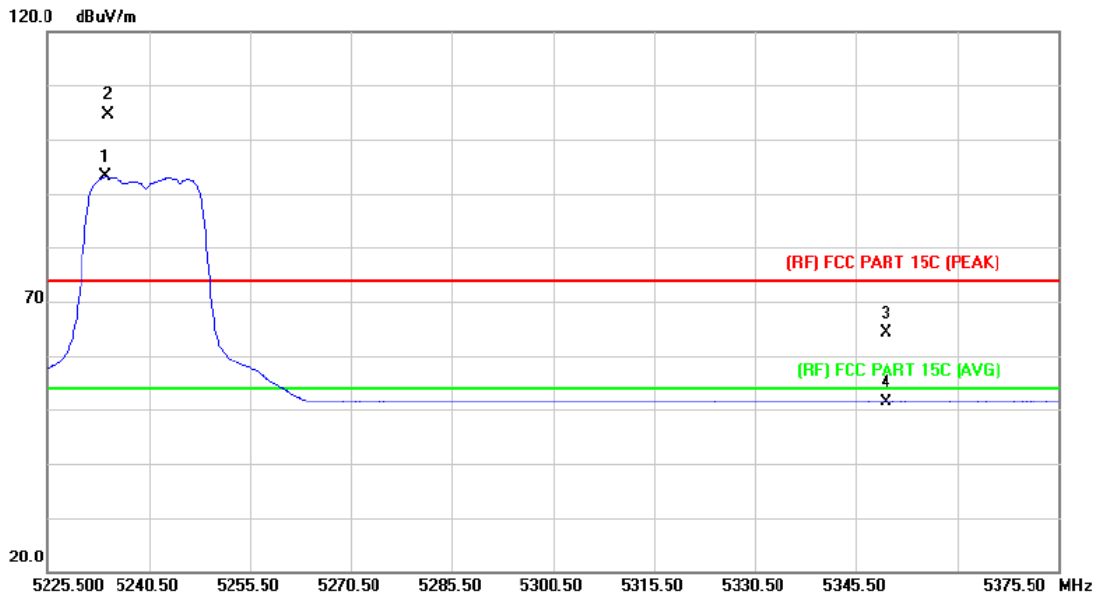

No.	Mk.	Freq. MHz	Reading Level dBuV	Correct Factor dB/m	Measure- ment dBuV/m	Limit dBuV/m	Over dB	Detector
1	*	5234.050	76.01	17.02	93.03	Fundamental Frequency		AVG
2	X	5234.350	87.58	17.02	104.60	Fundamental Frequency		peak
3		5350.000	47.48	16.77	64.25	74.00	-9.75	peak
4		5350.000	34.72	16.77	51.49	54.00	-2.51	AVG

Emission Level= Read Level+ Correct Factor

Temperature:	25 °C	Relative Humidity:	55%
Test Voltage:	AC 120V/60Hz		
Ant. Pol.	Vertical		
Test Mode:	TX 802.11n(HT20) Mode 5240 MHz (U-NII-1)		
Remark:			

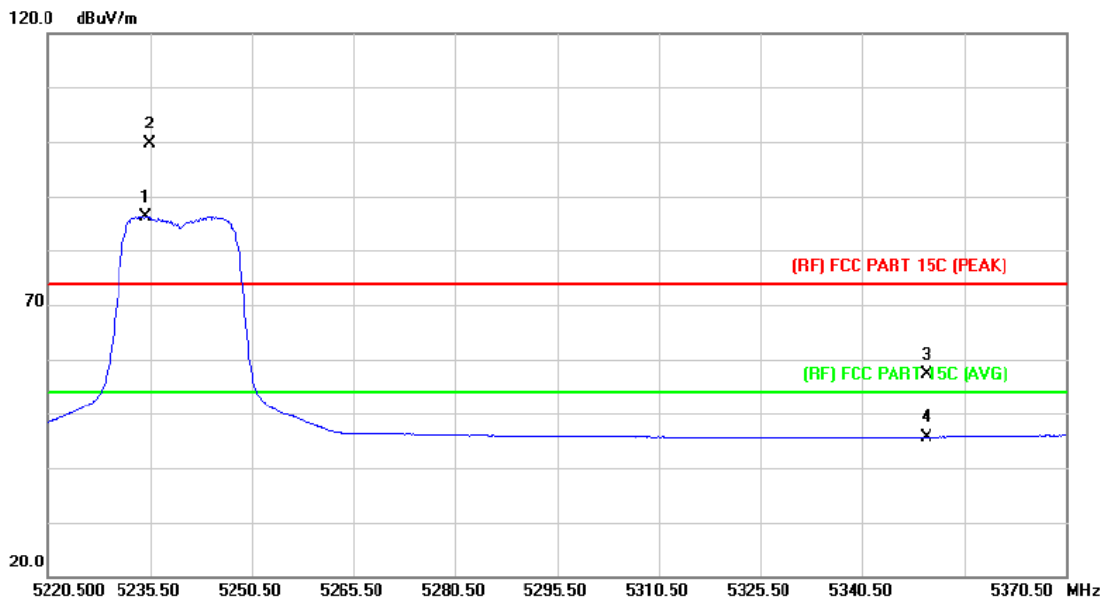

No.	Mk.	Freq. MHz	Reading Level dBuV	Correct Factor dB/m	Measure- ment dBuV/m	Limit dBuV/m	Over dB	Detector
1	*	5234.750	69.20	17.02	86.22	Fundamental Frequency		AVG
2	X	5235.350	82.65	17.02	99.67	Fundamental Frequency		peak
3		5350.000	40.39	16.77	57.16	74.00	-16.84	peak
4		5350.000	28.94	16.77	45.71	54.00	-8.29	AVG

Emission Level= Read Level+ Correct Factor

Temperature:	25 °C	Relative Humidity:	55%
Test Voltage:	AC 120V/60Hz		
Ant. Pol.	Horizontal		
Test Mode:	TX 802.11n(HT40) Mode 5190 MHz (U-NII-1)		
Remark:			

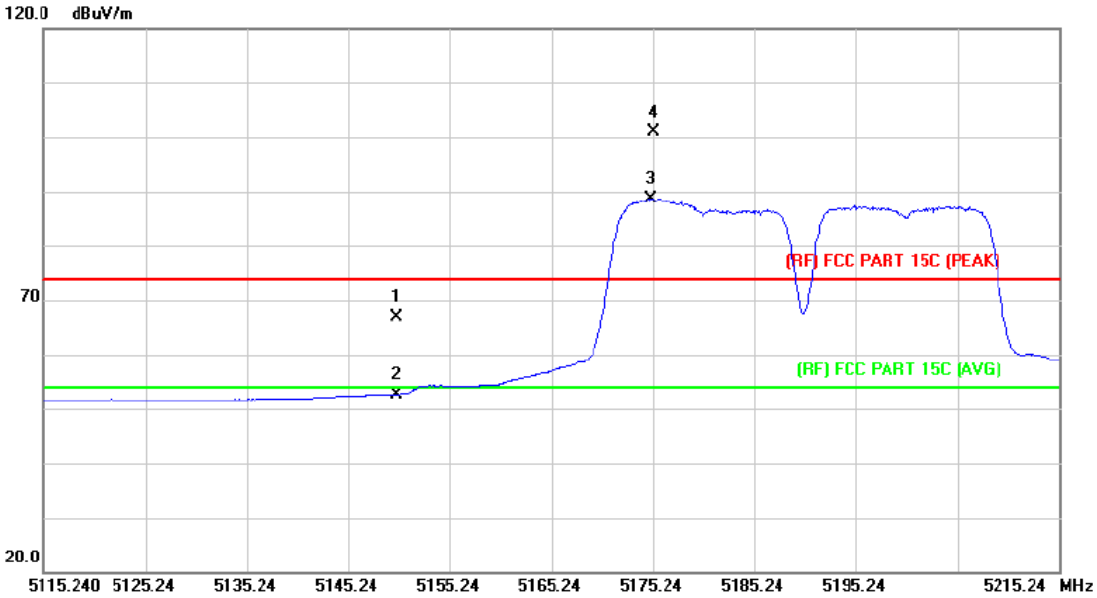

No.	Mk.	Freq. MHz	Reading Level dBuV	Correct Factor dB/m	Measure- ment dBuV/m	Limit dBuV/m	Over dB	Detector
1		5150.000	49.59	17.21	66.80	74.00	-7.20	peak
2		5150.000	35.53	17.21	52.74	74.00	-21.26	AVG
3	X	5175.040	71.58	17.15	88.73	Fundamental Frequency		AVG
4	*	5175.240	83.77	17.15	100.92	Fundamental Frequency		peak

Emission Level= Read Level+ Correct Factor

Temperature:	25 °C	Relative Humidity:	55%
Test Voltage:	AC 120V/60Hz		
Ant. Pol.	Vertical		
Test Mode:	TX 802.11n(HT40) Mode 5190 MHz (U-NII-1)		
Remark:			

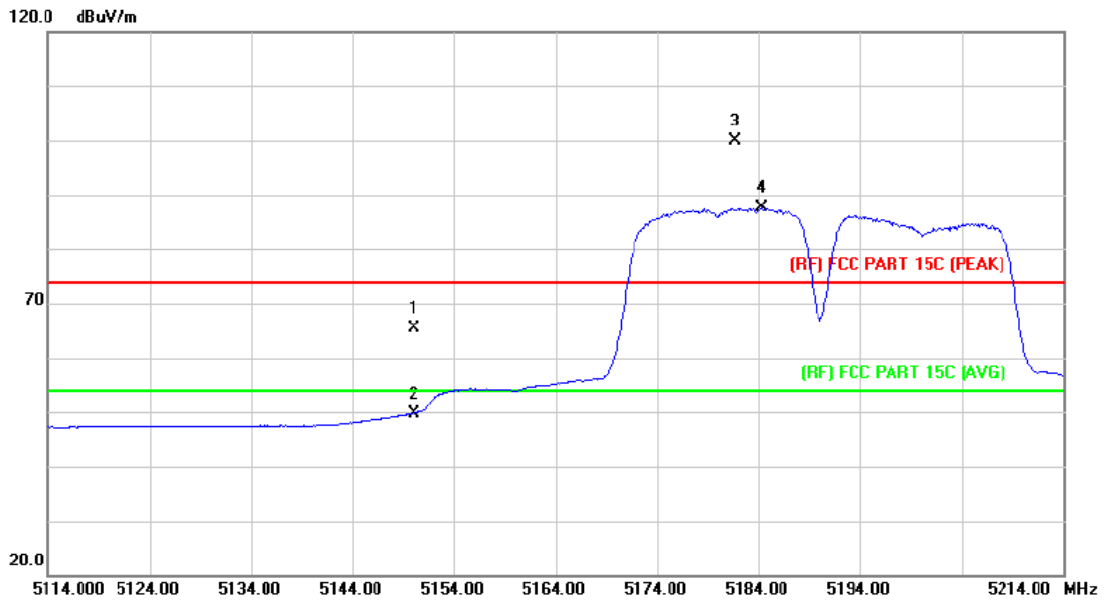

No.	Mk.	Freq. MHz	Reading Level dBuV	Correct Factor dB/m	Measure- ment dBuV/m	Limit dBuV/m	Over dB	Detector
1		5150.000	48.10	17.21	65.31	74.00	-8.69	peak
2		5150.000	32.54	17.21	49.75	54.00	-4.25	AVG
3	X	5181.700	82.75	17.14	99.89	Fundamental Frequency		peak
4	*	5184.300	70.40	17.14	87.54	Fundamental Frequency		AVG

Emission Level= Read Level+ Correct Factor

Temperature:	25 °C	Relative Humidity:	55%
Test Voltage:	AC 120V/60Hz		
Ant. Pol.	Horizontal		
Test Mode:	TX 802.11n(HT40) Mode 5230 MHz (U-NII-1)		
Remark:			

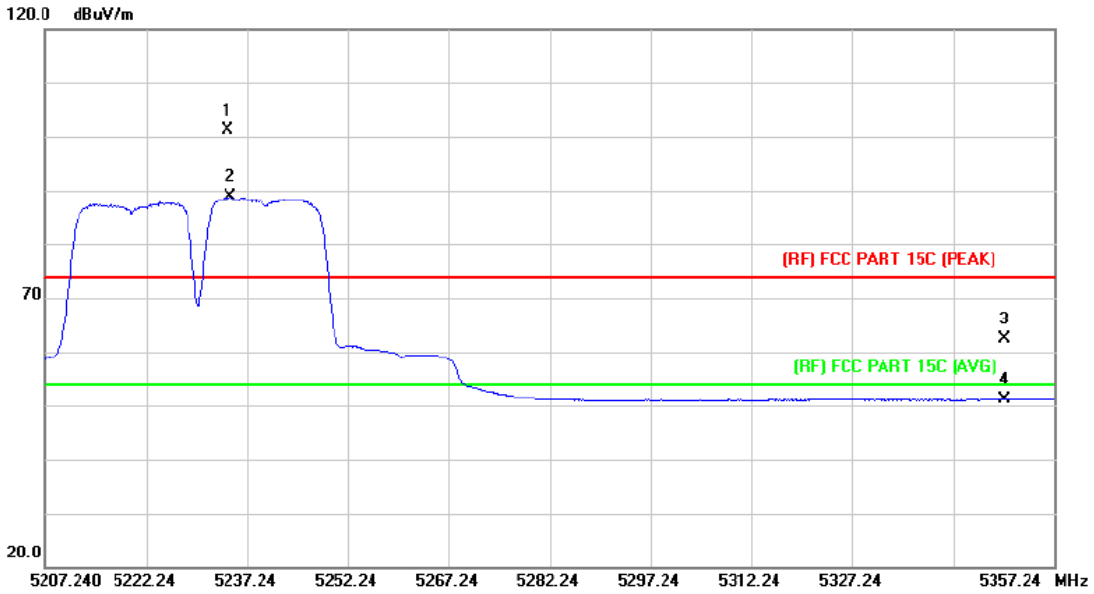

No.	Mk.	Freq. MHz	Reading Level dBuV	Correct Factor dB/m	Measure- ment dBuV/m	Limit dBuV/m	Over dB	Detector
1	X	5234.240	84.21	17.02	101.23	Fundamental Frequency		peak
2	*	5234.690	71.85	17.02	88.87	Fundamental Frequency		AVG
3		5350.000	45.67	16.77	62.44	74.00	-11.56	peak
4		5350.000	34.25	16.77	51.02	54.00	-2.98	AVG

Emission Level= Read Level+ Correct Factor

Temperature:	25 °C	Relative Humidity:	55%
Test Voltage:	AC 120V/60Hz		
Ant. Pol.	Vertical		
Test Mode:	TX 802.11n(HT40) Mode 5230 MHz (U-NII-1)		
Remark:			

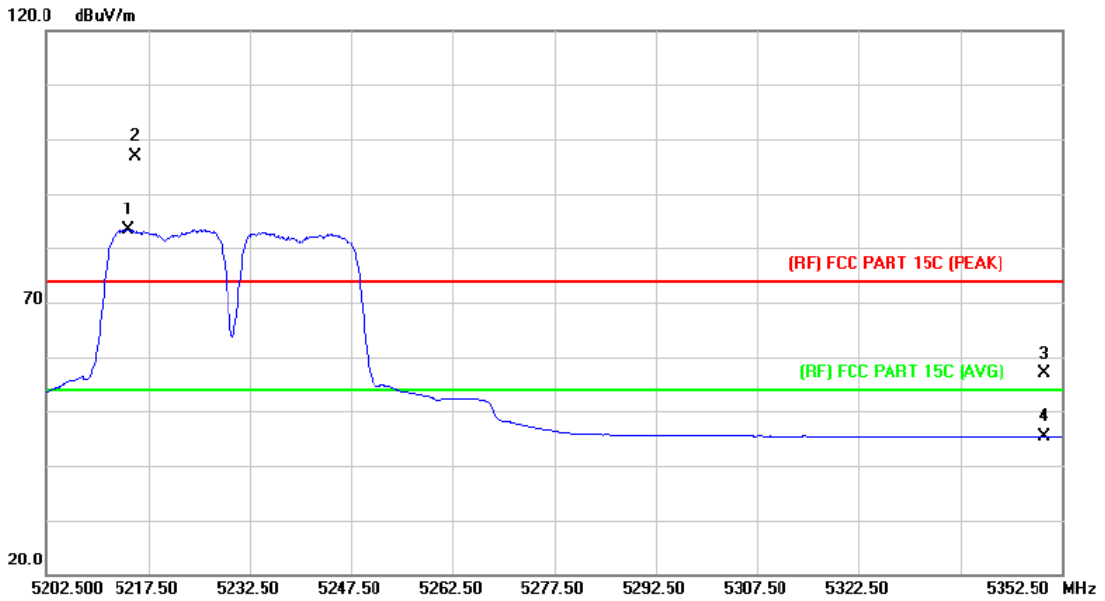

No.	Mk.	Freq. MHz	Reading Level dBuV	Correct Factor dB/m	Measure- ment dBuV/m	Limit dBuV/m	Over dB	Detector
1	*	5214.500	66.39	17.06	83.45			Fundamental Frequency AVG
2	X	5215.550	79.79	17.06	96.85			Fundamental Frequency peak
3		5350.000	40.20	16.77	56.97	74.00	-17.03	peak
4		5350.000	28.67	16.77	45.44	54.00	-8.56	AVG

Emission Level= Read Level+ Correct Factor

Temperature:	25 °C	Relative Humidity:	55%
Test Voltage:	AC 120V/60Hz		
Ant. Pol.	Horizontal		
Test Mode:	TX 802.11a Mode 5745 MHz (U-NII-3)		
Remark:			

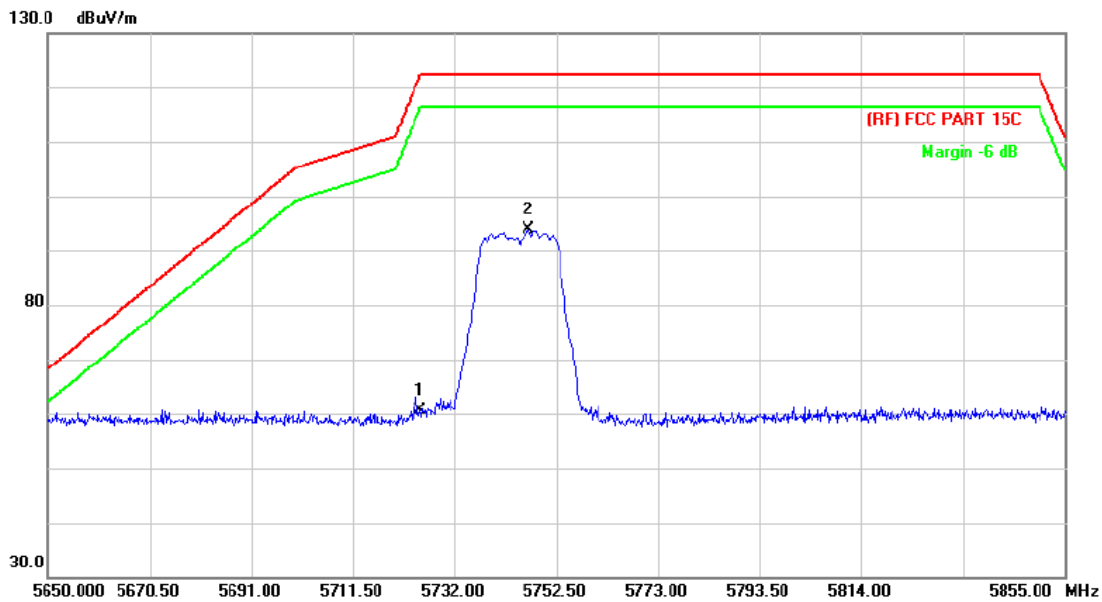

No.	Mk.	Freq. MHz	Reading Level dBuV	Correct Factor dB/m	Measurement dBuV/m	Limit dBuV/m	Over dB	Detector
1		5725.000	42.89	17.84	60.73	122.30	-61.57	peak
2	*	5746.965	75.94	17.98	93.92	122.30	-28.38	peak

Emission Level= Read Level+ Correct Factor

Temperature:	25 °C	Relative Humidity:	55%
Test Voltage:	AC 120V/60Hz		
Ant. Pol.	Vertical		
Test Mode:	TX 802.11a Mode 5745 MHz (U-NII-3)		
Remark:			

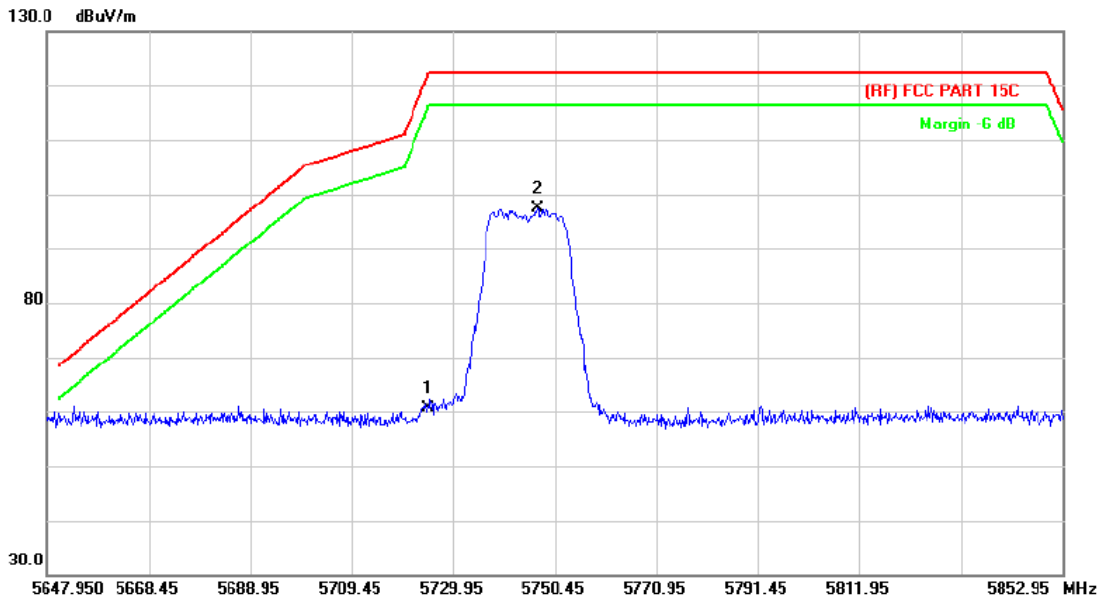

No.	Mk.	Freq. MHz	Reading Level dBuV	Correct Factor dB/m	Measure- ment dBuV/m	Limit dBuV/m	Over dB	Detector
1		5725.000	42.68	17.84	60.52	122.30	-61.78	peak
2	*	5746.965	79.40	17.98	97.38	122.30	-24.92	peak

Emission Level= Read Level+ Correct Factor

Temperature:	25 °C	Relative Humidity:	55%
Test Voltage:	AC 120V/60Hz		
Ant. Pol.	Horizontal		
Test Mode:	TX 802.11a Mode 5825 MHz (U-NII-3)		
Remark:			

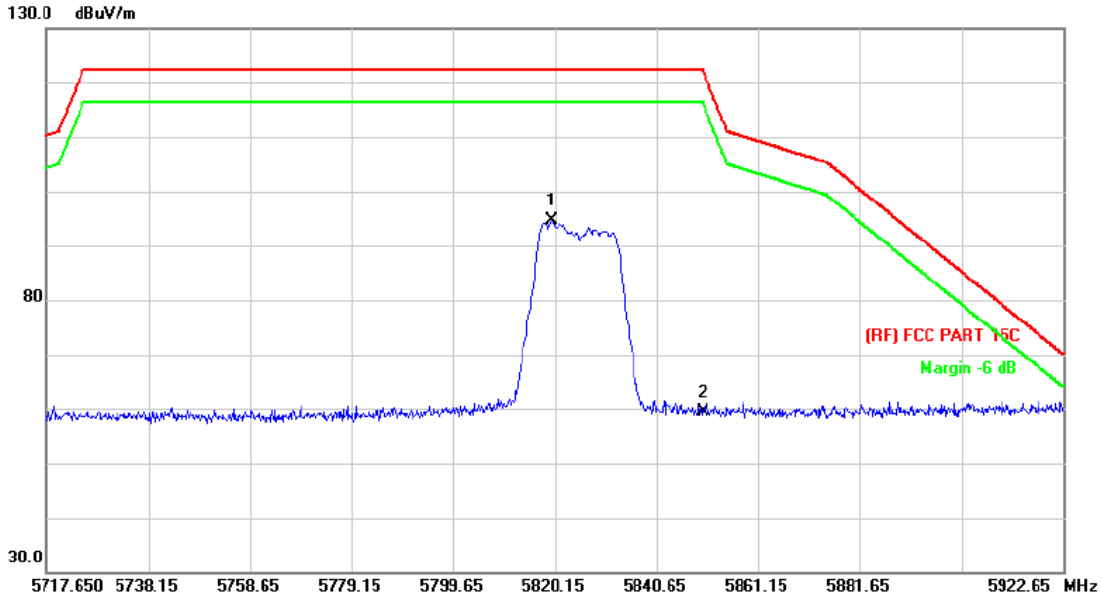

No.	Mk.	Freq. MHz	Reading Level dBuV	Correct Factor dB/m	Measure- ment dBuV/m	Limit dBuV/m	Over dB	Detector
1	*	5819.330	76.12	18.43	94.55	122.30	-27.75	peak
2		5850.000	40.83	18.62	59.45	122.30	-62.85	peak

Emission Level= Read Level+ Correct Factor

Temperature:	25 °C	Relative Humidity:	55%
Test Voltage:	AC 120V/60Hz		
Ant. Pol.	Vertical		
Test Mode:	TX 802.11a Mode 5825 MHz (U-NII-3)		
Remark:			

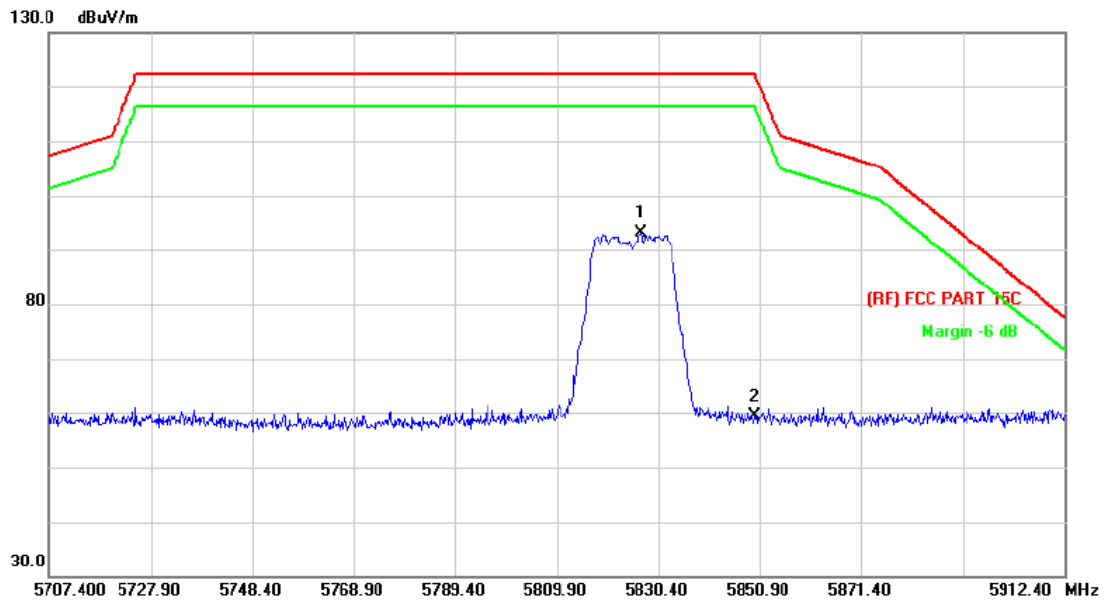

No.	Mk.	Freq. MHz	Reading Level dBuV	Correct Factor dB/m	Measure- ment dBuV/m	Limit dBuV/m	Over dB	Detector
1	*	5826.915	74.54	18.48	93.02	122.30	-29.28	peak
2		5850.000	40.77	18.62	59.39	122.30	-62.91	peak

Emission Level= Read Level+ Correct Factor

Temperature:	25 °C	Relative Humidity:	55%
Test Voltage:	AC 120V/60Hz		
Ant. Pol.	Horizontal		
Test Mode:	TX 802.11n(HT20) Mode 5745 MHz (U-NII-3)		
Remark:			

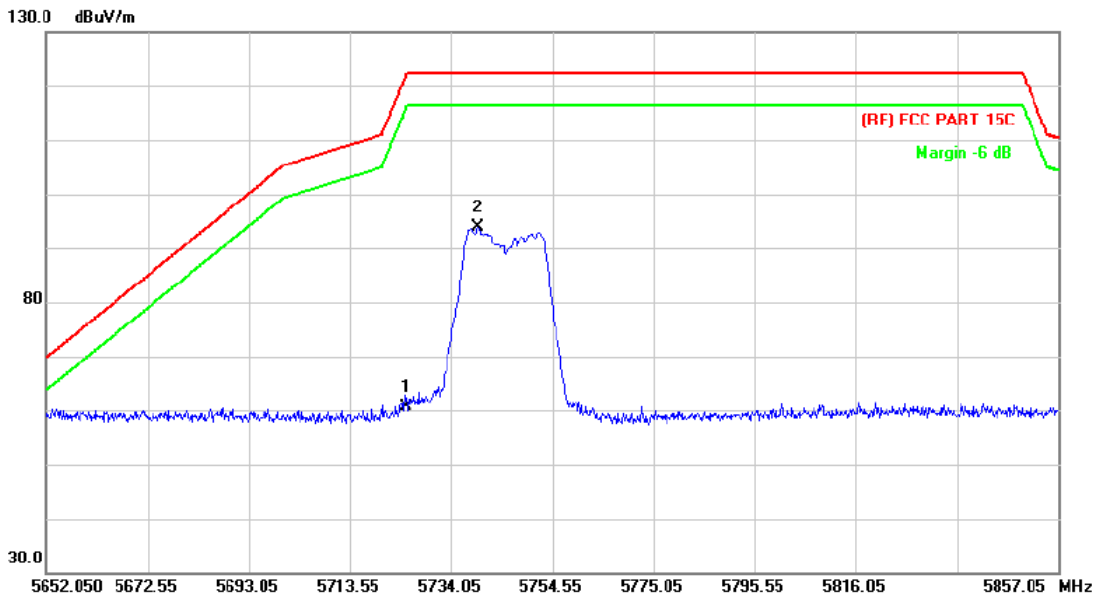

No.	Mk.	Freq. MHz	Reading Level dBuV	Correct Factor dB/m	Measure- ment dBuV/m	Limit dBuV/m	Over dB	Detector
1		5725.000	42.73	17.84	60.57	122.30	-61.73	peak
2	*	5739.380	75.83	17.93	93.76	122.30	-28.54	peak

Emission Level= Read Level+ Correct Factor

Temperature:	25 °C	Relative Humidity:	55%
Test Voltage:	AC 120V/60Hz		
Ant. Pol.	Vertical		
Test Mode:	TX 802.11n(HT20) Mode 5745 MHz (U-NII-3)		
Remark:			

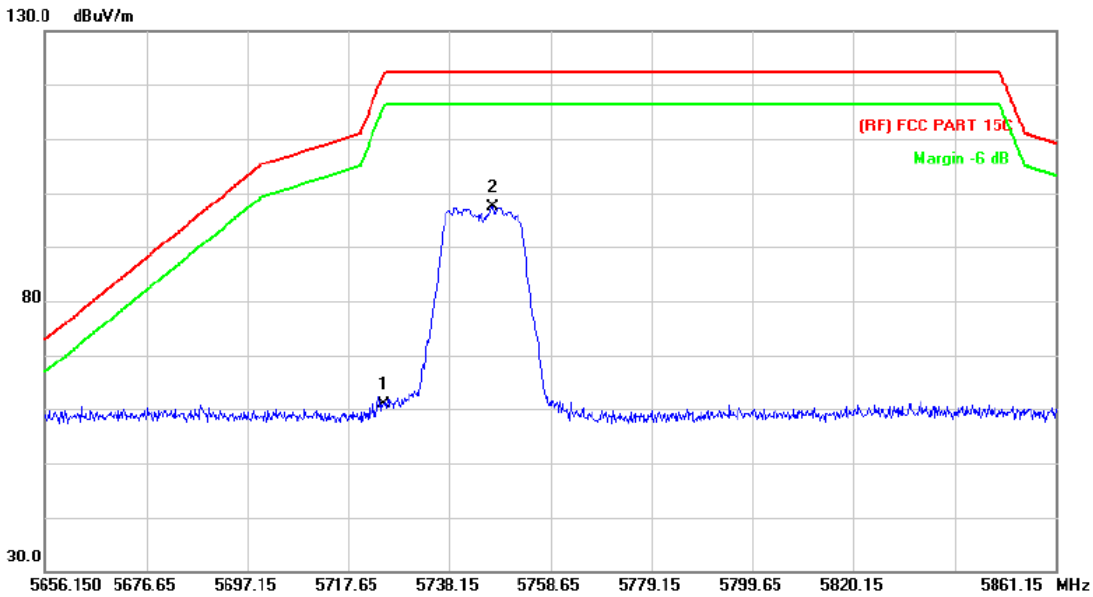

No.	Mk.	Freq. MHz	Reading Level dBuV	Correct Factor dB/m	Measure- ment dBuV/m	Limit dBuV/m	Over dB	Detector
1		5725.000	43.04	17.84	60.88	122.30	-61.42	peak
2	*	5746.965	79.45	17.98	97.43	122.30	-24.87	peak

Emission Level= Read Level+ Correct Factor

Temperature:	25 °C	Relative Humidity:	55%
Test Voltage:	AC 120V/60Hz		
Ant. Pol.	Horizontal		
Test Mode:	TX 802.11n(HT20) Mode 5825 MHz (U-NII-3)		
Remark:			

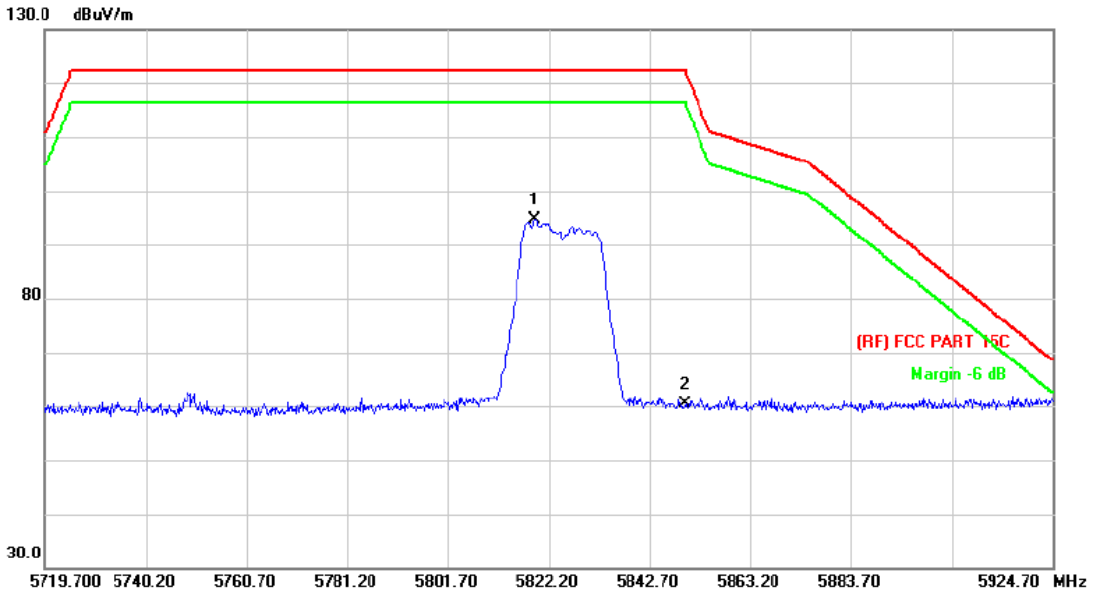

No.	Mk.	Freq. MHz	Reading Level dBuV	Correct Factor dB/m	Measure- ment dBuV/m	Limit dBuV/m	Over dB	Detector
1	*	5819.330	76.10	18.43	94.53	122.30	-27.77	peak
2		5850.000	41.65	18.62	60.27	122.30	-62.03	peak

Emission Level= Read Level+ Correct Factor

Temperature:	25 °C	Relative Humidity:	55%
Test Voltage:	AC 120V/60Hz		
Ant. Pol.	Vertical		
Test Mode:	TX 802.11n(HT20) Mode 5825 MHz (U-NII-3)		
Remark:			

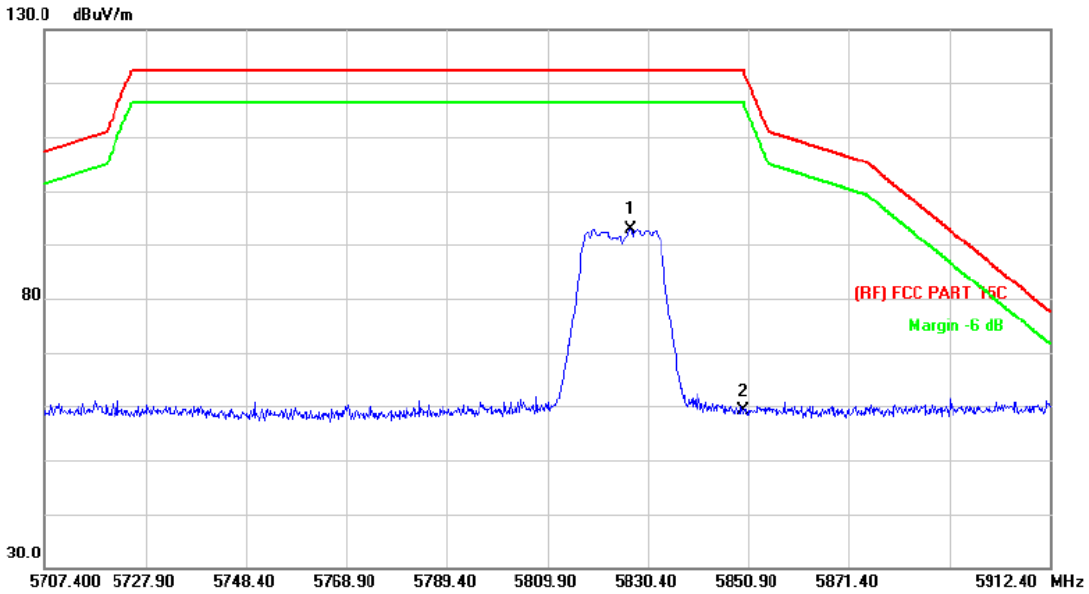

No.	Mk.	Freq. MHz	Reading Level dBuV	Correct Factor dB/m	Measure- ment dBuV/m	Limit dBuV/m	Over dB	Detector
1	*	5826.915	74.51	18.48	92.99	122.30	-29.31	peak
2		5850.000	40.62	18.62	59.24	122.30	-63.06	peak

Emission Level= Read Level+ Correct Factor

Temperature:	25 °C	Relative Humidity:	55%
Test Voltage:	AC 120V/60Hz		
Ant. Pol.	Horizontal		
Test Mode:	TX 802.11n(HT40) Mode 5755 MHz (U-NII-3)		
Remark:			

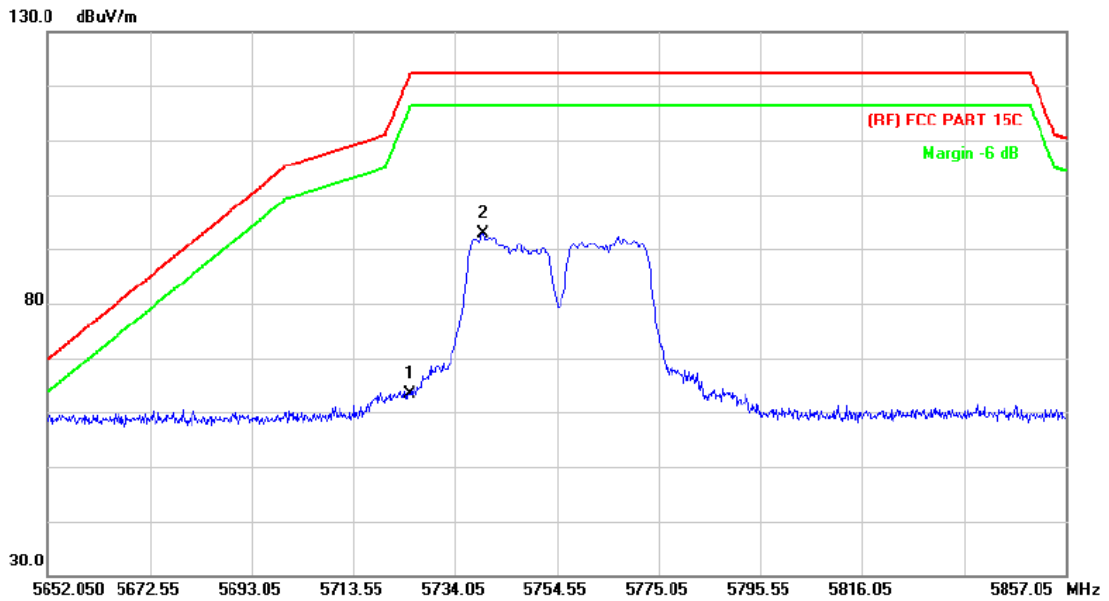

No.	Mk.	Freq. MHz	Reading Level dBuV	Correct Factor dB/m	Measure- ment dBuV/m	Limit dBuV/m	Over dB	Detector
1		5725.000	45.45	17.84	63.29	122.30	-59.01	peak
2	*	5739.585	74.93	17.93	92.86	122.30	-29.44	peak

Emission Level= Read Level+ Correct Factor

Temperature:	25 °C	Relative Humidity:	55%
Test Voltage:	AC 120V/60Hz		
Ant. Pol.	Vertical		
Test Mode:	TX 802.11n(HT40) Mode 5755 MHz (U-NII-3)		
Remark:			

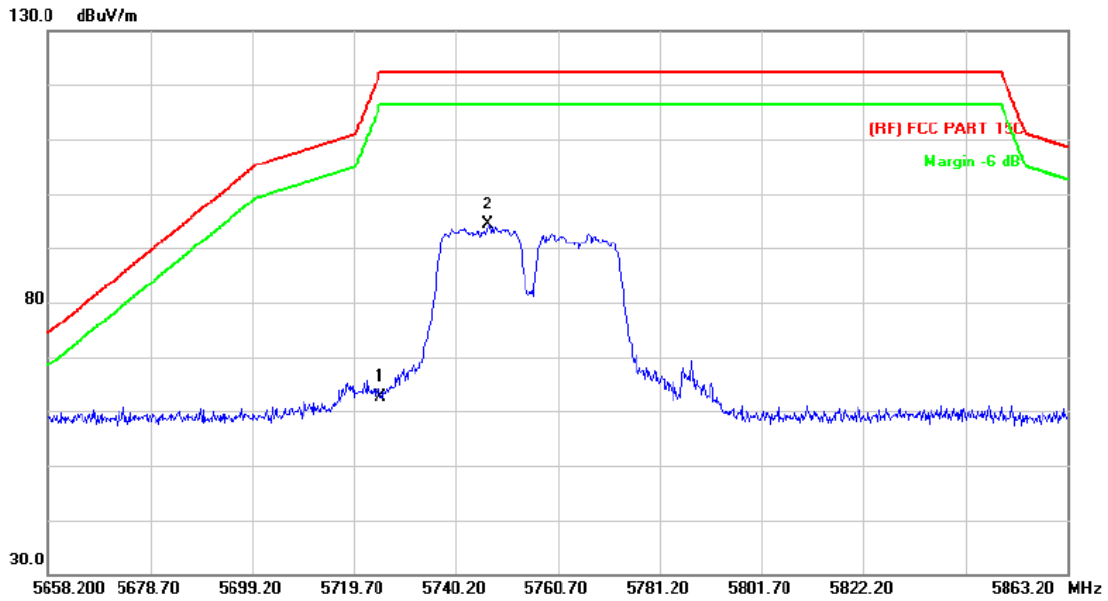

No.	Mk.	Freq. MHz	Reading Level dBuV	Correct Factor dB/m	Measure- ment dBuV/m	Limit dBuV/m	Over dB	Detector
1		5725.000	44.75	17.84	62.59	122.30	-59.71	peak
2	*	5746.760	76.47	17.98	94.45	122.30	-27.85	peak

Emission Level= Read Level+ Correct Factor

Temperature:	25 °C	Relative Humidity:	55%
Test Voltage:	AC 120V/60Hz		
Ant. Pol.	Horizontal		
Test Mode:	TX 802.11n(HT40) Mode 5795 MHz (U-NII-3)		
Remark:			

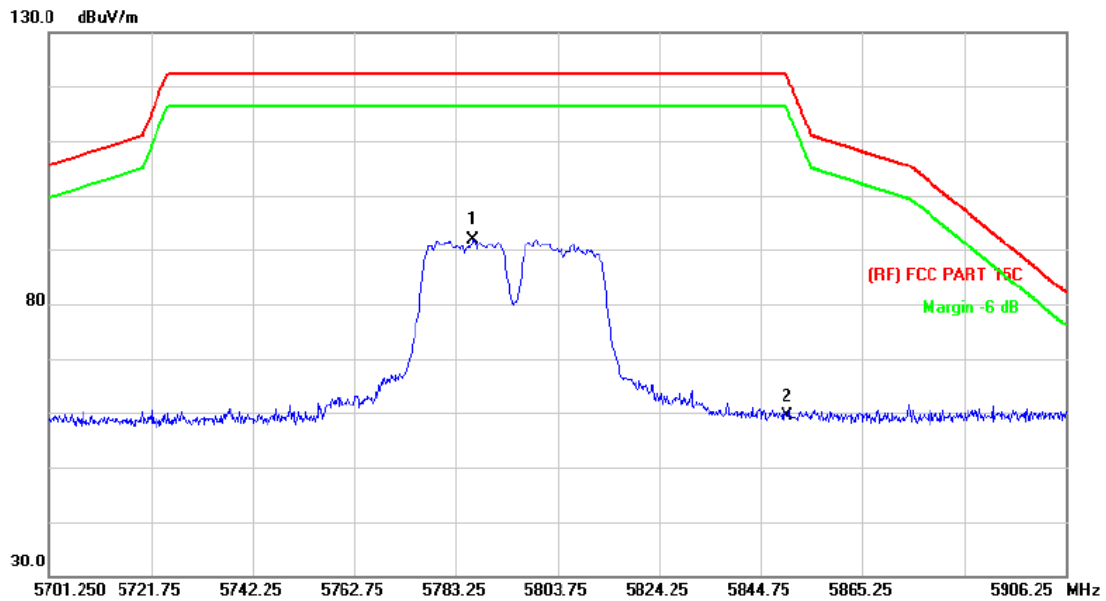

No.	Mk.	Freq. MHz	Reading Level dBuV	Correct Factor dB/m	Measure- ment dBuV/m	Limit dBuV/m	Over dB	Detector
1	*	5786.735	73.59	18.23	91.82	122.30	-30.48	peak
2		5850.000	40.68	18.62	59.30	122.30	-63.00	peak

Emission Level= Read Level+ Correct Factor

Temperature:	25 °C	Relative Humidity:	55%
Test Voltage:	AC 120V/60Hz		
Ant. Pol.	Vertical		
Test Mode:	TX 802.11n(HT40) Mode 5795 MHz (U-NII-3)		
Remark:			

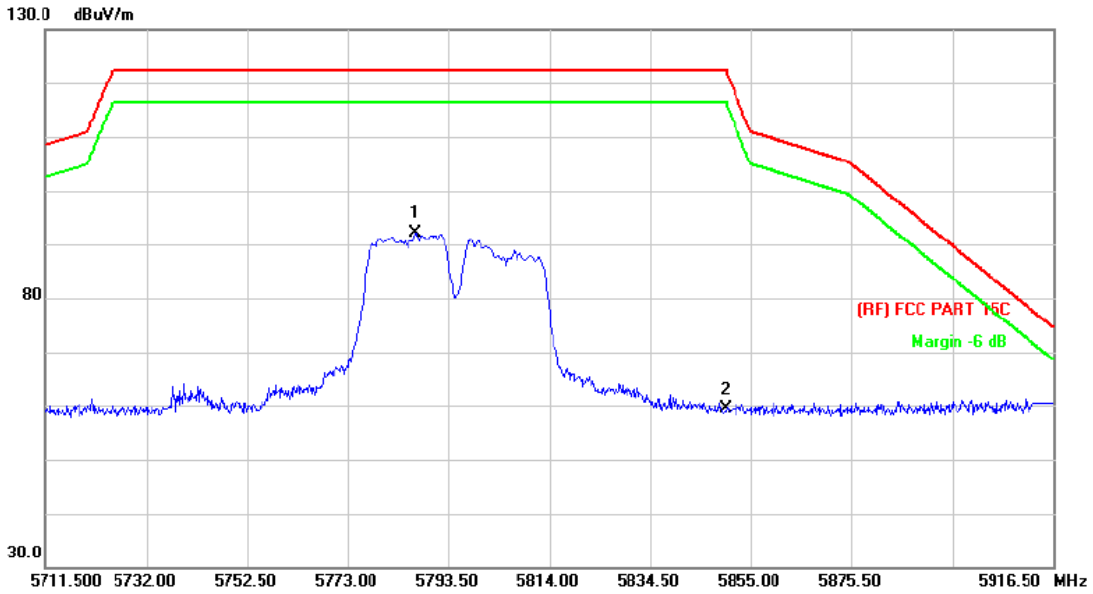

No.	Mk.	Freq. MHz	Reading Level dBuV	Correct Factor dB/m	Measure- ment dBuV/m	Limit dBuV/m	Over dB	Detector
1	*	5786.940	73.91	18.23	92.14	122.30	-30.16	peak
2		5850.000	40.68	18.62	59.30	122.30	-63.00	peak

Emission Level= Read Level+ Correct Factor

(2) Conducted Test

Temperature:	25 °C	Relative Humidity:	55%
Test Voltage:	AC 120V/60Hz		
Test Mode:	TX 802.11a mode(U-NII-1) / 5180MHz&5240MHz		
Remark:	The EUT is programed in continuously transmitting mode		

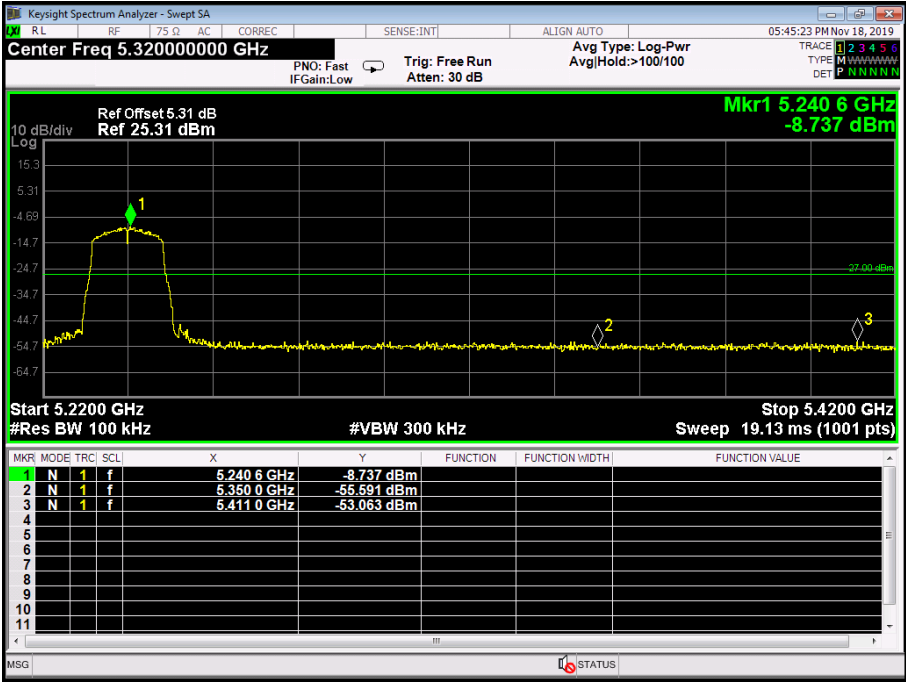
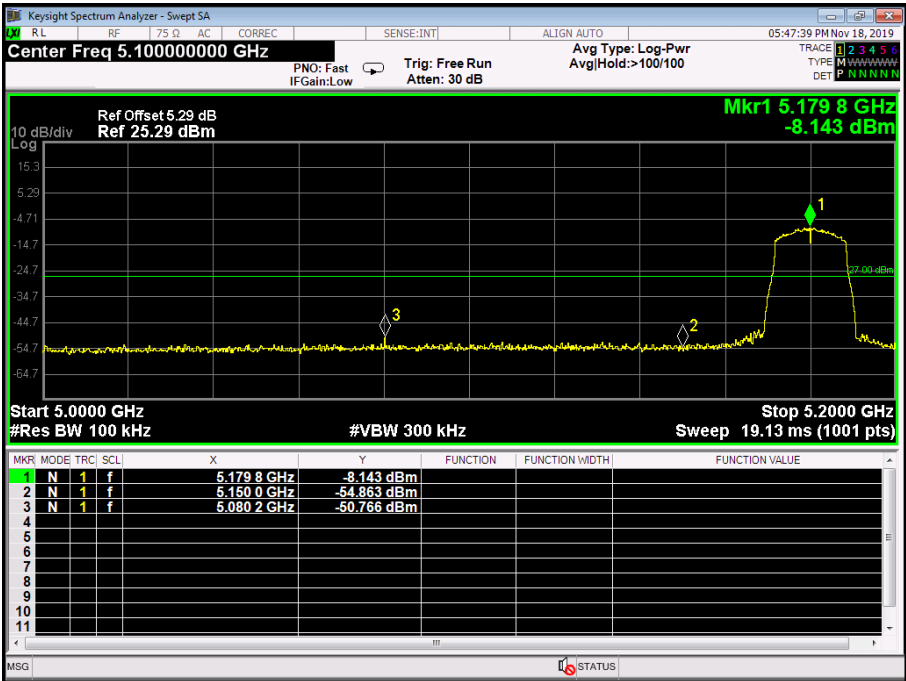

Temperature:	25 °C	Relative Humidity:	55%
Test Voltage:	AC 120V/60Hz		
Test Mode:	TX 802.11n(HT20) mode(U-NII-1) / 5180MHz&5240MHz		
Remark:	The EUT is programed in continuously transmitting mode		

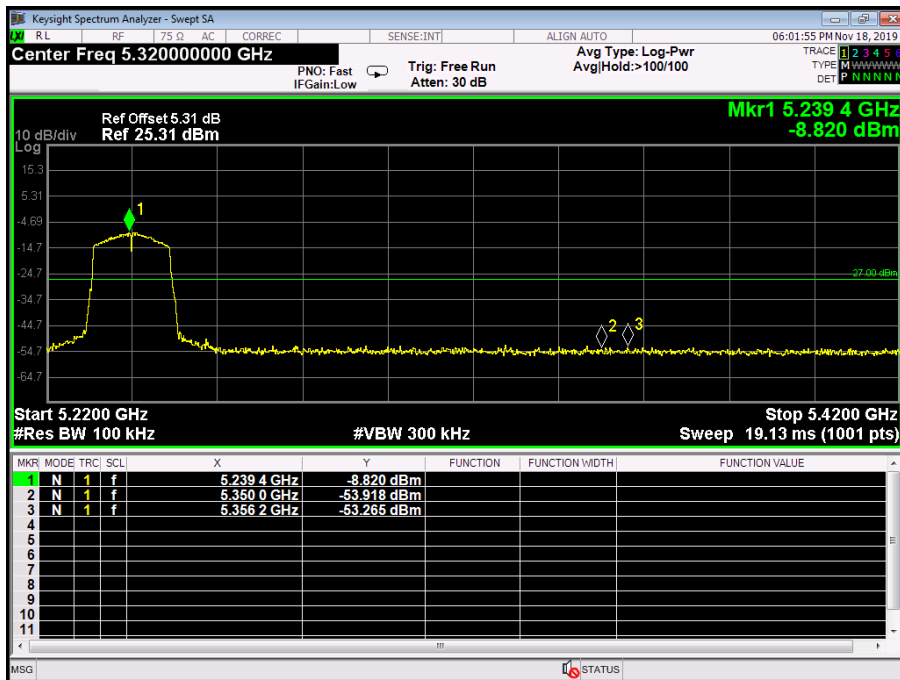
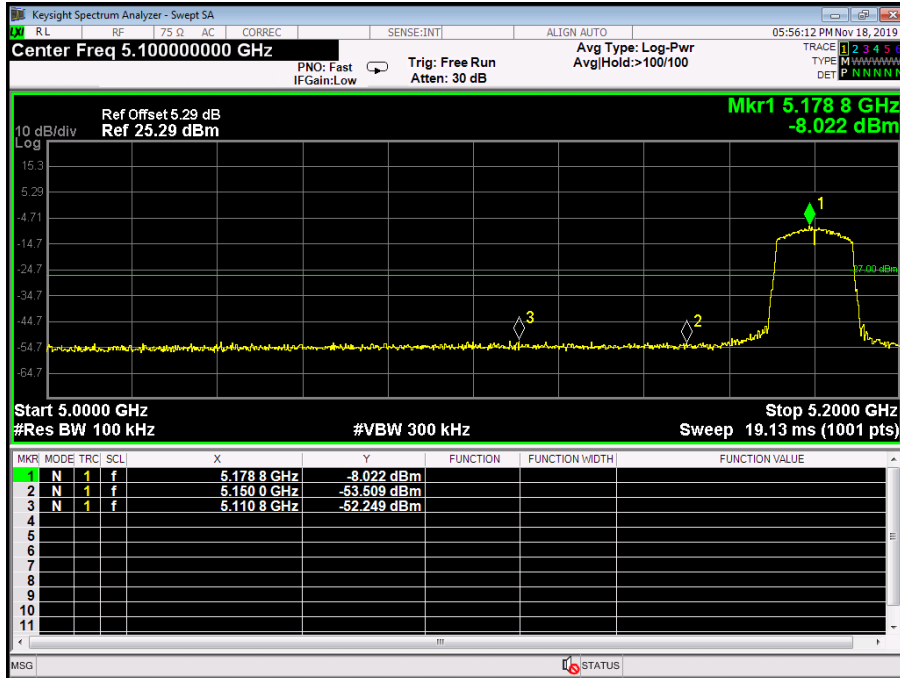

Temperature:	25 °C	Relative Humidity:	55%
Test Voltage:	AC 120V/60Hz		
Test Mode:	TX 802.11n(HT40) mode(U-NII-1) / 5190MHz&5230MHz		
Remark:	The EUT is programed in continuously transmitting mode		

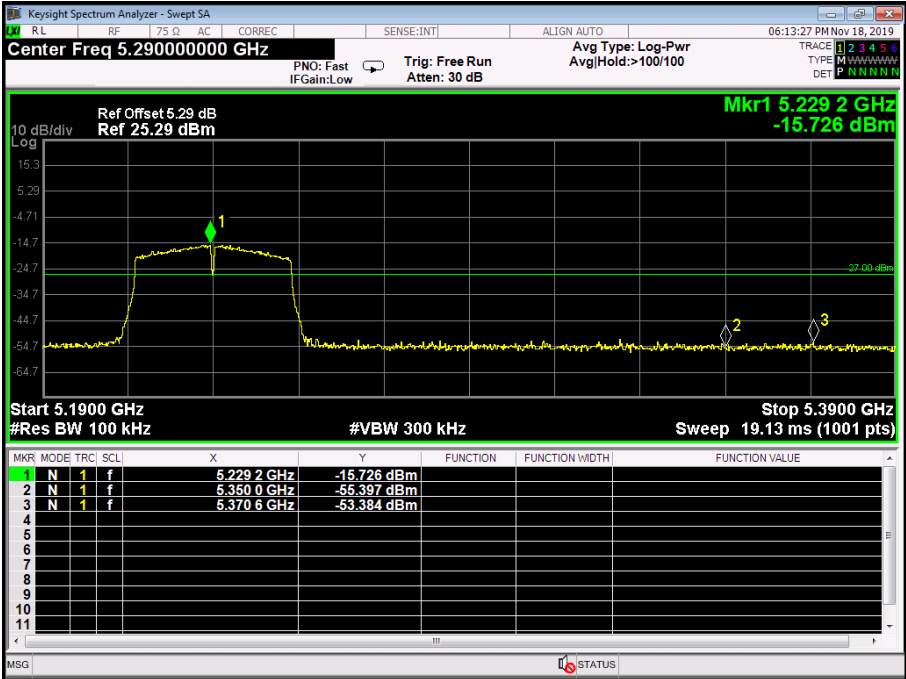
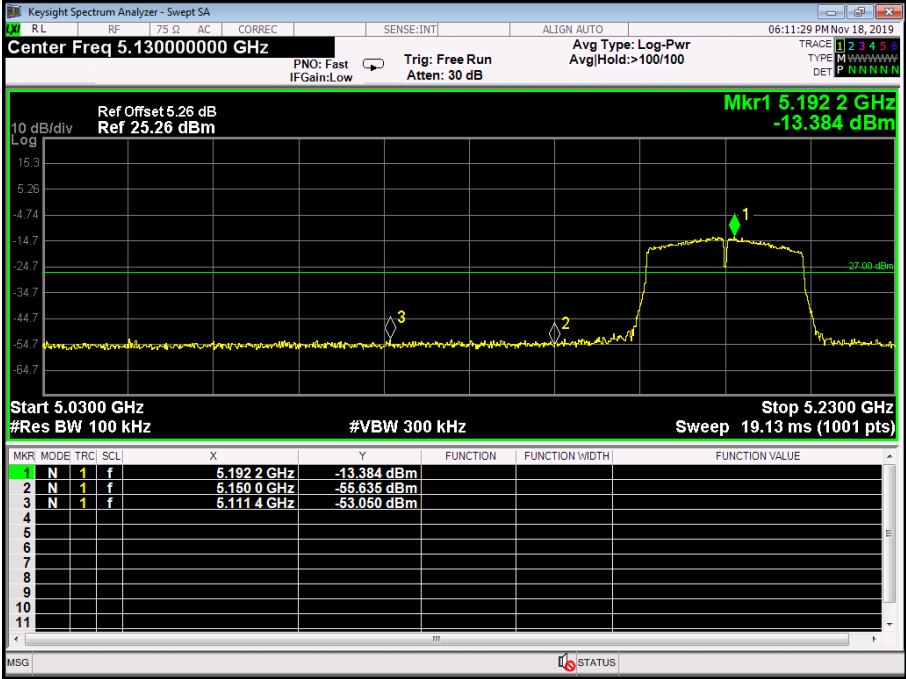

Temperature:	25 °C	Relative Humidity:	55%
Test Voltage:	AC 120V/60Hz		
Test Mode:	TX 802.11a Mode 5745MHz /5825MHz (U-NII-3)		
Remark:	The EUT is programed in continuously transmitting mode		

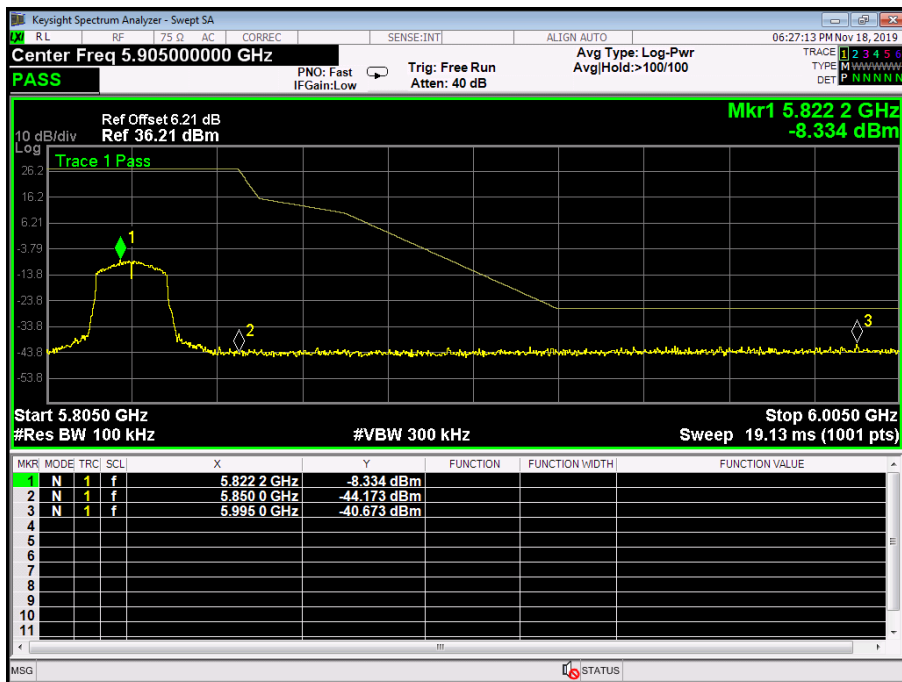
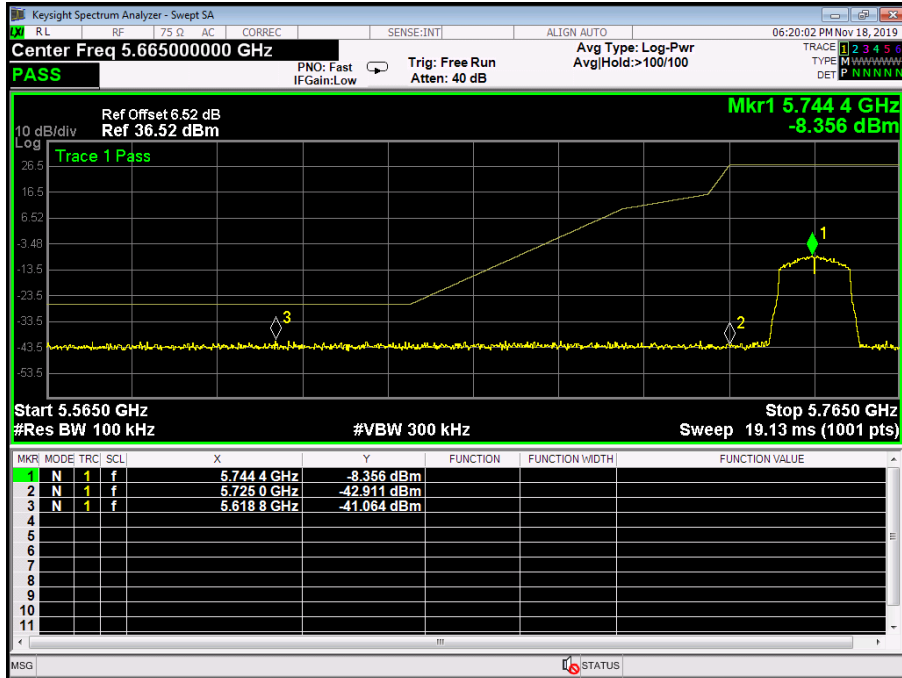

Temperature:	25 °C	Relative Humidity:	55%
Test Voltage:	AC 120V/60Hz		
Test Mode:	TX 802.11n(HT20) Mode 5745MHz /5825MHz (U-NII-3)		
Remark:	The EUT is programed in continuously transmitting mode		

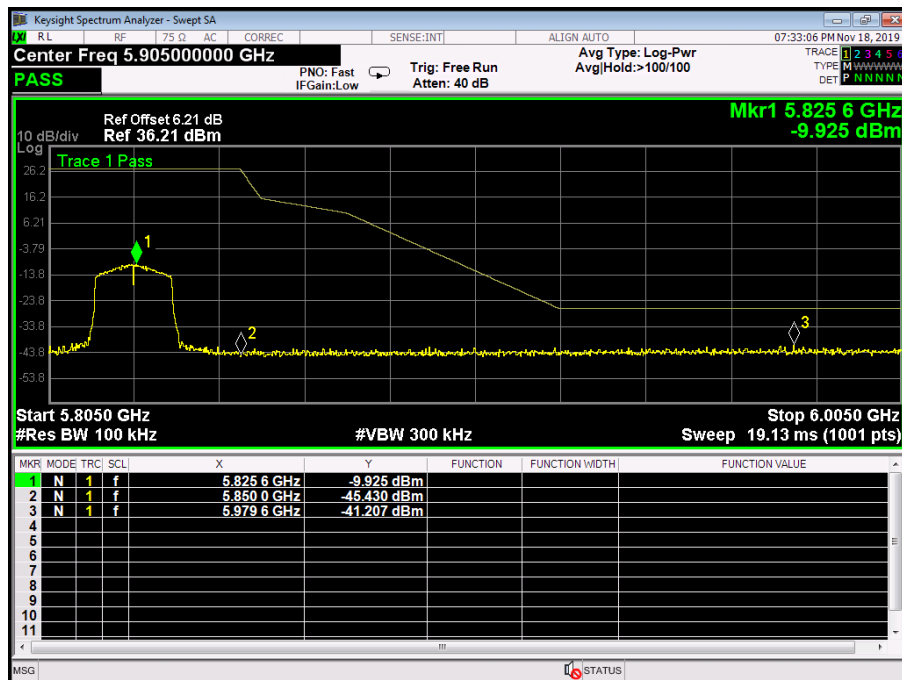
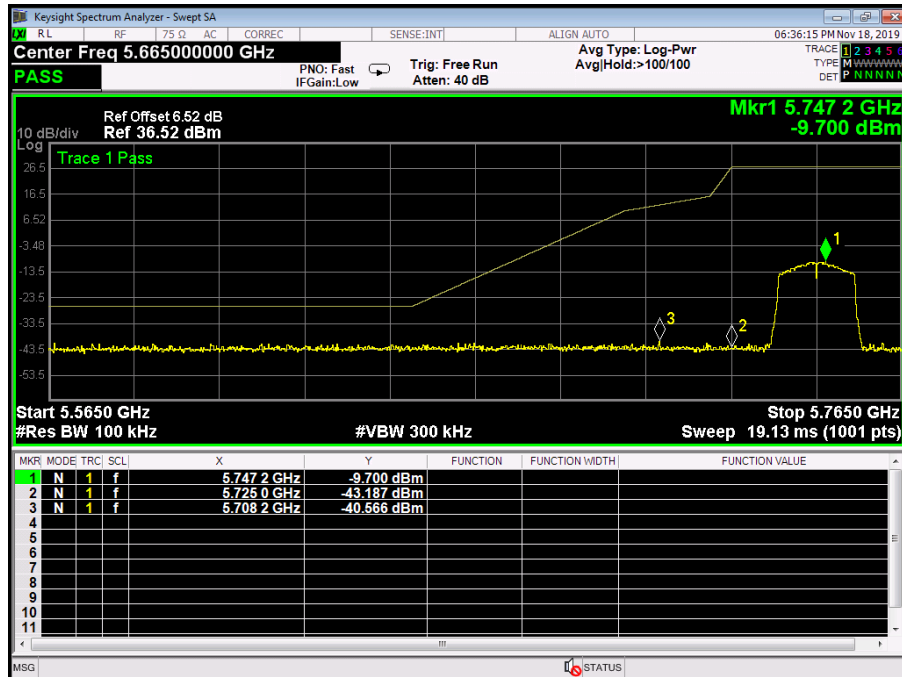

Temperature:	25 °C	Relative Humidity:	55%
Test Voltage:	AC 120V/60Hz		
Test Mode:	TX 802.11 n(HT40) Mode 5755MHz/5795 (U-NII-3)		
Remark:	The EUT is programed in continuously transmitting mode		

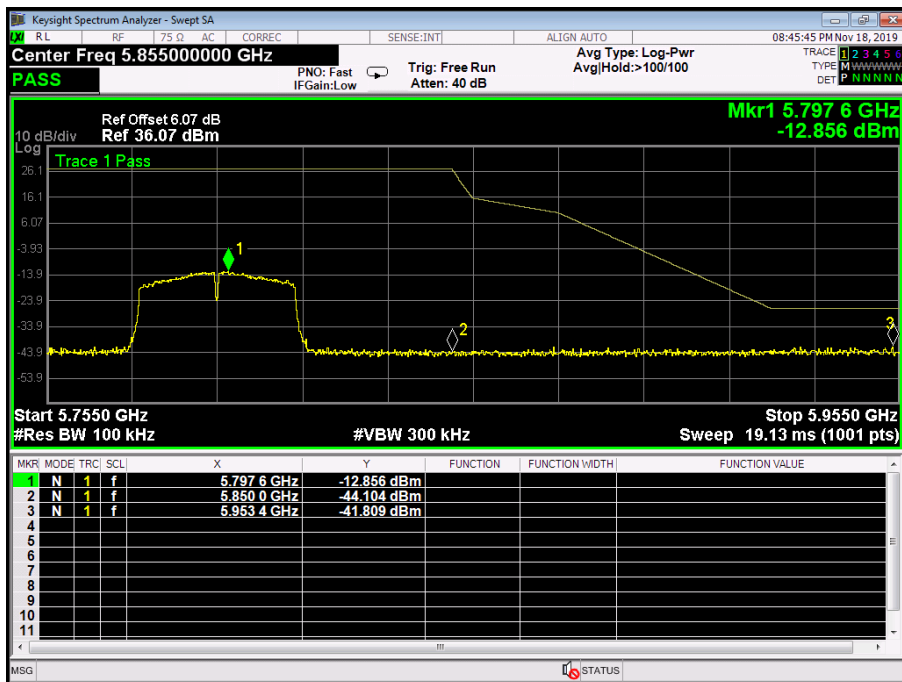
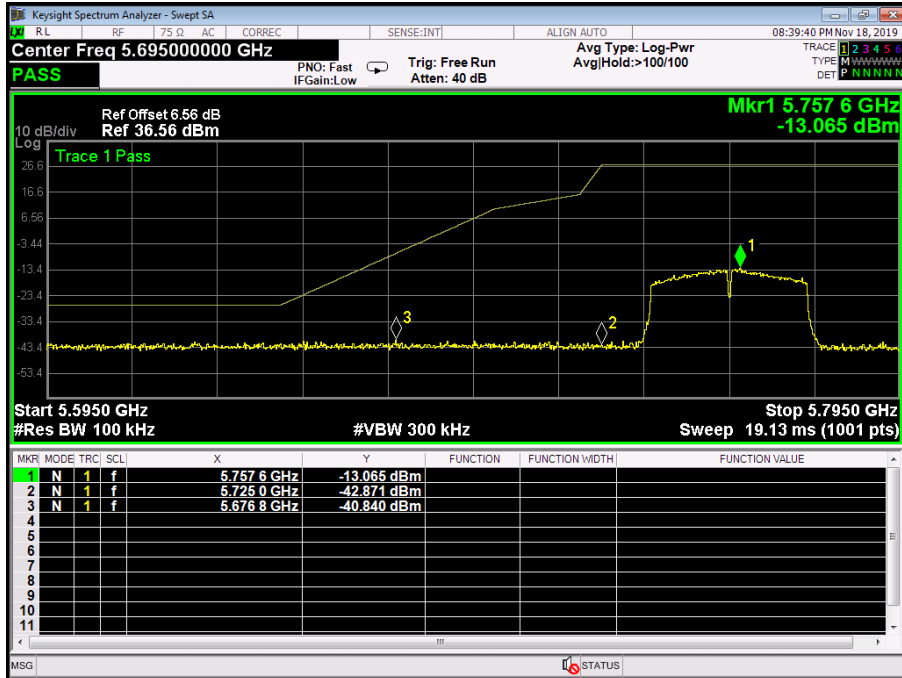

Attachment D--Bandwidth Test Data

Temperature:	25 °C	Relative Humidity:	55%
Test Voltage:	AC 120V/60Hz		
Test Mode:	TX 802.11a Mode (U-NII-1)		
Channel	Frequency (MHz)	26dB Bandwidth (MHz)	99% Bandwidth (MHz)
36	5180	19.96	16.448
40	5200	19.87	16.512
48	5240	19.77	16.465

802.11a Mode
5180 MHz

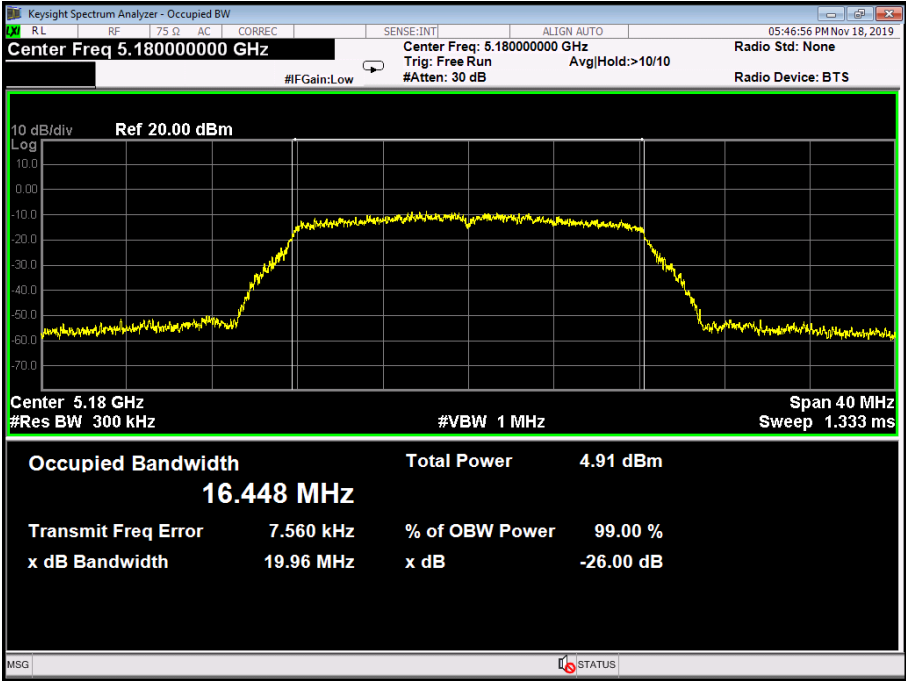

802.11a Mode

5200 MHz

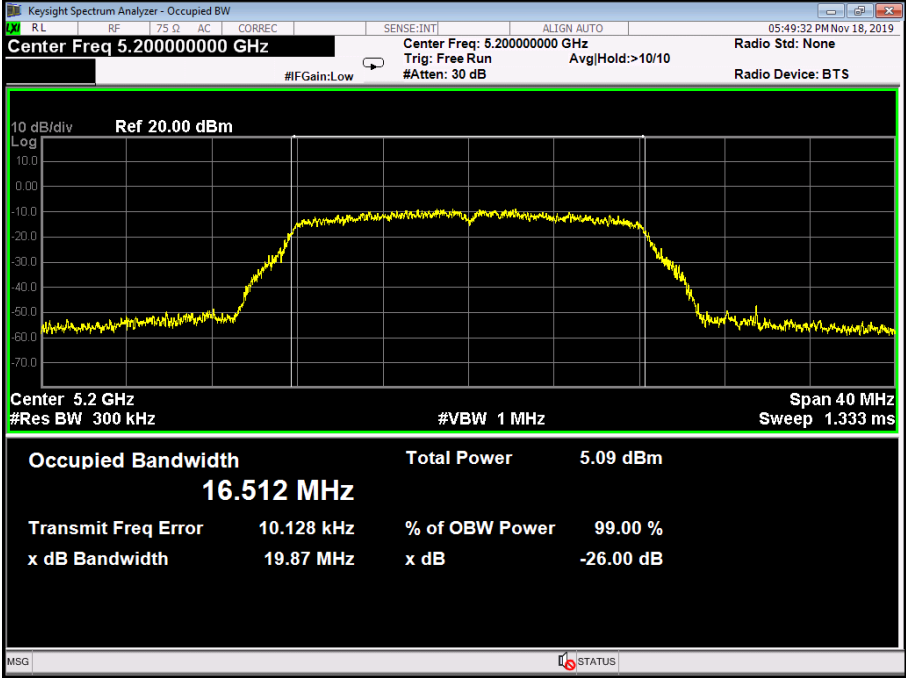

802.11a Mode

5240 MHz

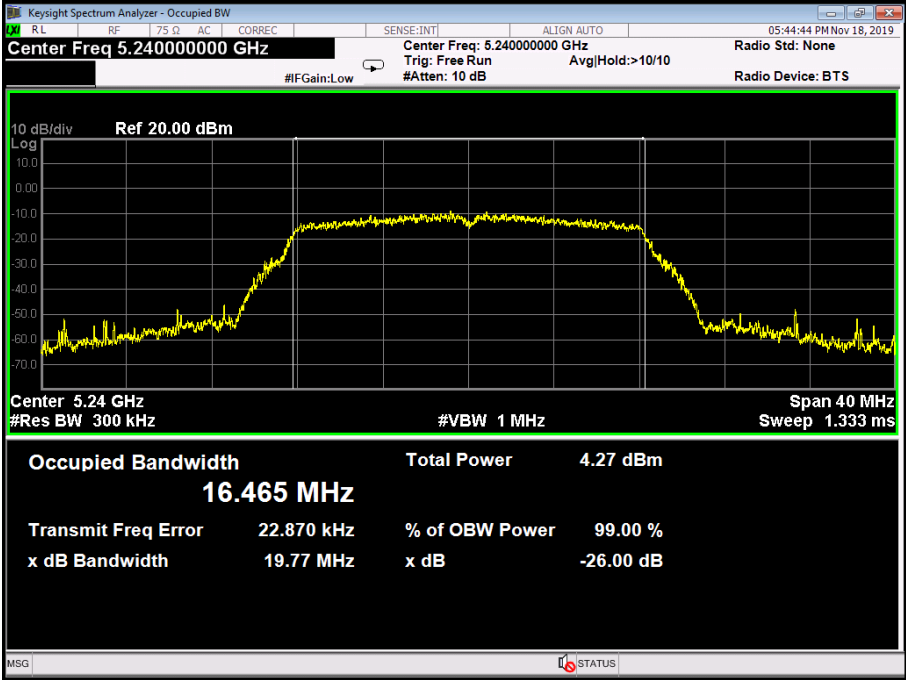

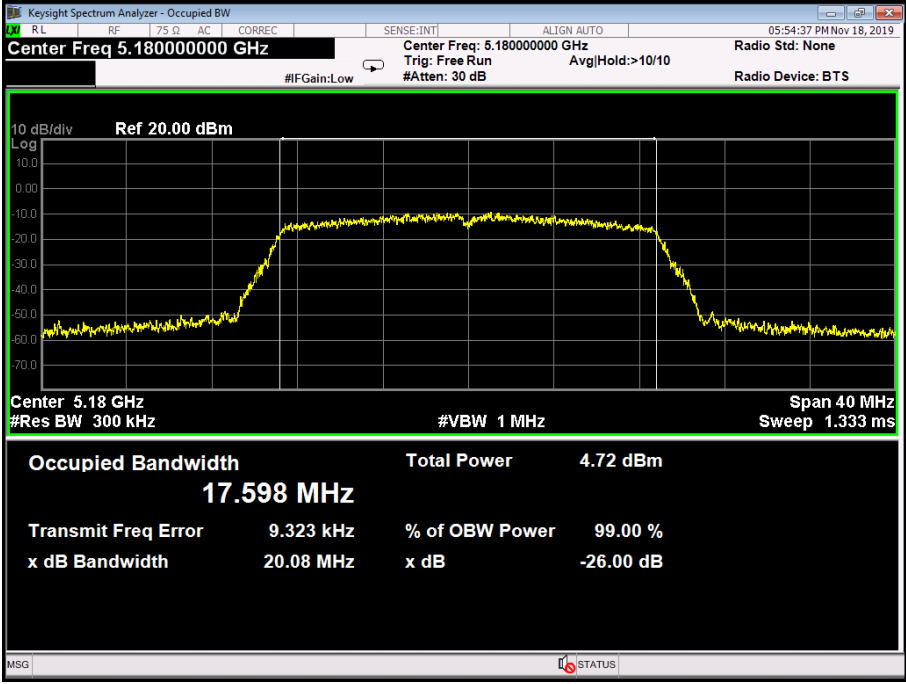
Temperature:	25 °C	Relative Humidity:	55%
Test Voltage:	AC 120V/60Hz		
Test Mode:	TX 802.11n(HT20) Mode (U-NII-1)		
Channel	Frequency (MHz)	26dB Bandwidth (MHz)	99% Bandwidth (MHz)
36	5180	20.08	17.598
40	5200	20.33	17.579
48	5240	20.34	17.609
802.11n(HT20) Mode			
5180 MHz			
			

802.11n(HT20) Mode

5200 MHz

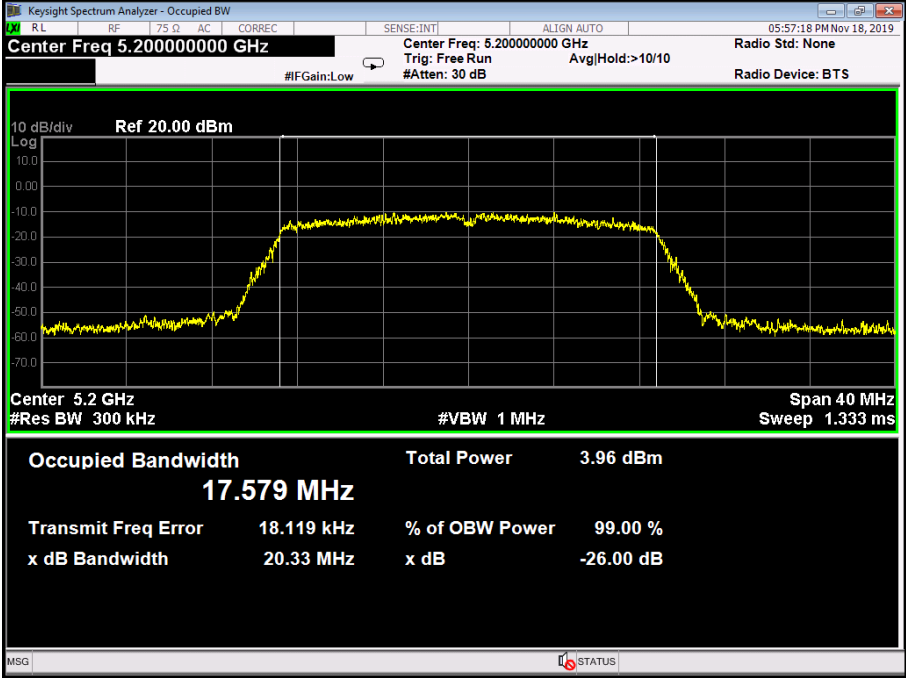

802.11n(HT20) Mode

5240 MHz

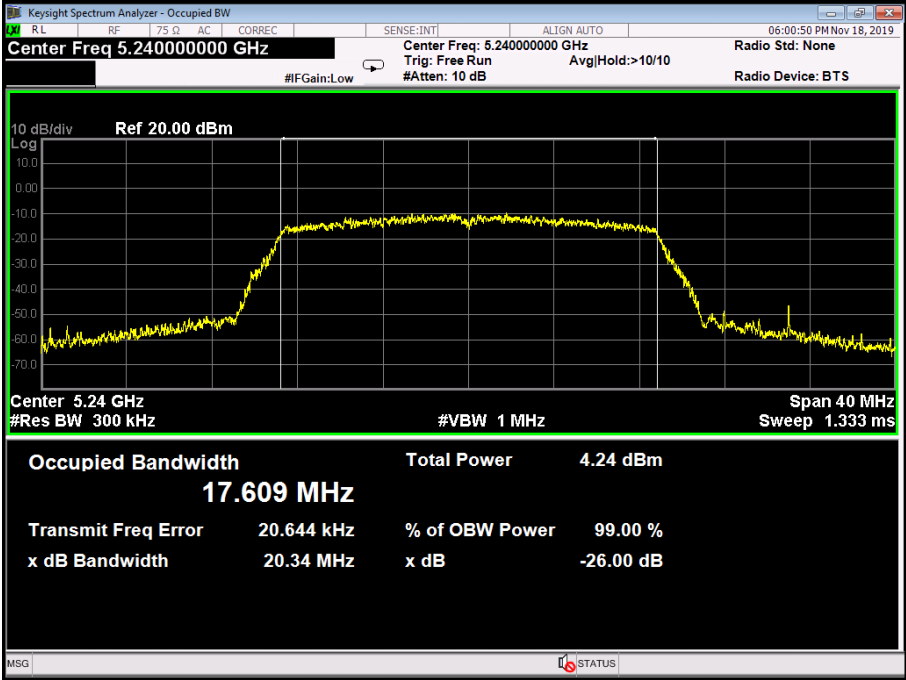

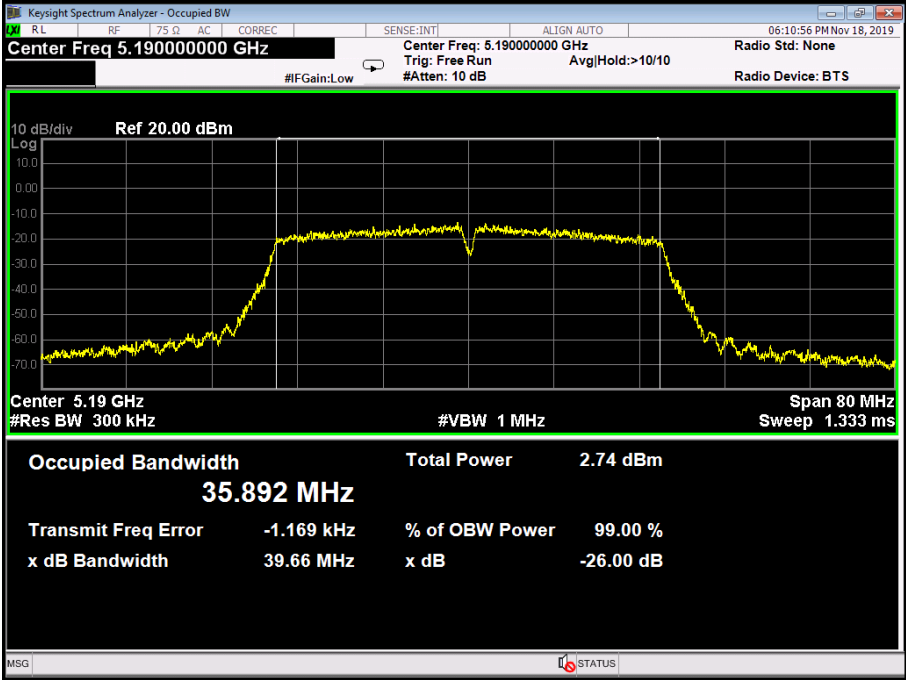
Temperature:	25 °C	Relative Humidity:	55%
Test Voltage:	AC 120V/60Hz		
Test Mode:	TX 802.11N(HT40) Mode (U-NII-1)		
Channel	Frequency (MHz)	26dB Bandwidth (MHz)	99% Bandwidth (MHz)
38	5190	39.66	35.892
46	5230	39.37	35.838
802.11N(HT40) Mode			
5190 MHz			
			

802.11N(HT40) Mode

5230 MHz

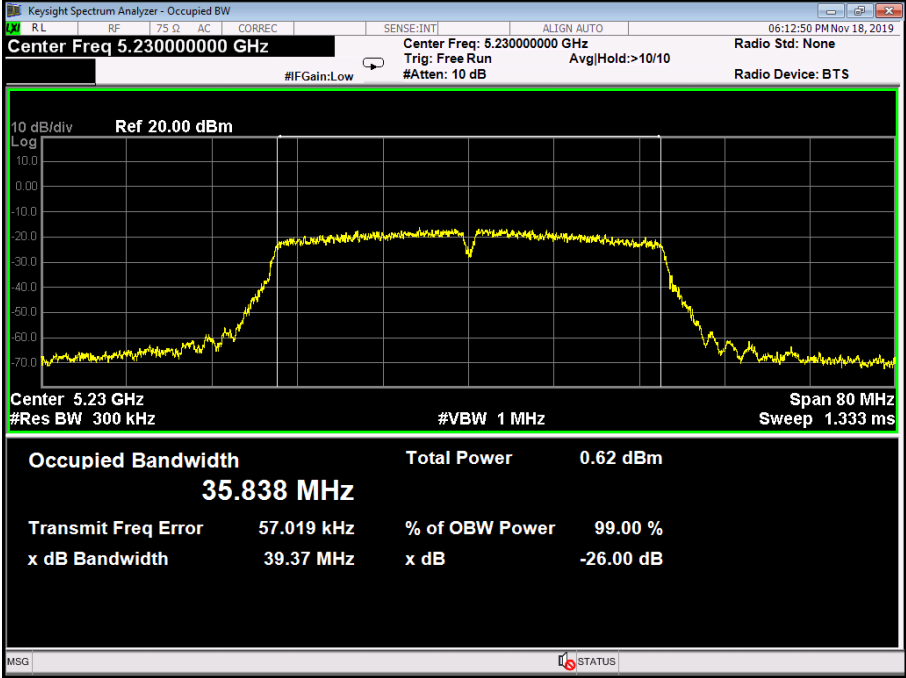

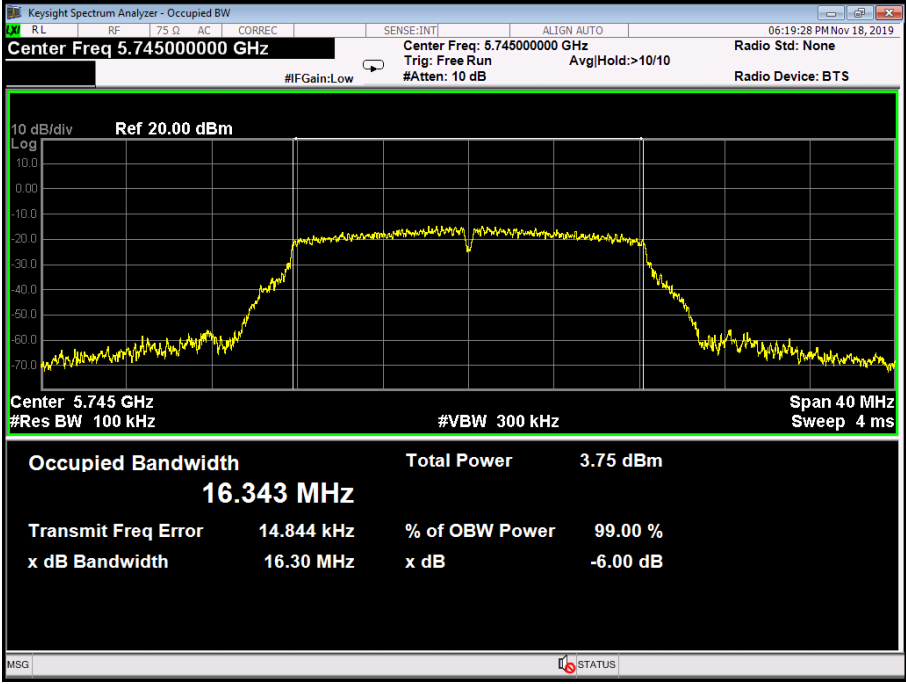
Temperature:	25 °C	Relative Humidity:	55%
Test Voltage:	AC 120V/60Hz		
Test Mode:	TX 802.11a Mode (U-NII-3)		
Channel	Frequency (MHz)	6dB Bandwidth (MHz)	99% Bandwidth (MHz)
149	5745	16.30	16.343
157	5785	16.33	16.351
165	5825	16.30	16.340
802.11a Mode			
5745 MHz			
			

802.11a Mode

5785 MHz

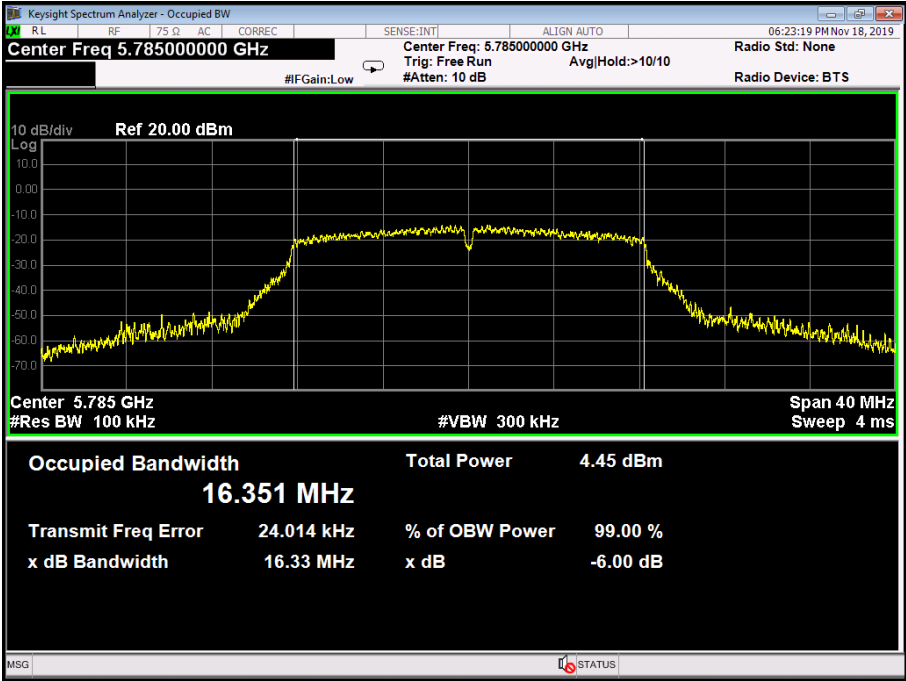

802.11a Mode

5825 MHz

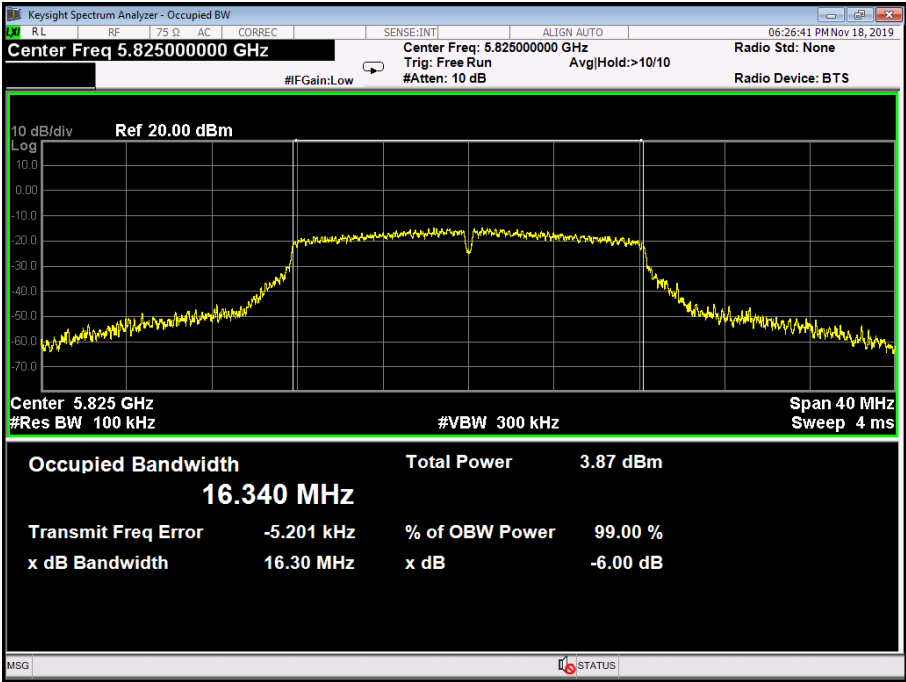

Temperature:	25 °C	Relative Humidity:	55%
Test Voltage:	AC 120V/60Hz		
Test Mode:	TX 802.11n(HT20) Mode (U-NII-3)		
Channel	Frequency (MHz)	6dB Bandwidth (MHz)	99% Bandwidth (MHz)
149	5745	17.56	17.508
157	5785	17.53	17.511
165	5825	17.25	17.547
802.11n(HT20) Mode			
5745 MHz			
<p>Keysight Spectrum Analyzer - Occupied BW</p> <p>Center Freq 5.74500000 GHz</p> <p>Center Freq: 5.745000000 GHz</p> <p>Trig: Free Run</p> <p>#Atten: 10 dB</p> <p>Avg/Hold:>10/10</p> <p>Radio Std: None</p> <p>Radio Device: BTS</p> <p>#FGain:Low</p> <p>10 dB/div</p> <p>Ref 20.00 dBm</p> <p>Log</p> <p>Center 5.745 GHz</p> <p>#Res BW 100 kHz</p> <p>#VBW 300 kHz</p> <p>Span 40 MHz</p> <p>Sweep 4 ms</p> <p>Occupied Bandwidth Total Power 2.60 dBm</p> <p>17.508 MHz</p> <p>Transmit Freq Error 13.092 kHz % of OBW Power 99.00 %</p> <p>x dB Bandwidth 17.56 MHz x dB -6.00 dB</p>			

**802.11n(HT20) Mode
5785 MHz**

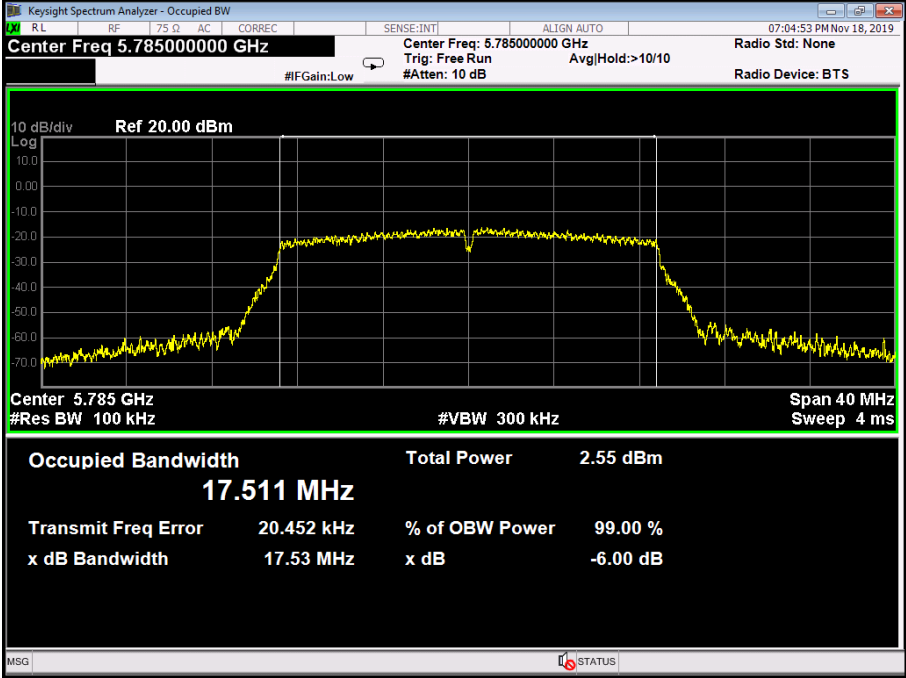

**802.11n(HT20) Mode
5825 MHz**

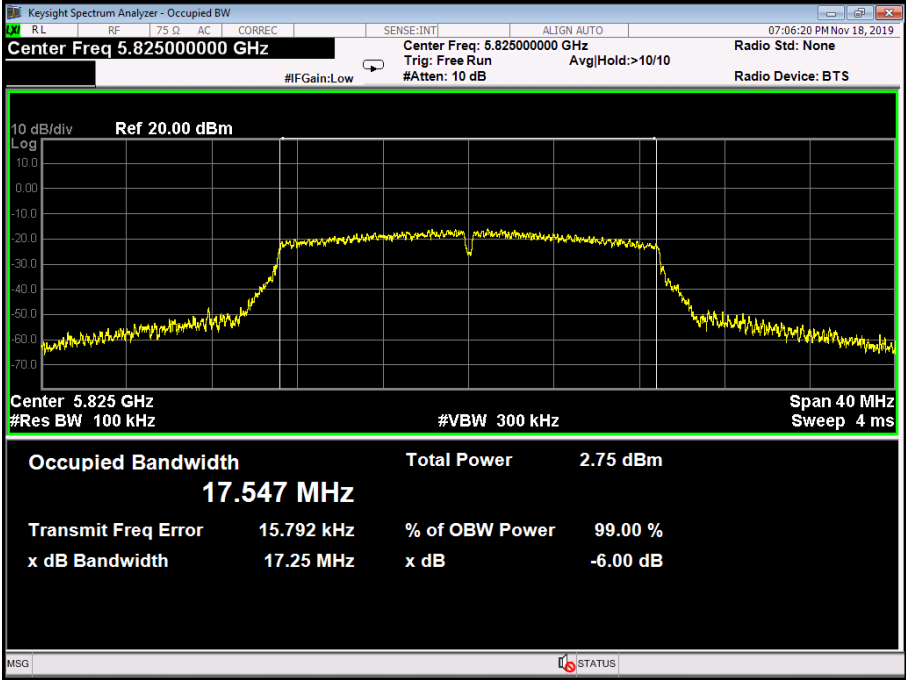

Temperature:	25 °C	Relative Humidity:	55%
Test Voltage:	AC 120V/60Hz		
Test Mode:	TX 802.11n(HT40) Mode (U-NII-3)		
Channel	Frequency (MHz)	6dB Bandwidth (MHz)	99% Bandwidth (MHz)
151	5755	36.31	35.852
159	5795	35.52	36.808

802.11n(HT40) Mode

5755 MHz

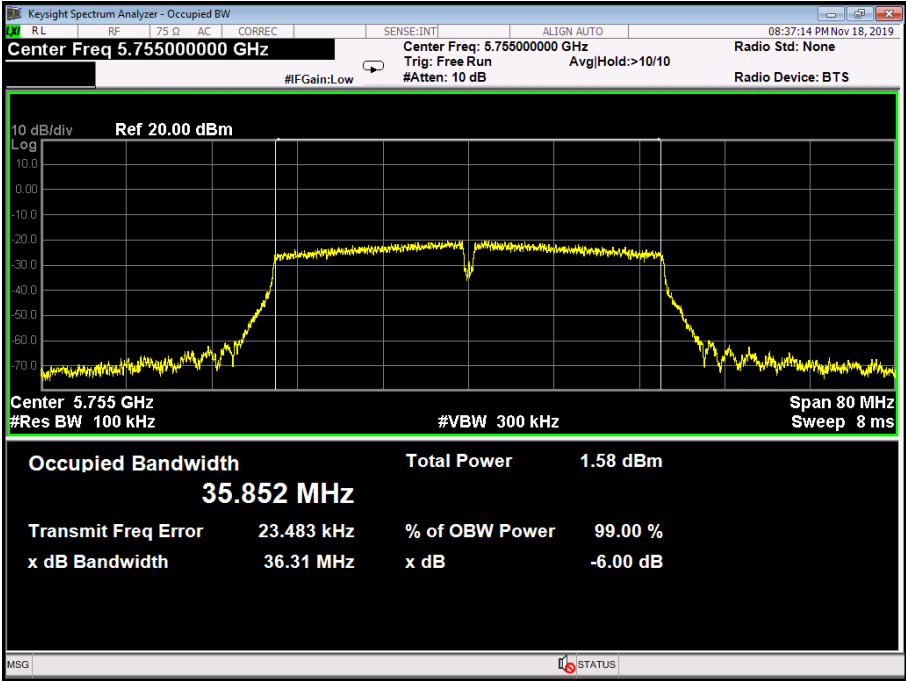

802.11n(HT40) Mode

5795 MHz

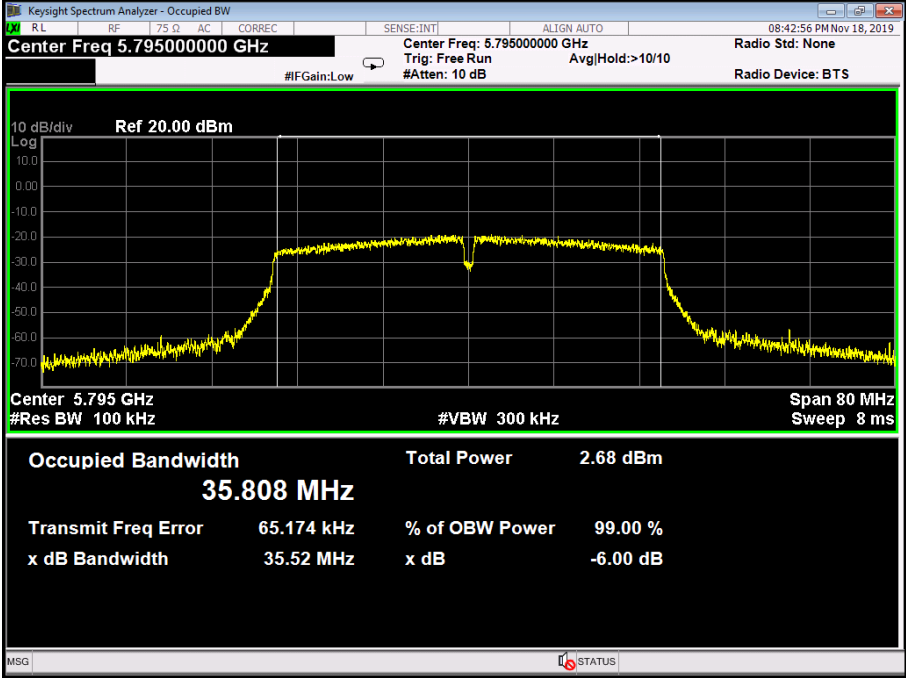

Attachment E--AVG Output Power Test Data

Temperature:	25 °C	Relative Humidity:	55%		
Test Voltage:	AC 120V/60Hz				
U-NII-1					
Test Mode	Frequency (MHz)	Test Data			Limit (dBm)
		Conducted Power (dBm)	Duty Factor (dB)	Total Power (dBm)	
802.11a	5180	6.43	0	6.43	24
	5200	6.44	0	6.44	
	5240	6.25	0	6.25	
802.11n (HT20)	5180	6.42	0	6.42	
	5200	6.12	0	6.12	
	5240	6.14	0	6.14	
802.11n (HT40)	5190	6.35	0	6.35	
	5230	6.22	0	6.22	
Result: PASS					

Temperature:	25 °C	Relative Humidity:	55%		
Test Voltage:	AC 120V/60Hz				
U-NII-3					
Test Mode	Frequency (MHz)	Test Data			Limit (dBm)
		Conducted Power (dBm)	Duty Factor (dB)	Total Power (dBm)	
802.11a	5745	6.52	0	6.52	30
	5785	6.14	0	6.14	
	5825	6.02	0	6.02	
802.11n (HT20)	5745	6.22	0	6.22	
	5785	6.14	0	6.14	
	5825	6.10	0	6.10	
802.11n (HT40)	5755	6.11	0	6.11	
	5795	6.11	0	6.11	
Result: PASS					

Test Mode		Duty cycle
U-NII-1	802.11 a	>98%
	802.11 n(HT20)	
	802.11 n(HT40)	
U-NII-3	802.11 a	
	802.11 n(HT20)	
	802.11 n(HT40)	
Please see the next plots.		

802.11 n(HT40) 5190MHz U-NII-1

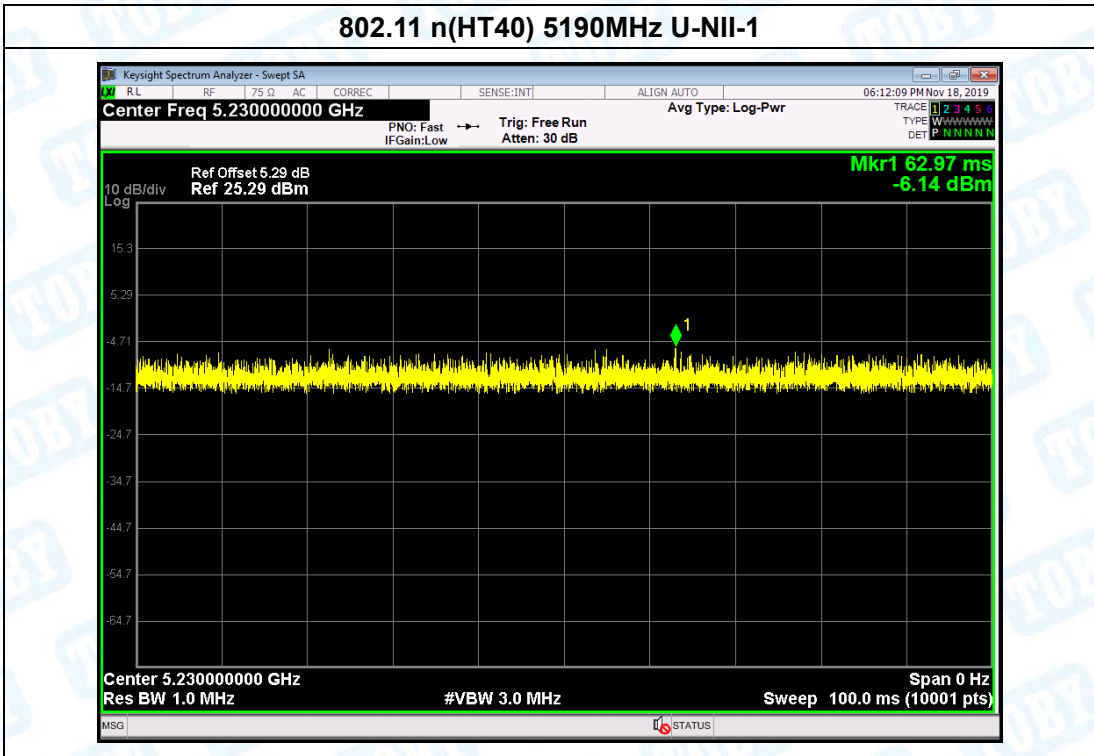

802.11 a 5785MHz U-NII-3

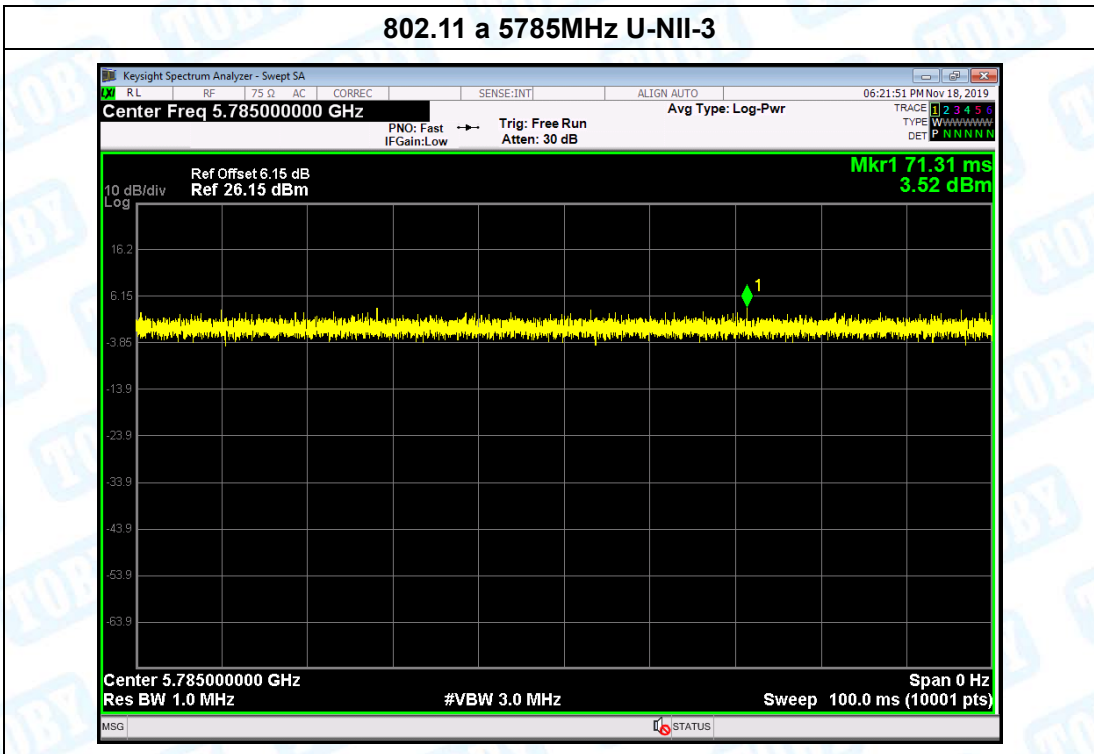

802.11 n(HT20) 5785MHz U-NII-3

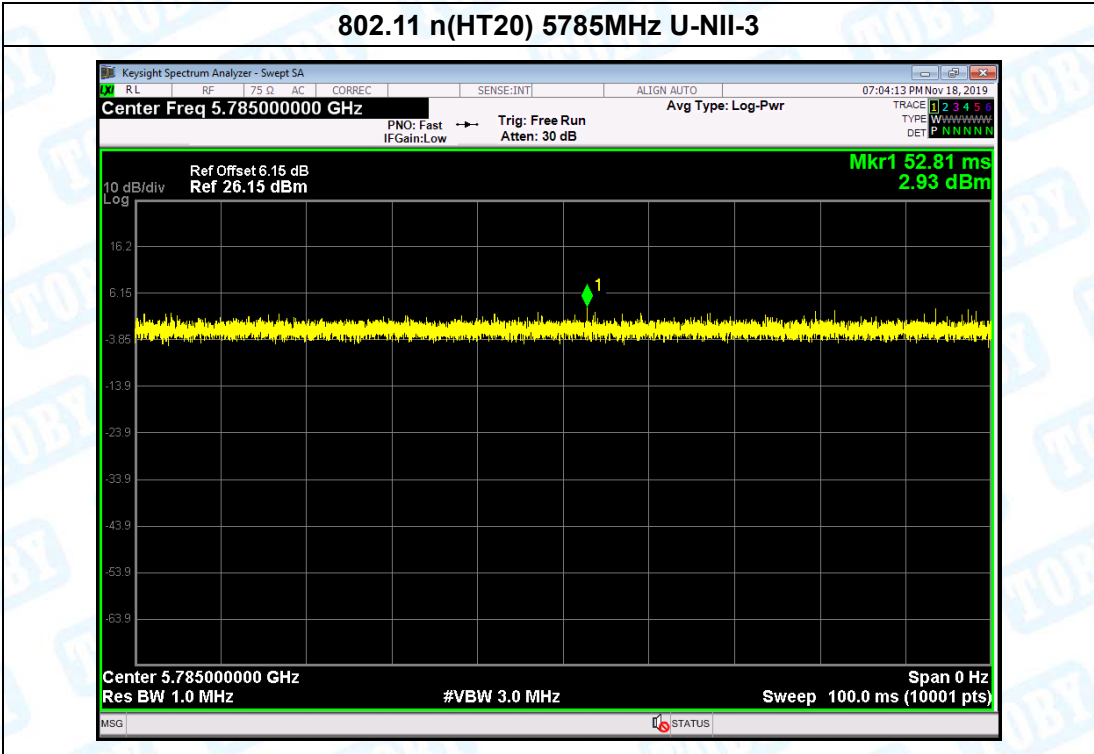

802.11 n(HT40) 5755MHz U-NII-3

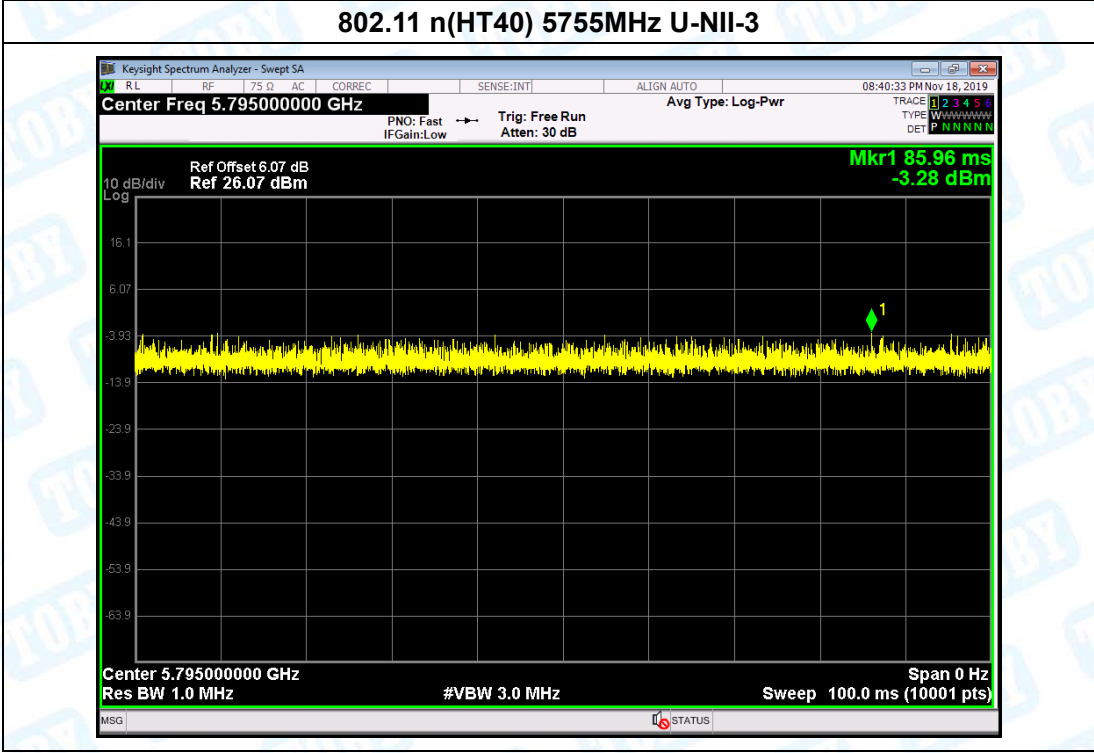

Attachment F-- Power Spectral Density Test Data

Temperature:	25 °C	Relative Humidity:	55%
Test Voltage:	AC 120V/60Hz		
U-NII-1			
Test Mode	Frequency (MHz)	Test Data	
		Power Density (dBm/MHz)	
802.11a	5180	2.331	
	5200	2.626	
	5240	1.951	
802.11n (HT20)	5180	2.707	
	5200	1.590	
	5240	2.168	
802.11n (HT40)	5190	-2.110	
	5230	-4.348	
Limit (dBm/MHz)			
11			
Result: PASS			
Test plots please refer to below pages:			

Antenna A

802.11 a 5180 MHz

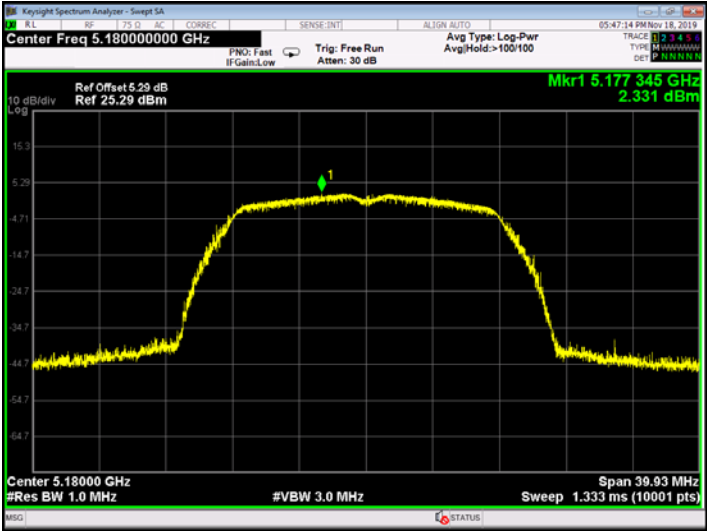

802.11 a 5200 MHz

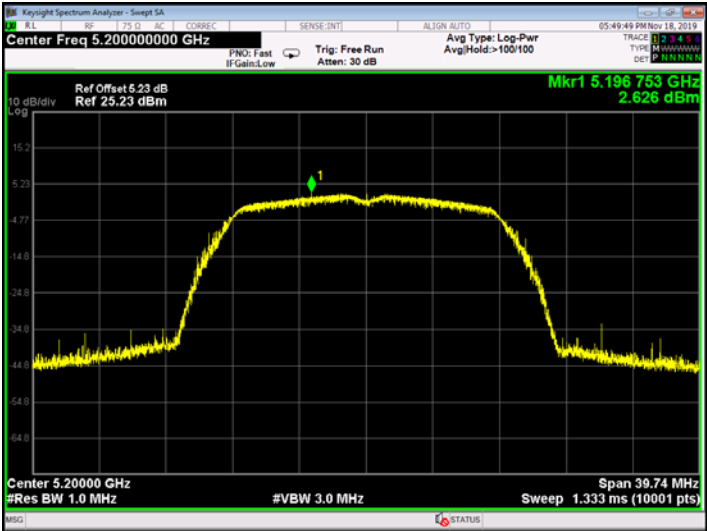

802.11 a 5240 MHz

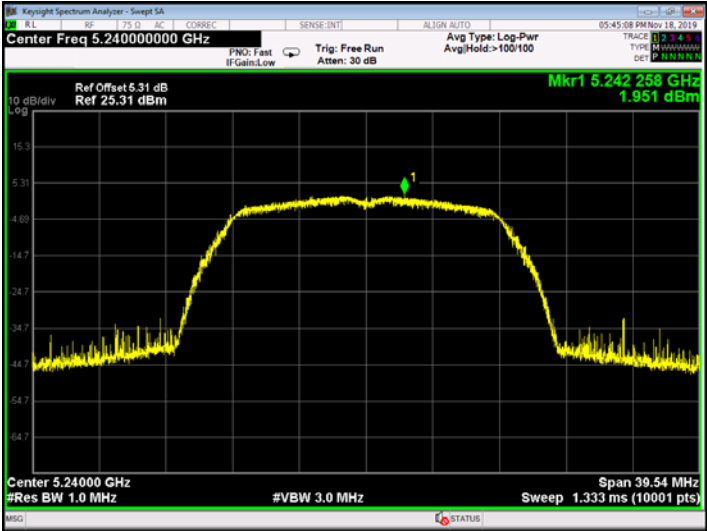

Antenna A

802.11 n(HT20) 5180 MHz

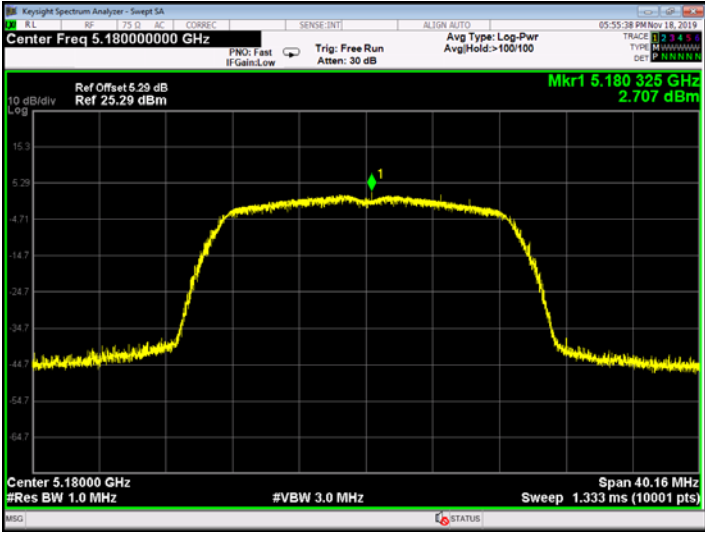

802.11 n(HT20) 5200 MHz

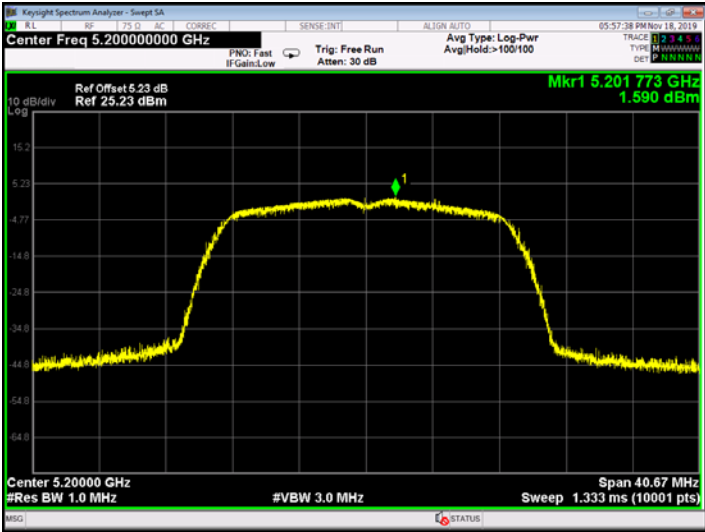

802.11 n(HT20) 5240 MHz

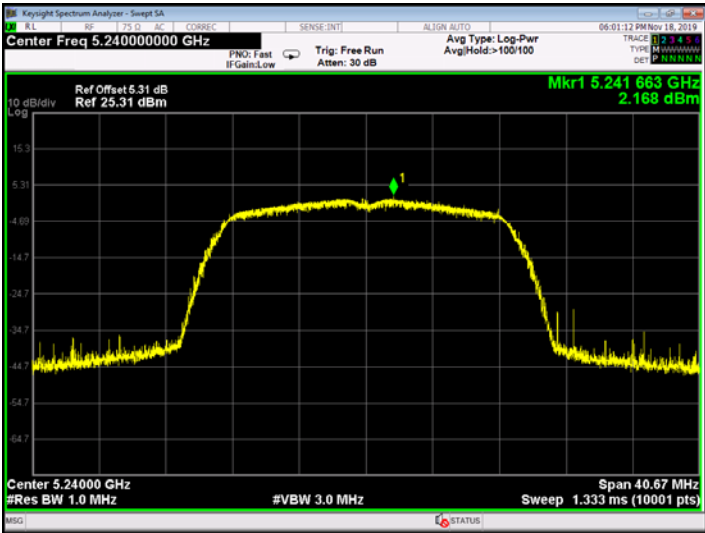

Antenna A

802.11 n(HT40) 5190 MHz

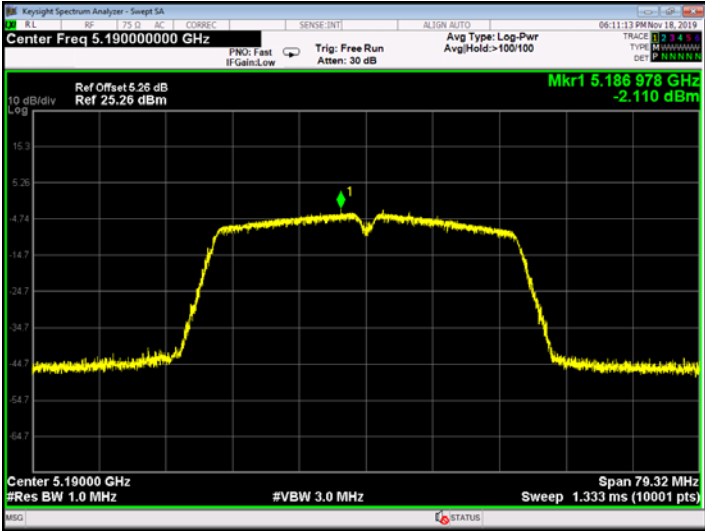

802.11 n(HT40) 5230 MHz

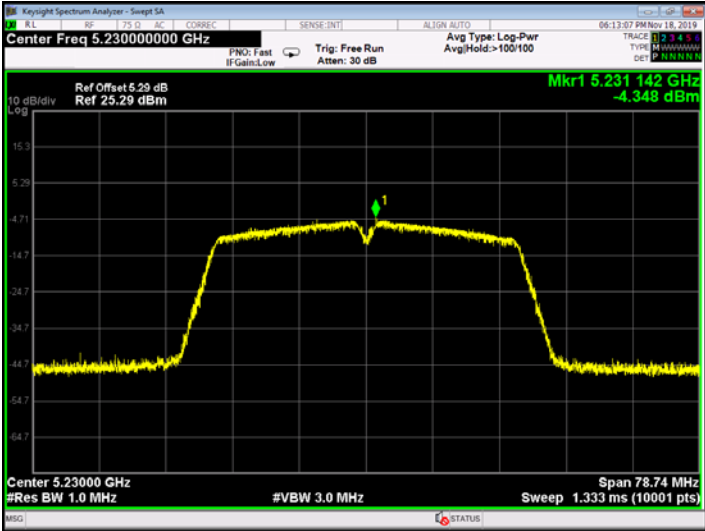

Temperature:	25 °C	Relative Humidity:	55%
Test Voltage:	AC 120V/60Hz		
U-NII-3			
Test Mode	Frequency (MHz)	Test Data	
		Power Density (dBm/500kHz)	
802.11a	5745	-0.648	
	5785	-0.201	
	5825	-1.374	
802.11n (HT20)	5745	-2.189	
	5785	-2.735	
	5825	-2.540	
802.11n (HT40)	5755	-6.106	
	5795	-4.903	
Limit (dBm/500kHz)			
30			
Result: PASS			
Test plots please refer to below pages:			

Antenna A

802.11 a 5745 MHz

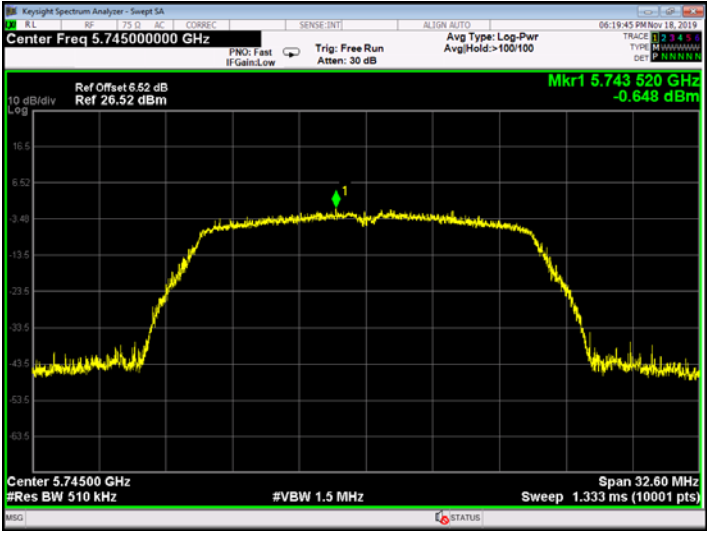

802.11 a 5785 MHz

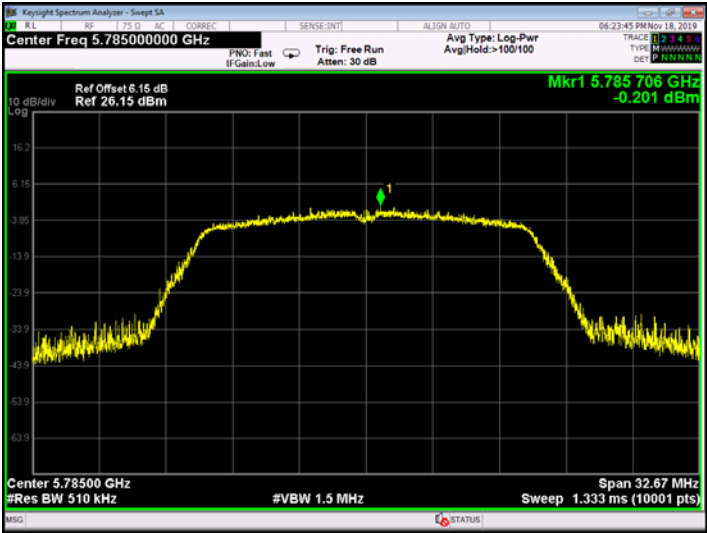

802.11 a 5825 MHz

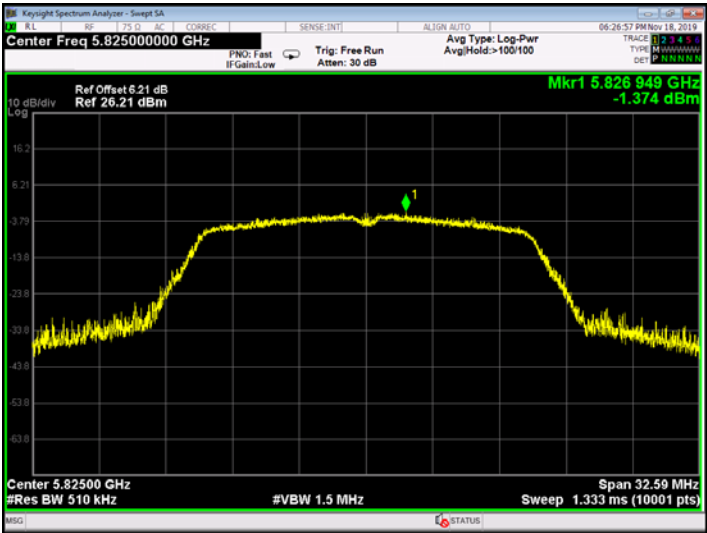

Antenna A

802.11 n(HT20) 5745 MHz

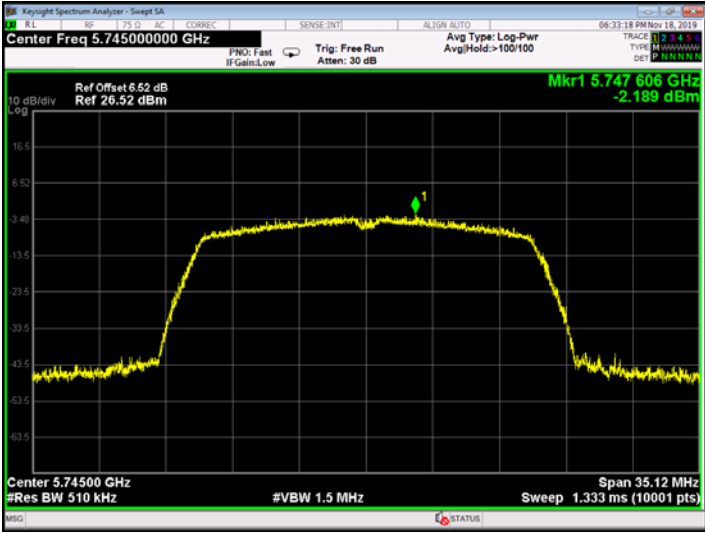

802.11 n(HT20) 5785 MHz

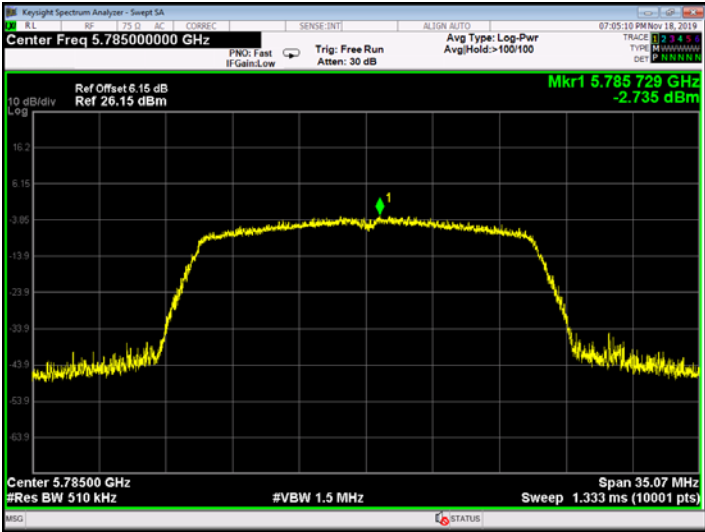

802.11 n(HT20) 5825 MHz

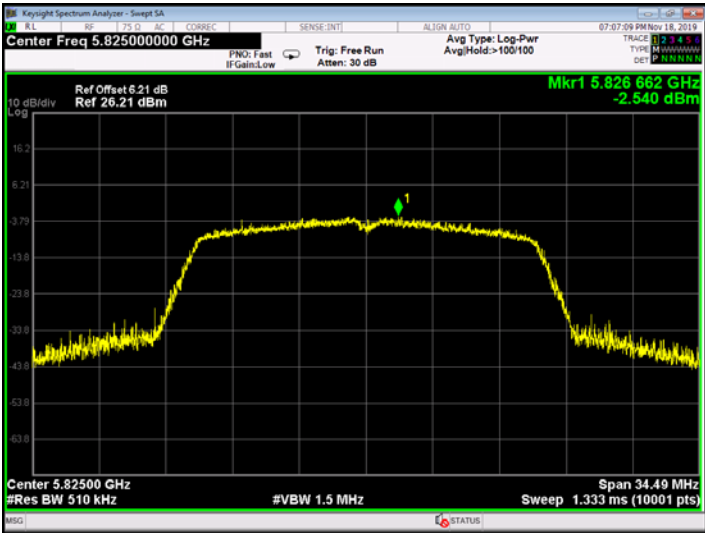

Antenna A

802.11 n(HT40) 5755 MHz

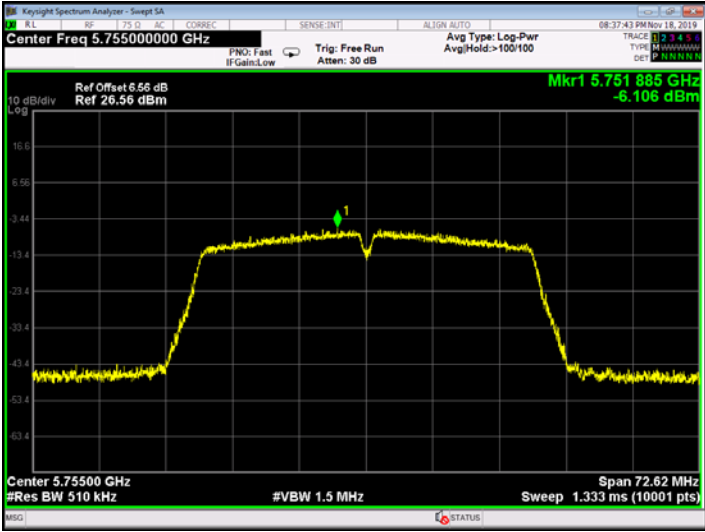

802.11 n(HT40) 5795 MHz

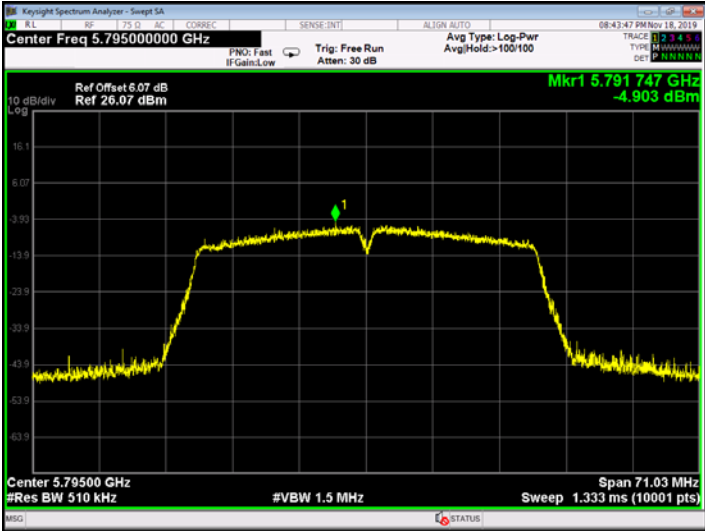

Attachment G----Frequency Stability Measurement Data

Only show the worst case 802.11 a Mode 5180MHz.

801.11a U-NII-1: 5180 MHz	
Voltage vs. Frequency Stability	
Voltage (V)	Measurement Frequency (MHz)
132	5179.9643
120	5180.0000
118	5179.9582
Max. Deviation (MHz)	0.0413
Max. Deviation (ppm)	8.02
Temperature vs. Frequency Stability	
Temperature (°C)	Measurement Frequency (MHz)
0	5179.9752
10	5179.9742
20	5179.9724
30	5179.9762
40	5179.9734
50	5179.9784
Max. Deviation (MHz)	0.0272
Max. Deviation (ppm)	5.32
Limit (ppm)	20
Result	Pass

Only show the worst case 802.11 a Mode 5745MHz.

801.11a U-NII-3: 5745 MHz	
Voltage vs. Frequency Stability	
Voltage (V)	Measurement Frequency (MHz)
132	5744.9657
120	5745.0000
118	5744.9524
Max. Deviation (MHz)	0.0475
Max. Deviation (ppm)	8.35
Temperature vs. Frequency Stability	
Temperature (°C)	Measurement Frequency (MHz)
0	5744.9633
10	5744.9725
20	5744.9565
30	5744.9654
40	5744.9514
50	5744.9765
Max. Deviation (MHz)	0.0481
Max. Deviation (ppm)	8.45
Limit (ppm)	20
Result	Pass

-----END OF REPORT-----