



RADIO TEST REPORT

Report No: STS1909168W01

Issued for

Telo Systems Ltd.

Room 408, Chuangye Building, Seven-Star Park, Chuangye
 2nd Road, Bao'an 28th District, Xin'an Bao'an District
 Shenzhen, China

Product Name:	Smart Phone
Brand Name:	Telo Systems
Model Name:	TE610
Series Model:	N/A
FCC ID:	2ANY6-TE610
Test Standard:	FCC Part 22H and 24E

Any reproduction of this document must be done in full. No single part of this document may be reproduced without permission from STS, All Test Data Presented in this report is only applicable to presented Test sample.





TEST RESULT CERTIFICATION

Applicant's Name: Telo Systems Ltd.
Address.....: Room 408,Chuangye Building,Seven-Star Park,Chuangye 2nd Road,Bao'an 28th District,Xin'anBao'an District Shenzhen, China
Manufacture's Name: Telo Systems Ltd.
Address.....: Room 408,Chuangye Building,Seven-Star Park,Chuangye 2nd Road,Bao'an 28th District,Xin'anBao'an District Shenzhen,China

Product Description

Product Name: Smart Phone
Brand Name.....: Telo Systems
Model Name.....: TE610
SeriesModel.....: N/A
Test Standards.....: FCC Part 22H and 24E
Test Procedure.....: KDB 971168 D01 v03r01,ANSI C63.26(2015)

This device described above has been tested by STS, the test results show that the equipment under test (EUT) is in compliance with the FCC requirements. And it is applicable only to the tested sample identified in the report.
This report shall not be reproduced except in full, without the written approval of STS, this document may be altered or revised by STS, personal only, and shall be noted in the revision of the document..

Date of Test.....:
Date (s) of performance of tests : 12 Sept. 2019 ~ 30 Sept. 2019
Date of Issue: 08 Oct. 2019
Test Result: Pass

Testing Engineer : [Signature]
(ChrisChen)

Technical Manager : [Signature]
(Sunday Hu)

Authorized Signatory : [Signature]
(Vita Li)





Table of Contents	Page
1 INTRODUCTION	6
1.1 TEST FACTORY	6
1.2 MEASUREMENT UNCERTAINTY	6
2 PRODUCT INFORMATION	7
3 TEST CONFIGURATION OF EQUIPMENT UNDER TEST	9
4 MEASUREMENT INSTRUMENTS	10
5 TEST ITEMS	11
5.1 CONDUCTED OUTPUT POWER	11
5.2 PEAK TO AVERAGE RATIO	12
5.3 TRANSMITTER RADIATED POWER (EIRP/ERP)	13
5.4 OCCUPIED BANDWIDTH	14
5.5 FREQUENCY STABILITY	15
5.6 SPURIOUS EMISSIONS AT ANTENNA TERMINALS	16
5.7 BAND EDGE	17
5.8 FIELD STRENGTH OF SPURIOUS RADIATION MEASUREMENT	18
APPENDIX A. TEST RESULT	20
A1. CONDUCTED OUTPUT POWER	20
A2. PEAK-TO-AVERAGE RADIO	24
A3. TRANSMITTER RADIATED POWER (EIRP/ERP)	33
A4. OCCUPIED BANDWIDTH(99% OCCUPIED BANDWIDTH/26DB BANDWIDTH)	35
A5. FREQUENCY STABILITY	44
A6. SPURIOUS EMISSIONS AT ANTENNA TERMINALS	48
A7. BAND EDGE	56
A8. FIELD STRENGTH OF SPURIOUS RADIATION MEASUREMENT	60
APPENDIX-PHOTOS OF TEST SETUP	68



Revision History

Rev.	Issue Date	Report NO.	Effect Page	Contents
00	08 Oct. 2019	STS1909168W01	ALL	Initial Issue





SUMMARY OF TEST RESULTS

Test procedures according to the technical standards:

The radiated emission testing was performed according to the procedures of KDB 971168 D01 v03r01 and ANSI C63.26(2015)

FCC Rules	Test Description	Test Limit	Test Result	Reference
2.1046	Conducted Output Power	Reporting Only	PASS	
22.913d 24.232d	Peak-to-Average Ratio	< 13 dB	PASS	
2.1046 22.913 24.232	Effective Radiated Power/Equivalent Isotropic Radiated Power	< 7 Watts max. ERP(Part 22) < 2 Watts max. EIRP(Part 24)	PASS	
2.1049 22.917 24.238	Occupied Bandwidth	Reporting Only	PASS	
2.1055 22.355 24.235	Frequency Stability	< 2.5 ppm (Part 22) Emission must remain in band (Part 24)	PASS	
2.1051 22.917 24.238	Spurious Emission at Antenna Terminals	< 43+10log ₁₀ (P[Watts])	PASS	
2.1053 22.917 24.238	Field Strength of Spurious Radiation	< 43+10log ₁₀ (P[Watts])	PASS	
2.1051 22.917 24.238	Band Edge	< 43+10log ₁₀ (P[Watts])	PASS	



1 INTRODUCTION

1.1 TEST FACTORY

SHENZHEN STS TEST SERVICES CO., LTD

Add. : A 1/F, Building B, Zhuoke Science Park, No.190 Chongqing Road, HepingShequ, Fuyong Sub-District, Bao'an District, Shenzhen, Guang Dong, China

FCC test Firm Registration Number: 625569

IC test Firm Registration Number: 12108A

A2LA Certificate No.: 4338.01

1.2 MEASUREMENT UNCERTAINTY

The measurement uncertainties shown below were calculated in accordance with the requirements of ANSI C63.4-2014. All measurement uncertainty values are shown with a coverage factor of $k = 2$ to indicate a 95% level of confidence. The measurement data shown herein meets or exceeds the CISPR measurement uncertainty values specified in CISPR 16-4-2 and, thus, can be compared directly to specified limits to determine compliance.

No.	Item	Uncertainty
1	RF output power, conducted	± 0.71 dB
2	Unwanted Emissions, conducted	± 0.63 dB
3	All emissions, radiated 30-200 MHz	± 3.43 dB
4	All emissions, radiated 200 MHz-1 GHz	± 3.57 dB
5	All emissions, radiated > 1 GHz	± 4.13 dB
6	Conducted Emission (9 kHz-150 kHz)	± 3.18 dB
7	Conducted Emission (150 kHz-30 MHz)	± 2.70 dB



2 PRODUCT INFORMATION

ProductName	Smart Phone
Trade Name	Telo Systems
Model Name	TE610
Series Model	N/A
Model Difference	N/A
Tx Frequency:	GSM/GPRS/EDGE: 850: 824 MHz ~ 849MHz 1900: 1850 MHz ~ 1910MHz WCDMA: Band V: 824 MHz ~ 849 MHz Band II: 1850 MHz ~ 1910 MHz
Rx Frequency:	GSM/GPRS/EDGE: 850: 869 MHz ~ 894 MHz 1900: 1930 MHz ~ 1990MHz WCDMA: Band V: 869 MHz ~ 894 MHz Band II: 1930 MHz ~ 1990 MHz
Max RF Output Power:	GSM850(1-Slot):32.66dBm, GSM1900(1-Slot):29.39dBm GPRS850(1-Slot):29.13dBm, GPRS1900(1-Slot):25.89dBm GPRS850(2-Slot):28.73dBm, GPRS1900(2-Slot):25.39dBm GPRS850(3-Slot):28.32dBm, GPRS1900(3-Slot):24.93dBm GPRS850(4-Slot):27.84dBm, GPRS1900(4-Slot):24.50dBm EDGE 850(1-Slot):27.35dBm, EDGE 1900(1-Slot):25.17dBm EDGE 850(2-Slot):26.58dBm, EDGE 1900(2-Slot):24.41dBm EDGE 850(3-Slot):25.87dBm, EDGE 1900(3-Slot):23.63dBm EDGE 850(4-Slot):25.43dBm, EDGE 1900(4-Slot):22.88dBm WCDMA Band V:23.21dBm, WCDMA Band II:22.78dBm
Type of Emission:	GSM(850): 318KGXW; GSM(1900): 321KGXW GPRS(850): 320KGXW; GPRS(1900): 317KGXW EDGE(850): 314KG7W; EDGE(1900): 320KG7W WCDMA850: 4M70F9W WCDMA1900: 4M70F9W
Modulation Characteristics:	GMSK for GSM/GPRS; GMSK and 8PSK for EDGE WCDMA: QPSK; HSDPA:QPSK/16QAM; HSUPA:BPSK
SIM Card:	SIM 1 and SIM 2 is a chipset unit and tested as single chipset, SIM 1 is used to tested
Antenna:	PIFA Antenna
Antenna gain:	GSM 850: -0.5dBi ,PCS 1900:-0.2dBiWCDMA 850: -0.5dBi, WCDMA1900: -0.2dBi,
Battery parameter:	Rated Voltage: 3.8V Charge Limit: 4.35V Capacity: 5200mAh



Adapter:	Input: AC 100~240V, 300mA, 50/60Hz Output: DC 5V, 2000mA
GPRS/EDGE Class:	Multi-Class12
Extreme Vol. Limits:	DC 3.6V~ DC 4.4V(Normal: DC 3.8V)
Extreme Temp. Tolerance:	-30°C to +50°C
Hardware version number:	LM182_V1.0
Software version number:	TE610_US_V1_20190802
<i>** Note: The High Voltage 4.35V and Low Voltage 3.5V was declared by manufacturer, The EUT couldn't be operate normally with higher or lower voltage.</i>	





3 TEST CONFIGURATION OF EQUIPMENT UNDER TEST

Antenna port conducted and radiated test items were performed according to KDB 971168 D01 and ANSI C63.262015 PowerMeas. License Digital Systems with maximum output power.

Radiated measurements were performed with rotating EUT in different three orthogonal test planes to find the maximum emission.

Radiated emissions were investigated as following frequency range:

1. 30 MHz to 10th harmonic for GSM850 and WCDMA Band V.
2. 30 MHz to 10th harmonic for GSM1900 and WCDMA Band II.

All modes and data rates and positions were investigated.

Test modes are chosen to be reported as the worst case configuration below:

BAND	TEST MODES	
	RADIATED TCS	CONDUCTED TCS
GSM 850	GSM LINK GPRS/EDGE CLASS 12 LINK	GSM LINK GPRS/EDGE CLASS 12 LINK
GSM 1900	GSM LINK GPRS/EDGE CLASS 12 LINK	GSM LINK GPRS/EDGE CLASS 12 LINK
WCDMA BAND V	RMC 12.2KBPS LINK	RMC 12.2KBPS LINK
WCDMA BAND II	RMC 12.2KBPS LINK	RMC 12.2KBPS LINK



4 MEASUREMENT INSTRUMENTS

Radiation Test equipment

Kind of Equipment	Manufacturer	Type No.	Serial No.	Last calibration	Calibrated until
Test Receiver	R&S	ESCI	101427	2018.10.13	2019.10.12
Signal Analyzer	Agilent	N9020A	MY51110105	2019.03.02	2020.03.01
Wireless Communications Test Set	R&S	CMW 500	133884	2019.03.02	2020.03.01
Bilog Antenna	TESEQ	CBL6111D	34678	2017.11.02	2020.11.1
Horn Antenna	SCHWARZBECK	BBHA 9120D(1201)	9120D-1343	2018.10.19	2021.10.18
SHF-EHF Horn Antenna (18G-40GHz)	A-INFO	LB-180400-KF	J211020657	2018.03.11	2021.03.10
Pre-Amplifier (0.1M-3GHz)	EM	EM330	060665	2018.10.13	2019.10.12
Pre-Amplifier (1G-18GHz)	SKET	LNPA-01018G-45	SK2018080901	2018.10.13	2019.10.12
turn table	EM	SC100_1	60531	N/A	N/A
Antenna mast	EM	SC100	N/A	N/A	N/A
Temperature & Humidity	HH660	Mieo	N/A	2018.10.11	2019.10.10
Test SW	BULUN	BL410-E/18.905			

RF Connected Test

Kind of Equipment	Manufacturer	Type No.	Serial No.	Last calibration	Calibrated until
Universal Radio communication tester	R&S	CMU200	11764	2018.10.13	2019.10.12
Wireless Communications Test Set	R&S	CMW 500	133884	2019.03.02	2020.03.01
Signal Analyzer	Agilent	N9020A	MY49100060	2018.10.13	2019.10.12
Temperature & Humidity	HH660	Mieo	N/A	2018.10.11	2019.10.10
Temperature & Humidity test chamber	Safety test	AG80L	171200018	2019.03.02	2020.03.01
Test SW	FARAD	LZ-RF /LzRf-3A3			

Equipment with a calibration date of "NCR" shown in this list was not used to make direct calibrated measurements.



5 TEST ITEMS

5.1 CONDUCTED OUTPUT POWER

Test overview

A system simulator was used to establish communication with the EUT. Its parameters were set to enforce EUT transmitting at the maximum power. The measured power in the radio frequency on the transmitter output terminals shall be reported.

Test procedures

1. The transmitter output port was connected to the system simulator.
2. Set eut at maximum power through the system simulator.
3. Select lowest, middle, and highest channels for each band and different modulation.
4. Measure and record the power level from the system simulator.

Test setup





5.2 PEAK TO AVERAGE RATIO

TEST OVERVIEW

According to §24.232(d), power measurements for transmissions by stations authorized under this section may be made either in accordance with a commission-approved average power technique or in compliance with paragraph (e) of this section. In both instances, equipment employed must be authorized in accordance with the provisions of §24.51. In measuring transmissions in this band using an average power technique, the peak-to-average ratio (PAR) of the transmission may not exceed 13 db.

TEST PROCEDURES

1. The testing follows fcckdb 971168 v03r01 section
2. The eut was connected to the and peak and av system simulator& spectrum analysis reads
3. Select lowest, middle, and highest channels for each band and different modulation.
4. Set the test probe and measure average power of the spectrum analysis

TEST SETUP

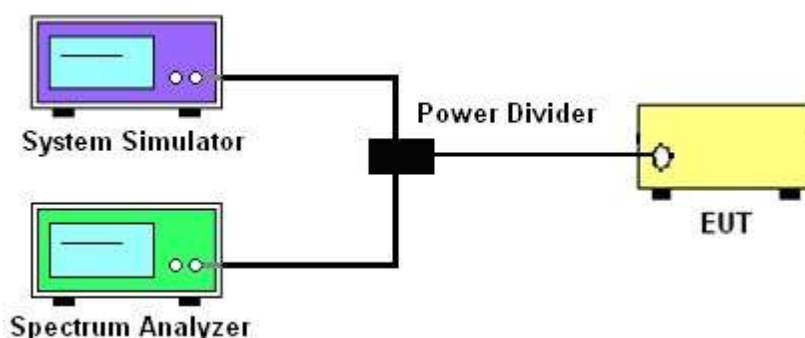



5.3 TRANSMITTER RADIATED POWER (EIRP/ERP)

TEST OVERVIEW

Effective Radiated Power (ERP) and Equivalent Isotropic Radiated Power (EIRP) measurements are performed using the substitution method described in ANSI C63.26 2015 with the EUT transmitting into an integral antenna. Measurements on signals operating below 1GHz are performed using vertically polarized tuned dipole antennas. Measurements on signals operating above 1GHz are performed using vertically polarized broadband horn antennas. All measurements are performed as RMS average measurements while the EUT is operating at maximum power, and at the appropriate frequencies.

TEST PROCEDURE

1. The testing follows FCC KDB 971168 Section 5.8 and ANSI C63.26-2015 Section 5.2.
2. The transmitter was placed on a wooden turntable, and it was transmitting into a non-radiating load which was also placed on the turntable.
3. The measurement antenna was placed at a distance of 3 meters from the EUT. During the tests, the antenna height and polarization as well as EUT azimuth were varied in order to identify the maximum level of emissions from the EUT. The test was performed by placing the EUT on 3-orthogonal axis.
4. The frequency range up to tenth harmonic of the fundamental frequency was investigated.
5. Remove the EUT and replace it with substitution antenna. A signal generator was connected to the substitution antenna by a nonradiating cable. The absolute levels of the spurious emissions were measured by the substitution.
6. Effective Isotropic Radiated Power (EIRP) was measured by substitution method according to ANSI C63.26-2015. The EUT was replaced by the substitution antenna at same location, and then a known power from S.G. was applied into the dipole antenna through a Tx cable, and then recorded the maximum Analyzer reading through raised and lowered the test antenna. The correction factor (in dB) = S.G. - Tx Cable loss + Substitution antenna gain - Analyzer reading. Then the EUT's EIRP/ERP was calculated with the correction factor,
$$\text{ERP/EIRP} = \text{P.SG} + \text{GT} - \text{LC}$$

ERP/EIRP = effective or equivalent radiated power, respectively (expressed in the same units as P_{Meas} as, typically dBW or dBm);
P_{Meas}(PK) = measured transmitter output power or PSD, in dBm or dBW;
GT = gain of the transmitting antenna, in dBd (ERP) or dBi (EIRP);
LC = signal attenuation in the connecting cable between the transmitter and antenna, in dB.



5.4 OCCUPIED BANDWIDTH

TEST OVERVIEW

The occupied bandwidth, that is the frequency bandwidth such that, below its lower and above its upper frequency limits, the mean powers radiated are each equal to 0.5 percent of the total mean power radiated by a given emission shall be measured.

The 26 dB emission bandwidth is defined as the frequency range between two points, one above and one below the carrier frequency, at which the spectral density of the emission is attenuated 26 dB below the maximum in-band spectral density of the modulated signal. Spectral density (power per unit bandwidth) is to be measured with a detector of resolution bandwidth equal to approximately 1.0% of the emission bandwidth.

All modes of operation were investigated and the worst case configuration results are reported in this section.

TEST PROCEDURE

1. The signal analyzer's automatic bandwidth measurement capability was used to perform the 99% occupied bandwidth and the 26dB bandwidth. The bandwidth measurement was not influenced by any intermediate power nulls in the fundamental emission.
2. $RBW = 1 - 5\%$ of the expected OBW
3. $VBW \geq 3 \times RBW$
4. Detector = Peak
5. Trace mode = max hold
6. Sweep = auto couple
7. The trace was allowed to stabilize
8. If necessary, steps 2 – 7 were repeated after changing the RBW such that it would be within 1 – 5% of the 99% occupied bandwidth observed in Step 7

TEST SETUP

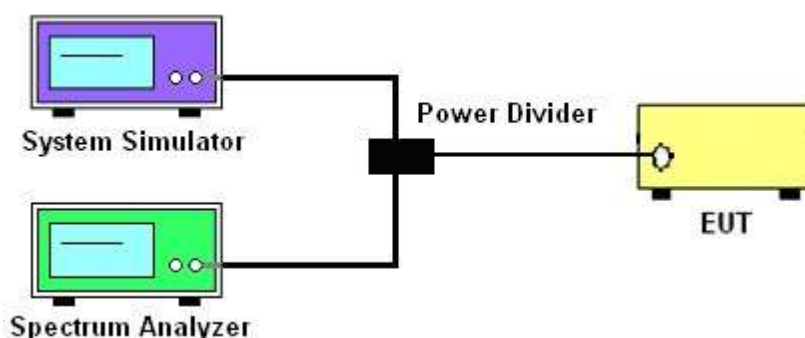

5.5 FREQUENCY STABILITY

Test Overview

Frequency stability testing is performed in accordance with the guidelines of ANSI C63.26 2015. The frequency stability of the transmitter is measured by:

- a.) Temperature: The temperature is varied from -30°C to $+50^{\circ}\text{C}$ in 10°C increments using an environmental chamber.
- b.) Primary Supply Voltage: The primary supply voltage is varied from 85% to 115% of the nominal value for non hand-carried battery and AC powered equipment. For hand-carried, battery-powered equipment, primary supply voltage is reduced to the battery operating end point which shall be specified by the manufacturer.

For Part 22, the frequency stability of the transmitter shall be maintained within $\pm 0.00025\%$ (± 2.5 ppm) of the center frequency. For Part 24 the frequency stability shall be sufficient to ensure that the fundamental emission stays within the authorized frequency block.

Test Procedure

Temperature Variation

1. The testing follows fccdb 971168 D01 section 9.0
2. The EUT was set up in the thermal chamber and connected with the system simulator.
3. With power OFF, the temperature was decreased to -30°C and the EUT was stabilized before testing. Power was applied and the maximum change in frequency was recorded within one minute.
4. With power OFF, the temperature was raised in 10°C steps up to 50°C . The EUT was stabilized at each step for at least half an hour. Power was applied and the maximum frequency change was recorded within one minute.

Voltage Variation

1. The testing follows FCC KDB 971168 D01 Section 9.0.
2. The EUT was placed in a temperature chamber at $25 \pm 5^{\circ}\text{C}$ and connected with the system simulator.
3. The power supply voltage to the EUT was varied from 85% to 115% of the nominal value measured at the input to the EUT.
4. The variation in frequency was measured for the worst case.

TEST SETUP

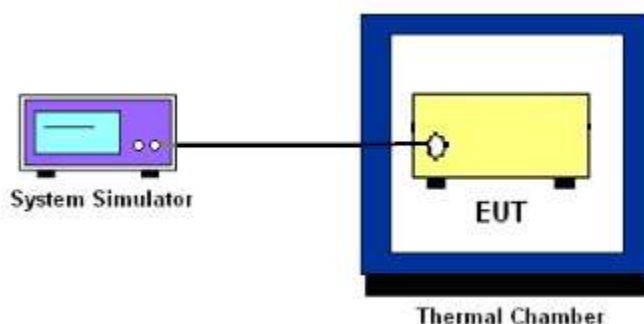

5.6 SPURIOUS EMISSIONS AT ANTENNA TERMINALS

Test Overview

The power of any emission outside of the authorized operating frequency ranges must be lower than the transmitter power (P) by a factor of at least $43 + 10 \log (P)$ dB.

It is measured by means of a calibrated spectrum analyzer and scanned from 30 MHz up to a frequency including its 10th harmonic.

Test procedure

1. The testing FCC KDB 971168 D01 v03r01 Section 6.0. and ANSI C63.26-2015-Section 5.5
2. The EUT was connected to the spectrum analyzer and system simulator via a power divider.
3. The RF output of EUT was connected to the spectrum analyzer by an RF cable and attenuator. The path loss was compensated to the results for each measurement.
4. The middle channel for the highest RF power within the transmitting frequency was measured.
5. The conducted spurious emission for the whole frequency range was taken.
6. The RF fundamental frequency should be excluded against the limit line in the operating frequency band.

7. The limit line is derived from $43 + 10 \log (P)$ dB below the transmitter power P(Watts)

$$= P(W) - [43 + 10 \log (P)] \text{ (dB)}$$

$$= [30 + 10 \log (P)] \text{ (dBm)} - [43 + 10 \log (P)] \text{ (dB)}$$

$$= -13 \text{ dBm.}$$

Test Setup

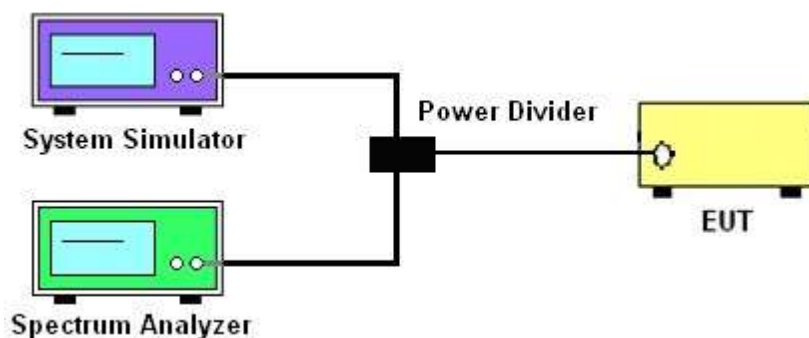

5.7 BAND EDGE

OVERVIEW

All out of band emissions are measured with a spectrum analyzer connected to the antenna terminal of the EUT while the EUT is operating at maximum power, and at the appropriate frequencies. All data rates were investigated to determine the worst case configuration. All modes of operation were investigated and the worst case configuration results are reported in this section.

The minimum permissible attenuation level of any spurious emission is $43 + \log_{10}(P[\text{Watts}])$, where P is the transmitter power in Watts.

TEST PROCEDURE

1. The testing FCC KDB 971168 D01 v03r01 Section 6.0. and ANSI C63.26-2015-Section 5.7
2. Start and stop frequency were set such that the band edge would be placed in the center of the Plot.
3. The EUT was connected to the spectrum analyzer and system simulator via a power divider.
4. The RF output of EUT was connected to the spectrum analyzer by an RF cable and attenuator. The path loss was compensated to the results for each measurement.

5. The band edges of low and high channels for the highest RF powers were measured.

6. The RF fundamental frequency should be excluded against the limit line in the operating frequency band.

7. The limit line is derived from $43 + 10\log(P)$ dB below the transmitter power P(Watts)

$$= P(\text{W}) - [43 + 10\log(P)] (\text{dB})$$

$$= [30 + 10\log(P)] (\text{dBm}) - [43 + 10\log(P)] (\text{dB})$$

$$= -13\text{dBm}.$$

TEST SETUP

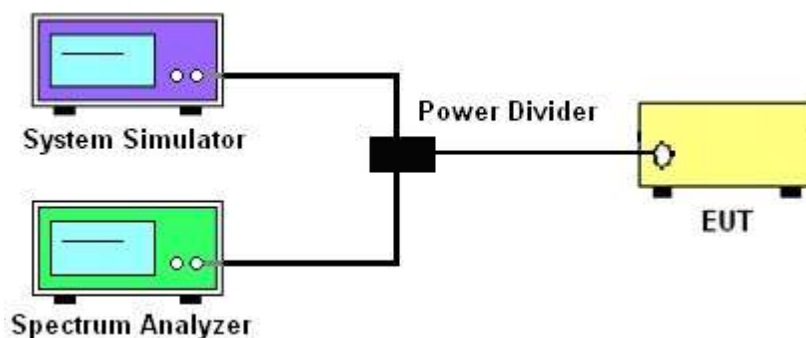



5.8 FIELD STRENGTH OF SPURIOUS RADIATION MEASUREMENT

Test overview

Radiated spurious emissions measurements are performed using the substitution method described in ANSI C63.26-2015 with the EUT transmitting into an integral antenna. Measurements on signals operating below 1GHz are performed using horizontally and vertically polarized tuned dipole antennas. Measurements on signals operating above 1GHz are performed using vertically and horizontally polarized horn antennas. All measurements are performed as peak measurements while the EUT is operating at maximum power and at the appropriate frequencies.

It is measured by means of a calibrated spectrum analyzer and scanned from 30 MHz up to a frequency including its 10th harmonic.

Test procedure

1. The testing FCC KDB 971168 D01 Section 5.8 and ANSI C63.26-2015-Section 5.5.
2. RBW = 100kHz for emissions below 1GHz and 1MHz for emissions above 1GHz
3. VBW $\geq 3 \times$ RBW
4. Span = 1.5 times the OBW
5. No. of sweep points $> 2 \times$ span/RBW
6. Detector = Peak
7. Trace mode = max hold
8. The trace was allowed to stabilize
9. Effective Isotropic Spurious Radiation was measured by substitution method according to TIA/EIA-603-D. The EUT was replaced by the substitution antenna at same location, and then a known power from S.G. was applied into the dipole antenna through a Tx cable, and then recorded the maximum Analyzer reading through raised and lowered the test antenna. The correction factor (in dB) = S.G. - Tx Cable loss + Substitution antenna gain - Analyzer reading. Then the EUT's EIRP/ERP was calculated with the correction factor,
$$\text{ERP/EIRP} = \text{P.SG} + \text{GT} - \text{LC}$$

ERP/EIRP = effective or equivalent radiated power, respectively (expressed in the same units as P_{Meas}, typically dBW or dBm);
P.SG = measured transmitter output power or PSD, in dBm or dBW;
GT = gain of the transmitting antenna, in dBd (ERP) or dBi (EIRP);
LC = signal attenuation in the connecting cable between the transmitter and antenna, in dB.

TEST SETUP

For radiated test from 30MHz to 1GHz

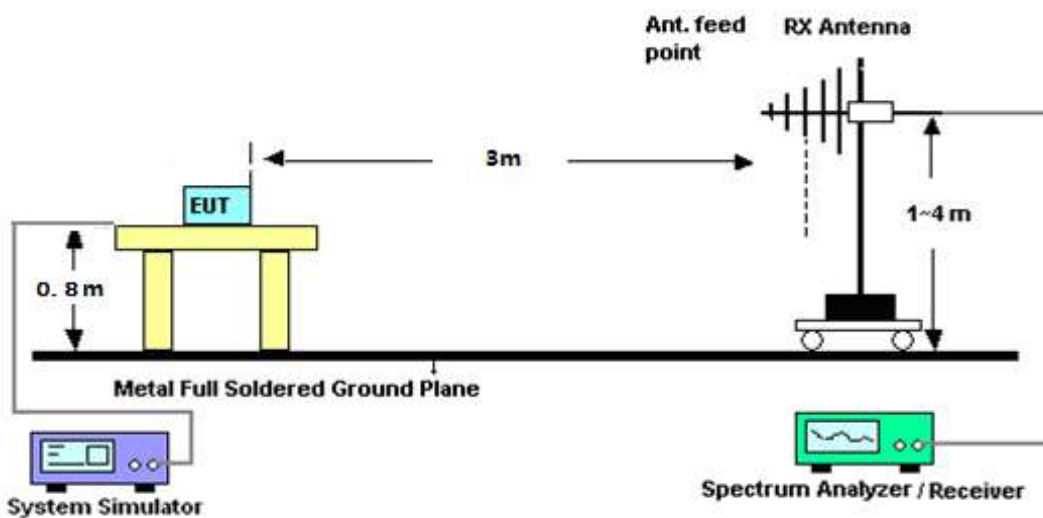

For radiated test from above 1GHz

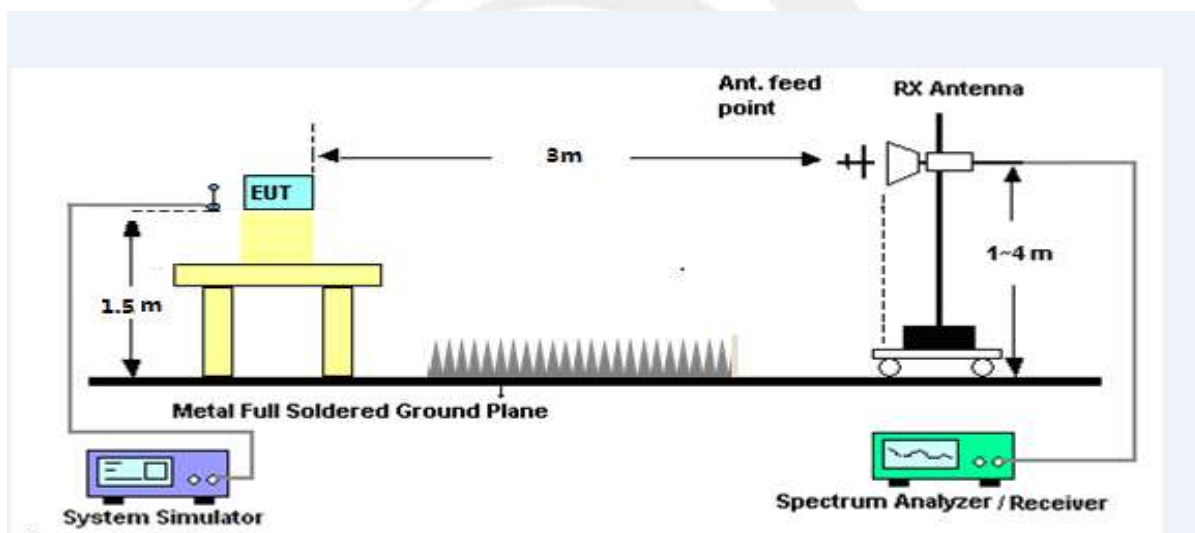

APPENDIX A.TESTRESULT
A1.CONDUCTED OUTPUT POWER

GSM 850:

GSM 850		
Mode	Frequency (MHz)	AVG Power(dBm)
GSM (GMSK,1-Slot)	824.2	32.42
	836.6	32.66
	848.8	32.59
GPRS (GMSK,1-Slot)	824.2	28.89
	836.6	29.13
	848.8	29.05
GPRS (GMSK,2-Slot)	824.2	28.45
	836.6	28.73
	848.8	28.57
GPRS (GMSK,3-Slot)	824.2	27.97
	836.6	28.32
	848.8	28.15
GPRS (GMSK,4-Slot)	824.2	27.54
	836.6	27.84
	848.8	27.70
EGPRS (8PSK,1-Slot)	824.2	27.22
	836.6	27.35
	848.8	27.33
EGPRS (8PSK,2-Slot)	824.2	26.47
	836.6	26.58
	848.8	26.54
EGPRS (8PSK,3-Slot)	824.2	25.71
	836.6	25.87
	848.8	25.74
EGPRS (8PSK,4-Slot)	824.2	24.92
	836.6	25.08
	848.8	25.43



PCS 1900:

PCS 1900		
Mode	Frequency (MHz)	AVG Power(dBm)
GSM (GMSK,1-Slot)	1850.2	29.00
	1880.0	29.13
	1909.8	29.39
GPRS (GMSK,1-Slot)	1850.2	25.53
	1880.0	25.66
	1909.8	25.89
GPRS (GMSK,2-Slot)	1850.2	25.08
	1880.0	25.18
	1909.8	25.39
GPRS (GMSK,3-Slot)	1850.2	24.63
	1880.0	24.69
	1909.8	24.93
GPRS (GMSK,4-Slot)	1850.2	24.14
	1880.0	24.23
	1909.8	24.50
EGPRS (8PSK,1-Slot)	1850.2	25.17
	1880.0	25.01
	1909.8	24.83
EGPRS (8PSK,2-Slot)	1850.2	24.41
	1880.0	24.25
	1909.8	24.10
EGPRS (8PSK,3-Slot)	1850.2	23.63
	1880.0	23.49
	1909.8	23.36
EGPRS (8PSK,4-Slot)	1850.2	22.88
	1880.0	22.76
	1909.8	22.60



UMTS BAND V

UMTS BAND V		
Mode	Frequency(MHz)	AVG Power
WCDMA 850 RMC	826.4	23.09
	836.6	23.16
	846.6	23.21
HSDPA Subtest 1	826.4	22.12
	836.6	22.21
	846.6	22.25
HSDPA Subtest 2	826.4	21.66
	836.6	21.74
	846.6	21.78
HSDPA Subtest 3	826.4	21.28
	836.6	21.25
	846.6	21.29
HSDPA Subtest 4	826.4	20.89
	836.6	20.90
	846.6	20.83
HSUPA Subtest 1	826.4	22.11
	836.6	22.16
	846.6	21.77
HSUPA Subtest 2	826.4	21.26
	836.6	21.19
	846.6	20.82
HSUPA Subtest 3	826.4	21.12
	836.6	20.74
	846.6	20.40
HSUPA Subtest 4	826.4	20.69
	836.6	20.44
	846.6	19.97
HSUPA Subtest 5	826.4	19.19
	836.6	19.00
	846.6	18.53



UMTS BAND II

UMTS BAND II		
Mode	Frequency(MHz)	AVG Power
WCDMA 1900 RMC	1852.4	22.30
	1880	22.52
	1907.6	22.78
HSDPA Subtest 1	1852.4	21.40
	1880	21.63
	1907.6	21.82
HSDPA Subtest 2	1852.4	20.97
	1880	21.13
	1907.6	21.38
HSDPA Subtest 3	1852.4	20.62
	1880	20.67
	1907.6	20.94
HSDPA Subtest 4	1852.4	20.31
	1880	20.24
	1907.6	20.50
HSUPA Subtest 1	1852.4	21.33
	1880	21.62
	1907.6	21.38
HSUPA Subtest 2	1852.4	20.43
	1880	20.66
	1907.6	20.44
HSUPA Subtest 3	1852.4	20.41
	1880	20.22
	1907.6	20.05
HSUPA Subtest 4	1852.4	19.99
	1880	19.92
	1907.6	19.67
HSUPA Subtest 5	1852.4	18.56
	1880	18.44
	1907.6	18.21



A2. PEAK-TO-AVERAGE RADIO

GSM 850		
Mode	Frequency (MHz)	PAR
GSM 850	824.2	0.09
	836.6	0.08
	848.8	0.09
GPRS 850	824.2	0.09
	836.6	0.09
	848.8	0.10
EGPRS 850	824.2	2.85
	836.6	2.94
	848.8	3.04

PCS 1900		
Mode	Frequency (MHz)	PAR
PCS1900	1850.2	0.11
	1880	0.12
	1909.8	0.13
GPRS1900	1850.2	0.12
	1880	0.11
	1909.8	0.12
EGPRS1900	1850.2	2.72
	1880	2.70
	1909.8	2.97

UMTS Band II		
Mode	Frequency (MHz)	PAR
WCDMA 1900 RMC	1852.4	3.39
	1880	2.77
	1907.6	2.86
HSDPA 1900	1852.4	6.83
	1880	5.25
	1907.6	5.06
HSUPA 1900	1852.4	7.11
	1880	4.43
	1907.6	4.62

UMTS Band V		
Mode	Frequency (MHz)	PAR
WCDMA 850 RMC	826.4	3.23
	836.6	3.26
	846.6	3.37
HSDPA 850	826.4	4.81
	836.6	6.49
	846.6	6.28
HSUPA 850	826.4	4.56
	836.6	6.71
	846.6	6.86

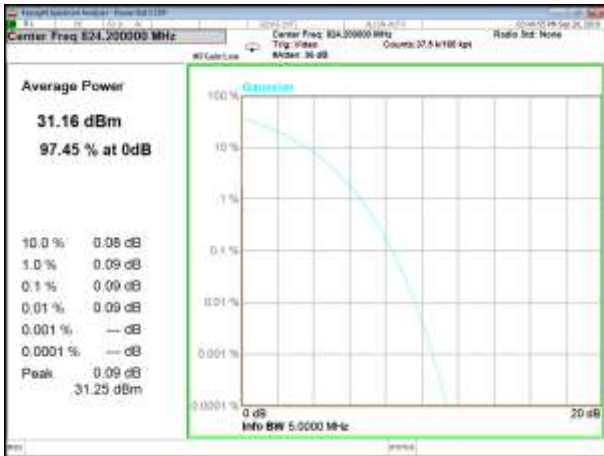

GSM850_QPSK_Lower

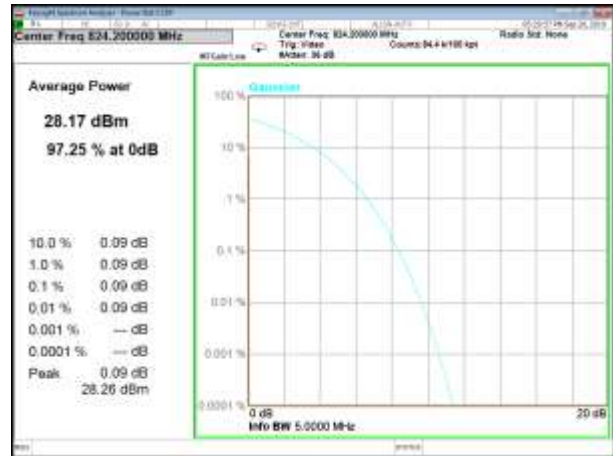

GPRS850_QPSK_Lower

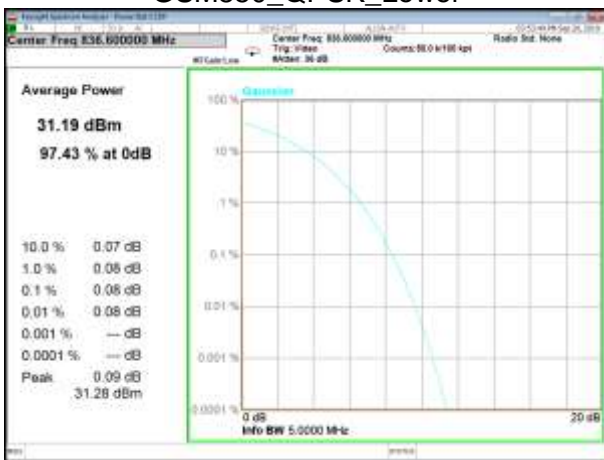

GSM850_QPSK_Middle

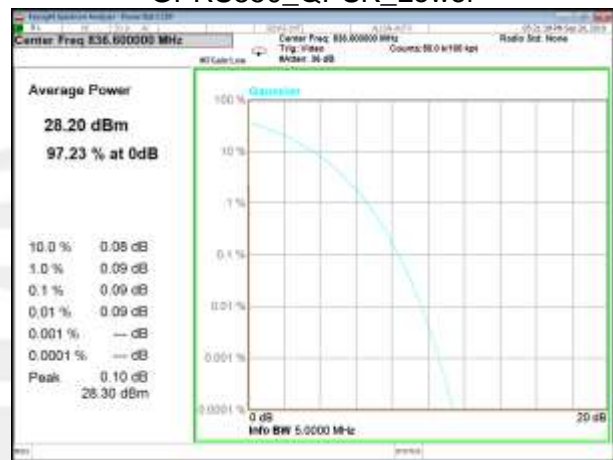

GPRS850_QPSK_Middle

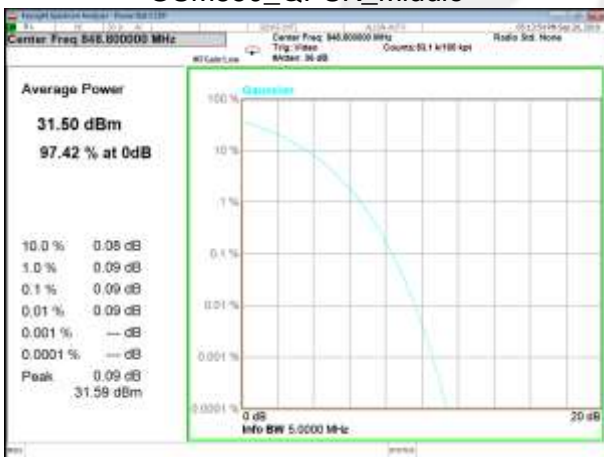

GSM850_QPSK_Higher

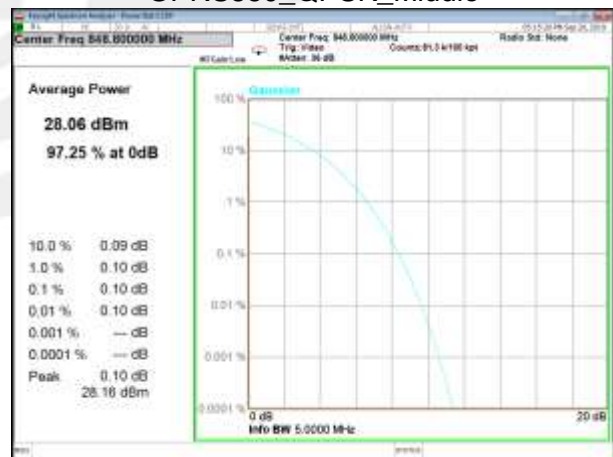

GPRS850_QPSK_Higher

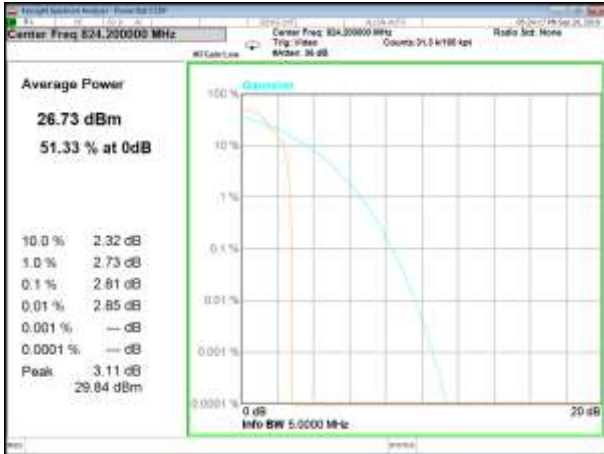

EGPRS850_QPSK_Lower

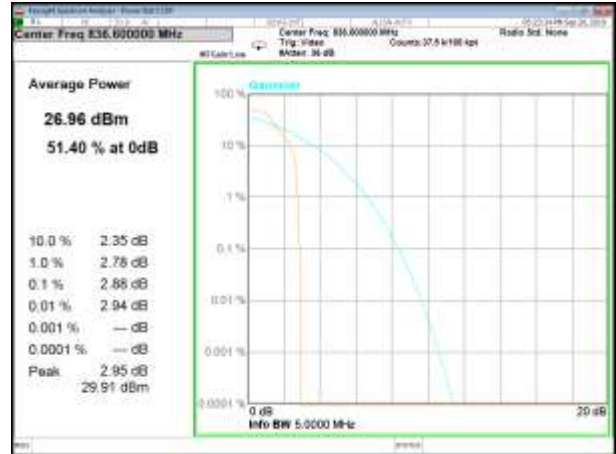

EGPRS850_QPSK_Middle

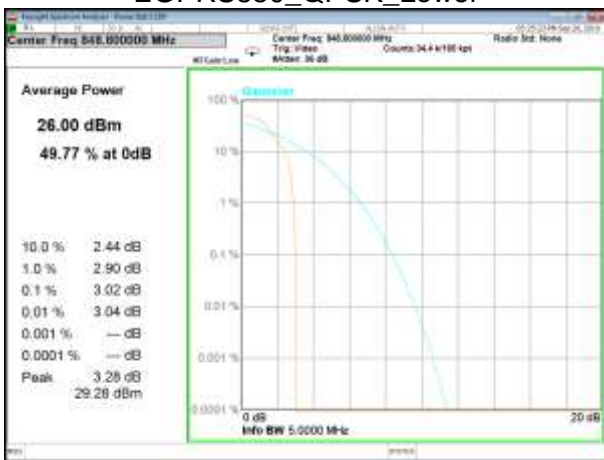

EGPRS850_QPSK_Higher

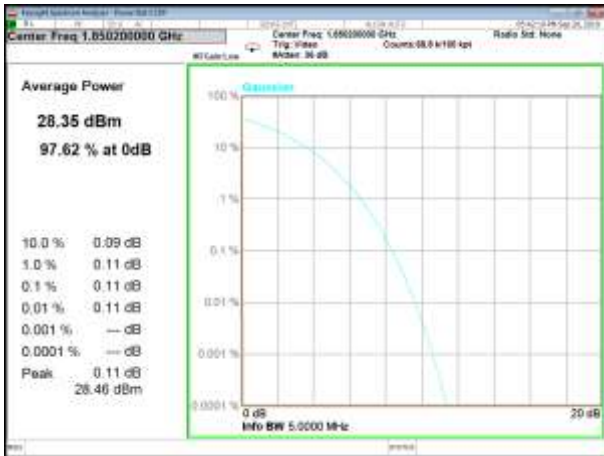

GSM1900_QPSK_Lower_

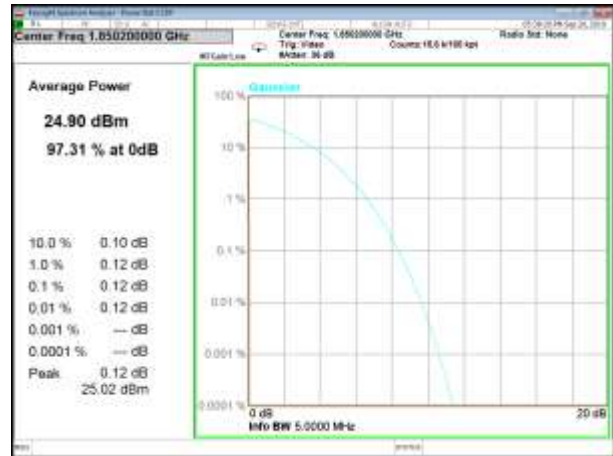

GPRS1900_QPSK_Lower_



GSM1900_QPSK_Middle_



GPRS1900_QPSK_Middle_

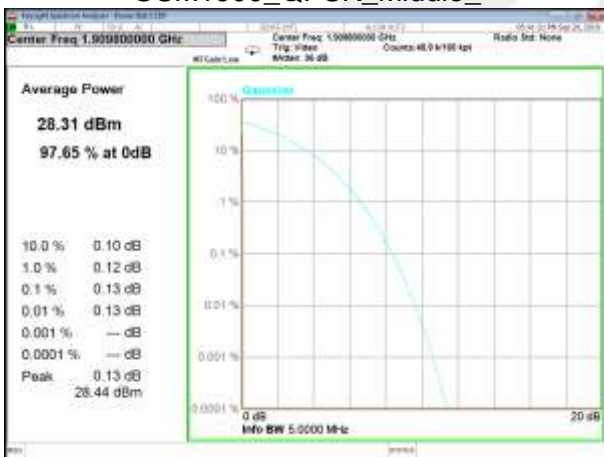

GSM1900_QPSK_Higher_



GPRS1900_QPSK_Higher_

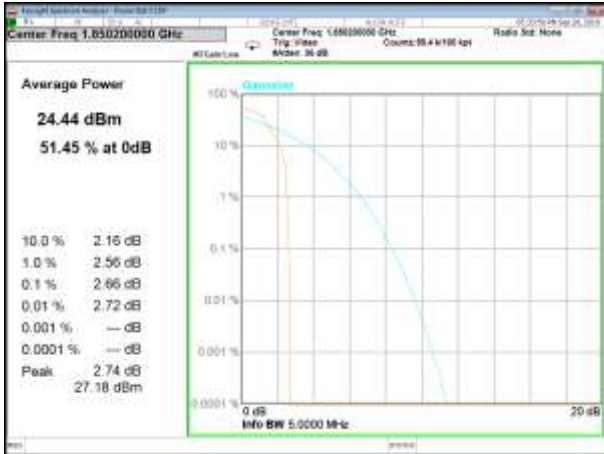

EGPRS1900_QPSK_Lower_

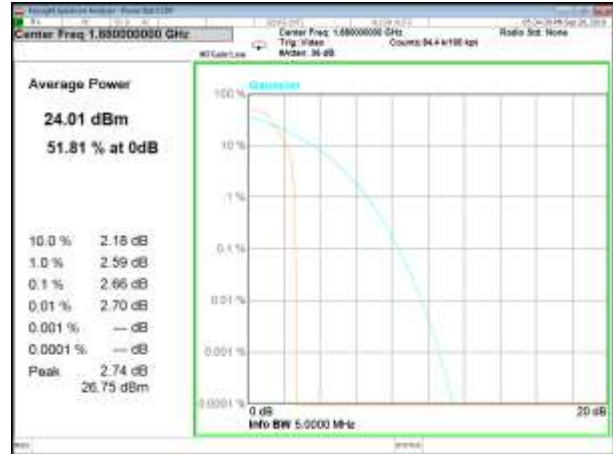

EGPRS1900_QPSK_Middle_

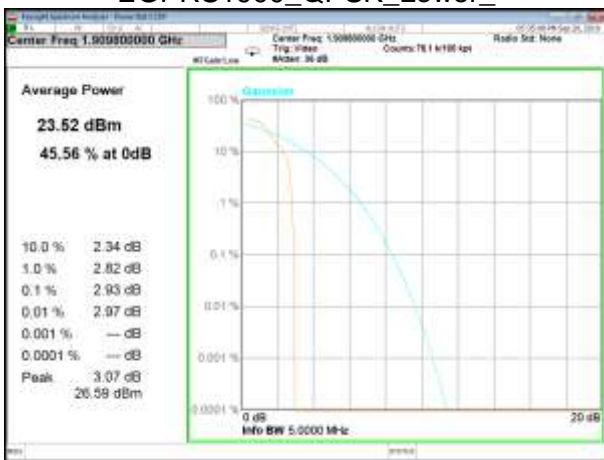

EGPRS1900_QPSK_Higher_

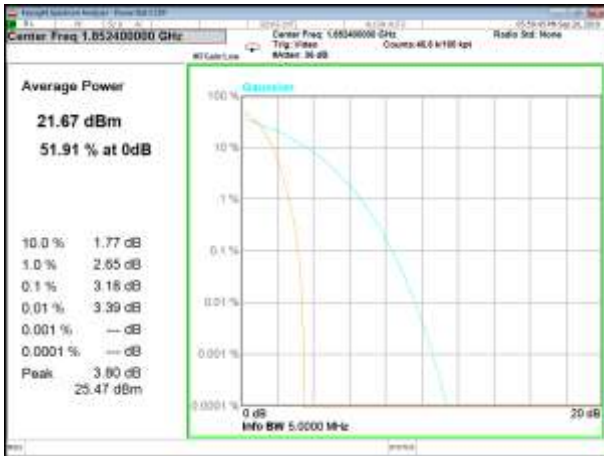

WCDMA2_QPSK_Lower

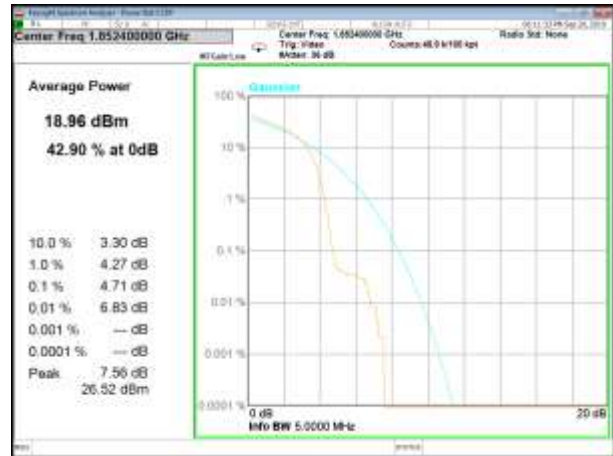

HSDPA2_QPSK_Lower

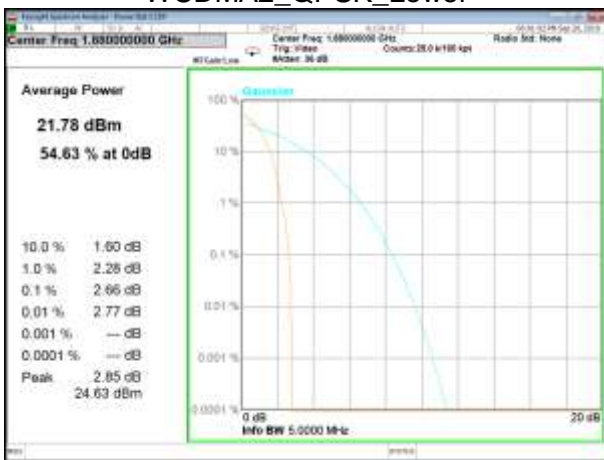

WCDMA2_QPSK_Middle

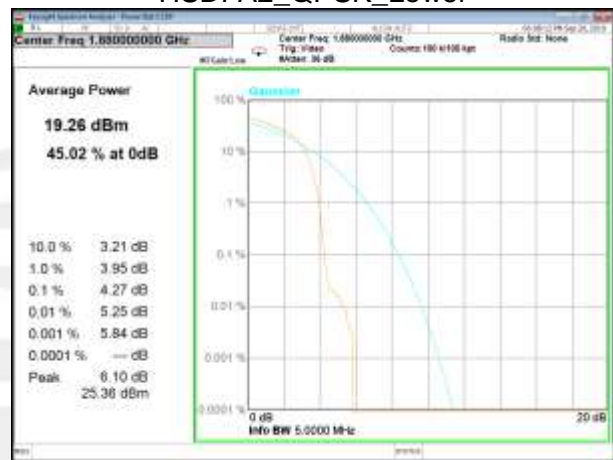

HSDPA2_QPSK_Middle

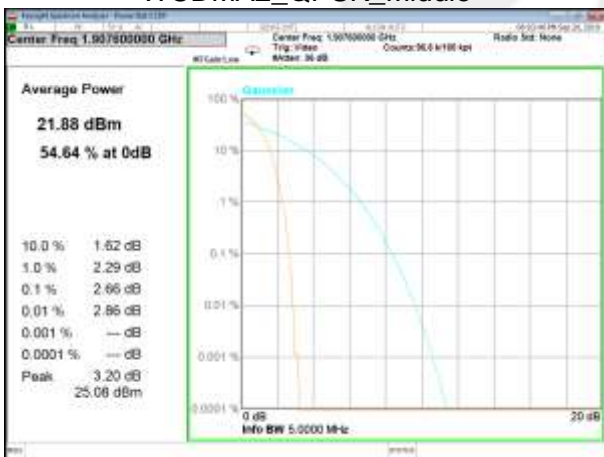

WCDMA2_QPSK_Higher

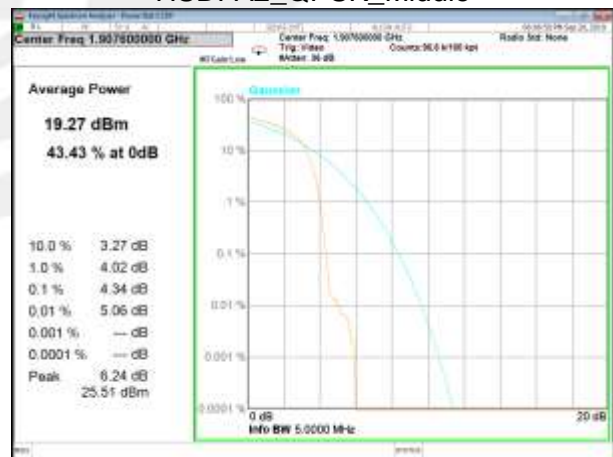

HSDPA2_QPSK_Higher

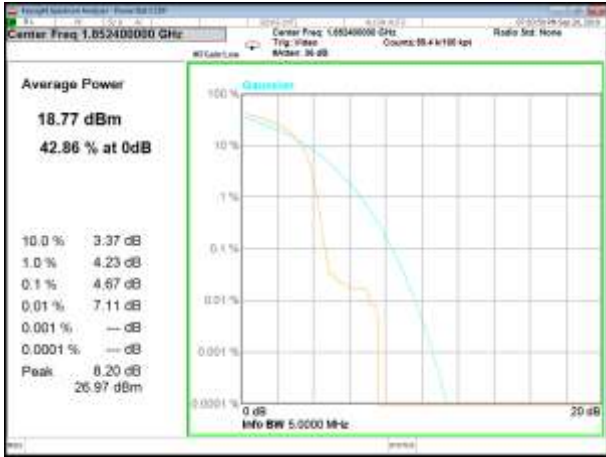

HSUPA2_QPSK_Lower

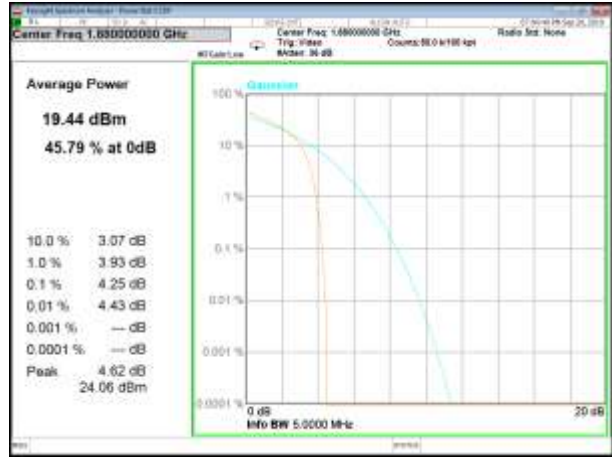

HSUPA2_QPSK_Middle

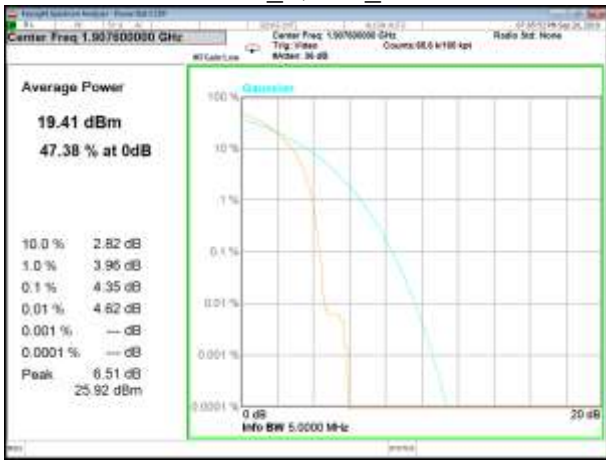

HSUPA2_QPSK_Higher

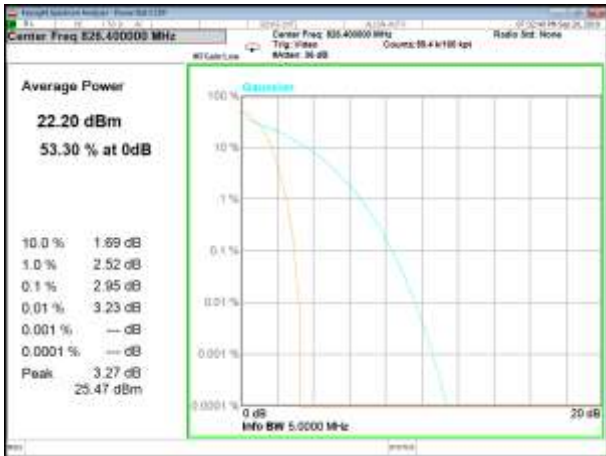

WCDMA5_QPSK_Lower_

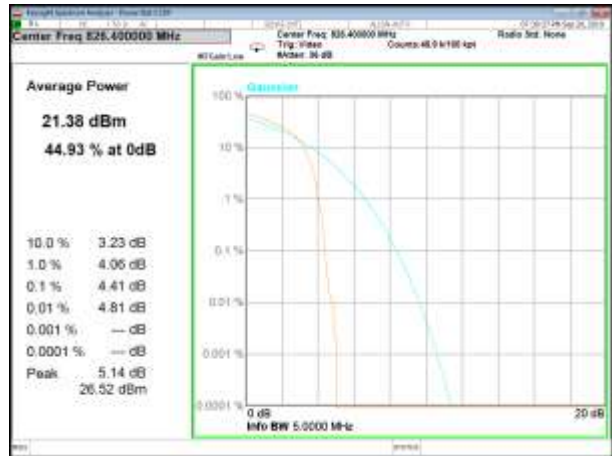

HSDPA5_QPSK_Lower_

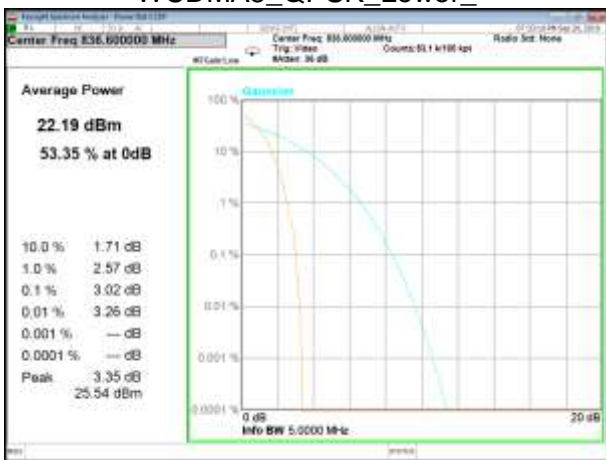

WCDMA5_QPSK_Middle_

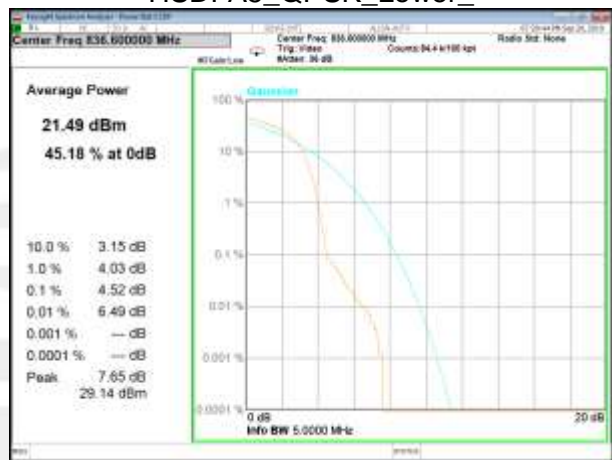

HSDPA5_QPSK_Middle_



WCDMA5_QPSK_Higher_

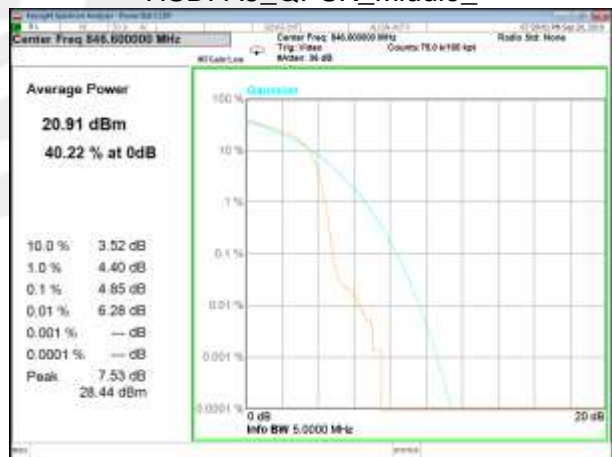

HSDPA5_QPSK_Higher_

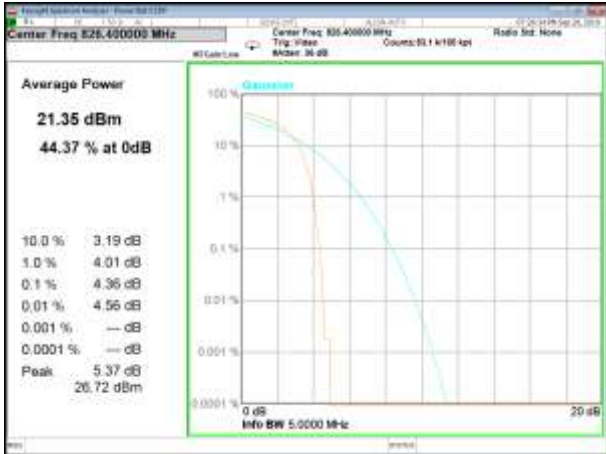

HSUPA5_QPSK_Lower_

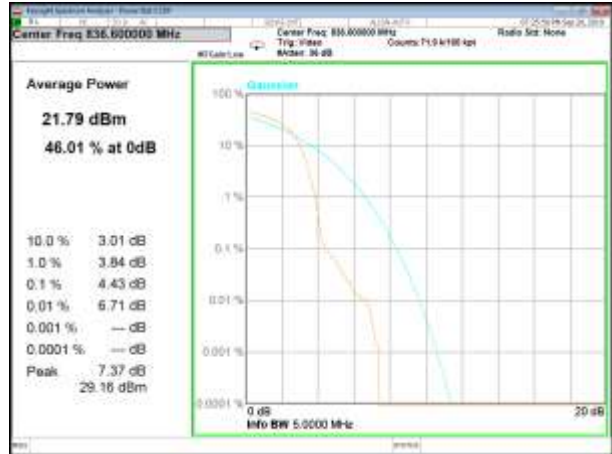

HSUPA5_QPSK_Middle_

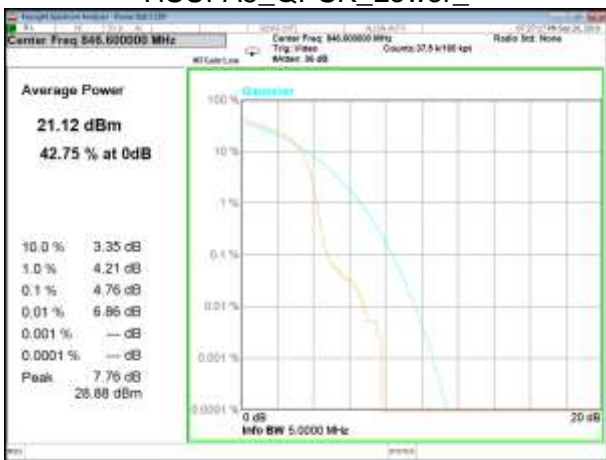

HSUPA5_QPSK_Higher_



A3. TRANSMITTER RADIATED POWER (EIRP/ERP)

Note: Test is divided into three directions, X/Y/Z. X pattern for the worst

Radiated Power (ERP) for GSM 850 MHZ							
Mode	Frequency	Result					Conclusion
		S G.Level (dBm)	Cable loss	Gain(dBi)	PMeas E.R.P(dBm)	Polarization Of Max. ERP	
GSM850	824.2	23.66	0.44	6.5	29.72	Horizontal	Pass
	824.2	25.59	0.44	6.5	31.65	Vertical	Pass
	836.6	24.03	0.45	6.5	30.08	Horizontal	Pass
	836.6	25.92	0.45	6.5	31.97	Vertical	Pass
	848.8	24.05	0.46	6.5	30.09	Horizontal	Pass
	848.8	25.80	0.46	6.5	31.84	Vertical	Pass
GPRS850	824.2	19.70	0.44	6.5	25.76	Horizontal	Pass
	824.2	22.10	0.44	6.5	28.16	Vertical	Pass
	836.6	20.41	0.45	6.5	26.46	Horizontal	Pass
	836.6	22.50	0.45	6.5	28.55	Vertical	Pass
	848.8	19.82	0.46	6.5	25.86	Horizontal	Pass
	848.8	22.30	0.46	6.5	28.34	Vertical	Pass
EGPRS850	824.2	18.19	0.44	6.5	24.25	Horizontal	Pass
	824.2	20.66	0.44	6.5	26.72	Vertical	Pass
	836.6	18.33	0.45	6.5	24.38	Horizontal	Pass
	836.6	20.51	0.45	6.5	26.56	Vertical	Pass
	848.8	18.48	0.46	6.5	24.52	Horizontal	Pass
	848.8	20.66	0.46	6.5	26.70	Vertical	Pass
Limit	ERP<7W=38.45dBm						

Radiated Power (EIRP) for PCS 1900 MHZ							
Mode	Frequency	Result					Conclusion
		S G.Level (dBm)	Cable loss	Gain (dBi)	PMeas E.I.R.P.(dBm)	Polarization Of Max. ERP	
PCS1900	1850.2	18.41	2.41	10.35	26.35	Horizontal	Pass
	1850.2	20.2	2.41	10.35	28.14	Vertical	Pass
	1880	18.9	2.42	10.35	26.83	Horizontal	Pass
	1880	20.67	2.42	10.35	28.60	Vertical	Pass
	1909.8	19.08	2.43	10.35	27.00	Horizontal	Pass
	1909.8	20.84	2.43	10.35	28.76	Vertical	Pass
GPRS1900	1850.2	14.17	2.41	10.35	22.11	Horizontal	Pass
	1850.2	16.51	2.41	10.35	24.45	Vertical	Pass
	1880	14.39	2.42	10.35	22.32	Horizontal	Pass
	1880	16.74	2.42	10.35	24.67	Vertical	Pass
	1909.8	14.6	2.43	10.35	22.52	Horizontal	Pass
	1909.8	16.84	2.43	10.35	24.76	Vertical	Pass
EGPRS1900	1850.2	14.36	2.41	10.35	22.30	Horizontal	Pass
	1850.2	16.48	2.41	10.35	24.42	Vertical	Pass
	1880	14.06	2.42	10.35	21.99	Horizontal	Pass
	1880	16.34	2.42	10.35	24.27	Vertical	Pass
	1909.8	14.18	2.43	10.35	22.10	Horizontal	Pass
	1909.8	16.35	2.43	10.35	24.27	Vertical	Pass
Limit	EIRP<2W=33dBm						



Radiated Power (EIRP) for WCDMA Band II							
Mode	Frequency	Result					Conclusion
		S G.Level (dBm)	Cable loss	Gain (dBi)	PMeas E.I.R.P.(dBm)	Polarization Of Max. ERP	
WCDMA	1852.4	11.77	2.41	10.35	19.71	Horizontal	Pass
	1852.4	13.73	2.41	10.35	21.67	Vertical	Pass
	1880	12.11	2.42	10.35	20.04	Horizontal	Pass
	1880	14.03	2.42	10.35	21.96	Vertical	Pass
	1907.4	12.35	2.43	10.35	20.27	Horizontal	Pass
	1907.4	14.23	2.43	10.35	22.15	Vertical	Pass
HSUPA	1852.4	10.83	2.41	10.35	18.77	Horizontal	Pass
	1852.4	12.79	2.41	10.35	20.73	Vertical	Pass
	1880	11.31	2.42	10.35	19.24	Horizontal	Pass
	1880	13.11	2.42	10.35	21.04	Vertical	Pass
	1907.4	11.25	2.43	10.35	19.17	Horizontal	Pass
	1907.4	13.03	2.43	10.35	20.95	Vertical	Pass
HSDPA	1852.4	10.95	2.41	10.35	18.89	Horizontal	Pass
	1852.4	12.75	2.41	10.35	20.69	Vertical	Pass
	1880	10.97	2.42	10.35	18.90	Horizontal	Pass
	1880	12.95	2.42	10.35	20.88	Vertical	Pass
	1907.4	11.01	2.43	10.35	18.93	Horizontal	Pass
	1907.4	12.82	2.43	10.35	20.74	Vertical	Pass
Limit	EIRP<2W=33dBm						

Radiated Power (ERP) for WCDMA Band V							
Mode	Frequency	Result					Conclusion
		S G.Level (dBm)	Cable loss	Gain (dBi)	PMeas E.R.P.(dBm)	Polarization Of Max. ERP	
WCDMA	826.4	14.42	0.44	6.5	20.48	Horizontal	Pass
	826.4	16.36	0.44	6.5	22.42	Vertical	Pass
	836.6	14.76	0.45	6.5	20.81	Horizontal	Pass
	836.6	16.50	0.45	6.5	22.55	Vertical	Pass
	846.4	14.73	0.46	6.5	20.77	Horizontal	Pass
	846.4	16.49	0.46	6.5	22.53	Vertical	Pass
HSUPA	826.4	13.67	0.44	6.5	19.73	Horizontal	Pass
	826.4	15.52	0.44	6.5	21.58	Vertical	Pass
	836.6	13.83	0.45	6.5	19.88	Horizontal	Pass
	836.6	15.57	0.45	6.5	21.62	Vertical	Pass
	846.4	13.62	0.46	6.5	19.66	Horizontal	Pass
	846.4	15.56	0.46	6.5	21.60	Vertical	Pass
HSDPA	826.4	13.39	0.44	6.5	19.45	Horizontal	Pass
	826.4	15.29	0.44	6.5	21.35	Vertical	Pass
	836.6	13.43	0.45	6.5	19.48	Horizontal	Pass
	836.6	15.42	0.45	6.5	21.47	Vertical	Pass
	846.4	13.14	0.46	6.5	19.18	Horizontal	Pass
	846.4	14.99	0.46	6.5	21.03	Vertical	Pass
Limit	ERP<7W=38.45dBm						



A4. OCCUPIED BANDWIDTH(99% OCCUPIED BANDWIDTH/26dB BANDWIDTH)

GSM Bandwidth [KHz]						
Mode	Lowest		Middle		Highest	
	99% BW	26dB BW	99% BW	26dB BW	99% BW	26dB BW
GSM850	244.12	308.9	247.08	317.5	243.47	313.9
GPRS850	241.28	320.1	246.36	318	244.43	317.4
EGPRS850	245.22	305.8	248.51	313.6	244.82	312.8

GSM Bandwidth [KHz]						
Mode	Lowest		Middle		Highest	
	99% BW	26dB BW	99% BW	26dB BW	99% BW	26dB BW
GSM1900	246.67	320.5	245.58	315.4	245.88	318.5
GPRS1900	244	315.7	242.99	316.1	243.68	316.8
EGPRS1900	251.66	316	253.46	322.3	244.7	319.5

WCDMA Bandwidth [MHz]						
Mode	Lowest		Middle		Highest	
	99% BW	26dB BW	99% BW	26dB BW	99% BW	26dB BW
WCDMA II	4.166	4.674	4.174	4.703	4.168	4.703
HSDPA II	4.174	4.675	4.17	4.683	4.171	4.683
HSUPA II	4.178	4.665	4.178	4.666	4.168	4.681

WCDMA Bandwidth [MHz]						
Mode	Lowest		Middle		Highest	
	99% BW	26dB BW	99% BW	26dB BW	99% BW	26dB BW
WCDMA V	4.172	4.679	4.169	4.674	4.166	4.667
HSDPA V	4.16	4.667	4.177	4.658	4.18	4.706
HSUPA V	4.172	4.665	4.179	4.678	4.172	4.68



GSM_850_Lower 26BW and 99%

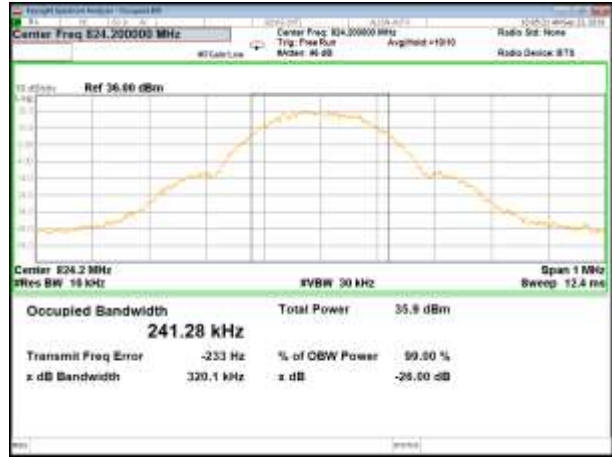

GPRS_850_Lower 26BW and 99%



GSM_850_Middle 26BW and 99%



GPRS_850_Middle 26BW and 99%



GSM_850_Higher 26BW and 99%



GPRS_850_Higher 26BW and 99%



EGPRS_850_Lower_26BW and 99%

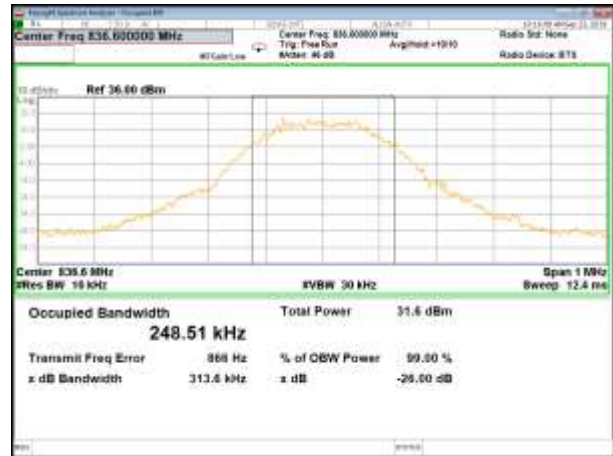

EGPRS_850_Middle_26BW and 99%



EGPRS_850_Higher_26BW and 99%



GSM_1900_Lower 26BW and 99%



GPRS_1900_Lower 26BW and 99%



GSM_1900_Middle 26BW and 99%



GPRS_1900_Middle 26BW and 99%



GSM_1900_Higher 26BW and 99%



GPRS_1900_Higher 26BW and 99%



EGPRS_1900_Lower 26BW and 99%



EGPRS_1900_Middle_26BW and 99%



EGPRS_1900_Higher 26BW and 99%



B2_WCDMA_Lower_26BW and 99%



B2_HSDPA_Lower_26BW and 99%



B2_WCDMA_Middle_26BW and 99%



B2_HSDPA_Middle_26BW and 99%



B2_WCDMA_Higher_26BW and 99%



B2_HSDPA_Higher_26BW and 99%



B2_HSUPA_Lower_26BW and 99%



B2_HSUPA_Middle_26BW and 99%



B2_HSUPA_Higher_26BW and 99%



B5_WCDMA_Lower_26BW and 99%



B5_HSDPA_Lower_26BW and 99%

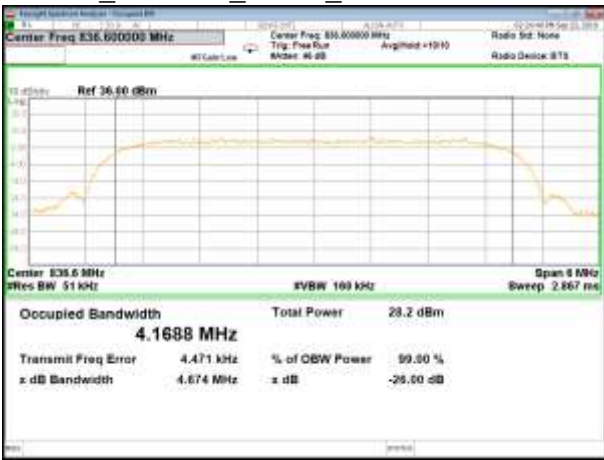

B5_WCDMA_Middle_26BW and 99%



B5_HSDPA_Middle_26BW and 99%



B5_WCDMA_Higher_26BW and 99%



B5_HSDPA_Higher_26BW and 99%



B5_HSUPA_Lower_26BW and 99%



B5_HSUPA_Middle_26BW and 99%

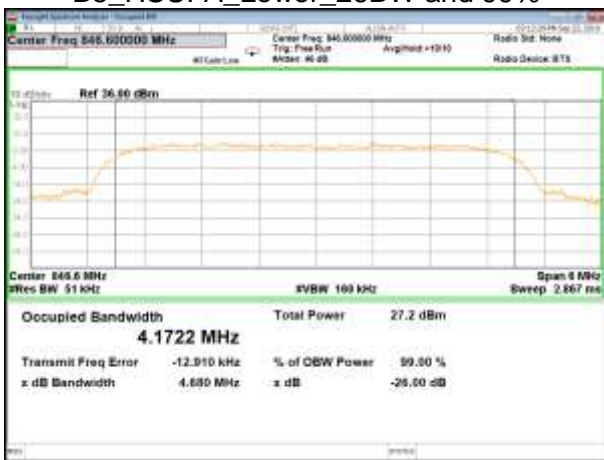

B5_HSUPA_Higher_26BW and 99%



A5.FREQUENCY STABILITY

Normal Voltage = \${Nor.}; Battery End Point (BEP) = 3.5V; Maximum Voltage = 4.35V

GSM 850 /836.6MHz					
Temperature (°C)	Voltage	Freq. Dev.	Freq. Dev.	Limit	Result
	(Volt)	(Hz)	(ppm)		
50	Normal Voltage	25.50	0.030	2.5ppm	PASS
40		34.38	0.041		
30		34.21	0.041		
20		17.31	0.021		
10		23.50	0.028		
0		20.89	0.025		
-10		17.79	0.021		
-20		29.30	0.035		
-30		15.22	0.018		
25		Maximum Voltage	35.55		
25	BEP	32.68	0.039		

GPRS 850 /836.6MHz					
Temperature (°C)	Voltage	Freq. Dev.	Freq. Dev.	Limit	Result
	(Volt)	(Hz)	(ppm)		
50	Normal Voltage	33.00	0.039	2.5ppm	PASS
40		23.45	0.028		
30		24.43	0.029		
20		24.07	0.029		
10		16.19	0.019		
0		27.63	0.033		
-10		12.74	0.015		
-20		18.54	0.022		
-30		18.06	0.022		
25		Maximum Voltage	35.21		
25	BEP	19.55	0.023		

EGPRS 850 /836.6MHz					
Temperature (°C)	Voltage	Freq. Dev.	Freq. Dev.	Limit	Result
	(Volt)	(Hz)	(ppm)		
50	Normal Voltage	15.55	0.019	2.5ppm	PASS
40		14.70	0.018		
30		12.19	0.015		
20		12.99	0.016		
10		17.12	0.020		
0		11.69	0.014		
-10		16.99	0.020		
-20		22.17	0.027		
-30		19.75	0.024		
25		Maximum Voltage	17.62		
25	BEP	21.92	0.026		



GSM 1900 / 1880MHz					
Temperature (°C)	Voltage	Freq. Dev.	Freq. Dev.	Limit	Result
	(Volt)	(Hz)	(ppm)		
50	Normal Voltage	16.17	0.009	Within Authorized Band	PASS
40		25.66	0.014		
30		34.97	0.019		
20		29.83	0.016		
10		17.63	0.009		
0		27.75	0.015		
-10		14.47	0.008		
-20		12.85	0.007		
-30		36.30	0.019		
25		Maximum Voltage	24.06		
25	BEP	22.65	0.012		

GPRS 1900 / 1880MHz					
Temperature (°C)	Voltage	Freq. Dev.	Freq. Dev.	Limit	Result
	(Volt)	(Hz)	(ppm)		
50	Normal Voltage	31.05	0.017	Within Authorized Band	PASS
40		15.84	0.008		
30		29.99	0.016		
20		31.06	0.017		
10		13.58	0.007		
0		16.63	0.009		
-10		30.68	0.016		
-20		30.26	0.016		
-30		14.19	0.008		
25		Maximum Voltage	34.46		
25	BEP	18.96	0.010		

EGPRS 1900 / 1880MHz					
Temperature (°C)	Voltage	Freq. Dev.	Freq. Dev.	Limit	Result
	(Volt)	(Hz)	(ppm)		
50	Normal Voltage	27.29	0.015	Within Authorized Band	PASS
40		29.07	0.015		
30		34.70	0.018		
20		27.92	0.015		
10		30.07	0.016		
0		35.22	0.019		
-10		24.42	0.013		
-20		26.69	0.014		
-30		32.20	0.017		
25		Maximum Voltage	18.28		
25	BEP	13.07	0.007		



UMTS Band II /1880MHz					
Temperature (°C)	Voltage	Freq. Dev.	Freq. Dev.	Limit	Result
	(Volt)	(Hz)	(ppm)		
50	Normal Voltage	22.33	0.012	Within Authorized Band	PASS
40		35.47	0.019		
30		20.41	0.011		
20		18.54	0.010		
10		35.94	0.019		
0		30.83	0.016		
-10		34.34	0.018		
-20		26.45	0.014		
-30		22.22	0.012		
25		Maximum Voltage	23.52		
25	BEP	27.30	0.015		

HSDPA Band II /1880MHz					
Temperature (°C)	Voltage	Freq. Dev.	Freq. Dev.	Limit	Result
	(Volt)	(Hz)	(ppm)		
50	Normal Voltage	26.88	0.014	Within Authorized Band	PASS
40		15.32	0.008		
30		13.20	0.007		
20		35.07	0.019		
10		26.60	0.014		
0		12.11	0.006		
-10		22.26	0.012		
-20		26.75	0.014		
-30		16.92	0.009		
25		Maximum Voltage	23.38		
25	BEP	21.64	0.012		

HSUPA Band II /1880MHz					
Temperature (°C)	Voltage	Freq. Dev.	Freq. Dev.	Limit	Result
	(Volt)	(Hz)	(ppm)		
50	Normal Voltage	25.11	0.013	Within Authorized Band	PASS
40		16.96	0.009		
30		32.31	0.017		
20		24.73	0.013		
10		21.25	0.011		
0		32.92	0.018		
-10		27.85	0.015		
-20		14.59	0.008		
-30		30.83	0.016		
25		Maximum Voltage	25.98		
25	BEP	35.78	0.019		



UMTS Band V / 836.6MHz					
Temperature (°C)	Voltage	Freq. Dev.	Freq. Dev.	Limit	Result
	(Volt)	(Hz)	(ppm)		
50	Normal Voltage	28.79	0.034	2.5ppm	PASS
40		17.76	0.021		
30		27.19	0.033		
20		29.89	0.036		
10		20.91	0.025		
0		20.85	0.025		
-10		24.04	0.029		
-20		33.17	0.040		
-30		22.43	0.027		
25		Maximum Voltage	34.39		
25	BEP	16.73	0.020		

HSDPA Band V / 836.6MHz					
Temperature (°C)	Voltage	Freq. Dev.	Freq. Dev.	Limit	Result
	(Volt)	(Hz)	(ppm)		
50	Normal Voltage	33.44	0.040	2.5ppm	PASS
40		31.64	0.038		
30		15.88	0.019		
20		14.98	0.018		
10		25.92	0.031		
0		11.98	0.014		
-10		13.58	0.016		
-20		18.21	0.022		
-30		28.27	0.034		
25		Maximum Voltage	35.95		
25	BEP	15.61	0.019		

HSUPA Band V / 836.6MHz					
Temperature (°C)	Voltage	Freq. Dev.	Freq. Dev.	Limit	Result
	(Volt)	(Hz)	(ppm)		
50	Normal Voltage	24.53	0.029	2.5ppm	PASS
40		27.18	0.032		
30		32.02	0.038		
20		33.38	0.040		
10		17.10	0.020		
0		31.97	0.038		
-10		28.31	0.034		
-20		22.68	0.027		
-30		24.29	0.029		
25		Maximum Voltage	26.44		
25	BEP	26.72	0.032		

1. The frequency fundamental emissions stay within the authorized frequency block based on the frequency deviation measured is small.



A6.SPURIOUS EMISSIONS AT ANTENNA TERMINALS



GSM_850_Lower_Conducted_Spurious



GPRS_850_Lower_Conducted_Spurious



GSM_850_Middle_Conducted_Spurious



GPRS_850_Middle_Conducted_Spurious



GSM_850_Higher_Conducted_Spurious



GPRS_850_Higher_Conducted_Spurious

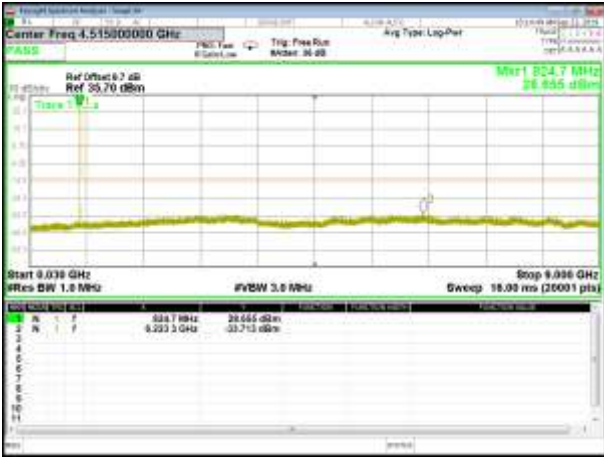

EGPRS_850_Lower_Conducted Spurious

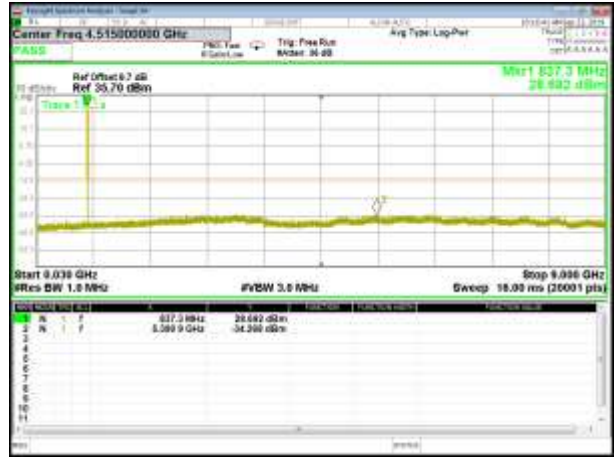

EGPRS_850_Middle_Conducted Spurious



EGPRS_850_Higher_Conducted Spurious

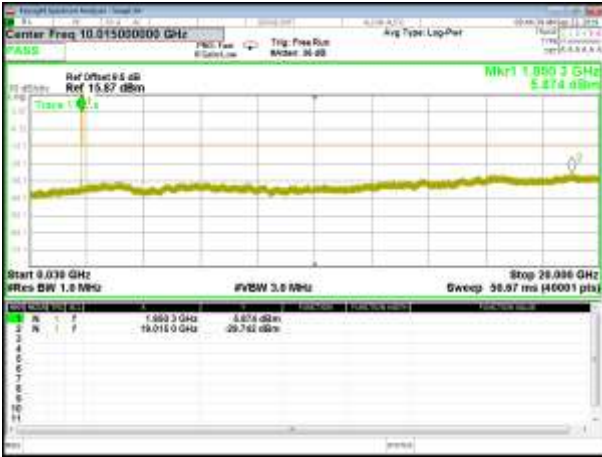

GSM_1900_Lower Conducted Spurious

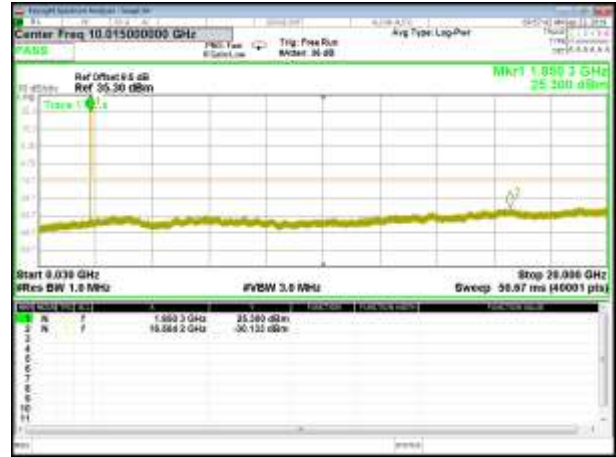

GPRS_1900_Lower Conducted Spurious

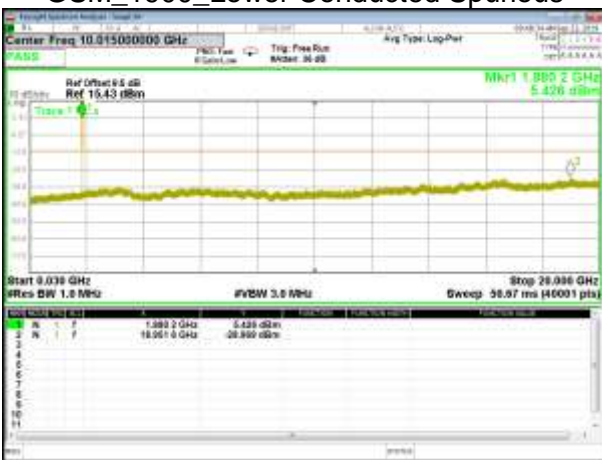

GSM_1900_Middle Conducted Spurious

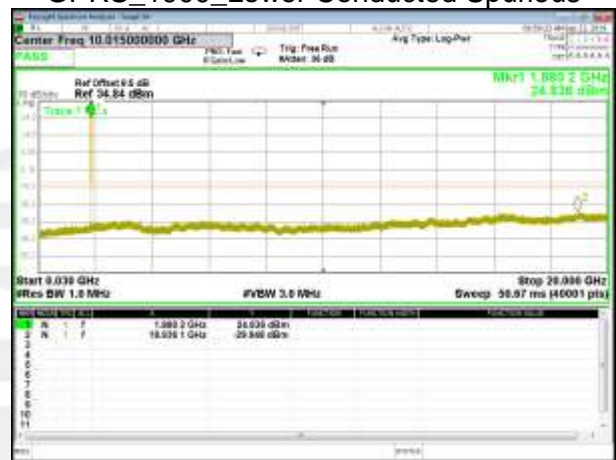

GPRS_1900_Middle Conducted Spurious



GSM_1900_Higher Conducted Spurious



GPRS_1900_Higher Conducted Spurious

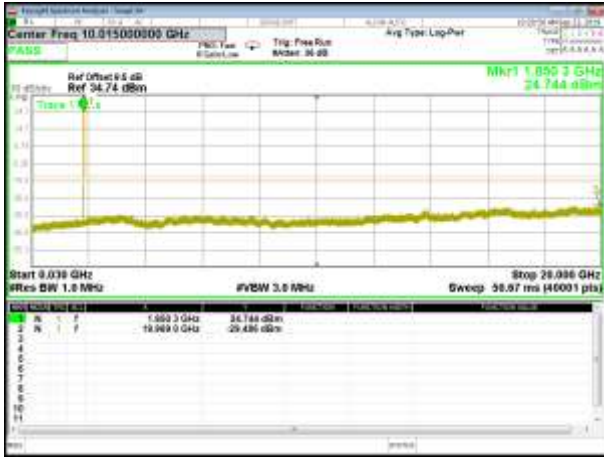

EGPRS_1900_Lower Conducted Spurious



EGPRS_1900_Middle Conducted Spurious



EGPRS_1900_Higher Conducted Spurious

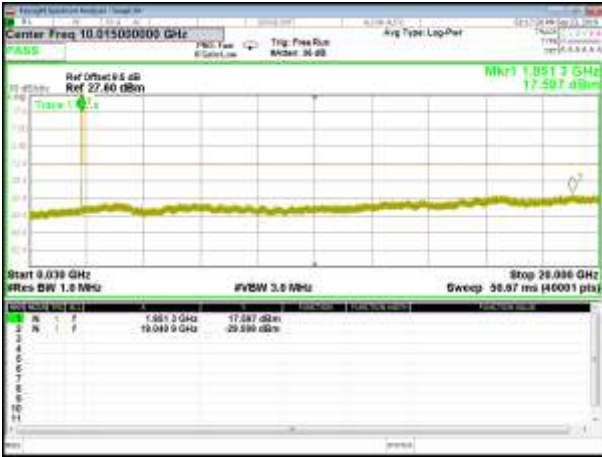

B2_WCDMA_Lower_Conducted Spurious



B2_HSDPA_Lower_Conducted Spurious



B2_WCDMA_Middle_Conducted Spurious



B2_HSDPA_Middle_Conducted Spurious



B2_WCDMA_Higher_Conducted Spurious



B2_HSDPA_Higher_Conducted Spurious



B2_HSUPA_Lower_Conducted Spurious



B2_HSUPA_Middle_Conducted Spurious

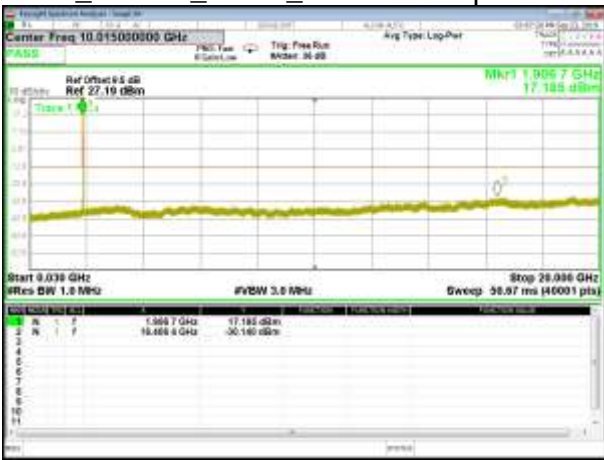

B2_HSUPA_Higher_Conducted Spurious

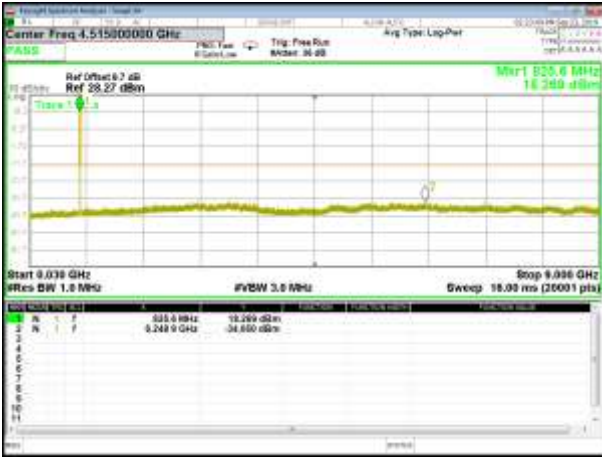

B5_WCDMA_Lower_Conducted Spurious

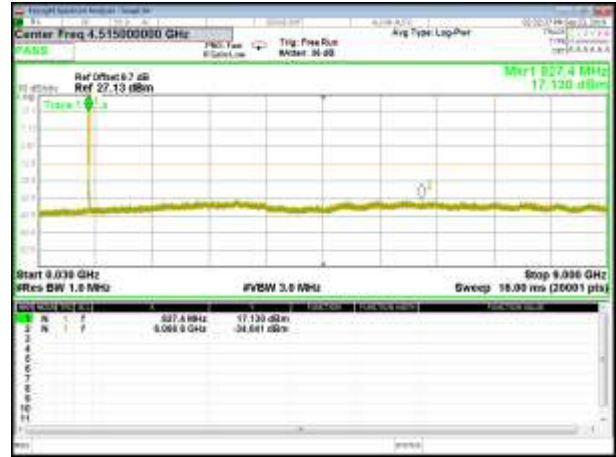

B5_HSDPA_Lower_Conducted Spurious

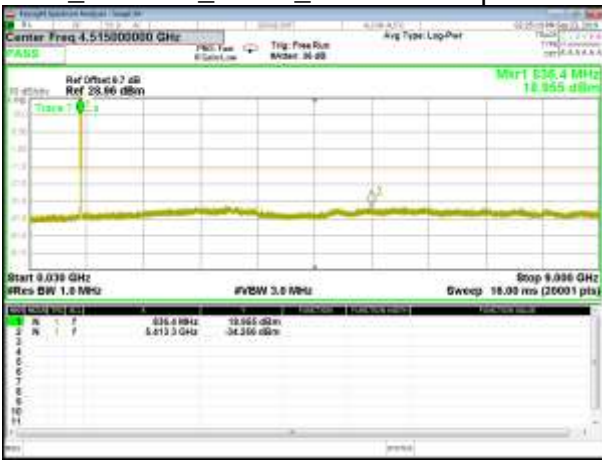

B5_WCDMA_Middle_Conducted Spurious

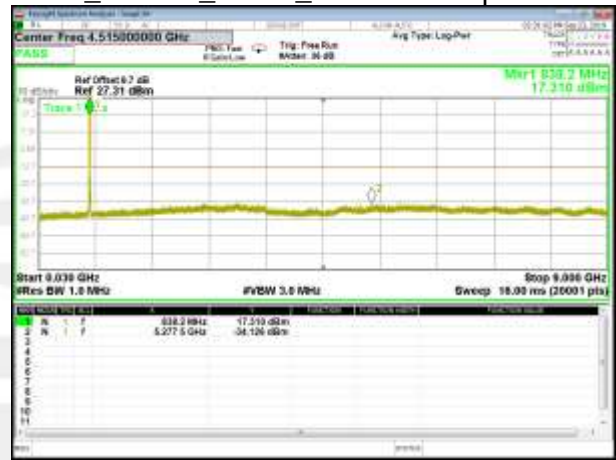

B5_HSDPA_Middle_Conducted Spurious



B5_WCDMA_Higher_Conducted Spurious



B5_HSDPA_Higher_Conducted Spurious

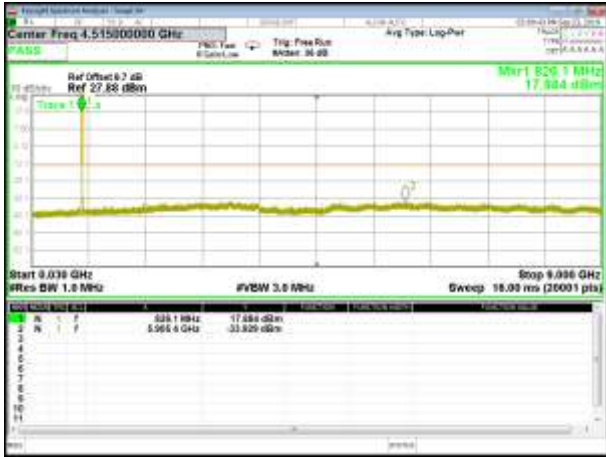

B5_HSUPA_Lower_Conducted Spurious

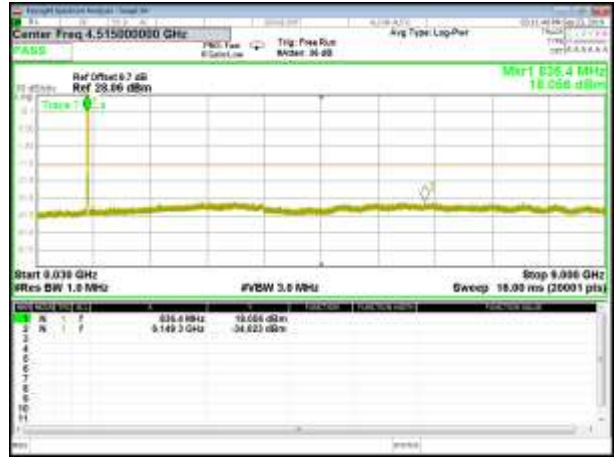

B5_HSUPA_Middle_Conducted Spurious



B5_HSUPA_Higher_Conducted Spurious



A7. BAND EDGE



GSM_850_Lower_Band edge



GPRS_850_Lower_Band edge



GSM_850_Higher_Band edge



GPRS_850_Higher_Band edge



EGPRS_850_Lower_Band edge



EGPRS_850_Higher_Band edge



GSM_1900_Lower Band edge



GPRS_1900_Lower Band edge



GSM_1900_Higher Band edge



GPRS_1900_Higher Band edge

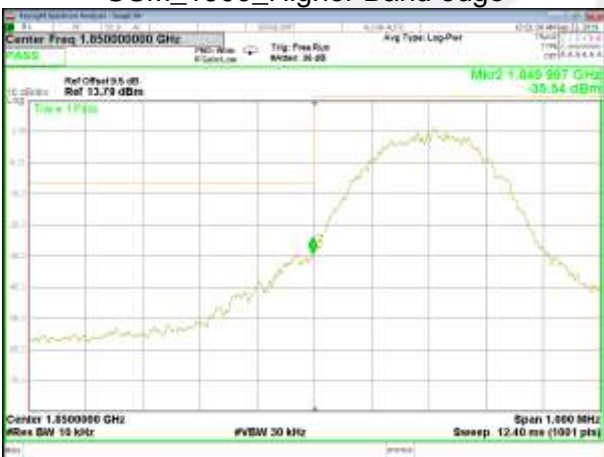

EGPRS_1900_Lower Band edge



EGPRS_1900_Higher Band edge



B2_WCDMA_Lower_Band edge



B2_HSDPA_Lower_Band edge



B2_WCDMA_Higher_Band edge



B2_HSDPA_Higher_Band edge

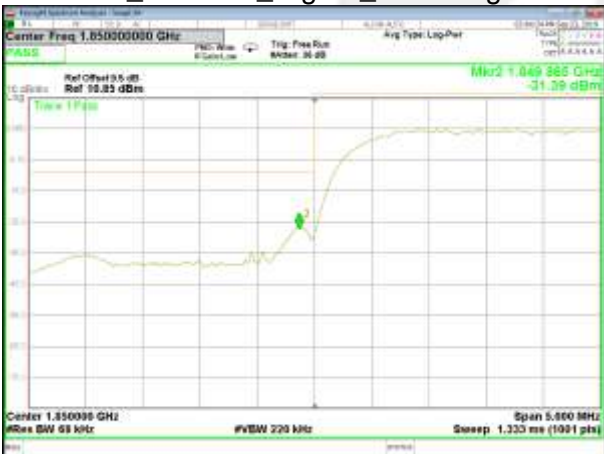

B2_HSUPA_Lower_Band edge



B2_HSUPA_Higher_Band edge



B5_WCDMA_Lower_Band edge

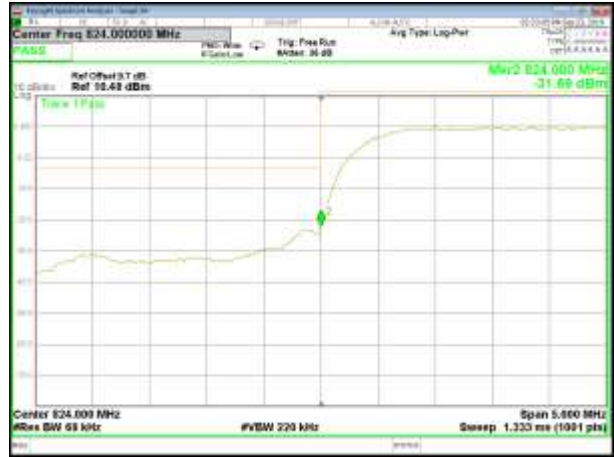

B5_HSDPA_Lower_Band edge



B5_WCDMA_Higher_Band edge



B5_HSDPA_Higher_Band edge



B5_HSUPA_Lower_Band edge



B5_HSUPA_Higher_Band edge



A8. FIELD STRENGTH OF SPURIOUS RADIATION MEASUREMENT

Note:(1) Below 30MHz no Spurious found is the worst condition.

(2) Above 3.5GHz amplitude of spurious emissions which are attenuated by more than 20dB below the permissible value

(3) Test is divided into three directions, X/Y/Z. X pattern for the worst.

GSM 850: (30-9000)MHz							
The Worst Test Results Channel 128/824.2 MHz							
Frequency(MHz)	S G.Lev (dBm)	Ant(dBi)	Loss	PMea (dBm)	Limit (dBm)	Margin (dBm)	Polarity
1648.32	-40.26	9.40	4.75	-35.61	-13.00	-22.61	H
2472.53	-39.21	10.60	8.39	-37.00	-13.00	-24.00	H
3296.86	-31.79	12.00	11.79	-31.58	-13.00	-18.58	H
1648.38	-44.44	9.40	4.75	-39.79	-13.00	-26.79	V
2472.47	-44.61	10.60	8.39	-42.40	-13.00	-29.40	V
3296.55	-42.56	12.00	11.79	-42.35	-13.00	-29.35	V
The Worst Test Results Channel 190/836.6 MHz							
Frequency(MHz)	S G.Lev (dBm)	Ant(dBi)	Loss	PMea (dBm)	Limit (dBm)	Margin (dBm)	Polarity
1673.24	-40.81	9.50	4.76	-36.07	-13.00	-23.07	H
2509.63	-39.84	10.70	8.40	-37.54	-13.00	-24.54	H
3346.02	-31.90	12.20	11.80	-31.50	-13.00	-18.50	H
1673.22	-43.36	9.40	4.75	-38.71	-13.00	-25.71	V
2509.55	-45.16	10.60	8.39	-42.95	-13.00	-29.95	V
3345.98	-43.65	12.20	11.82	-43.27	-13.00	-30.27	V
The Worst Test Results Channel 251/848.8 MHz							
Frequency(MHz)	S G.Lev (dBm)	Ant(dBi)	Loss	PMea (dBm)	Limit (dBm)	Margin (dBm)	Polarity
1697.49	-41.12	9.60	4.77	-36.29	-13.00	-23.29	H
2546.08	-40.25	10.80	8.50	-37.95	-13.00	-24.95	H
3395.24	-31.50	12.50	11.90	-30.90	-13.00	-17.90	H
1697.32	-44.50	9.60	4.77	-39.67	-13.00	-26.67	V
2546.17	-45.44	10.80	8.50	-43.14	-13.00	-30.14	V
3395.20	-42.53	12.50	11.90	-41.93	-13.00	-28.93	V

GPRS 850: (30-9000)MHz							
The Worst Test Results Channel 128/824.2 MHz							
Frequency(MHz)	S G.Lev (dBm)	Ant(dBi)	Loss	PMea (dBm)	Limit (dBm)	Margin (dBm)	Polarity
1648.12	-40.44	9.40	4.75	-35.79	-13.00	-22.79	H
2472.33	-40.59	10.60	8.39	-38.38	-13.00	-25.38	H
3296.71	-32.35	12.00	11.79	-32.14	-13.00	-19.14	H
1648.45	-44.02	9.40	4.75	-39.37	-13.00	-26.37	V
2472.29	-45.12	10.60	8.39	-42.91	-13.00	-29.91	V
3296.76	-43.82	12.00	11.79	-43.61	-13.00	-30.61	V



The Worst Test Results Channel 190/836.6 MHz							
Frequency(MHz)	S	Ant(dBi)	Loss	PMea	Limit	Margin	Polarity
	G.Lev (dBm)			(dBm)	(dBm)	(dBm)	
1672.91	-41.51	9.50	4.76	-36.77	-13.00	-23.77	H
2509.57	-40.00	10.70	8.40	-37.70	-13.00	-24.70	H
3346.29	-31.72	12.20	11.80	-31.32	-13.00	-18.32	H
1673.20	-44.08	9.40	4.75	-39.43	-13.00	-26.43	V
2509.59	-44.50	10.60	8.39	-42.29	-13.00	-29.29	V
3346.39	-42.82	12.20	11.82	-42.44	-13.00	-29.44	V

The Worst Test Results Channel 251/848.8 MHz							
Frequency(MHz)	S	Ant(dBi)	Loss	PMea	Limit	Margin	Polarity
	G.Lev (dBm)			(dBm)	(dBm)	(dBm)	
1697.50	-40.21	9.60	4.77	-35.38	-13.00	-22.38	H
2546.40	-39.37	10.80	8.50	-37.07	-13.00	-24.07	H
3394.96	-31.11	12.50	11.90	-30.51	-13.00	-17.51	H
1697.52	-43.50	9.60	4.77	-38.67	-13.00	-25.67	V
2546.29	-44.61	10.80	8.50	-42.31	-13.00	-29.31	V
3395.33	-43.03	12.50	11.90	-42.43	-13.00	-29.43	V

EGPRS 850: (30-9000)MHz							
The Worst Test Results Channel 128/824.2 MHz							
Frequency(MHz)	S	Ant(dBi)	Loss	PMea	Limit	Margin	Polarity
	G.Lev (dBm)			(dBm)	(dBm)	(dBm)	
1648.14	-40.45	9.40	4.75	-35.80	-13.00	-22.80	H
2472.64	-40.20	10.60	8.39	-37.99	-13.00	-24.99	H
3296.68	-31.46	12.00	11.79	-31.25	-13.00	-18.25	H
1648.28	-44.10	9.40	4.75	-39.45	-13.00	-26.45	V
2472.68	-45.06	10.60	8.39	-42.85	-13.00	-29.85	V
3296.49	-43.49	12.00	11.79	-43.28	-13.00	-30.28	V

The Worst Test Results Channel 190/836.6 MHz							
Frequency(MHz)	S	Ant(dBi)	Loss	PMea	Limit	Margin	Polarity
	G.Lev (dBm)			(dBm)	(dBm)	(dBm)	
1673.23	-41.41	9.50	4.76	-36.67	-13.00	-23.67	H
2509.90	-39.55	10.70	8.40	-37.25	-13.00	-24.25	H
3346.30	-31.78	12.20	11.80	-31.38	-13.00	-18.38	H
1673.13	-44.45	9.40	4.75	-39.80	-13.00	-26.80	V
2509.71	-45.26	10.60	8.39	-43.05	-13.00	-30.05	V
3346.25	-43.55	12.20	11.82	-43.17	-13.00	-30.17	V

The Worst Test Results Channel 251/848.8 MHz							
Frequency(MHz)	S	Ant(dBi)	Loss	PMea	Limit	Margin	Polarity
	G.Lev (dBm)			(dBm)	(dBm)	(dBm)	
1697.46	-40.29	9.60	4.77	-35.46	-13.00	-22.46	H
2546.15	-40.59	10.80	8.50	-38.29	-13.00	-25.29	H
3395.16	-31.84	12.50	11.90	-31.24	-13.00	-18.24	H
1697.40	-44.04	9.60	4.77	-39.21	-13.00	-26.21	V
2546.35	-44.95	10.80	8.50	-42.65	-13.00	-29.65	V
3395.10	-43.34	12.50	11.90	-42.74	-13.00	-29.74	V



DCS 1900: (30-20000)MHz							
The Worst Test Results for Channel 512/1850.2MHz							
Frequency(MHz)	S	Ant(dBi)	Loss	PMea	Limit	Margin	Polarity
	G.Lev (dBm)			(dBm)	(dBm)	(dBm)	
3700.12	-33.46	12.60	12.93	-33.79	-13.00	-20.79	H
5550.52	-35.03	13.10	17.11	-39.04	-13.00	-26.04	H
7400.77	-32.90	11.50	22.20	-43.60	-13.00	-30.60	H
3700.84	-35.15	12.60	12.93	-35.48	-13.00	-22.48	V
5550.27	-35.07	13.10	17.11	-39.08	-13.00	-26.08	V
7400.75	-32.89	11.50	22.20	-43.59	-13.00	-30.59	V
The Worst Test Results for Channel 661/1880.0MHz							
Frequency(MHz)	S	Ant(dBi)	Loss	PMea	Limit	Margin	Polarity
	G.Lev (dBm)			(dBm)	(dBm)	(dBm)	
3759.80	-33.57	12.60	12.93	-33.90	-13.00	-20.90	H
5640.16	-35.20	13.10	17.11	-39.21	-13.00	-26.21	H
7520.25	-33.51	11.50	22.20	-44.21	-13.00	-31.21	H
3760.01	-35.65	12.60	12.93	-35.98	-13.00	-22.98	V
5639.98	-34.74	13.10	17.11	-38.75	-13.00	-25.75	V
7520.01	-32.15	11.50	22.20	-42.85	-13.00	-29.85	V
The Worst Test Results for Channel 810/1909.8MHz							
Frequency(MHz)	S	Ant(dBi)	Loss	PMea	Limit	Margin	Polarity
	G.Lev (dBm)			(dBm)	(dBm)	(dBm)	
3819.55	-34.22	12.60	12.93	-34.55	-13.00	-21.55	H
5729.04	-35.31	13.10	17.11	-39.32	-13.00	-26.32	H
7639.15	-33.47	11.50	22.20	-44.17	-13.00	-31.17	H
3819.66	-34.95	12.60	12.93	-35.28	-13.00	-22.28	V
5729.27	-34.46	13.10	17.11	-38.47	-13.00	-25.47	V
7639.15	-33.19	11.50	22.20	-43.89	-13.00	-30.89	V

GPRS1900: (30-20000)MHz							
The Worst Test Results for Channel 512/1850.2MHz							
Frequency(MHz)	S	Ant(dBi)	Loss	PMea	Limit	Margin	Polarity
	G.Lev (dBm)			(dBm)	(dBm)	(dBm)	
3700.12	-34.38	12.60	12.93	-34.71	-13.00	-21.71	H
5550.26	-34.34	13.10	17.11	-38.35	-13.00	-25.35	H
7400.61	-32.89	11.50	22.20	-43.59	-13.00	-30.59	H
3700.35	-34.54	12.60	12.93	-34.87	-13.00	-21.87	V
5550.54	-34.01	13.10	17.11	-38.02	-13.00	-25.02	V
7400.96	-31.78	11.50	22.20	-42.48	-13.00	-29.48	V
The Worst Test Results for Channel 661/1880.0MHz							
Frequency(MHz)	S	Ant(dBi)	Loss	PMea	Limit	Margin	Polarity
	G.Lev (dBm)			(dBm)	(dBm)	(dBm)	
3759.78	-34.33	12.60	12.93	-34.66	-13.00	-21.66	H
5639.98	-34.40	13.10	17.11	-38.41	-13.00	-25.41	H
7520.16	-33.28	11.50	22.20	-43.98	-13.00	-30.98	H
3760.32	-35.37	12.60	12.93	-35.70	-13.00	-22.70	V
5639.96	-35.04	13.10	17.11	-39.05	-13.00	-26.05	V
7520.29	-32.15	11.50	22.20	-42.85	-13.00	-29.85	V
The Worst Test Results for Channel 810/1909.8MHz							



Frequency(MHz)	S G.Lev (dBm)	Ant(dBi)	Loss	PMea	Limit	Margin	Polarity
				(dBm)	(dBm)	(dBm)	
3819.58	-34.68	12.60	12.93	-35.01	-13.00	-22.01	H
5729.12	-34.46	13.10	17.11	-38.47	-13.00	-25.47	H
7638.93	-32.30	11.50	22.20	-43.00	-13.00	-30.00	H
3819.80	-34.87	12.60	12.93	-35.20	-13.00	-22.20	V
5729.33	-35.11	13.10	17.11	-39.12	-13.00	-26.12	V
7639.11	-32.79	11.50	22.20	-43.49	-13.00	-30.49	V

EGPRS 1900: (30-20000)MHz

The Worst Test Results for Channel 512/1850.2MHz

Frequency(MHz)	S G.Lev (dBm)	Ant(dBi)	Loss	PMea	Limit	Margin	Polarity
				(dBm)	(dBm)	(dBm)	
3700.09	-33.84	12.60	12.93	-34.17	-13.00	-21.17	H
5550.41	-34.80	13.10	17.11	-38.81	-13.00	-25.81	H
7400.85	-32.47	11.50	22.20	-43.17	-13.00	-30.17	H
3700.61	-34.99	12.60	12.93	-35.32	-13.00	-22.32	V
5550.47	-34.61	13.10	17.11	-38.62	-13.00	-25.62	V
7400.53	-31.82	11.50	22.20	-42.52	-13.00	-29.52	V

The Worst Test Results for Channel 661/1880.0MHz

Frequency(MHz)	S G.Lev (dBm)	Ant(dBi)	Loss	PMea	Limit	Margin	Polarity
				(dBm)	(dBm)	(dBm)	
3760.12	-34.66	12.60	12.93	-34.99	-13.00	-21.99	H
5639.80	-34.15	13.10	17.11	-38.16	-13.00	-25.16	H
7519.90	-33.32	11.50	22.20	-44.02	-13.00	-31.02	H
3760.04	-35.86	12.60	12.93	-36.19	-13.00	-23.19	V
5640.04	-34.18	13.10	17.11	-38.19	-13.00	-25.19	V
7519.96	-32.79	11.50	22.20	-43.49	-13.00	-30.49	V

The Worst Test Results for Channel 810/1909.8MHz

Frequency(MHz)	S G.Lev (dBm)	Ant(dBi)	Loss	PMea	Limit	Margin	Polarity
				(dBm)	(dBm)	(dBm)	
3819.66	-34.67	12.60	12.93	-35.00	-13.00	-22.00	H
5729.40	-34.22	13.10	17.11	-38.23	-13.00	-25.23	H
7639.24	-32.27	11.50	22.20	-42.97	-13.00	-29.97	H
3819.66	-35.65	12.60	12.93	-35.98	-13.00	-22.98	V
5729.27	-34.05	13.10	17.11	-38.06	-13.00	-25.06	V
7639.16	-32.94	11.50	22.20	-43.64	-13.00	-30.64	V



WCDMA Band V: (30-9000)MHz							
The worst test results channel 4132/826.4MHz							
Frequency(MHz)	S	Ant(dBi)	Loss	PMea	Limit	Margin	Polarity
	G.Lev (dBm)			(dBm)	(dBm)	(dBm)	
1652.38	-40.34	9.40	4.75	-35.69	-13.00	-22.69	H
2479.29	-39.50	10.60	8.39	-37.29	-13.00	-24.29	H
3305.63	-32.07	12.00	11.79	-31.86	-13.00	-18.86	H
1652.32	-43.28	9.40	4.75	-38.63	-13.00	-25.63	V
2479.40	-45.09	10.60	8.39	-42.88	-13.00	-29.88	V
3305.70	-43.38	12.00	11.79	-43.17	-13.00	-30.17	V
The Worst Test Results Channel 4183/836.6MHz							
Frequency(MHz)	S	Ant(dBi)	Loss	PMea	Limit	Margin	Polarity
	G.Lev (dBm)			(dBm)	(dBm)	(dBm)	
1673.17	-40.39	9.50	4.76	-35.65	-13.00	-22.65	H
2509.66	-40.17	10.70	8.40	-37.87	-13.00	-24.87	H
3346.41	-31.76	12.20	11.80	-31.36	-13.00	-18.36	H
1673.23	-43.46	9.40	4.75	-38.81	-13.00	-25.81	V
2509.77	-45.04	10.60	8.39	-42.83	-13.00	-29.83	V
3346.13	-43.77	12.20	11.82	-43.39	-13.00	-30.39	V
The Worst Test Results Channel 4233/846.6MHz							
Frequency(MHz)	S	Ant(dBi)	Loss	PMea	Limit	Margin	Polarity
	G.Lev (dBm)			(dBm)	(dBm)	(dBm)	
1693.67	-41.20	9.60	4.77	-36.37	-13.00	-23.37	H
2539.15	-40.58	10.80	8.50	-38.28	-13.00	-25.28	H
3386.06	-31.13	12.50	11.90	-30.53	-13.00	-17.53	H
1693.22	-43.55	9.60	4.77	-38.72	-13.00	-25.72	V
2539.43	-44.40	10.80	8.50	-42.10	-13.00	-29.10	V
3385.96	-43.32	12.50	11.90	-42.72	-13.00	-29.72	V

HSUPA Band V: (30-9000)MHz							
The worst test results channel 4132/826.4MHz							
Frequency(MHz)	S	Ant(dBi)	Loss	PMea	Limit	Margin	Polarity
	G.Lev (dBm)			(dBm)	(dBm)	(dBm)	
1652.10	-40.44	9.40	4.75	-35.79	-13.00	-22.79	H
2479.57	-40.42	10.60	8.39	-38.21	-13.00	-25.21	H
3305.53	-32.30	12.00	11.79	-32.09	-13.00	-19.09	H
1652.22	-44.37	9.40	4.75	-39.72	-13.00	-26.72	V
2479.24	-44.14	10.60	8.39	-41.93	-13.00	-28.93	V
3305.81	-42.89	12.00	11.79	-42.68	-13.00	-29.68	V
The Worst Test Results Channel 4183/836.6MHz							
Frequency(MHz)	S	Ant(dBi)	Loss	PMea	Limit	Margin	Polarity
	G.Lev (dBm)			(dBm)	(dBm)	(dBm)	
1672.87	-40.53	9.50	4.76	-35.79	-13.00	-22.79	H
2509.86	-39.96	10.70	8.40	-37.66	-13.00	-24.66	H
3346.19	-32.05	12.20	11.80	-31.65	-13.00	-18.65	H
1673.11	-43.39	9.40	4.75	-38.74	-13.00	-25.74	V
2509.43	-44.99	10.60	8.39	-42.78	-13.00	-29.78	V
3346.30	-42.70	12.20	11.82	-42.32	-13.00	-29.32	V
The Worst Test Results Channel 4233/846.6MHz							



Frequency(MHz)	S G.Lev (dBm)	Ant(dBi)	Loss	PMea	Limit	Margin	Polarity
				(dBm)	(dBm)	(dBm)	
1693.48	-40.68	9.60	4.77	-35.85	-13.00	-22.85	H
2539.56	-40.53	10.80	8.50	-38.23	-13.00	-25.23	H
3385.99	-31.79	12.50	11.90	-31.19	-13.00	-18.19	H
1693.38	-43.39	9.60	4.77	-38.56	-13.00	-25.56	V
2539.38	-44.94	10.80	8.50	-42.64	-13.00	-29.64	V
3386.30	-43.68	12.50	11.90	-43.08	-13.00	-30.08	V

HSDPA Band V: (30-9000)MHz

The worst test results channel 4132/826.4MHz

Frequency(MHz)	S G.Lev (dBm)	Ant(dBi)	Loss	PMea	Limit	Margin	Polarity
				(dBm)	(dBm)	(dBm)	
1652.49	-40.57	9.40	4.75	-35.92	-13.00	-22.92	H
2479.46	-39.93	10.60	8.39	-37.72	-13.00	-24.72	H
3305.68	-30.86	12.00	11.79	-30.65	-13.00	-17.65	H
1652.09	-44.04	9.40	4.75	-39.39	-13.00	-26.39	V
2479.55	-45.11	10.60	8.39	-42.90	-13.00	-29.90	V
3305.55	-43.28	12.00	11.79	-43.07	-13.00	-30.07	V

The Worst Test Results Channel 4183/836.6MHz

Frequency(MHz)	S G.Lev (dBm)	Ant(dBi)	Loss	PMea	Limit	Margin	Polarity
				(dBm)	(dBm)	(dBm)	
1673.05	-41.17	9.50	4.76	-36.43	-13.00	-23.43	H
2509.61	-40.17	10.70	8.40	-37.87	-13.00	-24.87	H
3346.37	-31.77	12.20	11.80	-31.37	-13.00	-18.37	H
1672.98	-43.35	9.40	4.75	-38.70	-13.00	-25.70	V
2509.50	-44.52	10.60	8.39	-42.31	-13.00	-29.31	V
3346.42	-43.42	12.20	11.82	-43.04	-13.00	-30.04	V

The Worst Test Results Channel 4233/846.6MHz

Frequency(MHz)	S G.Lev (dBm)	Ant(dBi)	Loss	PMea	Limit	Margin	Polarity
				(dBm)	(dBm)	(dBm)	
1693.63	-41.01	9.60	4.77	-36.18	-13.00	-23.18	H
2539.22	-39.36	10.80	8.50	-37.06	-13.00	-24.06	H
3386.07	-30.94	12.50	11.90	-30.34	-13.00	-17.34	H
1693.31	-43.66	9.60	4.77	-38.83	-13.00	-25.83	V
2539.38	-44.79	10.80	8.50	-42.49	-13.00	-29.49	V
3386.32	-42.53	12.50	11.90	-41.93	-13.00	-28.93	V



WCDMA Band II: (30-20000)MHz							
The Worst Test Results for Channel 9262/1852.4MHz							
Frequency(MHz)	S	Ant(dBi)	Loss	PMea	Limit	Margin	Polarity
	G.Lev (dBm)			(dBm)	(dBm)	(dBm)	
3704.14	-34.17	12.60	12.93	-34.50	-13.00	-21.50	H
5557.40	-34.90	13.10	17.11	-38.91	-13.00	-25.91	H
7409.57	-32.30	11.50	22.20	-43.00	-13.00	-30.00	H
3704.31	-35.56	12.60	12.93	-35.89	-13.00	-22.89	V
5557.26	-34.10	13.10	17.11	-38.11	-13.00	-25.11	V
7409.96	-32.23	11.50	22.20	-42.93	-13.00	-29.93	V
The Worst Test Results for Channel 9400/1880MHz							
Frequency(MHz)	S	Ant(dBi)	Loss	PMea	Limit	Margin	Polarity
	G.Lev (dBm)			(dBm)	(dBm)	(dBm)	
3760.13	-34.14	12.60	12.93	-34.47	-13.00	-21.47	H
5640.24	-35.25	13.10	17.11	-39.26	-13.00	-26.26	H
7519.94	-32.49	11.50	22.20	-43.19	-13.00	-30.19	H
3760.28	-34.77	12.60	12.93	-35.10	-13.00	-22.10	V
5640.02	-34.26	13.10	17.11	-38.27	-13.00	-25.27	V
7519.82	-33.08	11.50	22.20	-43.78	-13.00	-30.78	V
The Worst Test Results for Channel 9538/1907.6MHz							
Frequency(MHz)	S	Ant(dBi)	Loss	PMea	Limit	Margin	Polarity
	G.Lev (dBm)			(dBm)	(dBm)	(dBm)	
3815.50	-33.57	12.60	12.93	-33.90	-13.00	-20.90	H
5722.47	-34.03	13.10	17.11	-38.04	-13.00	-25.04	H
7630.10	-33.60	11.50	22.20	-44.30	-13.00	-31.30	H
3815.37	-35.50	12.60	12.93	-35.83	-13.00	-22.83	V
5722.45	-33.90	13.10	17.11	-37.91	-13.00	-24.91	V
7630.14	-32.00	11.50	22.20	-42.70	-13.00	-29.70	V

HSUPA Band II: (30-20000)MHz							
The Worst Test Results for Channel 9262/1852.4MHz							
Frequency(MHz)	S	Ant(dBi)	Loss	PMea	Limit	Margin	Polarity
	G.Lev (dBm)			(dBm)	(dBm)	(dBm)	
3704.14	-33.65	12.60	12.93	-33.98	-13.00	-20.98	H
5557.48	-34.89	13.10	17.11	-38.90	-13.00	-25.90	H
7409.69	-32.80	11.50	22.20	-43.50	-13.00	-30.50	H
3704.21	-35.21	12.60	12.93	-35.54	-13.00	-22.54	V
5557.24	-34.48	13.10	17.11	-38.49	-13.00	-25.49	V
7409.71	-31.97	11.50	22.20	-42.67	-13.00	-29.67	V
The Worst Test Results for Channel 9400/1880MHz							
Frequency(MHz)	S	Ant(dBi)	Loss	PMea	Limit	Margin	Polarity
	G.Lev (dBm)			(dBm)	(dBm)	(dBm)	
3760.12	-34.02	12.60	12.93	-34.35	-13.00	-21.35	H
5640.02	-34.12	13.10	17.11	-38.13	-13.00	-25.13	H
7520.12	-32.84	11.50	22.20	-43.54	-13.00	-30.54	H
3759.90	-34.78	12.60	12.93	-35.11	-13.00	-22.11	V
5640.00	-34.27	13.10	17.11	-38.28	-13.00	-25.28	V
7519.85	-32.50	11.50	22.20	-43.20	-13.00	-30.20	V
The Worst Test Results for Channel 9538/1907.6MHz							



Frequency(MHz)	S G.Lev (dBm)	Ant(dBi)	Loss	PMea	Limit	Margin	Polarity
				(dBm)	(dBm)	(dBm)	
3815.33	-33.76	12.60	12.93	-34.09	-13.00	-21.09	H
5722.28	-35.24	13.10	17.11	-39.25	-13.00	-26.25	H
7630.22	-32.79	11.50	22.20	-43.49	-13.00	-30.49	H
3815.55	-34.98	12.60	12.93	-35.31	-13.00	-22.31	V
5722.17	-35.08	13.10	17.11	-39.09	-13.00	-26.09	V
7629.93	-32.41	11.50	22.20	-43.11	-13.00	-30.11	V

HSDPA Band II: (30-20000)MHz

The Worst Test Results for Channel 9262/1852.4MHz

Frequency(MHz)	S G.Lev (dBm)	Ant(dBi)	Loss	PMea	Limit	Margin	Polarity
				(dBm)	(dBm)	(dBm)	
3704.22	-34.81	12.60	12.93	-35.14	-13.00	-22.14	H
5557.38	-35.35	13.10	17.11	-39.36	-13.00	-26.36	H
7409.78	-32.17	11.50	22.20	-42.87	-13.00	-29.87	H
3704.14	-34.65	12.60	12.93	-34.98	-13.00	-21.98	V
5557.52	-35.10	13.10	17.11	-39.11	-13.00	-26.11	V
7409.81	-32.01	11.50	22.20	-42.71	-13.00	-29.71	V

The Worst Test Results for Channel 9400/1880MHz

Frequency(MHz)	S G.Lev (dBm)	Ant(dBi)	Loss	PMea	Limit	Margin	Polarity
				(dBm)	(dBm)	(dBm)	
3760.18	-33.61	12.60	12.93	-33.94	-13.00	-20.94	H
5640.29	-34.02	13.10	17.11	-38.03	-13.00	-25.03	H
7520.10	-32.69	11.50	22.20	-43.39	-13.00	-30.39	H
3760.03	-35.49	12.60	12.93	-35.82	-13.00	-22.82	V
5640.29	-34.92	13.10	17.11	-38.93	-13.00	-25.93	V
7519.86	-32.65	11.50	22.20	-43.35	-13.00	-30.35	V

The Worst Test Results for Channel 9538/1907.6MHz

Frequency(MHz)	S G.Lev (dBm)	Ant(dBi)	Loss	PMea	Limit	Margin	Polarity
				(dBm)	(dBm)	(dBm)	
3815.47	-34.19	12.60	12.93	-34.52	-13.00	-21.52	H
5722.26	-35.25	13.10	17.11	-39.26	-13.00	-26.26	H
7630.09	-32.27	11.50	22.20	-42.97	-13.00	-29.97	H
3815.57	-35.77	12.60	12.93	-36.10	-13.00	-23.10	V
5722.50	-34.65	13.10	17.11	-38.66	-13.00	-25.66	V
7629.86	-32.89	11.50	22.20	-43.59	-13.00	-30.59	V



APPENDIX-PHOTOS OF TEST SETUP

Note: See test photos in setup photo document for the actual connections between Product and support equipment.

※※※※END OF THE REPORT※※※※

