



## FCC - TEST REPORT

Report Number : **68.950.19.0598.01** Date of Issue: **July 18, 2019**

---

Model : **PW07**

---

Product Type : **PowerWatch Series 2**

---

Applicant : **Matrix Industries, Inc.**

---

Address : **1455 Adams Dr, Suite 1190 Menlo Park, CA 94025, USA**

---

Manufacturer : **Matrix Industries, Inc.**

---

Address : **1455 Adams Dr, Suite 1190 Menlo Park, CA 94025, USA**

---

Test Result :  **Positive**     **Negative**

---

Total pages including Appendices : **33**

*TÜV SÜD Certification and Testing (China) Co., Ltd. – Shenzhen Branch is a subcontractor to TÜV SÜD Product Service GmbH according to the principles outlined in ISO 17025.*

*TÜV SÜD Certification and Testing (China) Co., Ltd. – Shenzhen Branch reports apply only to the specific samples tested under stated test conditions. Construction of the actual test samples has been documented. It is the manufacturer's responsibility to assure that additional production units of this model are manufactured with identical electrical and mechanical components. The manufacturer/importer is responsible to the Competent Authorities in Europe for any modifications made to the production units which result in non-compliance to the relevant regulations. TÜV SÜD Certification and Testing (China) Co., Ltd. – Shenzhen Branch shall have no liability for any deductions, inferences or generalizations drawn by the client or others from TÜV SÜD Certification and Testing (China) Co., Ltd. – Shenzhen Branch issued reports.*

*This report is the confidential property of the client. As a mutual protection to our clients, the public and ourselves, extracts from the test report shall not be reproduced except in full without our written approval*



# 1 Table of Contents

1	Table of Contents.....	2
2	Details about the Test Laboratory .....	3
3	Description of the Equipment Under Test.....	4
4	Summary of Test Standards.....	5
5	Summary of Test Results .....	6
6	General Remarks.....	7
7	Test Setups.....	8
8	Systems test configuration .....	9
9	Technical Requirement .....	10
9.1	Conducted Emission Test .....	10
9.2	Conducted peak output power .....	13
9.3	Power spectral density .....	15
9.4	6 dB Bandwidth and 99% Occupied Bandwidth .....	17
9.5	Spurious RF conducted emissions .....	21
9.6	Band edge .....	26
9.7	Spurious radiated emissions for transmitter .....	28
10	Test Equipment List.....	32
11	System Measurement Uncertainty.....	33

## 2 Details about the Test Laboratory

### Details about the Test Laboratory

#### Test Site 1

Company name: TÜV SÜD Certification and Testing (China) Co., Ltd. Shenzhen Branch  
Building 12 & 13, Zhiheng Wisdomland Business Park, Nantou Checkpoint  
Road 2, Nanshan District  
Shenzhen 518052  
P.R. China

Telephone: 86 755 8828 6998

Fax: 86 755 8828 5299

FCC Registration No.: 514049

FCC Designation Number: CA5009

IC Registration No.: 10320A

### 3 Description of the Equipment Under Test

Product:	PowerWatch Series 2
Model no.:	PW07
FCC ID:	2ANY2MPW07
Options and accessories:	Wireless Charger
Rating:	3.85Vdc 340mAh Li-ion Rechargeable battery
RF Transmission Frequency:	2402MHz-2480MHz
No. of Operated Channel:	40
Modulation:	GFSK
Antenna Type:	Integrated antenna
Antenna Gain:	-10.1dBi
Description of the EUT:	The Equipment Under Test (EUT) is a watch which support Bluetooth function operated at 2.4GHz.

## 4 Summary of Test Standards

Test Standards	
FCC Part 15 Subpart C 10-1-2018 Edition	PART 15 - RADIO FREQUENCY DEVICES Subpart C - Intentional Radiators

All the test methods were according to KDB 558074 D01 15.247 Meas Guidance v05r02 and ANSI C63.10 (2013).

## 5 Summary of Test Results

Technical Requirements						
FCC Part 15 Subpart C						
Test Condition	Pages	Test Site	Test Result			
			Pass	Fail	N/A	
§15.207	Conducted emission AC power port	10	Site 1	<input checked="" type="checkbox"/>	<input type="checkbox"/>	<input type="checkbox"/>
§15.247 (b) (1)	Conducted peak output power	13	Site 1	<input checked="" type="checkbox"/>	<input type="checkbox"/>	<input type="checkbox"/>
§15.247(a)(1)	20dB bandwidth	---	---	<input type="checkbox"/>	<input type="checkbox"/>	<input checked="" type="checkbox"/>
§15.247(a)(1)	Carrier frequency separation	---	---	<input type="checkbox"/>	<input type="checkbox"/>	<input checked="" type="checkbox"/>
§15.247(a)(1)(iii)	Number of hopping frequencies	---	---	<input type="checkbox"/>	<input type="checkbox"/>	<input checked="" type="checkbox"/>
§15.247(a)(1)(iii)	Dwell Time	---	---	<input type="checkbox"/>	<input type="checkbox"/>	<input checked="" type="checkbox"/>
§15.247(a)(2)	6dB bandwidth and 99% Occupied Bandwidth	14	Site 1	<input checked="" type="checkbox"/>	<input type="checkbox"/>	<input type="checkbox"/>
§15.247(e)	Power spectral density	15	Site 1	<input checked="" type="checkbox"/>	<input type="checkbox"/>	<input type="checkbox"/>
§15.247(d)	Spurious RF conducted emissions	18	Site 1	<input checked="" type="checkbox"/>	<input type="checkbox"/>	<input type="checkbox"/>
§15.247(d)	Band edge	22	Site 1	<input checked="" type="checkbox"/>	<input type="checkbox"/>	<input type="checkbox"/>
§15.247(d)	Spurious radiated emissions for transmitter	24	Site 1	<input checked="" type="checkbox"/>	<input type="checkbox"/>	<input type="checkbox"/>
§15.203	Antenna requirement	See note 2		<input checked="" type="checkbox"/>	<input type="checkbox"/>	<input type="checkbox"/>

Note 1: N/A=Not Applicable.

Note 2: The EUT uses an Integrated antenna, which gain is -7.95dBi. In accordance to §15.203, it is considered sufficiently to comply with the provisions of this section.

## 6 General Remarks

### Remarks

This submittal(s) (test report) is intended for FCC ID: 2ANY2MPW07 complies with Section 15.207, 15.209, 15.247 of the FCC Part 15, Subpart C rules.

### SUMMARY:

All tests according to the regulations cited on page 5 were

- Performed

- **Not** Performed

The Equipment under Test

- **Fulfills** the general approval requirements.

- **Does not** fulfill the general approval requirements.

Sample Received Date: June 20, 2019

Testing Start Date: July 2, 2019

Testing End Date: July 2, 2019

- TÜV SÜD Certification and Testing (China) Co., Ltd. Shenzhen Branch -

Reviewed by:



John Zhi  
Project Manager

Prepared by:

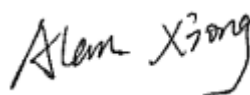

Alan Xiong  
Project Engineer

Tested by:



Tree Zhan  
Test Engineer

## 7 Test Setups

### 7.1 AC Power Line Conducted Emission test setups

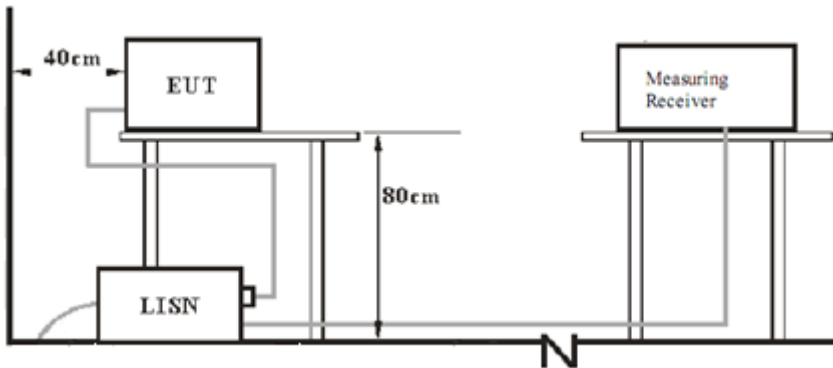

### 7.2 Radiated test setups Below 1GHz

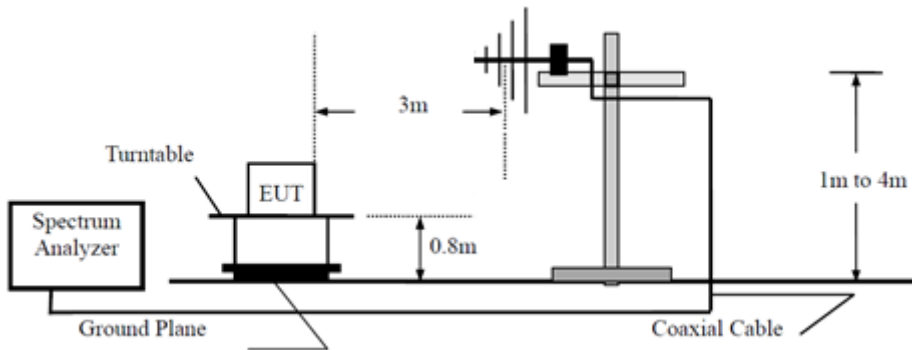

### Above 1GHz

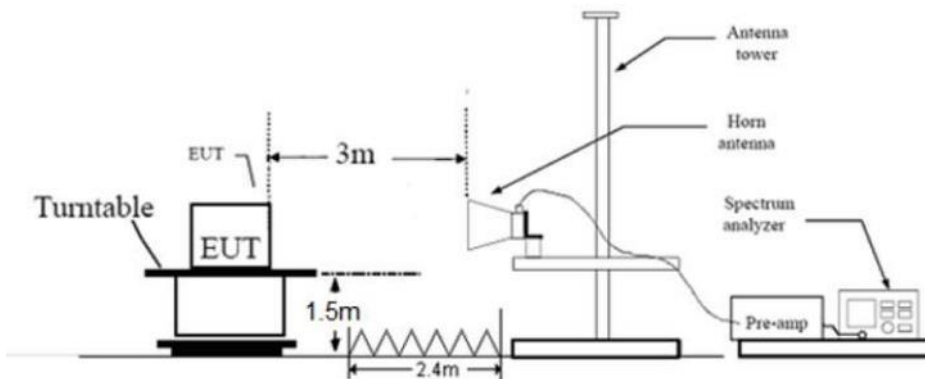

### 7.3 Conducted RF test setups

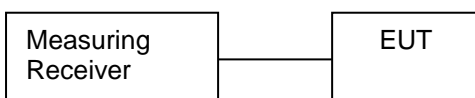



## 8 Systems test configuration

Auxiliary Equipment Used during Test:

DESCRIPTION	MANUFACTURER	MODEL NO.	S/N
Notebook	Lenovo	X240	---
Wireless charger	Matrix Industries, Inc.	TC03	---
Adapter	Apple	A1357	---

Test mode sample have been processed by manufacturer, the operation steps are as follows:

Step 1:

Download the latest Tera Term Software on the target windows system.

Step 2:

Copy provided ".ttl" files to the following folder of the target windows system.

Path: "C:\Program Files (x86)\teraterm"

Step 3:

Connect the EUT (TX, RX, GND) 3 wires to the UART-USB board, then plug it to the computer.

Step 4:

- a) Turn ON the EUT by press and hold lowers left and right buttons 7-8 seconds.
- b) Then the LCD will turn from black to white to indicate the EUT already turn ON.

Step 5:

Open the Tera Term and select the desired COM Port.

Go to Setup Serial Port and set the following settings for the UART.

Baudrate is 921600.

Step 6:

Go to Control / Macro menu. Select the RESET TTL first. Then select the desired test TTL file and hit Open. All test TTL file which were used for FCC testing as below:

- a) HCI\_RESET.ttl
- b) HCI\_LE\_TRANSMITTER\_TEST\_PRBS9-2402.ttl
- c) HCI\_LE\_TRANSMITTER\_TEST\_PRBS9-2440.ttl
- d) HCI\_LE\_TRANSMITTER\_TEST\_PRBS9-2480.ttl

## 9 Technical Requirement

### 9.1 Conducted Emission Test

#### Test Method

1. The EUT was placed on a table, which is 0.8m above ground plane
2. The power line of the EUT is connected to the AC mains through an Artificial Mains Network (A.M.N.).
3. Maximum procedure was performed to ensure EUT compliance
4. A EMI test receiver is used to test the emissions from both sides of AC line

#### Limit

According to §15.207, conducted emissions limit as below:

Frequency MHz	QP Limit dB $\mu$ V	AV Limit dB $\mu$ V
0.150-0.500	66-56*	56-46*
0.500-5	56	46
5-30	60	50

\*Decreasing linearly with logarithm of the frequency

## Conducted Emission

Product Type : PowerWatch Series 2  
 M/N : PW07  
 Operating Condition : Charging Mode  
 Test Specification : Line  
 Comment : AC 120V/60Hz

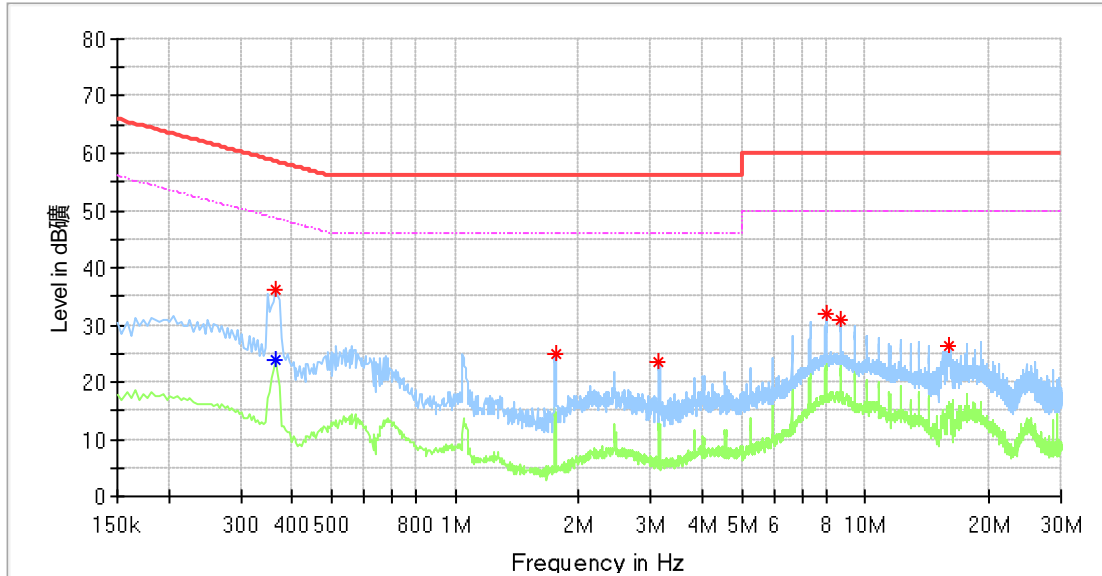

Frequency (MHz)	MaxPeak (dBµV)*	Average (dBµV)	Limit (dBµV)	Margin (dB)	Line	Corr. (dB)**
0.366000	---	23.70	48.59	24.89	L1	10.3
0.366000	36.19	---	58.59	22.40	L1	10.3
1.754000	24.77	---	56.00	31.23	L1	10.3
3.134000	23.48	---	56.00	32.52	L1	10.4
8.022000	32.05	---	60.00	27.95	L1	10.6
8.718000	30.83	---	60.00	29.17	L1	10.6
16.014000	26.16	---	60.00	33.84	L1	10.8

Remark :

\* Max Peak=Reading Level + Correction Factor

\*\*Correction Factor=Cable Loss + LISN Factor

(The Reading Level is recorded by software which is not shown in the sheet)

## Conducted Emission

Product Type : PowerWatch Series 2  
 M/N : PW07  
 Operating Condition : Charging Mode  
 Test Specification : Neutral  
 Comment : AC 120V/60Hz

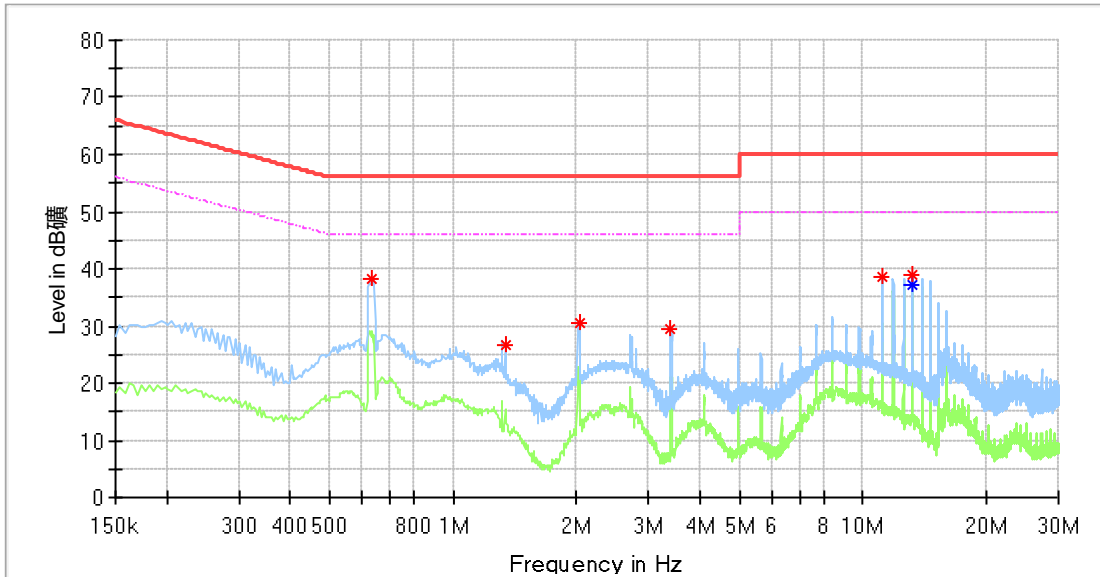

Frequency (MHz)	MaxPeak (dBµV) *	Average (dBµV)	Limit (dBµV)	Margin (dB)	Line	Corr. (dB) **
0.634000	38.19	---	56.00	17.81	N	10.3
1.338000	26.68	---	56.00	29.32	N	10.3
2.030000	30.49	---	56.00	25.51	N	10.3
3.402000	29.41	---	56.00	26.59	N	10.4
11.162000	38.72	---	60.00	21.28	N	10.7
13.254000	38.88	---	60.00	21.12	N	10.8
13.254000	---	37.24	50.00	12.76	N	10.8

Remark :

\* Max Peak=Reading Level + Correction Factor

\*\*Correction Factor=Cable Loss + LISN Factor

(The Reading Level is recorded by software which is not shown in the sheet)

## 9.2 Conducted peak output power

### Test Method

1. The RF output of EUT was connected to the test receiver by RF cable. The path loss was compensated to the results for each measurement.
2. Set to the maximum power setting and enable the EUT transmit continuously
3. Use the following test receiver settings:  
Span = approximately 5 times the 6dB bandwidth, centered on a hopping channel  
RBW > the 6dB bandwidth of the emission being measured, VBW $\geq$ 3RBW,  
Sweep = auto, Detector function = peak, Trace = max hold
4. Allow the trace to stabilize. Use the marker-to-peak function to set the marker to the peak of the emission. The indicated level is the peak output power and record the results in the test report.
5. Repeat above procedures until all frequencies measured were complete.

### Limits

According to §15.247 (b) (1), conducted peak output power limit as below:

Frequency Range MHz	Limit W	Limit dBm
2400-2483.5	$\leq 1$	$\leq 30$

Test result as below table

Frequency MHz	Conducted Peak Output Power dBm	Result
Bottom channel 2402MHz	1.66	Pass
Middle channel 2440MHz	1.38	Pass
Top channel 2480MHz	1.13	Pass

BLE\_BT4.0\_Ant1\_2402

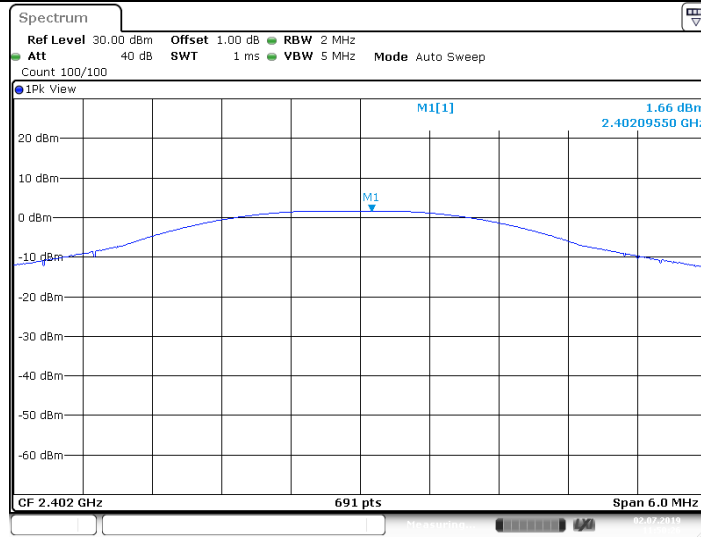

BLE\_BT4.0\_Ant1\_2440

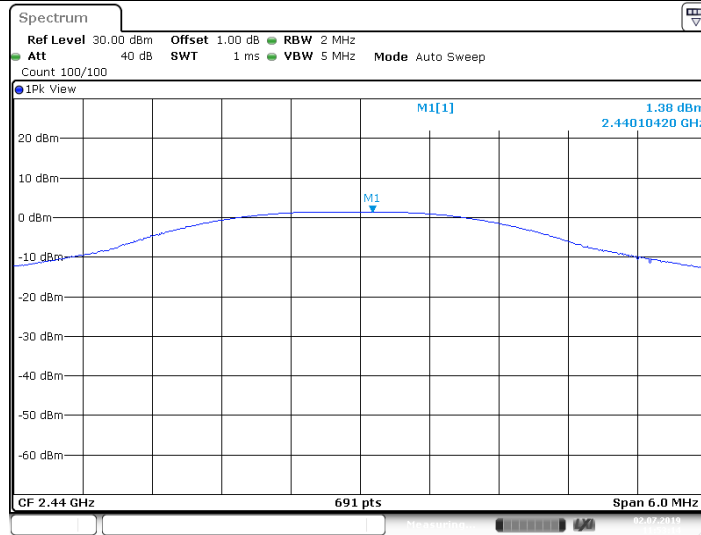

BLE\_BT4.0\_Ant1\_2480

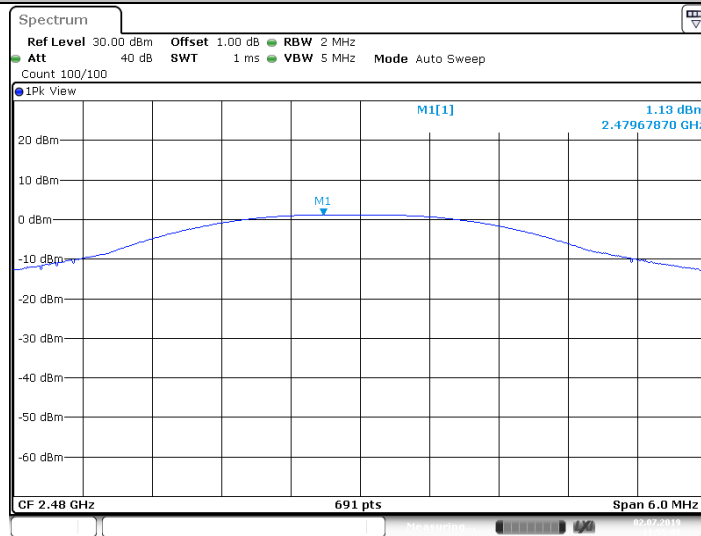

### 9.3 Power spectral density

#### Test Method

1. The RF output of EUT was connected to the test receiver by RF cable. The path loss was compensated to the results for each measurement.
2. Set to the maximum power setting and enable the EUT transmit continuously
3. Set analyzer center frequency to DTS channel center frequency. RBW=3kHz, VBW≥3RBW, Span=1.5 times DTS bandwidth, Detector=Peak, Sweep=auto, Trace= max hold.
4. Allow the trace to stabilize. Use the marker-to-peak function to set the marker to the peak of the emission. The indicated level is the peak output power and record the results in the test report.
5. Repeat above procedures until other frequencies measured were completed.

#### Limit

Limit [dBm/3KHz]

---

≤8

#### Test result

Frequency MHz	Power spectral density dBm/3KHz	Result
Bottom channel 2402MHz	-13.94	Pass
Middle channel 2440MHz	-14.20	Pass
Top channel 2480MHz	-14.92	Pass

BLE\_BT4.0\_Ant1\_2402

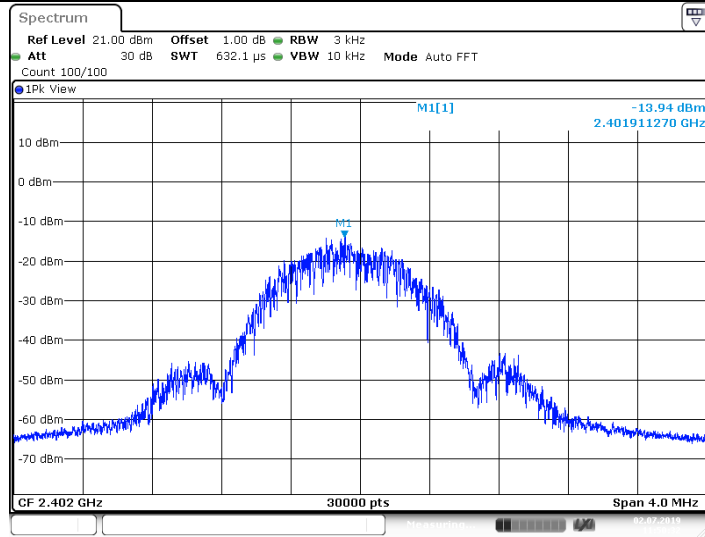

Date: 2 JUL 2019 11:50:32

BLE\_BT4.0\_Ant1\_2440

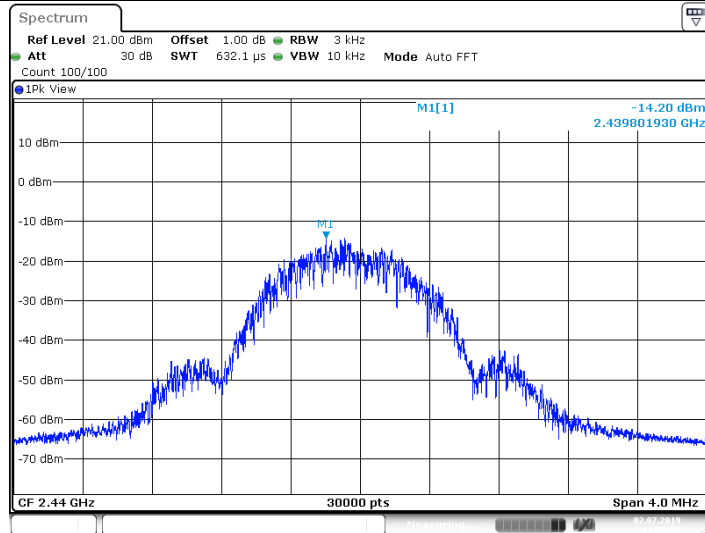

Date: 2 JUL 2019 11:53:20

BLE\_BT4.0\_Ant1\_2480

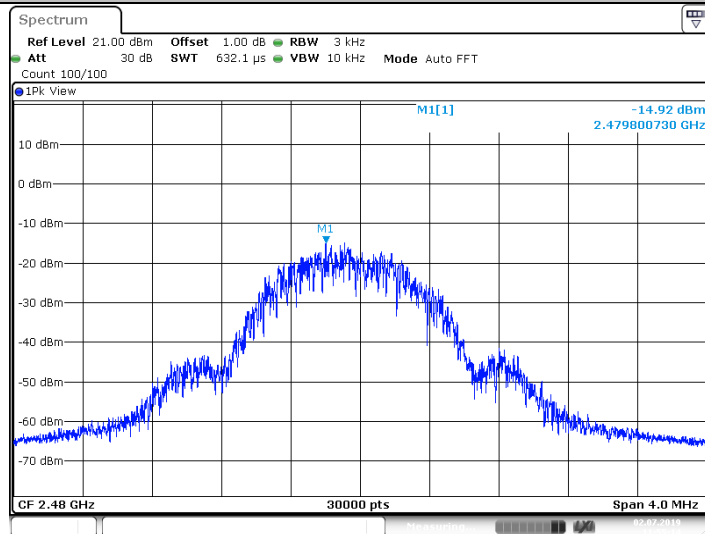

Date: 2 JUL 2019 11:55:14



## 9.4 6 dB Bandwidth and 99% Occupied Bandwidth

### Test Method

1. The RF output of EUT was connected to the test receiver by RF cable. The path loss was compensated to the results for each measurement.
2. Set to the maximum power setting and enable the EUT transmit continuously.
3. Use the following test receiver settings:  
 Span = approximately 5 times the 6dB bandwidth, centered on a hopping channel  
 RBW =100KHz, VBW≥3RBW,  
 Sweep = auto, Detector function = peak, Trace = max hold
4. Allow the trace to stabilize. Use the marker-to-peak function to set the marker to the peak of the emission. Measure the frequency difference of two frequencies that were attenuated 6 dB from the reference level. Record the frequency difference as the emission bandwidth. Record the results.
5. Repeat above procedures until all frequencies measured were complete.

### Limit

Limit [kHz]

≥500

### Test result

Frequency MHz	6dB bandwidth kHz	99% bandwidth kHz	Result
Bottom channel 2402MHz	684	1039	Pass
Middle channel 2440MHz	728	1059	Pass
Top channel 2480MHz	728	1079	Pass

**6 dB Bandwidth**

Low channel 2402MHz

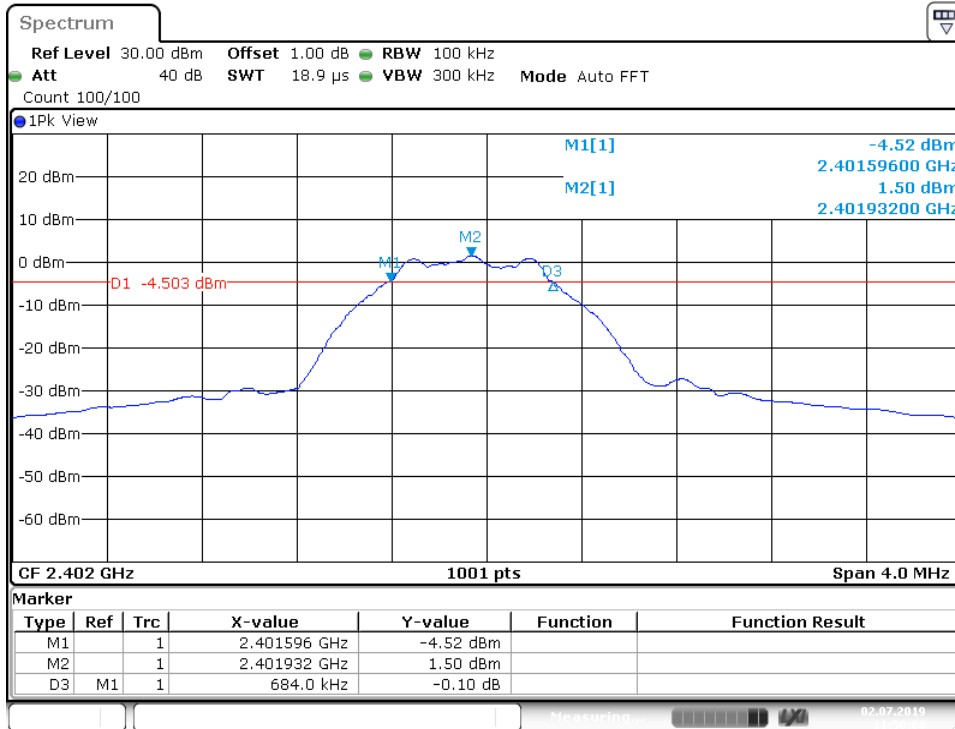

Date: 2 JUL 2019 11:50:08

Middle channel 2440MHz

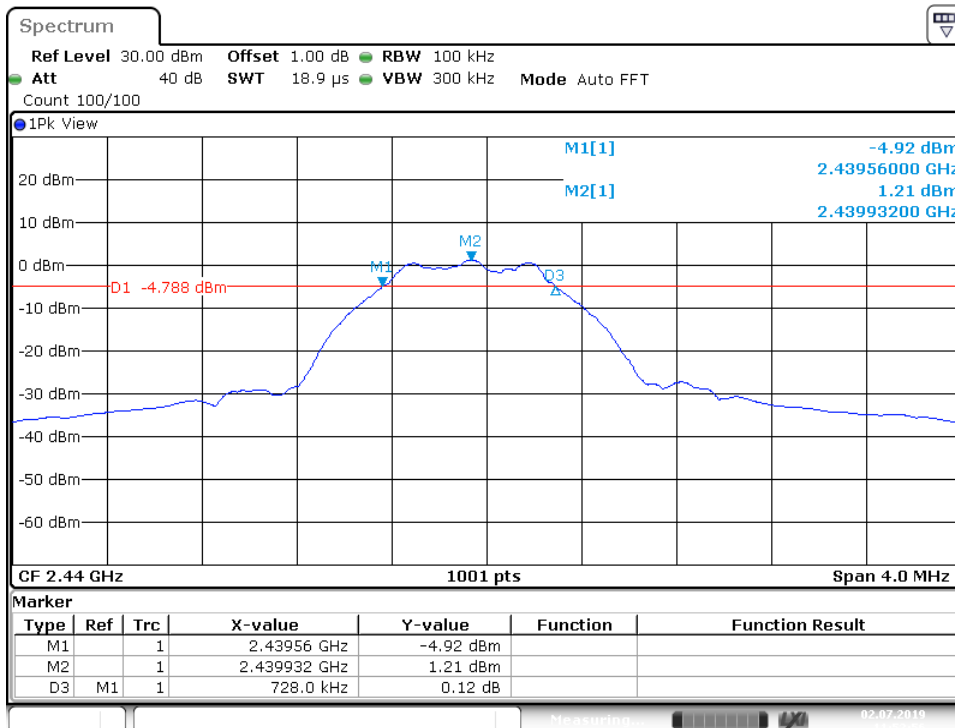

Date: 2 JUL 2019 11:52:56

### 6 dB Bandwidth

#### High channel 2480MHz

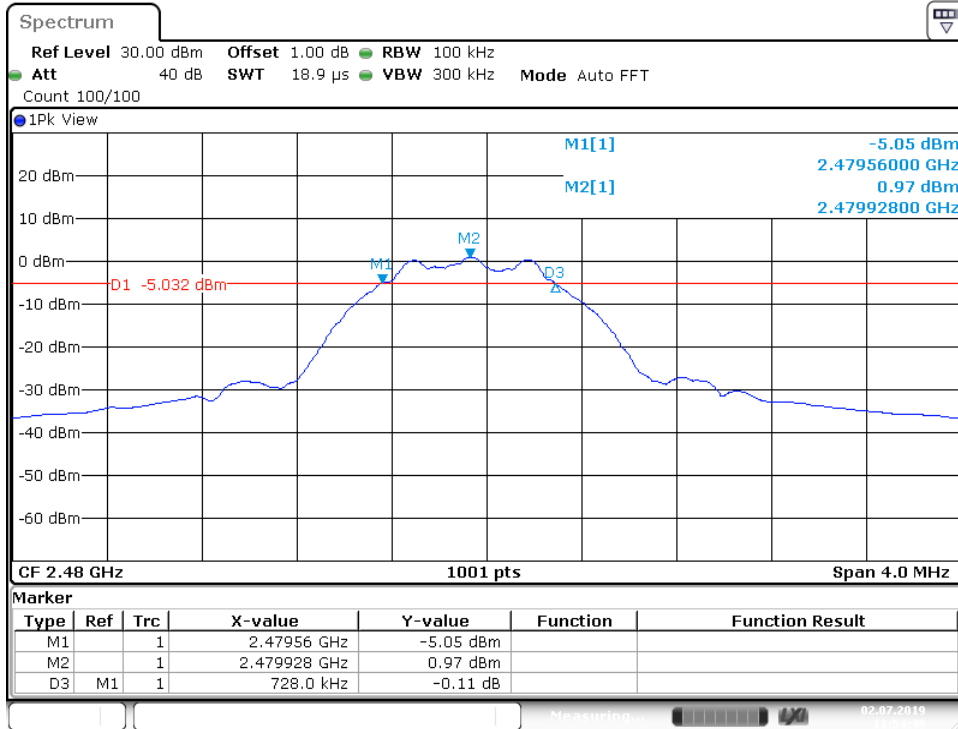

Date: 2 JUL 2019 11:54:50

### 99% Bandwidth

#### Low channel 2402MHz

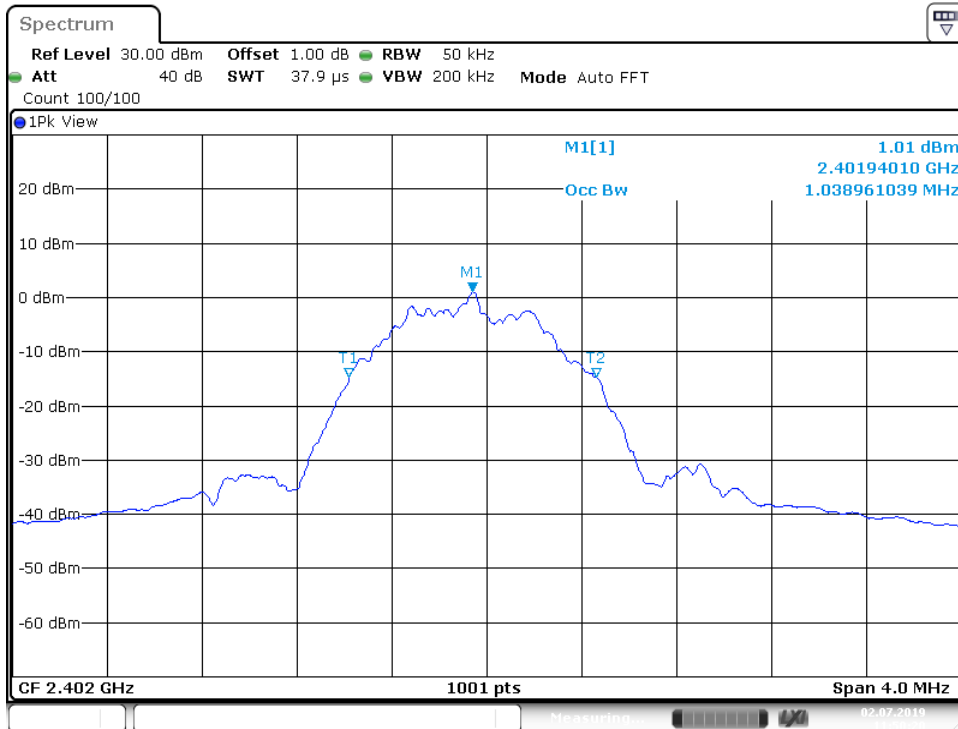

Date: 2 JUL 2019 11:50:19

**99% Bandwidth**

Middle channel 2440MHz

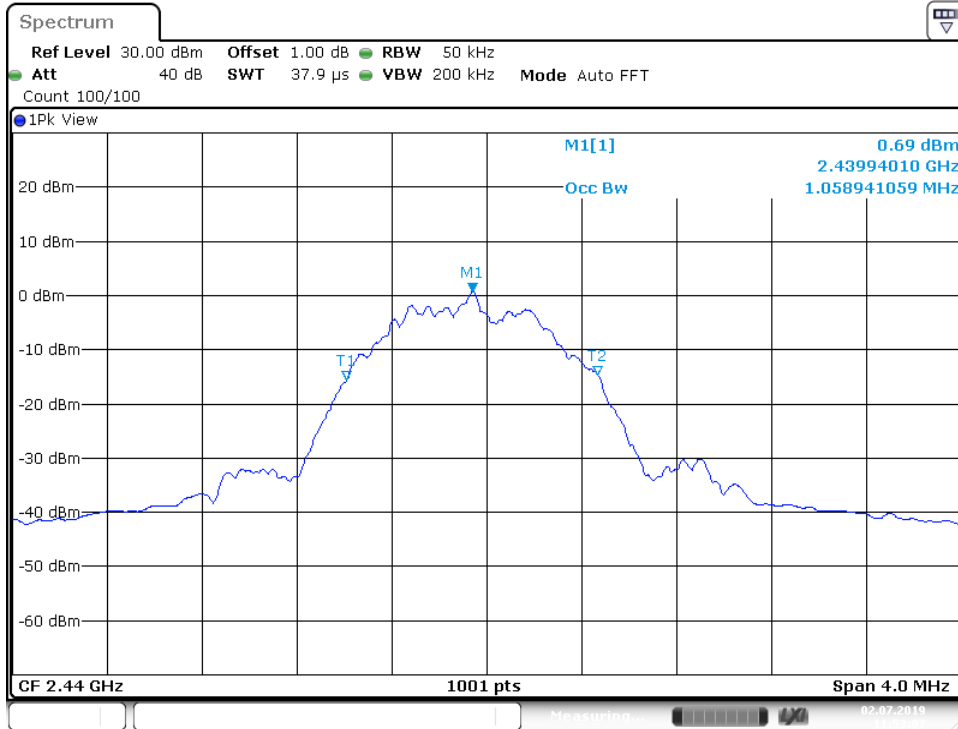

Date: 2 JUL 2019 11:53:07

High channel 2480MHz

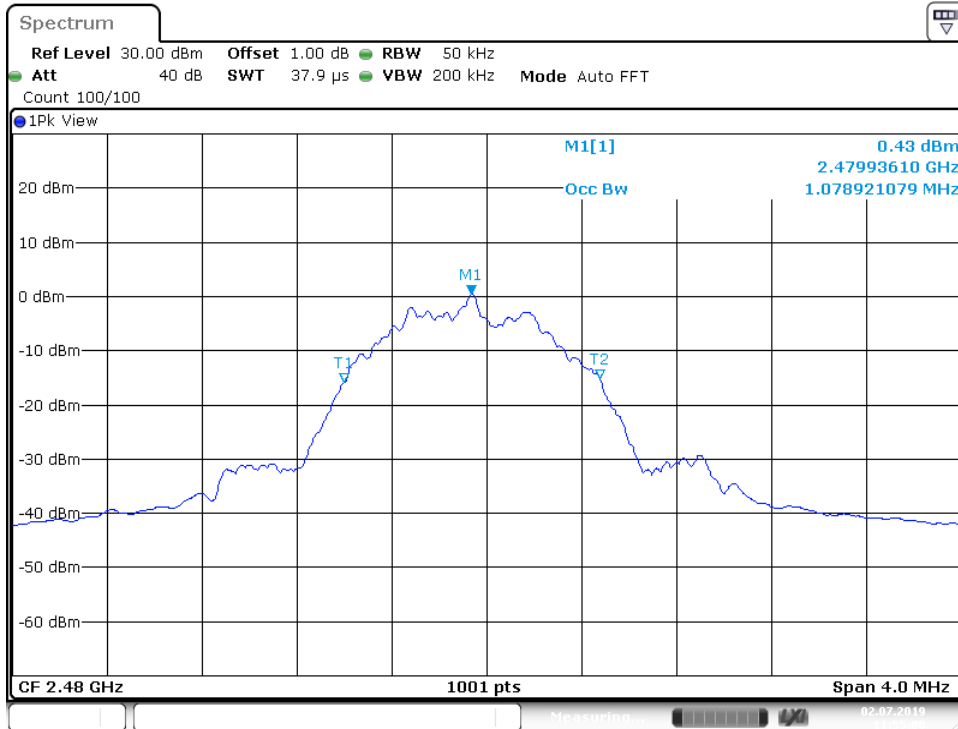

Date: 2 JUL 2019 11:55:01

## 9.5 Spurious RF conducted emissions

### Test Method

1. The RF output of EUT was connected to the spectrum analyzer by RF cable. The path loss was compensated to the results for each measurement.
2. Set to the maximum power setting and enable the EUT transmit continuously.
3. Set RBW = 100 kHz, VBW=300 kHz, Peak Detector. Unwanted Emissions measured in any 100 kHz bandwidth outside of the authorized frequency band shall be attenuated by at least 20 dB relative to the maximum in-band peak PSD level in 100 kHz when maximum peak conducted output power procedure is used. If the transmitter complies with the conducted power limits based on the use of RMS averaging over a time interval, the attenuation required under this paragraph shall be 30 dB instead of 20 dB.
4. Measure and record the results in the test report.
5. The RF fundamental frequency should be excluded against the limit line in the operating frequency

### Limit

Frequency Range MHz	Limit (dBc)
30-25000	-20

### Spurious RF conducted emissions

TestMode	Antenna	Channel (MHz)	FreqRange (MHz)	RefLevel	Result (dBm)	Limit (dBm)	Verdict
BLE_BT4.0	Ant1	2402	Reference	1.41	1.41	---	PASS
		2402	30~1000	30~1000	-61.92	<=-18.59	PASS
		2402	1000~26500	1000~26500	-45.53	<=-18.59	PASS
		2440	Reference	1.30	1.30	---	PASS
		2440	30~1000	30~1000	-62.02	<=-18.7	PASS
		2440	1000~26500	1000~26500	-37.24	<=-18.7	PASS
		2480	Reference	0.89	0.89	---	PASS
		2480	30~1000	30~1000	-61.61	<=-19.11	PASS
		2480	1000~26500	1000~26500	-50.98	<=-19.11	PASS

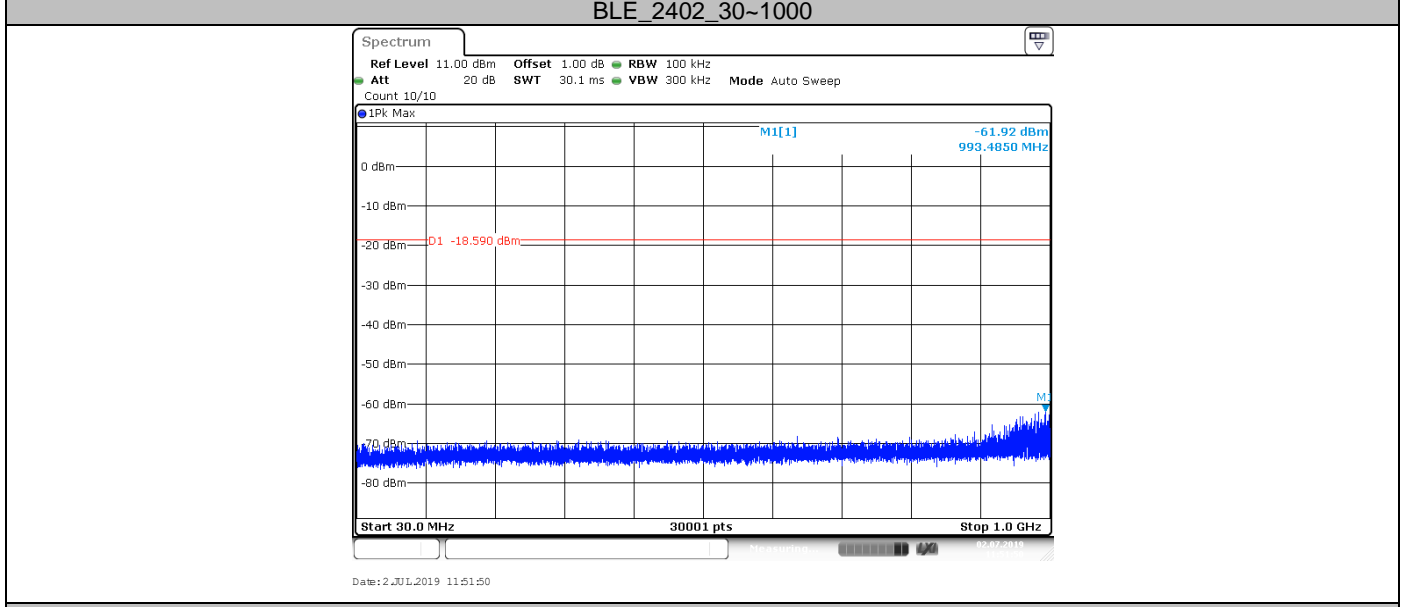
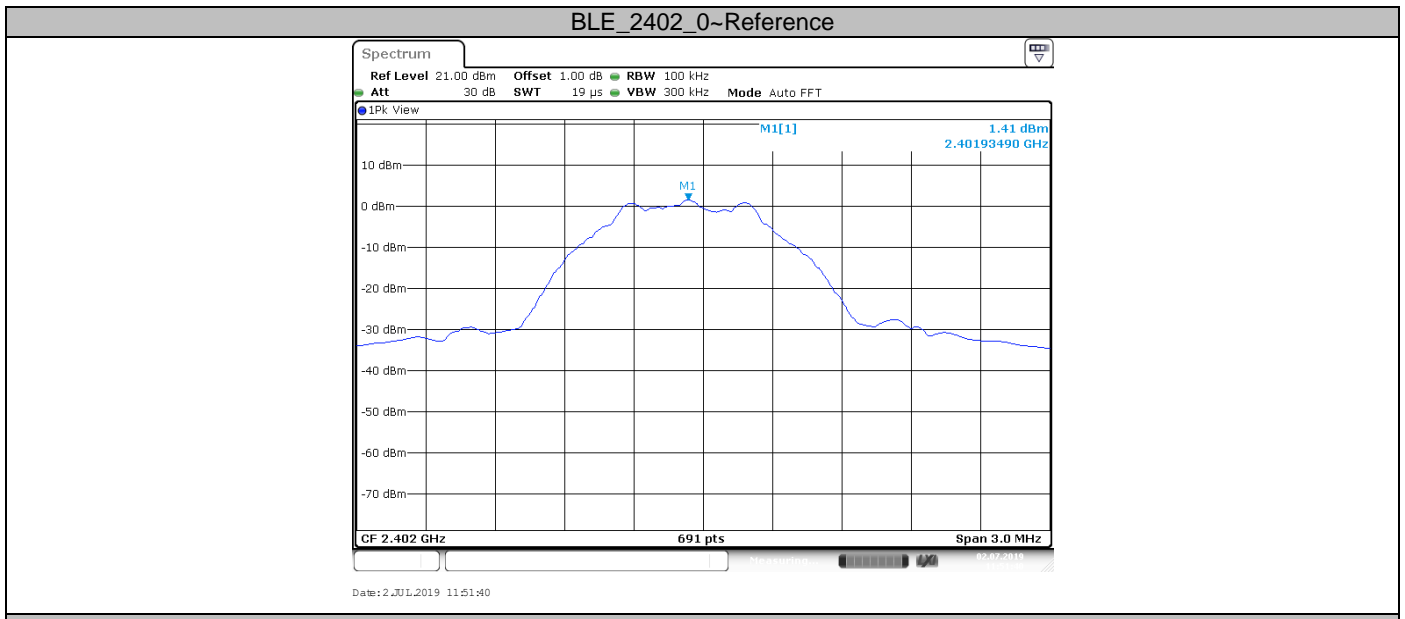

**BLE\_2402\_1000~26500**

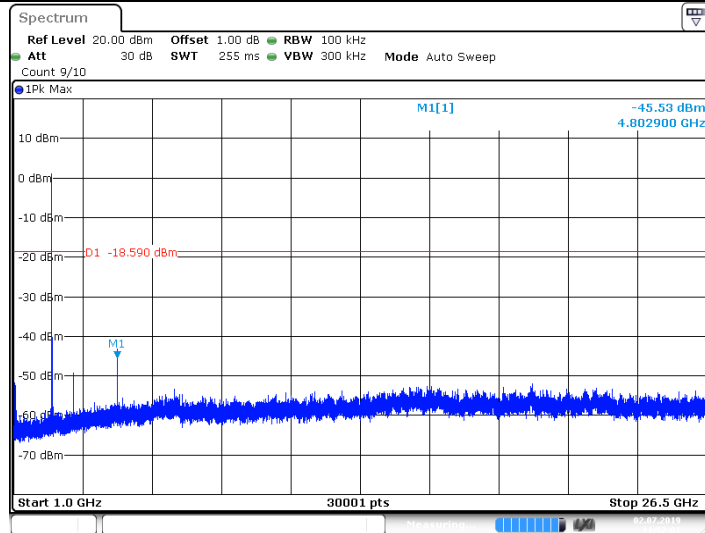

Date: 2 JUL 2019 11:52:01

### BLE\_2440\_0~Reference

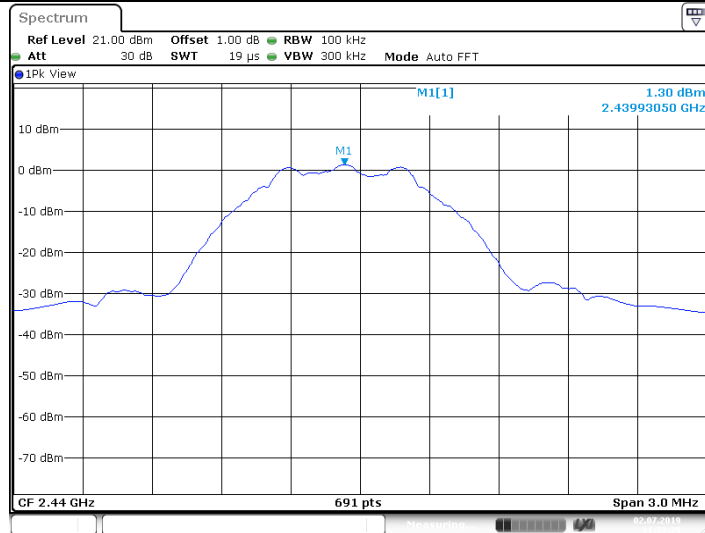

Date: 2 JUL 2019 11:53:26

### BLE\_2440\_30~1000

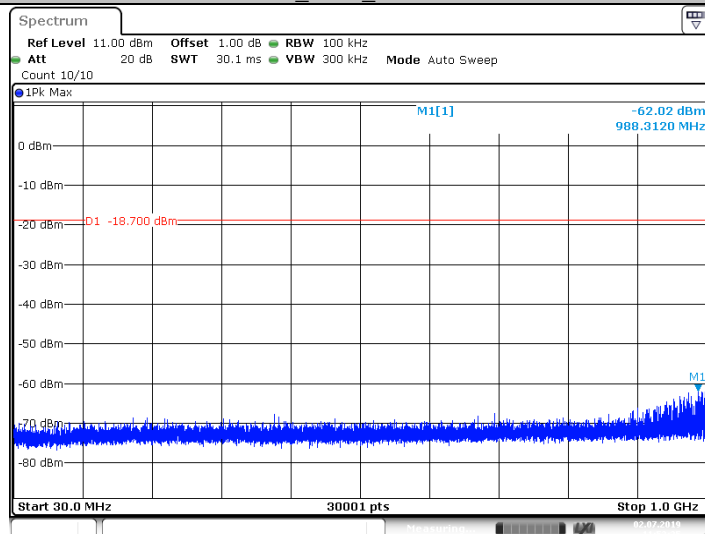

Date: 2 JUL 2019 11:53:36

### BLE\_2440\_1000~26500

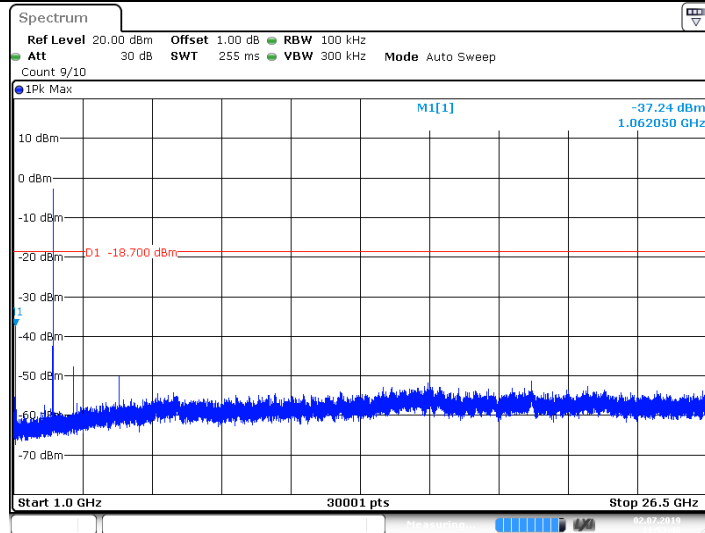

Date: 2 JUL 2019 11:53:47

### BLE\_2480\_0~Reference

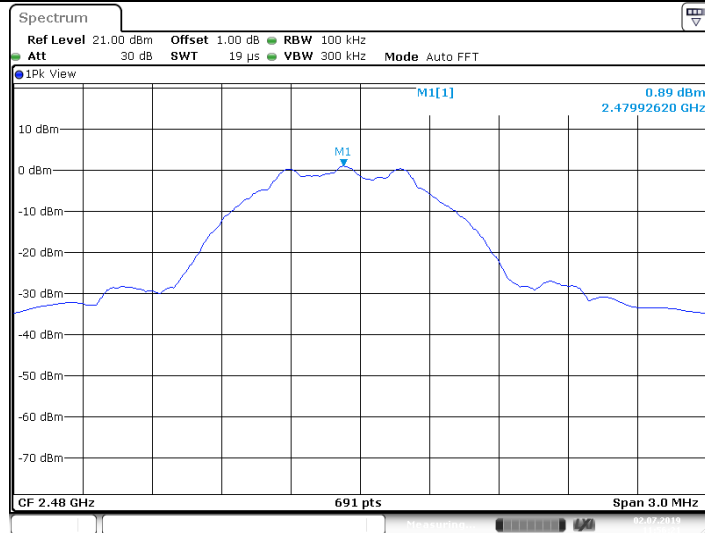

Date: 2 JUL 2019 11:56:21

### BLE\_2480\_30~1000

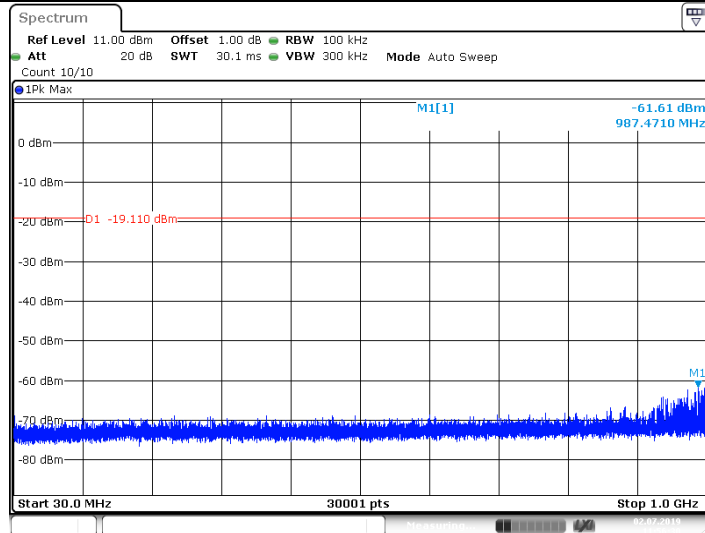

Date: 2 JUL 2019 11:56:30

### BLE\_2480\_1000~26500



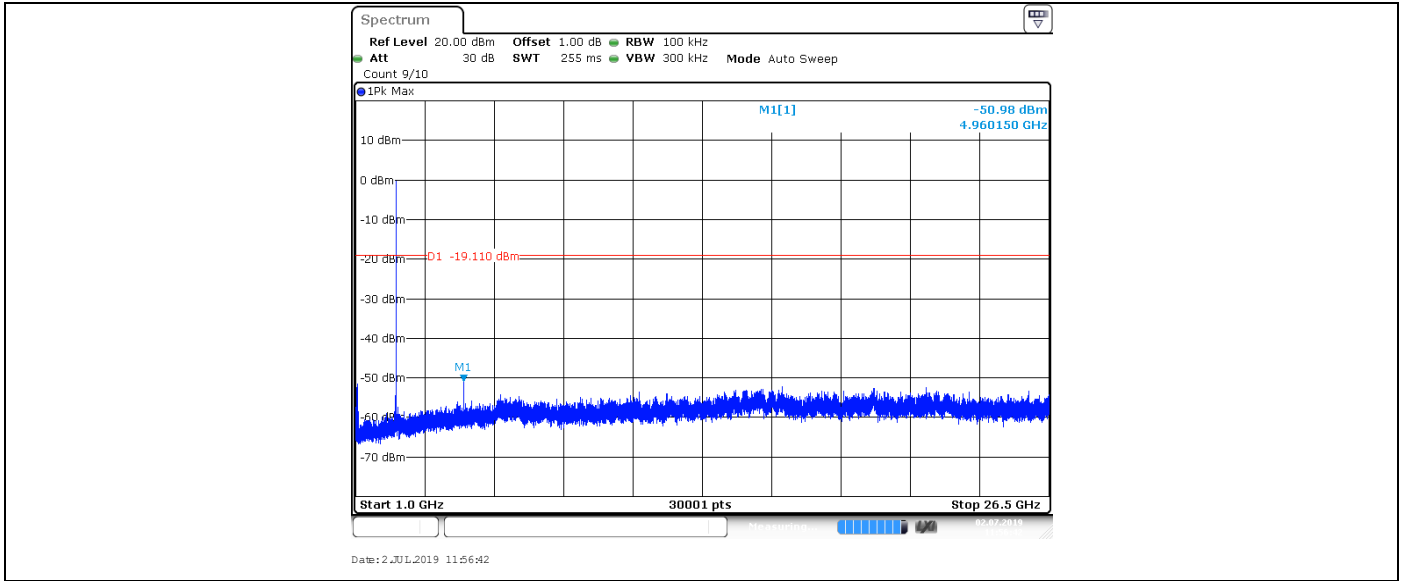

## 9.6 Band edge

### Test Method

1. The RF output of EUT was connected to the spectrum analyzer by RF cable. The path loss was compensated to the results for each measurement.
2. Set to the maximum power setting and enable the EUT transmit continuously.
3. Set RBW = 100 kHz, VBW=300 kHz, Peak Detector. Unwanted Emissions measured in any 100 kHz bandwidth outside of the authorized frequency band shall be attenuated by at least 20 dB relative to the maximum in-band peak PSD level in 100 kHz when maximum peak conducted output power procedure is used. If the transmitter complies with the conducted power limits based on the use of RMS averaging over a time interval, the attenuation required under this paragraph shall be 30 dB instead of 20 dB.
4. Measure and record the results in the test report.
5. The RF fundamental frequency should be excluded against the limit line in the operating frequency
6. Set to the maximum power setting and enable the EUT hopping mode, repeat the test.

### Limit

Frequency Range MHz	Limit (dBc)
30-25000	-20

### Band edge testing

TestMode	Antenna	ChName	Channel (MHz)	RefLevel (dBm)	Result (dBm)	Limit (dBm)	Verdict
BLE_BT4.0	Ant1	Low	2402	1.40	-37.63	<=-18.6	PASS
		High	2480	0.86	-41.69	<=-19.14	PASS

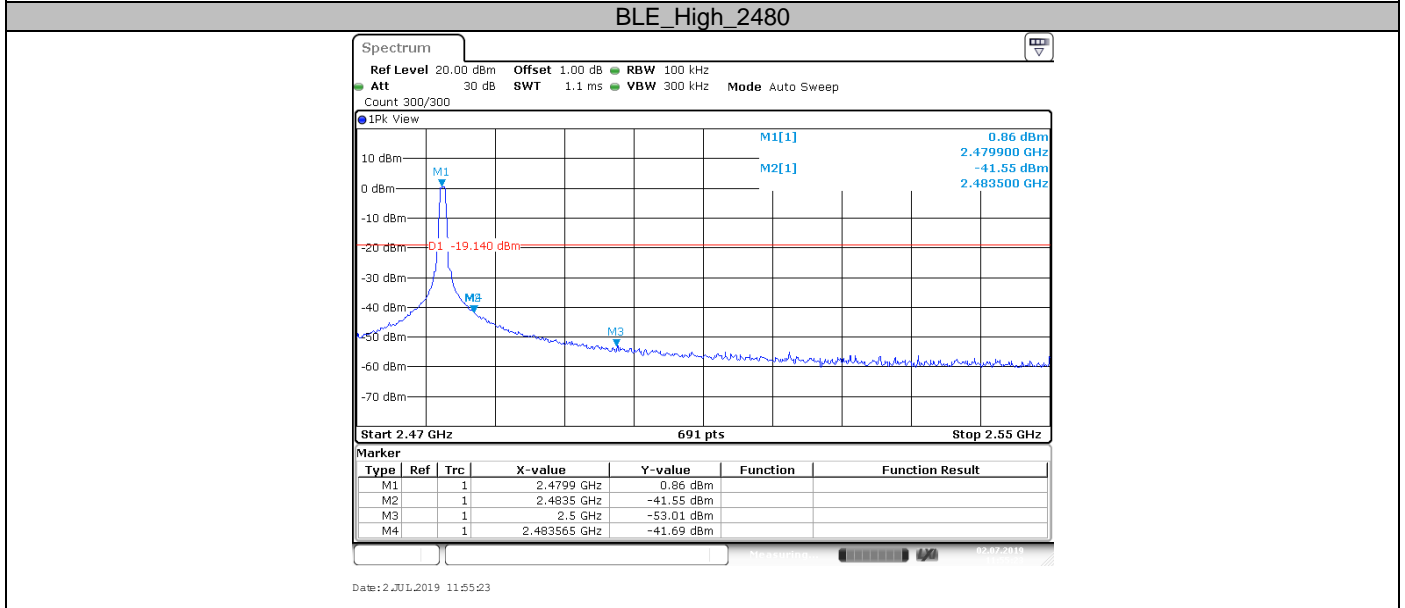
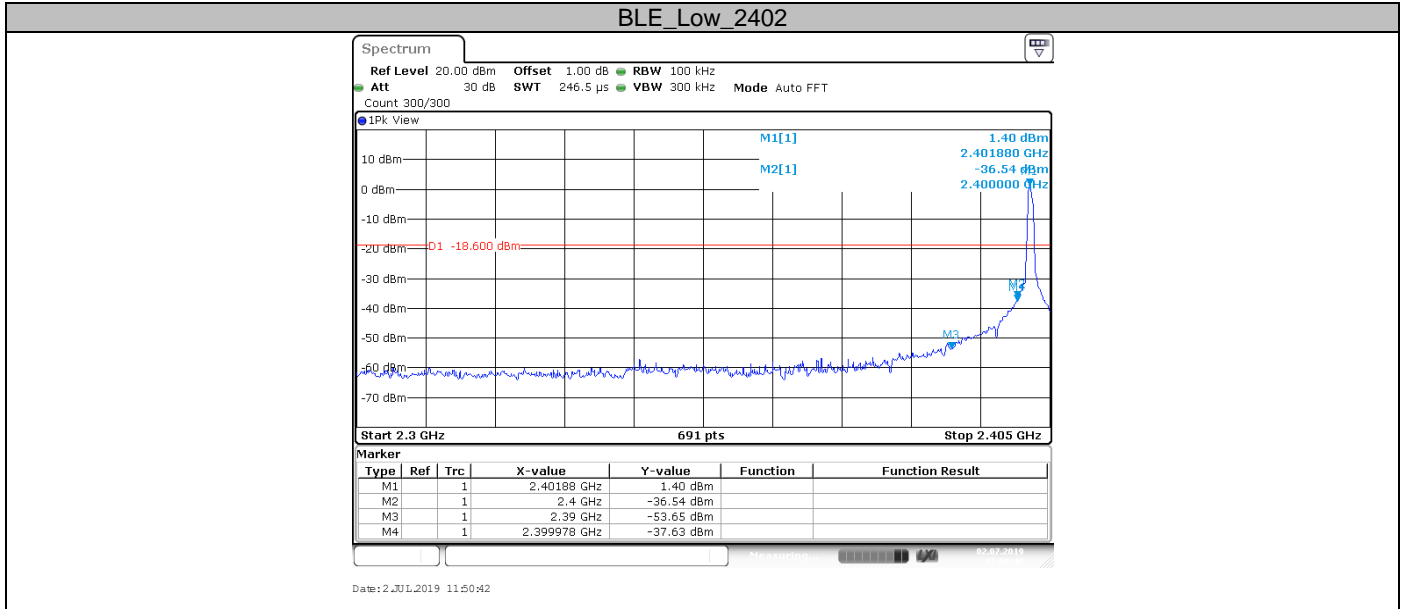

## 9.7 Spurious radiated emissions for transmitter

### Test Method

1. The EUT was placed on a turn table which is 1.5m above ground plane for above 1GHz and 0.8m above ground for below 1GHz at 3 meters chamber room for test. The table was rotated 360 degrees to determine the position of the highest radiation.
2. Set to the maximum power setting and enable the EUT transmit continuously
3. The EUT was set 3 meters away from the interference – receiving antenna, which was mounted on the top of a variable – height antenna tower.
4. The height of antenna is varied from one meter to four meters above the ground to determine the maximum value of the field strength. Both horizontal and vertical polarizations of the antenna are set to make the measurement.
5. For each suspected emission, the EUT was arranged to its worst case and then the antenna was tuned to heights from 1 meter to 4 meters and the rotatable table was turned from 0 degrees to 360 degrees to find the maximum reading.
6. Use the following spectrum analyzer settings According to C63.10:  
 For Peak unwanted emissions Above 1GHz:  
 Span = wide enough to capture the peak level of the in-band emission and all spurious  
 RBW = 1MHz, VBW $\geq$ RBW for peak measurement, Sweep = auto, Detector function = peak, Trace = max hold.  
 For Below 1GHz  
 Use the following spectrum analyzer settings:  
 Span = wide enough to capture the peak level of the in-band emission and all spurious  
 RBW = 100 KHz to 120KHz, VBW $\geq$ RBW for peak measurement, Sweep = auto, Detector function = peak, Trace = max hold.
7. Procedures for average unwanted emissions measurements above 1000 MHz
  - a) RBW = 1 MHz.
  - b) VBW \ [3 x RBW].
  - c) Detector = RMS (power averaging), if [span / (# of points in sweep)] \ RBW / 2. Satisfying this condition can require increasing the number of points in the sweep or reducing the span. If the condition is not satisfied, then the detector mode shall be set to peak.
  - d) Averaging type = power (i.e., rms) (As an alternative, the detector and averaging type may be set for linear voltage averaging. Some instruments require linear display mode to use linear voltage averaging. Log or dB averaging shall not be used.)
  - e) Sweep time = auto.
  - f) Perform a trace average of at least 100 traces if the transmission is continuous. If the transmission is not continuous, then the number of traces shall be increased by a factor of 1 / D, where D is the duty cycle. For example, with 50% duty cycle, at least 200 traces shall be averaged. (If a specific emission is demonstrated to be continuous—i.e., 100% duty cycle—then rather than turning ON and OFF with the transmit cycle, at least 100 traces shall be averaged.)
  - g) If tests are performed with the EUT transmitting at a duty cycle less than 98%, then a correction factor shall be added to the measurement results prior to comparing with the emission limit, to compute the emission level that would have been measured had the test been performed at 100% duty cycle. The correction factor is computed as follows:
    - 1) If power averaging (rms) mode was used in the preceding step e), then the correction factor is [10 log (1 / D)], where D is the duty cycle. For example, if the transmit duty cycle was 50%, then 3 dB shall be added to the measured emission levels.

- 2) If linear voltage averaging mode was used in the preceding step e), then the correction factor is  $[20 \log (1 / D)]$ , where D is the duty cycle. For example, if the transmit duty cycle was 50%, then 6 dB shall be added to the measured emission levels.
  - 3) If a specific emission is demonstrated to be continuous (100% duty cycle) rather than turning ON and OFF with the transmit cycle, then no duty cycle correction is required for that emission.
8. Repeat above procedures until all frequencies measured were complete.

## Spurious radiated emissions for transmitter

### Limit

The radio emission outside the operating frequency band shall be at least 20 dB below that in the 100 kHz bandwidth within the band that contains the highest level of the desired power. Radiated emissions which fall in the restricted bands, as defined in section 15.205, must comply with the radiated emission limits specified in section 15.209.

Frequency MHz	Field Strength uV/m	Field Strength dB $\mu$ V/m	Detector
30-88	100	40	QP
88-216	150	43.5	QP
216-960	200	46	QP
960-1000	500	54	QP
Above 1000	500	54	AV
Above 1000	5000	74	PK

## Spurious radiated emissions for transmitter

According to C63.10, if the peak (or quasi-peak) measured value complies with the average limit, it is unnecessary to perform an average measurement, so AV emission value did not show in below table if the peak value complies with average limit.

### Low channel 2402MHz Test Result

Frequency Band	Frequency	Emission Level	Polarization	Limit	Detector	Margin	Correct factor	Result
	MHz	dBuV/m		dBuV/m		dBuV/m	(dB)	
30-1000MHz	52.36	21.68	H	40	QP	18.32	-24.6	Pass
	110.03	19.11	H	43.5	QP	24.39	-27.1	Pass
	239.47	21.70	H	43.5	QP	24.30	-24.1	Pass
	871.26	32.53	H	46	QP	13.47	-16.0	Pass
	Other Frequencies	--	H	--	QP	--	--	Pass
	60.77	21.22	V	40	QP	18.78	-27.0	Pass
	103.24	19.06	V	43.5	QP	24.44	-27.5	Pass
	226.05	23.06	V	46	QP	22.94	-23.6	Pass
	882.52	32.93	V	46	QP	13.07	-15.8	Pass
	Other Frequencies	--	V	--	QP	--	--	Pass
1000-2500MHz	7020.13	38.61	H	74	PK	35.39	5.5	Pass
	15827.72	47.94	H	74	PK	26.06	18.2	Pass
	Other Frequencies	--	H	--	PK	--	--	Pass
	7004.19	36.74	V	74	PK	37.26	5.3	Pass
	13115.16	43.54	V	74	PK	30.46	13.8	Pass
	Other Frequencies	--	V	--	PK	--	--	Pass

#### Remark:

- (1) "\*" means the emission(s) appear within the restrict bands shall follow the requirement of section 15.205.
- (2) Data of measurement within this frequency range shown "--" in the table above means the reading of emissions are the noise floor or attenuated more than 20dB below the permissible limits or the field strength is too small to be measured.
- (3) We test Low channel, Middle channel and High channel, only the worse case recorded in this report.
- (4) Corrected Amplitude = Read level + Corrector factor  
 Above 1GHz: Corrector factor = Antenna Factor + Cable Loss- Amplifier Gain  
 Below 1GHz: Corrector factor = Antenna Factor + Cable Loss

## 10 Test Equipment List

### List of Test Instruments

#### Radiated Emission Test

DESCRIPTION	MANUFACTURER	MODEL NO.	SERIAL NO.	CAL. DUE DATE
EMI Test Receiver	Rohde & Schwarz	ESR 26	101269	2020-6-28
Trilog Super Broadband Test Antenna	Schwarzbeck	VULB 9163	707	2020-6-28
Horn Antenna	Rohde & Schwarz	HF907	102294	2020-6-22
Loop Antenna	Rohde & Schwarz	HFH2-Z2	100398	2020-7-7
Pre-amplifier	Rohde & Schwarz	SCU 18	102230	2020-6-28
Signal Generator	Rohde & Schwarz	SMY01	839369/005	2020-6-28
Attenuator	Agilent	8491A	MY39264334	2020-6-28
3m Semi-anechoic chamber	TDK	9X6X6	----	2020-7-7

#### Conducted Emission Test

DESCRIPTION	MANUFACTURER	MODEL NO.	SERIAL NO.	CAL. DUE DATE
EMI Test Receiver	Rohde & Schwarz	ESR 3	101782	2020-6-28
LISN	Rohde & Schwarz	ENV4200	100249	2020-6-28
Attenuator	Shanghai Huaxiang	TS2-26-3	080928189	2020-6-28
Test software	Rohde & Schwarz	EMC32	Version9.15.00	N/A

#### Conducted RF Test System

DESCRIPTION	MANUFACTURER	MODEL NO.	SERIAL NO.	CAL. DUE DATE
Signal Analyzer	Rohde & Schwarz	FSV40	101030	2020-6-28
RF Switch Module	Rohde & Schwarz	OSP120/OSP-B157	101226/100851	2020-6-28
Power Splitter	Weinschel	1580	SC319	2020-7-7
Test software	Tonscend	System for BT/WIFI	Version 2.5.77.0418	N/A



## 11 System Measurement Uncertainty

For a 95% confidence level, the measurement expanded uncertainties for defined systems, in accordance with the recommendations of ISO 17025 were:

System Measurement Uncertainty	
Test Items	Extended Uncertainty
Uncertainty for Conducted Emission 150kHz-30MHz (for test using AMN ENV432 or ENV4200)	3.21dB
Uncertainty for Radiated Spurious Emission 25MHz-3000MHz	Horizontal: 4.91dB; Vertical: 4.89dB;
Uncertainty for Radiated Spurious Emission 3000MHz-18000MHz	Horizontal: 4.80dB; Vertical: 4.79dB;
Uncertainty for Radiated Spurious Emission 18000MHz-40000MHz	Horizontal: 5.05dB; Vertical: 5.04dB;
Uncertainty for Conducted RF test with TS 8997	RF Power Conducted: 1.16dB Frequency test involved: $0.6 \times 10^{-7}$ or 1%