

# FCC RADIO TEST REPORT

## FCC ID: 2ANXU-SB6085

**Product :** FLOOR STAND TURNTABLE WITH BLUETOOTH RECEIVER, CD PLAYER AND FM RADIO

**Trade Name :** Studebaker

**Model Name/HVIN(s) :** MT229

**Serial Model :** SB6085, SB6085TE, SB6085RD,  
SB6085XXXXX

**Report No. :** UNIA20101709ER-01

### Prepared for

Shenzhen Jiayinking Technology Holding Company., Limited  
No.11, 11-1, Anye Road, Anliang village, Henggang Town,  
Longgang District, Shenzhen, China.

### Prepared by

Shenzhen United Testing Technology Co., Ltd.  
2F, Annex Bldg, Jiahuangyuan Tech Park, #365 Baotian 1 Rd, Tiegang  
Community, Xixiang Str, Bao'an District, Shenzhen, China

## TEST RESULT CERTIFICATION

**Applicant's name**.....: Shenzhen Jiayingking Technology Holding Company., Limited  
**Address**.....: No.11, 11-1, Anye Road, Anliang village, Henggang Town, Longgang District, Shenzhen, China.  
**Manufacturer's Name**.....: Shenzhen Jiayingking Technology Holding Company., Limited  
**Address**.....: No.11, 11-1, Anye Road, Anliang village, Henggang Town, Longgang District, Shenzhen, China.

### Product description

**Product name**.....: FLOOR STAND TURNTABLE WITH BLUETOOTH RECEIVER, CD PLAYER AND FM RADIO  
**Trade Mark**.....: Studebaker  
**Model and/or type reference** : MT229, SB6085, SB6085TE, SB6085RD, SB6085XXXXX  
**Standards**.....: FCC Rules and Regulations Part 15 Subpart C Section 15.247, ANSI C63.10: 2013

This device described above has been tested by Shenzhen United Testing Technology Co., Ltd., and the test results show that the equipment under test (EUT) is in compliance with the FCC requirements. And it is applicable only to the tested sample identified in the report.

This report shall not be reproduced except in full, without the written approval of UNI, this document may be altered or revised by Shenzhen United Testing Technology Co., Ltd., personnel only, and shall be noted in the revision of the document.

**Date of Test**.....:   
**Date (s) of performance of tests**.....: Nov. 02 ~ 12, 2020  
**Date of Issue**.....: Nov. 13, 2020  
**Test Result**.....: Pass

Tested by:

  
Kahn yang/Engineer

Reviewer:

  
Sherwin Qian/Supervisor

Approved & Authorized Signer:

  
Liuze/Manager

Table of Contents

Page

1. TEST SUMMARY.....	4
1.1 TEST PROCEDURES AND RESULTS.....	4
1.2 TEST FACILITY.....	4
1.3 MEASUREMENT UNCERTAINTY.....	4
2. GENERAL INFORMATION.....	5
2.1 GENERAL DESCRIPTION OF EUT.....	5
2.2 Carrier Frequency of Channels.....	6
2.3 Operation of EUT during testing.....	6
2.4 DESCRIPTION OF TEST SETUP.....	6
2.5 MEASUREMENT INSTRUMENTS LIST.....	7
3. CONDUCTED EMISSIONS TEST.....	8
3.1 Conducted Power Line Emission Limit.....	8
3.2 Test Setup.....	8
3.3 Test Procedure.....	8
3.4 Test Result.....	8
4. RADIATED EMISSION TEST.....	13
4.1 Radiation Limit.....	13
4.2 Test Setup.....	13
4.3 Test Procedure.....	14
4.4 Test Result.....	14
5. BAND EDGE.....	21
5.1 Limits.....	21
5.2 Test Procedure.....	21
5.3 Test Result.....	21
6. PHOTOGRAPH OF TEST.....	23

TEST SUMMARY

TEST PROCEDURES AND RESULTS

DESCRIPTION OF TEST	RESULT
CONDUCTED EMISSIONS TEST	COMPLIANT
RADIATED EMISSION TEST	COMPLIANT

TEST FACILITY

Test Firm : Shenzhen United Testing Technology Co., Ltd.  
 Address : 2F, Annex Bldg, Jiahuangyuan Tech Park, #365 Baotian 1 Rd, Tiegang Community, Xixiang Str, Bao'an District, Shenzhen, China

The testing quality ability of our laboratory meet with "Quality Law of People's Republic of China" Clause 19. The testing quality system of our laboratory meets with ISO/IEC-17025 requirements, which is approved by CNAS. This approval result is accepted by MRA of APLAC.

Our test facility is recognized, certified, or accredited by the following organizations:

CNAS-LAB Code: L6494

The EMC Laboratory has been assessed and in compliance with CNAS-CL01 accreditation criteria for testing Laboratories (identical to ISO/IEC 17025:2017 General Requirements) for the Competence of testing Laboratories.

Designation Number: CN1227

Test Firm Registration Number: 674885

The EMC Laboratory has been registered and fully described in a report filed with the (FCC) Federal Communications commission. The acceptance letter from the FCC is maintained in our files.

A2LA Certificate Number: 4747.01

MEASUREMENT UNCERTAINTY

Measurement Uncertainty

Conducted Emission Expanded Uncertainty	=	2.23dB, k=2
Radiated emission expanded uncertainty(9kHz-30MHz)	=	3.08dB, k=2
Radiated emission expanded uncertainty(30MHz-1000MHz)	=	4.42dB, k=2
Radiated emission expanded uncertainty(Above 1GHz)	=	4.06dB, k=2

GENERAL INFORMATION

GENERAL DESCRIPTION OF EUT

Equipment	FLOOR STAND TURNTABLE WITH BLUETOOTH RECEIVER, CD PLAYER AND FM RADIO
Trade Mark	Studebaker
Model Name/HVIN(s)	MT229
Sample ID	UNIA20101709ER -1#
Serial No.	SB6085, SB6085TE, SB6085RD, SB6085XXXX
Model Difference	Where xxxxx denote any printable characters in the ASCII Standard Character Table to represent variances in cosmetics or buyers.
FCC ID	2ANXU-SB6085
Antenna Type	PCB Antenna
Antenna Gain	0dBi
Frequency Range	2402-2480MHz
Number of Channels	79 channels for BR+EDR
Modulation Type	GFSK, Pi/4 QPSK, 8DPSK for BR+EDR
Power Source	DC 12V/2A form Adapter
<b>Adapter 1</b>	
Manufacturer	SHENZHEN SHI GUANGKAIYUAN TECHNOLOGY., LTD.
M/N	GKYZD0200120US
Input	AC 100-240V~50/60Hz 0.8A Max
Output	DC 12V/2A
<b>Adapter 2</b>	
Manufacturer	DONGGUAN LIYANG ELECTRICAL TECHNOLOGY CO., LTD
M/N	LY024SPS-120200UH
Input	AC 100-240V~50/60Hz 0.65A Max
Output	DC 12V/2A

Table for auxiliary equipment:

Equipment Description	Manufacturer	Model
Notebook	Lenovo	Lenovo G475

Carrier Frequency of Channels

Channel List							
Channel	Frequency (MHz)	Channel	Frequency (MHz)	Channel	Frequency (MHz)	Channel	Frequency (MHz)
00	2402	21	2423	42	2444	63	2465
01	2403	22	2424	43	2445	64	2466
02	2404	23	2425	44	2446	65	2467
03	2405	24	2426	45	2447	66	2468
04	2406	25	2427	46	2448	67	2469
05	2407	26	2428	47	2449	68	2470
06	2408	27	2429	48	2450	69	2471
07	2409	28	2430	49	2451	70	2472
08	2410	29	2431	50	2452	71	2473
09	2411	30	2432	51	2453	72	2474
10	2412	31	2433	52	2454	73	2475
11	2413	32	2434	53	2455	74	2476
12	2414	33	2435	54	2456	75	2477
13	2415	34	2436	55	2457	76	2478
14	2416	35	2437	56	2458	77	2479
15	2417	36	2438	57	2459	78	2480
16	2418	37	2439	58	2460		
17	2419	38	2440	59	2461		
18	2420	39	2441	60	2462		
19	2421	40	2442	61	2463		
20	2422	41	2443	62	2464		

Operation of EUT during testing

Operating Mode

The mode is used: Transmitting mode

Low Channel: 2402MHz

Middle Channel: 2441MHz

High Channel: 2480MHz

Test SW Version: BK3256 RF Test\_V1.3

DESCRIPTION OF TEST SETUP

Operation of EUT during Conducted testing:

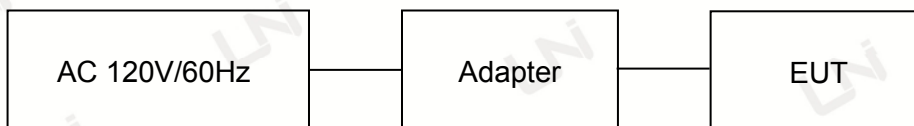

Operation of EUT during Radiation testing:

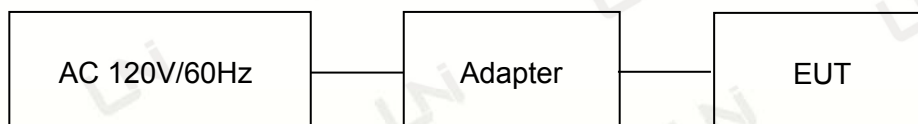

MEASUREMENT INSTRUMENTS LIST

Item	Equipment	Manufacturer	Model No.	Serial No.	Calibrated until
<b>CONDUCTED EMISSIONS TEST</b>					
1	AMN	Schwarzbeck	NNLK8121	8121370	2021.09.05
2	AMN	ETS	3810/2	00020199	2021.09.05
3	EMI TEST RECEIVER	Rohde&Schwarz	ESCI	101210	2021.09.05
4	AAN	TESEQ	T8-Cat6	38888	2021.09.05
<b>RADIATED EMISSION TEST</b>					
1	Horn Antenna	Sunol	DRH-118	A101415	2021.09.05
2	BicoNILog Antenna	Sunol	JB1 Antenna	A090215	2021.09.05
3	PREAMP	HP	8449B	3008A00160	2021.09.05
4	PREAMP	HP	8447D	2944A07999	2021.09.05
5	EMI TEST RECEIVER	Rohde&Schwarz	ESR3	101891	2021.09.05
6	VECTOR Signal Generator	Rohde&Schwarz	SMU200A	101521	2021.09.05
7	Signal Generator	Agilent	E4421B	MY4335105	2021.09.05
8	MXA Signal Analyzer	Agilent	N9020A	MY50510140	2021.09.05
9	MXA Signal Analyzer	Agilent	N9020A	MY51110104	2021.09.05
10	ANT Tower&Turn table Controller	Champro	EM 1000	60764	2021.09.05
11	Anechoic Chamber	Taihe Maorui	9m*6m*6m	966A0001	2021.09.05
12	Shielding Room	Taihe Maorui	6.4m*4m*3m	643A0001	2021.09.05
13	RF Power sensor	DARE	RPR3006W	15I00041SNO88	2021.09.05
14	RF Power sensor	DARE	RPR3006W	15I00041SNO89	2021.09.05
15	RF power divider	Anritsu	K241B	992289	2021.09.05
16	Wideband radio communication tester	Rohde&Schwarz	CMW500	154987	2021.09.05
17	Biconical antenna	Schwarzbeck	VHA 9103	91032360	2021.09.05
18	Biconical antenna	Schwarzbeck	VHA 9103	91032361	2021.09.05
19	Broadband Hybrid Antennas	Schwarzbeck	VULB9163	VULB9163#958	2021.09.05
20	Horn Antenna	Schwarzbeck	BBHA9120D	9120D-1680	2021.09.05
21	Active Receive Loop Antenna	Schwarzbeck	FMZB 1919B	00023	2021.09.05
22	Horn Antenna	Schwarzbeck	BBHA 9170	BBHA9170651	2021.09.05
23	Microwave Broadband PreActive Speaker	Schwarzbeck	BBV 9721	100472	2021.09.05
24	Active Loop Antenna	Com-Power	AL-130R	10160009	2021.09.05
25	Power Meter	KEYSIGHT	N1911A	MY50520168	2021.09.05
26	Frequency Meter	VICTOR	VC2000	997406086	2021.09.05
27	DC Power Source	HYELEC	HY5020E	055161818	2021.09.05
<b>Test software</b>					
1	E3	Audix	6.101223a	N/A	N/A

## CONDUCTED EMISSIONS TEST

### 3.1 Conducted Power Line Emission Limit

For unintentional device, according to § 15.107(a) Line Conducted Emission Limits is as following

Frequency (MHz)	Maximum RF Line Voltage(dB $\mu$ V)			
	CLASS A		CLASS B	
	Q.P.	Ave.	Q.P.	Ave.
0.15~0.50	79	66	66~56*	56~46*
0.50~5.00	73	60	56	46
5.00~30.0	73	60	60	50

\* Decreasing linearly with the logarithm of the frequency

For intentional device, according to §15.207(a) Line Conducted Emission Limit is same as above table.

### 3.2 Test Setup

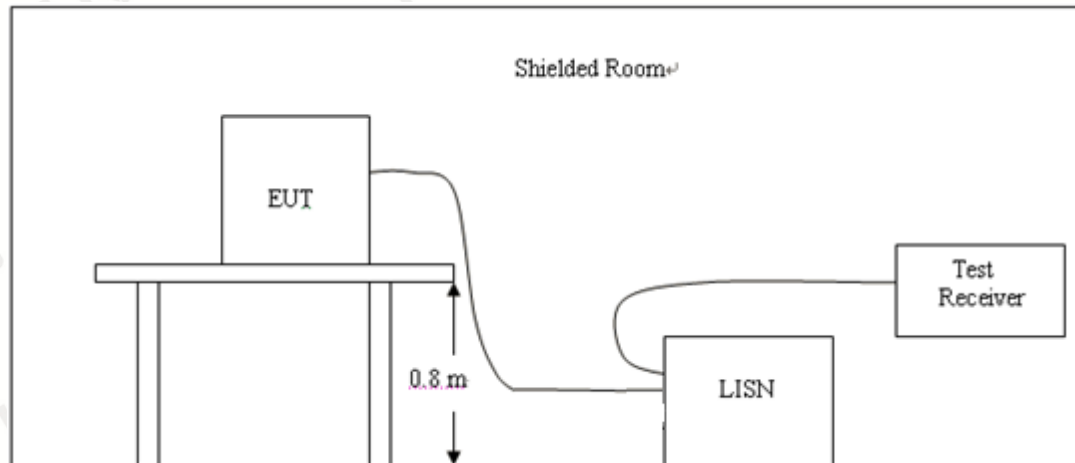

### 3.3 Test Procedure

- 1, The equipment was set up as per the test configuration to simulate typical actual usage per the user's manual. The EUT is a tabletop system, a wooden table with a height of 0.8 meters is used and is placed on the ground plane as per ANSI C63.10.
- 2, Support equipment, if needed, was placed as per ANSI C63.10.
- 3, All I/O cables were positioned to simulate typical actual usage as per ANSI C63.10.
- 4, If a EUT received DC power from the USB Port of Notebook PC, the PC's adapter received AC120V/60Hz power through a Line Impedance Stabilization Network (LISN) which supplied power source and was grounded to the ground plane.
- 5, All support equipments received AC power from a second LISN, if any.
- 6, The EUT test program was started. Emissions were measured on each current carrying line of the EUT using a spectrum Analyzer / Receiver connected to the LISN powering the EUT. The LISN has two monitoring points: Line 1 (Hot Side) and Line 2 (Neutral Side). Two scans were taken: one with Line 1 connected to Analyzer / Receiver and Line 2 connected to a 50 ohm load; the second scan had Line 1 connected to a 50 ohm load and Line 2 connected to the Analyzer / Receiver.
- 7, Analyzer / Receiver scanned from 150 KHz to 30MHz for emissions in each of the test modes.

### 3.4 Test Result

Pass

Remark:

1. All modes were tested at AC 120V and 240V, only the worst result of AC 120V was reported.
2. All modes of Low, Middle, and High channel were tested, only the worst result of High Channel was reported as below:



Temperature:	26°C	Relative Humidity:	48%
Test Date:	Nov. 05, 2020	Pressure:	1010hPa
Test Voltage:	AC 120V, 60Hz	Phase:	Line
Test Mode:	Transmitting mode of GFSK 2480MHz		
Adapter 1(GKYZD0200120US)			

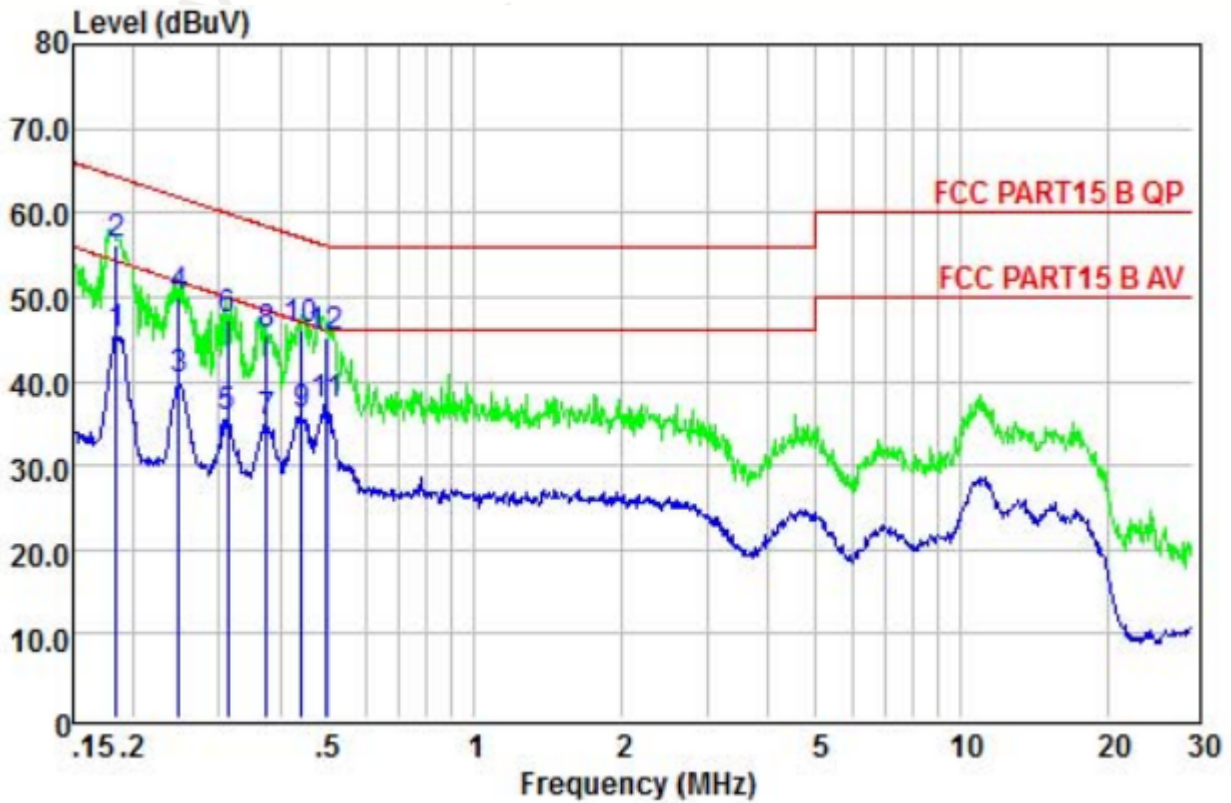

	Read Freq	Read Level	LISN Factor	Limit Level	Over Limit	Remark
	MHz	dBuV	dB	dBuV	dB	
1	0.18	35.69	9.64	45.38	54.28	-8.90 Average
2	0.18	46.61	9.64	56.30	64.28	-7.98 QP
3	0.25	30.54	9.63	40.22	51.82	-11.60 Average
4	0.25	40.14	9.63	49.82	61.82	-12.00 QP
5	0.31	25.87	9.63	35.55	49.93	-14.38 Average
6	0.31	37.71	9.63	47.39	59.93	-12.54 QP
7	0.38	25.53	9.66	35.24	48.39	-13.15 Average
8	0.38	35.82	9.66	45.53	58.39	-12.86 QP
9	0.44	26.34	9.68	36.07	47.02	-10.95 Average
10	0.44	36.46	9.68	46.19	57.02	-10.83 QP
11	0.50	27.45	9.69	37.19	46.01	-8.82 Average
12	0.50	35.56	9.69	45.30	56.01	-10.71 QP

Remark: Factor = Insertion Loss + Cable Loss, Result = Reading + Factor, Margin = Result – Limit.

Temperature:	26°C	Relative Humidity:	48%
Test Date:	Nov. 05, 2020	Pressure:	1010hPa
Test Voltage:	AC 120V, 60Hz	Phase:	Neutral
Test Mode:	Transmitting mode of GFSK 2480MHz		
Adapter 1(GKYZD0200120US)			

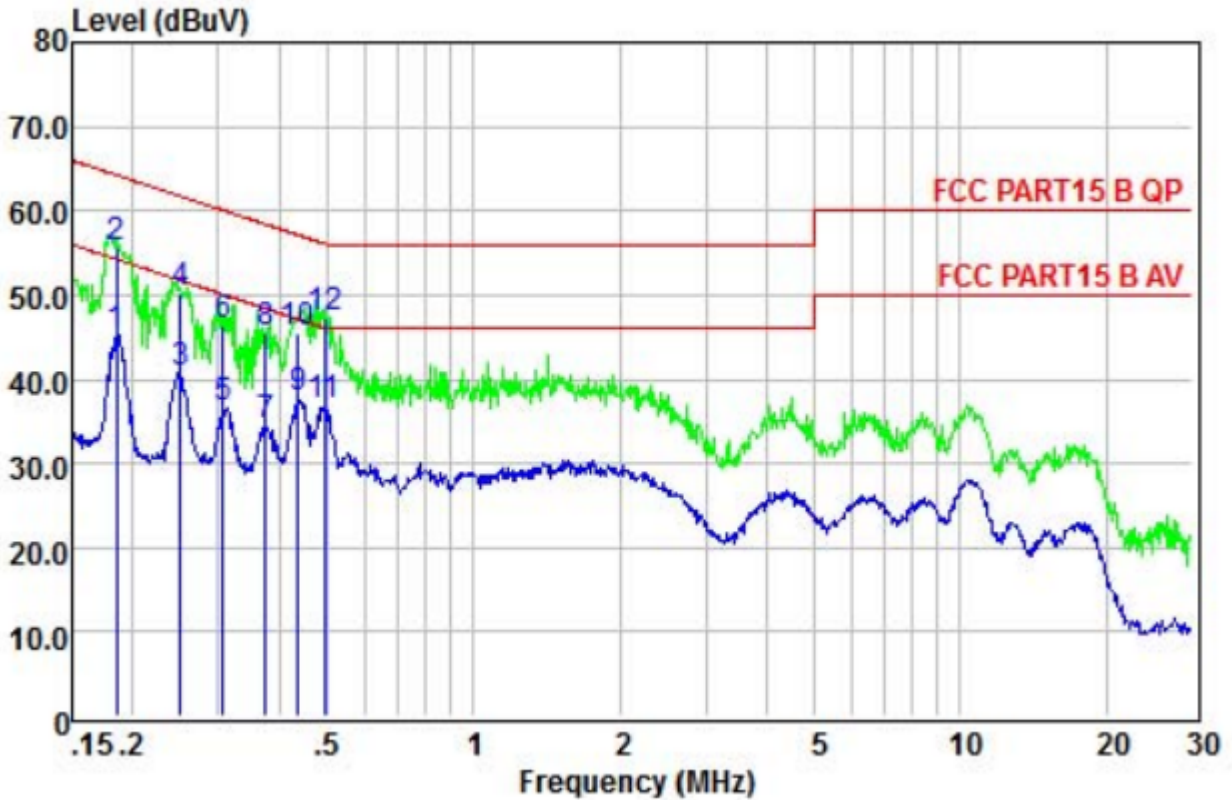

	Read	LISN	Limit	Over			
Freq	Level	Factor	Level	Line	Limit		
MHz	dBuV	dB	dBuV	dBuV	dB		
1	0.19	35.70	9.54	45.29	54.24	-8.95	Average
2	0.19	45.91	9.54	55.50	64.24	-8.74	QP
3	0.25	31.16	9.54	40.75	51.73	-10.98	Average
4	0.25	40.57	9.54	50.16	61.73	-11.57	QP
5	0.31	27.06	9.56	36.67	50.06	-13.39	Average
6	0.31	36.65	9.56	46.26	60.06	-13.80	QP
7	0.38	24.75	9.60	34.40	48.39	-13.99	Average
8	0.38	35.87	9.60	45.52	58.39	-12.87	QP
9	0.44	28.10	9.62	37.77	47.11	-9.34	Average
10	0.44	35.93	9.62	45.60	57.11	-11.51	QP
11	0.49	27.28	9.63	36.96	46.10	-9.14	Average
12	0.49	37.70	9.63	47.38	56.10	-8.72	QP

Remark: Factor = Insertion Loss + Cable Loss, Result = Reading + Factor, Margin = Result – Limit.

Temperature:	26°C	Relative Humidity:	48%
Test Date:	Nov. 05, 2020	Pressure:	1010hPa
Test Voltage:	AC 120V, 60Hz	Phase:	Line
Test Mode:	Transmitting mode of GFSK 2480MHz		
Adapter 2(LY024SPS-120200UH)			

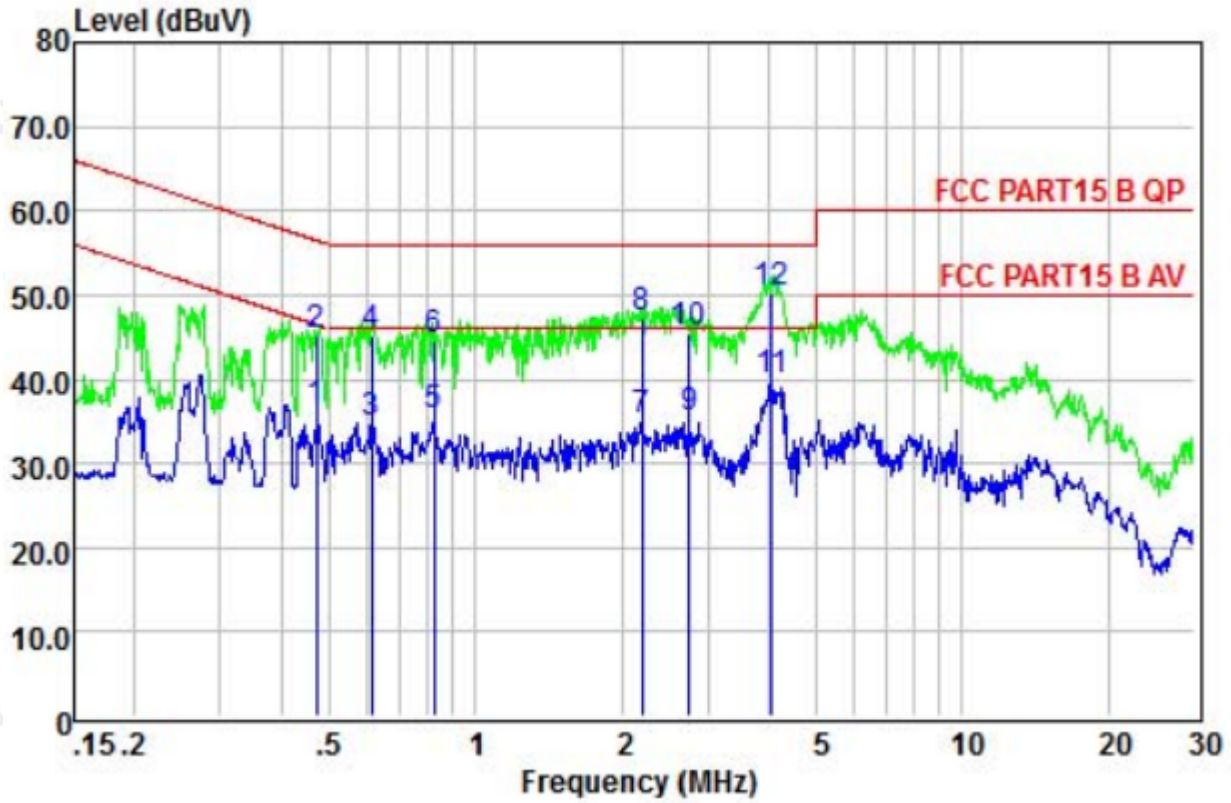

	Read Freq	Read Level	LISN Factor	Limit Level	Over Limit	Remark
	MHz	dBuV	dB	dBuV	dB	
1	0.47	26.66	9.69	36.40	46.45	-10.05 Average
2	0.47	35.51	9.69	45.25	56.45	-11.20 QP
3	0.61	24.94	9.66	34.65	46.00	-11.35 Average
4	0.61	35.55	9.66	45.26	56.00	-10.74 QP
5	0.83	26.06	9.63	35.74	46.00	-10.26 Average
6	0.83	34.85	9.63	44.53	56.00	-11.47 QP
7	2.20	25.43	9.59	35.08	46.00	-10.92 Average
8	2.20	37.54	9.59	47.19	56.00	-8.81 QP
9	2.75	25.86	9.58	35.50	46.00	-10.50 Average
10	2.75	35.89	9.58	45.53	56.00	-10.47 QP
11	4.07	30.21	9.57	39.84	46.00	-6.16 Average
12	4.07	40.51	9.57	50.14	56.00	-5.86 QP

Remark: Factor = Insertion Loss + Cable Loss, Result = Reading + Factor, Margin = Result – Limit.

Temperature:	26°C	Relative Humidity:	48%
Test Date:	Nov. 05, 2020	Pressure:	1010hPa
Test Voltage:	AC 120V, 60Hz	Phase:	Neutral
Test Mode:	Transmitting mode of GFSK 2480MHz		
Adapter 2(LY024SPS-120200UH)			

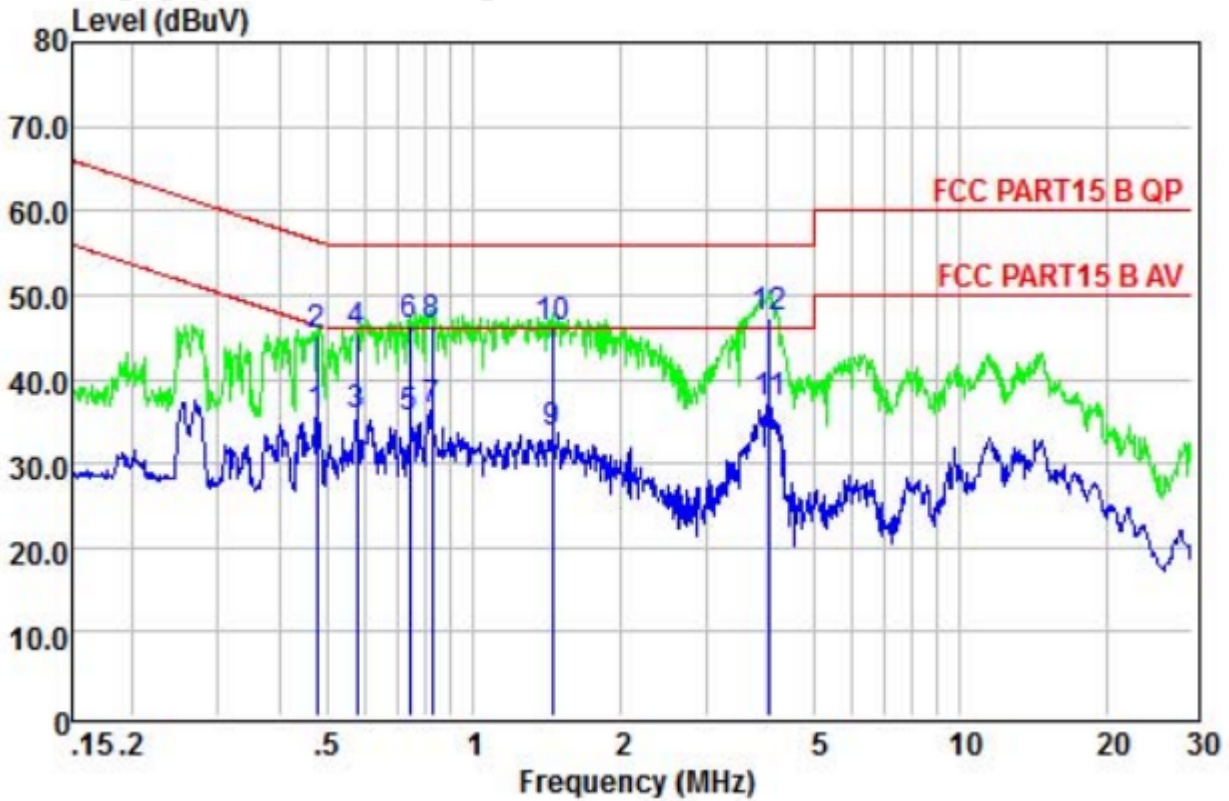

	Freq	Read Level	LISN Factor	Level	Limit Line	Over Limit	Remark
	MHz	dBuV	dB	dBuV	dBuV	dB	
1	0.48	25.92	9.63	35.60	46.36	-10.76	Average
2	0.48	35.61	9.63	45.29	56.36	-11.07	QP
3	0.58	26.00	9.63	35.68	46.00	-10.32	Average
4	0.58	35.70	9.63	45.38	56.00	-10.62	QP
5	0.74	25.58	9.63	35.26	46.00	-10.74	Average
6	0.74	36.69	9.63	46.37	56.00	-9.63	QP
7	0.83	26.57	9.63	36.25	46.00	-9.75	Average
8	0.83	36.70	9.63	46.38	56.00	-9.62	QP
9	1.46	24.06	9.60	33.72	46.00	-12.28	Average
10	1.46	36.37	9.60	46.03	56.00	-9.97	QP
11	4.05	27.51	9.66	37.23	46.00	-8.77	Average
12	4.05	37.46	9.66	47.18	56.00	-8.82	QP

Remark: Factor = Insertion Loss + Cable Loss, Result = Reading + Factor, Margin = Result – Limit.

## 4. RADIATED EMISSION TEST

### 4.1 Radiation Limit

For unintentional device, according to § 15.109(a), except for Class A digital devices, the field strength of radiated emissions from unintentional radiators at a distance of 3 meters shall not exceed the following values:

Frequency (MHz)	Distance (Meters)	Radiated (dB $\mu$ V/m)	Radiated ( $\mu$ V/m)
30-88	3	40	100
88-216	3	43.5	150
216-960	3	46	200
Above 960	3	54	500

For intentional device, according to § 15.209(a), the general requirement of field strength of radiated emissions from intentional radiators at a distance of 3 meters shall not exceed the above table.

### 4.2 Test Setup

#### 1. Radiated Emission Test-Up Frequency Below 30MHz

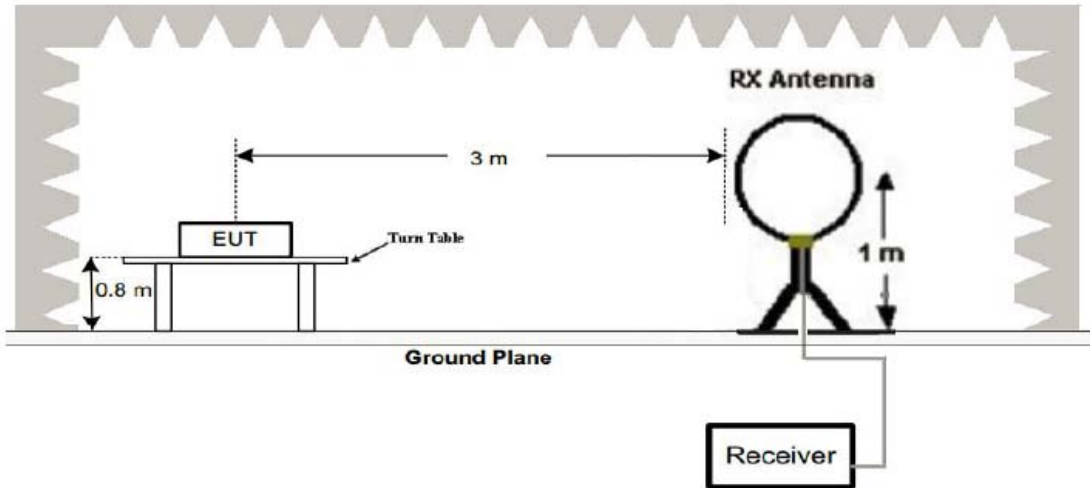

#### 2. Radiated Emission Test-Up Frequency 30MHz~1GHz

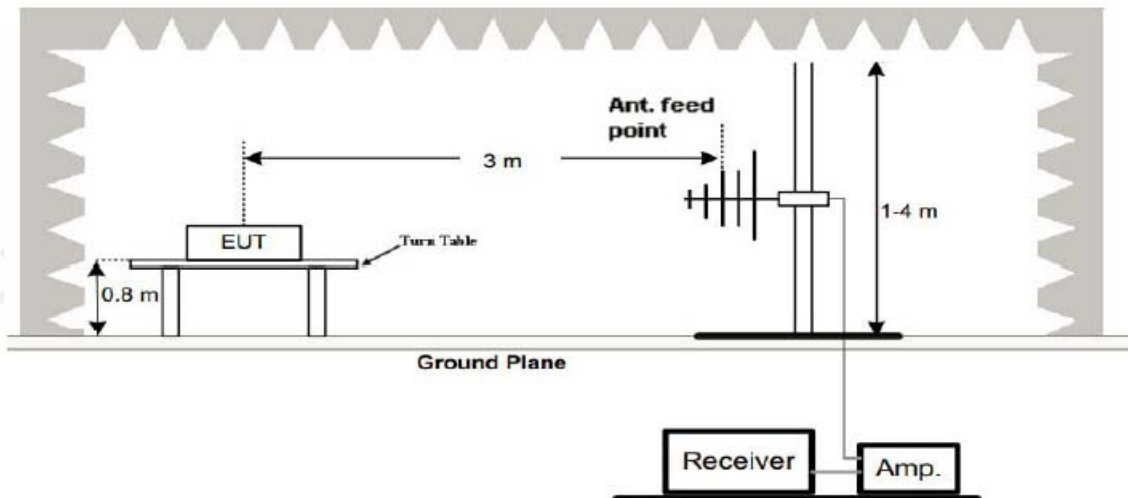

### 3. Radiated Emission Test-Up Frequency Above 1GHz

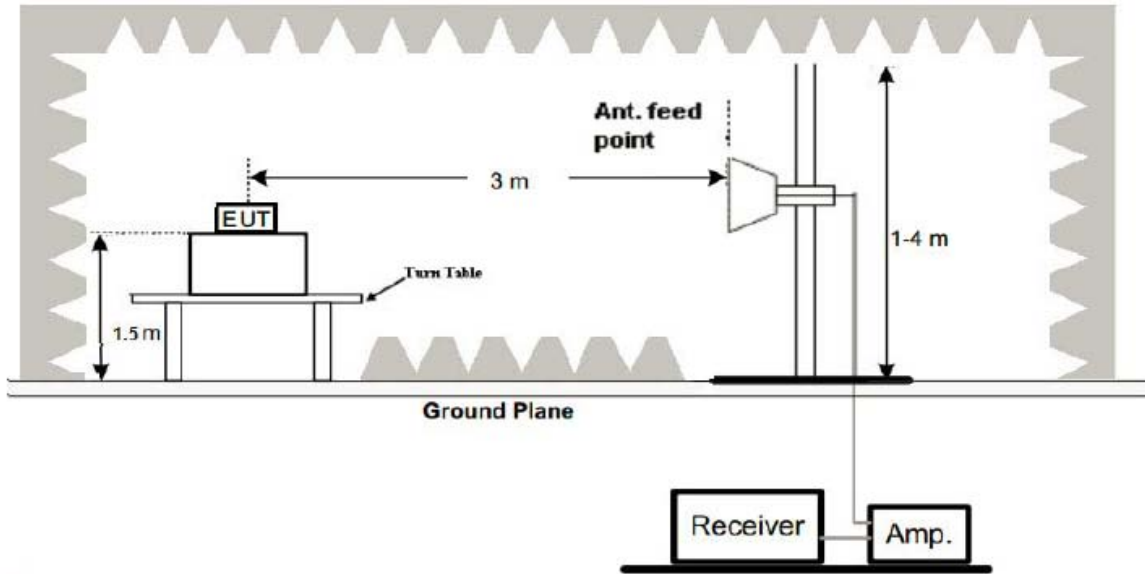

#### 4.3 Test Procedure

1. Below 1GHz measurement the EUT is placed on turntable which is 0.8m above ground plane. And above 1GHz measurement EUT was placed on low permittivity and low tangent turn table which is 1.5m above ground plane.
2. The turntable shall be rotated for 360 degrees to determine the position of maximum emission level.
3. EUT is set 3m away from the receiving antenna, which is varied from 1m to 4m to find out the highest emissions.
4. Maximum procedure was performed on the six highest emissions to ensure EUT compliance.
5. And also, each emission was to be maximized by changing the polarization of receiving antenna both horizontal and vertical.
6. Repeat above procedures until the measurements for all frequencies are complete.
7. The test frequency range from 9KHz to 25GHz per FCC PART 15.33(a).
8. The distance between test antenna and EUT as following table states:

Test Frequency range	Test Antenna Type	Test Distance
9KHz-30MHz	Active Loop Antenna	3
30MHz-1GHz	Bilog Antenna	3
1GHz-18GHz	Horn Antenna	3
18GHz-25GHz	Horn Antenna	1

**Note:**

For battery operated equipment, the equipment tests shall be performed using a new battery.

#### 4.4 Test Result

**PASS**

Remark:

1. All modes of GFSK,  $\pi/4$  DQPSK, 8DPSK were test at Low, Middle, and High channel, only the worst result of GFSK High Channel was reported for below 1GHz test.
2. For BT3.0 above 1GHz test all modes of GFSK,  $\pi/4$  DQPSK, and 8DPSK were test at Low, Middle, and High channel, only the worst result of GFSK DH5 was reported.
3. By preliminary testing and verifying three axis (X, Y and Z) position of EUT transmitted status, it was found that "Z axis" position was the worst, and test data recorded in this report.
4. Radiated emission test from 9KHz to 10th harmonic of fundamental was verified, and no emission found except system noise floor in 9KHz to 30MHz and not recorded in this report.

Below 1GHz Test Results:

Temperature:	22°C	Relative Humidity:	48%
Test Date:	Nov. 05, 2020	Pressure:	1010hPa
Test Voltage:	AC 120V, 60Hz	Polarization:	Vertical
Test Mode:	Transmitting mode of GFSK 2480MHz		
Adapter 1(GKYZD0200120US)			

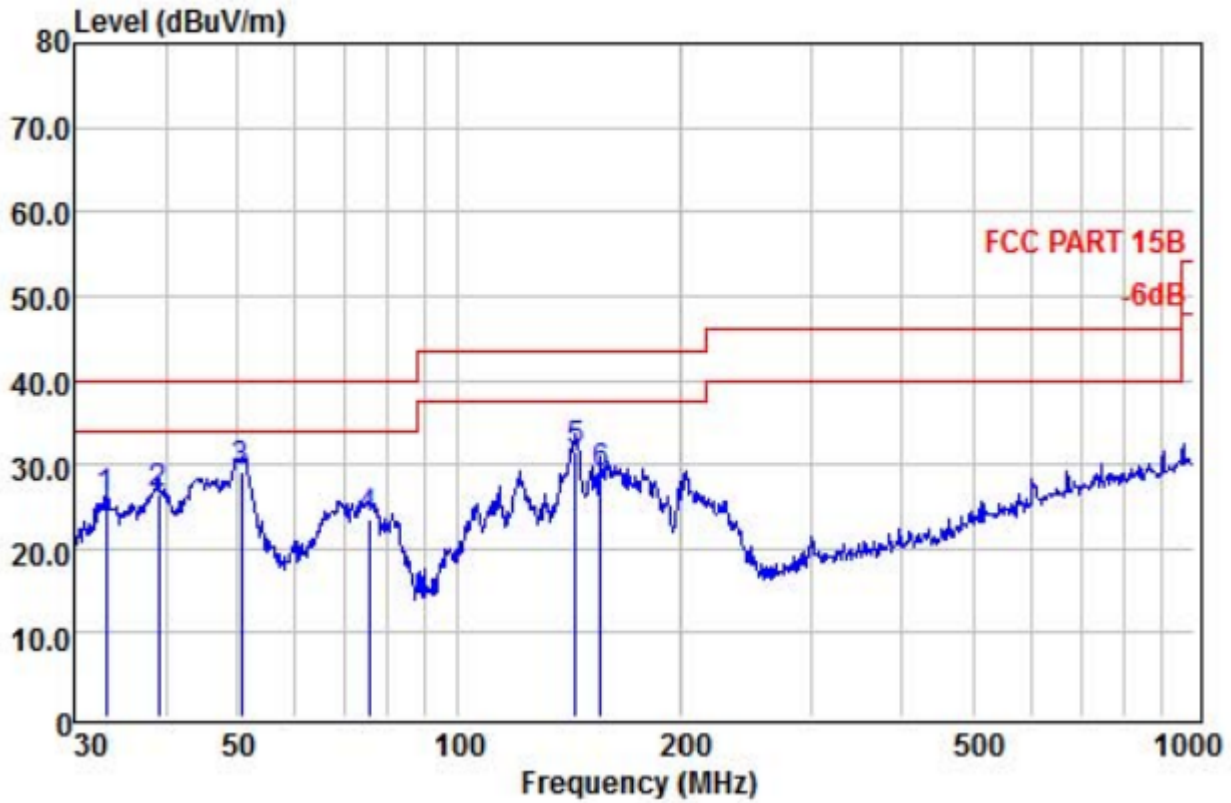

	Read Freq	Antenna Level	Antenna Factor	Cable Loss	Level	Limit Line	Over Limit	Remark
	MHz	dBuV	dB/m	dB	dBuV/m	dBuV/m	dB	
1	33.09	12.90	12.51	0.48	25.89	40.00	-14.11	QP
2	39.16	12.35	13.71	0.30	26.36	40.00	-13.64	QP
3	50.59	15.20	13.52	0.28	29.00	40.00	-11.00	QP
4	75.45	13.60	9.15	0.85	23.60	40.00	-16.40	QP
5	144.33	15.87	14.76	0.85	31.48	43.50	-12.02	QP
6	155.91	12.65	15.40	0.86	28.91	43.50	-14.59	QP

Remark: Absolute Level = Reading Level + Factor, Margin = Absolute Level – Limit  
 Factor = Ant. Factor + Cable Loss – Pre-Active Speaker

Temperature:	22°C	Relative Humidity:	48%
Test Date:	Nov. 05, 2020	Pressure:	1010hPa
Test Voltage:	AC 120V, 60Hz	Polarization:	Horizontal
Test Mode:	Transmitting mode of GFSK 2480MHz		
Adapter 1(GKYZD0200120US)			

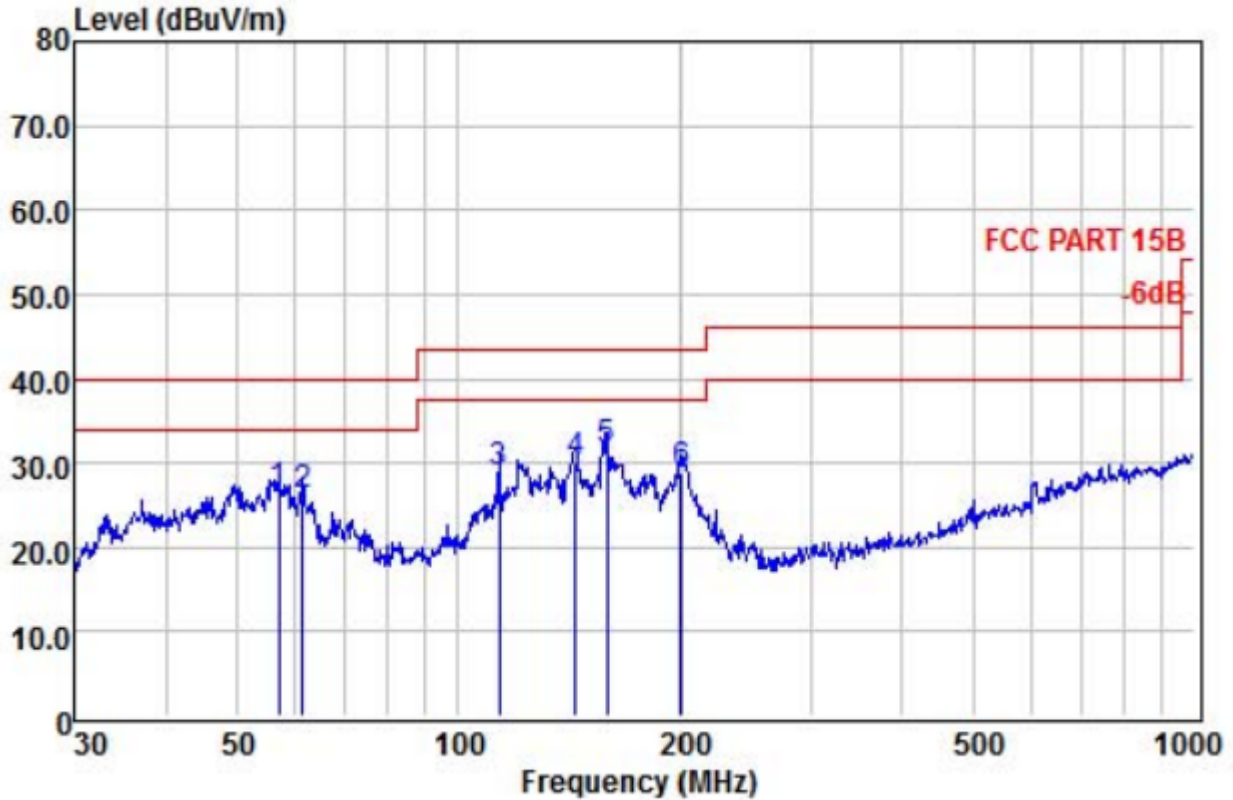

	Read	Antenna	Cable	Limit	Over	
Freq	Level	Factor	Loss	Line	Limit	Remark
MHz	dBuV	dB/m	dB	dBuV/m	dBuV/m	dB
1	56.99	13.57	12.46	0.46	26.49	40.00 -13.51 QP
2	61.35	13.89	11.64	0.58	26.11	40.00 -13.89 QP
3	113.71	15.12	12.91	0.83	28.86	43.50 -14.64 QP
4	144.33	14.33	14.76	0.85	29.94	43.50 -13.56 QP
5	159.23	15.17	15.57	0.86	31.60	43.50 -11.90 QP
6	200.69	18.41	9.62	0.88	28.91	43.50 -14.59 QP

Remark: Absolute Level = Reading Level + Factor, Margin = Absolute Level – Limit  
 Factor = Ant. Factor + Cable Loss – Pre-Active Speaker



Temperature:	22°C	Relative Humidity:	48%
Test Date:	Nov. 05, 2020	Pressure:	1010hPa
Test Voltage:	AC 120V, 60Hz	Polarization:	Vertical
Test Mode:	Transmitting mode of GFSK 2480MHz		
Adapter 2(LY024SPS-120200UH)			

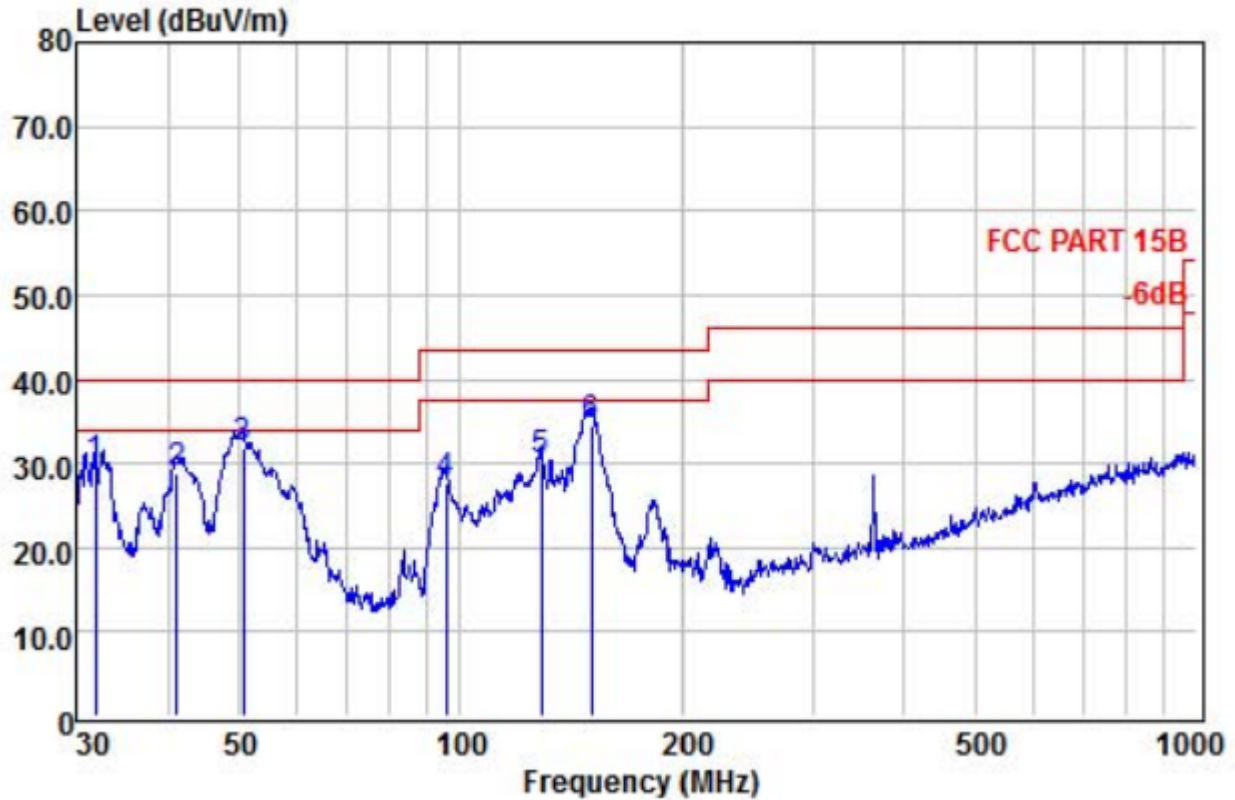

	Read	Antenna	Cable	Limit	Over		
Freq	Level	Factor	Loss	Level	Line	Limit	Remark
MHz	dBuV	dB/m	dB	dBuV/m	dBuV/m	dB	
1	31.84	16.83	12.38	0.52	29.73	40.00	-10.27 QP
2	41.13	14.84	13.74	0.28	28.86	40.00	-11.14 QP
3	50.59	18.08	13.52	0.28	31.88	40.00	-8.12 QP
4	95.43	17.33	9.62	0.83	27.78	43.50	-15.72 QP
5	128.56	15.40	14.01	0.84	30.25	43.50	-13.25 QP
6	150.54	18.66	15.11	0.86	34.63	43.50	-8.87 QP

Remark: Absolute Level = Reading Level + Factor, Margin = Absolute Level – Limit  
 Factor = Ant. Factor + Cable Loss – Pre-Active Speaker

Temperature:	22°C	Relative Humidity:	48%
Test Date:	Nov. 05, 2020	Pressure:	1010hPa
Test Voltage:	AC 120V, 60Hz	Polarization:	Horizontal
Test Mode:	Transmitting mode of GFSK 2480MHz		
Adapter 2(LY024SPS-120200UH)			

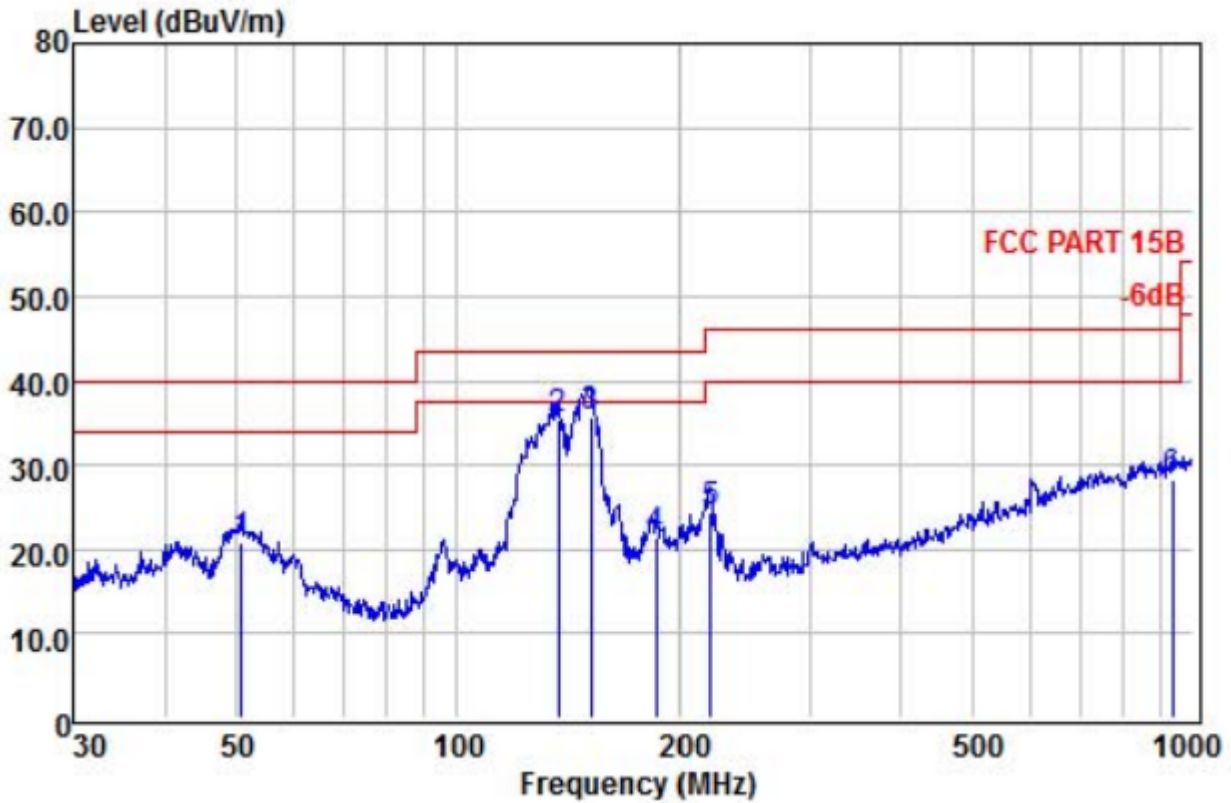

	Freq	ReadAntenna Level	Cable Factor	Cable Loss	Level	Limit Line	Over Limit	Remark
	MHz	dBuV	dB/m	dB	dBuV/m	dBuV/m	dB	
1	50.94	6.97	13.47	0.29	20.73	40.00	-19.27	QP
2	137.42	20.14	14.40	0.85	35.39	43.50	-8.11	QP
3	151.60	19.69	15.17	0.86	35.72	43.50	-7.78	QP
4	186.44	8.88	11.73	0.87	21.48	43.50	-22.02	QP
5	220.62	13.32	10.25	0.87	24.44	46.00	-21.56	QP
6	935.55	2.77	23.23	2.24	28.24	46.00	-17.76	QP

Remark: Absolute Level = Reading Level + Factor, Margin = Absolute Level – Limit  
 Factor = Ant. Factor + Cable Loss – Pre-Active Speaker

Remark:

- (1) Measuring frequencies from 9 KHz to the 1 GHz, Radiated emission test from 9KHz to 30MHz was verified, and no any emission was found except system noise floor.
- (2) \* denotes emission frequency which appearing within the Restricted Bands specified in provision of 15.205, then the general radiated emission limits in 15.209 apply.
- (3) The IF bandwidth of EMI Test Receiver between 30MHz to 1GHz was 120KHz, 1 MHz for measuring above 1 GHz, below 30MHz was 10KHz.

Above 1 GHz Test Results ( GFSK Worst Case):  
CH Low (2402MHz)

Horizontal

Frequency (MHz)	Reading Result (dBμV)	Factor (dB)	Emission Level (dBμV/m)	Limits (dBμV/m)	Margin (dB)	Detector Type
2402	109.53	-5.84	103.69	114.00	-10.31	PK
2402	84.53	-5.84	78.69	94.00	-15.31	AV
4804	64.27	-3.64	60.63	74.00	-13.37	PK
4804	52.49	-3.64	48.85	54.00	-5.15	AV
7206	63.24	-0.95	62.29	74.00	-11.71	PK
7206	48.26	-0.95	47.31	54.00	-6.69	AV

Remark: Factor = Antenna Factor + Cable Loss – Pre-Active Speaker. Margin = Absolute Level – Limit

Vertical

Frequency (MHz)	Reading Result (dBμV)	Factor (dB)	Emission Level (dBμV/m)	Limits (dBμV/m)	Margin (dB)	Detector Type
2402	108.67	-5.84	102.83	114.00	-11.17	PK
2402	83.65	-5.84	77.81	94.00	-16.19	AV
4804	62.41	-3.64	58.77	74.00	-15.23	PK
4804	51.27	-3.64	47.63	54.00	-6.37	AV
7206	63.52	-0.95	62.57	74.00	-11.43	PK
7206	49.36	-0.95	48.41	54.00	-5.59	AV

Remark: Factor = Antenna Factor + Cable Loss – Pre-Active Speaker. Margin = Absolute Level – Limit

CH Middle (2441MHz)

Horizontal

Frequency (MHz)	Reading Result (dBμV)	Factor (dB)	Emission Level (dBμV/m)	Limits (dBμV/m)	Margin (dB)	Detector Type
2441	108.63	-5.84	102.79	114.00	-11.21	PK
2441	83.25	-5.84	77.41	94.00	-16.59	AV
4882	66.89	-3.64	63.25	74.00	-10.75	PK
4882	52.46	-3.64	48.82	54.00	-5.18	AV
7323	61.53	-0.95	60.58	74.00	-13.42	PK
7323	48.52	-0.95	47.57	54.00	-6.43	AV

Remark: Factor = Antenna Factor + Cable Loss – Pre-Active Speaker. Margin = Absolute Level – Limit

Vertical

Frequency (MHz)	Reading Result (dBμV)	Factor (dB)	Emission Level (dBμV/m)	Limits (dBμV/m)	Margin (dB)	Detector Type
2441	109.03	-5.84	103.19	114.00	-10.81	PK
2441	81.43	-5.84	75.59	94.00	-18.41	AV
4882	63.25	-3.64	59.61	74.00	-14.39	PK
4882	51.27	-3.64	47.63	54.00	-6.37	AV
7323	61.53	-0.95	60.58	74.00	-13.42	PK
7323	48.26	-0.95	47.31	54.00	-6.69	AV

Remark: Factor = Antenna Factor + Cable Loss – Pre-Active Speaker. Margin = Absolute Level – Limit

CH High (2480MHz)

Horizontal

Frequency (MHz)	Reading Result (dBμV)	Factor (dB)	Emission Level (dBμV/m)	Limits (dBμV/m)	Margin (dB)	Detector Type
2480	109.36	-5.84	103.52	114.00	-10.48	PK
2480	83.46	-5.84	77.62	94.00	-16.38	AV
4960	62.43	-3.64	58.79	74.00	-15.21	PK
4960	49.21	-3.64	45.57	54.00	-8.43	AV
7440	62.15	-0.95	61.2	74.00	-12.8	PK
7440	48.36	-0.95	47.41	54.00	-6.59	AV

Remark: Factor = Antenna Factor + Cable Loss – Pre-Active Speaker. Margin = Absolute Level – Limit

Vertical

Frequency (MHz)	Reading Result (dBμV)	Factor (dB)	Emission Level (dBμV/m)	Limits (dBμV/m)	Margin (dB)	Detector Type
2480	107.46	-5.84	101.62	114.00	-12.38	PK
2480	82.35	-5.84	76.51	94.00	-17.49	AV
4960	61.42	-3.64	57.78	74.00	-16.22	PK
4960	52.36	-3.64	48.72	54.00	-5.28	AV
7440	61.24	-0.95	60.29	74.00	-13.71	PK
7440	48.69	-0.95	47.74	54.00	-6.26	AV

Remark: Factor = Antenna Factor + Cable Loss – Pre-Active Speaker. Margin = Absolute Level – Limit

Remark:

- (1) Measuring frequencies from 1 GHz to the 25 GHz.
- (2) “F” denotes fundamental frequency; “H” denotes spurious frequency. “E” denotes band edge frequency.
- (3) \* denotes emission frequency which appearing within the Restricted Bands specified in provision of 15.205, then the general radiated emission limits in 15.209 apply.
- (4) Data of measurement within this frequency range shown “--- ” in the table above means the reading of emissions are attenuated more than 20dB below the permissible limits or the field strength is too small to be measured.
- (5) The IF bandwidth of EMI Test Receiver between 30MHz to 1GHz was 120KHz, 1 MHz for measuring above 1 GHz, below 30MHz was 10KHz. The resolution bandwidth of test receiver/spectrum analyzer is 1MHz and video bandwidth is 3MHz for peak measurement with peak detector at frequency above 1GHz. The resolution bandwidth of test receiver/spectrum analyzer is 1MHz and video bandwidth is 10Hz for Average measurement with peak detection at frequency above 1GHz.
- (6) When the test results of Peak Detected below the limits of Average Detected, the Average Detected is not need completed. For example: Top Channel at Fundamental 73.16dBuV/m(PK Value) <93.98(AV Limit), at harmonic 53.20 dBuV/m(PK Value) <54 dBuV/m(AV Limit), the Average Detected not need to completed.
- (7) All modes of operation were investigated and the worst-case emissions are reported.

## 5. BAND EDGE

### 5.1 Limits

FCC PART 15.247 Emissions radiated outside of the specified frequency bands, except for harmonics, shall be attenuated by at least 20 dB below the level of the fundamental or to the general radiated emission limits in §15.209, whichever is the lesser attenuation.

### 5.2 Test Procedure

The band edge compliance of RF radiated emission should be measured by following the guidance in ANSI C63.10 with respect to maximizing the emission by rotating the EUT, measuring the emission while the EUT is situated in three orthogonal planes (if appropriate), adjusting the measurement antenna height and polarization etc. Set RBW to 1MHz and VBM to 3MHz to measure the peak field strength and set RBW to 1MHz and VBW to 10kHz to measure the average radiated field strength. The conducted RF band edge was measured by using a spectrum analyzer. Set span wide enough to capture the highest in-band emission and the emission at the band edge. Set RBW to 100 KHz and VBW to 300 KHz, to measure the conducted peak band edge.

### 5.3 Test Result

PASS

Remark: All modes of GFSK,  $\pi/4$  DQPSK, 8DPSK were tested, only the worst result of GFSK was reported as below.

Radiated Band Edge Test:

Worst case on GFSK

Operation Mode: TX CH Low (2402MHz)

Horizontal

Frequency (MHz)	Reading Result (dBμV)	Factor (dB)	Emission Level (dBμV/m)	Limits (dBμV/m)	Margin (dB)	Detector Type
2310	52.36	-5.81	46.55	74.00	-27.45	PK
2310	/	-5.81	/	54.00	/	AV
2390	52.16	-5.84	46.32	74.00	-27.68	PK
2390	/	-5.84	/	54.00	/	AV
2400	51.36	-5.84	45.52	74.00	-28.48	PK
2400	/	-5.84	/	54.00	/	AV

Remark: Factor = Antenna Factor + Cable Loss – Pre-Active Speaker.

Vertical

Frequency (MHz)	Reading Result (dBμV)	Factor (dB)	Emission Level (dBμV/m)	Limits (dBμV/m)	Margin (dB)	Detector Type
2310	53.06	-5.81	47.25	74.00	-26.75	PK
2310	/	-5.81	/	54.00	/	AV
2390	52.46	-5.84	46.62	74.00	-27.38	PK
2390	/	-5.84	/	54.00	/	AV
2400	51.69	-5.84	45.85	74.00	-28.15	PK
2400	/	-5.84	/	54.00	/	AV

Remark: Factor = Antenna Factor + Cable Loss – Pre-Active Speaker.

Operation Mode: TX CH High (2480MHz)

Horizontal

Frequency (MHz)	Reading Result (dBμV)	Factor (dB)	Emission Level (dBμV/m)	Limits (dBμV/m)	Margin (dB)	Detector Type
2483.5	53.26	-5.65	47.61	74.00	-26.39	PK
2483.5	/	-5.65	/	54.00	/	AV
2500	52.47	-5.72	46.75	74.00	-27.25	PK
2500	/	-5.72	/	54.00	/	AV

Remark: Factor = Antenna Factor + Cable Loss – Pre-Active Speaker.

Vertical

Frequency (MHz)	Reading Result (dBμV)	Factor (dB)	Emission Level (dBμV/m)	Limits (dBμV/m)	Margin (dB)	Detector Type
2483.5	52.96	-5.65	47.31	74.00	-26.69	PK
2483.5	/	-5.65	/	54.00	/	AV
2500	52.34	-5.72	46.62	74.00	-27.38	PK
2500	/	-5.72	/	54.00	/	AV

Remark: Factor = Antenna Factor + Cable Loss – Pre-Active Speaker.

6. PHOTOGRAPH OF TEST

**Radiated Emission  
(Below 1G)**



**Radiated Emission  
(Above 1G)**

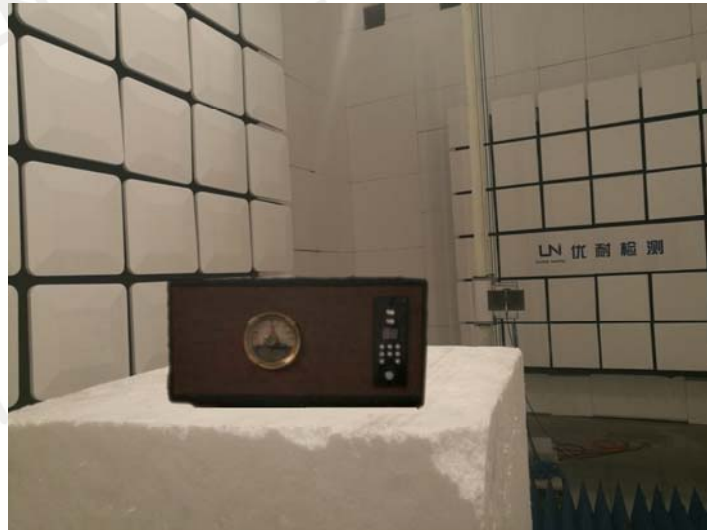

**Conducted Emission**



\*\*\*End of Report\*\*\*