

| | | | |
|-----------------|-------------------------------|---------------|------------|
| Test Report #: | SAR-FION-002-17001_Appendix_C | FCC ID: | 2ANVA-V200 |
| Date of Report: | 2018-02-12 | IC Cert. No.: | 22342-V200 |



Tissue Parameters Appendix C

SAR measurements were made within 24 hours of the measurement of liquid parameters.

Recipe for liquids below 1 GHz:

Water 35-58%

Sugar 40-60%

Salt 0-6%

Hydroxyethyl-cellulose <0.3%

Preventol-D7 0.1-0.7%

Recipe for liquids above 1-3 GHz:

Water 52-75%

DGBE 25-48%

Salt <1.0%

900 MHz Body Liquid

| Date | Temp (°C) | Frequency (MHz) | Relative Permativity | Conductivity (S/m) |
|------------|-----------|-----------------|----------------------|--------------------|
| 2018/01/08 | 21.46 | 825 | 52.7926 | 0.9773 |
| | | 826 | 52.805 | 0.9755 |
| | | 827 | 52.7989 | 0.9769 |
| | | 828 | 52.7864 | 0.9776 |
| | | 829 | 52.768 | 0.9789 |
| | | 830 | 52.7658 | 0.9801 |
| | | 831 | 52.7552 | 0.9808 |
| | | 832 | 52.7351 | 0.9819 |
| | | 833 | 52.7264 | 0.9828 |
| | | 834 | 52.7153 | 0.9833 |
| | | 835 | 52.7061 | 0.9846 |
| | | 836 | 52.6895 | 0.9857 |
| | | 837 | 52.6801 | 0.9869 |
| | | 838 | 52.6715 | 0.9882 |
| | | 839 | 52.6532 | 0.9893 |
| | | 840 | 52.6404 | 0.9902 |
| | | 841 | 52.634 | 0.9913 |
| | | 842 | 52.6252 | 0.9923 |
| | | 843 | 52.6164 | 0.9932 |
| | | 844 | 52.6014 | 0.9946 |
| 845 | 52.5928 | 0.9955 | | |
| 846 | 52.5843 | 0.9966 | | |

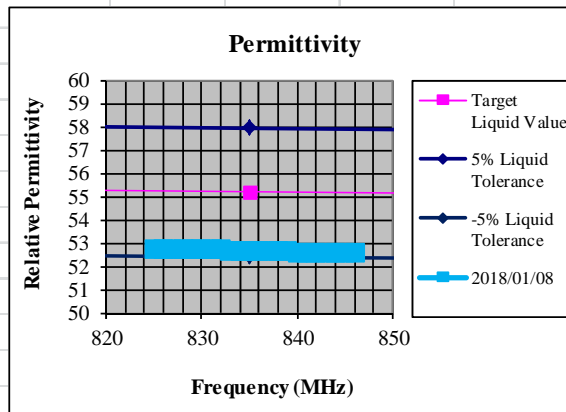
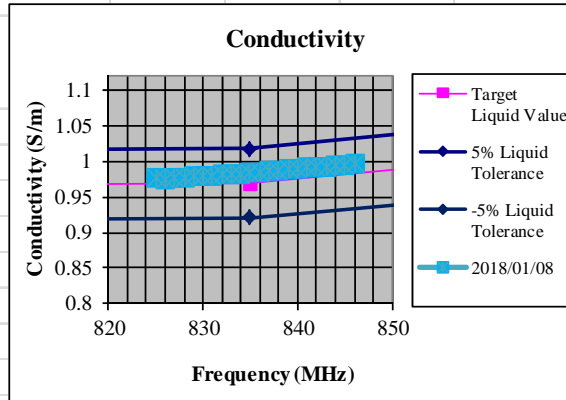

1750 MHz Body Liquid

| Date | Temp (°C) | Frequency (MHz) | Relative Permativity | Conductivity (S/m) |
|------------|-----------|-----------------|----------------------|--------------------|
| 10/30/2017 | 22.85 | 1725 | 51.3263 | 1.4312 |
| | | 1726 | 51.3165 | 1.432 |
| | | 1727 | 51.3083 | 1.4331 |
| | | 1728 | 51.2923 | 1.4334 |
| | | 1729 | 51.2849 | 1.4347 |
| | | 1730 | 51.2735 | 1.435 |
| | | 1731 | 51.2658 | 1.4361 |
| | | 1732 | 51.2522 | 1.4371 |
| | | 1733 | 51.2429 | 1.4386 |
| | | 1734 | 51.2341 | 1.4392 |
| | | 1735 | 51.2277 | 1.4405 |
| | | 1736 | 51.212 | 1.4416 |
| | | 1737 | 51.2045 | 1.4435 |
| | | 1738 | 51.1965 | 1.4443 |
| | | 1739 | 51.1945 | 1.4459 |
| | | 1740 | 51.1875 | 1.4471 |
| | | 1741 | 51.1768 | 1.4479 |
| | | 1742 | 51.1679 | 1.4505 |
| | | 1743 | 51.1668 | 1.4516 |
| | | 1744 | 51.1615 | 1.4538 |
| 1745 | 51.1621 | 1.4565 | | |
| 1746 | 51.1551 | 1.4574 | | |

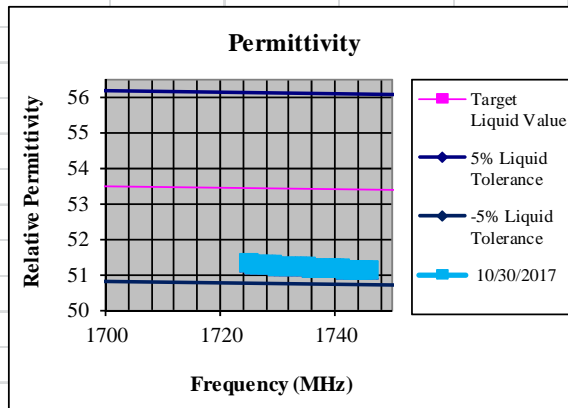
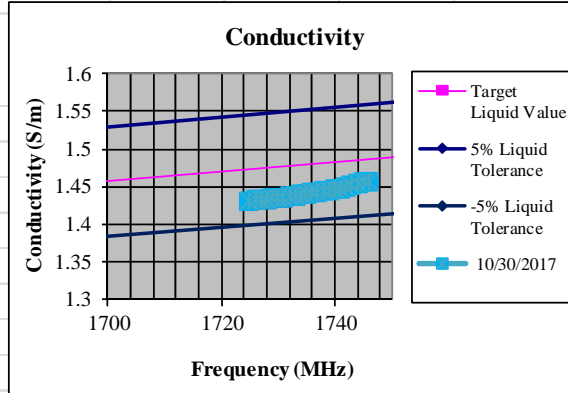

1900 MHz Body Liquid

| Date | Temp (°C) | Frequency (MHz) | Relative Permativity | Conductivity (S/m) |
|------------|-----------|-----------------|----------------------|--------------------|
| 2017/12/19 | 21.05 | 1870 | 52.2468 | 1.5529 |
| | | 1871 | 52.2441 | 1.5542 |
| | | 1872 | 52.2463 | 1.5558 |
| | | 1873 | 52.2423 | 1.5574 |
| | | 1874 | 52.24 | 1.5587 |
| | | 1875 | 52.2406 | 1.561 |
| | | 1876 | 52.2412 | 1.5616 |
| | | 1877 | 52.2407 | 1.563 |
| | | 1878 | 52.2368 | 1.5643 |
| | | 1879 | 52.2369 | 1.5658 |
| | | 1880 | 52.2372 | 1.5671 |
| | | 1881 | 52.2332 | 1.5684 |
| | | 1882 | 52.2347 | 1.5696 |
| | | 1883 | 52.2314 | 1.5709 |
| | | 1884 | 52.2335 | 1.572 |
| | | 1885 | 52.2318 | 1.5727 |
| | | 1886 | 52.2254 | 1.5744 |
| | | 1887 | 52.2309 | 1.5754 |
| | | 1888 | 52.2275 | 1.5762 |
| | | 1889 | 52.2258 | 1.5776 |
| 1890 | 52.2242 | 1.5782 | | |
| 1891 | 52.2201 | 1.5793 | | |

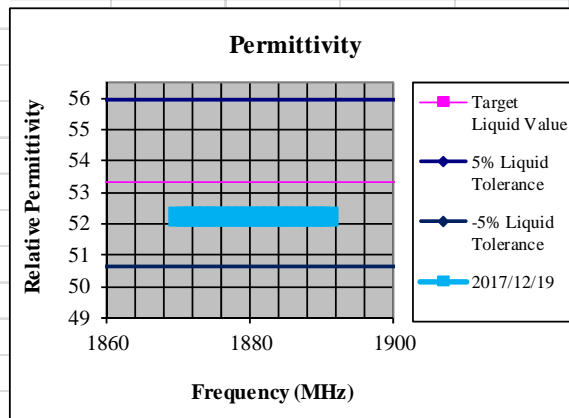
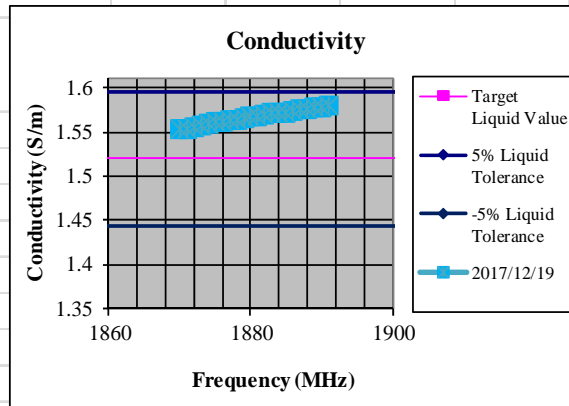

2450 MHz Body Liquid

| Date | Temp (°C) | Frequency (MHz) | Relative Permativity | Conductivity (S/m) |
|------------|-----------|-----------------|----------------------|--------------------|
| 2018/01/09 | 22.54 | 2425 | 52.5792 | 1.9995 |
| | | 2426 | 52.5691 | 2.0005 |
| | | 2427 | 52.5623 | 2.0006 |
| | | 2428 | 52.5554 | 2.0009 |
| | | 2429 | 52.5497 | 2.0012 |
| | | 2430 | 52.5385 | 2.0021 |
| | | 2431 | 52.529 | 2.0018 |
| | | 2432 | 52.5219 | 2.0029 |
| | | 2433 | 52.5164 | 2.0041 |
| | | 2434 | 52.5094 | 2.0047 |
| | | 2435 | 52.5 | 2.0049 |
| | | 2436 | 52.4959 | 2.0055 |
| | | 2437 | 52.4879 | 2.0055 |
| | | 2438 | 52.479 | 2.0067 |
| | | 2439 | 52.4722 | 2.0078 |
| | | 2440 | 52.4758 | 2.0079 |
| | | 2441 | 52.4724 | 2.0097 |
| | | 2442 | 52.4661 | 2.0108 |
| 2443 | 52.4568 | 2.012 | | |
| 2444 | 52.4524 | 2.0132 | | |
| 2445 | 52.4474 | 2.0145 | | |
| 2446 | 52.4532 | 2.0151 | | |

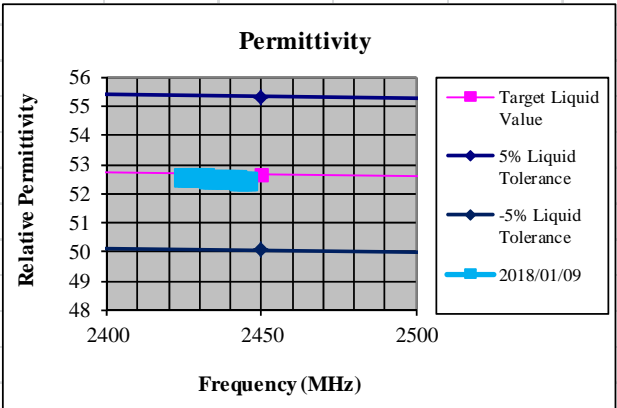
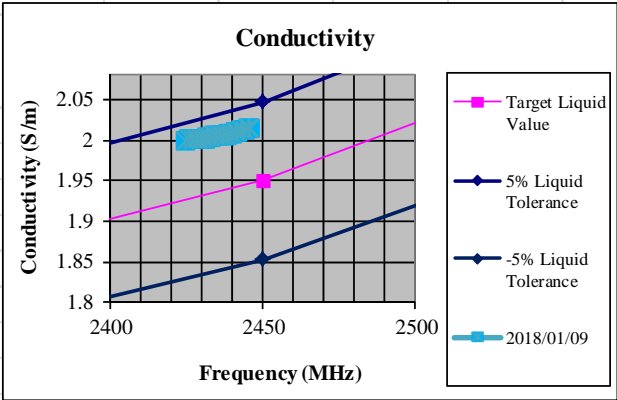

| | | | |
|-----------------|-------------------------------|---------------|------------|
| Test Report #: | SAR-FION-002-17001_Appendix_C | FCC ID: | 2ANVA-V200 |
| Date of Report: | 2018-02-12 | IC Cert. No.: | 22342-V200 |

Test Equipment

Test Equipment

SAR1 Lab

| Instrument description | Supplier / Manufacturer | Model | Serial No. | Calibration (date) | Calibration Due (date) |
|------------------------------|-------------------------|--------------------|-----------------|--------------------|------------------------|
| Robot | Staubli | TX90 | F10/5D3NA1/A/01 | N/A | N/A |
| Elliptical Phantom | SPEAG | OD OVA 001 BB | 1092 | N/A | N/A |
| Software | SPEAG | Dasy52 52.8.8.1222 | N/A | N/A | N/A |
| Device Holder | SPEAG | SD 000H01 | N/A | N/A | N/A |
| Data Acquisition Electronics | SPEAG | DAE4 | 1266 | 2017/05/16 | 2019/05/16 |
| SAR Probe | SPEAG | ES3DV3 | 3323 | 2017/05/12 | 2019/05/12 |

Shared Equipment

| Instrument description | Supplier / Manufacturer | Model | Serial No. | Calibration (date) | Calibration Due (date) |
|-------------------------------|-------------------------|----------|------------|--------------------|------------------------|
| 900 MHz Body Tissue Simulant | SPEAG | MSL 900 | 110518-7 | 2018/01/08 | N/A |
| 1750 MHz Body Tissue Simulant | SPEAG | MSL 1750 | 100824-2 | 2017/10/30 | N/A |
| 1900 MHz Body Tissue Simulant | SPEAG | MSL 1900 | 110615-4 | 2017/12/19 | N/A |
| 2450 MHz Body Tissue Simulant | SPEAG | MSL2450 | 110530-1 | 2018/01/30 | N/A |
| 900 MHz Dipole | SPEAG | D900V2 | 1d110 | 2016/05/11 | N/A |
| 1750 MHz Dipole | SPEAG | D1750V2 | 1045 | 2016/05/11 | N/A |
| 1900 MHz Dipole | SPEAG | D1900V2 | 5d135 | 2016/04/25 | N/A |
| 2450 MHz Dipole | SPEAG | D2450V2 | 859 | 2016/04/19 | N/A |
| RF Amplifier | Amp. Research | 30S1G3 | N/A | N/A | N/A |
| Dielectric Measurement Kit | SPEAG | DAK-3.5 | 1118 | 2017/05/10 | 2019/05/10 |
| Synthesized CW Generator | Agilent | 83712B | US37101255 | N/A | N/A |
| Network Analyzer | Agilent | N9923A | MY51491621 | 2017/08/16 | 2019/08/16 |
| Power Sensor | Agilent | E9300A | MY41400484 | 2017/08 | 2020/08 |
| Power Sensor | Agilent | E9300A | MY41400492 | 2017/08 | 2020/08 |
| Power Meter | Agilent | E4419B | MY45101996 | 2017/08 | 2020/08 |
| Radio Communications Tester | Rohde & Schwarz | CMU 200 | 110759 | 2017/05 | 2020/05 |

| | | | |
|-----------------|-------------------------------|---------------|------------|
| Test Report #: | SAR-FION-002-17001_Appendix_C | FCC ID: | 2ANVA-V200 |
| Date of Report: | 2018-02-12 | IC Cert. No.: | 22342-V200 |

Equipment Calibration/Performance Documents:

Attached:

SAR Probe ES3DV3 Calibration Report – SN:3323

DAE4 Calibrated Report – SN:1266

2450 MHz Dipole Calibration Report – SN:859

900 MHz Dipole Calibration Report – SN:1d110

1750 MHz Dipole Calibration Report – SN:1045

1900 MHz Dipole Calibration Report-SN:5d135

| | | | |
|-----------------|-------------------------------|---------------|------------|
| Test Report #: | SAR-FION-002-17001_Appendix_C | FCC ID: | 2ANVA-V200 |
| Date of Report: | 2018-02-12 | IC Cert. No.: | 22342-V200 |



Equipment Calibration/Performance Documents

1.1. ES3DV3-SN 3323 May 2017

**Calibration Laboratory of
Schmid & Partner
Engineering AG**
Zeughausstrasse 43, 8004 Zurich, Switzerland



S Schweizerischer Kalibrierdienst
S Service suisse d'étalonnage
C Servizio svizzero di taratura
S Swiss Calibration Service

Accredited by the Swiss Accreditation Service (SAS)
The Swiss Accreditation Service is one of the signatories to the EA
Multilateral Agreement for the recognition of calibration certificates

Accreditation No.: **SCS 0108**

Client **Cetecom USA**

Certificate No: **ES3-3323_May17**

CALIBRATION CERTIFICATE

Object: **ES3DV3 - SN:3323**

Calibration procedure(s): **QA CAL-01.v9, QA CAL-23.v5, QA CAL-25.v6
Calibration procedure for dosimetric E-field probes**

Calibration date: **May 12, 2017**

This calibration certificate documents the traceability to national standards, which realize the physical units of measurements (SI).
The measurements and the uncertainties with confidence probability are given on the following pages and are part of the certificate.

All calibrations have been conducted in the closed laboratory facility: environment temperature (22 ± 3)°C and humidity < 70%.

Calibration Equipment used (M&TE critical for calibration)

| Primary Standards | ID | Cal Date (Certificate No.) | Scheduled Calibration |
|----------------------------|------------------|-----------------------------------|------------------------|
| Power meter NRP | SN: 104778 | 04-Apr-17 (No. 217-02521/02522) | Apr-18 |
| Power sensor NRP-Z91 | SN: 103244 | 04-Apr-17 (No. 217-02521) | Apr-18 |
| Power sensor NRP-Z91 | SN: 103245 | 04-Apr-17 (No. 217-02525) | Apr-18 |
| Reference 20 dB Attenuator | SN: S5277 (20x) | 07-Apr-17 (No. 217-02528) | Apr-18 |
| Reference Probe ES3DV2 | SN: 3013 | 31-Dec-16 (No. ES3-3013_Dec16) | Dec-17 |
| DAE4 | SN: 660 | 7-Dec-16 (No. DAE4-660_Dec16) | Dec-17 |
| Secondary Standards | ID | Check Date (in house) | Scheduled Check |
| Power meter E4419B | SN: GB41293874 | 06-Apr-16 (in house check Jun-16) | In house check: Jun-18 |
| Power sensor E4412A | SN: MY41498087 | 06-Apr-16 (in house check Jun-16) | In house check: Jun-18 |
| Power sensor E4412A | SN: 000110210 | 06-Apr-16 (in house check Jun-16) | In house check: Jun-18 |
| RF generator HP 8648C | SN: US3642U01700 | 04-Aug-99 (in house check Jun-16) | In house check: Jun-18 |
| Network Analyzer HP 8753E | SN: US37390585 | 18-Oct-01 (in house check Oct-16) | In house check: Oct-17 |

| | | | |
|----------------|------------------------------|-----------------------------------|---------------|
| Calibrated by: | Name Michael Weber | Function Laboratory Technician | Signature |
| Approved by: | Name Katja Pokovic | Function Technical Manager | Signature |

Issued: May 16, 2017

This calibration certificate shall not be reproduced except in full without written approval of the laboratory.

| | | | |
|-----------------|-------------------------------|---------------|------------|
| Test Report #: | SAR-FION-002-17001_Appendix_C | FCC ID: | 2ANVA-V200 |
| Date of Report: | 2018-02-12 | IC Cert. No.: | 22342-V200 |

**Calibration Laboratory of
Schmid & Partner
Engineering AG**
Zeughausstrasse 43, 8004 Zurich, Switzerland



S Schweizerischer Kalibrierdienst
C Service suisse d'étalonnage
S Servizio svizzero di taratura
S Swiss Calibration Service

Accredited by the Swiss Accreditation Service (SAS)
The Swiss Accreditation Service is one of the signatories to the EA
Multilateral Agreement for the recognition of calibration certificates

Accreditation No.: **SCS 0108**

Glossary:

| | |
|-----------------------|---|
| TSL | tissue simulating liquid |
| NORM _{x,y,z} | sensitivity in free space |
| ConvF | sensitivity in TSL / NORM _{x,y,z} |
| DCP | diode compression point |
| CF | crest factor (1/duty_cycle) of the RF signal |
| A, B, C, D | modulation dependent linearization parameters |
| Polarization φ | φ rotation around probe axis |
| Polarization θ | θ rotation around an axis that is in the plane normal to probe axis (at measurement center), i.e., θ = 0 is normal to probe axis |
| Connector Angle | information used in DASY system to align probe sensor X to the robot coordinate system |

Calibration is Performed According to the Following Standards:

- IEEE Std 1528-2013, "IEEE Recommended Practice for Determining the Peak Spatial-Averaged Specific Absorption Rate (SAR) in the Human Head from Wireless Communications Devices: Measurement Techniques", June 2013
- IEC 62209-1, "Procedure to measure the Specific Absorption Rate (SAR) for hand-held devices used in close proximity to the ear (frequency range of 300 MHz to 3 GHz)", February 2005
- IEC 62209-2, "Procedure to determine the Specific Absorption Rate (SAR) for wireless communication devices used in close proximity to the human body (frequency range of 30 MHz to 6 GHz)", March 2010
- KDB 865664, "SAR Measurement Requirements for 100 MHz to 6 GHz"

Methods Applied and Interpretation of Parameters:

- NORM_{x,y,z}:** Assessed for E-field polarization θ = 0 (f ≤ 900 MHz in TEM-cell; f > 1800 MHz: R22 waveguide). NORM_{x,y,z} are only intermediate values, i.e., the uncertainties of NORM_{x,y,z} does not affect the E²-field uncertainty inside TSL (see below ConvF).
- NORM(f)_{x,y,z} = NORM_{x,y,z} * frequency_response** (see Frequency Response Chart). This linearization is implemented in DASY4 software versions later than 4.2. The uncertainty of the frequency response is included in the stated uncertainty of ConvF.
- DCP_{x,y,z}:** DCP are numerical linearization parameters assessed based on the data of power sweep with CW signal (no uncertainty required). DCP does not depend on frequency nor media.
- PAR:** PAR is the Peak to Average Ratio that is not calibrated but determined based on the signal characteristics
- A_{x,y,z}; B_{x,y,z}; C_{x,y,z}; D_{x,y,z}; VR_{x,y,z}:** A, B, C, D are numerical linearization parameters assessed based on the data of power sweep for specific modulation signal. The parameters do not depend on frequency nor media. VR is the maximum calibration range expressed in RMS voltage across the diode.
- ConvF and Boundary Effect Parameters:** Assessed in flat phantom using E-field (or Temperature Transfer Standard for f ≤ 800 MHz) and inside waveguide using analytical field distributions based on power measurements for f > 800 MHz. The same setups are used for assessment of the parameters applied for boundary compensation (alpha, depth) of which typical uncertainty values are given. These parameters are used in DASY4 software to improve probe accuracy close to the boundary. The sensitivity in TSL corresponds to NORM_{x,y,z} * ConvF whereby the uncertainty corresponds to that given for ConvF. A frequency dependent ConvF is used in DASY version 4.4 and higher which allows extending the validity from ± 50 MHz to ± 100 MHz.
- Spherical isotropy (3D deviation from isotropy):** in a field of low gradients realized using a flat phantom exposed by a patch antenna.
- Sensor Offset:** The sensor offset corresponds to the offset of virtual measurement center from the probe tip (on probe axis). No tolerance required.
- Connector Angle:** The angle is assessed using the information gained by determining the NORM_x (no uncertainty required).

| | | | |
|-----------------|-------------------------------|---------------|------------|
| Test Report #: | SAR-FION-002-17001_Appendix_C | FCC ID: | 2ANVA-V200 |
| Date of Report: | 2018-02-12 | IC Cert. No.: | 22342-V200 |



ES3DV3 – SN:3323

May 12, 2017

Probe ES3DV3

SN:3323

Manufactured: January 10, 2012
Calibrated: May 12, 2017

Calibrated for DASY/EASY Systems
(Note: non-compatible with DASY2 system!)

| | | | |
|-----------------|-------------------------------|---------------|------------|
| Test Report #: | SAR-FION-002-17001_Appendix_C | FCC ID: | 2ANVA-V200 |
| Date of Report: | 2018-02-12 | IC Cert. No.: | 22342-V200 |



ES3DV3- SN:3323

May 12, 2017

DASY/EASY - Parameters of Probe: ES3DV3 - SN:3323

Basic Calibration Parameters

| | Sensor X | Sensor Y | Sensor Z | Unc (k=2) |
|---|----------|----------|----------|---------------|
| Norm ($\mu\text{V}/(\text{V}/\text{m})^2$) ^A | 0.94 | 1.03 | 0.95 | $\pm 10.1 \%$ |
| DCP (mV) ^B | 106.4 | 106.6 | 104.4 | |

Modulation Calibration Parameters

| UID | Communication System Name | | A dB | B dB $\sqrt{\mu\text{V}}$ | C | D dB | VR mV | Unc ^E (k=2) |
|-----|---------------------------|---|---------|------------------------------|-----|---------|----------|---------------------------|
| 0 | CW | X | 0.0 | 0.0 | 1.0 | 0.00 | 178.8 | $\pm 2.7 \%$ |
| | | Y | 0.0 | 0.0 | 1.0 | | 195.7 | |
| | | Z | 0.0 | 0.0 | 1.0 | | 187.4 | |

Note: For details on UID parameters see Appendix.

The reported uncertainty of measurement is stated as the standard uncertainty of measurement multiplied by the coverage factor $k=2$, which for a normal distribution corresponds to a coverage probability of approximately 95%.

^A The uncertainties of Norm X,Y,Z do not affect the E²-field uncertainty inside TSL (see Pages 5 and 6).

^B Numerical linearization parameter: uncertainty not required.

^E Uncertainty is determined using the max. deviation from linear response applying rectangular distribution and is expressed for the square of the field value.

| | | | |
|-----------------|-------------------------------|---------------|------------|
| Test Report #: | SAR-FION-002-17001_Appendix_C | FCC ID: | 2ANVA-V200 |
| Date of Report: | 2018-02-12 | IC Cert. No.: | 22342-V200 |



ES3DV3– SN:3323

May 12, 2017

DASY/EASY - Parameters of Probe: ES3DV3 - SN:3323

Calibration Parameter Determined in Head Tissue Simulating Media

| f (MHz) ^C | Relative Permittivity ^F | Conductivity (S/m) ^F | ConvF X | ConvF Y | ConvF Z | Alpha ^G | Depth ^G (mm) | Unc (k=2) |
|----------------------|------------------------------------|---------------------------------|---------|---------|---------|--------------------|-------------------------|-----------|
| 750 | 41.9 | 0.89 | 6.49 | 6.49 | 6.49 | 0.80 | 1.24 | ± 12.0 % |
| 835 | 41.5 | 0.90 | 6.38 | 6.38 | 6.38 | 0.80 | 1.18 | ± 12.0 % |
| 900 | 41.5 | 0.97 | 6.24 | 6.24 | 6.24 | 0.50 | 1.48 | ± 12.0 % |
| 1750 | 40.1 | 1.37 | 5.47 | 5.47 | 5.47 | 0.74 | 1.19 | ± 12.0 % |
| 1900 | 40.0 | 1.40 | 5.18 | 5.18 | 5.18 | 0.45 | 1.61 | ± 12.0 % |
| 1950 | 40.0 | 1.40 | 5.12 | 5.12 | 5.12 | 0.80 | 1.17 | ± 12.0 % |
| 2300 | 39.5 | 1.67 | 5.05 | 5.05 | 5.05 | 0.80 | 1.19 | ± 12.0 % |
| 2450 | 39.2 | 1.80 | 4.68 | 4.68 | 4.68 | 0.76 | 1.28 | ± 12.0 % |
| 2550 | 39.1 | 1.91 | 4.63 | 4.63 | 4.63 | 0.76 | 1.32 | ± 12.0 % |

^C Frequency validity above 300 MHz of ± 100 MHz only applies for DASY v4.4 and higher (see Page 2), else it is restricted to ± 50 MHz. The uncertainty is the RSS of the ConvF uncertainty at calibration frequency and the uncertainty for the indicated frequency band. Frequency validity below 300 MHz is ± 10, 25, 40, 50 and 70 MHz for ConvF assessments at 30, 64, 128, 150 and 220 MHz respectively. Above 5 GHz frequency validity can be extended to ± 110 MHz.

^F At frequencies below 3 GHz, the validity of tissue parameters (ϵ and σ) can be relaxed to ± 10% if liquid compensation formula is applied to measured SAR values. At frequencies above 3 GHz, the validity of tissue parameters (ϵ and σ) is restricted to ± 5%. The uncertainty is the RSS of the ConvF uncertainty for indicated target tissue parameters.

^G Alpha/Depth are determined during calibration. SPEAG warrants that the remaining deviation due to the boundary effect after compensation is always less than ± 1% for frequencies below 3 GHz and below ± 2% for frequencies between 3-6 GHz at any distance larger than half the probe tip diameter from the boundary.

| | | | |
|-----------------|-------------------------------|---------------|------------|
| Test Report #: | SAR-FION-002-17001_Appendix_C | FCC ID: | 2ANVA-V200 |
| Date of Report: | 2018-02-12 | IC Cert. No.: | 22342-V200 |



ES3DV3- SN:3323

May 12, 2017

DASY/EASY - Parameters of Probe: ES3DV3 - SN:3323

Calibration Parameter Determined in Body Tissue Simulating Media

| f (MHz) ^C | Relative Permittivity ^F | Conductivity (S/m) ^F | ConvF X | ConvF Y | ConvF Z | Alpha ^G | Depth (mm) ^G | Unc (k=2) |
|----------------------|------------------------------------|---------------------------------|---------|---------|---------|--------------------|-------------------------|-----------|
| 750 | 55.5 | 0.96 | 6.49 | 6.49 | 6.49 | 0.49 | 1.55 | ± 12.0 % |
| 835 | 55.2 | 0.97 | 6.38 | 6.38 | 6.38 | 0.59 | 1.39 | ± 12.0 % |
| 900 | 55.0 | 1.05 | 6.31 | 6.31 | 6.31 | 0.63 | 1.31 | ± 12.0 % |
| 1750 | 53.4 | 1.49 | 5.15 | 5.15 | 5.15 | 0.55 | 1.46 | ± 12.0 % |
| 1900 | 53.3 | 1.52 | 4.97 | 4.97 | 4.97 | 0.70 | 1.33 | ± 12.0 % |
| 1950 | 53.3 | 1.52 | 5.09 | 5.09 | 5.09 | 0.62 | 1.44 | ± 12.0 % |
| 2300 | 52.9 | 1.81 | 4.71 | 4.71 | 4.71 | 0.80 | 1.24 | ± 12.0 % |
| 2450 | 52.7 | 1.95 | 4.60 | 4.60 | 4.60 | 0.80 | 1.16 | ± 12.0 % |
| 2550 | 52.6 | 2.09 | 4.45 | 4.45 | 4.45 | 0.80 | 1.10 | ± 12.0 % |

^C Frequency validity above 300 MHz of ± 100 MHz only applies for DASY v4.4 and higher (see Page 2), else it is restricted to ± 50 MHz. The uncertainty is the RSS of the ConvF uncertainty at calibration frequency and the uncertainty for the indicated frequency band. Frequency validity below 300 MHz is ± 10, 25, 40, 50 and 70 MHz for ConvF assessments at 30, 64, 128, 150 and 220 MHz respectively. Above 5 GHz frequency validity can be extended to ± 110 MHz.

^F At frequencies below 3 GHz, the validity of tissue parameters (ϵ and σ) can be relaxed to ± 10% if liquid compensation formula is applied to measured SAR values. At frequencies above 3 GHz, the validity of tissue parameters (ϵ and σ) is restricted to ± 5%. The uncertainty is the RSS of the ConvF uncertainty for indicated target tissue parameters.

^G Alpha/Depth are determined during calibration. SPEAG warrants that the remaining deviation due to the boundary effect after compensation is always less than ± 1% for frequencies below 3 GHz and below ± 2% for frequencies between 3-6 GHz at any distance larger than half the probe tip diameter from the boundary.

| | | | |
|-----------------|-------------------------------|---------------|------------|
| Test Report #: | SAR-FION-002-17001_Appendix_C | FCC ID: | 2ANVA-V200 |
| Date of Report: | 2018-02-12 | IC Cert. No.: | 22342-V200 |



ES3DV3– SN:3323

May 12, 2017

Frequency Response of E-Field (TEM-Cell:ifi110 EXX, Waveguide: R22)

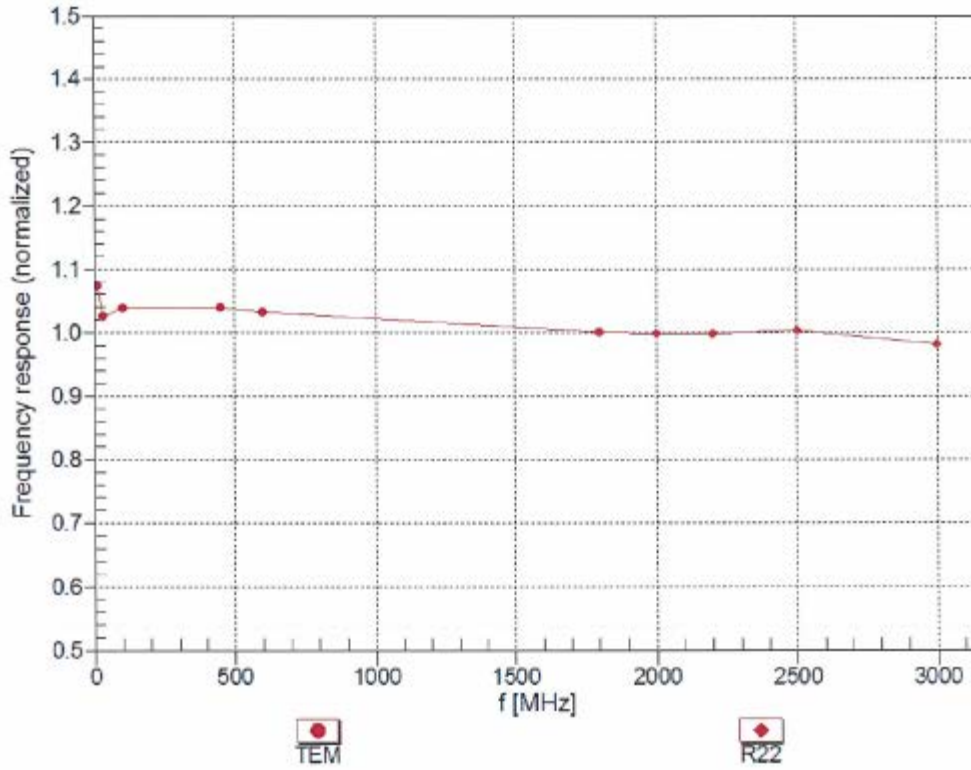

Uncertainty of Frequency Response of E-field: $\pm 6.3\%$ (k=2)

| | | | |
|-----------------|-------------------------------|---------------|------------|
| Test Report #: | SAR-FION-002-17001_Appendix_C | FCC ID: | 2ANVA-V200 |
| Date of Report: | 2018-02-12 | IC Cert. No.: | 22342-V200 |



ES3DV3- SN:3323

May 12, 2017

Receiving Pattern (ϕ), $\theta = 0^\circ$

f=600 MHz, TEM

f=1800 MHz, R22

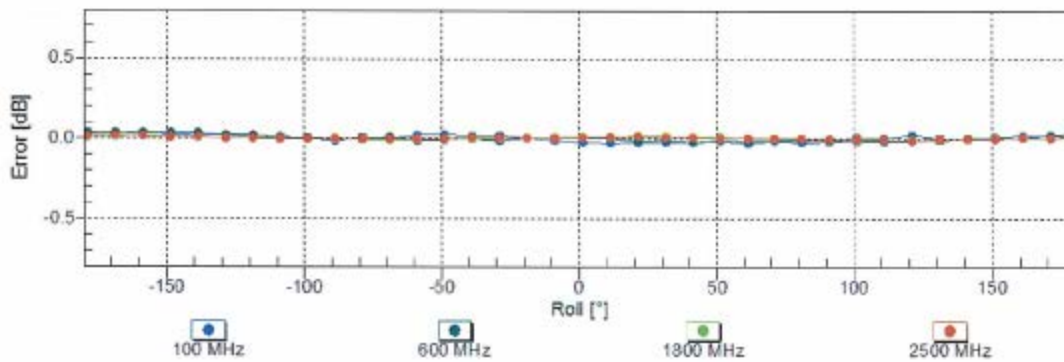
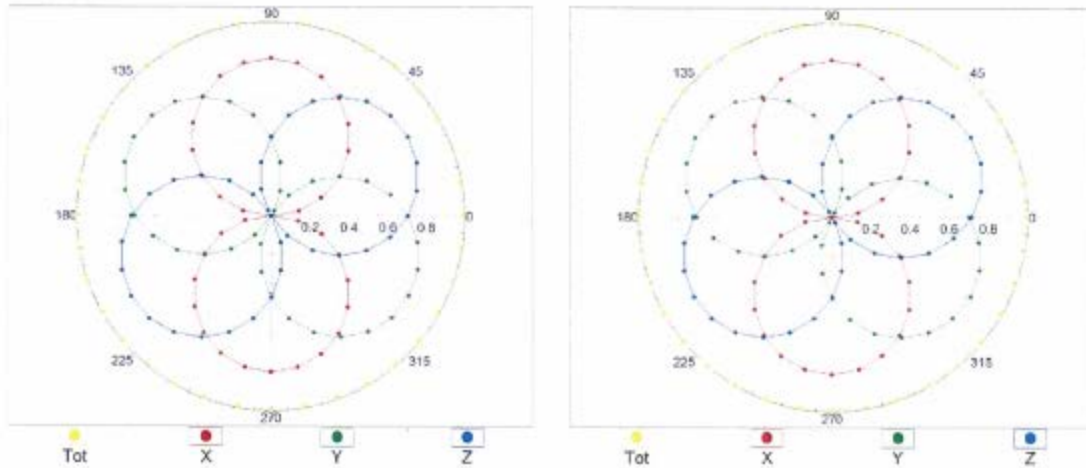

Uncertainty of Axial Isotropy Assessment: $\pm 0.5\%$ (k=2)

| | | | |
|-----------------|-------------------------------|---------------|------------|
| Test Report #: | SAR-FION-002-17001_Appendix_C | FCC ID: | 2ANVA-V200 |
| Date of Report: | 2018-02-12 | IC Cert. No.: | 22342-V200 |



ES3DV3- SN:3323

May 12, 2017

Dynamic Range $f(SAR_{head})$ (TEM cell , $f_{eval} = 1900$ MHz)

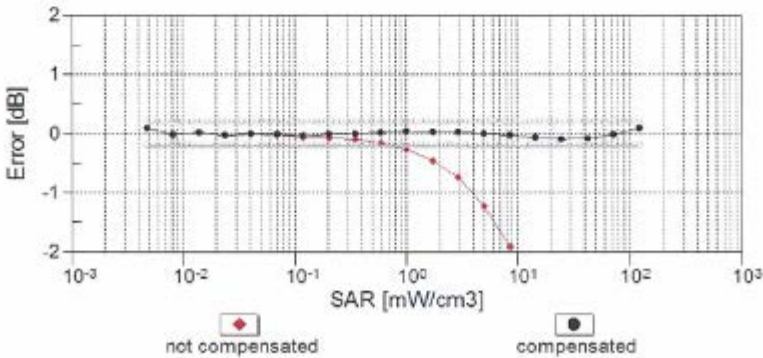
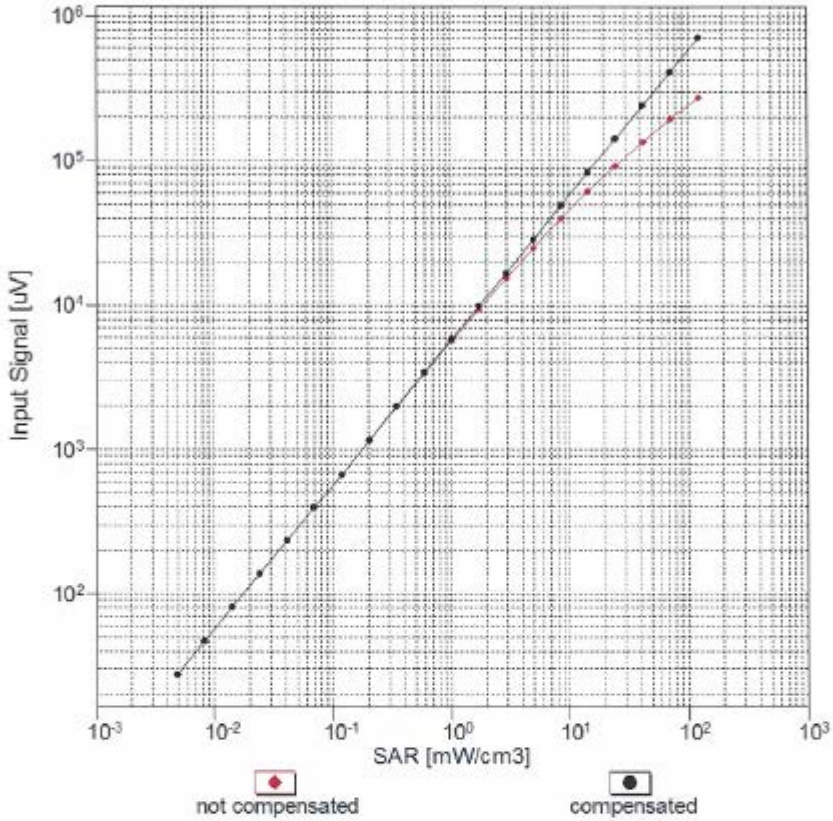

Uncertainty of Linearity Assessment: $\pm 0.6\%$ (k=2)

Conversion Factor Assessment

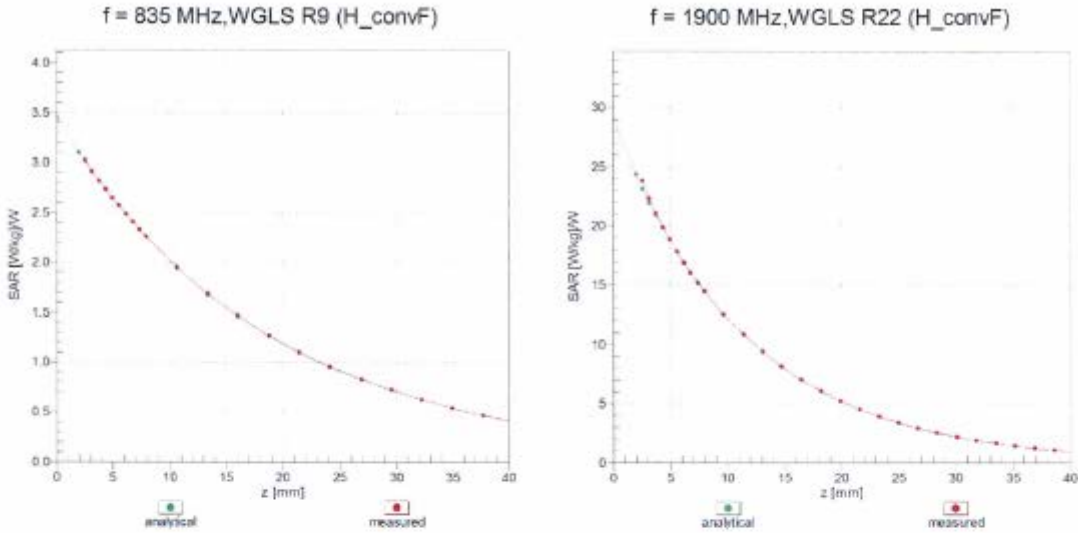

Deviation from Isotropy in Liquid Error (ϕ, ϑ), f = 900 MHz

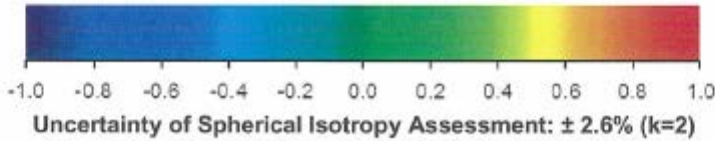
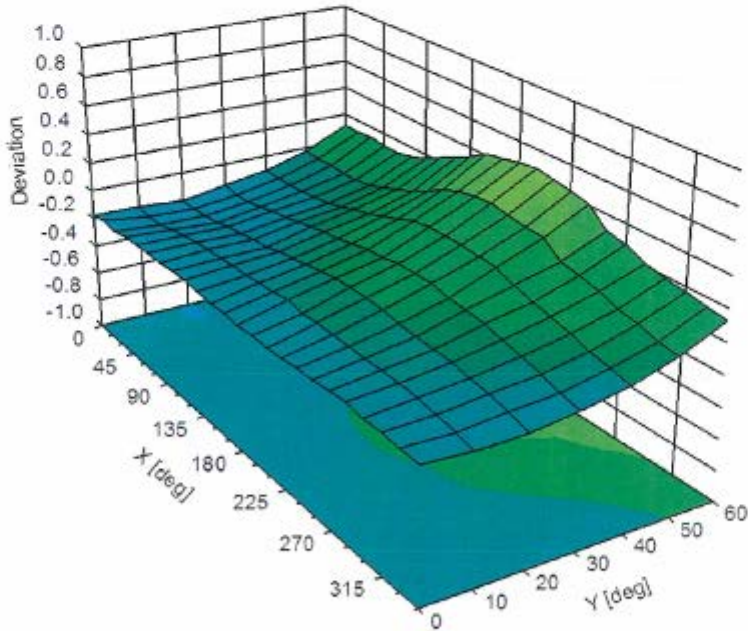

| | | | |
|-----------------|-------------------------------|---------------|------------|
| Test Report #: | SAR-FION-002-17001_Appendix_C | FCC ID: | 2ANVA-V200 |
| Date of Report: | 2018-02-12 | IC Cert. No.: | 22342-V200 |



ES3DV3- SN:3323

May 12, 2017

DASY/EASY - Parameters of Probe: ES3DV3 - SN:3323

Other Probe Parameters

| | |
|---|------------|
| Sensor Arrangement | Triangular |
| Connector Angle (°) | 21.3 |
| Mechanical Surface Detection Mode | enabled |
| Optical Surface Detection Mode | disabled |
| Probe Overall Length | 337 mm |
| Probe Body Diameter | 10 mm |
| Tip Length | 10 mm |
| Tip Diameter | 4 mm |
| Probe Tip to Sensor X Calibration Point | 2 mm |
| Probe Tip to Sensor Y Calibration Point | 2 mm |
| Probe Tip to Sensor Z Calibration Point | 2 mm |
| Recommended Measurement Distance from Surface | 3 mm |

ES3DV3- SN:3323

May 12, 2017

Modulation Calibration Parameters

| UID | Communication System Name | | A dB | B dB $\sqrt{\mu V}$ | C | D dB | VR mV | Unc ^E (k=2) |
|-----------|--|---|---------|------------------------|------|---------|----------|---------------------------|
| 0 | CW | X | 0.0 | 0.0 | 1.0 | 0.00 | 178.8 | ±2.7 % |
| | | Y | 0.0 | 0.0 | 1.0 | | 195.7 | |
| | | Z | 0.0 | 0.0 | 1.0 | | 187.4 | |
| 10011-CAB | UMTS-FDD (WCDMA) | X | 3.56 | 68.3 | 18.9 | 2.91 | 145.1 | ±0.5 % |
| | | Y | 3.48 | 68.5 | 19.3 | | 114.5 | |
| | | Z | 3.47 | 67.8 | 18.8 | | 108.4 | |
| 10021-DAC | GSM-FDD (TDMA, GMSK) | X | 18.67 | 89.6 | 25.0 | 9.39 | 98.4 | ±0.9 % |
| | | Y | 34.44 | 99.7 | 29.0 | | 134.0 | |
| | | Z | 31.99 | 99.1 | 29.3 | | 124.4 | |
| 10024-DAC | GPRS-FDD (TDMA, GMSK, TN 0-1) | X | 20.55 | 88.1 | 22.3 | 6.56 | 109.6 | ±1.2 % |
| | | Y | 51.06 | 99.6 | 26.0 | | 95.2 | |
| | | Z | 15.88 | 83.4 | 21.7 | | 135.6 | |
| 10027-DAC | GPRS-FDD (TDMA, GMSK, TN 0-1-2) | X | 28.40 | 90.0 | 21.2 | 4.80 | 120.0 | ±1.4 % |
| | | Y | 61.08 | 99.9 | 24.7 | | 101.3 | |
| | | Z | 25.01 | 90.0 | 22.6 | | 137.7 | |
| 10028-DAC | GPRS-FDD (TDMA, GMSK, TN 0-1-2-3) | X | 7.58 | 74.1 | 15.1 | 3.55 | 123.4 | ±1.7 % |
| | | Y | 53.57 | 99.6 | 24.1 | | 102.2 | |
| | | Z | 55.82 | 99.7 | 24.2 | | 137.0 | |
| 10081-CAB | CDMA2000 (1xRTT, RC3) | X | 4.14 | 66.8 | 18.6 | 3.97 | 138.2 | ±0.7 % |
| | | Y | 3.99 | 66.3 | 18.6 | | 114.4 | |
| | | Z | 4.25 | 67.3 | 19.0 | | 142.3 | |
| 10100-CAC | LTE-FDD (SC-FDMA, 100% RB, 20 MHz, QPSK) | X | 6.14 | 66.4 | 18.9 | 5.67 | 109.4 | ±1.2 % |
| | | Y | 6.46 | 67.7 | 19.7 | | 129.2 | |
| | | Z | 6.37 | 67.1 | 19.3 | | 118.1 | |
| 10103-CAC | LTE-TDD (SC-FDMA, 100% RB, 20 MHz, QPSK) | X | 11.48 | 75.6 | 25.1 | 9.29 | 113.2 | ±2.7 % |
| | | Y | 14.25 | 80.5 | 27.5 | | 149.5 | |
| | | Z | 13.70 | 78.8 | 26.5 | | 138.0 | |
| 10108-CAD | LTE-FDD (SC-FDMA, 100% RB, 10 MHz, QPSK) | X | 6.15 | 66.3 | 19.0 | 5.80 | 109.8 | ±1.2 % |
| | | Y | 6.44 | 67.5 | 19.8 | | 128.5 | |
| | | Z | 6.40 | 67.1 | 19.4 | | 118.4 | |
| 10151-CAC | LTE-TDD (SC-FDMA, 50% RB, 20 MHz, QPSK) | X | 11.01 | 75.2 | 25.1 | 9.28 | 109.5 | ±2.7 % |
| | | Y | 13.57 | 79.9 | 27.3 | | 143.3 | |
| | | Z | 13.17 | 78.3 | 26.4 | | 133.0 | |
| 10154-CAD | LTE-FDD (SC-FDMA, 50% RB, 10 MHz, QPSK) | X | 5.89 | 65.9 | 18.8 | 5.75 | 108.2 | ±1.2 % |
| | | Y | 6.14 | 66.9 | 19.5 | | 126.4 | |
| | | Z | 6.09 | 66.5 | 19.1 | | 116.2 | |
| 10169-CAC | LTE-FDD (SC-FDMA, 1 RB, 20 MHz, QPSK) | X | 5.20 | 67.0 | 19.5 | 5.73 | 133.6 | ±0.9 % |
| | | Y | 4.97 | 66.0 | 19.1 | | 111.8 | |
| | | Z | 5.40 | 67.4 | 19.9 | | 144.2 | |

| | | | |
|-----------------|-------------------------------|---------------|------------|
| Test Report #: | SAR-FION-002-17001_Appendix_C | FCC ID: | 2ANVA-V200 |
| Date of Report: | 2018-02-12 | IC Cert. No.: | 22342-V200 |



ES3DV3– SN:3323

May 12, 2017

| | | | | | | | | |
|-----------|---|---|-------|------|------|------|-------|--------|
| 10172-CAC | LTE-TDD (SC-FDMA, 1 RB, 20 MHz, QPSK) | X | 10.80 | 80.1 | 27.4 | 9.21 | 126.2 | ±2.2 % |
| | | Y | 11.04 | 79.5 | 27.2 | | 107.6 | |
| | | Z | 12.99 | 82.8 | 28.5 | | 146.6 | |
| 10175-CAD | LTE-FDD (SC-FDMA, 1 RB, 10 MHz, QPSK) | X | 5.19 | 67.0 | 19.5 | 5.72 | 132.5 | ±0.9 % |
| | | Y | 5.45 | 68.2 | 20.4 | | 149.6 | |
| | | Z | 5.37 | 67.3 | 19.8 | | 137.9 | |
| 10297-AAB | LTE-FDD (SC-FDMA, 50% RB, 20 MHz, QPSK) | X | 6.18 | 66.4 | 19.0 | 5.81 | 113.1 | ±1.2 % |
| | | Y | 6.44 | 67.5 | 19.8 | | 123.2 | |
| | | Z | 6.28 | 66.6 | 19.2 | | 112.6 | |
| 10403-AAB | CDMA2000 (1xEV-DO, Rev. 0) | X | 4.75 | 67.2 | 18.2 | 3.76 | 109.0 | ±0.5 % |
| | | Y | 4.72 | 67.0 | 18.3 | | 123.7 | |
| | | Z | 4.72 | 66.7 | 18.0 | | 111.0 | |

^E Uncertainty is determined using the max. deviation from linear response applying rectangular distribution and is expressed for the square of the field value.

| | | | |
|-----------------|-------------------------------|---------------|------------|
| Test Report #: | SAR-FION-002-17001_Appendix_C | FCC ID: | 2ANVA-V200 |
| Date of Report: | 2018-02-12 | IC Cert. No.: | 22342-V200 |

1.1. DAE4 - SN 1266 May 2017

Schmid & Partner Engineering AG

s p e a g

Zeughausstrasse 43, 8004 Zurich, Switzerland
 Phone +41 44 245 9700, Fax +41 44 245 9779
 info@speag.com, http://www.speag.com

1266

IMPORTANT NOTICE

USAGE OF THE DAE 4

The DAE unit is a delicate, high precision instrument and requires careful treatment by the user. There are no serviceable parts inside the DAE. Special attention shall be given to the following points:

Battery Exchange: The battery cover of the DAE4 unit is closed using a screw, over tightening the screw may cause the threads inside the DAE to wear out.

Shipping of the DAE: Before shipping the DAE to SPEAG for calibration, remove the batteries and pack the DAE in an antistatic bag. This antistatic bag shall then be packed into a larger box or container which protects the DAE from impacts during transportation. The package shall be marked to indicate that a fragile instrument is inside.

E-Stop Failures: Touch detection may be malfunctioning due to broken magnets in the E-stop. Rough handling of the E-stop may lead to damage of these magnets. Touch and collision errors are often caused by dust and dirt accumulated in the E-stop. To prevent E-stop failure, the customer shall always mount the probe to the DAE carefully and keep the DAE unit in a non-dusty environment if not used for measurements.

Repair: Minor repairs are performed at no extra cost during the annual calibration. However, SPEAG reserves the right to charge for any repair especially if rough unprofessional handling caused the defect.

DASY Configuration Files: Since the exact values of the DAE input resistances, as measured during the calibration procedure of a DAE unit, are not used by the DASY software, a nominal value of 200 MOhm is given in the corresponding configuration file.

Important Note:

Warranty and calibration is void if the DAE unit is disassembled partly or fully by the Customer.

Important Note:

Never attempt to grease or oil the E-stop assembly. Cleaning and readjusting of the E-stop assembly is allowed by certified SPEAG personnel only and is part of the annual calibration procedure.

Important Note:

To prevent damage of the DAE probe connector pins, use great care when installing the probe to the DAE. Carefully connect the probe with the connector notch oriented in the mating position. Avoid any rotational movement of the probe body versus the DAE while turning the locking nut of the connector. The same care shall be used when disconnecting the probe from the DAE.

Schmid & Partner Engineering

TN_BR040315AD DAE4.doc

11.12.2009

| | |
|--|--------------------------|
| Test Report #: SAR-FION-002-17001_Appendix_C | FCC ID: 2ANVA-V200 |
| Date of Report: 2018-02-12 | IC Cert. No.: 22342-V200 |



**Calibration Laboratory of
Schmid & Partner
Engineering AG**
Zeughausstrasse 43, 8004 Zurich, Switzerland



S Schweizerischer Kalibrierdienst
C Service suisse d'étalonnage
S Servizio svizzero di taratura
S Swiss Calibration Service

Accredited by the Swiss Accreditation Service (SAS)
The Swiss Accreditation Service is one of the signatories to the EA
Multilateral Agreement for the recognition of calibration certificates

Accreditation No.: **SCS 0108**

Client **Cetecom USA**

Certificate No: **DAE4-1266_May17**

CALIBRATION CERTIFICATE

Object **DAE4 - SD 000 D04 BM - SN: 1266**

Calibration procedure(s) **QA CAL-06.v29
Calibration procedure for the data acquisition electronics (DAE)**

Calibration date: **May 16, 2017**

This calibration certificate documents the traceability to national standards, which realize the physical units of measurements (SI).
The measurements and the uncertainties with confidence probability are given on the following pages and are part of the certificate.

All calibrations have been conducted in the closed laboratory facility: environment temperature $(22 \pm 3)^\circ\text{C}$ and humidity $< 70\%$.

Calibration Equipment used (M&TE critical for calibration)

| Primary Standards | ID # | Cal Date (Certificate No.) | Scheduled Calibration |
|-------------------------------|--------------------|----------------------------|------------------------|
| Keithley Multimeter Type 2001 | SN: 0810278 | 09-Sep-16 (No:19065) | Sep-17 |
| Secondary Standards | ID # | Check Date (in house) | Scheduled Check |
| Auto DAE Calibration Unit | SE UWS 053 AA 1001 | 05-Jan-17 (in house check) | In house check: Jan-18 |
| Calibrator Box V2.1 | SE UMS 006 AA 1002 | 05-Jan-17 (in house check) | In house check: Jan-18 |

Calibrated by: **Name** Adrian Gehring **Function** Technician

Signature

Approved by: **Name** Fin Bornholt **Function** Deputy Technical Manager

Issued: May 16, 2017

This calibration certificate shall not be reproduced except in full without written approval of the laboratory.

| | | | |
|-----------------|-------------------------------|---------------|------------|
| Test Report #: | SAR-FION-002-17001_Appendix_C | FCC ID: | 2ANVA-V200 |
| Date of Report: | 2018-02-12 | IC Cert. No.: | 22342-V200 |

**Calibration Laboratory of
Schmid & Partner
Engineering AG**
Zeughausstrasse 43, 8004 Zurich, Switzerland



S Schweizerischer Kalibrierdienst
C Service suisse d'étalonnage
S Servizio svizzero di taratura
S Swiss Calibration Service

Accredited by the Swiss Accreditation Service (SAS)

The Swiss Accreditation Service is one of the signatories to the EA
Multilateral Agreement for the recognition of calibration certificates

Accreditation No.: **SCS 0108**

Glossary

DAE data acquisition electronics
Connector angle information used in DASY system to align probe sensor X to the robot coordinate system.

Methods Applied and Interpretation of Parameters

- **DC Voltage Measurement:** Calibration Factor assessed for use in DASY system by comparison with a calibrated instrument traceable to national standards. The figure given corresponds to the full scale range of the voltmeter in the respective range.
- **Connector angle:** The angle of the connector is assessed measuring the angle mechanically by a tool inserted. Uncertainty is not required.
- The following parameters as documented in the Appendix contain technical information as a result from the performance test and require no uncertainty.
 - **DC Voltage Measurement Linearity:** Verification of the Linearity at +10% and -10% of the nominal calibration voltage. Influence of offset voltage is included in this measurement.
 - **Common mode sensitivity:** Influence of a positive or negative common mode voltage on the differential measurement.
 - **Channel separation:** Influence of a voltage on the neighbor channels not subject to an input voltage.
 - **AD Converter Values with inputs shorted:** Values on the internal AD converter corresponding to zero input voltage
 - **Input Offset Measurement:** Output voltage and statistical results over a large number of zero voltage measurements.
 - **Input Offset Current:** Typical value for information; Maximum channel input offset current, not considering the input resistance.
 - **Input resistance:** Typical value for information: DAE input resistance at the connector, during internal auto-zeroing and during measurement.
 - **Low Battery Alarm Voltage:** Typical value for information. Below this voltage, a battery alarm signal is generated.
 - **Power consumption:** Typical value for information. Supply currents in various operating modes.

| | | | |
|-----------------|-------------------------------|---------------|------------|
| Test Report #: | SAR-FION-002-17001_Appendix_C | FCC ID: | 2ANVA-V200 |
| Date of Report: | 2018-02-12 | IC Cert. No.: | 22342-V200 |

DC Voltage Measurement

A/D - Converter Resolution nominal

High Range: 1LSB = 6.1 μ V, full range = -100...+300 mV

Low Range: 1LSB = 61nV, full range = -1.....+3mV

DASY measurement parameters: Auto Zero Time: 3 sec; Measuring time: 3 sec

| Calibration Factors | X | Y | Z |
|---------------------|---------------------------|---------------------------|---------------------------|
| High Range | 405.100 \pm 0.02% (k=2) | 404.425 \pm 0.02% (k=2) | 405.131 \pm 0.02% (k=2) |
| Low Range | 3.96533 \pm 1.50% (k=2) | 3.96575 \pm 1.50% (k=2) | 3.99340 \pm 1.50% (k=2) |

Connector Angle

| | |
|---|------------------------------------|
| Connector Angle to be used in DASY system | 62.0 $^{\circ}$ \pm 1 $^{\circ}$ |
|---|------------------------------------|

Appendix (Additional assessments outside the scope of SCS0108)

1. DC Voltage Linearity

| High Range | Reading (μV) | Difference (μV) | Error (%) |
|-------------------|---------------------------|------------------------------|-----------|
| Channel X + Input | 199992.99 | 0.32 | 0.00 |
| Channel X + Input | 20001.26 | 0.32 | 0.00 |
| Channel X - Input | -19999.61 | 1.43 | -0.01 |
| Channel Y + Input | 199993.14 | 0.50 | 0.00 |
| Channel Y + Input | 20001.25 | 0.38 | 0.00 |
| Channel Y - Input | -20002.55 | -1.43 | 0.01 |
| Channel Z + Input | 199993.40 | 0.88 | 0.00 |
| Channel Z + Input | 19999.60 | -1.33 | -0.01 |
| Channel Z - Input | -20002.30 | -1.22 | 0.01 |

| Low Range | Reading (μV) | Difference (μV) | Error (%) |
|-------------------|---------------------------|------------------------------|-----------|
| Channel X + Input | 2001.14 | 0.40 | 0.02 |
| Channel X + Input | 202.27 | 1.12 | 0.56 |
| Channel X - Input | -198.05 | 0.60 | -0.30 |
| Channel Y + Input | 2000.87 | 0.04 | 0.00 |
| Channel Y + Input | 200.90 | -0.38 | -0.19 |
| Channel Y - Input | -198.79 | -0.15 | 0.07 |
| Channel Z + Input | 2000.07 | -0.66 | -0.03 |
| Channel Z + Input | 200.05 | -1.16 | -0.58 |
| Channel Z - Input | -198.91 | -0.19 | 0.10 |

2. Common mode sensitivity

DASY measurement parameters: Auto Zero Time: 3 sec; Measuring time: 3 sec

| | Common mode Input Voltage (mV) | High Range Average Reading (μV) | Low Range Average Reading (μV) |
|-----------|--------------------------------|--|---|
| Channel X | 200 | 23.24 | 21.54 |
| | - 200 | -20.37 | -21.76 |
| Channel Y | 200 | 10.90 | 10.97 |
| | - 200 | -11.91 | -12.47 |
| Channel Z | 200 | -10.12 | -9.85 |
| | - 200 | 8.85 | 8.60 |

3. Channel separation

DASY measurement parameters: Auto Zero Time: 3 sec; Measuring time: 3 sec

| | Input Voltage (mV) | Channel X (μV) | Channel Y (μV) | Channel Z (μV) |
|-----------|--------------------|-----------------------------|-----------------------------|-----------------------------|
| Channel X | 200 | - | -0.13 | -3.54 |
| Channel Y | 200 | 6.10 | - | 1.26 |
| Channel Z | 200 | 9.04 | 4.10 | - |

4. AD-Converter Values with inputs shorted

DASY measurement parameters: Auto Zero Time: 3 sec; Measuring time: 3 sec

| | High Range (LSB) | Low Range (LSB) |
|-----------|------------------|-----------------|
| Channel X | 15787 | 16946 |
| Channel Y | 15723 | 16579 |
| Channel Z | 16204 | 15801 |

5. Input Offset Measurement

DASY measurement parameters: Auto Zero Time: 3 sec; Measuring time: 3 sec

Input 10M Ω

| | Average (μ V) | min. Offset (μ V) | max. Offset (μ V) | Std. Deviation (μ V) |
|-----------|--------------------|------------------------|------------------------|---------------------------|
| Channel X | 1.07 | -0.43 | 2.63 | 0.60 |
| Channel Y | -0.28 | -1.86 | 1.36 | 0.56 |
| Channel Z | -0.52 | -2.30 | 1.55 | 0.60 |

6. Input Offset Current

Nominal Input circuitry offset current on all channels: <25fA

7. Input Resistance (Typical values for information)

| | Zeroing (kOhm) | Measuring (MOhm) |
|-----------|----------------|------------------|
| Channel X | 200 | 200 |
| Channel Y | 200 | 200 |
| Channel Z | 200 | 200 |

8. Low Battery Alarm Voltage (Typical values for information)

| Typical values | Alarm Level (VDC) |
|----------------|-------------------|
| Supply (+ Vcc) | +7.9 |
| Supply (- Vcc) | -7.6 |

9. Power Consumption (Typical values for information)

| Typical values | Switched off (mA) | Stand by (mA) | Transmitting (mA) |
|----------------|-------------------|---------------|-------------------|
| Supply (+ Vcc) | +0.01 | +6 | +14 |
| Supply (- Vcc) | -0.01 | -8 | -9 |

| | | | |
|-----------------|-------------------------------|---------------|------------|
| Test Report #: | SAR-FION-002-17001_Appendix_C | FCC ID: | 2ANVA-V200 |
| Date of Report: | 2018-02-12 | IC Cert. No.: | 22342-V200 |



1.1. D900V2-1d11 May 2016

**Calibration Laboratory of
Schmid & Partner
Engineering AG**
Zeughausstrasse 43, 8004 Zurich, Switzerland



S Schweizerischer Kalibrierdienst
C Service suisse d'étalonnage
S Servizio svizzero di taratura
S Swiss Calibration Service

Accredited by the Swiss Accreditation Service (SAS)
The Swiss Accreditation Service is one of the signatories to the EA
Multilateral Agreement for the recognition of calibration certificates

Accreditation No.: **SCS 0108**

Client **Cetecom USA**

Certificate No: **D900V2-1d110_May16**

CALIBRATION CERTIFICATE

Object **D900V2 - SN:1d110**

Calibration procedure(s) **QA CAL-05.v9
Calibration procedure for dipole validation kits above 700 MHz**

Calibration date: **May 11, 2016**

This calibration certificate documents the traceability to national standards, which realize the physical units of measurements (SI).
The measurements and the uncertainties with confidence probability are given on the following pages and are part of the certificate.

All calibrations have been conducted in the closed laboratory facility: environment temperature (22 ± 3)°C and humidity < 70%.

Calibration Equipment used (M&TE critical for calibration)

| Primary Standards | ID # | Cal Date (Certificate No.) | Scheduled Calibration |
|-----------------------------|--------------------|---------------------------------|-----------------------|
| Power meter NRP | SN: 104778 | 06-Apr-16 (No. 217-02288/02289) | Apr-17 |
| Power sensor NRP-Z91 | SN: 103244 | 06-Apr-16 (No. 217-02288) | Apr-17 |
| Power sensor NRP-Z91 | SN: 103245 | 06-Apr-16 (No. 217-02289) | Apr-17 |
| Reference 20 dB Attenuator | SN: 5058 (20k) | 05-Apr-16 (No. 217-02292) | Apr-17 |
| Type-N mismatch combination | SN: 5047.2 / 06327 | 05-Apr-16 (No. 217-02295) | Apr-17 |
| Reference Probe EX3DV4 | SN: 7349 | 31-Dec-15 (No. EX3-7349_Dec15) | Dec-16 |
| DAE4 | SN: 601 | 30-Dec-15 (No. DAE4-601_Dec15) | Dec-16 |

| Secondary Standards | ID # | Check Date (in house) | Scheduled Check |
|---------------------------|----------------|-----------------------------------|------------------------|
| Power meter EPM-442A | SN: GB37480704 | 07-Oct-15 (No. 217-02222) | In house check: Oct-16 |
| Power sensor HP 8481A | SN: US37292783 | 07-Oct-15 (No. 217-02222) | In house check: Oct-16 |
| Power sensor HP 8481A | SN: MY41092317 | 07-Oct-15 (No. 217-02223) | In house check: Oct-16 |
| RF generator R&S SMT-06 | SN: 100972 | 15-Jun-15 (in house check Jun-15) | In house check: Oct-16 |
| Network Analyzer HP 8753E | SN: US37390585 | 18-Oct-01 (in house check Oct-15) | In house check: Oct-16 |

Calibrated by: **Michael Weber** Name: Michael Weber Function: Laboratory Technician Signature: *M. Weber*

Approved by: **Katja Pckovic** Name: Katja Pckovic Function: Technical Manager Signature: *Katja Pckovic*

Issued: May 18, 2016

This calibration certificate shall not be reproduced except in full without written approval of the laboratory.

| | | | |
|-----------------|-------------------------------|---------------|------------|
| Test Report #: | SAR-FION-002-17001_Appendix_C | FCC ID: | 2ANVA-V200 |
| Date of Report: | 2018-02-12 | IC Cert. No.: | 22342-V200 |

**Calibration Laboratory of
Schmid & Partner
Engineering AG**
Zeughausstrasse 43, 8004 Zurich, Switzerland



S Schweizerischer Kalibrierdienst
C Service suisse d'étalonnage
S Servizio svizzero di taratura
S Swiss Calibration Service

Accredited by the Swiss Accreditation Service (SAS)
The Swiss Accreditation Service is one of the signatories to the EA
Multilateral Agreement for the recognition of calibration certificates

Accreditation No.: **SCS 0108**

Glossary:

TSL tissue simulating liquid
ConvF sensitivity in TSL / NORM x,y,z
N/A not applicable or not measured

Calibration is Performed According to the Following Standards:

- a) IEEE Std 1528-2013, "IEEE Recommended Practice for Determining the Peak Spatial-Averaged Specific Absorption Rate (SAR) in the Human Head from Wireless Communications Devices: Measurement Techniques", June 2013
- b) IEC 62209-1, "Procedure to measure the Specific Absorption Rate (SAR) for hand-held devices used in close proximity to the ear (frequency range of 300 MHz to 3 GHz)", February 2005
- c) IEC 62209-2, "Procedure to determine the Specific Absorption Rate (SAR) for wireless communication devices used in close proximity to the human body (frequency range of 30 MHz to 6 GHz)", March 2010
- d) KDB 865664, "SAR Measurement Requirements for 100 MHz to 6 GHz"

Additional Documentation:

- e) DASY4/5 System Handbook

Methods Applied and Interpretation of Parameters:

- *Measurement Conditions:* Further details are available from the Validation Report at the end of the certificate. All figures stated in the certificate are valid at the frequency indicated.
- *Antenna Parameters with TSL:* The dipole is mounted with the spacer to position its feed point exactly below the center marking of the flat phantom section, with the arms oriented parallel to the body axis.
- *Feed Point Impedance and Return Loss:* These parameters are measured with the dipole positioned under the liquid filled phantom. The impedance stated is transformed from the measurement at the SMA connector to the feed point. The Return Loss ensures low reflected power. No uncertainty required.
- *Electrical Delay:* One-way delay between the SMA connector and the antenna feed point. No uncertainty required.
- *SAR measured:* SAR measured at the stated antenna input power.
- *SAR normalized:* SAR as measured, normalized to an input power of 1 W at the antenna connector.
- *SAR for nominal TSL parameters:* The measured TSL parameters are used to calculate the nominal SAR result.

The reported uncertainty of measurement is stated as the standard uncertainty of measurement multiplied by the coverage factor k=2, which for a normal distribution corresponds to a coverage probability of approximately 95%.

Measurement Conditions

DASY system configuration, as far as not given on page 1.

| | | |
|------------------------------|------------------------|-------------|
| DASY Version | DASY5 | V52.8.8 |
| Extrapolation | Advanced Extrapolation | |
| Phantom | Modular Flat Phantom | |
| Distance Dipole Center - TSL | 15 mm | with Spacer |
| Zoom Scan Resolution | dx, dy, dz = 5 mm | |
| Frequency | 900 MHz ± 1 MHz | |

Head TSL parameters

The following parameters and calculations were applied.

| | Temperature | Permittivity | Conductivity |
|---|-----------------|--------------|------------------|
| Nominal Head TSL parameters | 22.0 °C | 41.5 | 0.97 mho/m |
| Measured Head TSL parameters | (22.0 ± 0.2) °C | 41.2 ± 6 % | 0.96 mho/m ± 6 % |
| Head TSL temperature change during test | < 0.5 °C | ---- | ---- |

SAR result with Head TSL

| SAR averaged over 1 cm ³ (1 g) of Head TSL | Condition | |
|---|--------------------|---------------------------------|
| SAR measured | 250 mW input power | 2.65 W/kg |
| SAR for nominal Head TSL parameters | normalized to 1W | 10.7 W/kg ± 17.0 % (k=2) |

| SAR averaged over 10 cm ³ (10 g) of Head TSL | condition | |
|---|--------------------|---------------------------------|
| SAR measured | 250 mW input power | 1.70 W/kg |
| SAR for nominal Head TSL parameters | normalized to 1W | 6.83 W/kg ± 16.5 % (k=2) |

Body TSL parameters

The following parameters and calculations were applied.

| | Temperature | Permittivity | Conductivity |
|---|-----------------|--------------|------------------|
| Nominal Body TSL parameters | 22.0 °C | 55.0 | 1.05 mho/m |
| Measured Body TSL parameters | (22.0 ± 0.2) °C | 55.1 ± 6 % | 1.05 mho/m ± 6 % |
| Body TSL temperature change during test | < 0.5 °C | ---- | ---- |

SAR result with Body TSL

| SAR averaged over 1 cm ³ (1 g) of Body TSL | Condition | |
|---|--------------------|---------------------------------|
| SAR measured | 250 mW input power | 2.73 W/kg |
| SAR for nominal Body TSL parameters | normalized to 1W | 10.9 W/kg ± 17.0 % (k=2) |

| SAR averaged over 10 cm ³ (10 g) of Body TSL | condition | |
|---|--------------------|---------------------------------|
| SAR measured | 250 mW input power | 1.78 W/kg |
| SAR for nominal Body TSL parameters | normalized to 1W | 7.12 W/kg ± 16.5 % (k=2) |

| | | | |
|-----------------|-------------------------------|---------------|------------|
| Test Report #: | SAR-FION-002-17001_Appendix_C | FCC ID: | 2ANVA-V200 |
| Date of Report: | 2018-02-12 | IC Cert. No.: | 22342-V200 |



Appendix (Additional assessments outside the scope of SCS 0108)

Antenna Parameters with Head TSL

| | |
|--------------------------------------|--------------------------------|
| Impedance, transformed to feed point | 50.8 Ω - 0.8 j Ω |
| Return Loss | - 39.3 dB |

Antenna Parameters with Body TSL

| | |
|--------------------------------------|--------------------------------|
| Impedance, transformed to feed point | 46.7 Ω - 2.9 j Ω |
| Return Loss | - 27.0 dB |

General Antenna Parameters and Design

| | |
|----------------------------------|----------|
| Electrical Delay (one direction) | 1.411 ns |
|----------------------------------|----------|

After long term use with 100W radiated power, only a slight warming of the dipole near the feedpoint can be measured.

The dipole is made of standard semirigid coaxial cable. The center conductor of the feeding line is directly connected to the second arm of the dipole. The antenna is therefore short-circuited for DC-signals. On some of the dipoles, small end caps are added to the dipole arms in order to improve matching when loaded according to the position as explained in the "Measurement Conditions" paragraph. The SAR data are not affected by this change. The overall dipole length is still according to the Standard.

No excessive force must be applied to the dipole arms, because they might bend or the soldered connections near the feedpoint may be damaged.

Additional EUT Data

| | |
|-----------------|-------------------|
| Manufactured by | SPEAG |
| Manufactured on | February 22, 2010 |

| | | | |
|-----------------|-------------------------------|---------------|------------|
| Test Report #: | SAR-FION-002-17001_Appendix_C | FCC ID: | 2ANVA-V200 |
| Date of Report: | 2018-02-12 | IC Cert. No.: | 22342-V200 |

DASY5 Validation Report for Head TSL

Date: 09.05.2016

Test Laboratory: SPEAG, Zurich, Switzerland

DUT: Dipole 900 MHz; Type: D900V2; Serial: D900V2 - SN:1d110

Communication System: UID 0 - CW; Frequency: 900 MHz

Medium parameters used: $f = 900 \text{ MHz}$; $\sigma = 0.96 \text{ S/m}$; $\epsilon_r = 41.2$; $\rho = 1000 \text{ kg/m}^3$

Phantom section: Flat Section

Measurement Standard: DASY5 (IEEE/IEC/ANSI C63.19-2011)

DASY52 Configuration:

- Probe: EX3DV4 - SN7349; ConvF(9.7, 9.7, 9.7); Calibrated: 31.12.2015;
- Sensor-Surface: 1.4mm (Mechanical Surface Detection)
- Electronics: DAE4 Sn601; Calibrated: 30.12.2015
- Phantom: Flat Phantom 4.9L; Type: QD000P49AA; Serial: 1001
- DASY52 52.8.8(1258); SEMCAD X 14.6.10(7372)

Dipole Calibration for Head Tissue/Pin=250 mW, d=15mm/Zoom Scan (7x7x7)/Cube 0:

Measurement grid: $dx=5\text{mm}$, $dy=5\text{mm}$, $dz=5\text{mm}$

Reference Value = 63.58 V/m; Power Drift = -0.00 dB

Peak SAR (extrapolated) = 4.02 W/kg

SAR(1 g) = 2.65 W/kg; SAR(10 g) = 1.7 W/kg

Maximum value of SAR (measured) = 3.55 W/kg

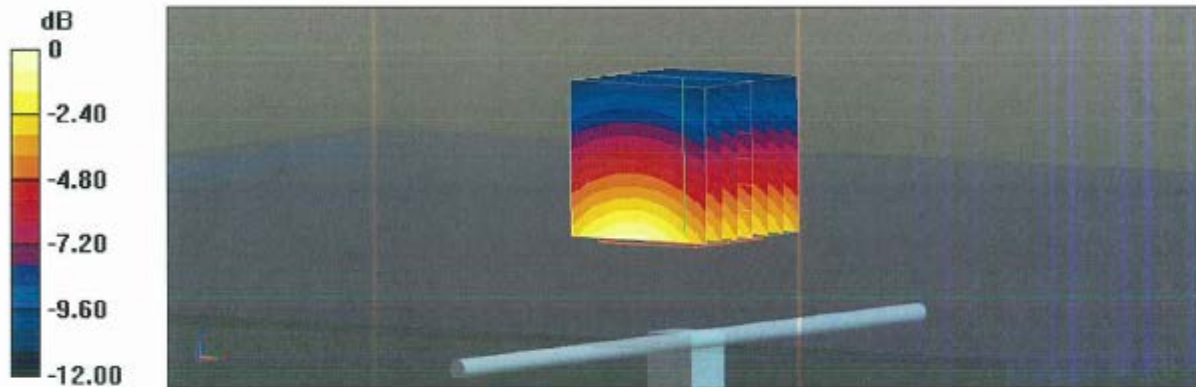

0 dB = 3.55 W/kg = 5.50 dBW/kg

| | | | |
|-----------------|-------------------------------|---------------|------------|
| Test Report #: | SAR-FION-002-17001_Appendix_C | FCC ID: | 2ANVA-V200 |
| Date of Report: | 2018-02-12 | IC Cert. No.: | 22342-V200 |



Impedance Measurement Plot for Head TSL

9 May 2016 11:34:45
 CH1 S11 1 U FS 1: 50.770 Ω -781.25 m Ω 226.35 pF 900.000 000 MHz

*
 Del
 Cor
 Avg
 16
 H1d

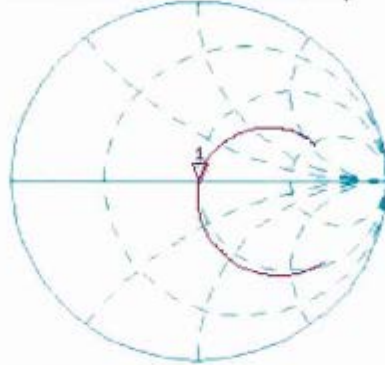

CH2 S11 LOG 5 dB/REF -20 dB 1: -39.266 dB 900.000 000 MHz

Del
 Cor
 Avg
 16
 H1d

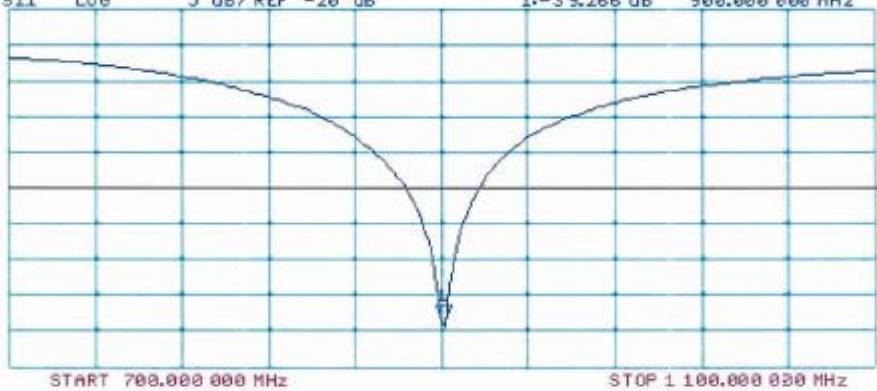

| | | | |
|-----------------|-------------------------------|---------------|------------|
| Test Report #: | SAR-FION-002-17001_Appendix_C | FCC ID: | 2ANVA-V200 |
| Date of Report: | 2018-02-12 | IC Cert. No.: | 22342-V200 |

DASY5 Validation Report for Body TSL

Date: 11.05.2016

Test Laboratory: SPEAG, Zurich, Switzerland

DUT: Dipole 900 MHz; Type: D900V2; Serial: D900V2 - SN:1d110

Communication System: UID 0 - CW; Frequency: 900 MHz
 Medium parameters used: $f = 900 \text{ MHz}$; $\sigma = 1.05 \text{ S/m}$; $\epsilon_r = 55.1$; $\rho = 1000 \text{ kg/m}^3$
 Phantom section: Flat Section
 Measurement Standard: DASY5 (IEEE/IEC/ANSI C63.19-2011)

DASY52 Configuration:

- Probe: EX3DV4 - SN7349; ConvF(9.64, 9.64, 9.64); Calibrated: 31.12.2015;
- Sensor-Surface: 1.4mm (Mechanical Surface Detection)
- Electronics: DAE4 Sn601; Calibrated: 30.12.2015
- Phantom: Flat Phantom 4.9L; Type: QD000P49AA; Serial: 1001
- DASY52 52.8.8(1258); SEMCAD X 14.6.10(7372)

Dipole Calibration for Body Tissue/Pin=250 mW, d=15mm/Zoom Scan (7x7x7)/Cube 0:

Measurement grid: $dx=5\text{mm}$, $dy=5\text{mm}$, $dz=5\text{mm}$
 Reference Value = 62.14 V/m; Power Drift = -0.01 dB
 Peak SAR (extrapolated) = 4.01 W/kg
SAR(1 g) = 2.73 W/kg; SAR(10 g) = 1.78 W/kg
 Maximum value of SAR (measured) = 3.60 W/kg

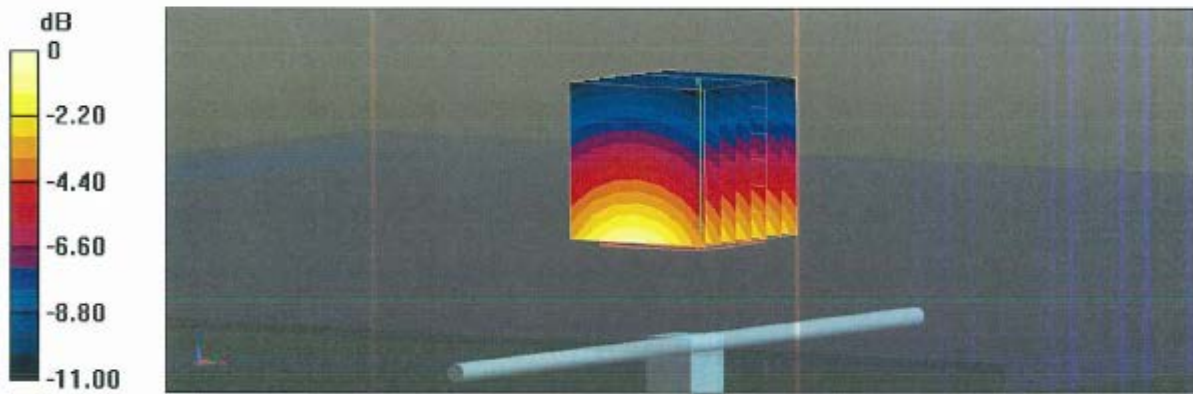

0 dB = 3.60 W/kg = 5.56 dBW/kg

| | | | |
|-----------------|-------------------------------|---------------|------------|
| Test Report #: | SAR-FION-002-17001_Appendix_C | FCC ID: | 2ANVA-V200 |
| Date of Report: | 2018-02-12 | IC Cert. No.: | 22342-V200 |



Impedance Measurement Plot for Body TSL

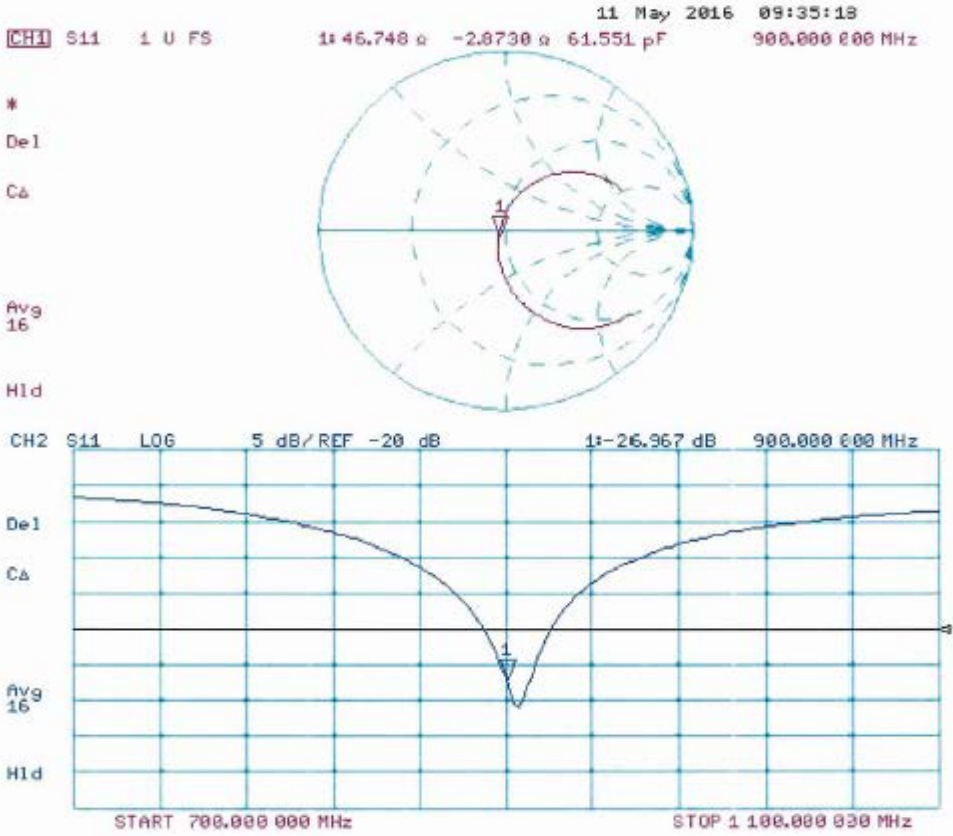

| | | | |
|-----------------|-------------------------------|---------------|------------|
| Test Report #: | SAR-FION-002-17001_Appendix_C | FCC ID: | 2ANVA-V200 |
| Date of Report: | 2018-02-12 | IC Cert. No.: | 22342-V200 |



1.1. D1750V2-1045 May 2016

Calibration Laboratory of Schmid & Partner Engineering AG
 Zeughausstrasse 43, 8004 Zurich, Switzerland



S Schweizerischer Kalibrierdienst
C Service suisse d'étalonnage
S Servizio svizzero di taratura
S Swiss Calibration Service

Accredited by the Swiss Accreditation Service (SAS)
 The Swiss Accreditation Service is one of the signatories to the EA Multilateral Agreement for the recognition of calibration certificates

Accreditation No.: **SCS 0108**

Client **Cetecom USA**

Certificate No: **D1750V2-1045_May16**

CALIBRATION CERTIFICATE

Object **D1750V2 - SN:1045**

Calibration procedure(s) **QA CAL-05.v9
 Calibration procedure for dipole validation kits above 700 MHz**

Calibration date: **May 11, 2016**

This calibration certificate documents the traceability to national standards, which realize the physical units of measurements (SI). The measurements and the uncertainties with confidence probability are given on the following pages and are part of the certificate.

All calibrations have been conducted in the closed laboratory facility: environment temperature (22 ± 3)°C and humidity < 70%.

Calibration Equipment used (M&TE critical for calibration)

| Primary Standards | ID # | Cal Date (Certificate No.) | Scheduled Calibration |
|-----------------------------|--------------------|---------------------------------|-----------------------|
| Power meter NRP | SN: 104778 | 06-Apr-16 (No. 217-02288/02289) | Apr-17 |
| Power sensor NRP-Z91 | SN: 103244 | 06-Apr-16 (No. 217-02288) | Apr-17 |
| Power sensor NRP-Z91 | SN: 103245 | 06-Apr-16 (No. 217-02289) | Apr-17 |
| Reference 20 dB Attenuator | SN: 5058 (20k) | 05-Apr-16 (No. 217-02292) | Apr-17 |
| Type-N mismatch combination | SN: 5047.2 / 06327 | 05-Apr-16 (No. 217-02295) | Apr-17 |
| Reference Probe EX3DV4 | SN: 7349 | 31-Dec-15 (No. EX3-7349_Dec15) | Dec-16 |
| DAE4 | SN: 601 | 30-Dec-15 (No. DAE4-601_Dec15) | Dec-16 |

| Secondary Standards | ID # | Check Date (in house) | Scheduled Check |
|---------------------------|----------------|-----------------------------------|------------------------|
| Power meter EPM-442A | SN: GB37480704 | 07-Oct-15 (No. 217-02222) | In house check: Oct-16 |
| Power sensor HP 8481A | SN: US37292783 | 07-Oct-15 (No. 217-02222) | In house check: Oct-16 |
| Power sensor HP 8481A | SN: MY41092317 | 07-Oct-15 (No. 217-02223) | In house check: Oct-16 |
| RF generator R&S SMT-06 | SN: 100972 | 15-Jun-15 (in house check Jun-15) | In house check: Oct-16 |
| Network Analyzer HP 8753E | SN: US37390585 | 18-Oct-01 (in house check Oct-15) | In house check: Oct-16 |

| | | | |
|----------------|-----------------------|-----------------------------------|---------------|
| Calibrated by: | Name Michael Weber | Function Laboratory Technician | Signature |
| Approved by: | Name Katja Pokovic | Function Technical Manager | Signature |

Issued: May 18, 2016

This calibration certificate shall not be reproduced except in full without written approval of the laboratory.

| | |
|--|--------------------------|
| Test Report #: SAR-FION-002-17001_Appendix_C | FCC ID: 2ANVA-V200 |
| Date of Report: 2018-02-12 | IC Cert. No.: 22342-V200 |

**Calibration Laboratory of
Schmid & Partner
Engineering AG**
Zeughausstrasse 43, 8004 Zurich, Switzerland



S Schweizerischer Kalibrierdienst
C Service suisse d'étalonnage
S Servizio svizzero di taratura
S Swiss Calibration Service

Accredited by the Swiss Accreditation Service (SAS)
The Swiss Accreditation Service is one of the signatories to the EA
Multilateral Agreement for the recognition of calibration certificates

Accreditation No.: **SCS 0108**

Glossary:

TSL tissue simulating liquid
ConvF sensitivity in TSL / NORM x,y,z
N/A not applicable or not measured

Calibration is Performed According to the Following Standards:

- a) IEEE Std 1528-2013, "IEEE Recommended Practice for Determining the Peak Spatial-Averaged Specific Absorption Rate (SAR) in the Human Head from Wireless Communications Devices: Measurement Techniques", June 2013
- b) IEC 62209-1, "Procedure to measure the Specific Absorption Rate (SAR) for hand-held devices used in close proximity to the ear (frequency range of 300 MHz to 3 GHz)", February 2005
- c) IEC 62209-2, "Procedure to determine the Specific Absorption Rate (SAR) for wireless communication devices used in close proximity to the human body (frequency range of 30 MHz to 6 GHz)", March 2010
- d) KDB 865664, "SAR Measurement Requirements for 100 MHz to 6 GHz"

Additional Documentation:

- e) DASy4/5 System Handbook

Methods Applied and Interpretation of Parameters:

- *Measurement Conditions:* Further details are available from the Validation Report at the end of the certificate. All figures stated in the certificate are valid at the frequency indicated.
- *Antenna Parameters with TSL:* The dipole is mounted with the spacer to position its feed point exactly below the center marking of the flat phantom section, with the arms oriented parallel to the body axis.
- *Feed Point Impedance and Return Loss:* These parameters are measured with the dipole positioned under the liquid filled phantom. The impedance stated is transformed from the measurement at the SMA connector to the feed point. The Return Loss ensures low reflected power. No uncertainty required.
- *Electrical Delay:* One-way delay between the SMA connector and the antenna feed point. No uncertainty required.
- *SAR measured:* SAR measured at the stated antenna input power.
- *SAR normalized:* SAR as measured, normalized to an input power of 1 W at the antenna connector.
- *SAR for nominal TSL parameters:* The measured TSL parameters are used to calculate the nominal SAR result.

The reported uncertainty of measurement is stated as the standard uncertainty of measurement multiplied by the coverage factor k=2, which for a normal distribution corresponds to a coverage probability of approximately 95%.

Measurement Conditions

DASY system configuration, as far as not given on page 1.

| | | |
|------------------------------|------------------------|-------------|
| DASY Version | DASY5 | V52.8.8 |
| Extrapolation | Advanced Extrapolation | |
| Phantom | Modular Flat Phantom | |
| Distance Dipole Center - TSL | 10 mm | with Spacer |
| Zoom Scan Resolution | dx, dy, dz = 5 mm | |
| Frequency | 1750 MHz ± 1 MHz | |

Head TSL parameters

The following parameters and calculations were applied.

| | Temperature | Permittivity | Conductivity |
|---|-----------------|--------------|------------------|
| Nominal Head TSL parameters | 22.0 °C | 40.1 | 1.37 mho/m |
| Measured Head TSL parameters | (22.0 ± 0.2) °C | 39.8 ± 6 % | 1.36 mho/m ± 6 % |
| Head TSL temperature change during test | < 0.5 °C | ---- | ---- |

SAR result with Head TSL

| SAR averaged over 1 cm ³ (1 g) of Head TSL | Condition | |
|---|--------------------|---------------------------------|
| SAR measured | 250 mW input power | 9.00 W/kg |
| SAR for nominal Head TSL parameters | normalized to 1W | 36.1 W/kg ± 17.0 % (k=2) |

| SAR averaged over 10 cm ³ (10 g) of Head TSL | condition | |
|---|--------------------|---------------------------------|
| SAR measured | 250 mW input power | 4.78 W/kg |
| SAR for nominal Head TSL parameters | normalized to 1W | 19.2 W/kg ± 16.5 % (k=2) |

Body TSL parameters

The following parameters and calculations were applied.

| | Temperature | Permittivity | Conductivity |
|---|-----------------|--------------|------------------|
| Nominal Body TSL parameters | 22.0 °C | 53.4 | 1.49 mho/m |
| Measured Body TSL parameters | (22.0 ± 0.2) °C | 53.8 ± 6 % | 1.50 mho/m ± 6 % |
| Body TSL temperature change during test | < 0.5 °C | ---- | ---- |

SAR result with Body TSL

| SAR averaged over 1 cm ³ (1 g) of Body TSL | Condition | |
|---|--------------------|---------------------------------|
| SAR measured | 250 mW input power | 9.19 W/kg |
| SAR for nominal Body TSL parameters | normalized to 1W | 36.7 W/kg ± 17.0 % (k=2) |

| SAR averaged over 10 cm ³ (10 g) of Body TSL | condition | |
|---|--------------------|---------------------------------|
| SAR measured | 250 mW input power | 4.90 W/kg |
| SAR for nominal Body TSL parameters | normalized to 1W | 19.6 W/kg ± 16.5 % (k=2) |

| | | | |
|-----------------|-------------------------------|---------------|------------|
| Test Report #: | SAR-FION-002-17001_Appendix_C | FCC ID: | 2ANVA-V200 |
| Date of Report: | 2018-02-12 | IC Cert. No.: | 22342-V200 |



Appendix (Additional assessments outside the scope of SCS 0108)

Antenna Parameters with Head TSL

| | |
|--------------------------------------|--------------------------------|
| Impedance, transformed to feed point | 49.3 Ω - 0.4 j Ω |
| Return Loss | - 41.6 dB |

Antenna Parameters with Body TSL

| | |
|--------------------------------------|--------------------------------|
| Impedance, transformed to feed point | 45.5 Ω - 1.0 j Ω |
| Return Loss | - 26.4 dB |

General Antenna Parameters and Design

| | |
|----------------------------------|----------|
| Electrical Delay (one direction) | 1.219 ns |
|----------------------------------|----------|

After long term use with 100W radiated power, only a slight warming of the dipole near the feedpoint can be measured.

The dipole is made of standard semirigid coaxial cable. The center conductor of the feeding line is directly connected to the second arm of the dipole. The antenna is therefore short-circuited for DC-signals. On some of the dipoles, small end caps are added to the dipole arms in order to improve matching when loaded according to the position as explained in the "Measurement Conditions" paragraph. The SAR data are not affected by this change. The overall dipole length is still according to the Standard.

No excessive force must be applied to the dipole arms, because they might bend or the soldered connections near the feedpoint may be damaged.

Additional EUT Data

| | |
|-----------------|-------------------|
| Manufactured by | SPEAG |
| Manufactured on | February 19, 2010 |

| | | | |
|-----------------|-------------------------------|---------------|------------|
| Test Report #: | SAR-FION-002-17001_Appendix_C | FCC ID: | 2ANVA-V200 |
| Date of Report: | 2018-02-12 | IC Cert. No.: | 22342-V200 |

DASY5 Validation Report for Head TSL

Date: 11.05.2016

Test Laboratory: SPEAG, Zurich, Switzerland

DUT: Dipole 1750 MHz; Type: D1750V2; Serial: D1750V2 - SN:1045

Communication System: UID 0 - CW; Frequency: 1750 MHz

Medium parameters used: $f = 1750$ MHz; $\sigma = 1.36$ S/m; $\epsilon_r = 39.8$; $\rho = 1000$ kg/m³

Phantom section: Flat Section

Measurement Standard: DASY5 (IEEE/IEC/ANSI C63.19-2011)

DASY52 Configuration:

- Probe: EX3DV4 - SN7349; ConvF(8.54, 8.54, 8.54); Calibrated: 31.12.2015;
- Sensor-Surface: 1.4mm (Mechanical Surface Detection)
- Electronics: DAE4 Sn601; Calibrated: 30.12.2015
- Phantom: Flat Phantom 5.0 (front); Type: QD000P50AA; Serial: 1001
- DASY52 52.8.8(1258); SEMCAD X 14.6.10(7372)

Dipole Calibration for Head Tissue/Pin=250 mW, d=10mm/Zoom Scan (7x7x7)/Cube 0:

Measurement grid: dx=5mm, dy=5mm, dz=5mm

Reference Value = 103.8 V/m; Power Drift = 0.02 dB

Peak SAR (extrapolated) = 16.5 W/kg

SAR(1 g) = 9 W/kg; SAR(10 g) = 4.78 W/kg

Maximum value of SAR (measured) = 13.6 W/kg

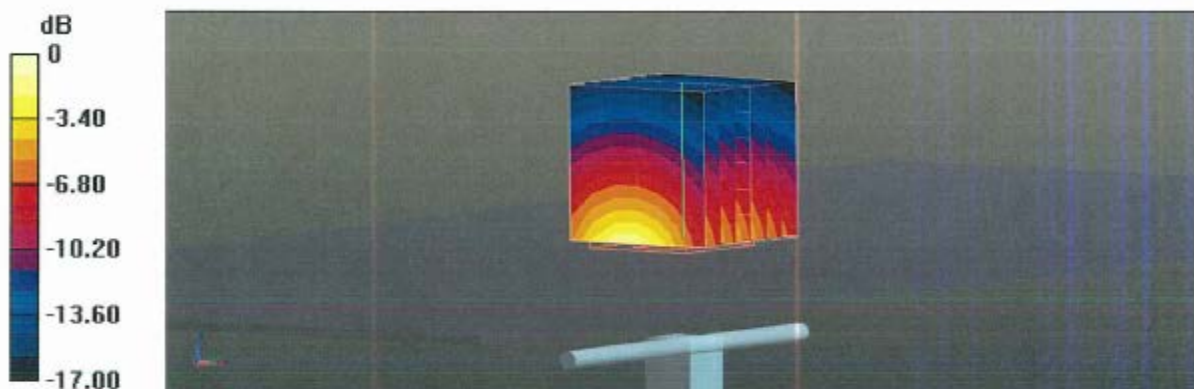

0 dB = 13.6 W/kg = 11.34 dBW/kg

Impedance Measurement Plot for Head TSL

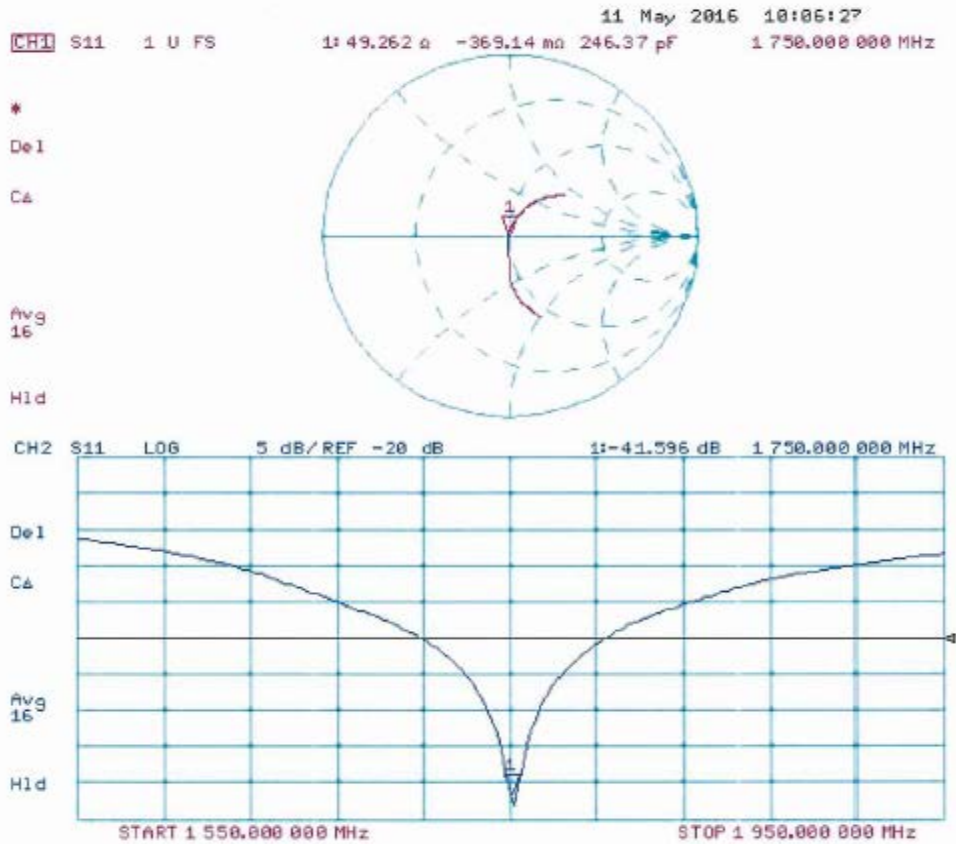

| | | | |
|-----------------|-------------------------------|---------------|------------|
| Test Report #: | SAR-FION-002-17001_Appendix_C | FCC ID: | 2ANVA-V200 |
| Date of Report: | 2018-02-12 | IC Cert. No.: | 22342-V200 |

DASY5 Validation Report for Body TSL

Date: 11.05.2016

Test Laboratory: SPEAG, Zurich, Switzerland

DUT: Dipole 1750 MHz; Type: D1750V2; Serial: D1750V2 - SN:1045

Communication System: UID 0 - CW; Frequency: 1750 MHz

Medium parameters used: $f = 1750$ MHz; $\sigma = 1.5$ S/m; $\epsilon_r = 53.8$; $\rho = 1000$ kg/m³

Phantom section: Flat Section

Measurement Standard: DASY5 (IEEE/IEC/ANSI C63.19-2011)

DASY52 Configuration:

- Probe: EX3DV4 - SN7349; ConvF(8.25, 8.25, 8.25); Calibrated: 31.12.2015;
- Sensor-Surface: 1.4mm (Mechanical Surface Detection)
- Electronics: DAE4 Sn601; Calibrated: 30.12.2015
- Phantom: Flat Phantom 5.0 (back); Type: QD000P50AA; Serial: 1002
- DASY52 52.8.8(1258); SEMCAD X 14.6.10(7372)

Dipole Calibration for Body Tissue/Pin=250 mW, d=10mm/Zoom Scan (7x7x7)/Cube 0:

Measurement grid: dx=5mm, dy=5mm, dz=5mm

Reference Value = 99.89 V/m; Power Drift = 0.02 dB

Peak SAR (extrapolated) = 16.1 W/kg

SAR(1 g) = 9.19 W/kg; SAR(10 g) = 4.9 W/kg

Maximum value of SAR (measured) = 13.7 W/kg

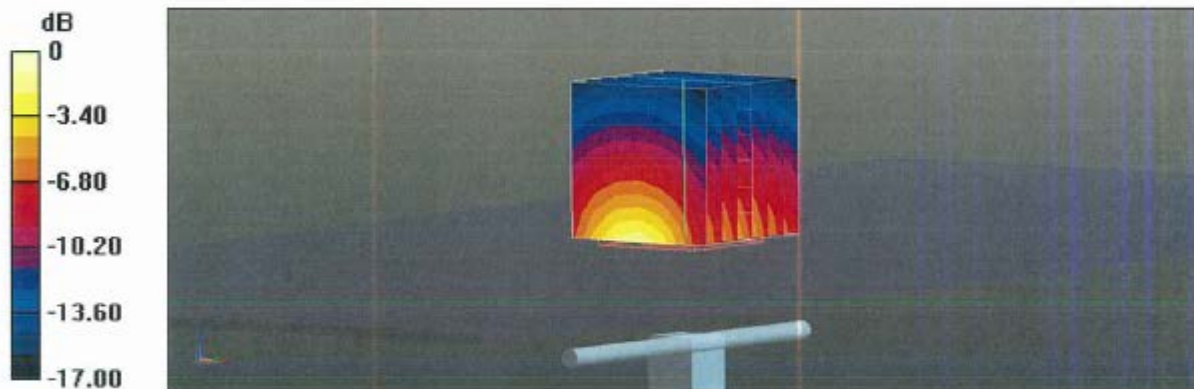

0 dB = 13.7 W/kg = 11.37 dBW/kg

| | | | |
|-----------------|-------------------------------|---------------|------------|
| Test Report #: | SAR-FION-002-17001_Appendix_C | FCC ID: | 2ANVA-V200 |
| Date of Report: | 2018-02-12 | IC Cert. No.: | 22342-V200 |



Impedance Measurement Plot for Body TSL

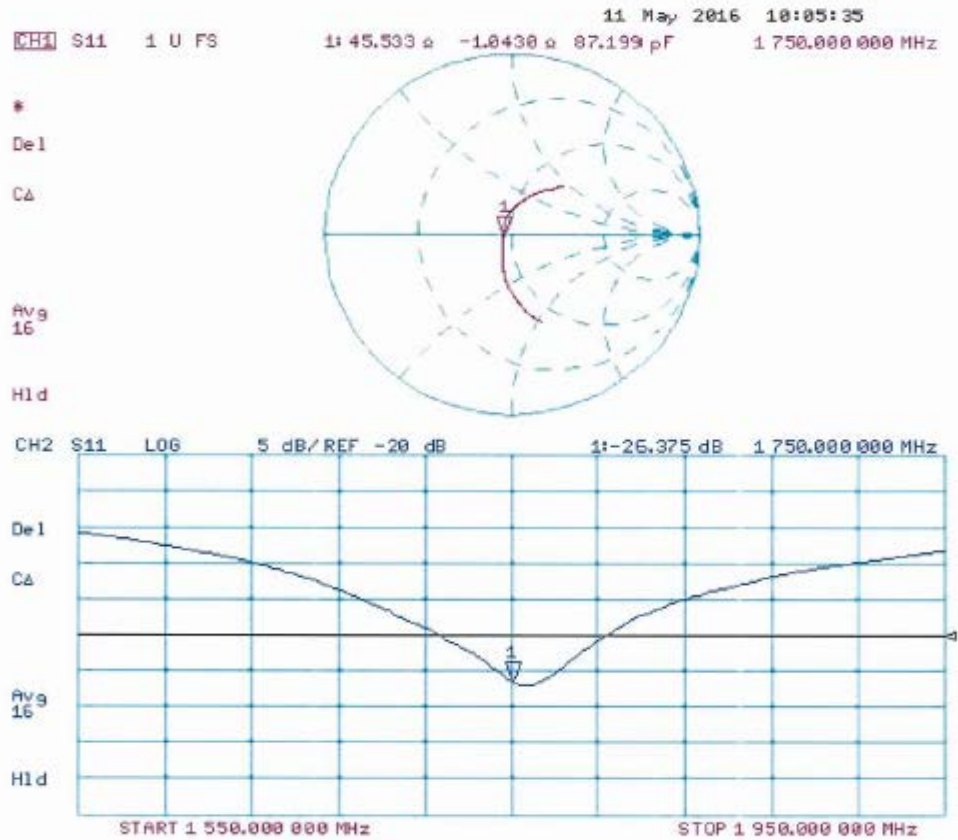

| | | | |
|-----------------|-------------------------------|---------------|------------|
| Test Report #: | SAR-FION-002-17001_Appendix_C | FCC ID: | 2ANVA-V200 |
| Date of Report: | 2018-02-12 | IC Cert. No.: | 22342-V200 |



1.1. D1900V2-5d135 April 2016

**Calibration Laboratory of
Schmid & Partner
Engineering AG**
Zeughausstrasse 43, 8004 Zurich, Switzerland



S Schweizerischer Kalibrierdienst
C Service suisse d'étalonnage
S Servizio svizzero di taratura
S Swiss Calibration Service

Accredited by the Swiss Accreditation Service (SAS)
The Swiss Accreditation Service is one of the signatories to the EA
Multilateral Agreement for the recognition of calibration certificates

Accreditation No.: **SCS 0108**

Client **Cetecom USA**

Certificate No: **D1900V2-5d135_Apr16**

CALIBRATION CERTIFICATE

Object: **D1900V2 - SN: 5d135**

Calibration procedure(s): **QA CAL-05.v9
Calibration procedure for dipole validation kits above 700 MHz**

Calibration date: **April 25, 2016**

This calibration certificate documents the traceability to national standards, which realize the physical units of measurements (SI).
The measurements and the uncertainties with confidence probability are given on the following pages and are part of the certificate.

All calibrations have been conducted in the closed laboratory facility: environment temperature (22 ± 3)°C and humidity < 70%.

Calibration Equipment used (M&TE critical for calibration)

| Primary Standards | ID # | Cal Date (Certificate No.) | Scheduled Calibration |
|-----------------------------|--------------------|---------------------------------|-----------------------|
| Power meter NRP | SN: 104778 | 06-Apr-16 (No. 217-02288/02289) | Apr-17 |
| Power sensor NRP-Z91 | SN: 103244 | 06-Apr-16 (No. 217-02288) | Apr-17 |
| Power sensor NRP-Z91 | SN: 103245 | 06-Apr-16 (No. 217-02289) | Apr-17 |
| Reference 20 dB Attenuator | SN: 5058 (20k) | 05-Apr-16 (No. 217-02292) | Apr-17 |
| Type-N mismatch combination | SN: 5047.2 / 06327 | 05-Apr-16 (No. 217-02295) | Apr-17 |
| Reference Probe EX3DV4 | SN: 7349 | 31-Dec-15 (No. EX3-7349_Dec15) | Dec-16 |
| DAE4 | SN: 601 | 30-Dec-15 (No. DAE4-601_Dec15) | Dec-16 |

| Secondary Standards | ID # | Check Date (in house) | Scheduled Check |
|---------------------------|----------------|-----------------------------------|------------------------|
| Power meter EPM-442A | SN: GB37480704 | 07-Oct-15 (No. 217-02222) | In house check: Oct-16 |
| Power sensor HP 8481A | SN: US37292783 | 07-Oct-15 (No. 217-02222) | In house check: Oct-16 |
| Power sensor HP 8481A | SN: MY41092317 | 07-Oct-15 (No. 217-02223) | In house check: Oct-16 |
| RF generator R&S SMT-06 | SN: 100972 | 15-Jun-15 (in house check Jun-15) | In house check: Oct-16 |
| Network Analyzer HP 8753E | SN: US37390585 | 18-Oct-01 (in house check Oct-15) | In house check: Oct-16 |

| | | | |
|----------------|-----------------------|-----------------------------------|---------------|
| Calibrated by: | Name Michael Weber | Function Laboratory Technician | Signature |
| Approved by: | Katja Pokovic | Technical Manager | |

Issued: April 26, 2016

This calibration certificate shall not be reproduced except in full without written approval of the laboratory.

| | | | |
|-----------------|-------------------------------|---------------|------------|
| Test Report #: | SAR-FION-002-17001_Appendix_C | FCC ID: | 2ANVA-V200 |
| Date of Report: | 2018-02-12 | IC Cert. No.: | 22342-V200 |

**Calibration Laboratory of
Schmid & Partner
Engineering AG**
Zeughausstrasse 43, 8004 Zurich, Switzerland



S Schweizerischer Kalibrierdienst
C Service suisse d'étalonnage
S Servizio svizzero di taratura
S Swiss Calibration Service

Accredited by the Swiss Accreditation Service (SAS)
The Swiss Accreditation Service is one of the signatories to the EA
Multilateral Agreement for the recognition of calibration certificates

Accreditation No.: **SCS 0108**

Glossary:

TSL tissue simulating liquid
ConvF sensitivity in TSL / NORM x,y,z
N/A not applicable or not measured

Calibration is Performed According to the Following Standards:

- a) IEEE Std 1528-2013, "IEEE Recommended Practice for Determining the Peak Spatial-Averaged Specific Absorption Rate (SAR) in the Human Head from Wireless Communications Devices: Measurement Techniques", June 2013
- b) IEC 62209-1, "Procedure to measure the Specific Absorption Rate (SAR) for hand-held devices used in close proximity to the ear (frequency range of 300 MHz to 3 GHz)", February 2005
- c) IEC 62209-2, "Procedure to determine the Specific Absorption Rate (SAR) for wireless communication devices used in close proximity to the human body (frequency range of 30 MHz to 6 GHz)", March 2010
- d) KDB 865664, "SAR Measurement Requirements for 100 MHz to 6 GHz"

Additional Documentation:

- e) DASY4/5 System Handbook

Methods Applied and Interpretation of Parameters:

- *Measurement Conditions:* Further details are available from the Validation Report at the end of the certificate. All figures stated in the certificate are valid at the frequency indicated.
- *Antenna Parameters with TSL:* The dipole is mounted with the spacer to position its feed point exactly below the center marking of the flat phantom section, with the arms oriented parallel to the body axis.
- *Feed Point Impedance and Return Loss:* These parameters are measured with the dipole positioned under the liquid filled phantom. The impedance stated is transformed from the measurement at the SMA connector to the feed point. The Return Loss ensures low reflected power. No uncertainty required.
- *Electrical Delay:* One-way delay between the SMA connector and the antenna feed point. No uncertainty required.
- *SAR measured:* SAR measured at the stated antenna input power.
- *SAR normalized:* SAR as measured, normalized to an input power of 1 W at the antenna connector.
- *SAR for nominal TSL parameters:* The measured TSL parameters are used to calculate the nominal SAR result.

The reported uncertainty of measurement is stated as the standard uncertainty of measurement multiplied by the coverage factor k=2, which for a normal distribution corresponds to a coverage probability of approximately 95%.

| | | | |
|-----------------|-------------------------------|---------------|------------|
| Test Report #: | SAR-FION-002-17001_Appendix_C | FCC ID: | 2ANVA-V200 |
| Date of Report: | 2018-02-12 | IC Cert. No.: | 22342-V200 |



Measurement Conditions

DASY system configuration, as far as not given on page 1.

| | | |
|------------------------------|------------------------|-------------|
| DASY Version | DASY5 | V52.8.8 |
| Extrapolation | Advanced Extrapolation | |
| Phantom | Modular Flat Phantom | |
| Distance Dipole Center - TSL | 10 mm | with Spacer |
| Zoom Scan Resolution | dx, dy, dz = 5 mm | |
| Frequency | 1900 MHz ± 1 MHz | |

Head TSL parameters

The following parameters and calculations were applied.

| | Temperature | Permittivity | Conductivity |
|---|-----------------|--------------|------------------|
| Nominal Head TSL parameters | 22.0 °C | 40.0 | 1.40 mho/m |
| Measured Head TSL parameters | (22.0 ± 0.2) °C | 40.0 ± 6 % | 1.37 mho/m ± 6 % |
| Head TSL temperature change during test | < 0.5 °C | ---- | ---- |

SAR result with Head TSL

| SAR averaged over 1 cm ³ (1 g) of Head TSL | Condition | |
|---|--------------------|---------------------------------|
| SAR measured | 250 mW input power | 9.29 W/kg |
| SAR for nominal Head TSL parameters | normalized to 1W | 37.6 W/kg ± 17.0 % (k=2) |

| SAR averaged over 10 cm ³ (10 g) of Head TSL | condition | |
|---|--------------------|---------------------------------|
| SAR measured | 250 mW input power | 4.90 W/kg |
| SAR for nominal Head TSL parameters | normalized to 1W | 19.8 W/kg ± 16.5 % (k=2) |

Body TSL parameters

The following parameters and calculations were applied.

| | Temperature | Permittivity | Conductivity |
|---|-----------------|--------------|------------------|
| Nominal Body TSL parameters | 22.0 °C | 53.3 | 1.52 mho/m |
| Measured Body TSL parameters | (22.0 ± 0.2) °C | 52.9 ± 6 % | 1.49 mho/m ± 6 % |
| Body TSL temperature change during test | < 0.5 °C | ---- | ---- |

SAR result with Body TSL

| SAR averaged over 1 cm ³ (1 g) of Body TSL | Condition | |
|---|--------------------|---------------------------------|
| SAR measured | 250 mW input power | 9.60 W/kg |
| SAR for nominal Body TSL parameters | normalized to 1W | 38.8 W/kg ± 17.0 % (k=2) |

| SAR averaged over 10 cm ³ (10 g) of Body TSL | condition | |
|---|--------------------|---------------------------------|
| SAR measured | 250 mW input power | 5.09 W/kg |
| SAR for nominal Body TSL parameters | normalized to 1W | 20.5 W/kg ± 16.5 % (k=2) |

| | | | |
|-----------------|-------------------------------|---------------|------------|
| Test Report #: | SAR-FION-002-17001_Appendix_C | FCC ID: | 2ANVA-V200 |
| Date of Report: | 2018-02-12 | IC Cert. No.: | 22342-V200 |



Appendix (Additional assessments outside the scope of SCS 0108)

Antenna Parameters with Head TSL

| | |
|--------------------------------------|--------------------------------|
| Impedance, transformed to feed point | 52.8 Ω + 9.9 j Ω |
| Return Loss | - 20.0 dB |

Antenna Parameters with Body TSL

| | |
|--------------------------------------|--------------------------------|
| Impedance, transformed to feed point | 48.2 Ω + 9.7 j Ω |
| Return Loss | - 20.0 dB |

General Antenna Parameters and Design

| | |
|----------------------------------|----------|
| Electrical Delay (one direction) | 1.203 ns |
|----------------------------------|----------|

After long term use with 100W radiated power, only a slight warming of the dipole near the feedpoint can be measured.

The dipole is made of standard semirigid coaxial cable. The center conductor of the feeding line is directly connected to the second arm of the dipole. The antenna is therefore short-circuited for DC-signals. On some of the dipoles, small end caps are added to the dipole arms in order to improve matching when loaded according to the position as explained in the "Measurement Conditions" paragraph. The SAR data are not affected by this change. The overall dipole length is still according to the Standard.

No excessive force must be applied to the dipole arms, because they might bend or the soldered connections near the feedpoint may be damaged.

Additional EUT Data

| | |
|-----------------|----------------|
| Manufactured by | SPEAG |
| Manufactured on | April 14, 2010 |

| | | | |
|-----------------|-------------------------------|---------------|------------|
| Test Report #: | SAR-FION-002-17001_Appendix_C | FCC ID: | 2ANVA-V200 |
| Date of Report: | 2018-02-12 | IC Cert. No.: | 22342-V200 |

DASY5 Validation Report for Head TSL

Date: 25.04.2016

Test Laboratory: SPEAG, Zurich, Switzerland

DUT: Dipole 1900 MHz; Type: D1900V2; Serial: D1900V2 - SN: 5d135

Communication System: UID 0 - CW; Frequency: 1900 MHz

Medium parameters used: $f = 1900$ MHz; $\sigma = 1.37$ S/m; $\epsilon_r = 40$; $\rho = 1000$ kg/m³

Phantom section: Flat Section

Measurement Standard: DASY5 (IEEE/IEC/ANSI C63.19-2011)

DASY52 Configuration:

- Probe: EX3DV4 - SN7349; ConvF(8.2, 8.2, 8.2); Calibrated: 31.12.2015;
- Sensor-Surface: 1.4mm (Mechanical Surface Detection)
- Electronics: DAE4 Sn601; Calibrated: 30.12.2015
- Phantom: Flat Phantom 5.0 (front); Type: QD000P50AA; Serial: 1001
- DASY52 52.8.8(1258); SEMCAD X 14.6.10(7372)

Dipole Calibration for Head Tissue/Pin=250 mW, d=10mm/Zoom Scan (7x7x7)/Cube 0:

Measurement grid: dx=5mm, dy=5mm, dz=5mm

Reference Value = 106.8 V/m; Power Drift = -0.00 dB

Peak SAR (extrapolated) = 16.8 W/kg

SAR(1 g) = 9.29 W/kg; SAR(10 g) = 4.9 W/kg

Maximum value of SAR (measured) = 14.2 W/kg

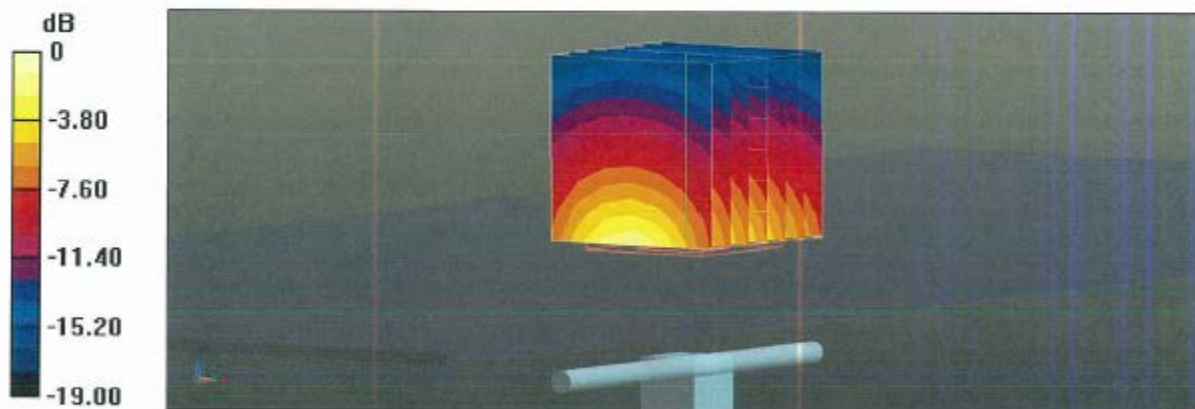

0 dB = 14.2 W/kg = 11.52 dBW/kg

| | | | |
|-----------------|-------------------------------|---------------|------------|
| Test Report #: | SAR-FION-002-17001_Appendix_C | FCC ID: | 2ANVA-V200 |
| Date of Report: | 2018-02-12 | IC Cert. No.: | 22342-V200 |



Impedance Measurement Plot for Head TSL

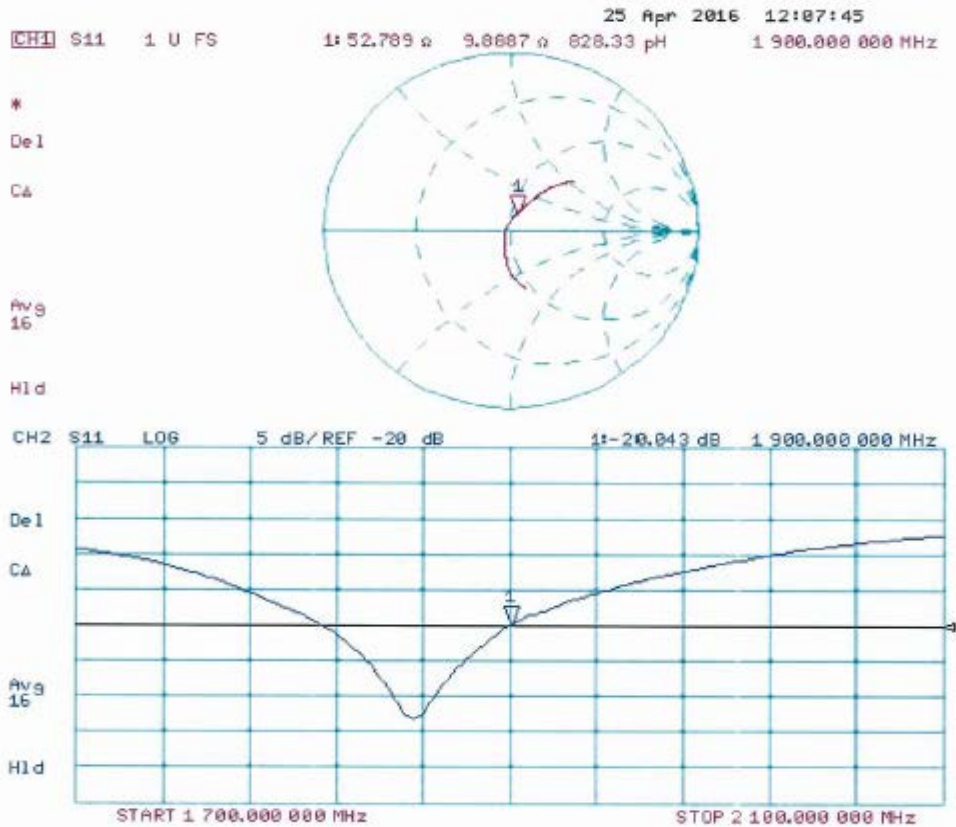

| | | | |
|-----------------|-------------------------------|---------------|------------|
| Test Report #: | SAR-FION-002-17001_Appendix_C | FCC ID: | 2ANVA-V200 |
| Date of Report: | 2018-02-12 | IC Cert. No.: | 22342-V200 |

DASY5 Validation Report for Body TSL

Date: 25.04.2016

Test Laboratory: SPEAG, Zurich, Switzerland

DUT: Dipole 1900 MHz; Type: D1900V2; Serial: D1900V2 - SN: 5d135

Communication System: UID 0 - CW; Frequency: 1900 MHz

Medium parameters used: $f = 1900$ MHz; $\sigma = 1.49$ S/m; $\epsilon_r = 52.9$; $\rho = 1000$ kg/m³

Phantom section: Flat Section

Measurement Standard: DASY5 (IEEE/IEC/ANSI C63.19-2011)

DASY52 Configuration:

- Probe: EX3DV4 - SN7349; ConvF(8.03, 8.03, 8.03); Calibrated: 31.12.2015;
- Sensor-Surface: 1.4mm (Mechanical Surface Detection)
- Electronics: DAE4 Sn601; Calibrated: 30.12.2015
- Phantom: Flat Phantom 5.0 (back); Type: QD000P50AA; Serial: 1002
- DASY52 52.8.8(1258); SEMCAD X 14.6.10(7372)

Dipole Calibration for Body Tissue/Pin=250 mW, d=10mm/Zoom Scan (7x7x7)/Cube 0:

Measurement grid: dx=5mm, dy=5mm, dz=5mm

Reference Value = 102.9 V/m; Power Drift = 0.00 dB

Peak SAR (extrapolated) = 16.8 W/kg

SAR(1 g) = 9.6 W/kg; SAR(10 g) = 5.09 W/kg

Maximum value of SAR (measured) = 14.5 W/kg

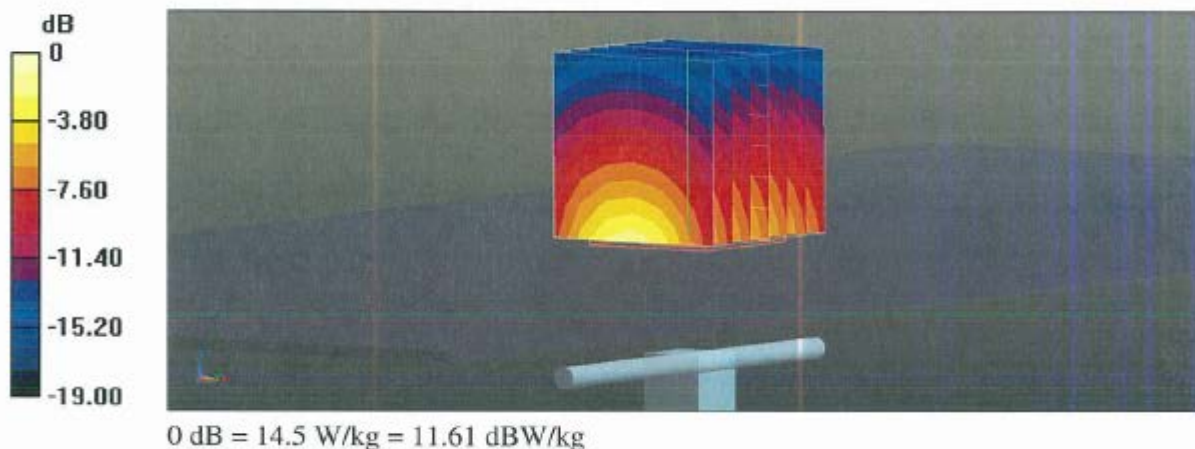

| | | | |
|-----------------|-------------------------------|---------------|------------|
| Test Report #: | SAR-FION-002-17001_Appendix_C | FCC ID: | 2ANVA-V200 |
| Date of Report: | 2018-02-12 | IC Cert. No.: | 22342-V200 |



Impedance Measurement Plot for Body TSL

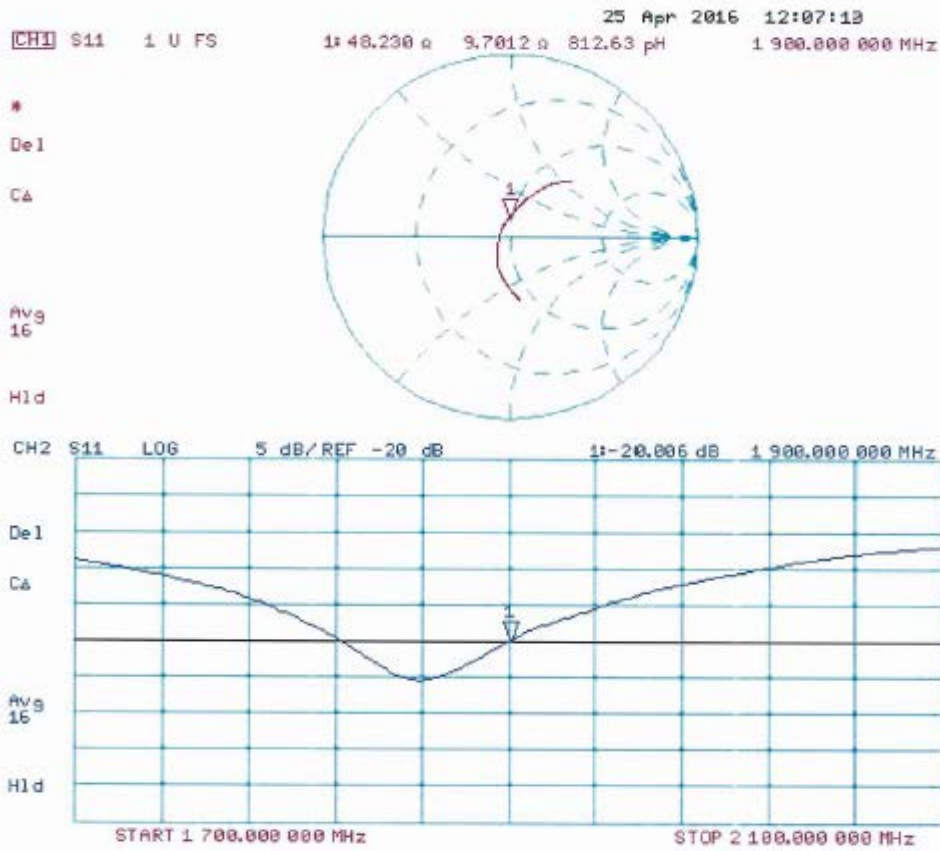

| | |
|--|--------------------------|
| Test Report #: SAR-FION-002-17001_Appendix_C | FCC ID: 2ANVA-V200 |
| Date of Report: 2018-02-12 | IC Cert. No.: 22342-V200 |



1.2. D2450V2-859 April 2016

**Calibration Laboratory of
Schmid & Partner
Engineering AG**
Zeughausstrasse 43, 8004 Zurich, Switzerland



S Schweizerischer Kalibrierdienst
C Service suisse d'étalonnage
S Servizio svizzero di taratura
S Swiss Calibration Service

Accredited by the Swiss Accreditation Service (SAS)
The Swiss Accreditation Service is one of the signatories to the EA
Multilateral Agreement for the recognition of calibration certificates

Accreditation No.: **SCS 0108**

Client **Cetecom USA**

Certificate No: **D2450V2-859_Apr16**

CALIBRATION CERTIFICATE

Object **D2450V2 - SN: 859**

Calibration procedure(s) **QA CAL-05.v9
Calibration procedure for dipole validation kits above 700 MHz**

Calibration date: **April 19, 2016**

This calibration certificate documents the traceability to national standards, which realize the physical units of measurements (SI).
The measurements and the uncertainties with confidence probability are given on the following pages and are part of the certificate.

All calibrations have been conducted in the closed laboratory facility: environment temperature (22 ± 3)°C and humidity < 70%.

Calibration Equipment used (M&TE critical for calibration)

| Primary Standards | ID # | Cal Date (Certificate No.) | Scheduled Calibration |
|-----------------------------|--------------------|-----------------------------------|------------------------|
| Power meter NRP | SN: 104778 | 06-Apr-16 (No. 217-02288/02289) | Apr-17 |
| Power sensor NRP-Z91 | SN: 103244 | 06-Apr-16 (No. 217-02288) | Apr-17 |
| Power sensor NRP-Z91 | SN: 103245 | 06-Apr-16 (No. 217-02289) | Apr-17 |
| Reference 20 dB Attenuator | SN: 5058 (20k) | 05-Apr-16 (No. 217-02292) | Apr-17 |
| Type-N mismatch combination | SN: 5047.2 / 06327 | 05-Apr-16 (No. 217-02295) | Apr-17 |
| Reference Probe EX3DV4 | SN: 7349 | 31-Dec-15 (No. EX3-7349_Dec15) | Dec-16 |
| DAE4 | SN: 601 | 30-Dec-15 (No. DAE4-601_Dec15) | Dec-16 |
| Secondary Standards | ID # | Check Date (in house) | Scheduled Check |
| Power meter EPM-442A | SN: GB37480704 | 07-Oct-15 (No. 217-02222) | In house check: Oct-16 |
| Power sensor HP 8481A | SN: US37292783 | 07-Oct-15 (No. 217-02222) | In house check: Oct-16 |
| Power sensor HP 8481A | SN: MY41092317 | 07-Oct-15 (No. 217-02223) | In house check: Oct-16 |
| RF generator R&S SMT-06 | SN: 100972 | 15-Jun-15 (in house check Jun-15) | In house check: Oct-16 |
| Network Analyzer HP 8753E | SN: US37390585 | 18-Oct-01 (in house check Oct-15) | In house check: Oct-16 |

| | | | |
|----------------|-----------------------|-----------------------------------|---------------|
| Calibrated by: | Name Michael Weber | Function Laboratory Technician | Signature |
| Approved by: | Katja Pokovic | Technical Manager | |

Issued: April 20, 2016

This calibration certificate shall not be reproduced except in full without written approval of the laboratory.

| | | | |
|-----------------|-------------------------------|---------------|------------|
| Test Report #: | SAR-FION-002-17001_Appendix_C | FCC ID: | 2ANVA-V200 |
| Date of Report: | 2018-02-12 | IC Cert. No.: | 22342-V200 |



| | |
|--|--------------------------|
| Test Report #: SAR-FION-002-17001_Appendix_C | FCC ID: 2ANVA-V200 |
| Date of Report: 2018-02-12 | IC Cert. No.: 22342-V200 |



**Calibration Laboratory of
Schmid & Partner
Engineering AG**
Zeughausstrasse 43, 8004 Zurich, Switzerland



S Schweizerischer Kalibrierdienst
C Service suisse d'étalonnage
S Servizio svizzero di taratura
S Swiss Calibration Service

Accredited by the Swiss Accreditation Service (SAS)
The Swiss Accreditation Service is one of the signatories to the EA
Multilateral Agreement for the recognition of calibration certificates

Accreditation No.: **SCS 0108**

Glossary:

TSL tissue simulating liquid
ConvF sensitivity in TSL / NORM x,y,z
N/A not applicable or not measured

Calibration is Performed According to the Following Standards:

- a) IEEE Std 1528-2013, "IEEE Recommended Practice for Determining the Peak Spatial-Averaged Specific Absorption Rate (SAR) in the Human Head from Wireless Communications Devices: Measurement Techniques", June 2013
- b) IEC 62209-1, "Procedure to measure the Specific Absorption Rate (SAR) for hand-held devices used in close proximity to the ear (frequency range of 300 MHz to 3 GHz)", February 2005
- c) IEC 62209-2, "Procedure to determine the Specific Absorption Rate (SAR) for wireless communication devices used in close proximity to the human body (frequency range of 30 MHz to 6 GHz)", March 2010
- d) KDB 865664, "SAR Measurement Requirements for 100 MHz to 6 GHz"

Additional Documentation:

- e) DASy4/5 System Handbook

Methods Applied and Interpretation of Parameters:

- *Measurement Conditions:* Further details are available from the Validation Report at the end of the certificate. All figures stated in the certificate are valid at the frequency indicated.
- *Antenna Parameters with TSL:* The dipole is mounted with the spacer to position its feed point exactly below the center marking of the flat phantom section, with the arms oriented parallel to the body axis.
- *Feed Point Impedance and Return Loss:* These parameters are measured with the dipole positioned under the liquid filled phantom. The impedance stated is transformed from the measurement at the SMA connector to the feed point. The Return Loss ensures low reflected power. No uncertainty required.
- *Electrical Delay:* One-way delay between the SMA connector and the antenna feed point. No uncertainty required.
- *SAR measured:* SAR measured at the stated antenna input power.
- *SAR normalized:* SAR as measured, normalized to an input power of 1 W at the antenna connector.
- *SAR for nominal TSL parameters:* The measured TSL parameters are used to calculate the nominal SAR result.

The reported uncertainty of measurement is stated as the standard uncertainty of measurement multiplied by the coverage factor k=2, which for a normal distribution corresponds to a coverage probability of approximately 95%.

| | | | |
|-----------------|-------------------------------|---------------|------------|
| Test Report #: | SAR-FION-002-17001_Appendix_C | FCC ID: | 2ANVA-V200 |
| Date of Report: | 2018-02-12 | IC Cert. No.: | 22342-V200 |



| | | | |
|-----------------|-------------------------------|---------------|------------|
| Test Report #: | SAR-FION-002-17001_Appendix_C | FCC ID: | 2ANVA-V200 |
| Date of Report: | 2018-02-12 | IC Cert. No.: | 22342-V200 |



Measurement Conditions

DASY system configuration, as far as not given on page 1.

| | | |
|------------------------------|------------------------|-------------|
| DASY Version | DASY5 | V52.8.8 |
| Extrapolation | Advanced Extrapolation | |
| Phantom | Modular Flat Phantom | |
| Distance Dipole Center - TSL | 10 mm | with Spacer |
| Zoom Scan Resolution | dx, dy, dz = 5 mm | |
| Frequency | 2450 MHz ± 1 MHz | |

Head TSL parameters

The following parameters and calculations were applied.

| | Temperature | Permittivity | Conductivity |
|---|-----------------|--------------|------------------|
| Nominal Head TSL parameters | 22.0 °C | 39.2 | 1.80 mho/m |
| Measured Head TSL parameters | (22.0 ± 0.2) °C | 40.0 ± 6 % | 1.83 mho/m ± 6 % |
| Head TSL temperature change during test | < 0.5 °C | ---- | ---- |

SAR result with Head TSL

| SAR averaged over 1 cm ³ (1 g) of Head TSL | Condition | |
|---|--------------------|---------------------------------|
| SAR measured | 250 mW input power | 12.8 W/kg |
| SAR for nominal Head TSL parameters | normalized to 1W | 51.0 W/kg ± 17.0 % (k=2) |

| SAR averaged over 10 cm ³ (10 g) of Head TSL | condition | |
|---|--------------------|---------------------------------|
| SAR measured | 250 mW input power | 5.92 W/kg |
| SAR for nominal Head TSL parameters | normalized to 1W | 23.7 W/kg ± 16.5 % (k=2) |

Body TSL parameters

The following parameters and calculations were applied.

| | Temperature | Permittivity | Conductivity |
|---|-----------------|--------------|------------------|
| Nominal Body TSL parameters | 22.0 °C | 52.7 | 1.95 mho/m |
| Measured Body TSL parameters | (22.0 ± 0.2) °C | 52.7 ± 6 % | 1.98 mho/m ± 6 % |
| Body TSL temperature change during test | < 0.5 °C | ---- | ---- |

SAR result with Body TSL

| SAR averaged over 1 cm ³ (1 g) of Body TSL | Condition | |
|---|--------------------|---------------------------------|
| SAR measured | 250 mW input power | 12.3 W/kg |
| SAR for nominal Body TSL parameters | normalized to 1W | 48.8 W/kg ± 17.0 % (k=2) |

| SAR averaged over 10 cm ³ (10 g) of Body TSL | condition | |
|---|--------------------|---------------------------------|
| SAR measured | 250 mW input power | 5.73 W/kg |
| SAR for nominal Body TSL parameters | normalized to 1W | 22.8 W/kg ± 16.5 % (k=2) |

| | | | |
|-----------------|-------------------------------|---------------|------------|
| Test Report #: | SAR-FION-002-17001_Appendix_C | FCC ID: | 2ANVA-V200 |
| Date of Report: | 2018-02-12 | IC Cert. No.: | 22342-V200 |



Appendix (Additional assessments outside the scope of SCS 0108)

Antenna Parameters with Head TSL

| | |
|--------------------------------------|--------------------------------|
| Impedance, transformed to feed point | 53.2 Ω + 3.7 j Ω |
| Return Loss | - 26.5 dB |

Antenna Parameters with Body TSL

| | |
|--------------------------------------|--------------------------------|
| Impedance, transformed to feed point | 49.9 Ω + 6.0 j Ω |
| Return Loss | - 24.4 dB |

General Antenna Parameters and Design

| | |
|----------------------------------|----------|
| Electrical Delay (one direction) | 1.159 ns |
|----------------------------------|----------|

After long term use with 100W radiated power, only a slight warming of the dipole near the feedpoint can be measured.

The dipole is made of standard semirigid coaxial cable. The center conductor of the feeding line is directly connected to the second arm of the dipole. The antenna is therefore short-circuited for DC-signals. On some of the dipoles, small end caps are added to the dipole arms in order to improve matching when loaded according to the position as explained in the "Measurement Conditions" paragraph. The SAR data are not affected by this change. The overall dipole length is still according to the Standard.

No excessive force must be applied to the dipole arms, because they might bend or the soldered connections near the feedpoint may be damaged.

Additional EUT Data

| | |
|-----------------|----------------|
| Manufactured by | SPEAG |
| Manufactured on | April 23, 2010 |

| | | | |
|-----------------|-------------------------------|---------------|------------|
| Test Report #: | SAR-FION-002-17001_Appendix_C | FCC ID: | 2ANVA-V200 |
| Date of Report: | 2018-02-12 | IC Cert. No.: | 22342-V200 |

DASY5 Validation Report for Head TSL

Date: 19.04.2016

Test Laboratory: SPEAG, Zurich, Switzerland

DUT: Dipole 2450 MHz; Type: D2450V2; Serial: D2450V2 - SN: 859

Communication System: UID 0 - CW; Frequency: 2450 MHz

Medium parameters used: $f = 2450$ MHz; $\sigma = 1.83$ S/m; $\epsilon_r = 40$; $\rho = 1000$ kg/m³

Phantom section: Flat Section

Measurement Standard: DASY5 (IEEE/IEC/ANSI C63.19-2011)

DASY52 Configuration:

- Probe: EX3DV4 - SN7349; ConvF(7.76, 7.76, 7.76); Calibrated: 31.12.2015;
- Sensor-Surface: 1.4mm (Mechanical Surface Detection)
- Electronics: DAE4 Sn601; Calibrated: 30.12.2015
- Phantom: Flat Phantom 5.0 (front); Type: QD000P50AA; Serial: 1001
- DASY52 52.8.8(1258); SEMCAD X 14.6.10(7372)

Dipole Calibration for Head Tissue/Pin=250 mW, d=10mm/Zoom Scan (7x7x7)/Cube 0:

Measurement grid: dx=5mm, dy=5mm, dz=5mm

Reference Value = 112.1 V/m; Power Drift = 0.04 dB

Peak SAR (extrapolated) = 25.9 W/kg

SAR(1 g) = 12.8 W/kg; SAR(10 g) = 5.92 W/kg

Maximum value of SAR (measured) = 20.8 W/kg

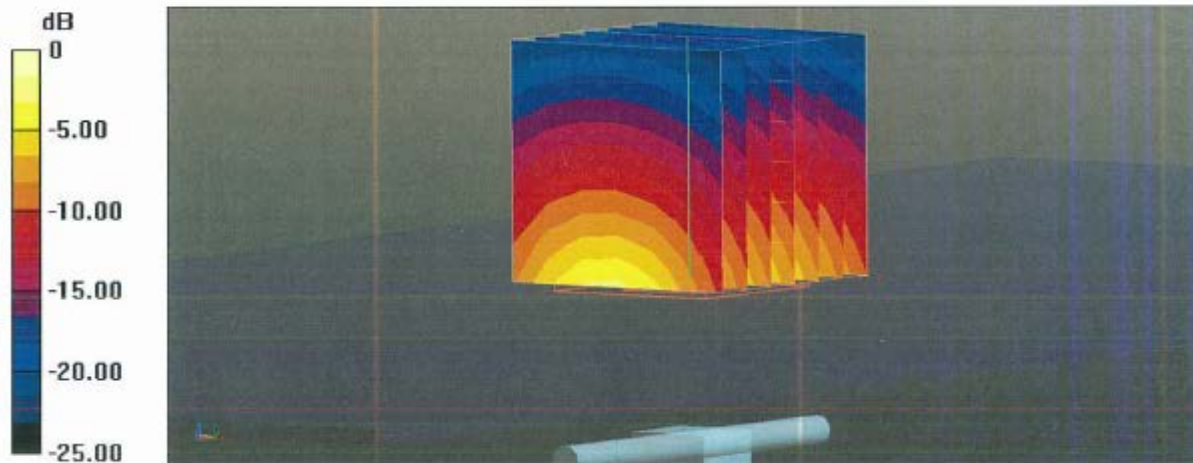

0 dB = 20.8 W/kg = 13.18 dBW/kg

| | | | |
|-----------------|-------------------------------|---------------|------------|
| Test Report #: | SAR-FION-002-17001_Appendix_C | FCC ID: | 2ANVA-V200 |
| Date of Report: | 2018-02-12 | IC Cert. No.: | 22342-V200 |



Impedance Measurement Plot for Head TSL

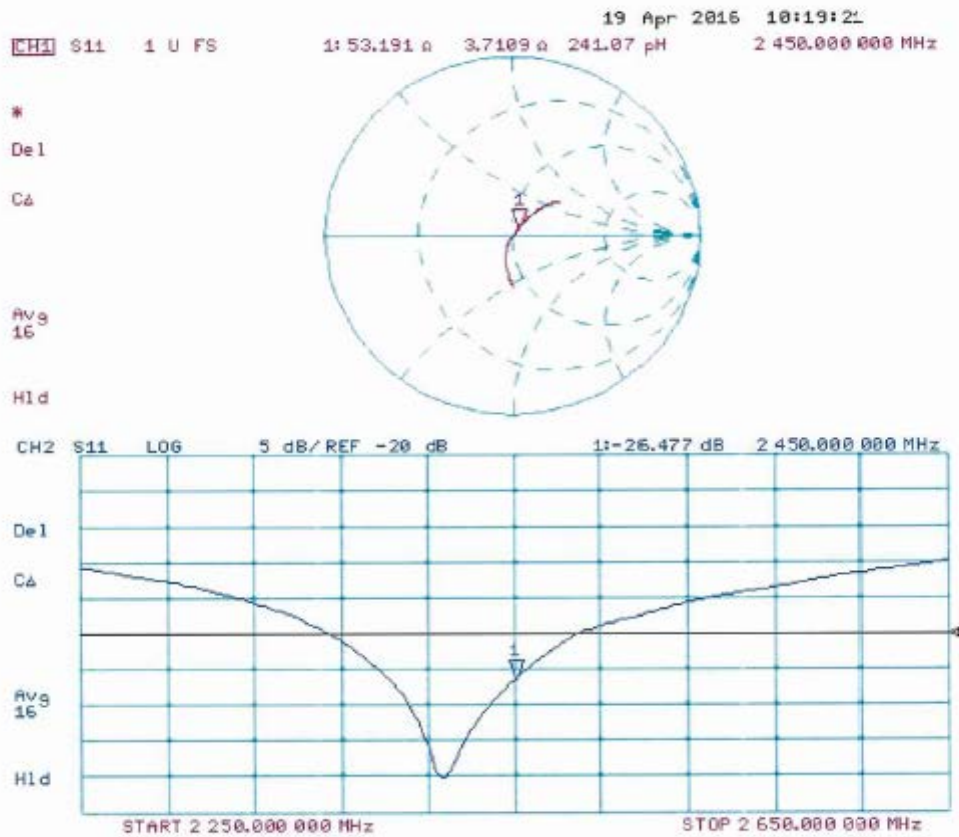

| | | | |
|-----------------|-------------------------------|---------------|------------|
| Test Report #: | SAR-FION-002-17001_Appendix_C | FCC ID: | 2ANVA-V200 |
| Date of Report: | 2018-02-12 | IC Cert. No.: | 22342-V200 |

DASY5 Validation Report for Body TSL

Date: 19.04.2016

Test Laboratory: SPEAG, Zurich, Switzerland

DUT: Dipole 2450 MHz; Type: D2450V2; Serial: D2450V2 - SN: 859

Communication System: UID 0 - CW; Frequency: 2450 MHz

Medium parameters used: $f = 2450$ MHz; $\sigma = 1.98$ S/m; $\epsilon_r = 52.7$; $\rho = 1000$ kg/m³

Phantom section: Flat Section

Measurement Standard: DASY5 (IEEE/IEC/ANSI C63.19-2011)

DASY52 Configuration:

- Probe: EX3DV4 - SN7349; ConvF(7.79, 7.79, 7.79); Calibrated: 31.12.2015;
- Sensor-Surface: 1.4mm (Mechanical Surface Detection)
- Electronics: DAE4 Sn601; Calibrated: 30.12.2015
- Phantom: Flat Phantom 5.0 (back); Type: QD000P50AA; Serial: 1002
- DASY52 52.8.8(1258); SEMCAD X 14.6.10(7372)

Dipole Calibration for Body Tissue/Pin=250 mW, d=10mm/Zoom Scan (7x7x7)/Cube 0:

Measurement grid: dx=5mm, dy=5mm, dz=5mm

Reference Value = 104.7 V/m; Power Drift = 0.04 dB

Peak SAR (extrapolated) = 24.4 W/kg

SAR(1 g) = 12.3 W/kg; SAR(10 g) = 5.73 W/kg

Maximum value of SAR (measured) = 20.0 W/kg

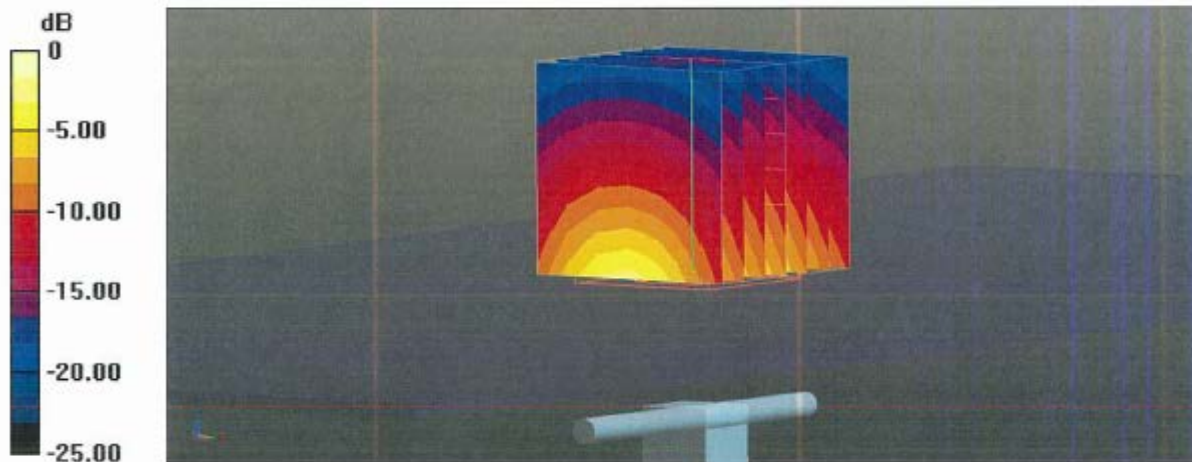

0 dB = 20.0 W/kg = 13.01 dBW/kg

| | | | |
|-----------------|-------------------------------|---------------|------------|
| Test Report #: | SAR-FION-002-17001_Appendix_C | FCC ID: | 2ANVA-V200 |
| Date of Report: | 2018-02-12 | IC Cert. No.: | 22342-V200 |



Impedance Measurement Plot for Body TSL

