

# TASHI

## MT430 User Manual and Installation Guide

Version : 1.0  
2018/3/27



# Table of Contents

|   |           |
|---|-----------|
| <b>TABLE OF CONTENTS</b> .....              | <b>2</b>  |
| <b>ABOUT THIS MANUAL</b> .....              | <b>4</b>  |
| Regulatory Compliance Statements.....       | 4         |
| LED Information.....                        | 8         |
| Adapter Notice .....                        | 8         |
| Hearing Damage Warning .....                | 9         |
| Warranty Policy .....                       | 9         |
| <b>CHAPTER 1</b> .....                      | <b>10</b> |
| <b>INTRODUCTION</b> .....                   | <b>10</b> |
| MT430 IP Based Biometric Terminal.....      | 10        |
| <b>CHAPTER 2</b> .....                      | <b>11</b> |
| <b>PACKAGE AND INTERFACE OVERVIEW</b> ..... | <b>11</b> |
| Packing.....                                | 11        |
| Interface of Standard Model .....           | 12        |
| Interface of Fingerprint Model.....         | 13        |
| Other function keys schematic .....         | 14        |
| Terminal Block .....                        | 16        |
| Relay pin definition .....                  | 17        |
| <b>CHAPTER 3</b> .....                      | <b>18</b> |
| <b>INSTALLATION</b> .....                   | <b>18</b> |
| Installation .....                          | 18        |
| Recommended installation height .....       | 20        |
| <b>CHAPTER 4</b> .....                      | <b>21</b> |
| <b>GETTING STARTED</b> .....                | <b>21</b> |
| Connect the power supply.....               | 21        |
| Using the MT430 for the first time .....    | 21        |

|  |           |
|--|-----------|
| Application Programs .....                       | 21        |
| Set date and time .....                          | 22        |
| <b>CHAPTER 5</b> .....                           | <b>24</b> |
| <b>BASIC OPERATION</b> .....                     | <b>24</b> |
| Wireless RF Card Reading Test .....              | 24        |
| Camera Test.....                                 | 25        |
| Fingerprint identification test (optional) ..... | 26        |
| <b>APPENDIX A</b> .....                          | <b>30</b> |
| <b>SYSTEM SPECIFICATIONS</b> .....               | <b>30</b> |
| <b>APPENDIX B</b> .....                          | <b>32</b> |
| <b>WORLDWIDE SUPPORT</b> .....                   | <b>32</b> |

## About This Manual

Thank you for purchasing the TASHI product.

This manual explains how to install, operate and maintain our product.

No part of this publication may be reproduced or used in any form, or by any electrical or mechanical means, such as photocopying, recording, or information storage and retrieval systems, without permission in writing from the manufacturer. The material in this manual is subject to change without notice.

## Regulatory Compliance Statements

---

### FCC Warning Statement

This device has been tested and found to comply with the limits for a Class B digital device, pursuant to part 15 of the FCC rules. These limits are designed to provide reasonable protection against harmful interference in a residential installation. This equipment generates uses and can radiate radio frequency energy and, if not installed and used in accordance with the instructions, may cause harmful interference with radio communications. However, there is no guarantee that interference will not occur in a particular installation. If this equipment does cause harmful interference with radio or television reception, which can be determined by turning the equipment off and on, the user is encouraged to try to correct the interference by one or more of the following measures:

- Reorient or relocate the receiving antenna.
- Increase the separation between the equipment and receiver.
- Connect the equipment into an outlet on a circuit different from that to which the receiver is connected.
- Consult the dealer or an experienced radio/TV technician for help.

1. This transmitter must not be co-located or operating in conjunction with any other antenna or transmitter.
2. This device complies with FCC RF radiation exposure limits set forth for an uncontrolled environment. To maintain compliance with FCC RF exposure requirements, avoid direct contact to the transmitting antenna during transmitting.
3. Any changes or modifications (including the antennas) made to this device that are not expressly approved by the manufacturer may void the user's authority to operate the equipment.

## FCC Label Statement

This device complies with part 15 of the FCC rules. Operation is subject to the following two conditions:

1. This device may not cause harmful interference.
2. This device must accept any interference received, including interference that may cause undesired operation.

## RF Radiation Exposure Statement

For body contact during operation, this device has been tested and meets FCC RF exposure guidelines when used with an accessory that contains no metal and that positions the handset a minimum of 0.5 cm from the body.

Use of other accessories may not ensure compliance with FCC RF exposure guidelines.

## Canadian Compliance Statement

This Class B Digital apparatus meets all requirements of the Canadian Interference-Causing Equipment Regulations.

Cet appareil numérique de la classe B respecte les exigences du Règlement sur le matériel brouilleur du Canada.

## European Conformity Statement

TASHI smartech co., Ltd here with declares that the TASHI product is in compliance with the essential requirements and all other provisions of the R&TTE 1999/5/EC directive, the EMC 2004/108/EC directive and the Low Voltage 2006/95/EC directive.

The declaration of conformity is available for download at:

<https://portal.unitech.eu/public/Safetyregulatorystatement>

## RoHS Statement



This device conforms to RoHS (Restriction Of Hazardous Substances) European Union regulations that set maximum concentration limits on hazardous materials used in electrical and electronic equipment.

## Waste electrical and electronic equipment (WEEE)

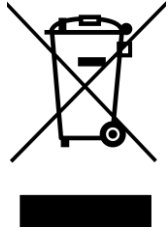

unitech group has set up a policy and process to meet the EU directive 2002/96/EC and update 2003/108/EC concerning electronic waste disposal.

For more detailed information of the electronic waste disposal of the products you have purchased from unitech group directly or via unitech group's resellers, you shall either contact your local supplier or visit us at :

<https://portal.unitech.eu/public/WEEE>

## 限用物質含有情況標示聲明書

Declaration of the Presence Condition of the Restricted Substances Marking

| 設備名稱： 網路式生物辨識終端機 ， 型號（型式）：MT430   |  |                  |  |  |  |  |  |   |   |   |   |   |   |   |   |   |   |   |   |   |   |   |   |   |   |   |   |   |   |   |   |   |   |   |   |   |
|---|--|------------------|--|--|--|--|--|---|---|---|---|---|---|---|---|---|---|---|---|---|---|---|---|---|---|---|---|---|---|---|---|---|---|---|---|---|
| Equipment name  | Type designation (Type)  |                  |  |  |  |  |  |   |   |   |   |   |   |   |   |   |   |   |   |   |   |   |   |   |   |   |   |   |   |   |   |   |   |   |   |   |
| 單元 Unit   | 限用物質及其化學符號<br>Restricted substances and its chemical symbols   |                  |  |  |  |  |  |   |   |   |   |   |   |   |   |   |   |   |   |   |   |   |   |   |   |   |   |   |   |   |   |   |   |   |   |   |
|   | <table border="1" style="width: 100%; border-collapse: collapse;"> <thead> <tr> <th style="text-align: center;">鉛Lead<br/>(Pb)</th> <th style="text-align: center;">汞Mercury<br/>(Hg)</th> <th style="text-align: center;">鎘Cadmium<br/>(Cd)</th> <th style="text-align: center;">六價鉻<br/>Hexavalent<br/>chromium<br/>(Cr<sup>+6</sup>)</th> <th style="text-align: center;">多溴聯苯<br/>Polybrominated<br/>biphenyls<br/>(PBB)</th> <th style="text-align: center;">多溴二苯醚<br/>Polybrominated<br/>diphenyl ethers<br/>(PBDE)</th> </tr> </thead> <tbody> <tr> <td style="text-align: center;">○</td> <td style="text-align: center;">○</td> <td style="text-align: center;">○</td> <td style="text-align: center;">○</td> <td style="text-align: center;">○</td> <td style="text-align: center;">○</td> </tr> <tr> <td style="text-align: center;">○</td> <td style="text-align: center;">○</td> <td style="text-align: center;">○</td> <td style="text-align: center;">○</td> <td style="text-align: center;">○</td> <td style="text-align: center;">○</td> </tr> <tr> <td style="text-align: center;">○</td> <td style="text-align: center;">○</td> <td style="text-align: center;">○</td> <td style="text-align: center;">○</td> <td style="text-align: center;">○</td> <td style="text-align: center;">○</td> </tr> <tr> <td style="text-align: center;">○</td> <td style="text-align: center;">○</td> <td style="text-align: center;">○</td> <td style="text-align: center;">○</td> <td style="text-align: center;">○</td> <td style="text-align: center;">○</td> </tr> <tr> <td style="text-align: center;">○</td> <td style="text-align: center;">○</td> <td style="text-align: center;">○</td> <td style="text-align: center;">○</td> <td style="text-align: center;">○</td> <td style="text-align: center;">○</td> </tr> </tbody> </table> | 鉛Lead<br>(Pb)    | 汞Mercury<br>(Hg)                                     | 鎘Cadmium<br>(Cd)                             | 六價鉻<br>Hexavalent<br>chromium<br>(Cr <sup>+6</sup> ) | 多溴聯苯<br>Polybrominated<br>biphenyls<br>(PBB) | 多溴二苯醚<br>Polybrominated<br>diphenyl ethers<br>(PBDE) | ○ | ○ | ○ | ○ | ○ | ○ | ○ | ○ | ○ | ○ | ○ | ○ | ○ | ○ | ○ | ○ | ○ | ○ | ○ | ○ | ○ | ○ | ○ | ○ | ○ | ○ | ○ | ○ | ○ |
| 鉛Lead<br>(Pb)   | 汞Mercury<br>(Hg)   | 鎘Cadmium<br>(Cd) | 六價鉻<br>Hexavalent<br>chromium<br>(Cr <sup>+6</sup> ) | 多溴聯苯<br>Polybrominated<br>biphenyls<br>(PBB) | 多溴二苯醚<br>Polybrominated<br>diphenyl ethers<br>(PBDE) |  |  |   |   |   |   |   |   |   |   |   |   |   |   |   |   |   |   |   |   |   |   |   |   |   |   |   |   |   |   |   |
| ○   | ○  | ○                | ○  | ○  | ○  |  |  |   |   |   |   |   |   |   |   |   |   |   |   |   |   |   |   |   |   |   |   |   |   |   |   |   |   |   |   |   |
| ○   | ○  | ○                | ○  | ○  | ○  |  |  |   |   |   |   |   |   |   |   |   |   |   |   |   |   |   |   |   |   |   |   |   |   |   |   |   |   |   |   |   |
| ○   | ○  | ○                | ○  | ○  | ○  |  |  |   |   |   |   |   |   |   |   |   |   |   |   |   |   |   |   |   |   |   |   |   |   |   |   |   |   |   |   |   |
| ○   | ○  | ○                | ○  | ○  | ○  |  |  |   |   |   |   |   |   |   |   |   |   |   |   |   |   |   |   |   |   |   |   |   |   |   |   |   |   |   |   |   |
| ○   | ○  | ○                | ○  | ○  | ○  |  |  |   |   |   |   |   |   |   |   |   |   |   |   |   |   |   |   |   |   |   |   |   |   |   |   |   |   |   |   |   |
| <p>備考1. “超出0.1 wt %” 及 “超出0.01 wt %” 係指限用物質之百分比含量超出百分比含量基準值。</p> <p>Note 1 : “Exceeding 0.1 wt %” and “exceeding 0.01 wt %” indicate that the percentage content of the restricted substance exceeds the reference percentage value of presence condition.</p> <p>備考2. “○” 係指該項限用物質之百分比含量未超出百分比含量基準值。</p> <p>Note 2 : “○” indicates that the percentage content of the restricted substance does not exceed the percentage of reference value of presence.</p> <p>備考3. “—” 係指該項限用物質為排除項目。</p> <p>Note 3 : The “—” indicates that the restricted substance corresponds to the exemption.</p> |  |                  |  |  |  |  |  |   |   |   |   |   |   |   |   |   |   |   |   |   |   |   |   |   |   |   |   |   |   |   |   |   |   |   |   |   |

### Taiwan NCC Warning Statement

#### 低功率電波輻射性電機管理辦法

第十二條：經型式認證合格之低功率射頻電機，非經許可，公司、商號或使用者均不得擅自變更頻率、加大功率或變更原設計之特性及功能。

第十四條：低功率射頻電機之使用不得影響飛航安全及干擾合法通信；經發現有干擾現象時，應立即停用，並改善至無干擾時方得繼續使用。

低功率射頻電機需忍受合法通信或工業、科學及醫療用電波輻射性電機設備之干擾。

## LED Information

---

The TASHI product contains LED indicator(s) or LED ring whose luminance is not harmful to human eyes during normal operation, user maintenance or prescribed service operations.

\*LED information only applies to the products with LED components.

## Storage and safety notice

Although charged batteries may be left unused for several months, their capacity may be depleted due to build up of internal resistance. If this happens, they will require recharging prior to use. Batteries may be stored at temperatures between -20°C to 60°C, however they may deplete more rapidly at higher temperatures. It is recommended to store batteries at room temperature.

*\* The message above only applies to the usage of the removable batteries.*

*For the products with non-removable batteries / without batteries, please refer to the specification of each product.*

## Product Operation and Storage Notice

---

The TASHI product has applicable operation and storage temperature conditions. Please follow the limitation of suggested temperature conditions to avoid failure, damage or malfunction.

*\*For applicable temperature conditions, please refer to the specification of each product.*

## Adapter Notice

---

1. Please do not leave the power adapter in the socket when it is not connected to your TASHI product for charging.
2. Please remove the power adapter when the battery is fully recharged.
3. The bundled power adapter that comes with your TASHI product is not meant to be used outdoors. An adapter exposed to water or rain, or a very humid environment can cause damage to both the adapter and the product.
4. Please only use the bundled power adapter or same specification of adapter to charge your TASHI



product. Using the wrong power adapter can damage your TASHI product.

*\* The message above only applies to the product connected to the adapter.*

*For the products without using the adapters, please refer to the specification of each product.*

## Hearing Damage Warning

---

### Zx.3 Warning

The warning shall be placed on the equipment, or on the packaging, or in the instruction manual and shall consist of the following:

- the symbol of Figure 1 with a minimum height of 5 mm; and
- the following wording, or similar :

To prevent possible hearing damage, do not listen at high volume levels for long periods.



Figure 1 – Warning label (IEC 60417-6044)

Alternatively, the entire warning may be given through the equipment display during use, when the user is asked to acknowledge activation of the higher level.

## Warranty Policy

---

The following items covered under the TASHI Limited Warranty are free from defects during normal use:

The warranty period is varied from each country. Please consult with your supplier or TASHI local office for actual length of warranty period to your purchased product.

Warranty becomes void if equipment is modified, improperly installed or used, damaged by accident or neglect, or if any parts are improperly installed or replaced by the user.

## Chapter 1

# Introduction

## MT430 IP Based Biometric Terminal

---





As a successor for replacing Window CE platform terminals, MT430 is an Android 6.0 equipped with Qualcomm platform, continuing to serve as a high end T&A terminals for Office and Home sectors in TASHI product line. To undertake the role set in those earlier generation products, MT430 is designed as a multi-functional terminal to perform access control, time attendance, security, and intercom. With its functions aforementioned, MT430 is with 5M pixels camera, 1:N finger print, and HF/LF readers, including HID, EM, MiFare/NFC/Felica; it is added on value with SIP function for performing video intercom and for mobile apps in smart phones. MT430 is certified with world' s major country safety certificates, and for resisting environmental conditions IP54 waterproofing / dustproof standard. The main intent for TASHI to providing MT430 is to offer users advanced features to create more user values in daily work and life.

## Chapter 2

# Package and Interface Overview

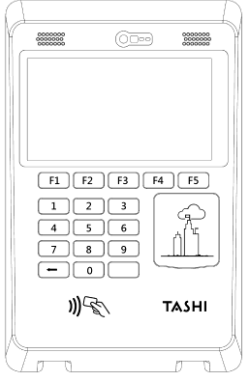
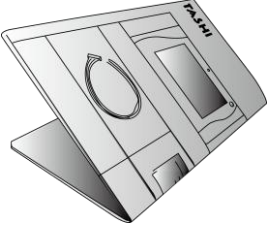
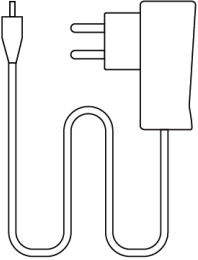
## Packing

Please make sure the following contents are in the MT430 box. If anything appears missing or damaged, please contact the TASHI representatives.

|   |   |   |   |
|---|---|---|---|
|           |   |   |  |
| <p align="center"><b>MT430</b><br/>Finger Print &amp; Reader Model or Reader only Model</p> |   | <p align="center">QRG Paper Note</p>  | <p align="center">Power Supplier</p>  |
|          |  |  |  |
| <p align="center">Relay Cable</p>   | <p align="center">Communication Cable</p>   | <p align="center">Magnetic tamper<br/>detection switch</p>                            | <p align="center">Screw</p>   |

## Interface of Standard Model

Different types of interface.

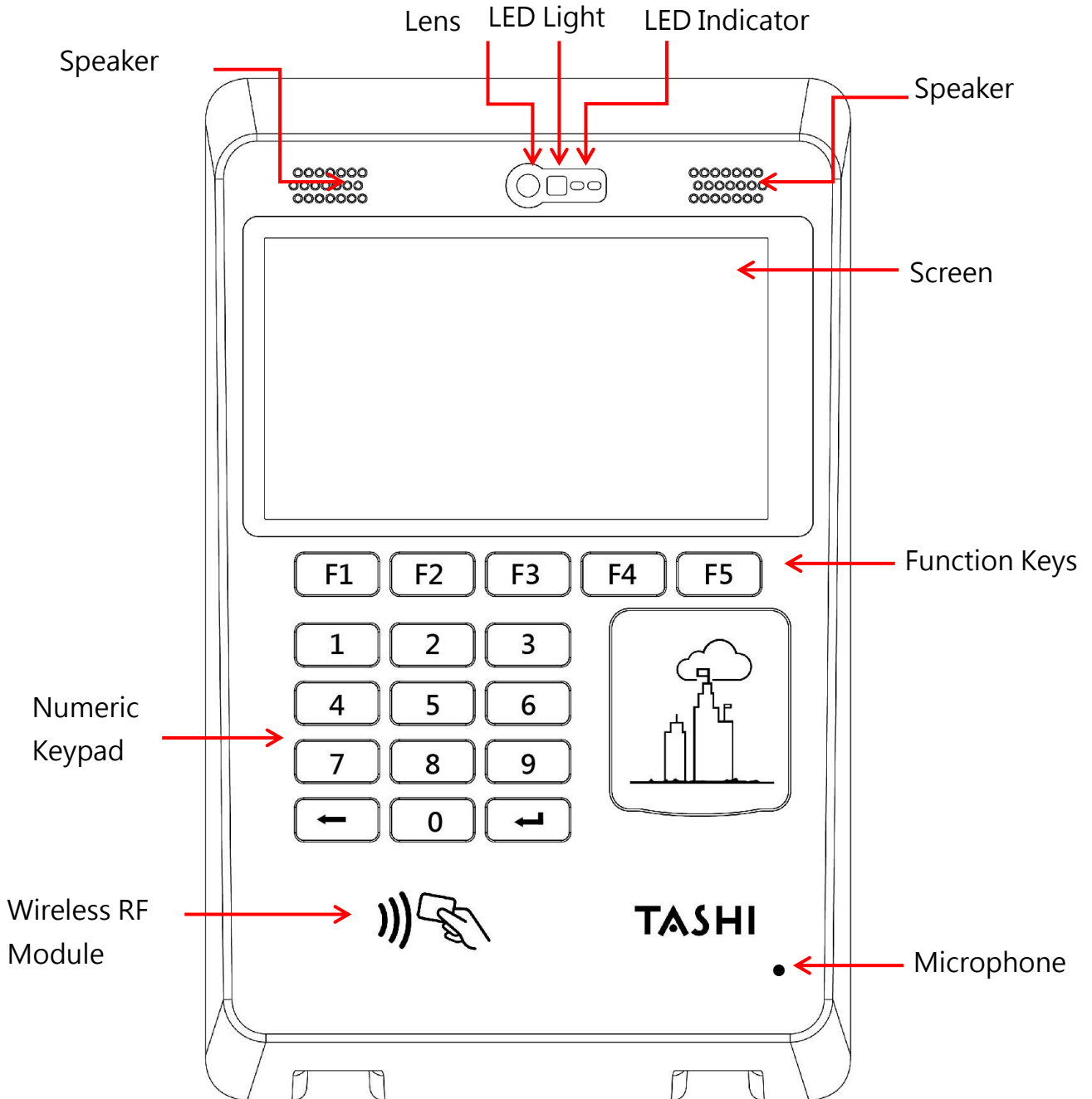

## Interface of Fingerprint Model

Different types of interface.

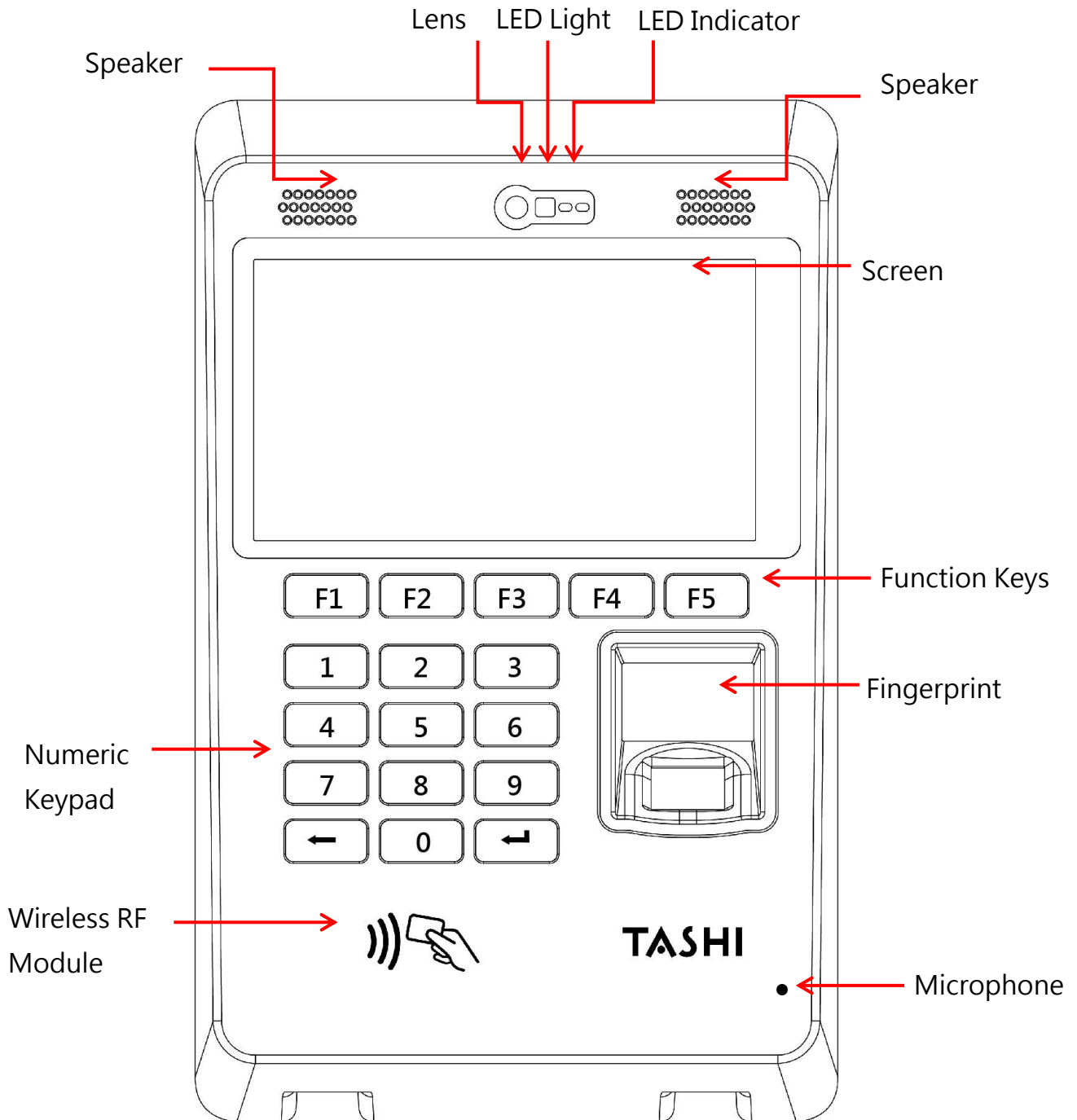

## Other function keys schematic

Different types of interface.

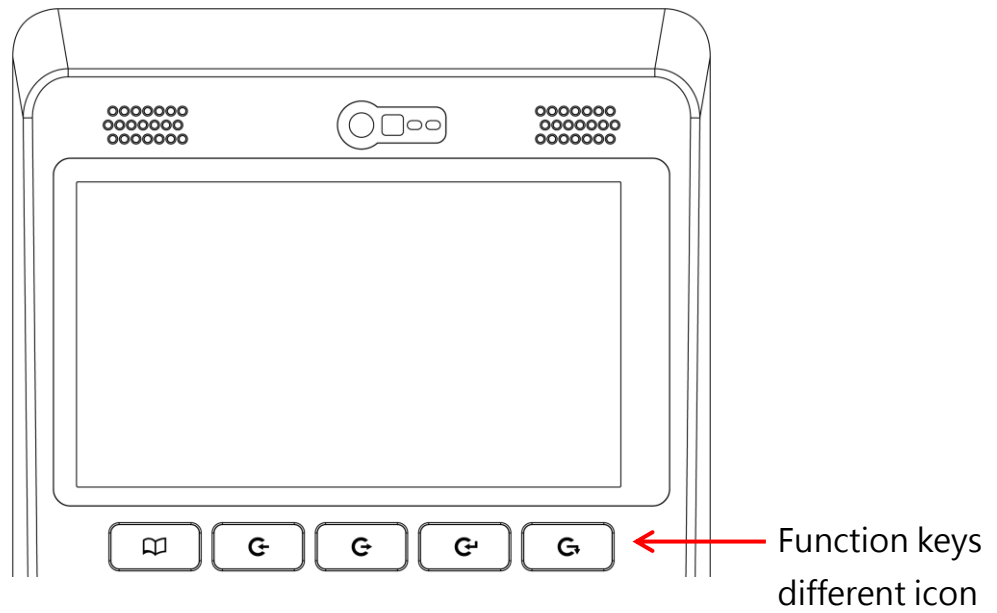
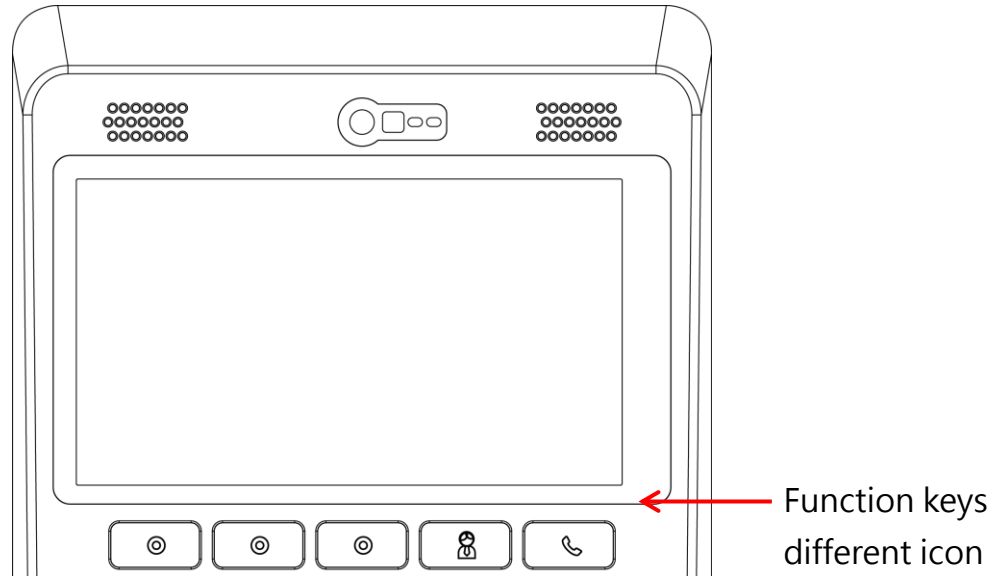

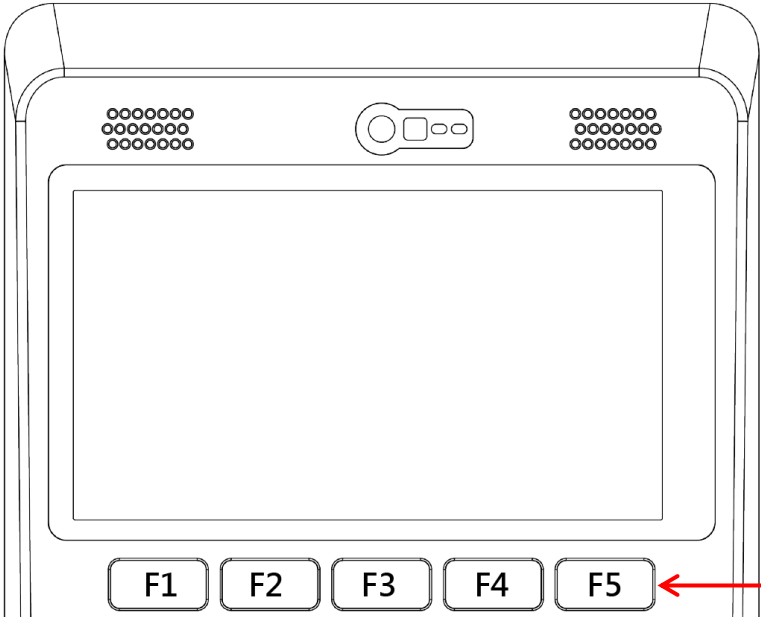

Function keys  
different icon

**Back View:**

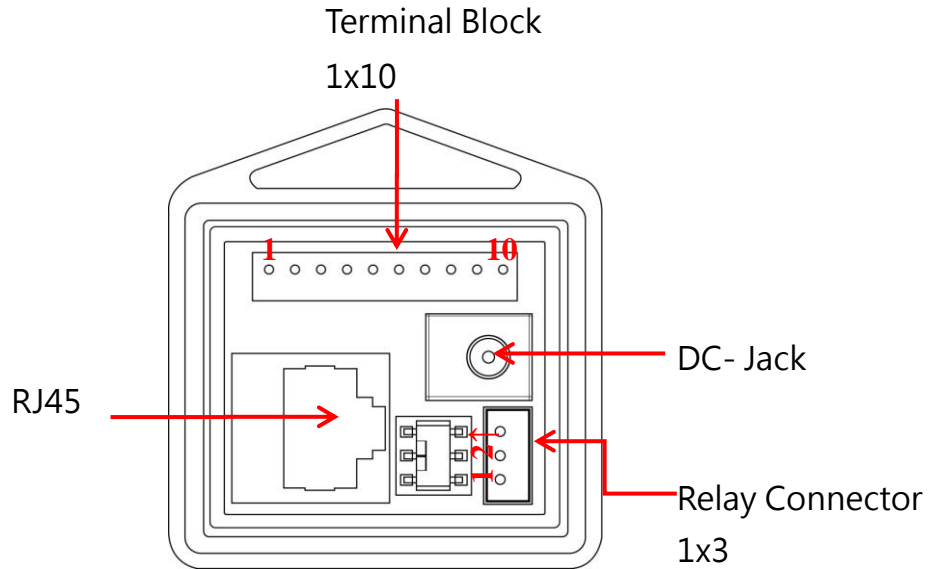

## Terminal Block

The MT430 provides a 10-pin terminal block plug for input/output signals.

Refer to the following illustration and insert the terminal block plug into the terminal block socket on the back side of the MT430.

Terminal Block (1X10)

| Pin   | Color  | Function     |
|-------|--------|--------------|
| Pin1  | Blue   | RS485-       |
| Pin2  | Green  | RS485+       |
| Pin3  | Yellow | DI-2         |
| Pin4  | Orange | DI-1         |
| Pin5  | Purple | Wiegand_D1   |
| Pin6  | Gray   | Wiegand_D2   |
| Pin7  | Black  | GND          |
| Pin8  | Black  | GND          |
| Pin9  | Red    | DC power 12V |
| Pin10 | Red    | DC power 12V |



## Relay pin definition

---

Relay Connector (1X3)

| Pin  | Color | Function |
|------|-------|----------|
| Pin1 | Black | Relay_NC |
| Pin2 | White | Relay_C  |
| Pin↑ | Brown | Relay_NO |

# Installation

## Installation

---

This section explains how to install the MT430.

1. Please lock the copper posts in the circle as below.
2. Then lock the wall mount (optional) to the in wall box

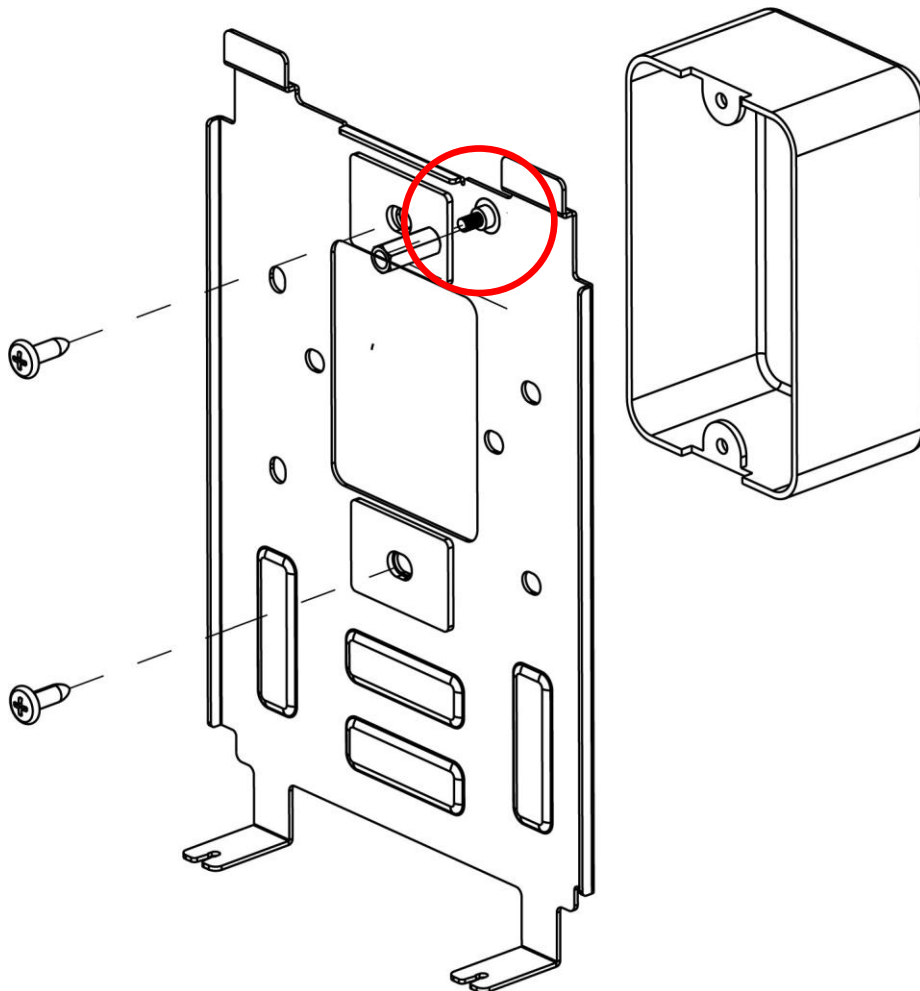

3. Finally hook the MT430 into the ditch as the red circle below and lock it to the wall mount.

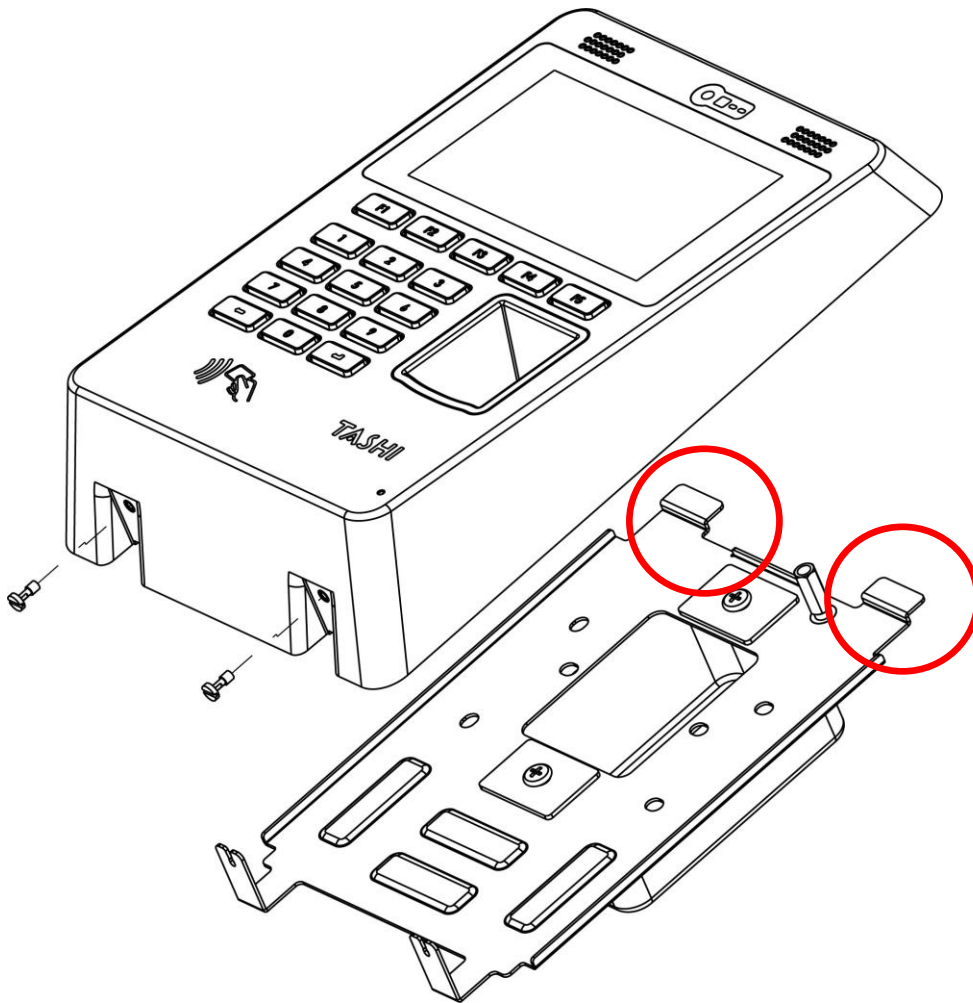

## Recommended installation height

---

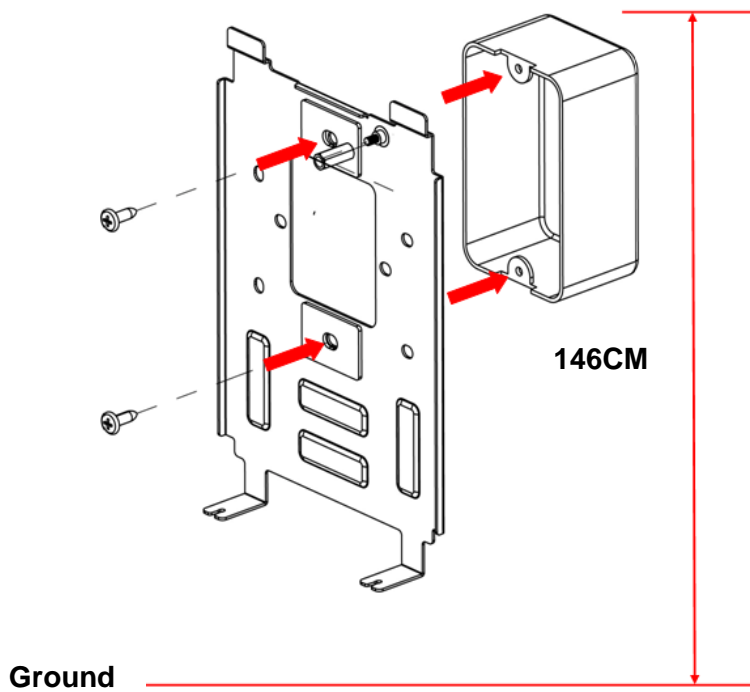

## Chapter 4

# Getting Started

## Connect the power supply

Use the following instructions to connect the power supply to the MT430: Plug the power adapter cable into the MT430's DC input jack, then connect the other end of the power adapter to a power outlet.

### Power on the MT430

When the power adapter is plugged into external power, the MT430 automatically turns on. TASHI screen appears.

## Using the MT430 for the first time

### Use the touch screen

1. Click on the screen to select an option.
2. Open the program
3. Use the on-screen keyboard to type letters or numbers into data fields or forms.

## Application Programs

Open application: button as below

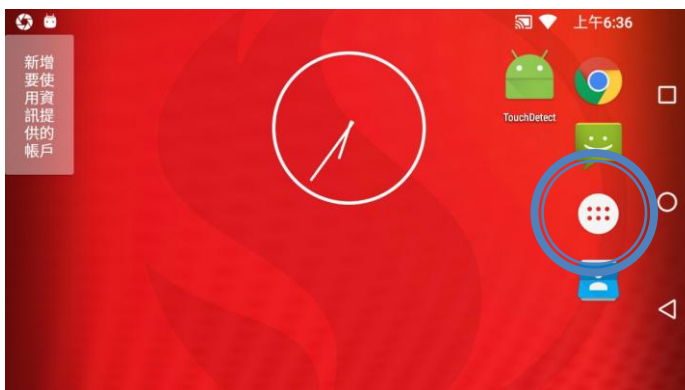

Select the application:



## Set date and time

Applications: Settings



Click on the date and time:

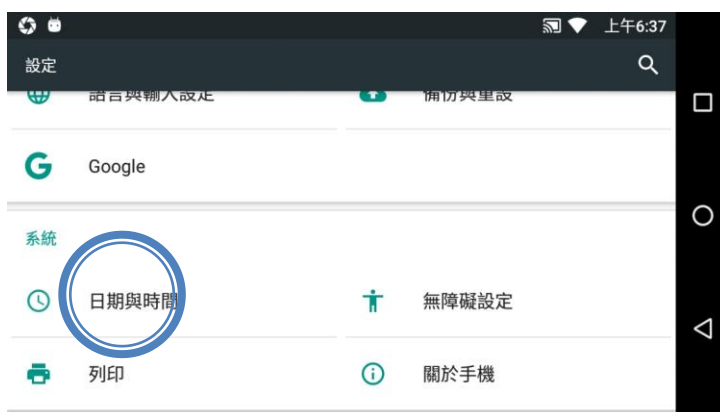

Make date/time/time zone settings:

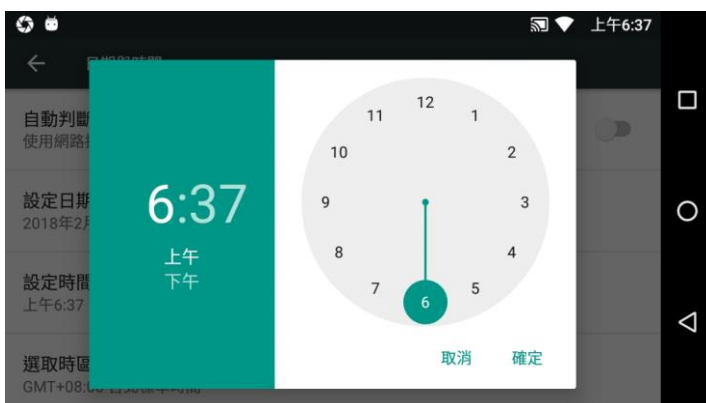
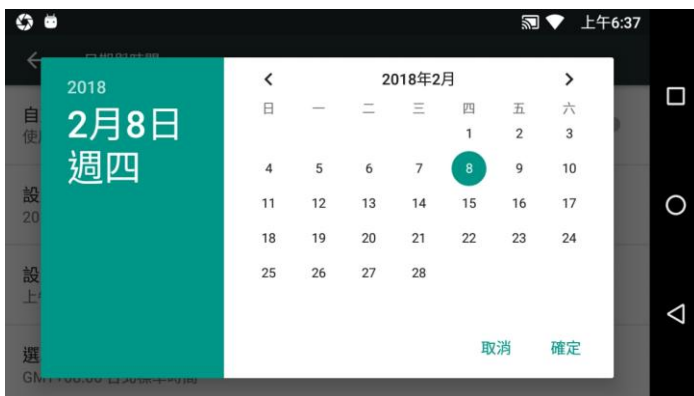

## Chapter 5

# Basic operation

### Wireless RF Card Reading Test

Find the RFID test in the programs: (RFID test)

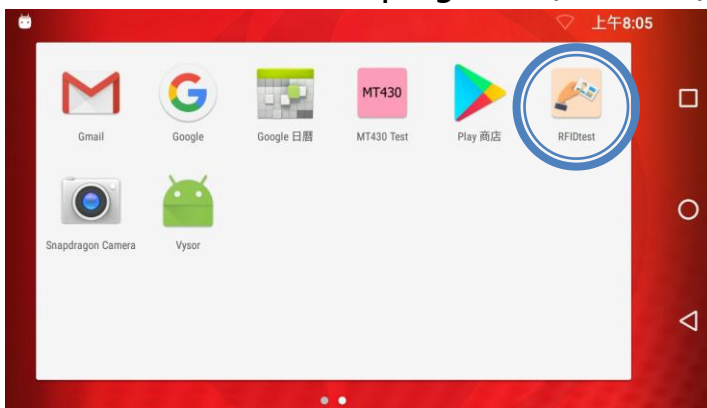

Click to open the test program, select the card format and press START on the right to start the wireless RF card reading test.

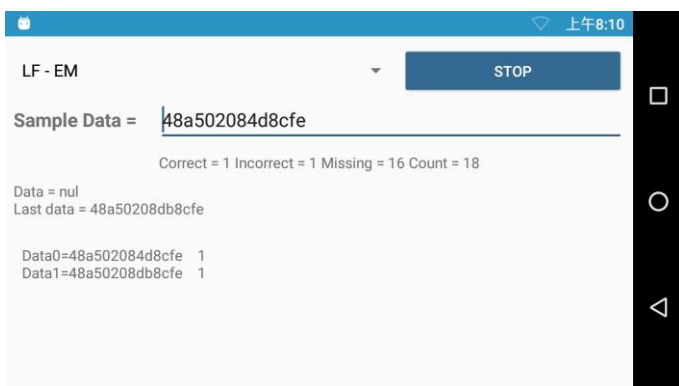
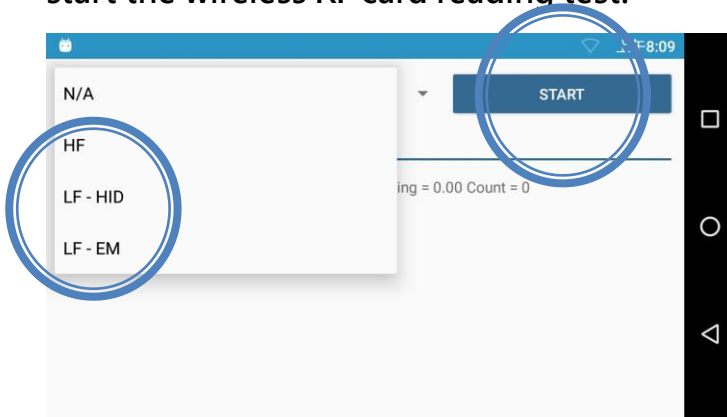



## Camera Test

---

Find the camera test program

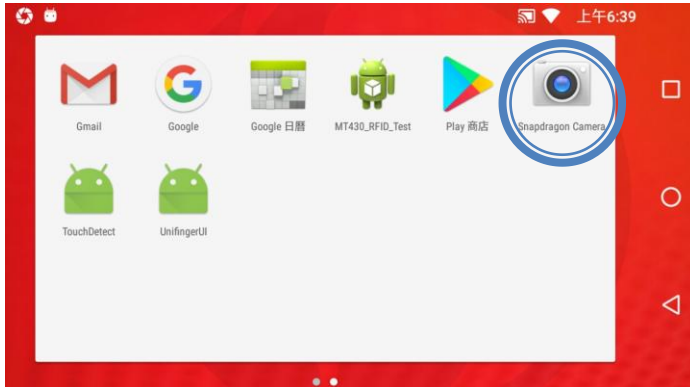

Click to open the test program to take a photo shoot test.



## Fingerprint identification test (optional)

Find the fingerprint test in the programs (Finger Print):

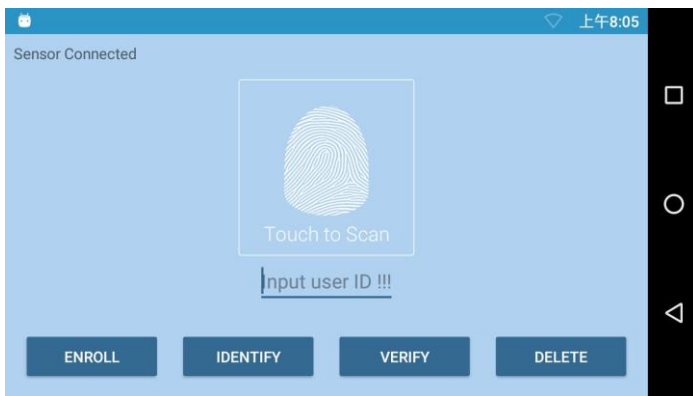

**ENROLL:** Create a fingerprint

**IDENTIFY:** Identification fingerprint

**VERIFY:** Verification fingerprint

**DELETE:** Delete fingerprint

Create a fingerprint: After pressing ENROLL, enter the number of the fingerprint (any number)

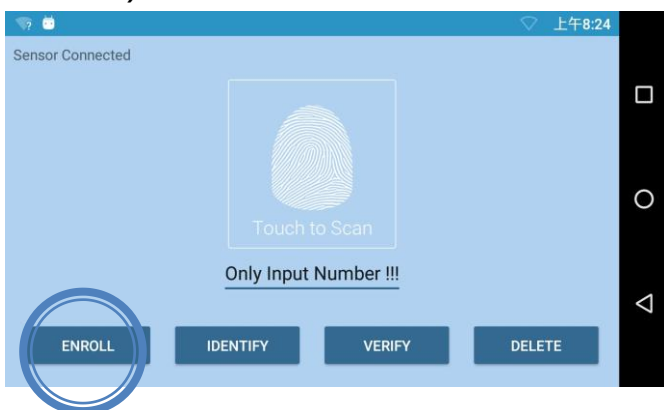

Enter any number and press the tick symbol (example is 888)

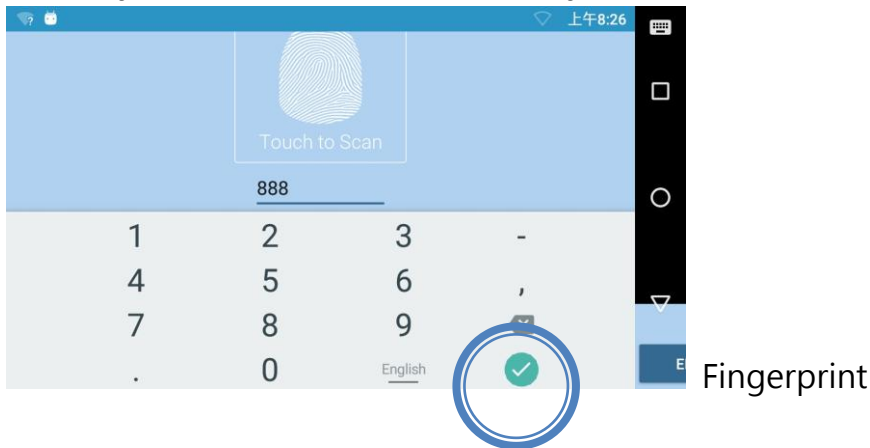

Return to the homepage and press ENROLL again. The fingerprint's red light will illuminate and placed your finger in the identification window. After successful reading, Enroll Success!! is displayed successfully on behalf of this fingerprint.

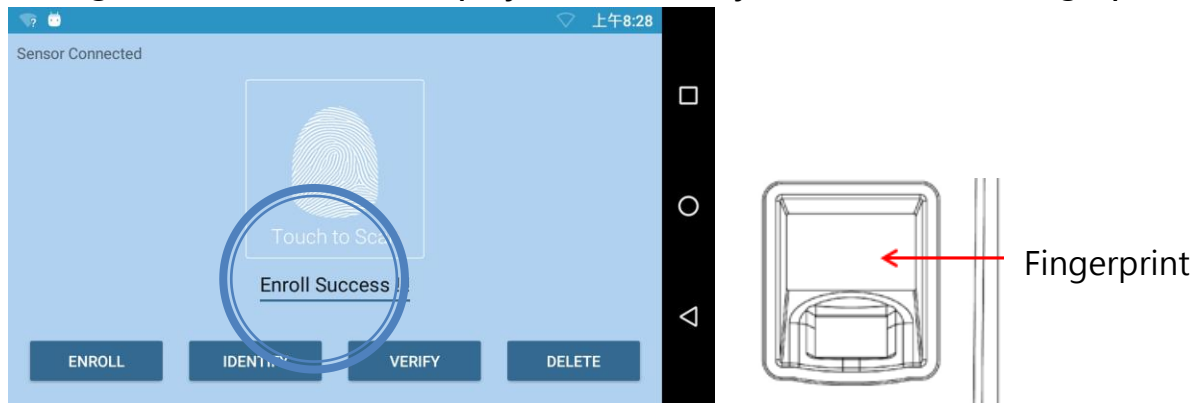

Recognition fingerprint: press IDENTIFY, after the red light of fingerprint identification is on, put your fingerprint into the identification window, and the number of the fingerprint will appear after the reading is successful.

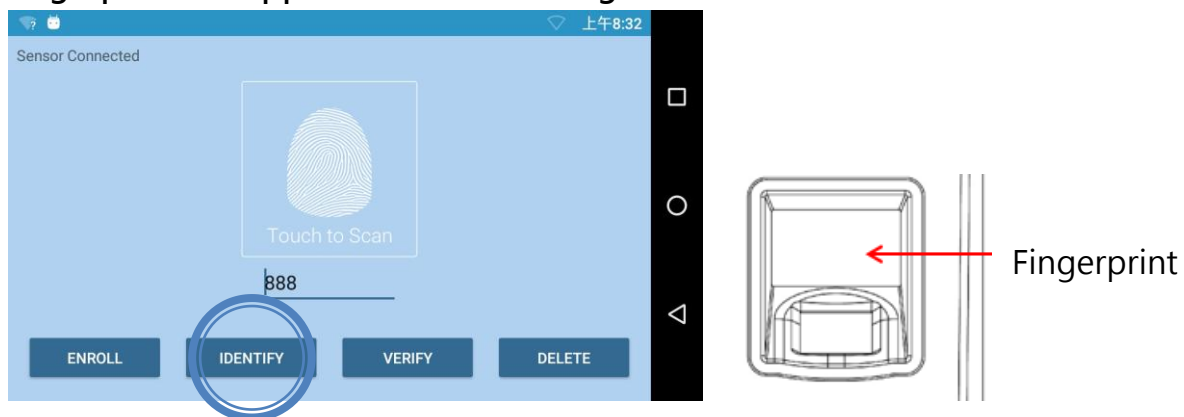

Verifying the fingerprint: Press VERIFY to enter the code for the fingerprint. Assuming that 888 is entered, press VERIFY again to verify that the fingerprint is correct.

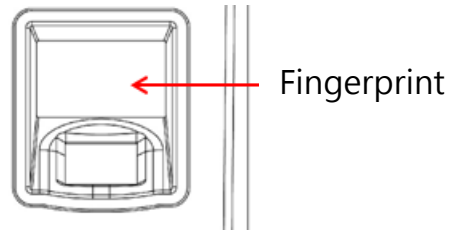
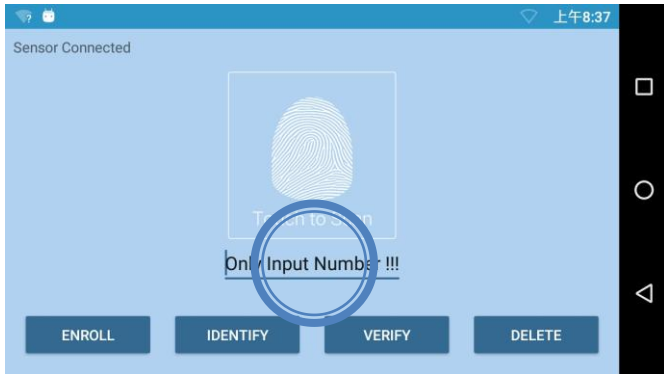

Verification failed:

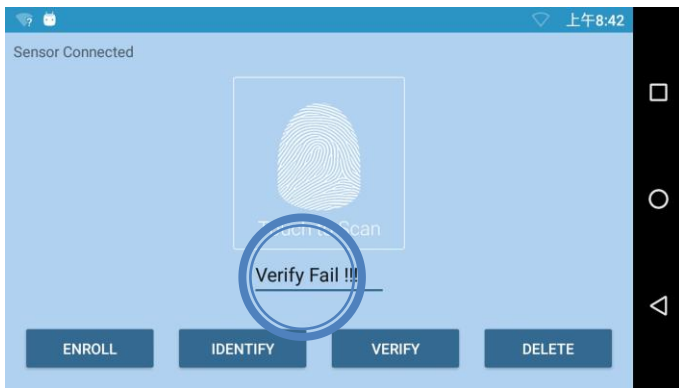

Verification successful:



Delete fingerprint: After pressing DELETE, input the fingerprint number to be deleted. Press DELETE again to return to the main screen to delete the fingerprint.

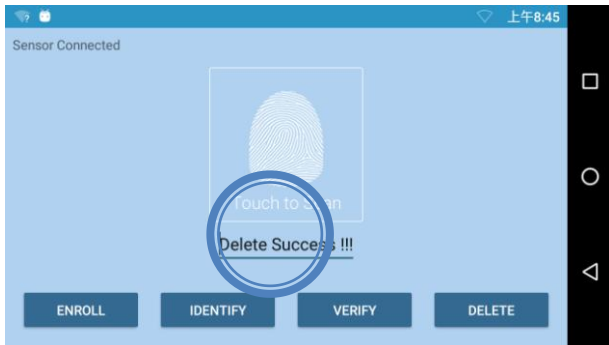

## Appendix A

# System Specifications

The following table shows the MT430 system specifications:

|               |  |
|---------------|--|
| CPU           | Qualcomm APQ8016   |
| Memory        | RAM: 2GB DDR3<br>ROM: 16GB eMMC  |
| OS            | Android 6.0  |
| LCD           | 4.7" Color TFT-LCD (720x 1280),<br>With touch screen/backlight function  |
| Button        | number key<br>Function keys 5<br>Enter key; Return key   |
| Camera        | 5 Megapixels   |
| Video         | 720p@30fps HD video playback and capture with H.264(AVC) and<br>playback with H.265(HEVC)  |
| Audio         | Full duplex<br>WAV/WMA<br>G.711 decode/encode<br>Sampling rate up to 48KHz   |
| Bluetooth     | V4.1 / BLE   |
| LED           | Red, Green, White (Fill light)   |
| I/O Interface | RJ45 10/100M bps PHY with POE function (optional)<br>DI x 1<br>Relay x1, 2A / 30V DC<br>Wigan Input / Output<br>RS485 RS485+, RS485-<br>Micro x 1, support up to 64 GB<br>SD |
| RFID          | Option 1: Mifare ISO-15693, ISO-14443A (EasyCard)/ 14443B/NFC/Felica<br>Option 2: EM<br>Option 3: HID  |
| Fingerprint   | Optical type (1:N)   |

|                       |   |
|-----------------------|---|
| Network               | 10/100M bps PHY<br>Full-duplex flow control<br>PoE(25W) on board (Optional via PCBA)<br>WiFi 802.11 b/g/n |
| Size and Weight       | 150.00 mm(L) x 240.00mm(W) x 50.61mm(H) / 700 公克  |
| Power Input           | DC 12V/2A   |
| Main Battery          | 3.7V / 5200mAh<br>(Up to 2~3 hours operation without power supply)  |
| Operating temperature | -10°C ~ 50°C (14°F ~ 122°F)   |
| Storage temperature   | -20°C ~ 60°C (-4°F ~ 140°F)   |
| Relative Humidity     | 5~95% non-condensed.  |
| IP Rating             | IP54 (front panel)  |

## Appendix B

### Worldwide Support

At Unitech group, we have a professional support team to answer your questions or any related technical issues. If the equipment problem occurs, you may contact our regional services representatives to get the quick response. We have seven regional services centers, and choose your region to get our quick support and their contact information can be found in our websites provided as below.

| Region                        | Website   |
|-------------------------------|---|
| TASHI Smartech                | <a href="http://www.tashi.ute.com">http://www.tashi.ute.com</a> |
| Global Operation Center       | <a href="http://www.ute.com">http://www.ute.com</a>             |
| Unitech Taiwan                | <a href="http://tw.ute.com">http://tw.ute.com</a>               |
| Unitech Asia Pacific & Middle | <a href="http://apac.ute.com">http://apac.ute.com</a>           |
|                               | <a href="http://india.ute.com">http://india.ute.com</a>         |
| Unitech China                 | <a href="http://cn.ute.com">http://cn.ute.com</a>               |
| Unitech Japan                 | <a href="http://jp.ute.com">http://jp.ute.com</a>               |
| Unitech America               | <a href="http://us.ute.com">http://us.ute.com</a>               |
|                               | <a href="http://can.ute.com">http://can.ute.com</a>             |
| Unitech Europe                | <a href="http://eu.ute.com">http://eu.ute.com</a>               |

In addition, you could contact TASHI Smartech by [TASHI@tashi.ute.com](mailto:TASHI@tashi.ute.com)