



**FCC 47 CFR PART 15 SUBPART C 15.247
TEST REPORT
FOR
Bluetooth Controller**

Model : LB0006

Issued to
Lebao Electronics co., Ltd.
15,2 F, Building D2, Epark Fuwan Industrial Zone, East District, Zhongshan,
Guangdong, China

Issued by
WH Technology Corp.



Open Site		No.120, Ln. 5, Hudong St., Xizhi Dist., New Taipei City 221, Taiwan (R.O.C.)
EMC Test Site	Xizhi Office and Lab	7F., No.262, Sec. 3, Datong Rd., Xizhi Dist., New Taipei City 221, Taiwan (R.O.C.)
Tel.: +886-2-7729-7707 Fax: +886-2- 8648-1311		
Test Firm Registration: 749714		

Note: This test refers exclusively to the test presented test model and sample. This report shall not be reproduced except in full, without the written approval of WH Technology Corp. This document may be altered or revised by WH Technology Corp. Personnel only, and shall be noted in the revision section of the document.



Contents

2. Report of Measurements and Examinations	5
2.1 List of Measurements and Examinations	5
3. Test Configuration of Equipment under Test	6
3.1 Description of the tested samples	6
3.2 Carrier Frequency of Channels	7
3.3 Test Mode and Test Software	8
3.4 TEST Methodology & General Test Procedures	9
3.5 Measurement Uncertainty	10
3.6 Description of the Support Equipments	10
4. Test and measurement equipment	11
4.1 calibration	11
4.2 equipment	11
5. Antenna Requirements	14
5.1 Standard Applicable	14
5.2 Antenna Construction and Directional Gain	14
6. Test of Radiated Emission	15
6.1 Test Limit	15
6.2 Test Procedures	15
6.3 Typical Test Setup	16
6.4 Test Result and Data (9kHz ~ 30MHz)	17
6.5 Test Result and Data (30MHz ~ 1GHz, worst emissions found)	17
6.1 Test Result and Data (Above 1GHz)	19
7. 6dB Bandwidth Measurement Data	22
7.1 Test Limit	22
7.2 Test Procedures	22
7.3 Test Setup Layout	22
7.4 Test Result and Data	23
8. Maximum Peak Output Power	25
8.1 Test Limit	25
8.2 Test Procedures	25
8.3 Test Setup Layout	25
8.4 Test Result and Data	26
9. Power Spectral Density	27
9.1 Test Limit	27
9.2 Test Procedures	27
9.3 Test Setup Layout	27
9.4 Test Result and Data	28



10. Band Edges Measurement	30
10.1 Test Limit	30
10.2 Test Procedure	30
10.3 Test Setup Layout	30
10.4 Test Result and Data	31
10.5 Restrict Band Emission Measurement Data	33
11. Restricted Bands of Operation	35
11.1 Labeling Requirement	35
12. Conducted Spurious Emission	36

APPENDIX 1 PHOTOS OF TEST CONFIGURATION

PHOTOS OF EUT



1. General Information

Applicant : Lebao Electronics co., Ltd.
Address : 15,2 F, Building D2, Epark Fuwan Industrial Zone, East District, Zhongshan, Guangdong, China
Manufacturer : Lebao Electronics co., Ltd.
Address : 15,2 F, Building D2, Epark Fuwan Industrial Zone, East District, Zhongshan, Guangdong, China
EUT : Bluetooth Controller
Model Name : LB0006
Trade Name : 
Model Differences : N/A

Is here with confirmed to comply with the requirements set out in the FCC Rules and Regulations Part 15 Subpart C and the measurement procedures were according to ANSI C63.10-2013. The said equipment in the configuration described in this report shows the maximum emission levels emanating

FCC part 15 subpart C

Receipt Date : 09/19/2017

Final Test Date : 11/15/2017

Tested By:

Tested By:

Nov 16, 2017



Date

Bell Wei/ Engineer

Nov 16, 2017



Date

Mike Lee / Manager
Designation Number: TW1083



2. Report of Measurements and Examinations

2.1 List of Measurements and Examinations

FCC Rule	Description of Test	Result
15.203	. Antenna Requirement	Pass
15.207	. Conducted Emission	N/A
15.209 15.247(d)	. Radiated Emission	Pass
15.247(a)(2)	. 6dB Bandwidth	Pass
15.247(b)	. Maximum Peak Output Power	Pass
15.247(d)	. 100kHz Bandwidth of Frequency Band Edges	Pass
15.247(e)	. Power Spectral Density	Pass
15.209 & 15.247(d)	. Conducted Spurious Emission (30MHz to 25GHz)	Pass



3. Test Configuration of Equipment under Test

3.1 Description of the tested samples

EUT Name : Bluetooth Controller

Model Number : LB0006

FCCID : 2ANU5-LB0006

Receipt Date : 09/19/2017

Power From : Inside Outside
Adaptor Battery AC Power Source
DC Power Source Support Unit PC or NB

Operate Frequency : Refer to the channel list as described below (2.402 ~2.480 GHz)

Modulation Technique : GFSK

Number of Channels : 40

Channel spacing : N/A 2 MHz

Operating Mode : Simplex Half Duplex

Antenna Type : PCB antenna

Antenna gain : 0 dBi



3.2 Carrier Frequency of Channels

BLE

Channel	Frequency(MHz)	Channel	Frequency(MHz)
00	2402	20	2442
01	2404	21	2444
02	2406	22	2446
03	2408	23	2448
04	2410	24	2450
05	2412	25	2452
06	2414	26	2454
07	2416	27	2456
08	2418	28	2458
09	2420	29	2460
10	2422	30	2462
11	2424	31	2464
12	2426	32	2466
13	2428	33	2468
14	2430	34	2470
15	2432	35	2472
16	2434	36	2474
17	2436	37	2476
18	2438	38	2478
19	2440	39	2480



3.3 Test Mode and Test Software

- a. During testing, the interface cables and equipment positions were varied according to ANSI C63.4.
- b. The complete test system included Notebook and EUT for RF test.
- c. Test Software: Radio Test.exe
- d. New Battery was used for all testing and the worst radiated emission case from X,Y and Z axis evaluation was selected for testing.
- e. The following test modes were performed for test:
 - BLE: CH00: 2402MHz, CH19: 2440MHz, CH39: 2480MHz



3.4 TEST Methodology & General Test Procedures

All testing as described bellowed were performed in accordance with ANSI C63.4:2014 and ANSI C63.10:2013.

Conducted Emissions

The EUT is placed on a wood table, which is at 0.8 m above ground plane acceding to clause 15.207 and requirements of ANSI C63.4:2014. Conducted emissions from the EUT measured in the frequency range between 0.15 MHz and 30MHz are using CISPR Quasi-Peak / Average detectors.

Radiated Emissions

The EUT is a placed on a turn table, which is 0.8 m above ground plane. The turntable was rotated through 360 degrees to determine the position of maximum emission level. The EUT is placed at 3m away from the receiving antenna, which varied from 1m to 4m to find out the highest emission. Each emission was to be maximized by changing the polarization of receiving antenna both horizontal and vertical.

- 1) Putting the EUT on the platform and turning on the EUT (on/off button on the bottom of the EUT).
- 2) Setting test channel described as “Channel setting and operating condition”, and testing channel by channel.
- 3) For the maximum output power measurement, we followed the method of measurement KDB558074 D01.
- 4) For the spurious emission test based on ANSI(2014), at the frequency where below 1GHz used quasi-peak detector mode; where above 1GHz used the peak and average detector mode. IF the peak value may be under average limit, the average mode will not be performed.



3.5 Measurement Uncertainty

Measurement Item	Uncertainty
Peak Output Power(conducted)	$\pm 1.345\text{dB}$
Power Spectral Density	$\pm 1.347\text{dB}$
Radiated emission(1G-25GHz)	$\pm 5.00\text{dB}$
Radiated emission(30M-1GHz)	$\pm 3.89\text{dB}$
Conducted emission	$\pm 1.81\text{dB}$

3.6 Description of the Support Equipments

Setup Diagram

See test photographs attached in appendix 1 for the actual connections between EUT and support equipment.

Support Equipment

Peripherals Devices:

OUTSIDE SUPPORT EQUIPMENT							
No.	Equipment	Model	Serial No.	FCC ID/ BSMI ID	Trade name	Data Cable	Power Cord
1.	Laptop	14q-by001A X	N/A	FCC DOC	HP	N/A	N/A
INSIDE SUPPORT EQUIPMENT							
No.	Equipment	Model	Serial No.	FCC ID/ BSMI ID	Trade name	Data Cable	Power Cord
1.	N/A	N/A	N/A	N/A	N/A	N/A	N/A

Note: All the above equipment /cable were placed in worse case position to maximize emission signals during emission test

Grounding: Grounding was in accordance with the manufacturer's requirement and conditions for the intended use.



4. Test and measurement equipment

4.1 calibration

The measuring equipment utilized to perform the tests documented in the report has been calibrated once a year or in accordance with the manufacturer's recommendations, and is traceable to recognized national standards.

4.2 equipment

The following list contains measurement equipment used for testing. The equipment conforms to the requirement of CISPR 16-1, ANSI C63.2 and. Other required standards.

Calibration of all test and measurement, including any accessories that may effect such calibration, is checked frequently to ensure the accuracy. Adjustments are made and correction factors are applied in accordance with the instructions contained in the respective.



TABLELIST OF TEST AND MEASUREMENT EQUIPMENT

Test Site	Instrument	Manufacturer	Model No.	S/N	Next Cal. Date
Conduction	Spectrum (9K--3GHz)	R&S	FSP3	833387/010	2018/09/20
	EMI Receiver	R&S	ESHS10	830223/008	2018/05/22
	LISN	Rolf Heine Hochfrequenztechnik	NNB-2/16z	98062	2018/05/25
	ISN	Schwarzbeck	8-Wire ISN CAT5	CAT5-8158-0094	2018/09/21
	RF Cable	N/A	N/A	EMI-3	2018/10/19
Radiation	Bilog antenna(30M-1G)	ETC	MCTD2786B	BLB16M04004/J B-5-004	2018/05/03
	Double Ridged Guide Horn antenna(1G-18G)	ETC	MCTD 1209	DRH15N0 2009	2017/11/23
	Horn antenna (18G-26G)	com-power	AH-826	81000	2018/08/15
	LOOP Antenna (Below 30M)	com-power	AL-130	17117	2018/10/04
	Pre amplifier (30M-1G)	EMC INSTRUMENT	EMC9135	980334	2018/05/04
	Microwave Preamplifier (1G-18G)	EMC INSTRUMENT	EMC051845	980108&AT -18001	2018/10/23
	Pre amplifier (18G~26G)	MITEQ	JS4-18002600-30 -5A	808329	2018/08/10
	EMI Test Receiver	R&S	ESVS30 (20M-1000MHz)	826006/002	2017/11/28



	RF Cable (open site)	EMCI	N male on end of both sides (EMI4)	30m	2018/10/19
	RF CABLE (1~26.5G)	HARBOUT INDUSTRIES	LL142MI(4M+4M)	NA	2018/03/08
	RF CABLE (1~26.5G)	HARBOUR INDUSTRIES	LL142MI(7M)	NA	2018/08/11
	Spectrum (9K--7GHz)	R&S	FSP7	830180/006	2018/03/25
	Spectrum (9K--40GHz)	AGILENT	8564EC	4046A0032	2018/03/01
Software	e3	AUDIX	N/A	N/A	N/A

***CALIBRATION INTERVAL OF INSTRUMENTS LISTED ABOVE IS ONE YEAR**



5. Antenna Requirements

5.1 Standard Applicable

For intentional device, according to FCC 47 CFR Section 15.203, an intentional radiator shall be designed to ensure that no antenna other than that furnished by the responsible party shall be used with the device.

And according to FCC 47 CFR Section 15.247 (b), if transmitting antennas of directional gain greater than 6dBi are used, the power shall be reduced by the amount in dB that the directional gain of the antenna exceeds 6dBi.

5.2 Antenna Construction and Directional Gain

BLE:

Antenna Type: PCB Antenna

Antenna Gain: 0 dBi



6. Test of Radiated Emission

6.1 Test Limit

In any 100kHz bandwidth outside the frequency band in which the spread spectrum or digitally modulated intentional radiator is operating, the radio frequency power that is produced by the intentional radiator shall be at least 20dB below that in the 100kHz bandwidth within the band that contains the highest level of the desired power, based on either an RF conducted or a radiated measurement. If the transmitter measurement is based on the maximum conducted output power, the attenuation required under this paragraph shall be 30dB instead of 20dB. In addition, radiated emissions which fall in section 15.205(a) the restricted bands must also comply with the radiated emission limit specified in section 15.209(a).

Frequency (MHz)	Field Strength (microvolt/meter)	Measurement Distance (meters)
0.009 ~ 0.490	2400/F(kHz)	300
0.490 ~ 1.705	24000/F(kHz)	30
1.705 ~ 30.0	30	30
30 ~ 88	100	3
88 ~ 216	150	3
216 ~ 960	200	3
Above 960	500	3

6.2 Test Procedures

- a. The EUT was placed on a rotatable table top 0.8 meter above ground.
- b. The EUT was set 3 meters from the interference receiving antenna which was mounted on the top of a variable height antenna tower.
- c. The table was rotated 360 degrees to determine the position of the highest radiation.
- d. The antenna is a broadband antenna and its height is varied between one meter and four meters above ground to find the maximum value of the field strength both horizontal polarization and vertical polarization of the antenna are set to make the measurement.
- e. For each suspected emission the EUT was arranged to its worst case and then tune the antenna tower (from 1 M to 4 M) and turn table (from 0 degree to 360 degrees) to find the maximum reading.
- f. Set the test-receiver system to Peak or CISPR quasi-peak Detect Function and specified bandwidth with Maximum Hold Mode.
- g. If the emission level of the EUT in peak mode was 3 dB lower than the limit specified, then testing will be stopped and peak values of EUT will be reported, otherwise, the emissions which do not have 3 dB margin will be repeated one by one using the quasi-peak method and reported.
- h. For testing above 1GHz, the emission level of the EUT in peak mode was 20dB lower than



average limit (that means the emission level in peak mode also complies with the limit in average mode), then testing will be stopped and peak values of EUT will be reported, otherwise, the emissions will be measured in average mode again and reported.

- i. "Cone of radiation" has been considered to be 3dB bandwidth of the measurement antenna.

6.3 Typical Test Setup

For radiated emissions frequency below 30MHz

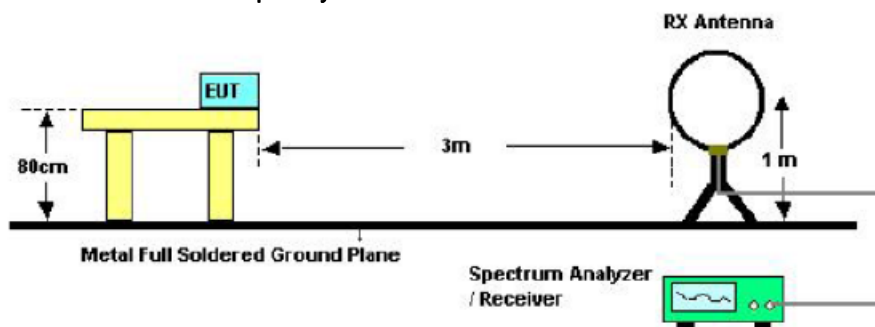

For radiated emissions frequency above 30MHz

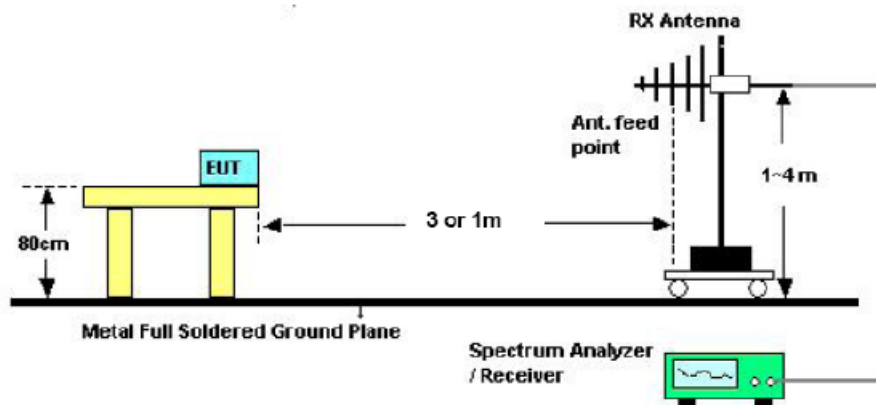

For radiated emissions frequency above 1GHz

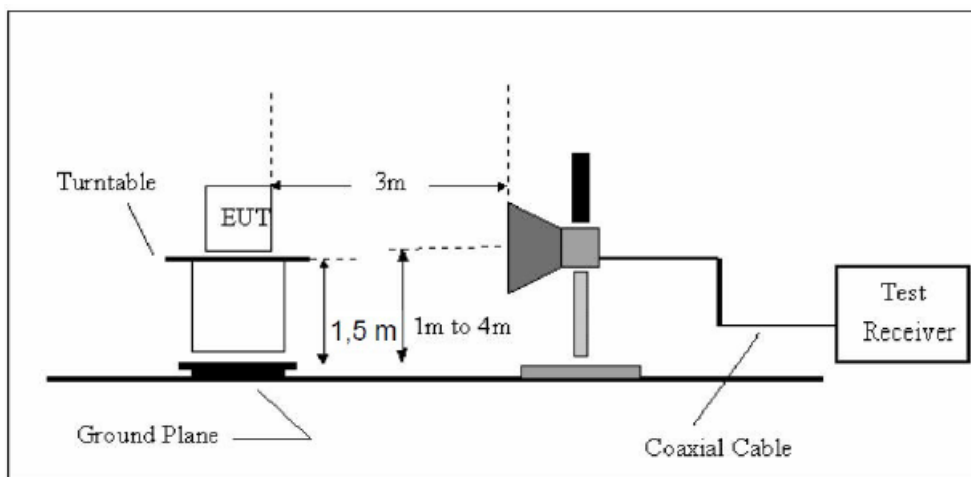

Note: For harmonic emissions test a appropriate high pass filter was inserted in the input port of AMP.



6.4 Test Result and Data (9kHz ~ 30MHz)

The 9kHz - 30MHz spurious emission is under limit 20dB more.

6.5 Test Result and Data (30MHz ~ 1GHz, worst emissions found)

Power	: DC 3 V	Pol/Phase	: HORIZONTAL
Test Mode	: TX CH19 (worst case)	Temperature	: 24 °C
Memo	:	Humidity	: 59%

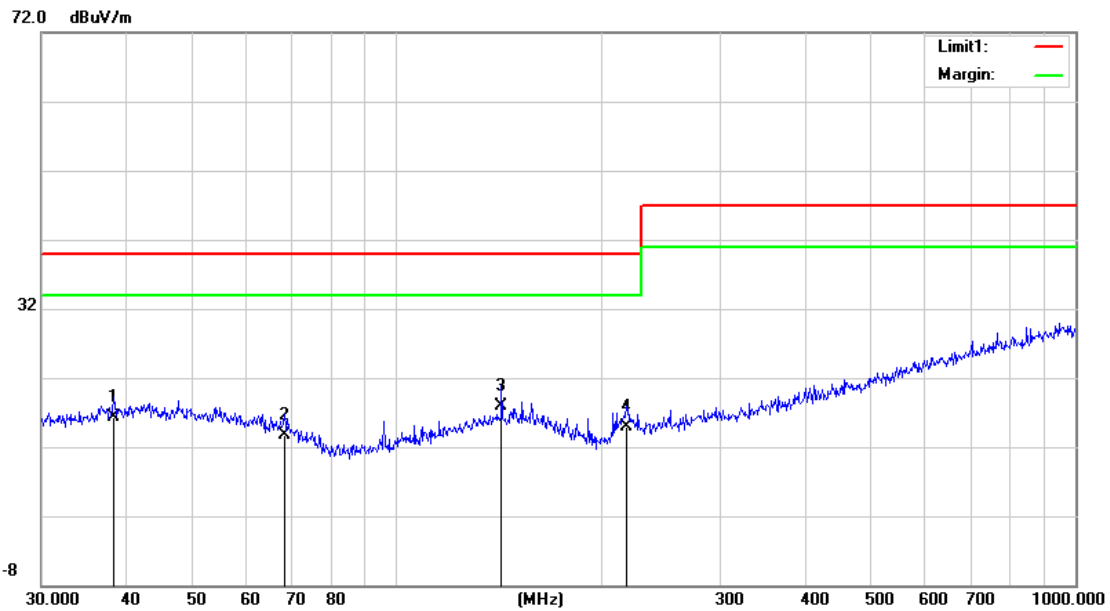

No.	Mk.	Freq. MHz	Reading Level dBuV	Correct Factor dB	Measure- ment dBuV/m	Limit dB/m	Over dB	Detector	Comment
1		38.3462	3.10	13.27	16.37	40.00	-23.63	QP	
2		68.3907	2.67	10.98	13.65	40.00	-26.35	QP	
3	*	142.8243	5.59	12.36	17.95	40.00	-22.05	QP	
4		218.3085	4.81	10.04	14.85	40.00	-25.15	QP	



Power	: DC 3 V	Pol/Phase	: VERTICAL
Test Mode	: TX CH19 (worst case)	Temperature	: 24 °C
Memo	:	Humidity	: 59%

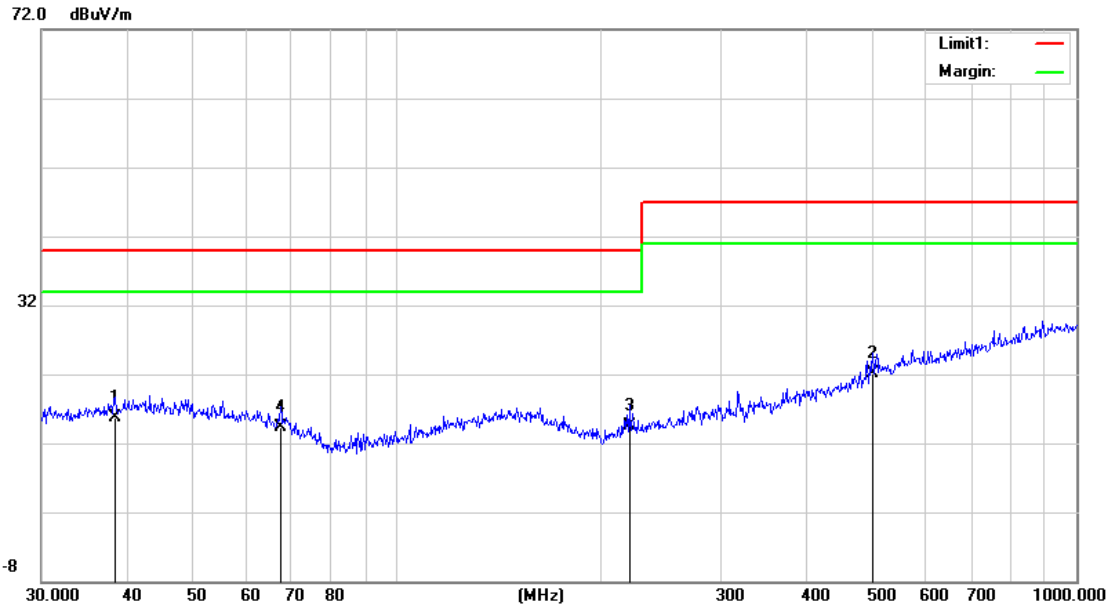

No.	Mk.	Freq. MHz	Reading Level dBuV	Correct Factor dB	Measure- ment dBuV/m	Limit dB/m	Over dB	Detector	Comment
1	*	38.4808	2.42	13.29	15.71	40.00	-24.29	QP	
2		501.1789	4.73	17.33	22.06	47.00	-24.94	QP	
3		219.8448	4.50	10.09	14.59	40.00	-25.41	QP	
4		67.4381	3.23	11.08	14.31	40.00	-25.69	QP	



6.1 Test Result and Data (Above 1GHz)

Power	: DC 3 V	Pol/Phase	: H/V
Test Mode	: TX CH00 GFSK	Temperature	: 24 °C
Memo	:	Humidity	: 59 %

(a) Antenna polarization: Horizontal

Frequency (MHz)	Reading Level (dBuV)	Correct Factor (dB)	Measure Level (dBuV/m)	Limit (dBuV/m)	Over (dB)	Detector Type
4804.00	61.98	-6.14	55.84	74.00	-18.16	peak
4804.00	46.63	-6.14	40.49	54.00	-13.51	AVG
7206.00	54.98	0.16	55.14	74.00	-18.86	peak
7206.00	41.15	0.16	41.31	54.00	-12.69	AVG

(b) Antenna polarization: Vertical

Frequency (MHz)	Reading Level (dBuV)	Correct Factor (dB)	Measure Level (dBuV/m)	Limit (dBuV/m)	Over (dB)	Detector Type
4804.00	61.98	-6.14	55.84	74.00	-18.16	peak
4804.00	46.63	-6.14	40.49	54.00	-13.51	AVG
7206.00	50.98	0.16	51.14	74.00	-22.86	peak
7206.00	34.15	0.16	34.31	54.00	-19.69	AVG



Power	: DC 3 V	Pol/Phase	: H/V
Test Mode	: TX CH19 GFSK	Temperature	: 24 °C
Memo	:	Humidity	: 59 %

(a) Antenna polarization: Horizontal

Frequency (MHz)	Reading Level (dBuV)	Correct Factor (dB)	Measure Level (dBuV/m)	Limit (dBuV/m)	Over (dB)	Detector Type
4880.00	66.17	-5.91	60.26	74.00	-13.74	peak
4880.00	49.67	-5.91	43.76	54.00	-10.24	AVG
7320.00	50.29	0.54	50.83	74.00	-23.17	peak
7320.00	34.99	0.54	35.53	54.00	-18.47	AVG

(b) Antenna polarization: Vertical

Frequency (MHz)	Reading Level (dBuV)	Correct Factor (dB)	Measure Level (dBuV/m)	Limit (dBuV/m)	Over (dB)	Detector Type
4880.00	63.57	-5.91	57.66	74.00	-16.34	peak
4880.00	46.81	-5.91	40.90	54.00	-13.10	AVG
7320.00	47.87	0.54	48.41	74.00	-25.59	peak
7320.00	34.82	0.54	35.36	54.00	-18.64	AVG



Power	: DC 3 V	Pol/Phase	: H/V
Test Mode	: TX CH39 GFSK	Temperature	: 24 °C
Memo	:	Humidity	: 59 %

(a) Antenna polarization: Horizontal

Frequency (MHz)	Reading Level (dBuV)	Correct Factor (dB)	Measure Level (dBuV/m)	Limit (dBuV/m)	Over (dB)	Detector Type
4960.00	61.18	-5.67	55.51	74.00	-18.49	peak
4960.00	51.38	-5.67	45.71	54.00	-8.29	AVG
7440.00	53.09	0.82	53.91	74.00	-20.09	peak
7440.00	37.19	0.82	38.01	54.00	-15.99	AVG

(b) Antenna polarization: Vertical

Frequency (MHz)	Reading Level (dBuV)	Correct Factor (dB)	Measure Level (dBuV/m)	Limit (dBuV/m)	Over (dB)	Detector Type
4960.00	58.69	-5.67	53.02	74.00	-20.98	peak
4960.00	44.45	-5.67	38.78	54.00	-15.22	AVG
7440.00	50.33	0.82	51.15	74.00	-22.85	peak
7440.00	39.62	0.82	40.44	54.00	-13.56	AVG



7. 6dB Bandwidth Measurement Data

7.1 Test Limit

The minimum of 6dB Bandwidth Measurement is 0.5 MHz.

7.2 Test Procedures

- a. The transmitter output was connected to the spectrum analyzer.
- b. Set RBW of spectrum analyzer to 1~5% of the emission bandwidth and $VBW \geq 3x RBW$.
- c. The 6 dB bandwidth is defined as the total spectrum the power of which is higher than peak power minus 6 dB.
- d. The 6dB Bandwidth was measured and recorded.

7.3 Test Setup Layout

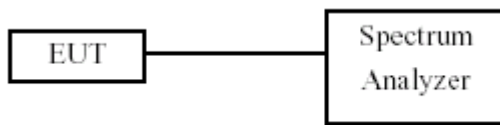



7.4 Test Result and Data

Test Date: Nov. 8, 2017

Temperature: 24°C

Atmospheric pressure: 1000 hPa

Humidity: 55%

Modulation Standard	Channel	Frequency (MHz)	6dB Bandwidth (KHz)
GFSK	0	2402	544.0
	19	2440	656.0
	39	2480	592.0

Modulation Standard: GFSK

Channel: 0

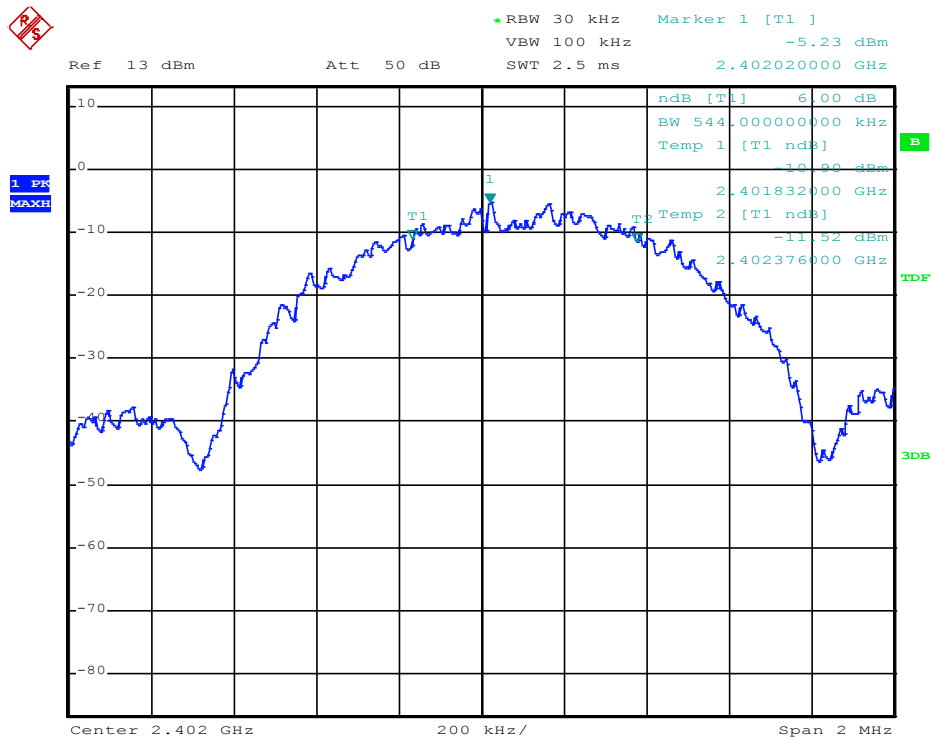



Channel: 19



*RBW 30 kHz Marker 1 [T1]
VBW 100 kHz -4.62 dBm
SWT 2.5 ms 2.440112000 GHz

Ref 13 dBm Att 50 dB

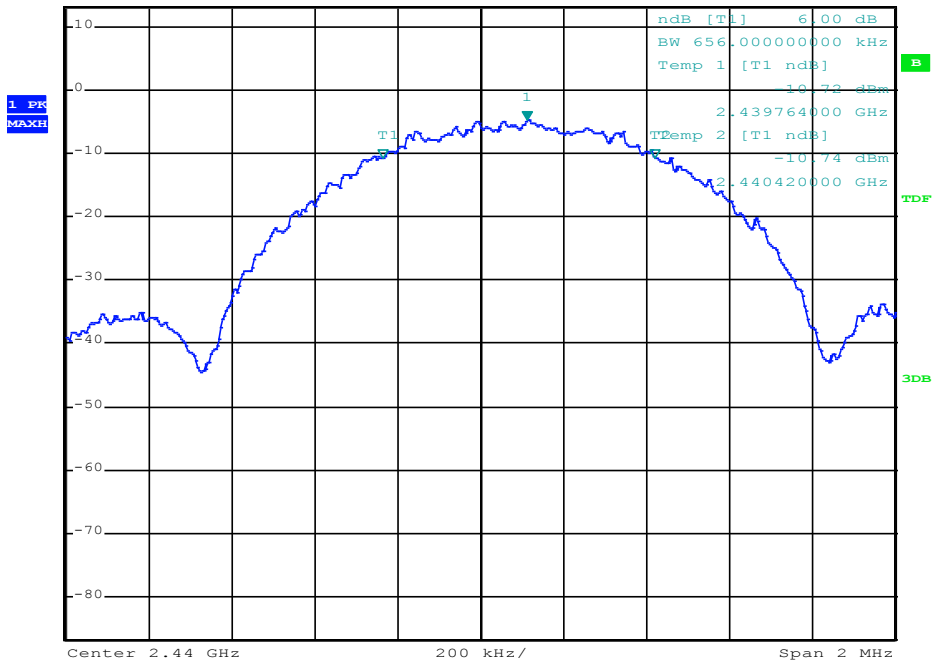

Channel: 39



*RBW 30 kHz Marker 1 [T1]
VBW 100 kHz -5.31 dBm
SWT 2.5 ms 2.480100000 GHz

Ref 13 dBm Att 50 dB

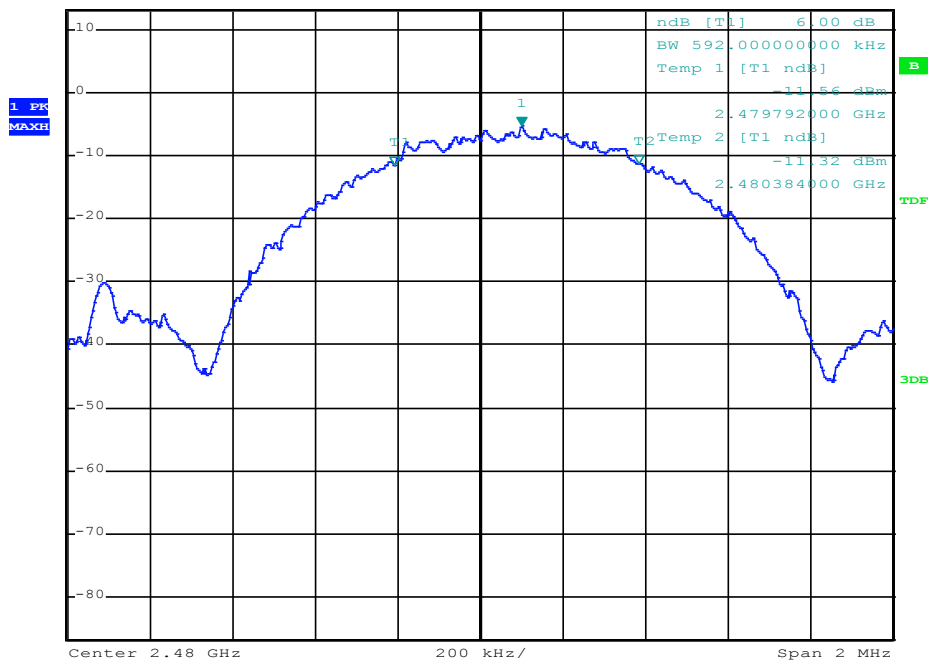



8. Maximum Peak Output Power

8.1 Test Limit

(b)(3) For systems using digital modulation in the 902-928 MHz, 2400-2483.5 MHz, and 5725-5850 MHz bands: 1 Watt.

8.2 Test Procedures

- a. Peak power is measured using the wideband power meter.
- b. Power is integrated over a bandwidth greater than or equal to the 99% bandwidth.
- c. The Peak Output Power was measured and recorded.

8.3 Test Setup Layout





8.4 Test Result and Data

Test Date: Nov. 08, 2017

Temperature: 24°C

Atmospheric pressure: 1000hPa

Humidity: 55%

Modulation Standard	Channel	Frequency (MHz)	Peak Power Output (dBm)	Peak Power Output (mW)
GFSK	0	2402	-0.85	0.82
	19	2440	-0.24	0.95
	39	2480	0.16	1.04



9. Power Spectral Density

9.1 Test Limit

The Maximum of Power Spectral Density Measurement is 8dBm

9.2 Test Procedures

- a. The transmitter output was connected to spectrum analyzer.
- b. The spectrum analyzer's resolution bandwidth were set at 3KHz RBW and 30KHz VBW as that of the fundamental frequency. Set the sweep time=auto couple.
- c. The power spectral density was measured and recorded.

9.3 Test Setup Layout

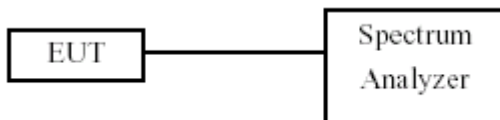



9.4 Test Result and Data

Test Date: Nov. 08, 2017

Temperature: 24°C

Atmospheric pressure: 1000 hPa

Humidity: 55%

Modulation Standard	Channel	Frequency (MHz)	Measured Power Density (dBm)
GFSK	0	2402	-22.10
	19	2440	-19.98
	39	2480	-19.88

Modulation Standard: GFSK
Channel: 0

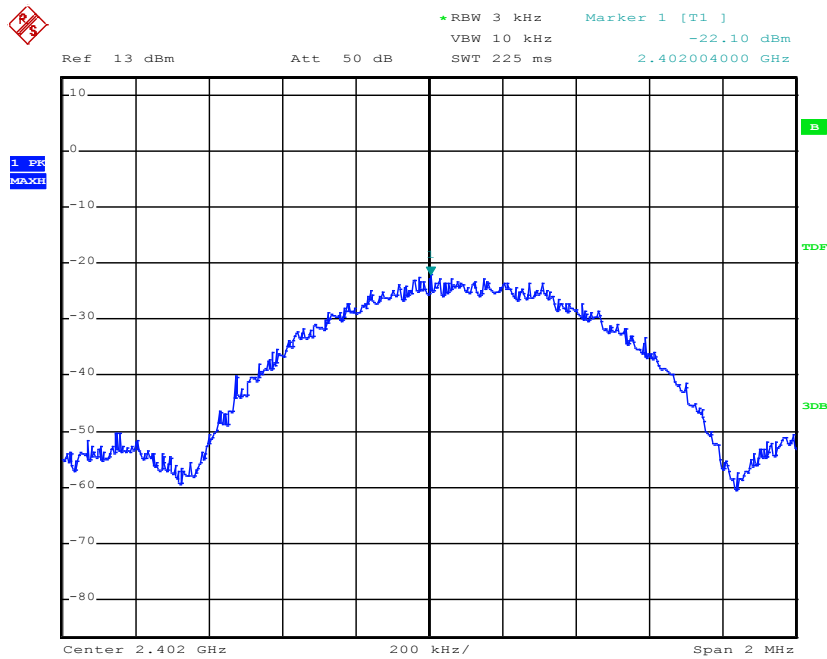



Channel: 19

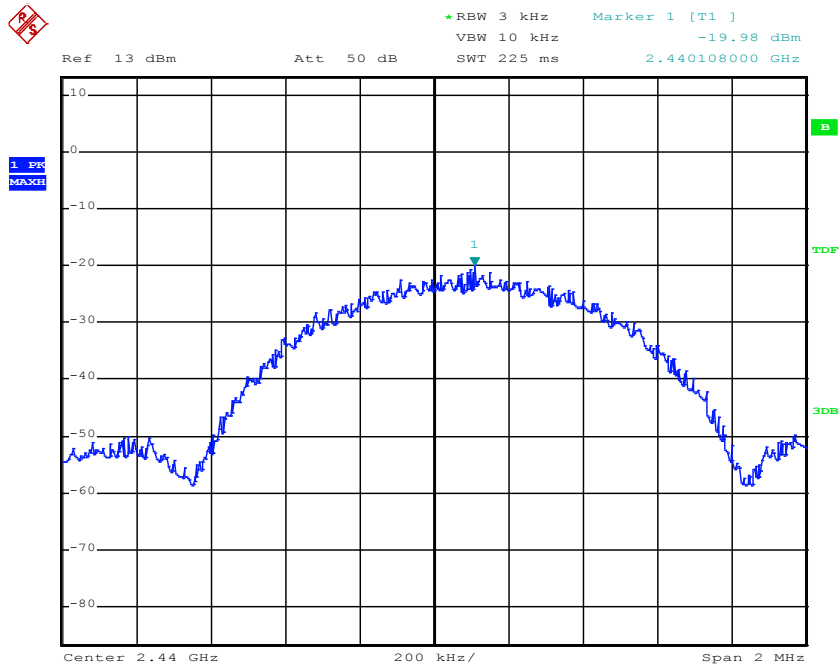

Channel: 39

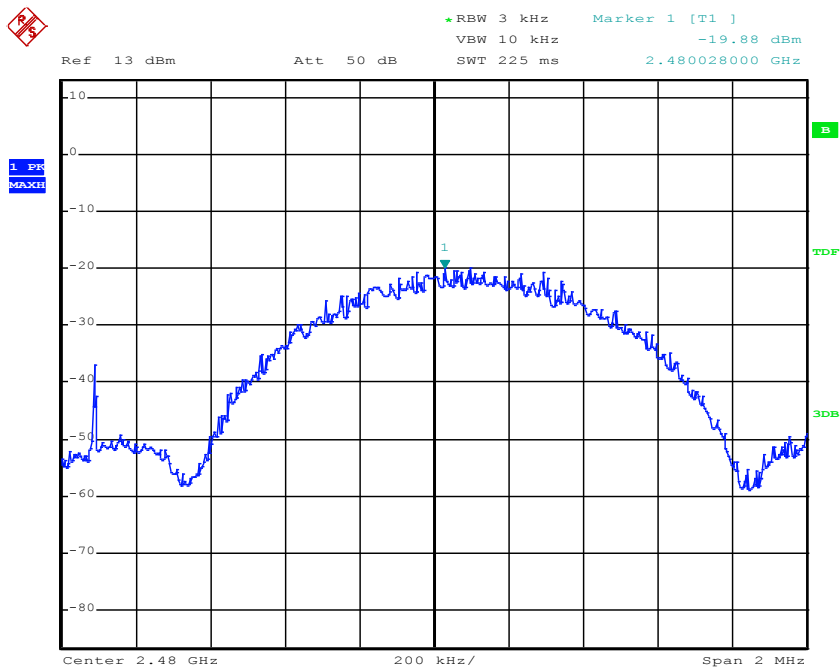



10. Band Edges Measurement

10.1 Test Limit

Below -20dB of the highest emission level of operating band (In 100 kHz Resolution Bandwidth)

10.2 Test Procedure

- a. The transmitter output was connected to the spectrum analyzer via a low lose cable.
- b. Set RBW of spectrum analyzer to 100 KHz and VBW of spectrum analyzer to 300 KHz with convenient frequency span including 100 KHz bandwidth from band edge.
- c. Peak conducted output power measured within any 100 kHz outside the authorized frequency band shall be attenuated by at least 20dB relative to the maximum measured in-band peak PSD level.
- d. The band edges was measured and recorded.

10.3 Test Setup Layout

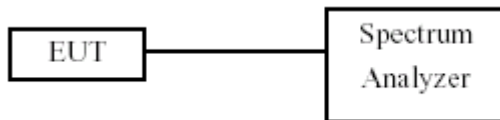



10.4 Test Result and Data

Test Date: Nov. 08, 2017

Temperature: 24°C

Atmospheric pressure: 1000hPa

Humidity: 55%

Modulation Standard	Channel	Frequency (MHz)	maximum value in frequency (MHz)	maximum value (dBm)
GFSK	0	2402	2399.58	-37.38
	39	2480	2483.58	-43.98



Modulation Standard: GFSK

Channel: 00

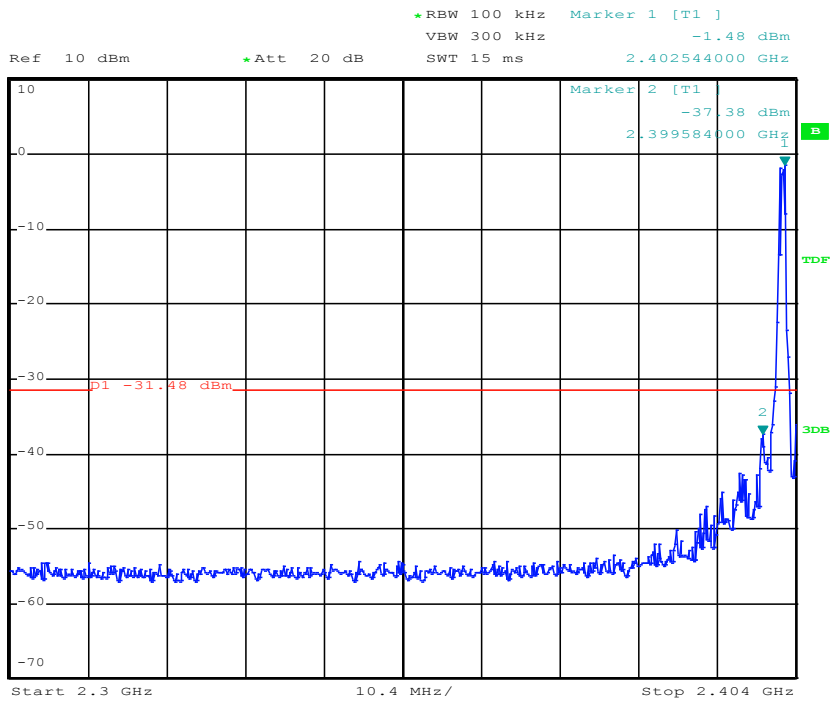

Channel: 39

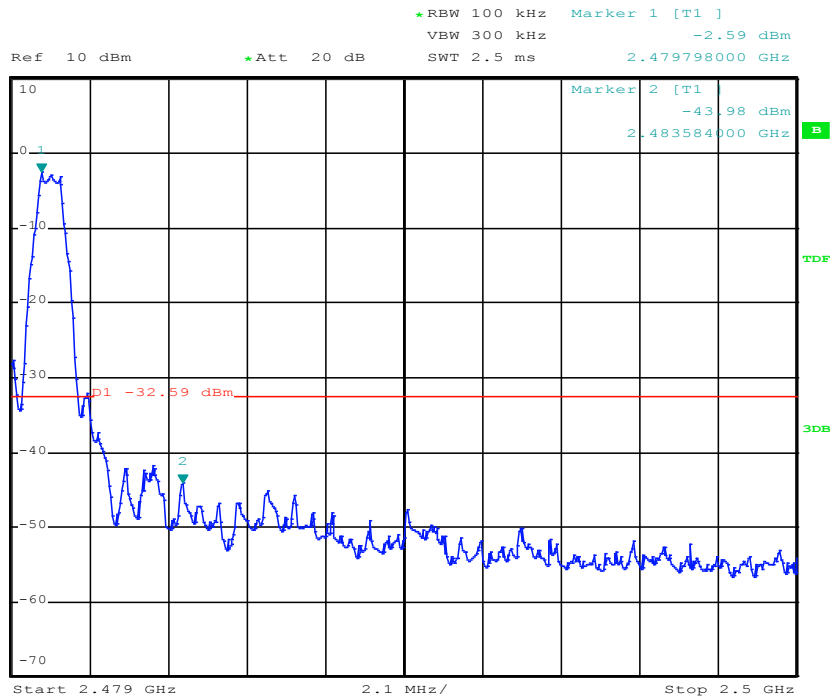



10.5 Restrict Band Emission Measurement Data

Power	: DC 3 V	Pol/Phase	: H/V
Test Mode	: GFSK	Temperature	: 24 °C
Test Date	: Nov. 09, 2017	Humidity	: 59 %

Channel 0						Fundamental Frequency: 2402 MHz				
Frequency (MHz)	Ant-Pol H/V	Meter Reading (dBuV)	Corrected Factor (dB)	Result (dBuV/m)	Remark	Limit (dBuV/m)		Margin (dB)	Table Deg.	Ant High (m)
						Peak	Ave			
2390.00	H	68.73	-14.08	54.65	Peak	74.00	--	-19.35	336	1.5
2390.00	H	52.08	-14.08	38.00	Ave	--	54.00	-16.00	336	1.5
2332.83	V	61.51	-14.05	47.46	Peak	74.00	--	-26.54	0	1.5
2332.83	V	53.22	-14.05	39.17	Ave	--	54.00	-14.83	0	1.5

Channel 39						Fundamental Frequency: 2480 MHz				
Frequency (MHz)	Ant-Pol H/V	Meter Reading (dBuV)	Corrected Factor (dB)	Result (dBuV/m)	Remark	Limit (dBuV/m)		Margin (dB)	Table Deg.	Ant High (m)
						Peak	Ave			
2483.50	H	63.03	-13.79	49.24	Peak	74.00	--	-24.76	7	1.5
2483.50	H	57.41	-13.79	43.62	Ave	--	54.00	-10.38	7	1.5
2493.95	V	61.56	-13.83	47.73	Peak	74.00	--	-26.27	0	1.5
2493.95	V	46.82	-13.83	32.99	Ave	--	54.00	-21.01	0	1.5



Note:

1. Emission level = Reading level + Correction factor
2. Correction factor : Antenna factor, Cable loss, Pre-Amp, etc.
3. All emissions as described above were determining by rotating the EUT through three orthogonal axes to maximizing the emissions if the EUT belongs to hand-held or body-worn devices.
4. Measurements above 1000 MHz, Peak detector setting:
1 MHz RBW with 1 MHz VBW (Peak Detector).
5. Measurements above 1000 MHz, Average detector setting:
1 MHz RBW with 10Hz VBW (RMS Detector).
6. Peak detector measurement data will represent the worst case results.
7. Where limits are specified for both average and peak detector functions, if the peak measured value complies with the average limit, it is unnecessary to perform an average measurement.



11. Restricted Bands of Operation

Only spurious emissions are permitted in any of the frequency bands listed below:

MHz	MHz	MHz	GHz
0.09000 – 0.11000	16.42000 – 16.42300	399.9 – 410.0	4.500 – 5.150
0.49500 – 0.505**	16.69475 – 16.69525	608.0 – 614.0	5.350 – 5.460
2.17350 – 2.19050	16.80425 – 16.80475	960.0 – 1240.0	7.250 – 7.750
4.12500 – 4.12800	25.50000 – 25.67000	1300.0 – 1427.0	8.025 – 8.500
4.17725 – 4.17775	37.50000 – 38.25000	1435.0 – 1626.5	9.000 – 9.200
4.20725 – 4.20775	73.00000 – 74.60000	1645.5 – 1646.5	9.300 – 9.500
6.21500 – 6.21800	74.80000 – 75.20000	1660.0 – 1710.0	10.600 – 12.700
6.26775 – 6.26825	108.00000 – 121.94000	1718.8 – 1722.2	13.250 – 13.400
6.31175 – 6.31225	123.00000 – 138.00000	2200.0 – 2300.0	14.470 – 14.500
8.29100 – 8.29400	149.90000 – 150.05000	2310.0 – 2390.0	15.350 – 16.200
8.36200 – 8.36600	156.52475 – 156.52525	2483.5 – 2500.0	17.700 – 21.400
8.37625 – 8.38675	156.70000 – 156.90000	2655.0 – 2900.0	22.010 – 23.120
8.41425 – 8.41475	162.01250 – 167.17000	3260.0 – 3267.0	23.600 – 24.000
12.29000 – 12.29300	167.72000 – 173.20000	3332.0 – 3339.0	31.200 – 31.800
12.51975 – 12.52025	240.00000 – 285.00000	3345.8 – 3358.0	36.430 – 36.500
12.57675 – 12.57725	322.00000 – 335.40000	3600.0 – 4400.0	Above 38.6
13.36000 – 13.41000			

** : Until February 1, 1999, this restricted band shall be 0.490-0.510 MHz

11.1 Labeling Requirement

The device shall bear the following statement in a conspicuous location on the device:

This device complies with part 15 of the FCC Rules. Operation is subject to the following two conditions: (1) This device may not cause harmful interference, and (2) this device must accept any interference received, including interference that may cause undesired operation.



12. Conducted Spurious Emission

Test Requirement: FCC Part 15 C section 15.247

(d) In any 100 kHz bandwidth outside the frequency band in which the spread spectrum or digitally modulated intentional radiator is operating, the radio frequency power that is produced by the intentional radiator shall be at least 20 dB below that in the 100 kHz bandwidth within the band that contains the highest level of the desired power. Based on either an RF conducted or a radiated measurement. Provided the transmitter demonstrates compliance with the peak conducted power limits.

Test Method: ANSI C63.10: Clause 6.7

Test Status: Pre-Scan has been conducted to determine the worst-case mode from all possible combinations between available modulations, data rates and antenna ports (if EUT with antenna diversity architecture). Following channel(s) was (were) selected for the final test as listed below.

Test Configuration:

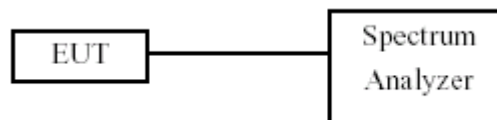

Test Procedure:

1. Remove the antenna from the EUT and then connect a low RF cable from the antenna port to the spectrum analyzer or power meter.
2. Set the spectrum analyzer: RBW=100 KHz, VBW = 300KHz. Sweep = auto; Detector Function = Peak. Trace = Max Hold, Scan up through 10th harmonic.
3. Measure the Conducted Spurious Emissions of the test frequency with special test status.
4. Repeat until all the test status is investigated.
5. Report the worse case.



Channel 00: 2.402GHz:

30 MHz to 1 GHz

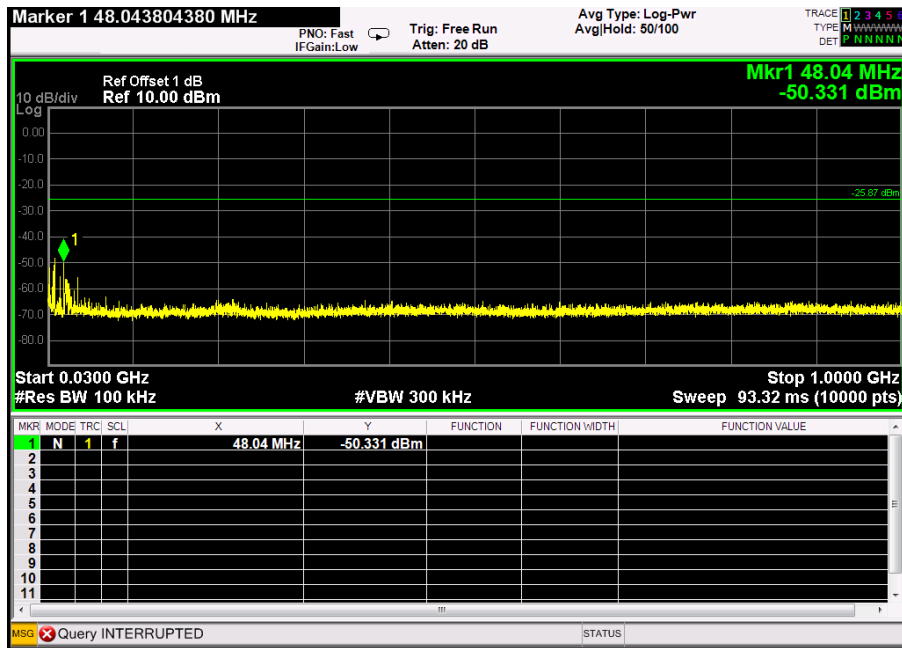

1 GHz to 26 GHz

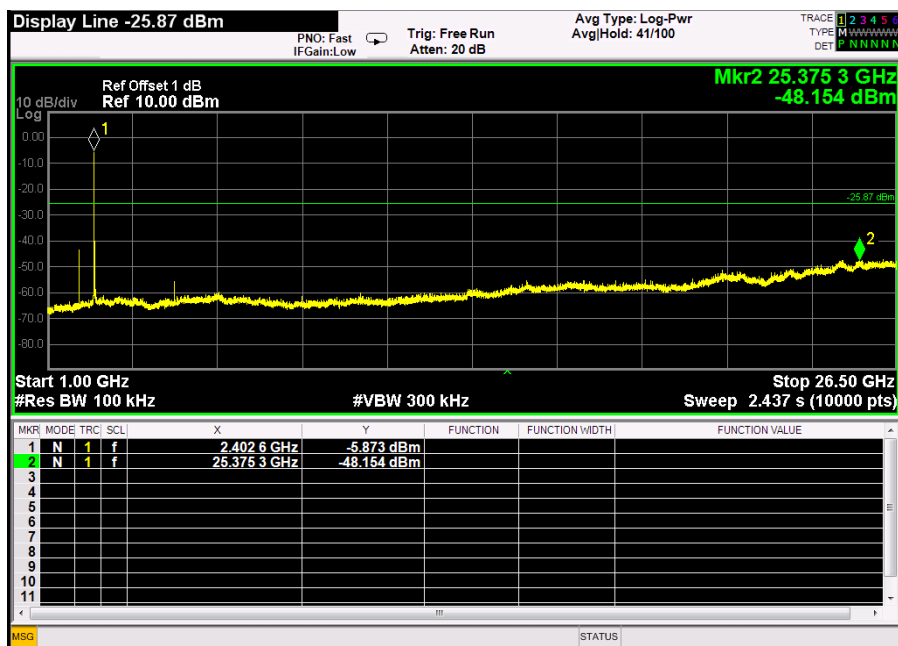



Channel 19: 2.440GHz:

30 MHz to 1 GHz

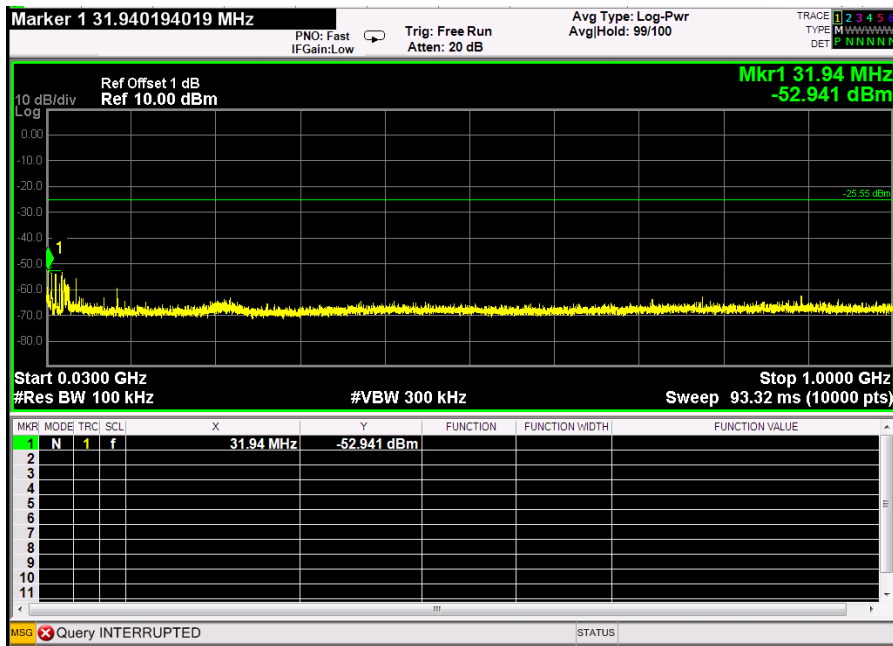

1 GHz to 26 GHz

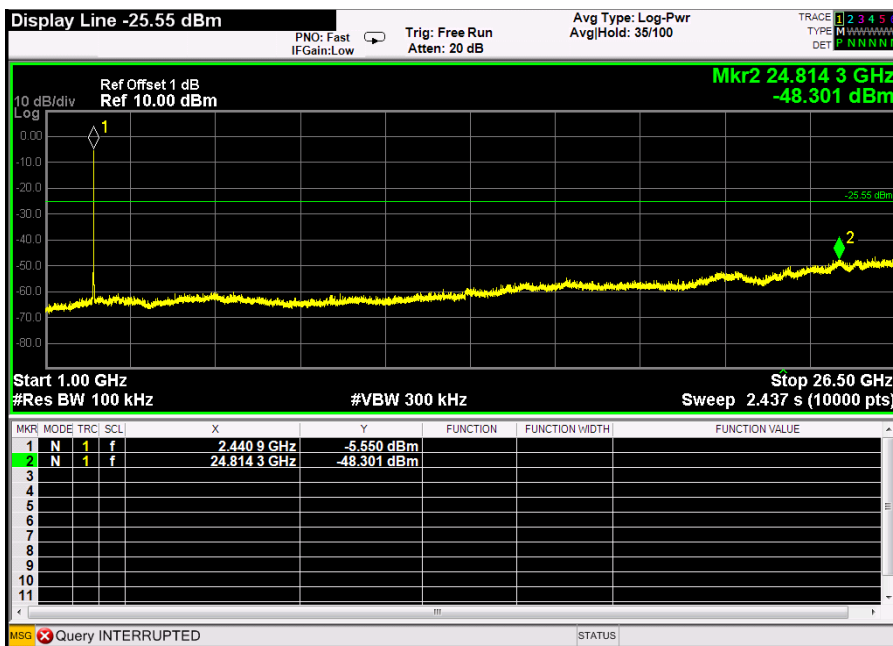



Channel 39:2.480 GHz

30 MHz to 1 GHz

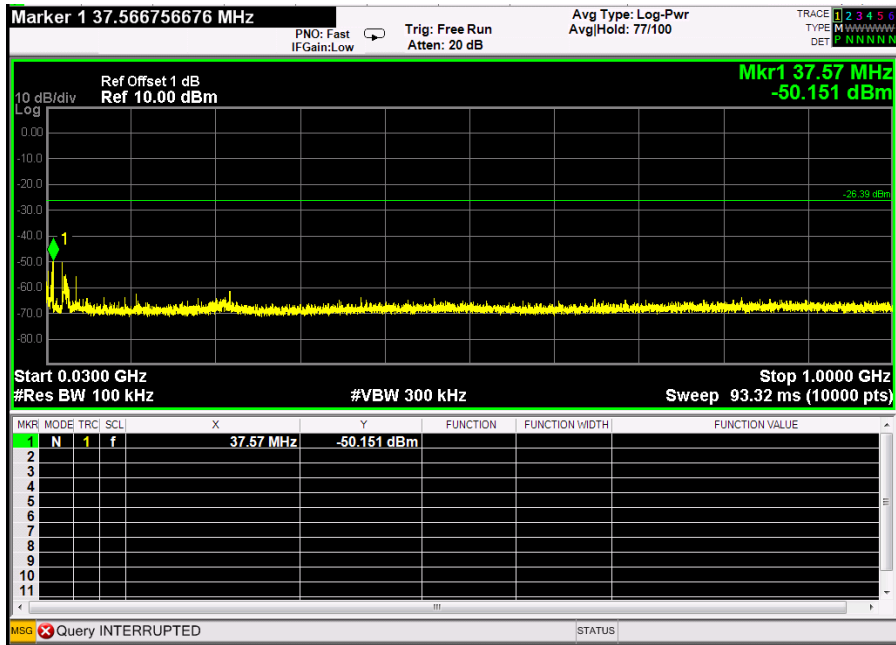

1 GHz to 26 GHz

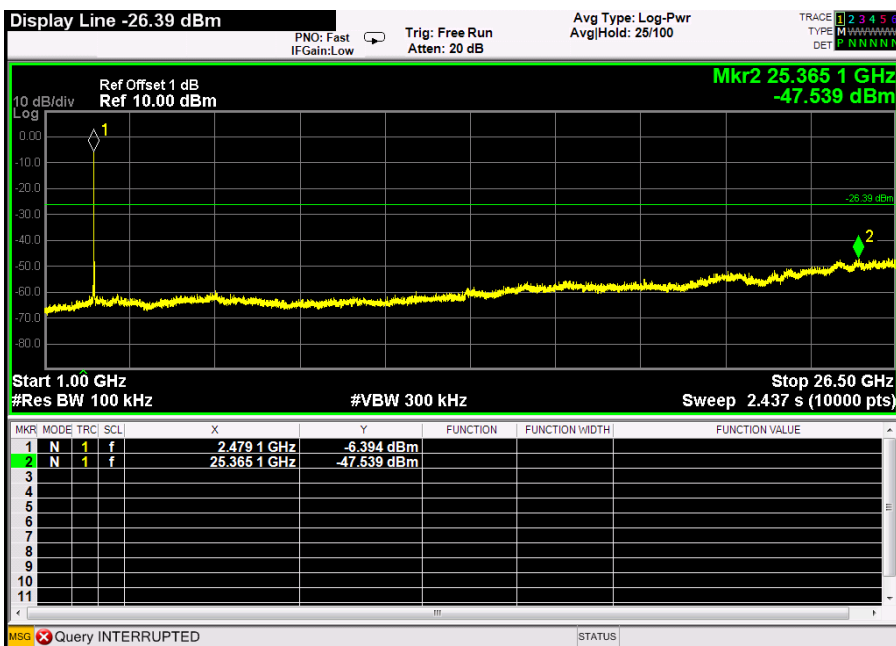



APPENDIX 1
PHOTOS OF TEST CONFIGURATION

Below 1GHz:

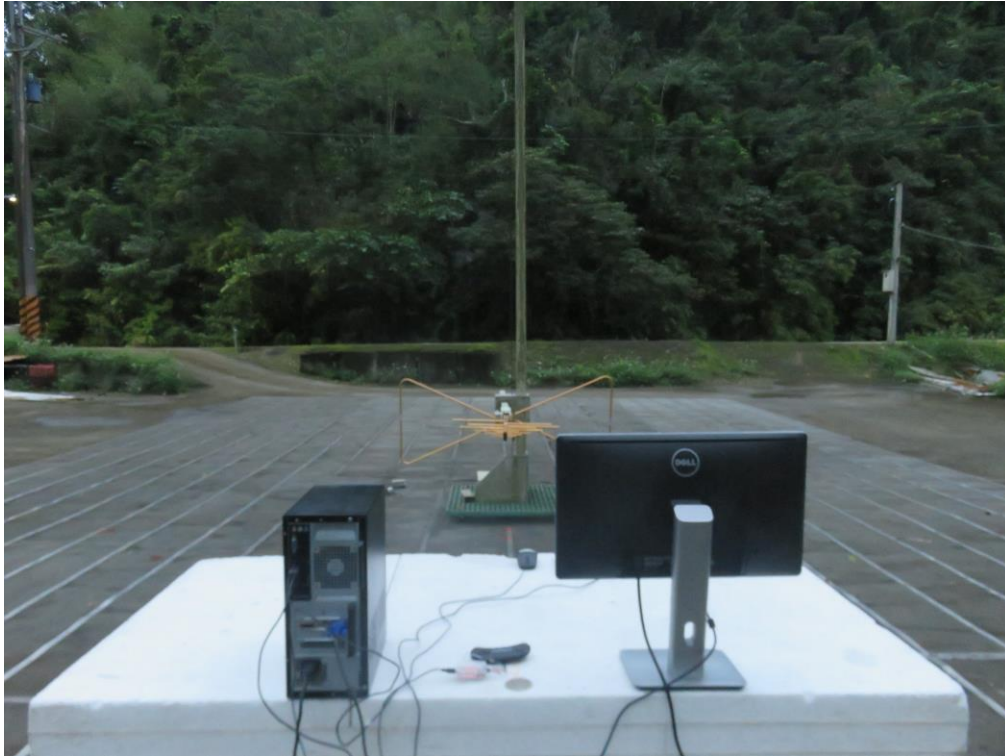

Above 1GHz:





PHOTOS OF EUT



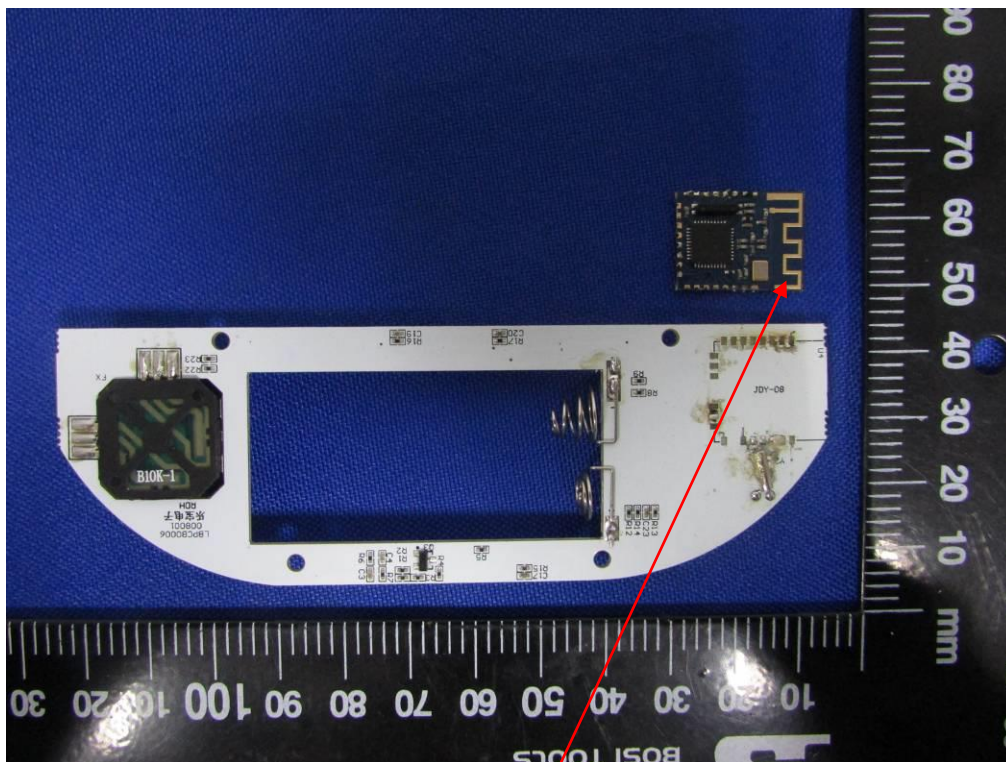
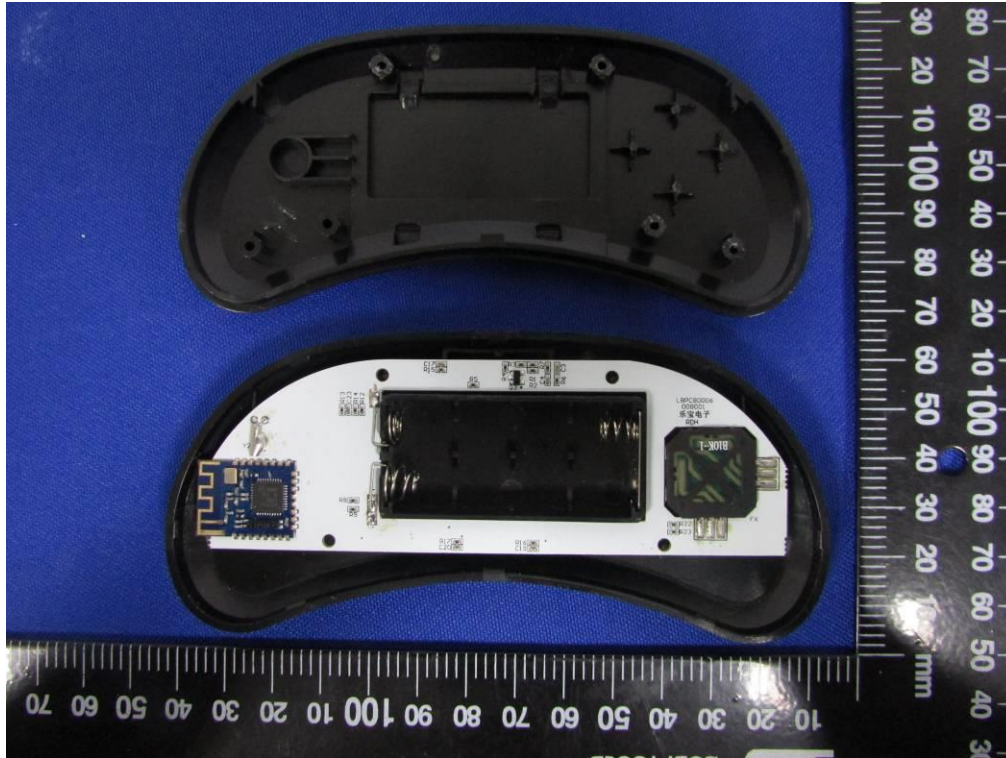

BT Antenna

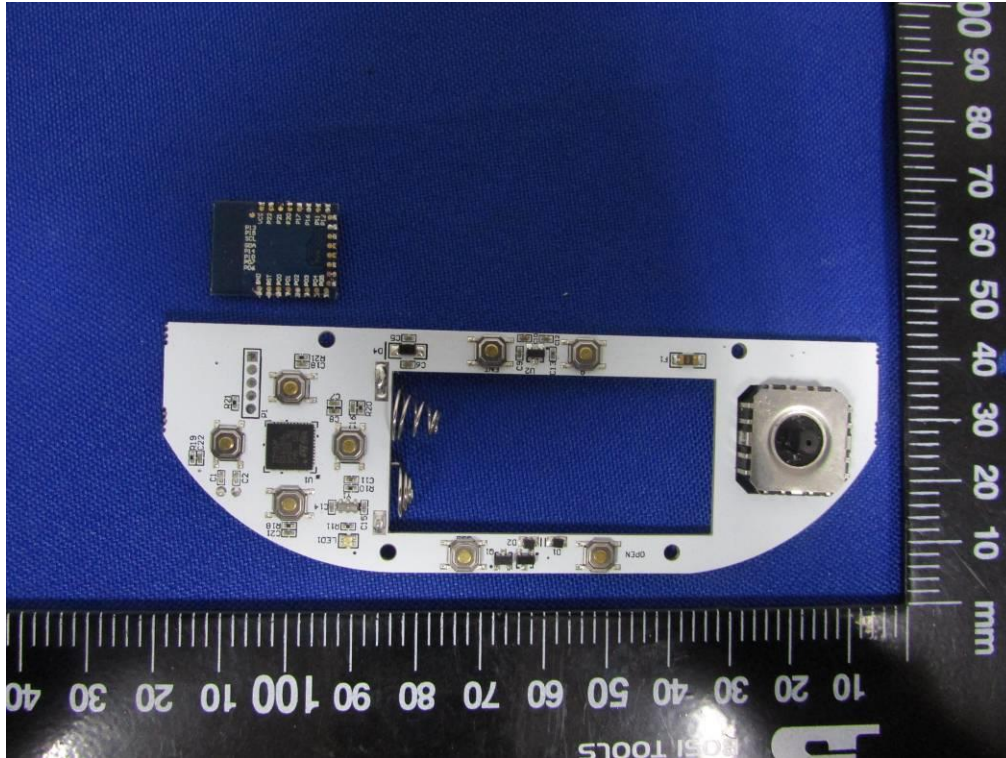

**** End of report ****