



No. 1 Workshop, M-10, Middle section, Science & Technology Park,
Shenzhen, Guangdong, China 518057

Telephone: +86 (0) 755 2601 2053
Fax: +86 (0) 755 2671 0594
Email: ee.shenzhen@sgs.com

Report No.: SZEM180200104302
Page: 1 of 43

1 Cover Page

RF TEST REPORT

| | |
|---|-------------------------------------|
| Application No.: | SZEM1802001043CR (SHEM1711007818CR) |
| Applicant: | Digital Peripheral Solutions Inc |
| FCC ID: | 2ANQL-QCW3MP1D |
| Equipment Under Test (EUT): | |
| NOTE: The following sample(s) was/were submitted and identified by the client as | |
| Product Name: | Wi-Fi SECURITY DOME CAMERA |
| Model No.(EUT): | QCW3MP1D |
| Standards: | 47 CFR Part 15, Subpart C |
| Date of Receipt: | 2018-01-29 |
| Date of Test: | 2018-01-30 |
| Date of Issue: | 2018-02-28 |
| Test Result: | Pass* |

*In the configuration tested, the EUT detailed in this report complied with the standards specified above.





The manufacturer should ensure that all products in series production are in conformity with the product sample detailed in this report. If the product in this report is used in any configuration other than that detailed in the report, the manufacturer must ensure the new system complies with all relevant standards. Any mention of SGS International Electrical Approvals or testing done by SGS International Electrical Approvals in connection with, distribution or use of the product described in this report must be approved by SGS International Electrical Approvals in writing.

This document is issued by the Company subject to its General Conditions of Service printed overleaf, available on request or accessible at <http://www.sgs.com/en/Terms-and-Conditions.aspx> and, for electronic format documents, subject to Terms and Conditions for Electronic Documents at <http://www.sgs.com/en/Terms-and-Conditions/Terms-e-Document.aspx>. Attention is drawn to the limitation of liability, indemnification and jurisdiction issues defined therein. Any holder of this document is advised that information contained hereon reflects the Company's findings at the time of its intervention only and within the limits of Client's instructions, if any. The Company's sole responsibility is to its Client and this document does not exonerate parties to a transaction from exercising all their rights and obligations under the transaction documents. This document cannot be reproduced except in full, without prior written approval of the Company. Any unauthorized alteration, forgery or falsification of the content or appearance of this document is unlawful and offenders may be prosecuted to the fullest extent of the law. Unless otherwise stated the results shown in this test report refer only to the sample(s) tested and such sample(s) are retained for 30 days only



| Revision Record | | | | |
|------------------------|----------------|-------------|-----------------|---------------|
| Version | Chapter | Date | Modifier | Remark |
| 00 | / | 2018-02-28 | / | Original |
| | | | | |
| | | | | |

| | | | | |
|---------------------------------|--|---|--|--|
| Authorized for issue by: | | | | |
| | |  <hr/> Foray Chen /Project Engineer | | |
| | |  <hr/> Eric Fu /Reviewer | | |

2 Test Summary

| Test Item | FCC Requirement | Test method | Result |
|--|--|--|--------|
| Antenna Requirement | FCC Part 15, Subpart C Section 15.203/15.247 (c) | --- | PASS |
| AC Power Line Conducted Emission | FCC Part 15, Subpart C Section 15.207 | ANSI C63.10 (2013) Section 6.2 | PASS |
| Minimum 6dB Bandwidth | FCC Part 15, Subpart C Section 15.247 (a)(2) | ANSI C63.10 (2013) Section 11.8.1 | PASS |
| Conducted (average) Output Power | FCC Part 15, Subpart C Section 15.247 (b)(3)(4) | ANSI C63.10 (2013) Section 11.9.2.2 | PASS |
| Power Spectrum Density | FCC Part 15, Subpart C Section 15.247 (e) | ANSI C63.10 (2013) Section 11.10.3 | PASS |
| RF Conducted Spurious Emissions and Band-edge | FCC Part 15, Subpart C Section 15.247(d) | ANSI C63.10 (2013) Section 11.11&11.13.3.3 | PASS |
| Radiated Spurious Emissions and Band-edge | FCC Part 15, Subpart C Section 15.205&15.209&15.247(d) | ANSI C63.10 (2013) Section 6.4&6.5&6.6&6.10 | PASS |



3 Contents

| | Page |
|--|-----------|
| 1 COVER PAGE | 1 |
| 2 TEST SUMMARY | 3 |
| 3 CONTENTS..... | 4 |
| 4 GENERAL INFORMATION | 5 |
| 4.1 CLIENT INFORMATION..... | 5 |
| 4.2 GENERAL DESCRIPTION OF E.U.T. | 5 |
| 4.3 TECHNICAL SPECIFICATIONS..... | 5 |
| 4.4 TEST MODE..... | 5 |
| 4.5 TEST CHANNEL | 6 |
| 4.6 DESCRIPTION OF SUPPORT UNITS..... | 6 |
| 4.7 TEST LOCATION | 6 |
| 4.8 TEST FACILITY | 7 |
| 4.9 MEASUREMENT UNCERTAINTY | 7 |
| 5 EQUIPMENTS USED DURING TEST | 8 |
| 6 TEST RESULTS | 9 |
| 6.1 E.U.T. TEST CONDITIONS | 9 |
| 6.2 ANTENNA REQUIREMENT..... | 10 |
| 6.3 CONDUCTED EMISSIONS ON MAINS TERMINALS | 11 |
| 6.4 6dB OCCUPIED BANDWIDTH..... | 15 |
| 6.5 CONDUCTED AVERAGE OUTPUT POWER | 16 |
| 6.6 AVERAGE POWER SPECTRAL DENSITY..... | 17 |
| 6.7 CONDUCTED SPURIOUS EMISSIONS AND BAND-EDGE | 18 |
| 6.7.1 <i>Conducted spurious emission</i> | 18 |
| 6.7.2 <i>Conducted Band-edge</i> | 18 |
| 6.8 RADIATED SPURIOUS EMISSIONS AND BAND-EDGE..... | 19 |
| 6.8.1 <i>Radiated Spurious Emissions</i> | 22 |
| 6.8.2 <i>Radiated Band edge</i> | 28 |
| 7 TEST SETUP PHOTOGRAPHS..... | 43 |
| 8 EUT CONSTRUCTIONAL DETAILS..... | 43 |



4 General Information

4.1 Client Information

| | |
|--------------------------|---|
| Applicant: | Digital Peripheral Solutions Inc |
| Address of Applicant: | 8015 E Crystal Drive , Anaheim,CA 92807 |
| Manufacturer: | Digital Peripheral Solutions Inc |
| Address of Manufacturer: | 8015 E Crystal Drive , Anaheim,CA 92807 |
| Factory: | 1, ZHEJIANG DAHUA VISION TECHNOLOGY CO., LTD. 2, ZHEJIANG DAHUA ZHILIAN CO.,LTD. |
| Address of Factory: | 1, No.1199, Bin'an Road, Binjiang District, Hangzhou, P.R. China 2, No.28, Dongqiao Road, Dongzhou Street, Fuyang District, Hangzhou, P.R.China. |

4.2 General Description of E.U.T.

| | |
|----------------------|---------------------------------------|
| Product Description: | Fixed product with 2.4G WiFi function |
| Rated Input: | DC 12V by Adapter |
| Test Voltage: | AC 120V 60Hz for adapter |

4.3 Technical Specifications

| | |
|-----------------------|--|
| Operation Frequency: | 802.11 b/g/n(HT20): 2412MHz-2462MHz 802.11 (HT40): 2422MHz-2452MHz |
| Modulation Technique: | 802.11 b DSSS(CCK, DQPSK, DBPSK) 802.11 g/n(OFDM(64QAM, 16QAM, QPSK, BPSK) |
| Number of Channel: | 802.11 b/g/n(HT20): 11, 802.11 (HT40):7 |
| Data Rate: | 802.11b: 1/2/5.5/11Mbps, 802.11g: 6/9/12/18/24/36/48/54Mbps 802.11n: MCS0~MCS7 |
| Antenna Type: | Dipole Antenna |
| Antenna Gain: | 2.0 dBi |

4.4 Test Mode

| Test Mode | Description of Test Mode |
|------------------|---|
| Engineering mode | Using test software to control EUT working in continuous transmitting, and select channel and modulation type |

4.5 Test Channel

| | 802.11 b/g/n20(HT20) | | | | | 802.11 n40(HT40) | | |
|-----------------|----------------------|-----------|-----------|-------|---------|------------------|-----------|-----------|
| | Channel | Frequency | Data rate | | | Channel | Frequency | Data rate |
| | | | b | g | n(HT20) | | | |
| lowest channel | CH01 | 2412MHz | 1Mbps | 6Mbps | MCS0 | CH03 | 2422MHz | MCS0 |
| Middle channel | CH06 | 2437MHz | 1Mbps | 6Mbps | MCS0 | CH06 | 2437MHz | MCS0 |
| Highest channel | CH11 | 2462MHz | 1Mbps | 6Mbps | MCS0 | CH09 | 2452MHz | MCS0 |

Remark: Preliminary tests were performed in all tests in different data rate and antenna configurations at lowest channel, the data rates of worse case as above were chosen for final test.

4.6 Description of Support Units

The EUT has been tested with support equipments as below.

| Description | Manufacturer | Model No. | Supplied By |
|---------------------------|--------------|----------------|-------------|
| Laptop | Lenovo | ThinkPad X100e | SGS |
| Serial port adapter plate | / | Test Plate 3 | SGS |
| Adapter | DVE | DSA-12G-12FEU | Client |

Parameter of adapter:

| | | | |
|----------|---------------|---------------------------|---------|
| Adapter: | Rated Input: | AC 100~240V, 50/60Hz 0.3A | |
| | Rated Output: | DC 12V 1.0A | |
| | Cable length: | AC port: | 2 wires |
| | | DC port: | 150 cm |

| Software name | Manufacturer | Version | Supplied By |
|---------------|--------------|---------|-------------|
| Secure CRT | VanDyke | V6.2.0 | SGS |

4.7 Test Location

All tests were performed at:

SGS-CSTC Standards Technical Services Co., Ltd., Shenzhen Branch

No. 1 Workshop, M-10, Middle Section, Science & Technology Park, Shenzhen, Guangdong, China. 518057.

Tel: +86 755 2601 2053

Fax: +86 755 2671 0594

No tests were sub-contracted.



4.8 Test Facility

The test facility is recognized, certified, or accredited by the following organizations:

• **CNAS (No. CNAS L2929)**

CNAS has accredited SGS-CSTC Standards Technical Services Co., Ltd. Shenzhen Branch EMC Lab to ISO/IEC 17025:2005 General Requirements for the Competence of Testing and Calibration Laboratories (CNAS-CL01 Accreditation Criteria for the Competence of Testing and Calibration Laboratories) for the competence in the field of testing.

• **A2LA (Certificate No. 3816.01)**

SGS-CSTC Standards Technical Services Co., Ltd., Shenzhen EMC Laboratory is accredited by the American Association for Laboratory Accreditation(A2LA). Certificate No. 3816.01.

• **VCCI**

The 10m Semi-anechoic chamber and Shielded Room of SGS-CSTC Standards Technical Services Co., Ltd. have been registered in accordance with the Regulations for Voluntary Control Measures with Registration No.: G-823, R-4188, T-1153 and C-2383 respectively.

• **FCC –Designation Number: CN1178**

SGS-CSTC Standards Technical Services Co., Ltd., Shenzhen EMC Laboratory has been recognized as an accredited testing laboratory.

Designation Number: CN1178. Test Firm Registration Number: 406779.

• **Industry Canada (IC)**

Two 3m Semi-anechoic chambers and the 10m Semi-anechoic chamber of SGS-CSTC Standards Technical Services Co., Ltd. Shenzhen Branch EMC Lab have been registered by Certification and Engineering Bureau of Industry Canada for radio equipment testing with Registration No.: 4620C-1, 4620C-2, 4620C-3.

4.9 Measurement Uncertainty

| No. | Parameter | Measurement Uncertainty |
|-----|-------------------------------|--|
| 1 | Radio Frequency | $< \pm 1 \times 10^{-5}$ |
| 2 | Total RF power, conducted | $< \pm 1.5$ dB |
| 3 | RF power density, conducted | $< \pm 3$ dB |
| 4 | Spurious emissions, conducted | $< \pm 3$ dB |
| 5 | All emissions, radiated | $< \pm 6$ dB (Below 1GHz) $< \pm 6$ dB (Above 1GHz) |
| 6 | Temperature | $< \pm 1^{\circ}\text{C}$ |
| 7 | Humidity | $< \pm 5$ % |
| 8 | DC and low frequency voltages | $< \pm 3$ % |

5 Equipments Used during Test

| Equipment | Manufacturer | Model No | Inventory No | Cal Date | Cal Due Date |
|--|--------------|--------------------|--------------|------------|--------------|
| Conducted Emission at AC Power Line | | | | | |
| EMI test receiver | R&S | ESR7 | SHEM162-1 | 2017-12-20 | 2018-12-19 |
| LISN | Schwarzbeck | NSLK8127 | SHEM061-1 | 2017-12-20 | 2018-12-19 |
| LISN | EMCO | 3816/2 | SHEM019-1 | 2017-12-20 | 2018-12-19 |
| Pulse limiter | R&S | ESH3-Z2 | SHEM029-1 | 2017-12-20 | 2018-12-19 |
| CE test Cable | / | CE01 | / | 2017-12-26 | 2018-12-25 |
| Conducted Test | | | | | |
| Spectrum Analyzer | R&S | FSP-30 | SHEM002-1 | 2017-12-20 | 2018-12-19 |
| Spectrum Analyzer | Agilent | N9020A | SHEM181-1 | 2017-09-26 | 2018-09-25 |
| Power meter | R&S | NRP | SHEM057-1 | 2017-12-26 | 2018-12-25 |
| Power Sensor | R&S | NRP-Z22 | SHEM136-1 | 2017-07-22 | 2018-07-21 |
| Power Sensor | R&S | NRP-Z91 | SHEM057-2 | 2017-12-26 | 2018-12-25 |
| Signal Generator | R&S | SMR40 | SHEM058-1 | 2017-07-03 | 2018-07-02 |
| Signal Generator | Agilent | N5182A | SHEM182-1 | 2017-09-26 | 2018-09-25 |
| Communication Tester | R&S | CMW270 | SHEM183-1 | 2017-10-22 | 2018-10-21 |
| Switcher | Tonscend | JS0806 | SHEM184-1 | 2017-09-26 | 2018-09-25 |
| Splitter | Anritsu | MA1612A | SHEM185-1 | / | / |
| Coupler | e-meca | 803-S-1 | SHEM186-1 | / | / |
| High-low Temp Cabinet | Suzhou Zhihe | TL-40 | SHEM087-1 | 2017-09-26 | 2018-09-25 |
| AC Power Stabilizer | WOCEN | 6100 | SHEM045-1 | 2017-12-26 | 2018-12-25 |
| DC Power Supply | QJE | QJ30003SII | SHEM046-1 | 2017-12-26 | 2018-12-25 |
| Conducted test Cable | / | RF01, RF 02 | / | 2017-12-26 | 2018-12-25 |
| Radiated Test | | | | | |
| EMI test receiver | R&S | ESU40 | SHEM051-1 | 2017-12-20 | 2018-12-19 |
| Spectrum Analyzer | R&S | FSP-30 | SHEM002-1 | 2017-12-20 | 2018-12-19 |
| Loop Antenna (9kHz-30MHz) | Schwarzbeck | FMZB1519 | SHEM135-1 | 2017-04-10 | 2020-04-09 |
| Antenna (25MHz-2GHz) | Schwarzbeck | VULB9168 | SHEM048-1 | 2017-02-28 | 2020-02-27 |
| Antenna (25MHz-3GHz) | Schwarzbeck | HL562 | SHEM010-1 | 2017-02-28 | 2020-02-27 |
| Horn Antenna (1-8GHz) | Schwarzbeck | HF906 | SHEM009-1 | 2017-10-24 | 2020-10-23 |
| Horn Antenna (1-18GHz) | Schwarzbeck | BBHA9120D | SHEM050-1 | 2017-01-14 | 2020-01-13 |
| Horn Antenna (14-40GHz) | Schwarzbeck | BBHA 9170 | SHEM049-1 | 2017-12-03 | 2020-12-02 |
| Pre-amplifier (9KHz-2GHz) | CLAVIIO | BDLNA-0001-412010 | SHEM164-1 | 2017-08-22 | 2018-08-21 |
| Pre-amplifier (1-18GHz) | CLAVIIO | BDLNA-0118-352810 | SHEM050-2 | 2017-08-22 | 2018-08-21 |
| High-amplifier (14-40GHz) | Schwarzbeck | 10001 | SHEM049-2 | 2017-12-20 | 2018-12-19 |
| Band filter | LORCH | 9BRX-875/X150-SR | SHEM156-1 | / | / |
| Band filter | LORCH | 13BRX-1950/X500-SR | SHEM083-2 | / | / |
| Band filter | LORCH | 5BRX-2400/X200-SR | SHEM155-1 | / | / |
| Band filter | LORCH | 5BRX-5500/X1000-SR | SHEM157-2 | / | / |
| High pass Filter | Wainwright | WHK3.0/18G-100SS | SHEM157-1 | / | / |
| High pass Filter | Wainwright | WHKS1700-3SS | SHEM157-3 | / | / |
| Semi/Fully Anechoic | ST | 11*6*6M | SHEM078-2 | 2017-07-22 | 2020-07-21 |
| RE test Cable | / | RE01, RE02, RE06 | / | 2017-12-26 | 2018-12-25 |



6 Test Results

6.1 E.U.T. test conditions

Requirements: 15.31(e) For intentional radiators, measurements of the variation of the input power or the radiated signal level of the fundamental frequency component of the emission, as appropriate, shall be performed with the supply voltage varied between 85% and 115% of the nominal rated supply voltage. For battery operated equipment, the equipment tests shall be performed using a new battery.

| | | |
|-------------------------------|-----------------------|---------------|
| Operating Environment: | Temperature: | 20.0 -25.0 °C |
| | Humidity: | 35-75 % RH |
| | Atmospheric Pressure: | 99.2 -102 kPa |

Test frequencies: According to the 15.31(m) Measurements on intentional radiators or receivers, other than TV broadcast receivers, shall be performed and, if required, reported for each band in which the device can be operated with the device operating at the number of frequencies in each band specified in the following table:

| Frequency range over which device operates | Number of frequencies | Location in the range of operation |
|--|-----------------------|---|
| 1 MHz or less | 1 | Middle |
| 1 to 10 MHz | 2 | 1 near top and 1 near bottom |
| More than 10 MHz | 3 | 1 near top, 1 near middle and 1 near bottom |

Pursuant to Part 15.31(c) For swept frequency equipment, measurements shall be made with the frequency sweep stopped at those frequencies chosen for the measurements to be reported.

6.2 Antenna Requirement

Standard requirement:

An intentional radiator shall be designed to ensure that no antenna other than that furnished by the responsible party shall be used with the device. The use of a permanently attached antenna or of an antenna that uses a unique coupling to the intentional radiator, the manufacturer may design the unit so that a broken antenna can be replaced by the user, but the use of a standard antenna jack or electrical connector is prohibited

The conducted output power limit specified in paragraph (b) of this section is based on the use of antennas with directional gains that do not exceed 6 dBi. Except as shown in paragraph (c) of this section, if transmitting antennas of directional gain greater than 6 dBi are used, the conducted output power from the intentional radiator shall be reduced below the stated values in paragraphs (b)(1), (b)(2), and (b)(3) of this section, as appropriate, by the amount in dB that the directional gain of the antenna exceeds 6 dBi.

EUT Antenna:

The antenna is Dipole Antenna (RP-SMA) and no consideration of replacement. The gain of the antenna is less than 2.0 dBi



6.3 Conducted Emissions on Mains Terminals

Frequency Range: 150 KHz to 30 MHz

Limit:

| Frequency range MHz | Class B Limits: dB (μV) | |
|------------------------|-------------------------|----------|
| | Quasi-peak | Average |
| 0.15 to 0.50 | 66 to 56 | 56 to 46 |
| 0.50 to 5 | 56 | 46 |
| 5 to 30 | 60 | 50 |

Note1: The limit decreases linearly with the logarithm of the frequency in the range 0.15 MHz to 0.50MHz.

Note2: The lower limit is applicable at the transition frequency.

Test Setup:

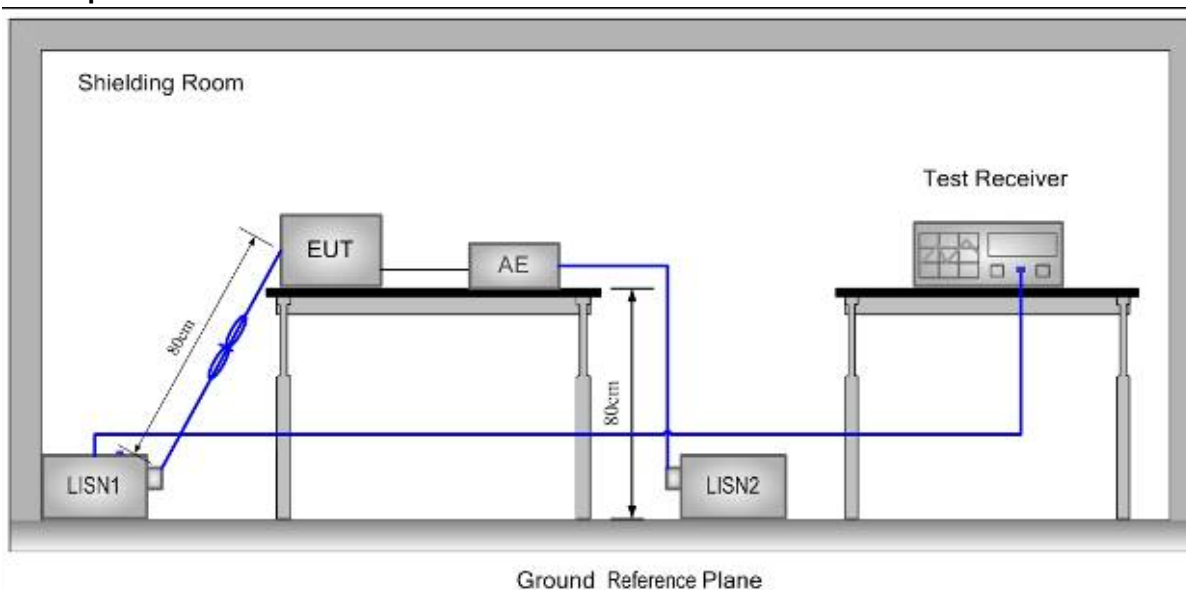

Test Procedure:

- 1) The mains terminal disturbance voltage was measured with the EUT in a shielded room.
- 2) The EUT was connected to AC power source through a LISN 1 (Line Impedance Stabilization Network) which provides 50Ω/50μH + 5Ω linear impedance. The power cables of all other units of the EUT were connected to a second LISN, which was bonded to the ground reference plane in the same way as the LISN for the unit being measured. A multiple socket outlet strip was used to connect multiple power cables to a single LISN provided the rating of the LISN was not exceeded
- 3) The tabletop EUT was placed upon a non-metallic table 0.8m above the ground reference plane. And for floor-standing arrangement, the EUT was placed on the horizontal ground reference plane, but separated from metallic contact with the ground reference plane by 0.1m of insulation.
- 4) The test was performed with a vertical ground reference plane. The rear of the EUT shall be 0.4 m from the vertical ground reference plane. The vertical ground reference plane was bonded to the horizontal ground reference plane. The LISN was placed 0.8 m from the boundary of the unit under test and bonded to a ground reference plane for LISN mounted on top of the ground reference plane. This distance was between the closest points of the LISN and the EUT. The mains lead of EUT excess 0.8m was folded back and forth parallel to the lead so as to form a



horizontal bundle with a length between 0.3m and 0.4m. All other units of the EUT and associated equipment were at least 0.8 m from the LISN.

Remark: Pre-scan was performed with peak detected on all ports, Quasi-peak & average measurements were performed at the frequencies at which maximum peak emission level were detected. Pretest under all modes; choose the worst case mode (802.11b in Middle channel) record on the report. Please see the attached Quasi-peak and Average test results.

Test Result: PASS

Test Data:

| | | | |
|-------------------|--------------|----------------------|--------|
| Test Mode: | 802.11b | Test Channel: | Middle |
| Test Port: | AC Live Line | | |

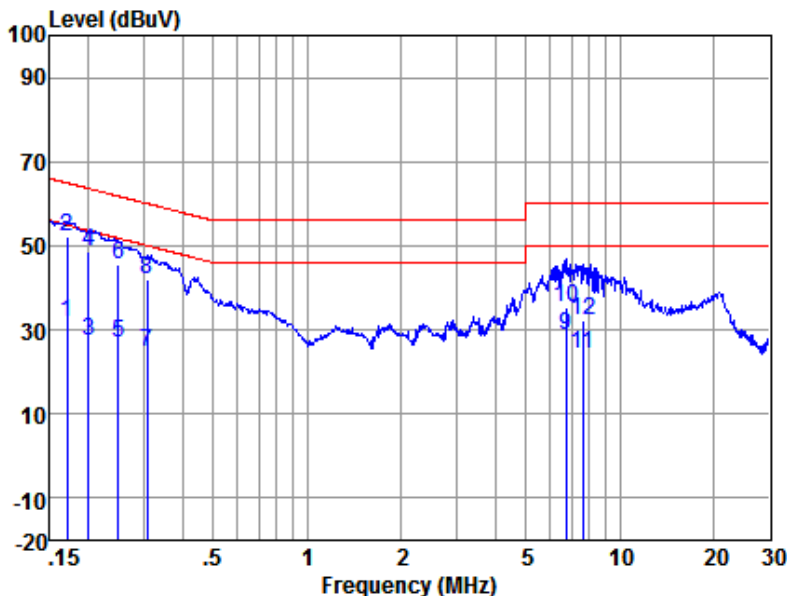

LISN : LINE
 EUT/Project No : 7817CR
 Test Mode : a

| | Freq (MHz) | Read level (dBUV) | LISN Factor (dB) | Cable Loss (dB) | Emission Level (dBUV) | Limit (dBUV) | Over Limit (dB) | Remark |
|----|------------|-------------------|------------------|-----------------|-----------------------|--------------|-----------------|---------|
| 1 | 0.17 | 21.93 | 0.11 | 9.81 | 31.85 | 54.94 | -23.09 | Average |
| 2 | 0.17 | 42.35 | 0.11 | 9.81 | 52.27 | 64.94 | -12.67 | QP |
| 3 | 0.20 | 17.51 | 0.11 | 9.81 | 27.43 | 53.62 | -26.19 | Average |
| 4 | 0.20 | 38.79 | 0.11 | 9.81 | 48.71 | 63.62 | -14.91 | QP |
| 5 | 0.25 | 16.95 | 0.11 | 9.81 | 26.87 | 51.82 | -24.95 | Average |
| 6 | 0.25 | 35.78 | 0.11 | 9.81 | 45.70 | 61.82 | -16.12 | QP |
| 7 | 0.31 | 14.95 | 0.11 | 9.81 | 24.87 | 50.06 | -25.19 | Average |
| 8 | 0.31 | 31.87 | 0.11 | 9.81 | 41.79 | 60.06 | -18.27 | QP |
| 9 | 6.73 | 18.91 | 0.11 | 9.86 | 28.88 | 50.00 | -21.12 | Average |
| 10 | 6.73 | 25.37 | 0.11 | 9.86 | 35.34 | 60.00 | -24.66 | QP |
| 11 | 7.65 | 14.54 | 0.10 | 9.86 | 24.50 | 50.00 | -25.50 | Average |
| 12 | 7.65 | 22.31 | 0.10 | 9.86 | 32.27 | 60.00 | -27.73 | QP |

Notes: Emission Level = Read Level + LISN Factor + Cable loss

This document is issued by the Company subject to its General Conditions of Service printed overleaf, available on request or accessible at www.sgs.com/terms_and_conditions.htm and, for electronic format documents, subject to Terms and Conditions for Electronic Documents at www.sgs.com/terms_e-document.htm. Attention is drawn to the limitation of liability, indemnification and jurisdiction issues defined therein. Any holder of this document is advised that information contained hereon reflects the Company's findings at the time of its intervention only and within the limits of Client's instructions, if any. The Company's sole responsibility is to its Client and this document does not exonerate parties to a transaction from exercising all their rights and obligations under the transaction documents. This document cannot be reproduced except in full, without prior written approval of the Company. Any unauthorized alteration, forgery or falsification of the content or appearance of this document is unlawful and offenders may be prosecuted to the fullest extent of the law. Unless otherwise stated the results shown in this test report refer only to the sample(s) tested and such sample(s) are retained for 90 days only

Test Port: AC Neutral Line

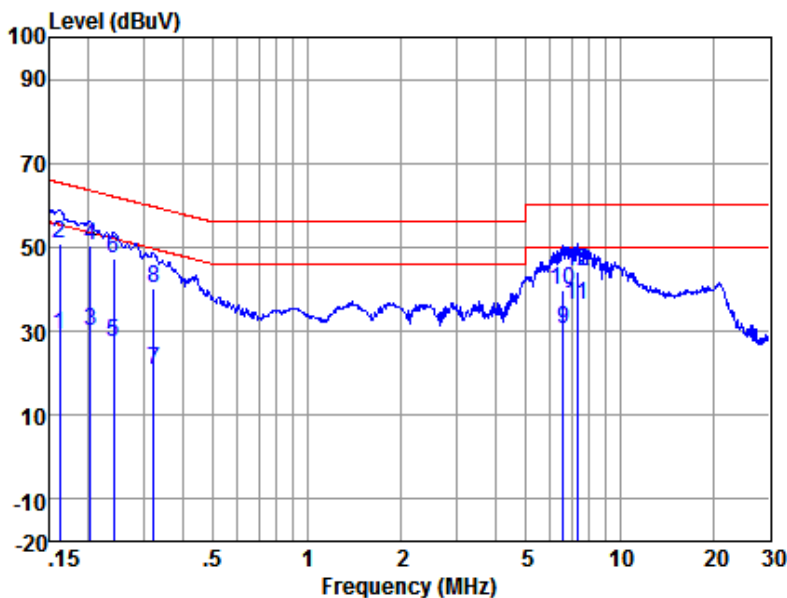

LISN : NEUTRAL
EUT/Project No : 7817CR
Test Mode : a

| | Freq (MHz) | Read level (dBuV) | LISN Factor (dB) | Cable Loss (dB) | Emission Level (dBuV) | Limit (dBuV) | Over Limit (dB) | Remark |
|----|---------------|-------------------------|------------------------|-----------------------|-----------------------------|-----------------|-----------------------|---------|
| 1 | 0.16 | 19.02 | 0.12 | 9.81 | 28.95 | 55.38 | -26.43 | Average |
| 2 | 0.16 | 40.97 | 0.12 | 9.81 | 50.90 | 65.38 | -14.48 | QP |
| 3 | 0.20 | 20.24 | 0.12 | 9.81 | 30.17 | 53.54 | -23.37 | Average |
| 4 | 0.20 | 40.33 | 0.12 | 9.81 | 50.26 | 63.54 | -13.28 | QP |
| 5 | 0.24 | 17.54 | 0.11 | 9.81 | 27.46 | 52.08 | -24.62 | Average |
| 6 | 0.24 | 37.35 | 0.11 | 9.81 | 47.27 | 62.08 | -14.81 | QP |
| 7 | 0.32 | 10.89 | 0.11 | 9.81 | 20.81 | 49.66 | -28.85 | Average |
| 8 | 0.32 | 30.11 | 0.11 | 9.81 | 40.03 | 59.66 | -19.63 | QP |
| 9 | 6.59 | 20.52 | 0.13 | 9.86 | 30.51 | 50.00 | -19.49 | Average |
| 10 | 6.59 | 29.97 | 0.13 | 9.86 | 39.96 | 60.00 | -20.04 | QP |
| 11 | 7.33 | 26.27 | 0.13 | 9.86 | 36.26 | 50.00 | -13.74 | Average |
| 12 | 7.33 | 34.03 | 0.13 | 9.86 | 44.02 | 60.00 | -15.98 | QP |

Notes: Emission Level = Read Level + LISN Factor + Cable loss

This document is issued by the Company subject to its General Conditions of Service printed overleaf, available on request or accessible at www.sgs.com/terms_and_conditions.htm and, for electronic format documents, subject to Terms and Conditions for Electronic Documents at www.sgs.com/terms_e-document.htm. Attention is drawn to the limitation of liability, indemnification and jurisdiction issues defined therein. Any holder of this document is advised that information contained hereon reflects the Company's findings at the time of its intervention only and within the limits of Client's instructions, if any. The Company's sole responsibility is to its Client and this document does not exonerate parties to a transaction from exercising all their rights and obligations under the transaction documents. This document cannot be reproduced except in full, without prior written approval of the Company. Any unauthorized alteration, forgery or falsification of the content or appearance of this document is unlawful and offenders may be prosecuted to the fullest extent of the law. Unless otherwise stated the results shown in this test report refer only to the sample(s) tested and such sample(s) are retained for 90 days only

6.4 6dB Occupied Bandwidth

Test Configuration:

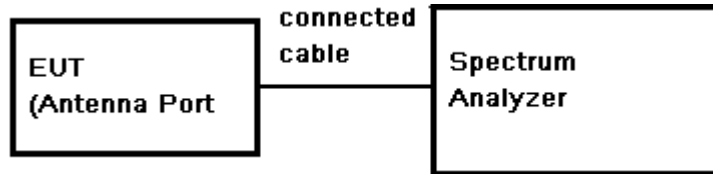

Test Procedure:

- 1) Place the EUT on the table and set it in transmitting mode.
- 2) Remove the antenna from the EUT and then connect a low loss RF cable from the antenna port to the spectrum analyzer.
- 3) Set the spectrum analyzer as RBW=100KHz, VBW \geq 3* RBW, Detector=Peak, Trace mode= Max hold, Sweep=Auto couple.
- 4) Set the spectrum analyser x dB (x=-6)
- 5) Repeat above procedures until all frequency measured was complete.

Limit:

\geq 500 kHz

Test Result:

Pass

Test Data:

The detailed test data see: Appendix A for SZEM180200104302

6.5 Conducted Average Output Power

Test Configuration:

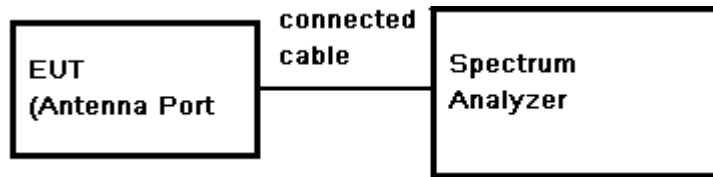

Test Procedure:

- 1) Place the EUT on the table and set it in transmitting mode.
- 2) Remove the antenna from the EUT and then connect a low loss RF cable from the antenna port to the spectrum.
- 3) Set the spectrum analyzer as RBW=1 % to 5 % of the OBW, VBW \geq 3* RBW, Detector=RMS, Span \geq 1.5 \times DTS bandwidth, Trace mode= Average, Sweep=Auto couple
- 4) Allow trace to fully stabilize.
- 5) Use the instrument's band/channel power measurement function with the band limits set equal to the DTS bandwidth edges
- 6) Record the max. Power channel reading.
- 7) Repeat above procedures until all the frequency measured were complete.

Test Limit: 30dBm

Test Result: Pass

Test Data:

The detailed test data see: Appendix A for SZEM180200104302

6.6 Average Power Spectral Density

Test Configuration:

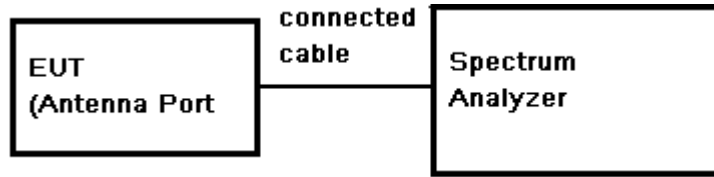

Test Procedure:

- 1) Remove the antenna from the EUT and then connect a low RF cable from the antenna port to the spectrum.
- 2) Set the spectrum analyzer: Center Frequency= Channel Frequency, RBW = 3 kHz VBW = 10 kHz. Span= 1.5 times the DTS bandwidth, Sweep = auto; Detector = RMS; Trace=Average.
- 3) Use the peak marker function to determine the maximum amplitude level within the RBW.
- 4) Record the marker level for the particular mode.
- 5) Repeat these steps for other channel and modes.

Test Limit: 8dBm/3kHz

Test Result: Pass

Test Data:

The detailed test data see: Appendix A for SZEM180200104302

6.7 Conducted Spurious Emissions and Band-edge

Test Configuration:

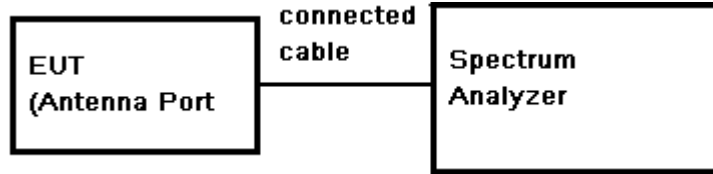

Test Procedure:

- 1) Remove the antenna from the EUT and then connect a low RF cable from the antenna port to the spectrum.
- 2) Set the spectrum analyzer: RBW = 100KHz. VBW = 300KHz. Sweep = auto; Detector Function = Peak (Max. hold).

Limit:

(d) In any 100 kHz bandwidth outside the frequency band in which the spread spectrum or digitally modulated intentional radiator is operating, the radio frequency power that is produced by the intentional radiator shall be at least 20 dB below that in the 100 kHz bandwidth within the band that contains the Highest level of the desired power, based on either an RF conducted or a radiated measurement, provided the transmitter demonstrates compliance with the peak conducted power limits.

Test Result:

Pass

6.7.1 Conducted spurious emission

The detailed test data see: Appendix A for SZEM180200104302

6.7.2 Conducted Band-edge

The detailed test data see: Appendix A for SZEM180200104302

6.8 Radiated Spurious Emissions and Band-edge

Frequency Range: 9KHz to 25GHz

Test site/setup: Measurement Distance: 3m
Test instrumentation set-up:

| Frequency Range | Detector | RBW | VBW |
|-------------------|------------|----------|----------|
| 0.009MHz-0.090MHz | Peak | 10kHz | 30kHz |
| 0.009MHz-0.090MHz | Average | 10kHz | 30kHz |
| 0.090MHz-0.110MHz | Quasi-peak | 10kHz | 30kHz |
| 0.110MHz-0.490MHz | Peak | 10kHz | 30kHz |
| 0.110MHz-0.490MHz | Average | 10kHz | 30kHz |
| 0.490MHz -30MHz | Quasi-peak | 10kHz | 30kHz |
| 30MHz-1GHz | Quasi-peak | 100kHz | 300kHz |
| Above 1GHz | Peak | RBW=1MHz | VBW≥RBW |
| | Average | | VBW=10Hz |

Sweep=Auto

15.209 Limit:

| Frequency | Field strength (microvolt/meter) | Limit (dBuV/m) |
|-------------------|----------------------------------|----------------|
| 0.009MHz-0.490MHz | 2400/F(KHz) | 128.5 ~ 93.8 |
| 0.490MHz-1.705MHz | 24000/F(KHz) | 73.8 ~63.0 |
| 1.705MHz-30MHz | 30 | 69.5 |
| 30MHz-88MHz | 100 | 40.0 |
| 88MHz-216MHz | 150 | 43.5 |
| 216MHz-960MHz | 200 | 46.0 |
| 960MHz-1GHz | 500 | 54.0 |
| Above 1GHz | 500 | 54.0 |

Note: 15.35(b), Unless otherwise specified, the limit on peak radio frequency emissions is 20dB above the maximum permitted average emission limit applicable to the equipment under test. This peak limit applies to the total peak emission level radiated by the device.

Test Configuration:

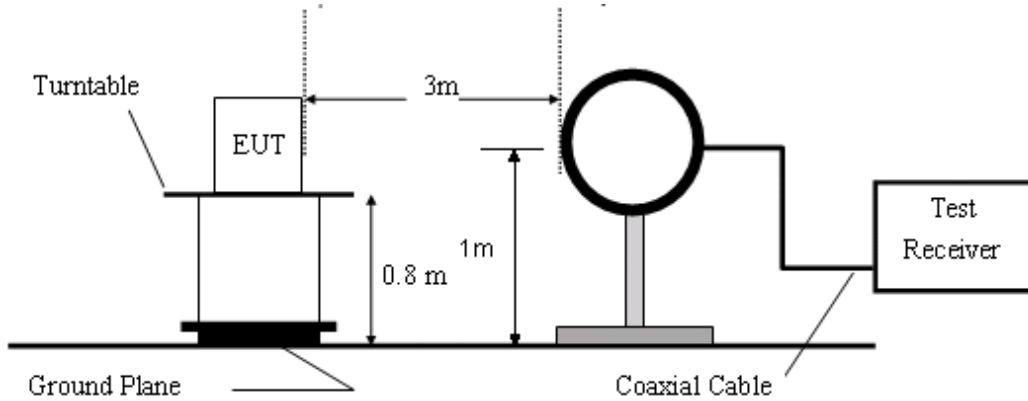

Figure1. Below 30MHz radiated emissions test configuration

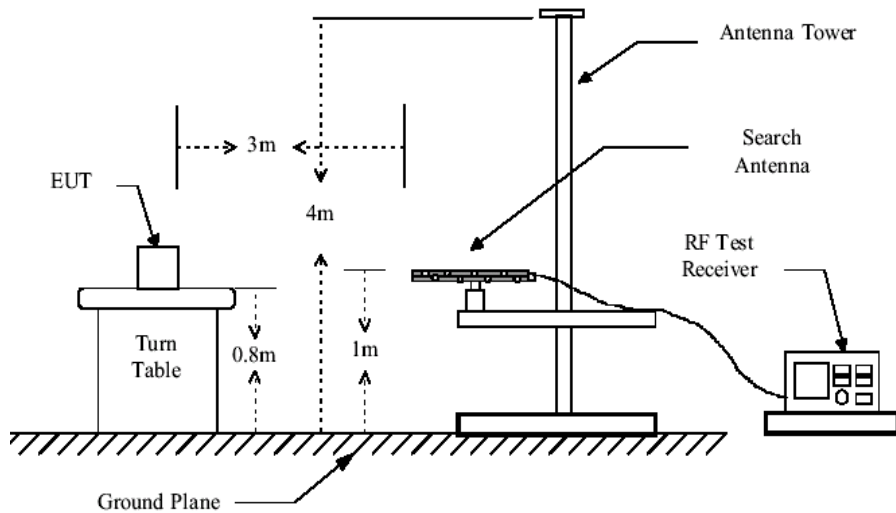

Figure2. 30MHz to 1GHz radiated emissions test configuration

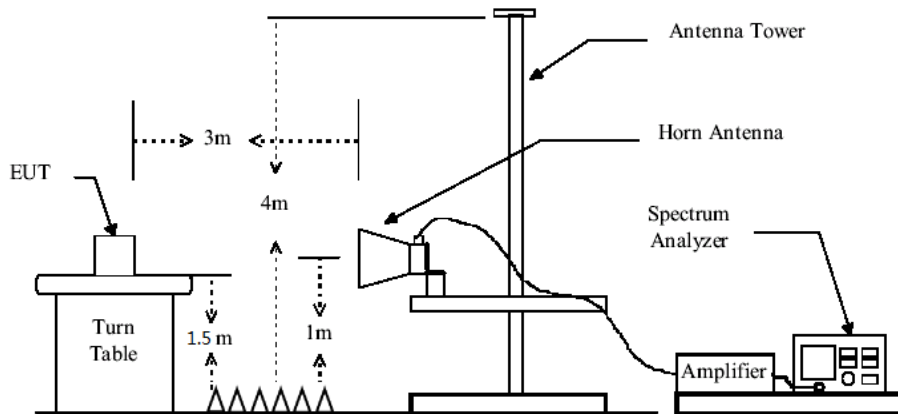

Figure3. Above 1GHz radiated emissions test configuration

- Test Procedure:**
- 1) The procedure used was ANSI Standard C63.10. The receiver was scanned from 9 KHz to 25GHz. When an emission was found, the table was rotated to produce the maximum signal strength. An initial pre-scan was performed for in peak detection mode using the receiver. The EUT was measured for both the Horizontal and Vertical polarities and performed a pre-test three orthogonal planes. For intentional radiators, measurements of the variation of the input power or the radiated signal level of the fundamental frequency component of the emission, as appropriate, shall be performed with the supply voltage varied between 85% and 115% of the nominal rated supply voltage. The worst case emissions were reported.
 - 2) Low noise amplifier was used below 1GHz, High pass Filter was used above 3GHz. We did not use any amplifier or filter between 1G and 3GHz.
 - 3) Test were performed for their spatial orthogonal(X, Y, Z), the worst test data (X orthogonal) was submitted.
 - a) For this intentional radiator operates below 25 GHz. the spectrum shall be investigated to the tenth harmonic of the highest fundamental frequency. And above the third harmonic of this intentional radiator, the disturbance is very low. So the test result only displays to 5rd harmonic.
 - b) As shown in Section, for frequencies above 1000MHz. the above field strength limits are based on average limits. However, the peak field strength of any emission shall not exceed the maximum permitted average limits specified above by more than 20 dB under any condition of modulation.
 - 4) Pretest under all modes below 1GHz; choose the worst case mode (802.11b) record on the report.
 - 5) No spurious emissions were detected within 20dB of limit below 30MHz.

Test Result: Pass

6.8.1 Radiated Spurious Emissions

30MHz-1GHz:

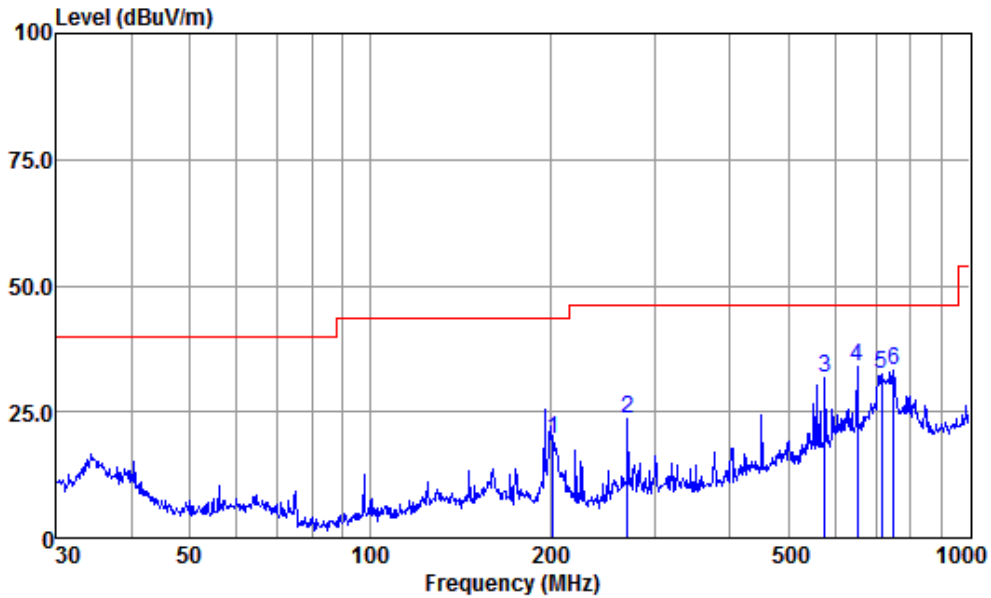

Antenna Polarity :HORIZONTAL
 EUT/Project :7817CR
 Test mode :a

| | Read Freq | Antenna Level | Cable Factor | Preamp Loss | Emission Factor | Limit Level | Over Line | Limit | Remark |
|---|-----------|---------------|--------------|-------------|-----------------|-------------|-----------|-------|--------|
| | MHz | dBuv | dB/m | dB | dB | dBuv/m | dBuv/m | dB | |
| 1 | 202.10 | 51.7 | 9.5 | 0.7 | 42.5 | 19.4 | 43.5 | -24.1 | QP |
| 2 | 269.43 | 52.9 | 12.2 | 0.8 | 42.4 | 23.5 | 46.0 | -22.5 | QP |
| 3 | 574.63 | 53.9 | 18.9 | 1.3 | 42.2 | 31.9 | 46.0 | -14.1 | QP |
| 4 | 651.94 | 55.0 | 19.8 | 1.5 | 42.3 | 34.0 | 46.0 | -12.0 | QP |
| 5 | 716.68 | 52.6 | 20.5 | 1.7 | 42.5 | 32.3 | 46.0 | -13.7 | QP |
| 6 | 750.11 | 52.6 | 21.1 | 1.9 | 42.6 | 33.0 | 46.0 | -13.0 | QP |

Note:Emission Level=Read Level+Antenna Factor+Cable loss-Preamp Factor

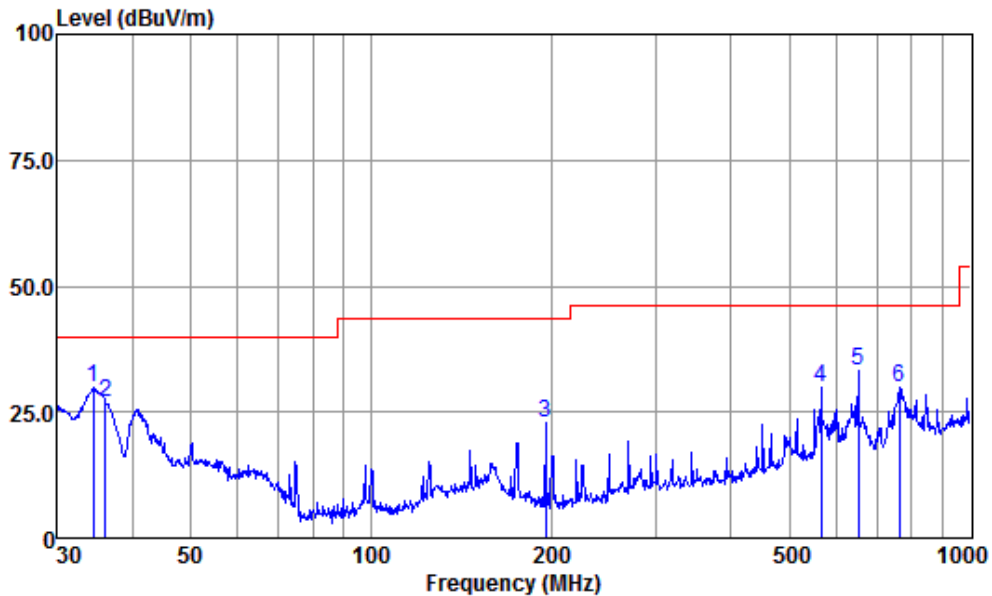

Antenna Polarity :VERTICAL
 EUT/Project :7817CR
 Test mode :a

| | Read Freq | Read Level | Antenna Factor | Cable Loss | Preamp Factor | Emission Level | Limit Line | Over Limit | Remark |
|---|-----------|------------|----------------|------------|---------------|----------------|------------|------------|--------|
| | MHz | dBuv | dB/m | dB | dB | dBuv/m | dBuv/m | dB | |
| 1 | 34.40 | 56.5 | 15.8 | 0.2 | 42.6 | 29.9 | 40.0 | -10.1 | QP |
| 2 | 36.13 | 53.4 | 15.9 | 0.2 | 42.6 | 26.9 | 40.0 | -13.1 | QP |
| 3 | 195.82 | 54.9 | 9.8 | 0.7 | 42.5 | 22.9 | 43.5 | -20.6 | QP |
| 4 | 564.64 | 52.2 | 18.7 | 1.3 | 42.2 | 30.0 | 46.0 | -16.0 | QP |
| 5 | 651.94 | 54.2 | 19.8 | 1.5 | 42.3 | 33.2 | 46.0 | -12.8 | QP |
| 6 | 763.38 | 49.1 | 21.3 | 1.9 | 42.6 | 29.7 | 46.0 | -16.3 | QP |

Note:Emission Level=Read Level+Antenna Factor+Cable loss-Preamp Factor



Above 1GHz:

Test mode: 802.11b

Channel: 2412

| Mark | Frequency (MHz) | Reading (dBuV) | Factor (dB) | Emission (dBuV/m) | Limit (dBuV/m) | Over Limit (dB) | Detector | Polarization |
|------|-----------------|----------------|-------------|-------------------|----------------|-----------------|----------|--------------|
| 1 | 4824 | 42.97 | 6.40 | 49.37 | 54 | -4.63 | peak | Horizontal |
| 2 | 7236 | 41.30 | 10.76 | 52.06 | 54 | -1.94 | peak | Horizontal |
| 3 | 9648 | 35.10 | 14.37 | 49.47 | 54 | -4.53 | peak | Horizontal |
| 4 | 4824 | 43.17 | 6.40 | 49.57 | 54 | -4.43 | peak | Vertical |
| 5 | 7236 | 40.37 | 10.76 | 51.13 | 54 | -2.87 | peak | Vertical |
| 6 | 9648 | 35.96 | 14.37 | 50.33 | 54 | -3.67 | peak | Vertical |

Test mode: 802.11b

Channel: 2437

| Mark | Frequency (MHz) | Reading (dBuV) | Factor (dB) | Emission (dBuV/m) | Limit (dBuV/m) | Over Limit (dB) | Detector | Polarization |
|------|-----------------|----------------|-------------|-------------------|----------------|-----------------|----------|--------------|
| 1 | 4874 | 38.40 | 6.92 | 45.32 | 54 | -8.68 | peak | Horizontal |
| 2 | 7311 | 36.59 | 11.08 | 47.67 | 54 | -6.33 | peak | Horizontal |
| 3 | 9748 | 33.67 | 14.36 | 48.03 | 54 | -5.97 | peak | Horizontal |
| 4 | 4874 | 41.88 | 6.92 | 48.80 | 54 | -5.20 | peak | Vertical |
| 5 | 7311 | 37.36 | 11.08 | 48.44 | 54 | -5.56 | peak | Vertical |
| 6 | 9748 | 34.19 | 14.36 | 48.55 | 54 | -5.45 | peak | Vertical |

Test mode: 802.11b

Channel: 2462

| Mark | Frequency (MHz) | Reading (dBuV) | Factor (dB) | Emission (dBuV/m) | Limit (dBuV/m) | Over Limit (dB) | Detector | Polarization |
|------|-----------------|----------------|-------------|-------------------|----------------|-----------------|----------|--------------|
| 1 | 4924 | 38.52 | 7.31 | 45.83 | 54 | -8.17 | peak | Horizontal |
| 2 | 7386 | 36.66 | 11.41 | 48.07 | 54 | -5.93 | peak | Horizontal |
| 3 | 9848 | 32.61 | 14.38 | 46.99 | 54 | -7.01 | peak | Horizontal |
| 4 | 4924 | 41.85 | 7.31 | 49.16 | 54 | -4.84 | peak | Vertical |
| 5 | 7386 | 39.74 | 11.41 | 51.15 | 54 | -2.85 | peak | Vertical |
| 6 | 9848 | 31.63 | 14.38 | 46.01 | 54 | -7.99 | peak | Vertical |

Test mode: 802.11g

Channel: 2412

| Mark | Frequency (MHz) | Reading (dBuV) | Factor (dB) | Emission (dBuV/m) | Limit (dBuV/m) | Over Limit (dB) | Detector | Polarization |
|------|-----------------|----------------|-------------|-------------------|----------------|-----------------|----------|--------------|
| 1 | 4824 | 41.38 | 6.40 | 47.78 | 54 | -6.22 | peak | Horizontal |
| 2 | 7236 | 39.04 | 10.76 | 49.80 | 54 | -4.20 | peak | Horizontal |
| 3 | 9648 | 33.24 | 14.37 | 47.61 | 54 | -6.39 | peak | Horizontal |
| 4 | 4824 | 43.66 | 6.40 | 50.06 | 54 | -3.94 | peak | Vertical |
| 5 | 7236 | 36.95 | 10.76 | 47.71 | 54 | -6.29 | peak | Vertical |
| 6 | 9648 | 35.18 | 14.37 | 49.55 | 54 | -4.45 | peak | Vertical |

Test mode: 802.11g

Channel: 2437

| Mark | Frequency (MHz) | Reading (dBuV) | Factor (dB) | Emission (dBuV/m) | Limit (dBuV/m) | Over Limit (dB) | Detector | Polarization |
|------|-----------------|----------------|-------------|-------------------|----------------|-----------------|----------|--------------|
| 1 | 4874 | 42.06 | 6.92 | 48.98 | 54 | -5.02 | peak | Horizontal |
| 2 | 7311 | 39.21 | 11.08 | 50.29 | 54 | -3.71 | peak | Horizontal |
| 3 | 9748 | 32.01 | 14.36 | 46.37 | 54 | -7.63 | peak | Horizontal |
| 4 | 4874 | 43.00 | 6.92 | 49.92 | 54 | -4.08 | peak | Vertical |
| 5 | 7311 | 36.57 | 11.08 | 47.65 | 54 | -6.35 | peak | Vertical |
| 6 | 9748 | 34.39 | 14.36 | 48.75 | 54 | -5.25 | peak | Vertical |

Test mode: 802.11g

Channel: 2462

| Mark | Frequency (MHz) | Reading (dBuV) | Factor (dB) | Emission (dBuV/m) | Limit (dBuV/m) | Over Limit (dB) | Detector | Polarization |
|------|-----------------|----------------|-------------|-------------------|----------------|-----------------|----------|--------------|
| 1 | 4924 | 39.38 | 7.31 | 46.69 | 54 | -7.31 | peak | Horizontal |
| 2 | 7386 | 34.43 | 11.41 | 45.84 | 54 | -8.16 | peak | Horizontal |
| 3 | 9848 | 36.75 | 14.38 | 51.13 | 54 | -2.87 | peak | Horizontal |
| 4 | 4924 | 40.38 | 7.31 | 47.69 | 54 | -6.31 | peak | Vertical |
| 5 | 7386 | 38.50 | 11.41 | 49.91 | 54 | -4.09 | peak | Vertical |
| 6 | 9848 | 36.24 | 14.38 | 50.62 | 54 | -3.38 | peak | Vertical |

Test mode: 802.11 n(HT20)

Channel: 2412

| Mark | Frequency (MHz) | Reading (dBuV) | Factor (dB) | Emission (dBuV/m) | Limit (dBuV/m) | Over Limit (dB) | Detector | Polarization |
|------|-----------------|----------------|-------------|-------------------|----------------|-----------------|----------|--------------|
| 1 | 4824 | 41.24 | 6.40 | 47.64 | 54 | -6.36 | peak | Horizontal |
| 2 | 7236 | 35.22 | 10.76 | 45.98 | 54 | -8.02 | peak | Horizontal |
| 3 | 9648 | 36.05 | 14.37 | 50.42 | 54 | -3.58 | peak | Horizontal |
| 4 | 4824 | 43.56 | 6.40 | 49.96 | 54 | -4.04 | peak | Vertical |
| 5 | 7236 | 35.68 | 10.76 | 46.44 | 54 | -7.56 | peak | Vertical |
| 6 | 9648 | 34.46 | 14.37 | 48.83 | 54 | -5.17 | peak | Vertical |

Test mode: 802.11 n(HT20)

Channel: 2437

| Mark | Frequency (MHz) | Reading (dBuV) | Factor (dB) | Emission (dBuV/m) | Limit (dBuV/m) | Over Limit (dB) | Detector | Polarization |
|------|-----------------|----------------|-------------|-------------------|----------------|-----------------|----------|--------------|
| 1 | 4874 | 42.13 | 6.92 | 49.05 | 54 | -4.95 | peak | Horizontal |
| 2 | 7311 | 38.19 | 11.08 | 49.27 | 54 | -4.73 | peak | Horizontal |
| 3 | 9748 | 31.86 | 14.36 | 46.22 | 54 | -7.78 | peak | Horizontal |
| 4 | 4874 | 39.49 | 6.92 | 46.41 | 54 | -7.59 | peak | Vertical |
| 5 | 7311 | 36.45 | 11.08 | 47.53 | 54 | -6.47 | peak | Vertical |
| 6 | 9748 | 31.60 | 14.36 | 45.96 | 54 | -8.04 | peak | Vertical |

Test mode: 802.11 n(HT20)

Channel: 2462

| Mark | Frequency (MHz) | Reading (dBuV) | Factor (dB) | Emission (dBuV/m) | Limit (dBuV/m) | Over Limit (dB) | Detector | Polarization |
|------|-----------------|----------------|-------------|-------------------|----------------|-----------------|----------|--------------|
| 1 | 4924 | 38.45 | 7.31 | 45.76 | 54 | -8.24 | peak | Horizontal |
| 2 | 7386 | 37.09 | 11.41 | 48.50 | 54 | -5.50 | peak | Horizontal |
| 3 | 9848 | 34.55 | 14.38 | 48.93 | 54 | -5.07 | peak | Horizontal |
| 4 | 4924 | 40.69 | 7.31 | 48.00 | 54 | -6.00 | peak | Vertical |
| 5 | 7386 | 37.62 | 11.41 | 49.03 | 54 | -4.97 | peak | Vertical |
| 6 | 9848 | 35.53 | 14.38 | 49.91 | 54 | -4.09 | peak | Vertical |

Test mode: 802.11 n(HT40)

Channel: 2422

| Mark | Frequency (MHz) | Reading (dBuV) | Factor (dB) | Emission (dBuV/m) | Limit (dBuV/m) | Over Limit (dB) | Detector | Polarization |
|------|-----------------|----------------|-------------|-------------------|----------------|-----------------|----------|--------------|
| 1 | 4844 | 41.66 | 6.60 | 48.26 | 54 | -5.74 | peak | Horizontal |
| 2 | 7266 | 37.81 | 10.89 | 48.70 | 54 | -5.30 | peak | Horizontal |
| 3 | 9688 | 35.73 | 14.35 | 50.08 | 54 | -3.92 | peak | Horizontal |
| 4 | 4844 | 39.43 | 6.60 | 46.03 | 54 | -7.97 | peak | Vertical |
| 5 | 7266 | 36.48 | 10.89 | 47.37 | 54 | -6.63 | peak | Vertical |
| 6 | 9688 | 31.42 | 14.35 | 45.77 | 54 | -8.23 | peak | Vertical |

Test mode: 802.11 n(HT40)

Channel: 2437

| Mark | Frequency (MHz) | Reading (dBuV) | Factor (dB) | Emission (dBuV/m) | Limit (dBuV/m) | Over Limit (dB) | Detector | Polarization |
|------|-----------------|----------------|-------------|-------------------|----------------|-----------------|----------|--------------|
| 1 | 4874 | 41.01 | 6.92 | 47.93 | 54 | -6.07 | peak | Horizontal |
| 2 | 7311 | 39.83 | 11.08 | 50.91 | 54 | -3.09 | peak | Horizontal |
| 3 | 9748 | 31.52 | 14.36 | 45.88 | 54 | -8.12 | peak | Horizontal |
| 4 | 4874 | 42.60 | 6.92 | 49.52 | 54 | -4.48 | peak | Vertical |
| 5 | 7311 | 38.53 | 11.08 | 49.61 | 54 | -4.39 | peak | Vertical |
| 6 | 9748 | 34.05 | 14.36 | 48.41 | 54 | -5.59 | peak | Vertical |

Test mode: 802.11 n(HT40)

Channel: 2452

| Mark | Frequency (MHz) | Reading (dBuV) | Factor (dB) | Emission (dBuV/m) | Limit (dBuV/m) | Over Limit (dB) | Detector | Polarization |
|------|-----------------|----------------|-------------|-------------------|----------------|-----------------|----------|--------------|
| 1 | 4904 | 41.30 | 7.22 | 48.52 | 54 | -5.48 | peak | Horizontal |
| 2 | 7356 | 39.09 | 11.28 | 50.37 | 54 | -3.63 | peak | Horizontal |
| 3 | 9808 | 31.55 | 14.37 | 45.92 | 54 | -8.08 | peak | Horizontal |
| 4 | 4904 | 43.09 | 7.22 | 50.31 | 54 | -3.69 | peak | Vertical |
| 5 | 7356 | 36.77 | 11.28 | 48.05 | 54 | -5.95 | peak | Vertical |
| 6 | 9808 | 32.93 | 14.37 | 47.30 | 54 | -6.70 | peak | Vertical |

Remark: 1) Emission = Receiver Reading - Factor

2) Factor = Antenna Factor + Cable Loss - Pre-amplifier Factor.

3) If the Peak value below the AV Limit, the AV test doesn't perform for this submission.

6.8.2 Radiated Band edge

Test Mode: 802.11b

Channel: 2412

| MK. | Frequency (MHz) | Reading (dBuV/m) | Corrected factor(dB) | Result (dBuV/m) | Limit (dBuV/m) | Over Limit (dB) | Detector | Polarization |
|-----|-----------------|------------------|----------------------|-----------------|----------------|-----------------|----------|--------------|
| 1 | 2332.2 | 47.23 | -3.71 | 43.52 | 54 | -10.48 | Peak | Horizontal |
| 2 | 2390 | 44.04 | -3.89 | 40.15 | 54 | -13.85 | Peak | Horizontal |
| 3 | 2410.92 | 93.84 | -3.92 | 89.92 | 54 | 35.92 | Peak | Horizontal |
| 1 | 2331.84 | 55.38 | -3.72 | 51.66 | 54 | -2.34 | Peak | Vertical |
| 2 | 2390 | 52.67 | -3.89 | 48.78 | 54 | -5.22 | Peak | Vertical |
| 3 | 2411.04 | 105.57 | -3.93 | 101.64 | 54 | 47.64 | Peak | Vertical |

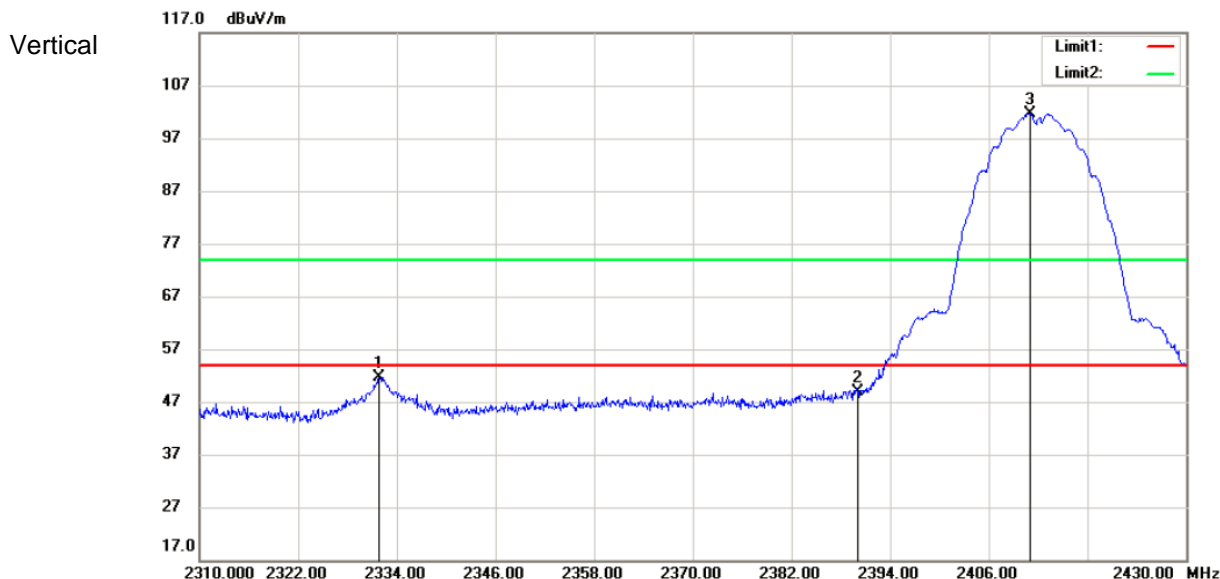
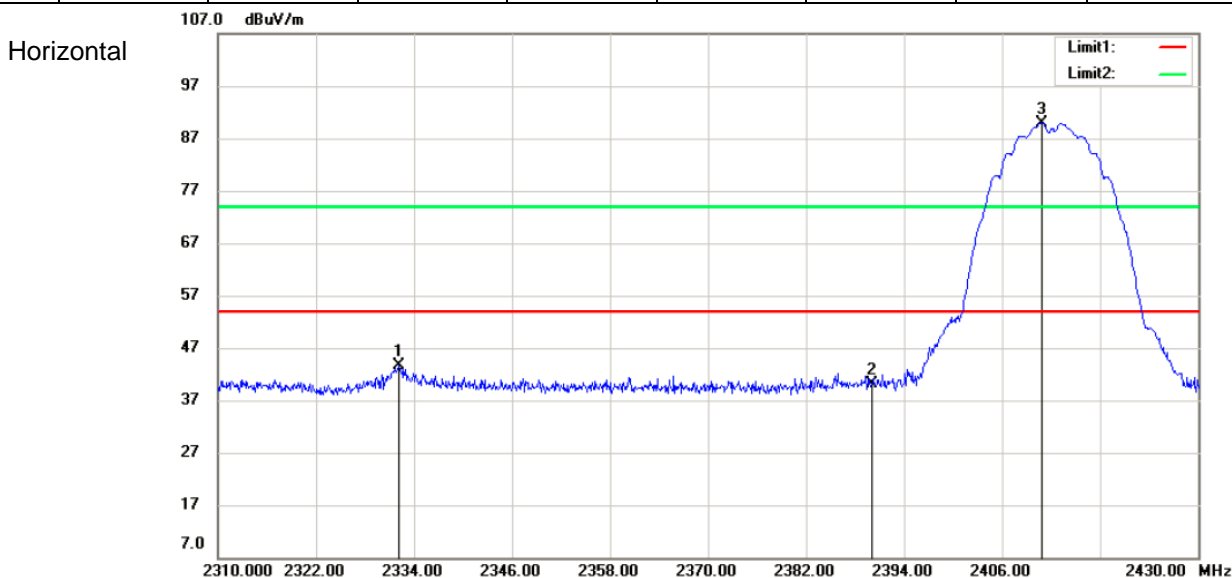

Test Mode: 802.11b

Channel: 2462

| MK. | Frequency (MHz) | Reading (dBuV/m) | Corrected factor(dB) | Result (dBuV/m) | Limit (dBuV/m) | Over Limit (dB) | Detector | Polarization |
|-----|-----------------|------------------|----------------------|-----------------|----------------|-----------------|----------|--------------|
| 1 | 2463.5 | 94.36 | -3.98 | 90.38 | 54 | 36.38 | Peak | Horizontal |
| 2 | 2483.5 | 44.77 | -4.01 | 40.76 | 54 | -13.24 | Peak | Horizontal |
| 3 | 2542.3 | 46.06 | -3.55 | 42.51 | 54 | -11.49 | Peak | Horizontal |
| 1 | 2463.1 | 105.21 | -3.98 | 101.23 | 54 | 47.23 | Peak | Vertical |
| 2 | 2483.5 | 51.98 | -4.01 | 47.97 | 54 | -6.03 | Peak | Vertical |
| 3 | 2542.6 | 51.86 | -3.55 | 48.31 | 54 | -5.69 | Peak | Vertical |

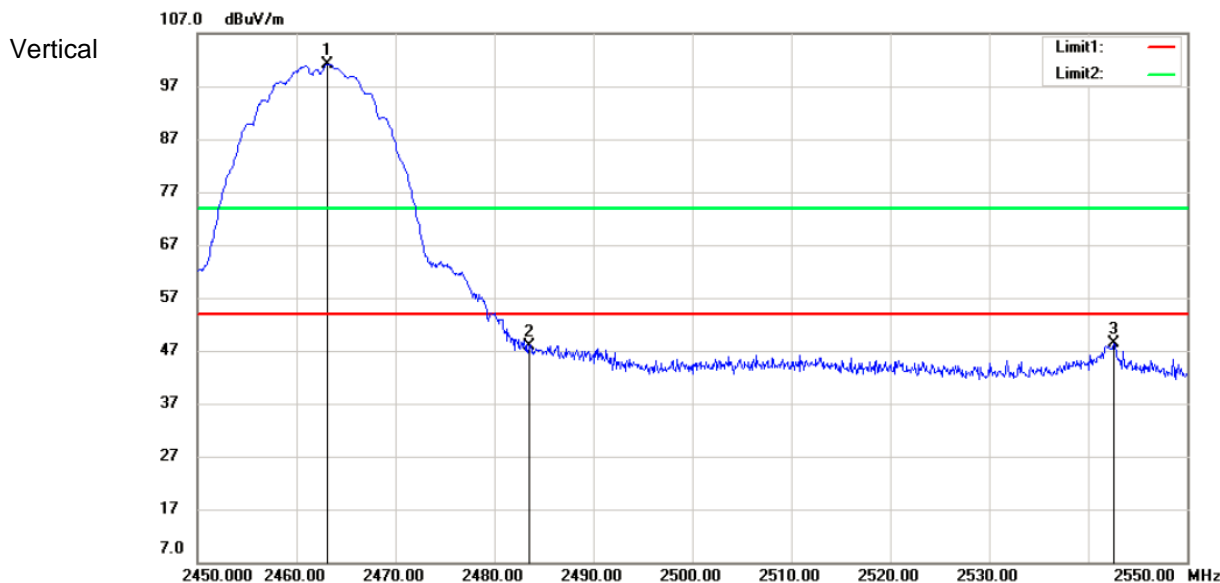
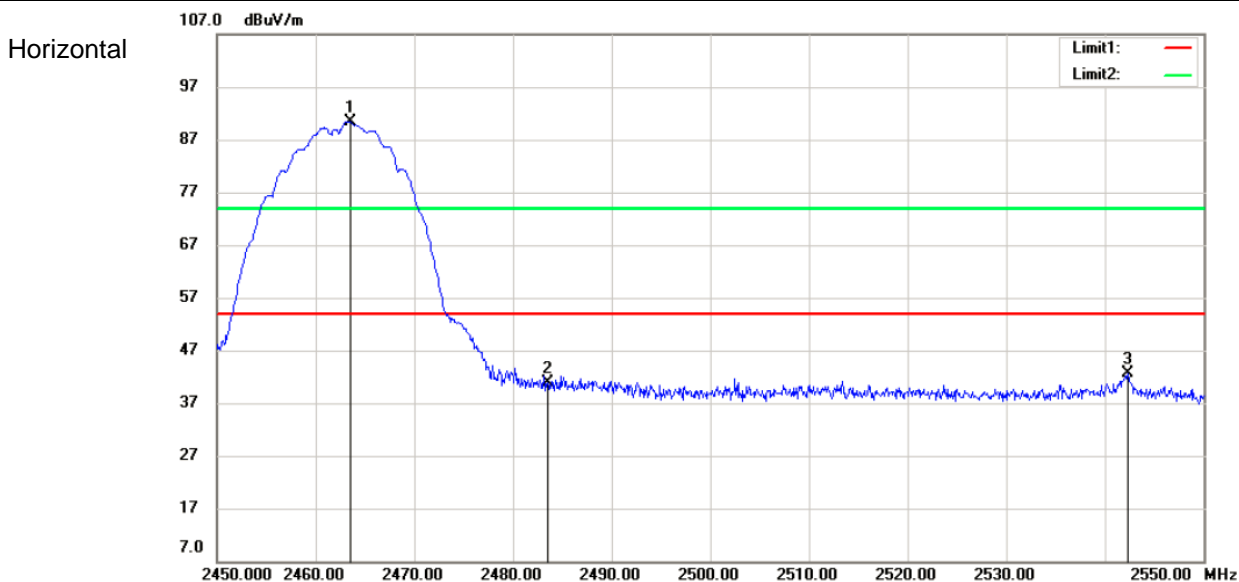



Test Mode: 802.11g

Channel: 2412

| MK. | Frequency (MHz) | Reading (dBuV/m) | Corrected factor(dB) | Result (dBuV/m) | Limit (dBuV/m) | Over Limit (dB) | Detector | Polarization |
|-----|-----------------|------------------|----------------------|-----------------|----------------|-----------------|----------|--------------|
| 1 | 2332.08 | 50.1 | -3.72 | 46.38 | 54 | -7.62 | Peak | Horizontal |
| 2 | 2390 | 44.78 | -3.89 | 40.89 | 54 | -13.11 | Peak | Horizontal |
| 3 | 2406 | 93.02 | -3.92 | 89.1 | 54 | 35.1 | Peak | Horizontal |

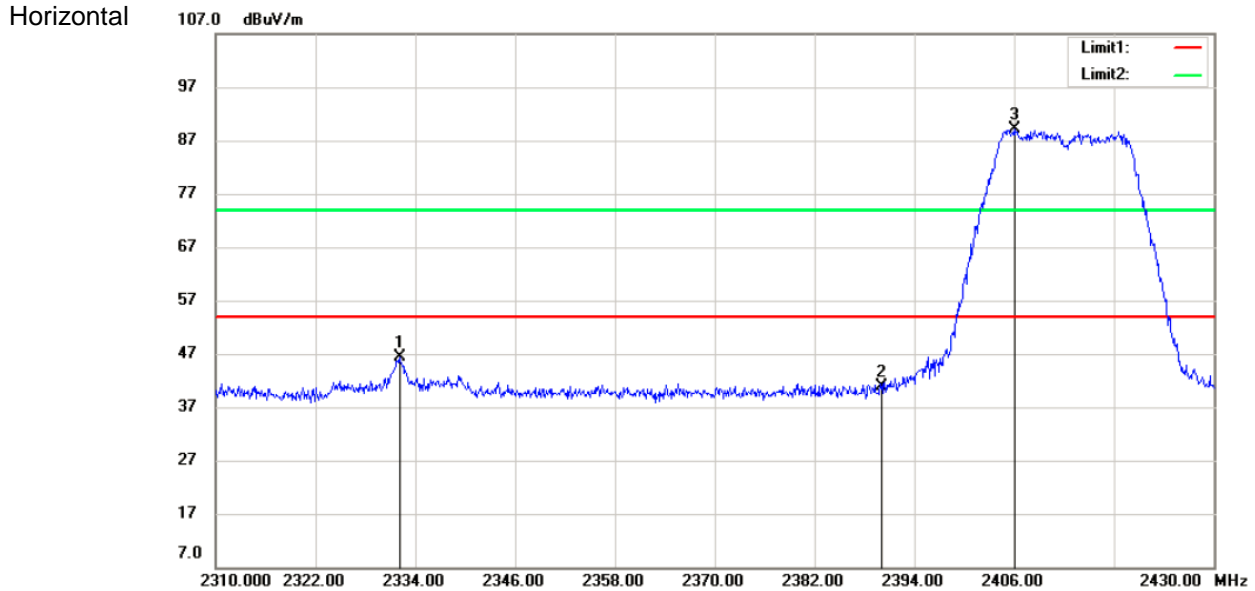

Test Mode: 802.11g

Channel: 2412

| MK. | Frequency (MHz) | Reading (dBuV/m) | Corrected factor(dB) | Result (dBuV/m) | Limit (dBuV/m) | Over Limit (dB) | Detector | Polarization |
|-----|-----------------|------------------|----------------------|-----------------|----------------|-----------------|----------|--------------|
| 1 | 2332.32 | 56.02 | -3.71 | 52.31 | 74 | -21.69 | Peak | Vertical |
| 2 | 2390 | 64.62 | -3.89 | 60.73 | 74 | -13.27 | Peak | Vertical |
| 3 | 2413.56 | 104.46 | -3.93 | 100.53 | 74 | 26.53 | Peak | Vertical |
| 1 | 2331.96 | 51.16 | -3.72 | 47.44 | 54 | -6.56 | Average | Vertical |
| 2 | 2390 | 46.44 | -3.89 | 42.55 | 54 | -11.45 | Average | Vertical |
| 3 | 2410.8 | 94.81 | -3.92 | 90.89 | 54 | 36.89 | Average | Vertical |

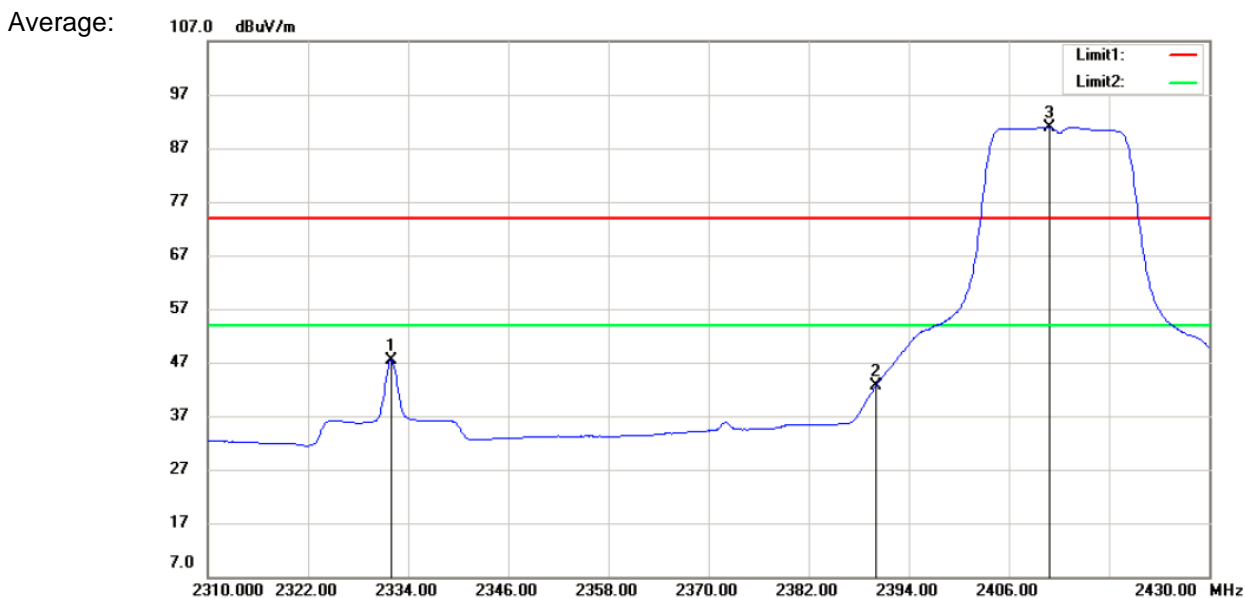
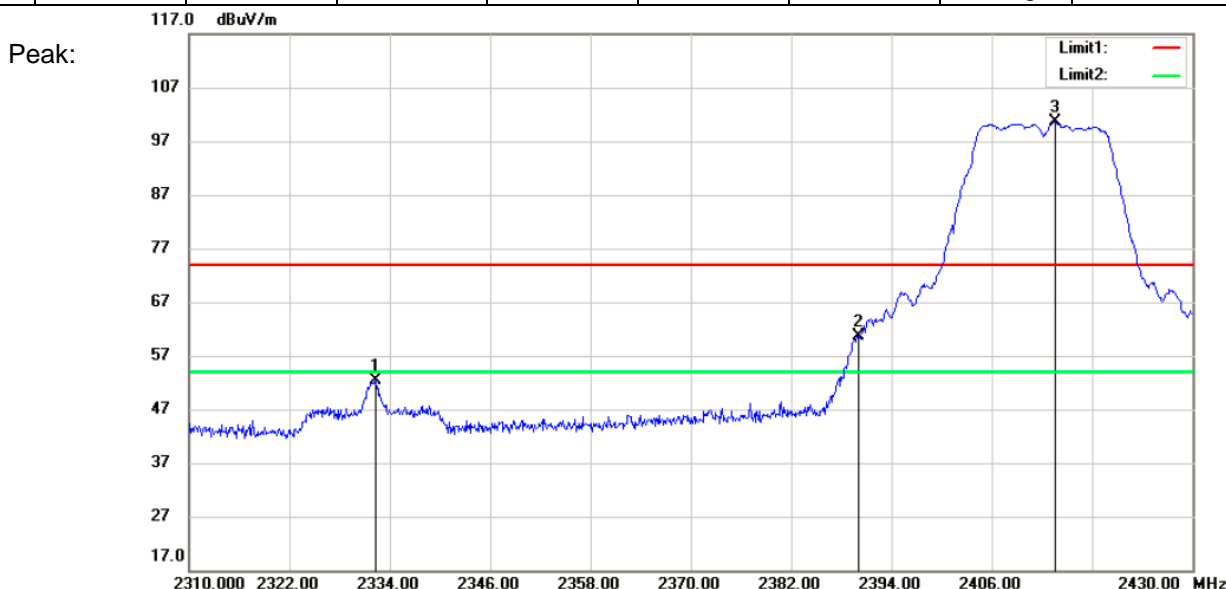

Test Mode: 802.11g

Channel: 2462

| MK. | Frequency (MHz) | Reading (dBuV/m) | Corrected factor(dB) | Result (dBuV/m) | Limit (dBuV/m) | Over Limit (dB) | Detector | Polarization |
|-----|-----------------|------------------|----------------------|-----------------|----------------|-----------------|----------|--------------|
| 1 | 2468.4 | 95.47 | -3.99 | 91.48 | 54 | 37.48 | Peak | Horizontal |
| 2 | 2483.5 | 44.62 | -4.01 | 40.61 | 54 | -13.39 | Peak | Horizontal |
| 3 | 2541.9 | 48.33 | -3.56 | 44.77 | 54 | -9.23 | Peak | Horizontal |

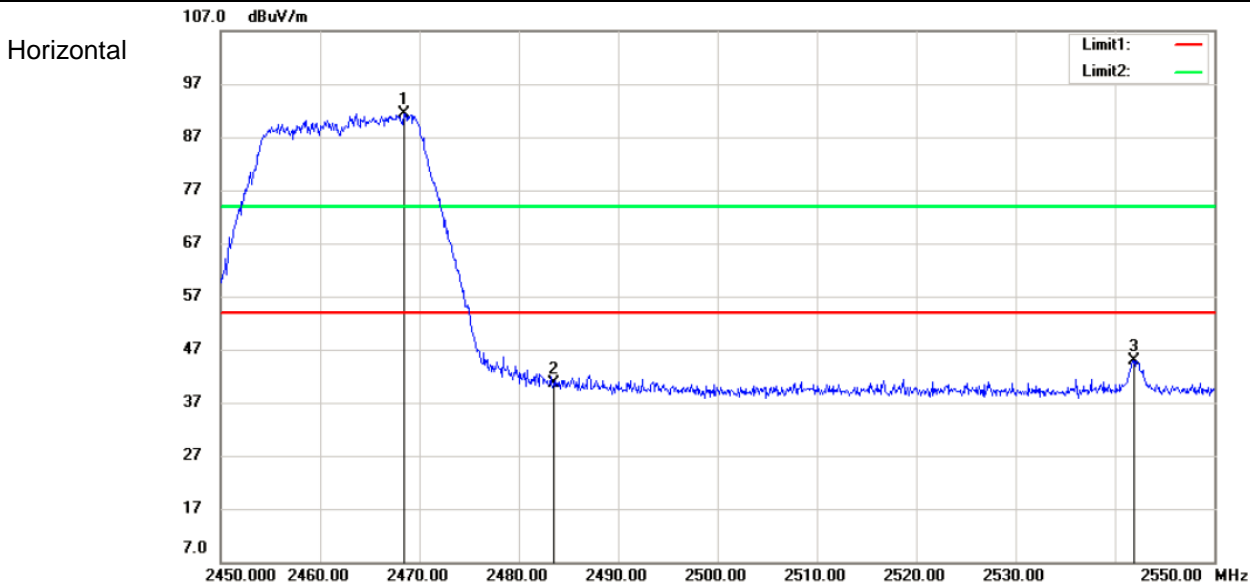

Test Mode: 802.11g

Channel: 2462

| MK. | Frequency (MHz) | Reading (dBuV/m) | Corrected factor(dB) | Result (dBuV/m) | Limit (dBuV/m) | Over Limit (dB) | Detector | Polarization |
|-----|-----------------|------------------|----------------------|-----------------|----------------|-----------------|----------|--------------|
| 1 | 2468.4 | 104.16 | -3.99 | 100.17 | 74 | 26.17 | Peak | Vertical |
| 2 | 2483.5 | 63.82 | -4.01 | 59.81 | 74 | -14.19 | Peak | Vertical |
| 3 | 2542.1 | 54.32 | -3.55 | 50.77 | 74 | -23.23 | Peak | Vertical |
| 1 | 2468.5 | 94.76 | -3.99 | 90.77 | 54 | 36.77 | Average | Vertical |
| 2 | 2483.5 | 47.6 | -4.01 | 43.59 | 54 | -10.41 | Average | Vertical |
| 3 | 2542 | 49.16 | -3.56 | 45.6 | 54 | -8.4 | Average | Vertical |

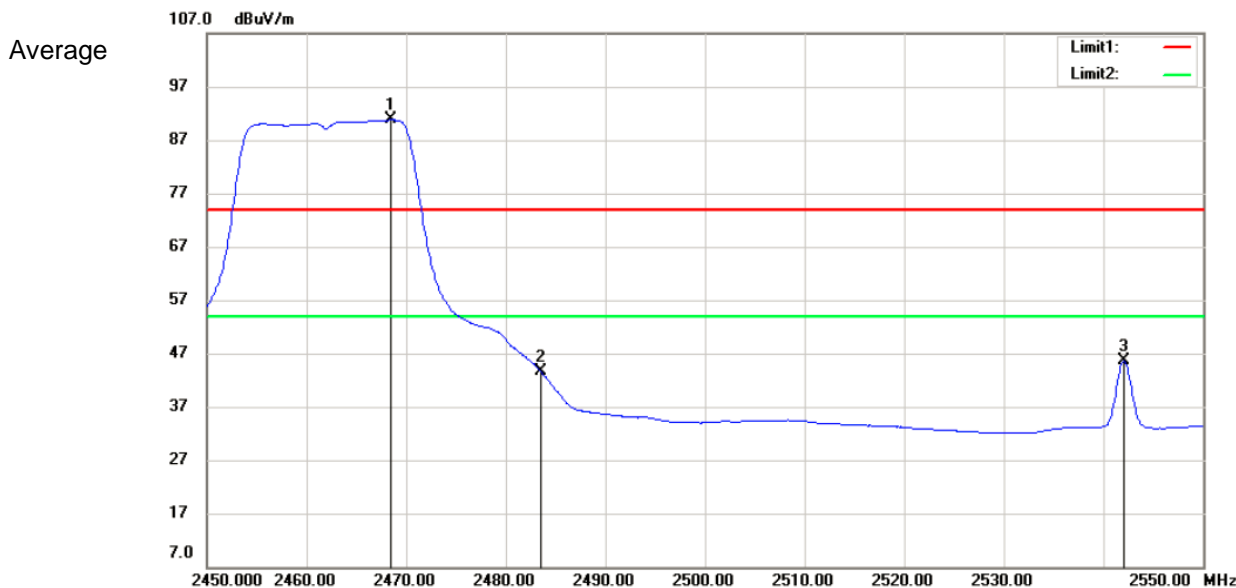
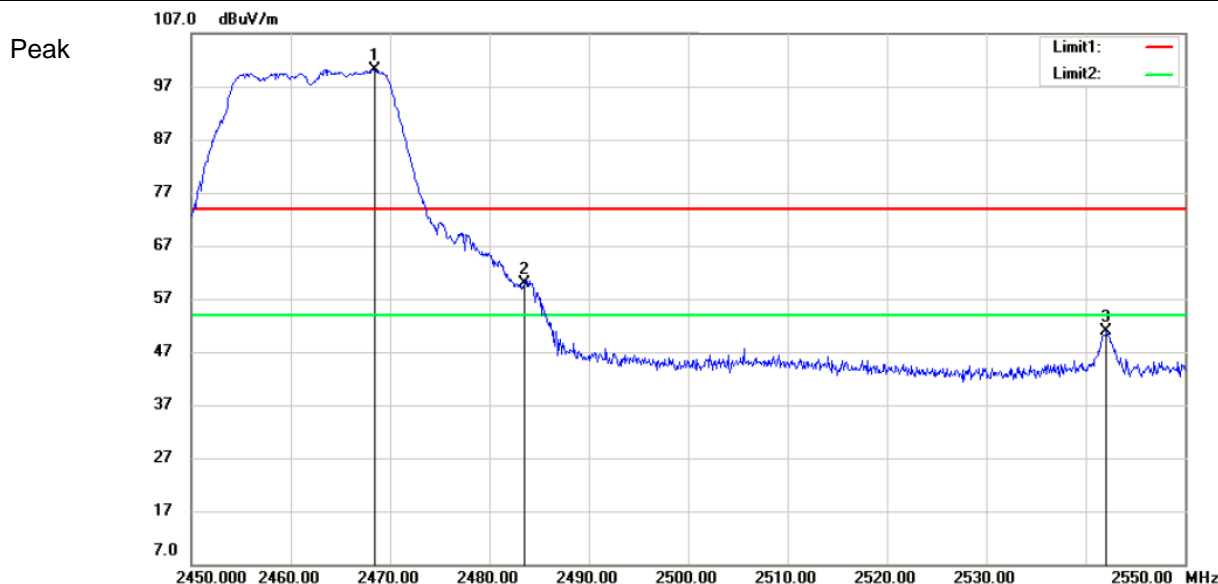



Test Mode: 802.11 n(HT20)

Channel: 2412

| MK. | Frequency (MHz) | Reading (dBuV/m) | Corrected factor(dB) | Result (dBuV/m) | Limit (dBuV/m) | Over Limit (dB) | Detector | Polarization |
|-----|-----------------|------------------|----------------------|-----------------|----------------|-----------------|----------|--------------|
| 1 | 2332.08 | 49.8 | -3.72 | 46.08 | 54 | -7.92 | Peak | Horizontal |
| 2 | 2390 | 44.51 | -3.89 | 40.62 | 54 | -13.38 | Peak | Horizontal |
| 3 | 2404.8 | 93.36 | -3.92 | 89.44 | 54 | 35.44 | Peak | Horizontal |

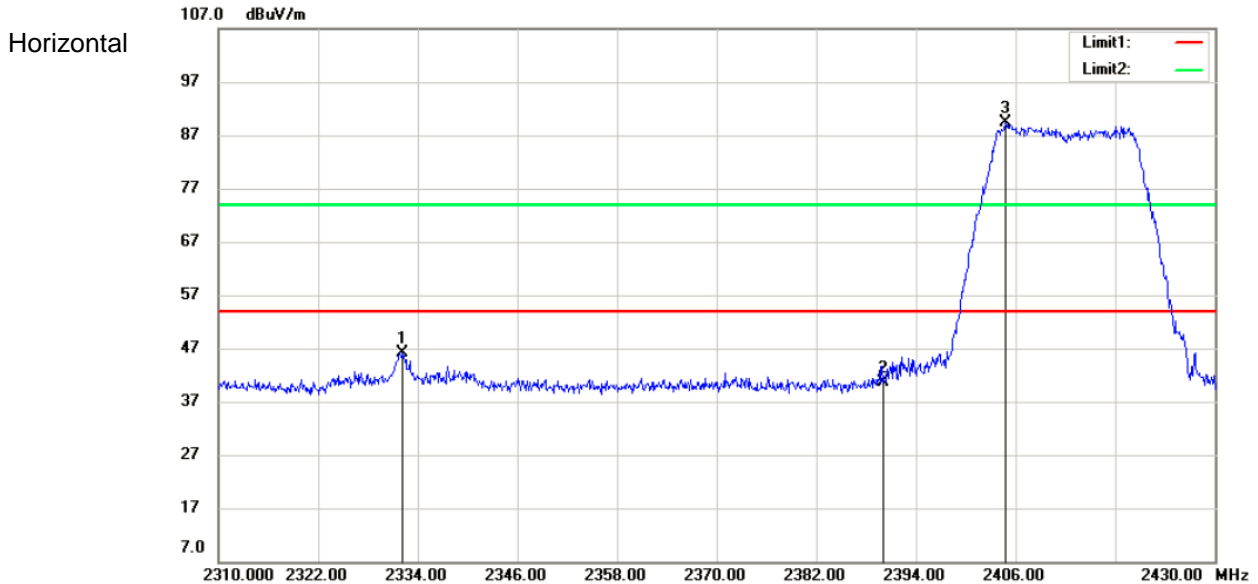

Test Mode: 802.11 n(HT20)

Channel: 2412

| MK. | Frequency (MHz) | Reading (dBuV/m) | Corrected factor(dB) | Result (dBuV/m) | Limit (dBuV/m) | Over Limit (dB) | Detector | Polarization |
|-----|-----------------|------------------|----------------------|-----------------|----------------|-----------------|----------|--------------|
| 1 | 2331.84 | 56.11 | -3.72 | 52.39 | 74 | -21.61 | Peak | Vertical |
| 2 | 2390 | 71.29 | -3.89 | 67.4 | 74 | -6.6 | Peak | Vertical |
| 3 | 2408.88 | 104.3 | -3.93 | 100.37 | 74 | 26.37 | Peak | Vertical |
| 1 | 2331.96 | 51.06 | -3.72 | 47.34 | 54 | -6.66 | Average | Vertical |
| 2 | 2390 | 48.61 | -3.89 | 44.72 | 54 | -9.28 | Average | Vertical |
| 3 | 2413.56 | 94.32 | -3.93 | 90.39 | 54 | 36.39 | Average | Vertical |

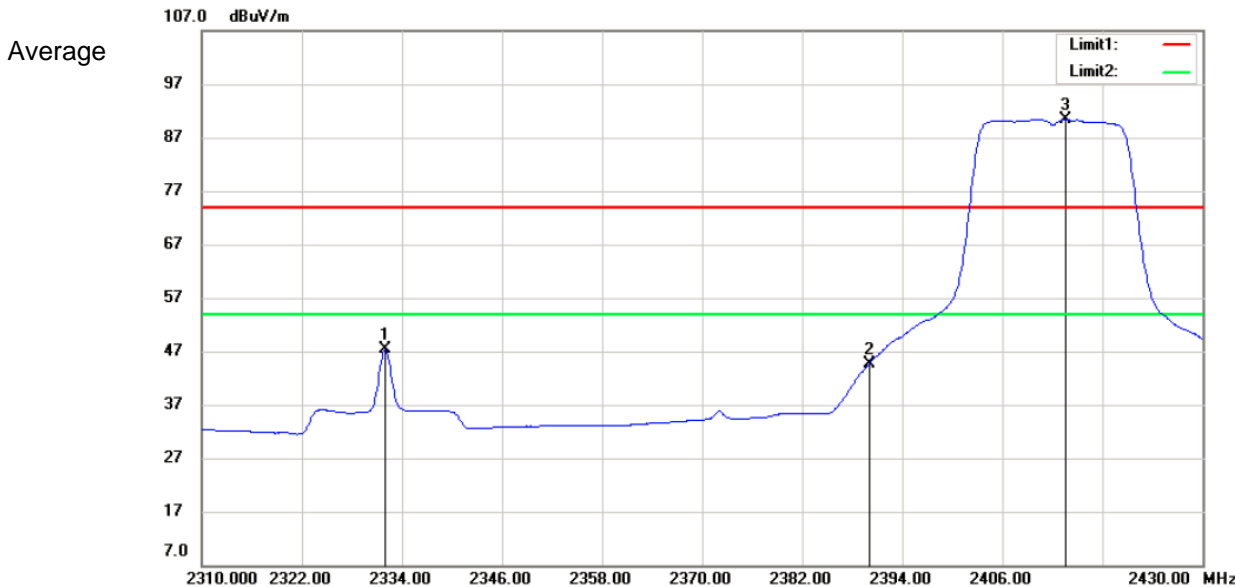
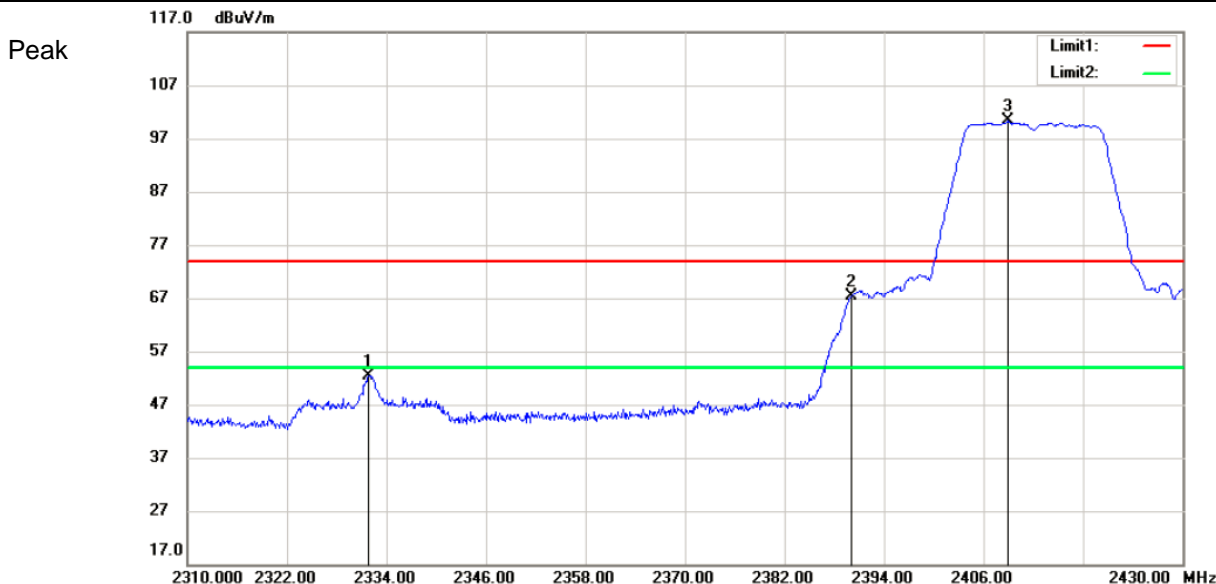

Test Mode: 802.11 n(HT20)

Channel: 2462

| MK. | Frequency (MHz) | Reading (dBuV/m) | Corrected factor(dB) | Result (dBuV/m) | Limit (dBuV/m) | Over Limit (dB) | Detector | Polarization |
|-----|-----------------|------------------|----------------------|-----------------|----------------|-----------------|----------|--------------|
| 1 | 2465.2 | 95.38 | -4 | 91.38 | 54 | 37.38 | Peak | Horizontal |
| 2 | 2483.5 | 46.16 | -4.01 | 42.15 | 54 | -11.85 | Peak | Horizontal |
| 3 | 2542.4 | 48.53 | -3.55 | 44.98 | 54 | -9.02 | Peak | Horizontal |

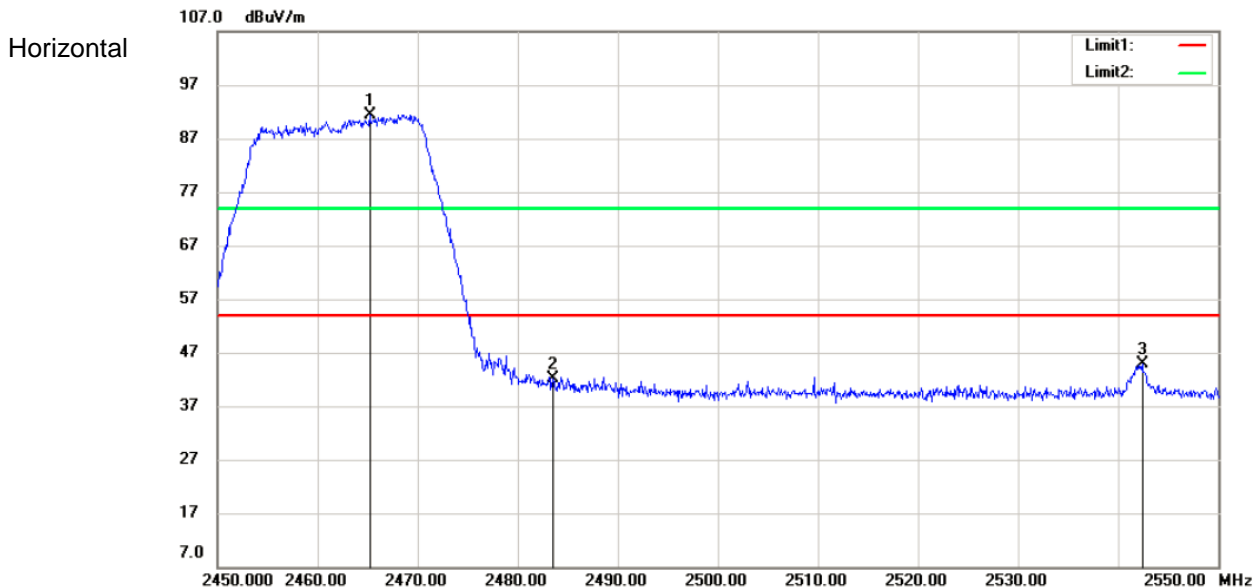

Test Mode: 802.11 n(HT20)

Channel: 2462

| MK. | Frequency (MHz) | Reading (dBuV/m) | Corrected factor(dB) | Result (dBuV/m) | Limit (dBuV/m) | Over Limit (dB) | Detector | Polarization |
|-----|-----------------|------------------|----------------------|-----------------|----------------|-----------------|----------|--------------|
| 1 | 2469.3 | 103.74 | -4 | 99.74 | 74 | 25.74 | Peak | Vertical |
| 2 | 2483.5 | 68.09 | -4.01 | 64.08 | 74 | -9.92 | Peak | Vertical |
| 3 | 2542.2 | 53.53 | -3.55 | 49.98 | 74 | -24.02 | Peak | Vertical |
| 1 | 2467.6 | 94.08 | -4 | 90.08 | 54 | 36.08 | Average | Vertical |
| 2 | 2483.5 | 48.67 | -4.01 | 44.66 | 54 | -9.34 | Average | Vertical |
| 3 | 2542 | 48.75 | -3.56 | 45.19 | 54 | -8.81 | Average | Vertical |

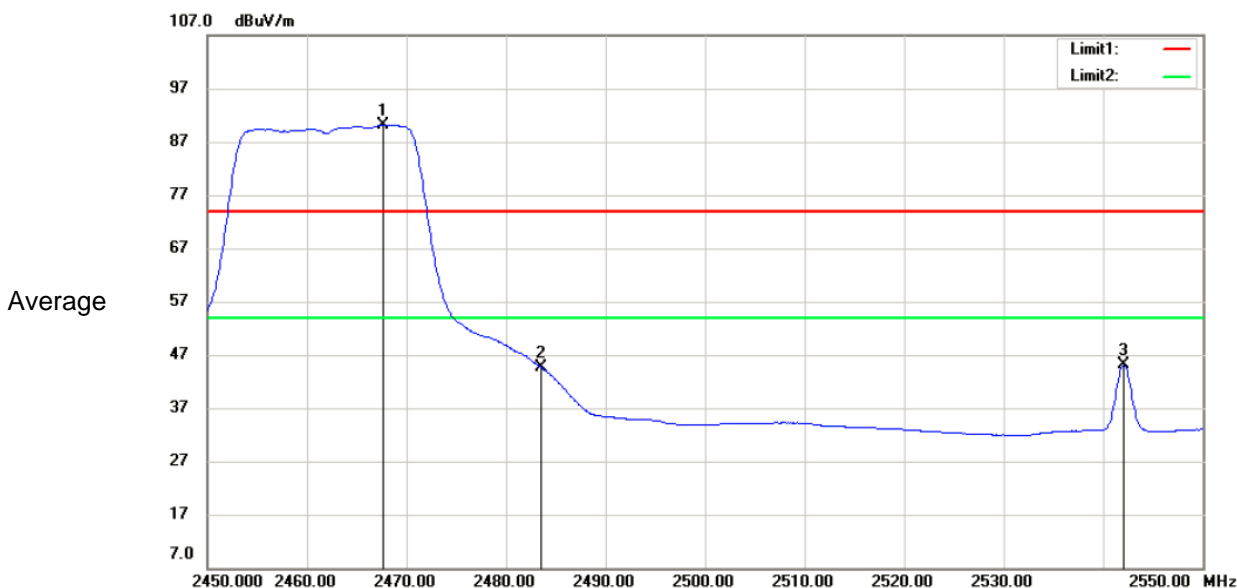
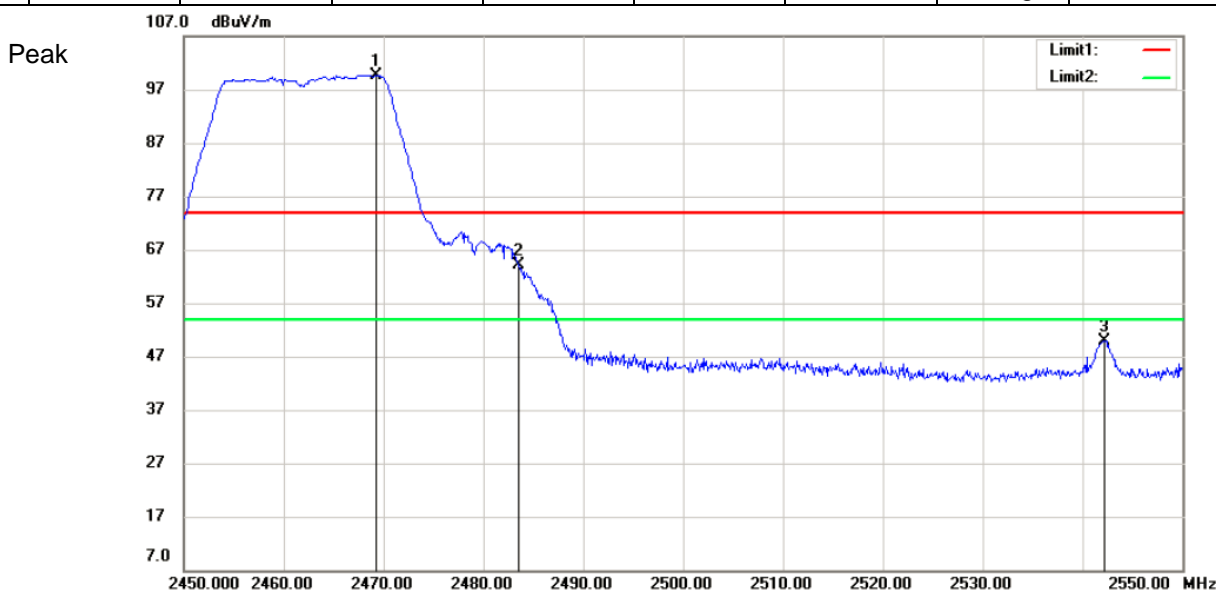

Test Mode: 802.11 n(HT40)

Channel: 2422

| MK. | Frequency (MHz) | Reading (dBuV/m) | Corrected factor(dB) | Result (dBuV/m) | Limit (dBuV/m) | Over Limit (dB) | Detector | Polarization |
|-----|-----------------|------------------|----------------------|-----------------|----------------|-----------------|----------|--------------|
| 1 | 2389.1 | 49.57 | -3.89 | 45.68 | 54 | -8.32 | Peak | Horizontal |
| 2 | 2390 | 44.06 | -3.89 | 40.17 | 54 | -13.83 | Peak | Horizontal |
| 3 | 2428.72 | 89.81 | -3.95 | 85.86 | 54 | 31.86 | Peak | Horizontal |

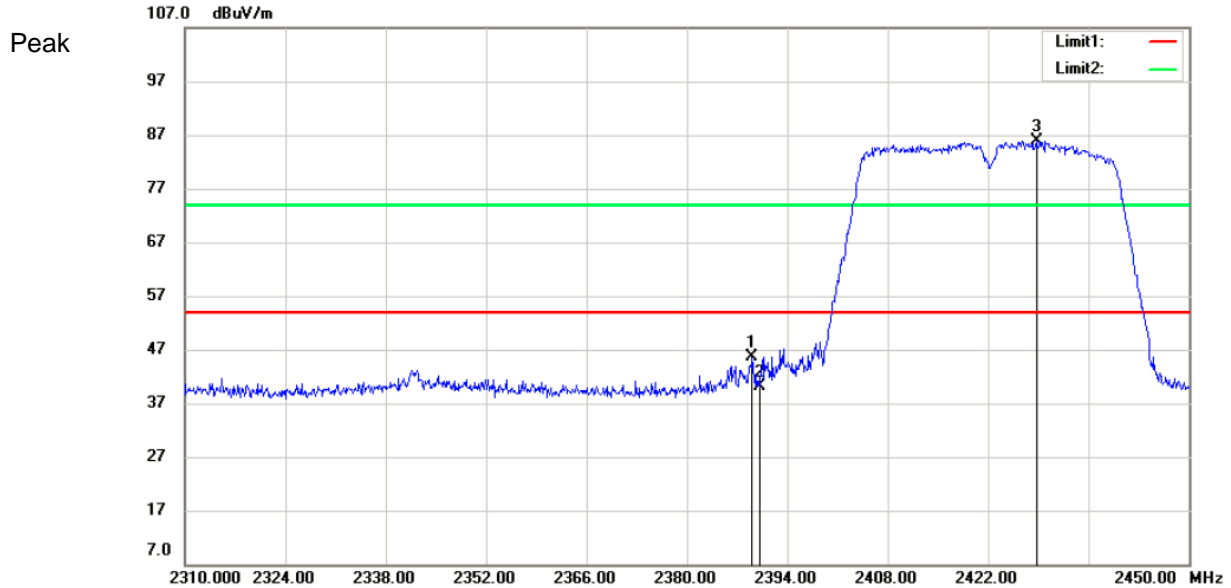

Test Mode: 802.11 n(HT40)

Channel: 2422

| MK. | Frequency (MHz) | Reading (dBuV/m) | Corrected factor(dB) | Result (dBuV/m) | Limit (dBuV/m) | Over Limit (dB) | Detector | Polarization |
|-----|-----------------|------------------|----------------------|-----------------|----------------|-----------------|----------|--------------|
| 1 | 2388.82 | 70.42 | -3.89 | 66.53 | 74 | -7.47 | Peak | Vertical |
| 2 | 2390 | 68.01 | -3.89 | 64.12 | 74 | -9.88 | Peak | Vertical |
| 3 | 2430.96 | 101.24 | -3.95 | 97.29 | 74 | 23.29 | Peak | Vertical |
| 1 | 2341.92 | 44.87 | -3.74 | 41.13 | 54 | -12.87 | Average | Vertical |
| 2 | 2390 | 54.2 | -3.89 | 50.31 | 54 | -3.69 | Average | Vertical |
| 3 | 2413.46 | 91.83 | -3.93 | 87.9 | 54 | 33.9 | Average | Vertical |

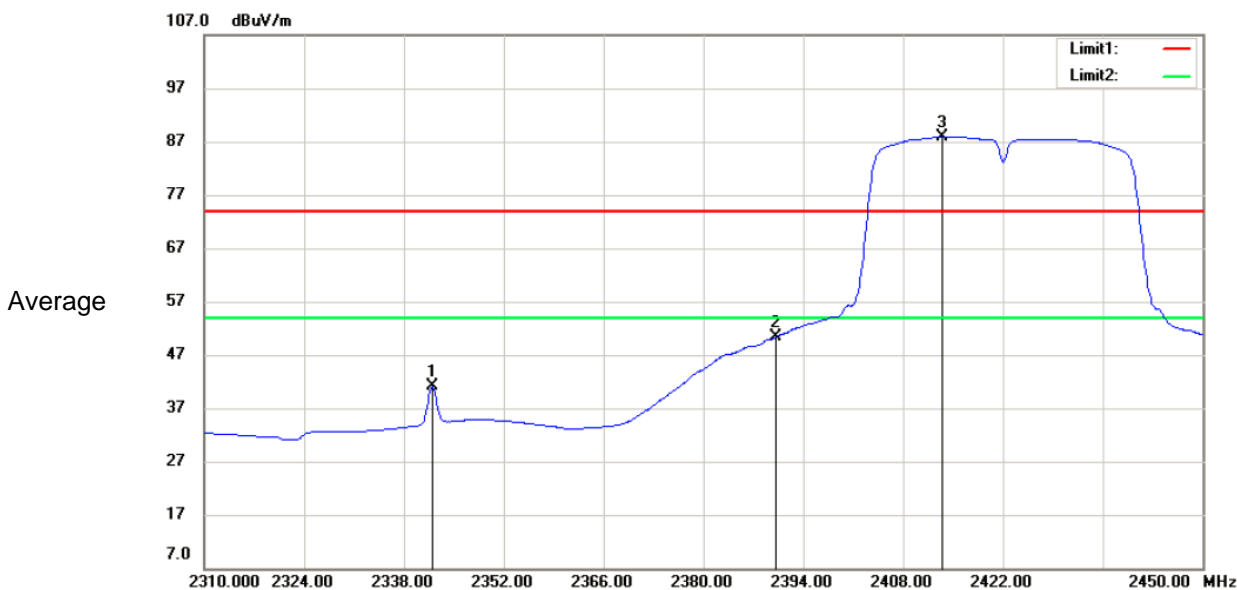
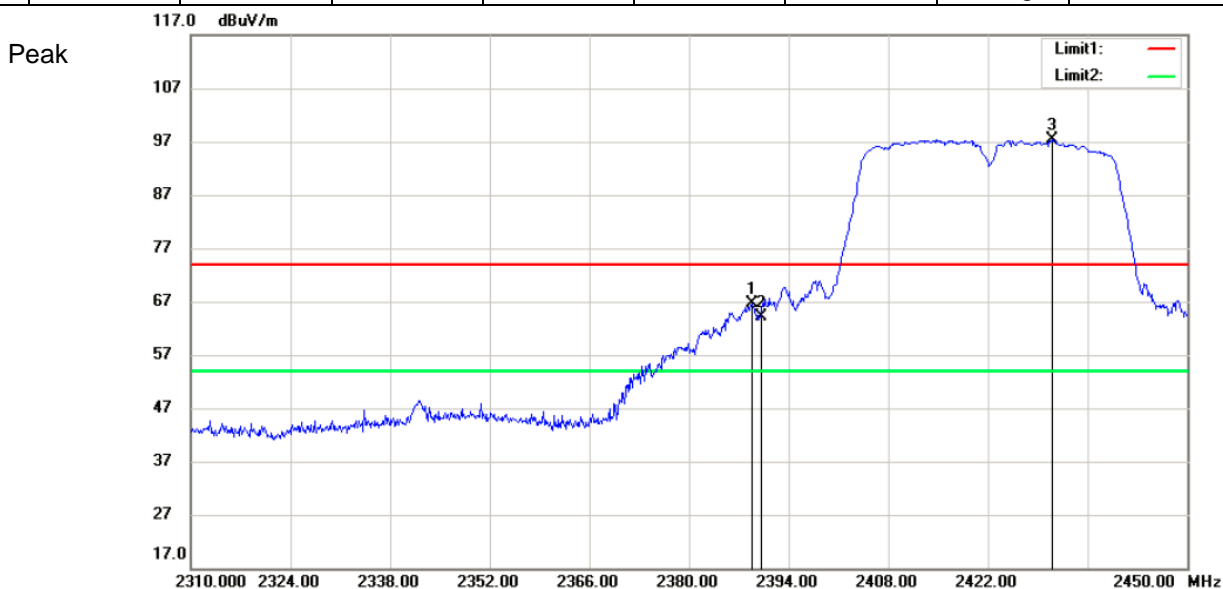



Test Mode: 802.11 n(HT40)

Channel: 2452

| MK. | Frequency (MHz) | Reading (dBuV/m) | Corrected factor(dB) | Result (dBuV/m) | Limit (dBuV/m) | Over Limit (dB) | Detector | Polarization |
|-----|-----------------|------------------|----------------------|-----------------|----------------|-----------------|----------|--------------|
| 1 | 2464.08 | 92.3 | -3.99 | 88.31 | 54 | 34.31 | Peak | Horizontal |
| 2 | 2483.5 | 46.05 | -4.01 | 42.04 | 54 | -11.96 | Peak | Horizontal |
| 3 | 2531.88 | 46.36 | -3.67 | 42.69 | 54 | -11.31 | Peak | Horizontal |

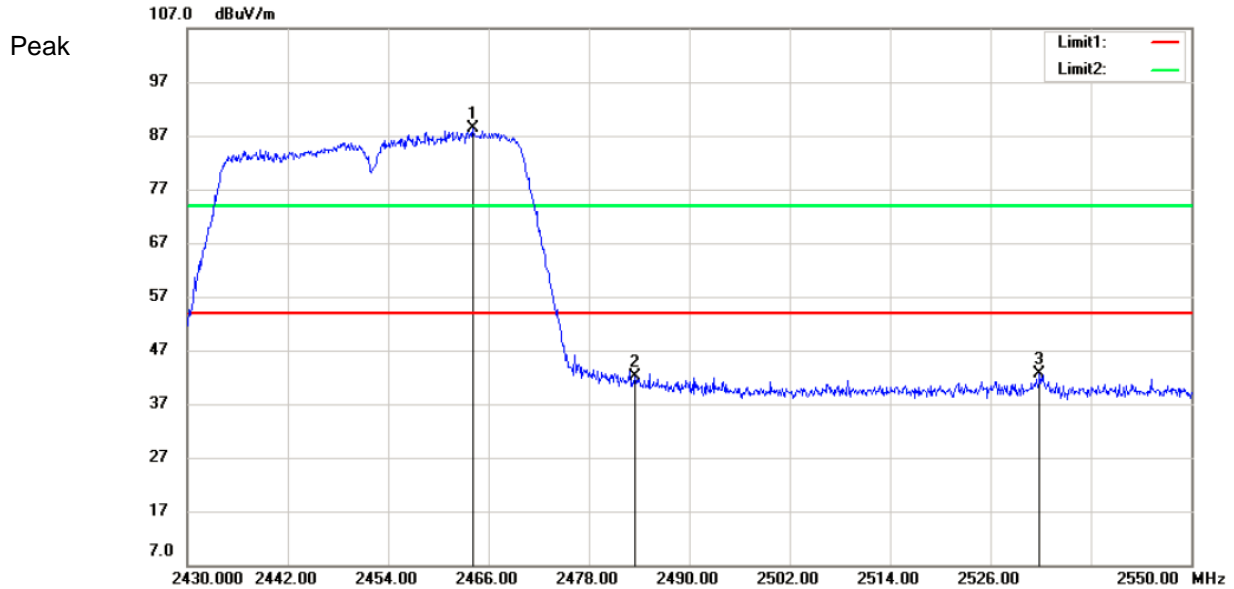

Test Mode: 802.11 n(HT40)

Channel: 2452

| MK. | Frequency (MHz) | Reading (dBuV/m) | Corrected factor(dB) | Result (dBuV/m) | Limit (dBuV/m) | Over Limit (dB) | Detector | Polarization |
|-----|-----------------|------------------|----------------------|-----------------|----------------|-----------------|----------|--------------|
| 1 | 2454.96 | 101.15 | -3.98 | 97.17 | 74 | 23.17 | Peak | Vertical |
| 2 | 2483.5 | 66.79 | -4.01 | 62.78 | 74 | -11.22 | Peak | Vertical |
| 3 | 2487.24 | 68.16 | -4.02 | 64.14 | 74 | -9.86 | Peak | Vertical |
| 1 | 2447.4 | 91.41 | -3.97 | 87.44 | 54 | 33.44 | Average | Vertical |
| 2 | 2483.5 | 53.28 | -4.01 | 49.27 | 54 | -4.73 | Average | Vertical |
| 3 | 2532 | 41.27 | -3.67 | 37.6 | 54 | -16.4 | Average | Vertical |

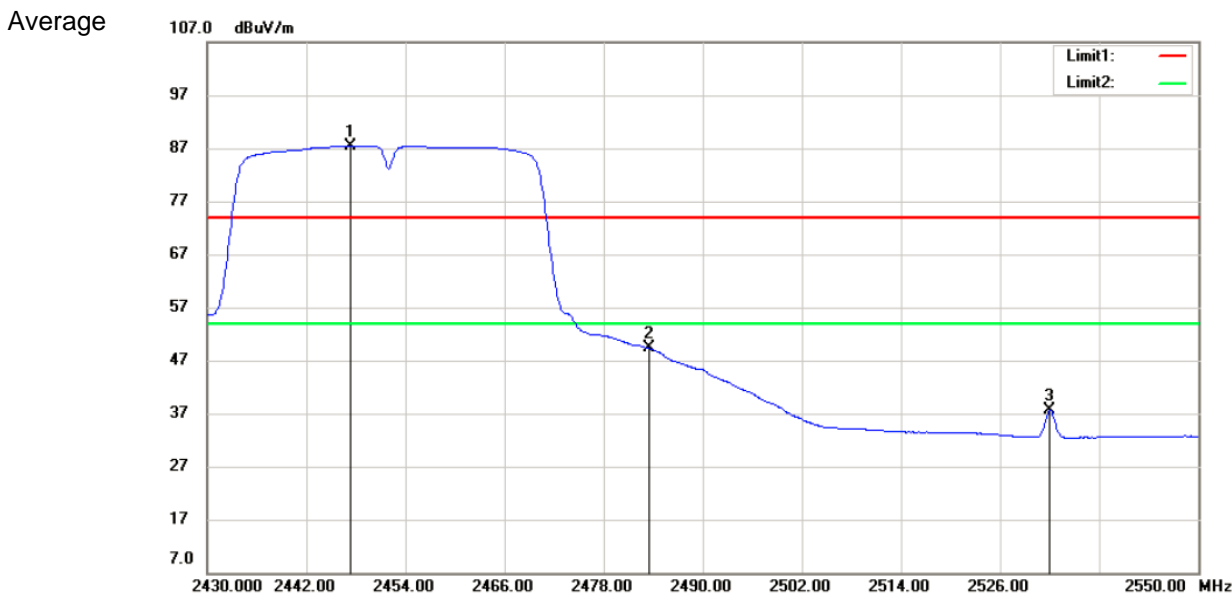
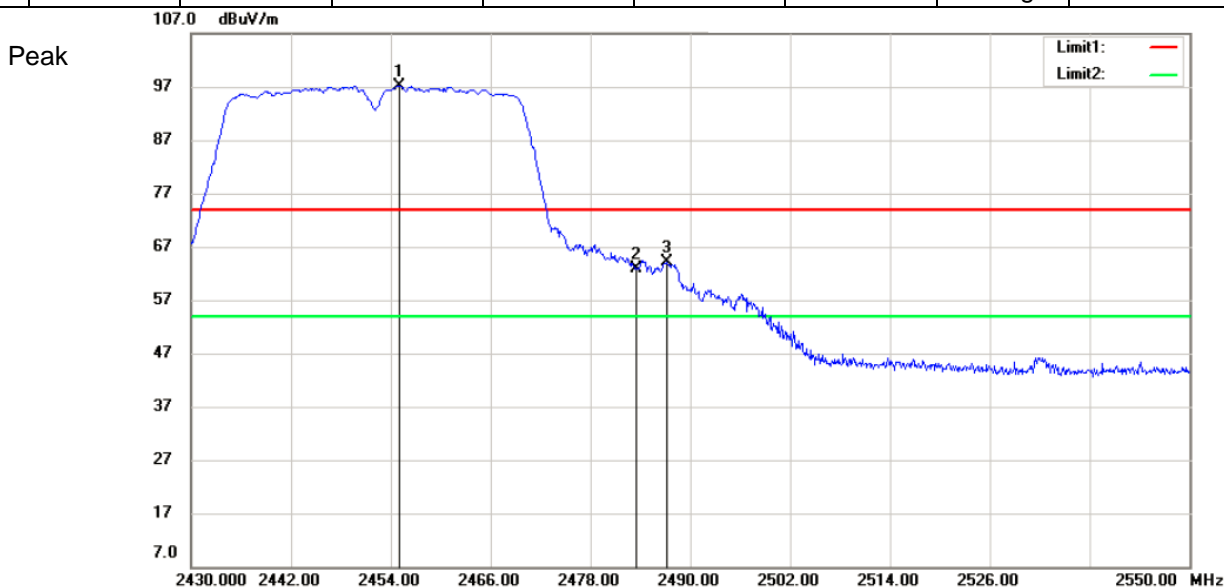



Remark: 1). Test Result = Receiver Reading + Corrected factor

Corrected factor= Antenna Factor + Cable Loss- Preamplifier Factor

2). If the Peak value below the AV Limit, the AV test doesn't perform for this submission.

All frequencies within the "Restricted bands" have been evaluated to compliance. Except as shown in paragraph of this section, only spurious emissions are permitted in any of the frequency bands listed below:

a. FCC Part 15, Subpart C Section 15.205 Restricted bands of operation.

| MHz | MHz | MHz | GHz |
|---------------------|-----------------------|-----------------|---------------|
| 0.090 - 0.110 | 16.42 - 16.423 | 399.9 - 410 | 4.5 - 5.15 |
| 10.495 - 0.505 | 16.69475 - 16.69525 | 608 - 614 | 5.35 - 5.46 |
| 2.1735 - 2.1905 | 16.80425 - 16.80475 | 960 - 1240 | 7.25 - 7.75 |
| 4.125 - 4.128 | 25.5 - 25.67 | 1300 - 1427 | 8.025 - 8.5 |
| 4.17725 - 4.17775 | 37.5 - 38.25 | 1435 - 1626.5 | 9.0 - 9.2 |
| 4.20725 - 4.20775 | 73 - 74.6 | 1645.5 - 1646.5 | 9.3 - 9.5 |
| 6.215 - 6.218 | 74.8 - 75.2 | 1660 - 1710 | 10.5 - 12.7 |
| 6.26775 - 6.26825 | 108 - 121.94 | 1718.8 - 1722.2 | 13.25 - 13.4 |
| 6.31175 - 6.31225 | 123 - 138 | 2200 - 2300 | 14.47 - 14.5 |
| 8.291 - 8.294 | 149.9 - 150.05 | 2310 - 2390 | 15.35 - 16.2 |
| 8.362 - 8.366 | 156.52475 - 156.52525 | 2483.5 - 2500 | 17.7 - 21.4 |
| 8.37625 - 8.38675 | 156.7 - 156.9 | 2655 - 2900 | 22.01 - 23.12 |
| 8.41425 - 8.41475 | 162.0125 - 167.17 | 3260 - 3267 | 23.6 - 24.0 |
| 12.29 - 12.293 | 167.72 - 173.2 | 3332 - 3339 | 31.2 - 31.8 |
| 12.51975 - 12.52025 | 240 - 285 | 3345.8 - 3358 | 36.43 - 36.5 |
| 12.57675 - 12.57725 | 322 - 335.4 | 3600 - 4400 | |
| 13.36 - 13.41 | | | |



7 Test Setup Photographs

Refer to the < Test Setup photos-FCC>.

8 EUT Constructional Details

Refer to the < External Photos > & < Internal Photos >.

--End of the Report--