



Test Report No.: RF170829W003-7



# FCC TEST REPORT (PART 27)

**Product:** LTE Mobile Phone

**Model Name:** M721L

**FCC ID:** 2ANQ6-M721L

**Applicant:** Meizu Technology Co., Ltd.

**Address:** Meizu Tech Bldg., Technology & Innovation Coast, Zhuhai,  
Guangdong Province, China

**Manufacturer:** Meizu Technology Co., Ltd.

**Address:** Meizu Tech Bldg., Technology & Innovation Coast, Zhuhai,  
Guangdong Province, China

**Prepared by:** BV 7Layers Communications Technology (Shenzhen) Co. Ltd

**Lab Location:** No.B102, Dazu Chuangxin Mansion, North of Beihuan Avenue,  
North Area, Hi-Tech Industrial Park, Nanshan District, Shenzhen,  
Guangdong, China

**TEL:** +86 755 8869 6566

**FAX:** +86 755 8869 6577

**E-MAIL:** [customerservice.dg@cn.bureauveritas.com](mailto:customerservice.dg@cn.bureauveritas.com)

**Report No.:** RF170829W003-7

**Received Date:** Sep. 26, 2017

**Test Date:** Oct. 08, 2017 ~ Oct. 31, 2017

**Issued Date:** Nov. 01, 2017

This report should not be used by the client to claim product certification, approval, or endorsement by A2LA or any government agencies.

This report is for your exclusive use. Any copying or replication of this report to or for any other person or entity, or use of our name or trademark, is permitted only with our prior written permission. This report sets forth our findings solely with respect to the test samples identified herein. The results set forth in this report are not indicative or representative of the quality or characteristics of the lot from which a test sample was taken or any similar or identical product unless specifically and expressly noted. Our report includes all of the tests requested by you and the results thereof based upon the information that you provided to us. You have 60 days from date of issuance of this report to notify us of any material error or omission caused by our negligence, provided, however, that such notice shall be in writing and shall specifically address the issue you wish to raise. A failure to raise such issue within the prescribed time shall constitute your unqualified acceptance of the completeness of this report, the tests conducted and the correctness of the report contents. Unless specific mention, the uncertainty of measurement has been explicitly taken into account to declare the compliance or non-compliance to the specification



# TABLE OF CONTENTS

**RELEASE CONTROL RECORD ..... 4**

**1 CERTIFICATION..... 5**

**2 SUMMARY OF TEST RESULTS..... 6**

2.1 MEASUREMENT UNCERTAINTY ..... 6

2.2 TEST SITE AND INSTRUMENTS ..... 7

**3 GENERAL INFORMATION ..... 8**

3.1 GENERAL DESCRIPTION OF EUT ..... 8

3.2 CONFIGURATION OF SYSTEM UNDER TEST ..... 10

3.3 DESCRIPTION OF SUPPORT UNITS ..... 11

3.4 TEST ITEM AND TEST CONFIGURATION..... 11

3.5 GENERAL DESCRIPTION OF APPLIED STANDARDS ..... 13

**4 TEST TYPES AND RESULTS ..... 14**

4.1 OUTPUT POWER MEASUREMENT ..... 14

4.1.1 LIMITS OF OUTPUT POWER MEASUREMENT ..... 14

4.1.2 TEST PROCEDURES ..... 14

4.1.3 TEST SETUP ..... 15

4.1.4 TEST RESULTS..... 16

4.2 FREQUENCY STABILITY MEASUREMENT ..... 21

4.2.1 LIMITS OF FREQUENCY STABILITY MEASUREMENT ..... 21

4.2.2 TEST PROCEDURE ..... 21

4.2.3 TEST SETUP ..... 21

4.2.4 TEST RESULTS..... 22

4.3 OCCUPIED BANDWIDTH MEASUREMENT ..... 26

4.3.1 LIMITS OF OCCUPIED BANDWIDTH MEASUREMENT ..... 26

4.3.2 TEST SETUP ..... 26

4.3.3 TEST PROCEDURES ..... 26

4.3.4 TEST RESULTS..... 27

4.4 PEAK TO AVERAGE RATIO..... 29

4.4.1 LIMITS OF PEAK TO AVERAGE RATIO MEASUREMENT ..... 29

4.4.2 TEST SETUP ..... 29

4.4.3 TEST PROCEDURES ..... 29

4.4.4 TEST RESULTS..... 30

4.5 BAND EDGE MEASUREMENT ..... 32

4.5.1 LIMITS OF BAND EDGE MEASUREMENT ..... 32

4.5.2 TEST SETUP ..... 32

4.5.3 TEST PROCEDURES ..... 33

4.5.4 TEST RESULTS..... 34

4.6 CONDUCTED SPURIOUS EMISSIONS..... 38

4.6.1 LIMITS OF CONDUCTED SPURIOUS EMISSIONS MEASUREMENT ..... 38

4.6.2 TEST PROCEDURE ..... 38

4.6.3 TEST SETUP ..... 38

4.6.4 TEST RESULTS..... 39

4.7 RADIATED EMISSION MEASUREMENT ..... 43

4.7.1 LIMITS OF RADIATED EMISSION MEASUREMENT ..... 43

4.7.2 TEST PROCEDURES ..... 43

4.7.3 DEVIATION FROM TEST STANDARD..... 43



**BUREAU  
VERITAS**

**Test Report No.: RF170829W003-7**

4.7.4	TEST SETUP .....	44
4.7.5	TEST RESULTS.....	45
<b>5</b>	<b>INFORMATION ON THE TESTING LABORATORIES .....</b>	<b>59</b>
<b>6</b>	<b>APPENDIX A – MODIFICATIONS RECORDERS FOR ENGINEERING CHANGES TO THE EUT BY THE LAB .....</b>	<b>60</b>



Test Report No.: RF170829W003-7

## RELEASE CONTROL RECORD

ISSUE NO.	REASON FOR CHANGE	DATE ISSUED
RF170829W003-7	Original release	Nov. 01, 2017



Test Report No.: RF170829W003-7

# 1 CERTIFICATION

**PRODUCT:** LTE Mobile Phone  
**BRAND NAME:** MEIZU  
**MODEL NAME:** M721L  
**APPLICANT:** Meizu Technology Co., Ltd.  
**TESTED:** Oct. 08, 2017 ~ Oct. 31, 2017  
**TEST SAMPLE:** Production Unit  
**STANDARDS:** **FCC Part 27, Subpart C, M**  
**FCC Part 2**  
ANSI /TIA/EIA-603-D  
ANSI/TIA/EIA-603-E

The above equipment has been tested by **BV 7Layers Communications Technology (Shenzhen) Co. Ltd** and found compliance with the requirement of the above standards. The test record, data evaluation & Equipment Under Test (EUT) configurations represented herein are true and accurate accounts of the measurements of the sample's EMC characteristics under the conditions specified in this report.

**PREPARED BY :** Yuqiang Yin, **DATE:** Nov. 01, 2017  
(Yuqiang Yin/ Engineer)

**APPROVED BY :** Bill Yao, **DATE:** Nov. 01, 2017  
( Bill Yao / Manager)

## 2 SUMMARY OF TEST RESULTS

The EUT has been tested according to the following specifications:

APPLIED STANDARD: FCC Part 27 & Part 2			
STANDARD SECTION	TEST TYPE AND LIMIT	RESULT	REMARK
2.1046 27.50(h)(2)	Equivalent Isotropically Radiated Power	PASS	Meet the requirement of limit.
2.1055 27.54	Frequency Stability	PASS	Meet the requirement of limit.
2.1049 27.53(m)(6)	Occupied Bandwidth	PASS	Meet the requirement of limit.
27.50(d)(5)	Peak to average ratio	PASS	Meet the requirement of limit.
2.1051 27.53(m)(4)(6)	Band Edge Measurements	PASS	Meet the requirement of limit.
2.1051 27.53(m)(4)(6)	Conducted Spurious Emissions	PASS	Meet the requirement of limit.
2.1053 27.53(m)(4)(6)	Radiated Spurious Emissions	PASS	Meet the requirement of limit. Minimum passing margin is -15.92dB at 47.46MHz.

### 2.1 MEASUREMENT UNCERTAINTY

Where relevant, the following measurement uncertainty levels have been estimated for tests performed on the EUT as specified in CISPR 16-4-2:

MEASUREMENT	FREQUENCY	UNCERTAINTY
Conducted emissions	9kHz~30MHz	2.66dB
Radiated emissions	9KHz ~ 30MHz	2.68dB
	30MHz ~ 1GMHz	3.26dB
	1GHz ~ 18GHz	4.48dB
	18GHz ~ 40GHz	4.12dB

This uncertainty represents an expanded uncertainty expressed at approximately the 95% confidence level using a coverage factor of k=2.



**BUREAU  
VERITAS**

Test Report No.: RF170829W003-7

## 2.2 TEST SITE AND INSTRUMENTS

Equipment	Manufacturer	Model No.	Serial No.	Last Cal.	Next Cal.
MXE EMI Receiver	KEYSIGHT	N9038A-544	MY54450026	Mar. 01,17	Feb. 28,18
EXA Signal Analyzer	KEYSIGHT	N9010A-544	MY54510332	Mar. 01,17	Feb. 28,18
Bilog Antenna 1	ETS-LINDGREN	3143B	00161964	Nov. 26,16	Nov. 25,18
Bilog Antenna 2	ETS-LINDGREN	3143B	00161965	Nov. 26,16	Nov. 25,18
Horn Antenna 1	ETS-LINDGREN	3117	00168728	Nov. 26,16	Nov. 25,18
Horn Antenna 2	ETS-LINDGREN	3117	00168692	Nov. 26,16	Nov. 25,18
Loop antenna	Daze	ZN30900A	0708	Nov. 28,16	Nov. 27,17
Horn Antenna (18GHz-40GHz)	N/A	QWH-SL-18-40 -K-SG/QMS-00 361	15433	Dec. 16,16	Dec. 15,17
Radio Communication Analyzer	ANRITSU	MT8820C	6201465426	Mar. 01,17	Feb. 28,18
Signal Pre-Amplifier	EMSI	EMC 9135	980249	Jul. 24,17	Jul. 23,18
Signal Pre-Amplifier	EMSI	EMC 012645B	980257	Jul. 24,17	Jul. 23,18
Signal Pre-Amplifier	EMSI	EMC 184045B	980259	Jul. 24,17	Jul. 23,18
3m Semi-anechoic Chamber	ETS-LINDGREN	9m*6m*6m	Euroshieldpn- CT0001143-1216	May 06,17	May 05,18
Test Software	E3	V 9.160323	N/A	N/A	N/A
Test Software	ADT	ADT_Radiated _V7.6.15.9.2	N/A	N/A	N/A
10dB Attenuator	JFW/USA	50HF-010-SM A	1505	Jul. 24,17	Jul. 23,18
Power Meter	Anritsu	ML2495A	1506002	Mar. 01,17	Feb. 28,18
Power Sensor	Anritsu	MA2411B	1339352	Mar. 01,17	Feb. 28,18
Humid & Temp Programmable Tester	Juyi	ITH-120-45-CP -AR	IAA1504-001	Jul. 18,17	Jul. 17,18
MXG Analog Microvave Signal Generator	KEYSIGHT	N5183A	MY50143024	Mar. 01,17	Feb. 28,18

- NOTE:**
1. The calibration interval of the above test instruments is 12 months or 24 months and the calibrations are traceable to CEPREI/CHINA, GRGT/CHINA and NIM/CHINA.
  2. The test was performed in 3m Semi-anechoic Chamber and RF Oven Room.
  3. The horn antenna is used only for the measurement of emission frequency above 1GHz if tested.
  4. The FCC Site Registration No. is 525120.

### 3 GENERAL INFORMATION

#### 3.1 GENERAL DESCRIPTION OF EUT

<b>PRODUCT</b>	LTE Mobile Phone	
<b>MODEL NAME</b>	M721L	
<b>POWER SUPPLY</b>	5.0Vdc (adapter or host equipment) 3.85Vdc (Li-ion, battery)	
<b>MODULATION TECHNOLOGY</b>	LTE Band 7	QPSK, 16QAM
<b>FREQUENCY RANGE</b>	LTE Band 7 Channel Bandwidth: 5MHz	2502.5MHz ~ 2567.5MHz
	LTE Band 7 Channel Bandwidth: 10MHz	2505MHz ~ 2565MHz
	LTE Band 7 Channel Bandwidth: 15MHz	2507.5MHz ~ 2562.5MHz
	LTE Band 7 Channel Bandwidth: 20MHz	2510MHz ~ 2560MHz
<b>EMISSION DESIGNATOR</b>	LTE Band 7 Channel Bandwidth: 5MHz	QPSK: 4M48G7D
		16QAM: 4M47W7D
	LTE Band 7 Channel Bandwidth: 10MHz	QPSK: 8M94G7D
		16QAM: 8M94W7D
	LTE Band 7 Channel Bandwidth: 15MHz	QPSK: 13M4G7D
		16QAM: 13M4W7D
	LTE Band 7 Channel Bandwidth: 20MHz	QPSK: 17M9G7D
		16QAM: 17M8W7D
<b>MAX. EIRP POWER</b>	LTE Band 7 Channel Bandwidth: 5MHz	112mW
	LTE Band 7 Channel Bandwidth: 10MHz	121mW
	LTE Band 7 Channel Bandwidth: 15MHz	127mW
	LTE Band 7 Channel Bandwidth: 20MHz	107mW
<b>ANTENNA TYPE</b>	Fixed Internal Antenna with 3.69dBi	
<b>HW VERSION</b>	V1.0	
<b>SW VERSION</b>	Flyme 6.1.4.0G	
<b>I/O PORTS</b>	Refer to user's manual	
<b>DATA CABLE</b>	USB cable: non-shielded, detachable, 1.0meter	

**NOTE:**

- For a more detailed features description, please refer to the manufacturer's specifications or the user's manual.





**BUREAU  
VERITAS**

**Test Report No.: RF170829W003-7**

2. The EUT was powered by the following adapter:

<b>ADAPTER</b>	
<b>BRAND:</b>	DONGGUAN AOHAI POWER TECHNOLOGY CO,LTD.
<b>MODEL:</b>	UP1220A
<b>INPUT:</b>	AC 100-240V, 700mA
<b>OUTPUT:</b>	DC 5V/9V/12V, 2000mA

3. The EUT matched the following USB cable:

<b>USB CABLE</b>	
<b>BRAND:</b>	N/A
<b>MODEL:</b>	K96092AA1
<b>SIGNAL LINE:</b>	1.0 METER

4. For the test results, the EUT had been tested with all conditions. But only the worst case was shown in test report.

### 3.2 CONFIGURATION OF SYSTEM UNDER TEST

#### FOR RADIATION EMISSION TEST

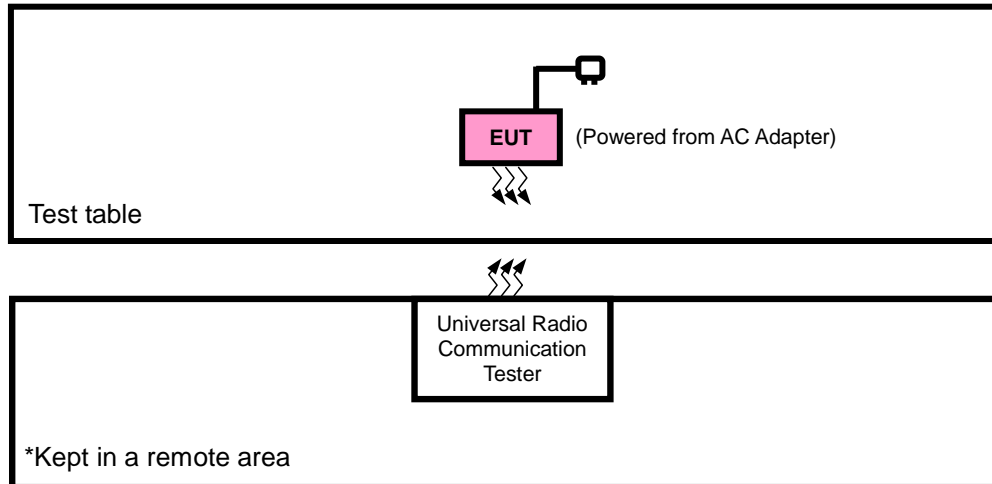

#### FOR CONDUCTED & E.I.R.P TEST

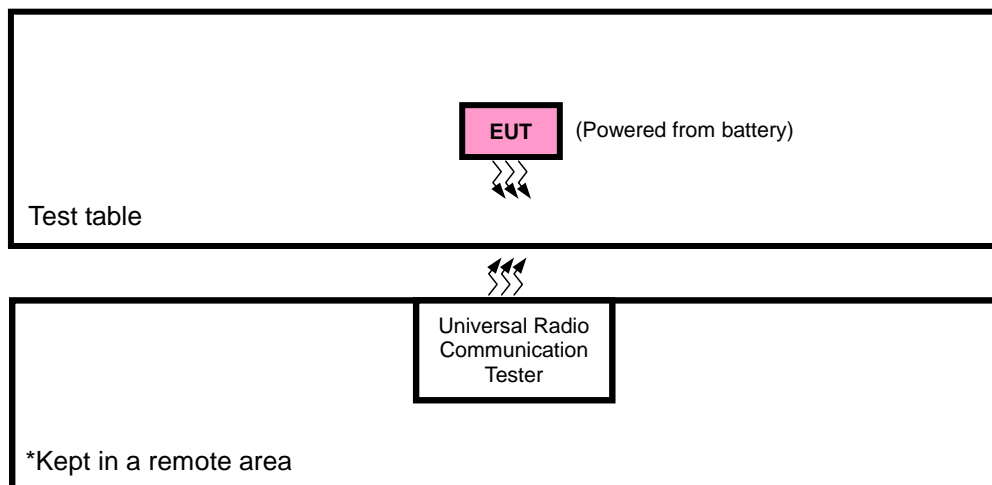

### 3.3 DESCRIPTION OF SUPPORT UNITS

The EUT has been tested as an independent unit together with other necessary accessories or support units. The following support units or accessories were used to form a representative test configuration during the tests.

NO.	PRODUCT	BRAND	MODEL NO.	SERIAL NO.	FCC ID
1	DC source	LONG WEI	PS-6403D	010934269	N/A
2	PC	HP	A6608CN	3CR83825X3	N/A

NO.	SIGNAL CABLE DESCRIPTION OF THE ABOVE SUPPORT UNITS
1	DC Line: Unshielded, Detachable 1.0m
2	AC Line: Unshielded, Detachable 1.5m

**NOTE:** All power cords of the above support units are non shielded (1.8m).

### 3.4 TEST ITEM AND TEST CONFIGURATION

Pre-Scan has been conducted to determine the worst-case mode from all possible combinations between available modulations, data rates, XYZ axis and antenna ports. The worst case was found when positioned on Y-plane for EIRP and X-axis for radiated emission. Following channel(s) was (were) selected for the final test as listed below:

EUT CONFIGURE MODE	DESCRIPTION
A	EUT + Adapter + USB Cable with LTE link
B	EUT + Battery with LTE link

**LTE BAND 7**

EUT CONFIGURE MODE	TEST ITEM	AVAILABLE CHANNEL	TESTED CHANNEL	CHANNEL BANDWIDTH	MODULATION	MODE	
B	EIRP	20775 to 21425	20775, 21100, 21425	5MHz	QPSK, 16QAM	1 RB / 0 RB Offset	
		20800 to 21400	20800, 21100, 21400	10MHz	QPSK, 16QAM	1 RB / 0RB Offset	
		20825 to 21375	20825, 21100, 21375	15MHz	QPSK, 16QAM	1 RB / 0 RB Offset	
		20850 to 21350	20850, 21100, 21350	20MHz	QPSK, 16QAM	1 RB / 0 RB Offset	
B	FREQUENCY STABILITY	20775 to 21425	20775, 21425	5MHz	QPSK	1 RB / 0 RB Offset	
		20800 to 21400	20800, 21400	10MHz	QPSK	1 RB / 0RB Offset	
		20825 to 21375	20825, 21375	15MHz	QPSK	1 RB / 0 RB Offset	
		20850 to 21350	20850, 21350	20MHz	QPSK	1 RB / 0 RB Offset	
B	OCCUPIED BANDWIDTH	20775 to 21425	20775, 21100, 21425	5MHz	QPSK, 16QAM	25 RB / 0 RB Offset	
		20800 to 21400	20800, 21100, 21400	10MHz	QPSK, 16QAM	50 RB / 0 RB Offset	
		20825 to 21375	20825, 21100, 21375	15MHz	QPSK, 16QAM	75 RB / 0 RB Offset	
		20850 to 21350	20850, 21100, 21350	20MHz	QPSK, 16QAM	100 RB / 0 RB Offset	
B	PEAK TO AVERAGE RATIO	20775 to 21425	20775, 21100, 21425	5MHz	QPSK, 16QAM	1 RB / 0 RB Offset	
		20800 to 21400	20800, 21100, 21400	10MHz	QPSK, 16QAM	1 RB / 0RB Offset	
		20825 to 21375	20825, 21100, 21375	15MHz	QPSK, 16QAM	1 RB / 0 RB Offset	
		20850 to 21350	20850, 21100, 21350	20MHz	QPSK, 16QAM	1 RB / 0 RB Offset	
B	BAND EDGE	20775 to 21425	20775	5MHz	QPSK	1 RB / 0 RB Offset	
			21425	5MHz	QPSK	25 RB / 0 RB Offset	
			20800 to 21400	20800	10MHz	QPSK	1 RB / 24 RB Offset
			21400	10MHz	QPSK	25 RB / 0 RB Offset	
		20800 to 21400	20800	10MHz	QPSK	1 RB / 0 RB Offset	
			21400	10MHz	QPSK	1 RB / 49 RB Offset	
			20825 to 21375	20825	15MHz	QPSK	50 RB / 0 RB Offset
			21375	15MHz	QPSK	1 RB / 0 RB Offset	
		20825 to 21375	20825	15MHz	QPSK	75 RB / 0 RB Offset	
			21375	15MHz	QPSK	1 RB / 74 RB Offset	
			20850 to 21350	20850	20MHz	QPSK	75 RB / 0 RB Offset
			21350	20MHz	QPSK	1 RB / 0 RB Offset	
B	CONDCUETED EMISSION	20775 to 21425	20775, 21100, 21425	5MHz	QPSK	100 RB / 0 RB Offset	
		20800 to 21400	20800, 21100, 21400	10MHz	QPSK	1 RB / 0 RB Offset	
		20825 to 21375	20825, 21100, 21375	15MHz	QPSK	1 RB / 0RB Offset	
		20850 to 21350	20850, 21100, 21350	20MHz	QPSK	1 RB / 0 RB Offset	
A	RADIATED EMISSION	20775 to 21425	21100	5MHz	QPSK	1 RB / 0 RB Offset	
		20800 to 21400	20800, 21100, 21400	10MHz	QPSK	1 RB / 0RB Offset	
		20825 to 21375	21100	15MHz	QPSK	1 RB / 0 RB Offset	
		20850 to 21350	21100	20MHz	QPSK	1 RB / 0 RB Offset	

**Note:** This device was tested under all bandwidths, RB configurations and modulations. The worst case was found in QPSK modulation.



Test Report No.: RF170829W003-7

**TEST CONDITION:**

TEST ITEM	ENVIRONMENTAL CONDITIONS	INPUT POWER	TESTED BY
EIRP	24deg. C, 60%RH	3.85Vdc from Battery	Simon Yang
FREQUENCY STABILITY	24deg. C, 61%RH	DC 3.45V/3.85V/4.4V	Wenliang Wu
OCCUPIED BANDWIDTH	24deg. C, 61%RH	3.85Vdc from Battery	Wenliang Wu
PEAK TO AVERAGE RATIO	24deg. C, 61%RH	3.85Vdc from Battery	Moon Xiong
BAND EDGE	24deg. C, 61%RH	3.85Vdc from Battery	Moon Xiong
CONDUCTED EMISSION	24deg. C, 61%RH	3.85Vdc from Battery	Moon Xiong
RADIATED EMISSION	24deg. C, 60%RH	5Vdc from adapter	Simon Yang

### 3.5 GENERAL DESCRIPTION OF APPLIED STANDARDS

The EUT is a RF product. According to the specifications of the manufacturer, it must comply with the requirements of the following standards:

**FCC 47 CFR Part 2**

**FCC 47 CFR Part 27**

**KDB 971168 D01 Power Meas License Digital Systems v02r02**

**ANSI/TIA/EIA-603-D**

**ANSI/TIA/EIA-603-E**

**NOTE:** All test items have been performed and recorded as per the above standards.

## 4 TEST TYPES AND RESULTS

### 4.1 OUTPUT POWER MEASUREMENT

#### 4.1.1 LIMITS OF OUTPUT POWER MEASUREMENT

The radiated peak output power shall be according to the specific rule Part 27.50(h)(2) that “User stations are limited to 2 watts” and 27.50(i) specific that “Peak transmit power must be measure over any interval of continuous transmission using instrumentation calibration in terms of rms-equivalent voltage.”

#### 4.1.2 TEST PROCEDURES

##### **EIRP MEASUREMENT:**

- a. All measurements were done at low, middle and high operational frequency range. RBW and VBW is 10MHz for LTE mode.
- b. Substitution method is used for E.I.R.P measurement. In the semi-anechoic chamber, EUT placed on the 0.8m height of Turn Table, rotated the table around 360 degrees to search the maximum radiation power and receiver antenna shall be rotated vertical and horizontal polarization and moved height from 1m to 4m to find the maximum polar radiated power. The “Read Value” is the spectrum reading the maximum power value.
- c. The substitution horn antenna is substituted for EUT at the same position and signals generator export the CW signal to the substitution antenna via a tx cable. Rotated the Turn Table and moved receiving antenna to find the maximum radiation power. Adjust output power level of S.G to get a Value of spectrum reading equal to “Read Value” of step b. Record the power level of S.G.
- d.  $EIRP = \text{Output power level of S.G} - \text{TX cable loss} + \text{Antenna gain of substitution horn.}$

##### **CONDUCTED POWER MEASUREMENT:**

- a. The EUT was set up for the maximum power with LTE link data modulation and link up with simulator.
- b. Set the EUT to transmit under low, middle and high channel and record the power level shown on simulator.

### 4.1.3 TEST SETUP

#### EIRP MEASUREMENT:

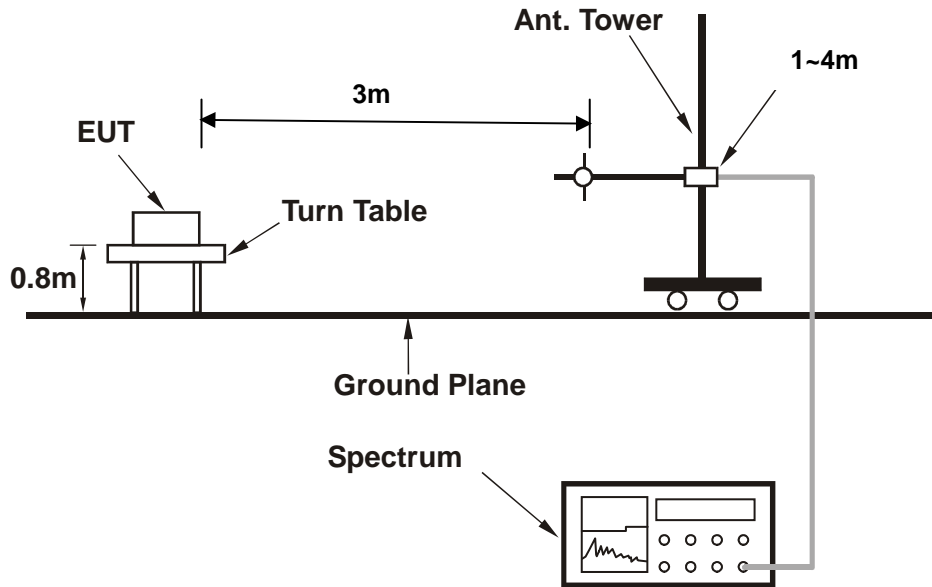

For the actual test configuration, please refer to the attached file (Test Setup Photo).

#### CONDUCTED POWER MEASUREMENT:

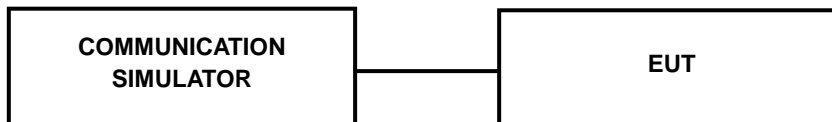

For the actual test configuration, please refer to the attached file (Test Setup Photo).

#### 4.1.4 TEST RESULTS

##### AVERAGE CONDUCTED OUTPUT POWER (dBm)

LTE Band 7							
BW	Modulation	RB Size	RB Offset	Low CH 20775	Mid CH 21100	High CH 21425	MPR
				Frequency 2502.5 MHz	Frequency 2535 MHz	Frequency 2567.5 MHz	
5 MHz	QPSK	1	0	22.56	22.72	22.61	0
		1	12	22.52	22.68	22.57	0
		1	24	22.47	22.63	22.52	0
		12	0	21.69	21.85	21.74	1
		12	6	21.66	21.82	21.71	1
		12	13	21.62	21.78	21.67	1
		25	0	21.70	21.86	21.75	1
	16QAM	1	0	21.49	21.65	21.54	1
		1	12	21.44	21.60	21.49	1
		1	24	21.39	21.55	21.44	1
		12	0	20.69	20.85	20.74	2
		12	6	20.67	20.83	20.72	2
		12	13	20.62	20.78	20.67	2
		25	0	20.68	20.84	20.73	2
BW	Modulation	RB Size	RB Offset	Low CH 20800	Mid CH 21100	High CH 21400	MPR
				Frequency 2505 MHz	Frequency 2535 MHz	Frequency 2565 MHz	
10 MHz	QPSK	1	0	22.60	22.76	22.65	0
		1	24	22.56	22.72	22.61	0
		1	49	22.51	22.67	22.56	0
		25	0	21.73	21.89	21.78	1
		25	12	21.70	21.86	21.75	1
		25	25	21.66	21.82	21.71	1
		50	0	21.74	21.90	21.79	1
	16QAM	1	0	21.53	21.69	21.58	1
		1	24	21.48	21.64	21.53	1
		1	49	21.43	21.59	21.48	1
		25	0	20.73	20.89	20.78	2
		25	12	20.71	20.87	20.76	2
		25	25	20.66	20.82	20.71	2
		50	0	20.72	20.88	20.77	2



LTE Band 7							
BW	Modulation	RB Size	RB Offset	Low CH 20825	Mid CH 21100	High CH 21375	MPR
				Frequency 2507.5 MHz	Frequency 2535 MHz	Frequency 2562.5 MHz	
15 MHz	QPSK	1	0	22.66	22.82	22.71	0
		1	37	22.62	22.78	22.67	0
		1	74	22.57	22.73	22.62	0
		36	0	21.79	21.95	21.84	1
		36	19	21.76	21.92	21.81	1
		36	39	21.72	21.88	21.77	1
		75	0	21.80	21.96	21.85	1
	16QAM	1	0	21.59	21.75	21.64	1
		1	37	21.54	21.70	21.59	1
		1	74	21.49	21.65	21.54	1
		36	0	20.79	20.95	20.84	2
		36	19	20.77	20.93	20.82	2
		36	39	20.72	20.88	20.77	2
		75	0	20.78	20.94	20.83	2
BW	Modulation	RB Size	RB Offset	Low CH 20850	Mid CH 21100	High CH 21350	MPR
				Frequency 2510 MHz	Frequency 2535 MHz	Frequency 2560 MHz	
20 MHz	QPSK	1	0	22.69	22.85	22.74	0
		1	50	22.65	22.81	22.70	0
		1	99	22.60	22.76	22.65	0
		50	0	21.82	21.98	21.87	1
		50	25	21.79	21.95	21.84	1
		50	50	21.75	21.91	21.80	1
		100	0	21.83	21.99	21.88	1
	16QAM	1	0	21.62	21.78	21.67	1
		1	50	21.57	21.73	21.62	1
		1	99	21.52	21.68	21.57	1
		50	0	20.82	20.98	20.87	2
		50	25	20.80	20.96	20.85	2
		50	50	20.75	20.91	20.80	2
		100	0	20.81	20.97	20.86	2



Test Report No.: RF170829W003-7

**EIRP**

**LTE BAND 7**

**CHANNEL BANDWIDTH: 5MHz QPSK**

Channel	Frequency (MHz)	SPA LVL (dBm)	Correction Factor(dB)	EIRP(dBm)	EIRP(mW)	Polarization (H/V)	Limit (W)
20775	2502.5	-26.83	45.65	18.82	76.23	H	2
21100	2535.0	-26.26	46.04	19.78	95.04	H	2
21425	2567.5	-26.19	45.87	19.67	92.77	H	2
20775	2502.5	-26.52	47.03	20.51	<b>112.36</b>	V	2
21100	2535.0	-27.07	46.57	19.50	89.08	V	2
21425	2567.5	-26.26	46.98	20.73	118.17	V	2

**CHANNEL BANDWIDTH: 5MHz 16QAM**

Channel	Frequency (MHz)	SPA LVL (dBm)	Correction Factor(dB)	EIRP(dBm)	EIRP(mW)	Polarization (H/V)	Limit (W)
20775	2502.5	-27.66	45.65	17.99	62.97	H	2
21100	2535.0	-27.28	46.04	18.76	75.14	H	2
21425	2567.5	-27.29	45.87	18.57	72.01	H	2
20775	2502.5	-27.35	47.03	19.68	92.81	V	2
21100	2535.0	-28.09	46.57	18.48	70.44	V	2
21425	2567.5	-27.36	46.98	19.63	91.73	V	2

**CHANNEL BANDWIDTH: 10MHz QPSK**

Channel	Frequency (MHz)	SPA LVL (dBm)	Correction Factor(dB)	EIRP(dBm)	EIRP(mW)	Polarization (H/V)	Limit (W)
20800	2505.0	-26.64	45.65	19.01	79.65	H	2
21100	2535.0	-26.20	46.04	19.84	96.36	H	2
21400	2565.0	-26.06	46.07	20.00	100.07	H	2
20800	2505.0	-26.33	47.18	20.84	<b>121.45</b>	V	2
21100	2535.0	-27.01	46.57	19.56	90.32	V	2
21400	2565.0	-26.13	47.06	20.94	124.14	V	2

**CHANNEL BANDWIDTH: 10MHz 16QAM**

Channel	Frequency (MHz)	SPA LVL (dBm)	Correction Factor(dB)	EIRP(dBm)	EIRP(mW)	Polarization (H/V)	Limit (W)
20800	2505.0	-27.79	45.65	17.86	61.12	H	2
21100	2535.0	-27.30	46.04	18.74	74.80	H	2
21400	2565.0	-27.22	46.07	18.84	76.61	H	2
20800	2505.0	-27.48	47.18	19.69	93.20	V	2
21100	2535.0	-28.11	46.57	18.46	70.11	V	2
21400	2565.0	-27.29	47.06	19.78	95.04	V	2

**CHANNEL BANDWIDTH: 15MHz QPSK**

Channel	Frequency (MHz)	SPA LVL (dBm)	Correction Factor(dB)	EIRP(dBm)	EIRP(mW)	Polarization (H/V)	Limit (W)
20825	2507.5	-26.65	45.63	18.99	79.18	H	2
21100	2535.0	-26.27	46.04	19.77	94.82	H	2
21375	2562.5	-26.13	45.94	19.81	95.63	H	2
20825	2507.5	-26.34	47.39	21.05	<b>127.26</b>	V	2
21100	2535.0	-27.08	46.57	19.49	88.88	V	2
21375	2562.5	-26.20	47.00	20.80	120.34	V	2

**CHANNEL BANDWIDTH: 15MHz 16QAM**

Channel	Frequency (MHz)	SPA LVL (dBm)	Correction Factor(dB)	EIRP(dBm)	EIRP(mW)	Polarization (H/V)	Limit (W)
20825	2507.5	-27.51	45.63	18.13	64.95	H	2
21100	2535.0	-27.14	46.04	18.90	77.61	H	2
21375	2562.5	-26.98	45.94	18.96	78.63	H	2
20825	2507.5	-27.20	47.39	20.19	104.40	V	2
21100	2535.0	-27.95	46.57	18.62	72.74	V	2
21375	2562.5	-27.05	47.00	19.95	98.95	V	2

**CHANNEL BANDWIDTH: 20MHz QPSK**

Channel	Frequency (MHz)	SPA LVL (dBm)	Correction Factor(dB)	EIRP(dBm)	EIRP(mW)	Polarization (H/V)	Limit (W)
20850	2510.0	-27.23	45.80	18.57	71.98	H	2
21100	2535.0	-26.72	46.04	19.32	85.49	H	2
21350	2560.0	-26.71	45.83	19.12	81.68	H	2
20850	2510.0	-26.92	47.21	20.29	106.86	V	2
21100	2535.0	-27.53	46.57	19.03	80.06	V	2
21350	2560.0	-26.78	47.07	20.29	<b>107.00</b>	V	2

**CHANNEL BANDWIDTH: 20MHz 16QAM**

Channel	Frequency (MHz)	SPA LVL (dBm)	Correction Factor(dB)	EIRP(dBm)	EIRP(mW)	Polarization (H/V)	Limit (W)
20850	2510.0	-28.16	45.80	17.64	58.10	H	2
21100	2535.0	-27.79	46.04	18.25	66.82	H	2
21350	2560.0	-27.54	45.83	18.29	67.47	H	2
20850	2510.0	-27.85	47.21	19.36	86.26	V	2
21100	2535.0	-28.60	46.57	17.96	62.57	V	2
21350	2560.0	-27.61	47.07	19.46	88.39	V	2

**REMARKS:** 1. EIRP Output Power (dBm) = SPA LVL (dBm) + Correction Factor (dB).  
2. Correction factor (dB) = Free Space Loss + Antenna Factor + Cable Loss

## 4.2 FREQUENCY STABILITY MEASUREMENT

### 4.2.1 LIMITS OF FREQUENCY STABILITY MEASUREMENT

The frequency stability shall be sufficient to ensure that the fundamental emissions stay within the authorized bands of operation.

### 4.2.2 TEST PROCEDURE

- a. Device is placed at the oven room. The oven room could control the temperatures and humidity. Power warm up is at least 15 min and power applied should perform before recording frequency error.
- b. EUT is connected the external power supply to control the DC input power. The test voltage range is from minimum to maximum working voltage. Each step shall be record the frequency error rate.
- c. The temperature range step is 10 degrees in this test items. All temperature levels shall be hold the  $\pm 0.5^{\circ}\text{C}$  during the measurement testing. The each temperature step shall be at least 0.5 hours, consider the EUT could be test under the stability condition.

**NOTE:** The frequency error was recorded frequency error from the communication simulator.

### 4.2.3 TEST SETUP

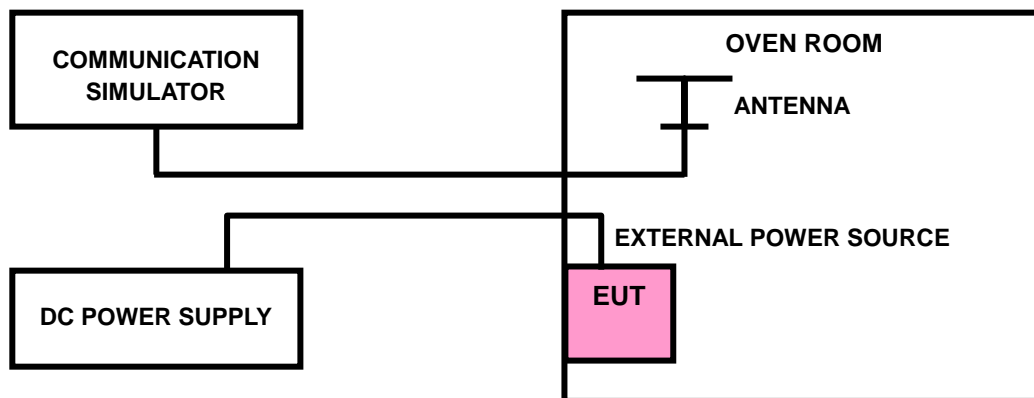

#### 4.2.4 TEST RESULTS

##### LTE BAND 7

##### FREQUENCY ERROR VS. VOLTAGE

VOLTAGE (Volts)	5MHz		LIMIT (ppm)
	FREQUENCY ERROR (ppm)		
	Low Channel	High Channel	
3.85	0.0005	0.0005	2.5
3.45	-0.0006	-0.0006	2.5
4.4	0.0006	0.0006	2.5

**NOTE:** The applicant defined the normal working voltage of the battery is from 3.45Vdc to 4.4Vdc.

##### FREQUENCY ERROR vs. TEMPERATURE.

TEMP. (°C)	5MHz		LIMIT (ppm)
	FREQUENCY ERROR (ppm)		
	Low Channel	High Channel	
-30	-0.0038	-0.0040	2.5
-20	-0.0033	-0.0034	2.5
-10	-0.0029	-0.0031	2.5
0	-0.0026	-0.0026	2.5
10	-0.0022	-0.0022	2.5
20	-0.0017	-0.0019	2.5
30	-0.0014	-0.0013	2.5
40	-0.0007	-0.0007	2.5
50	-0.0002	-0.0002	2.5

**FREQUENCY ERROR VS. VOLTAGE**

VOLTAGE (Volts)	10MHz		LIMIT (ppm)
	FREQUENCY ERROR (ppm)		
	Low Channel	High Channel	
3.85	0.0006	0.0006	2.5
3.45	-0.0006	-0.0007	2.5
4.4	0.0006	0.0005	2.5

**NOTE:** The applicant defined the normal working voltage of the battery is from 3.45Vdc to 4.4Vdc.

**FREQUENCY ERROR vs. TEMPERATURE.**

TEMP. (°C)	10MHz		LIMIT (ppm)
	FREQUENCY ERROR (ppm)		
	Low Channel	High Channel	
-30	-0.0039	-0.0040	2.5
-20	-0.0035	-0.0034	2.5
-10	-0.0027	-0.0025	2.5
0	-0.0021	-0.0020	2.5
10	-0.0017	-0.0017	2.5
20	-0.0016	-0.0014	2.5
30	-0.0011	-0.0010	2.5
40	-0.0007	-0.0005	2.5
50	-0.0003	-0.0003	2.5

**FREQUENCY ERROR VS. VOLTAGE**

VOLTAGE (Volts)	15MHz		LIMIT (ppm)
	FREQUENCY ERROR (ppm)		
	Low Channel	High Channel	
3.85	0.0006	0.0005	2.5
3.45	-0.0006	-0.0006	2.5
4.4	0.0005	0.0004	2.5

**NOTE:** The applicant defined the normal working voltage of the battery is from 3.45Vdc to 4.4Vdc.

**FREQUENCY ERROR vs. TEMPERATURE.**

TEMP. (°C)	15MHz		LIMIT (ppm)
	FREQUENCY ERROR (ppm)		
	Low Channel	High Channel	
-30	-0.0040	-0.0040	2.5
-20	-0.0037	-0.0038	2.5
-10	-0.0029	-0.0029	2.5
0	-0.0027	-0.0026	2.5
10	-0.0021	-0.0021	2.5
20	-0.0017	-0.0017	2.5
30	-0.0011	-0.0008	2.5
40	-0.0006	-0.0006	2.5
50	-0.0002	-0.0002	2.5



**FREQUENCY ERROR VS. VOLTAGE**

VOLTAGE (Volts)	20MHz		LIMIT (ppm)
	FREQUENCY ERROR (ppm)		
	Low Channel	High Channel	
3.85	0.0005	0.0006	2.5
3.45	-0.0005	-0.0007	2.5
4.4	0.0004	0.0007	2.5

**NOTE:** The applicant defined the normal working voltage of the battery is from 3.45Vdc to 4.4Vdc.

**FREQUENCY ERROR vs. TEMPERATURE.**

TEMP. (°C)	20MHz		LIMIT (ppm)
	FREQUENCY ERROR (ppm)		
	Low Channel	High Channel	
-30	-0.0041	-0.0041	2.5
-20	-0.0039	-0.0037	2.5
-10	-0.0035	-0.0032	2.5
0	-0.0030	-0.0028	2.5
10	-0.0022	-0.0021	2.5
20	-0.0018	-0.0018	2.5
30	-0.0013	-0.0014	2.5
40	-0.0009	-0.0008	2.5
50	-0.0004	-0.0004	2.5

### 4.3 OCCUPIED BANDWIDTH MEASUREMENT

#### 4.3.1 LIMITS OF OCCUPIED BANDWIDTH MEASUREMENT

The width of a frequency band such that, below the lower and above the upper frequency limits, the mean powers emitted are each equal to a specified percentage 0.5 % of the total mean power of a given emission.

#### 4.3.2 TEST SETUP

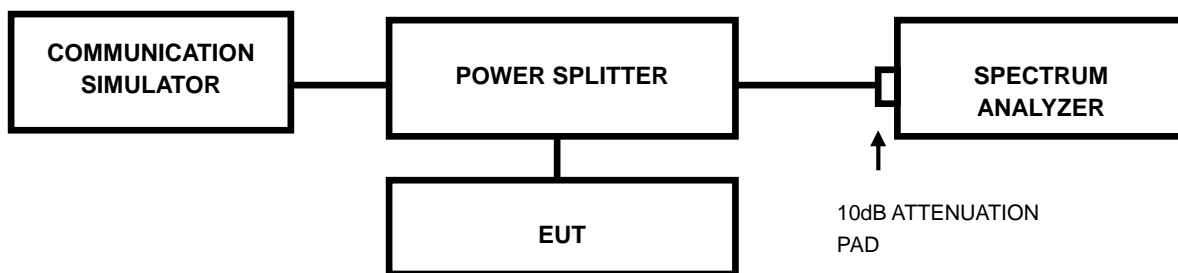

#### 4.3.3 TEST PROCEDURES

- a. The conducted occupied bandwidth used the power splitter via EUT RF power connector between simulation base station and spectrum analyzer.
- b. Use OBW measurement function of Spectrum analyzer to measure 99 % occupied bandwidth.

### 4.3.4 TEST RESULTS

LTE BAND 7							
CHANNEL BANDWIDTH: 5MHz				CHANNEL BANDWIDTH: 10MHz			
CHANNEL	FREQUENCY (MHz)	99% OCCUPIED BANDWIDTH (MHz)		CHANNEL	FREQUENCY (MHz)	99% OCCUPIED BANDWIDTH (MHz)	
		QPSK	16QAM			QPSK	16QAM
20775	2502.5	4.48	4.46	20800	2505	8.94	8.92
21100	2535	4.48	4.46	21100	2535	8.94	8.94
21425	2567.5	4.48	4.47	21400	2565	8.94	8.94

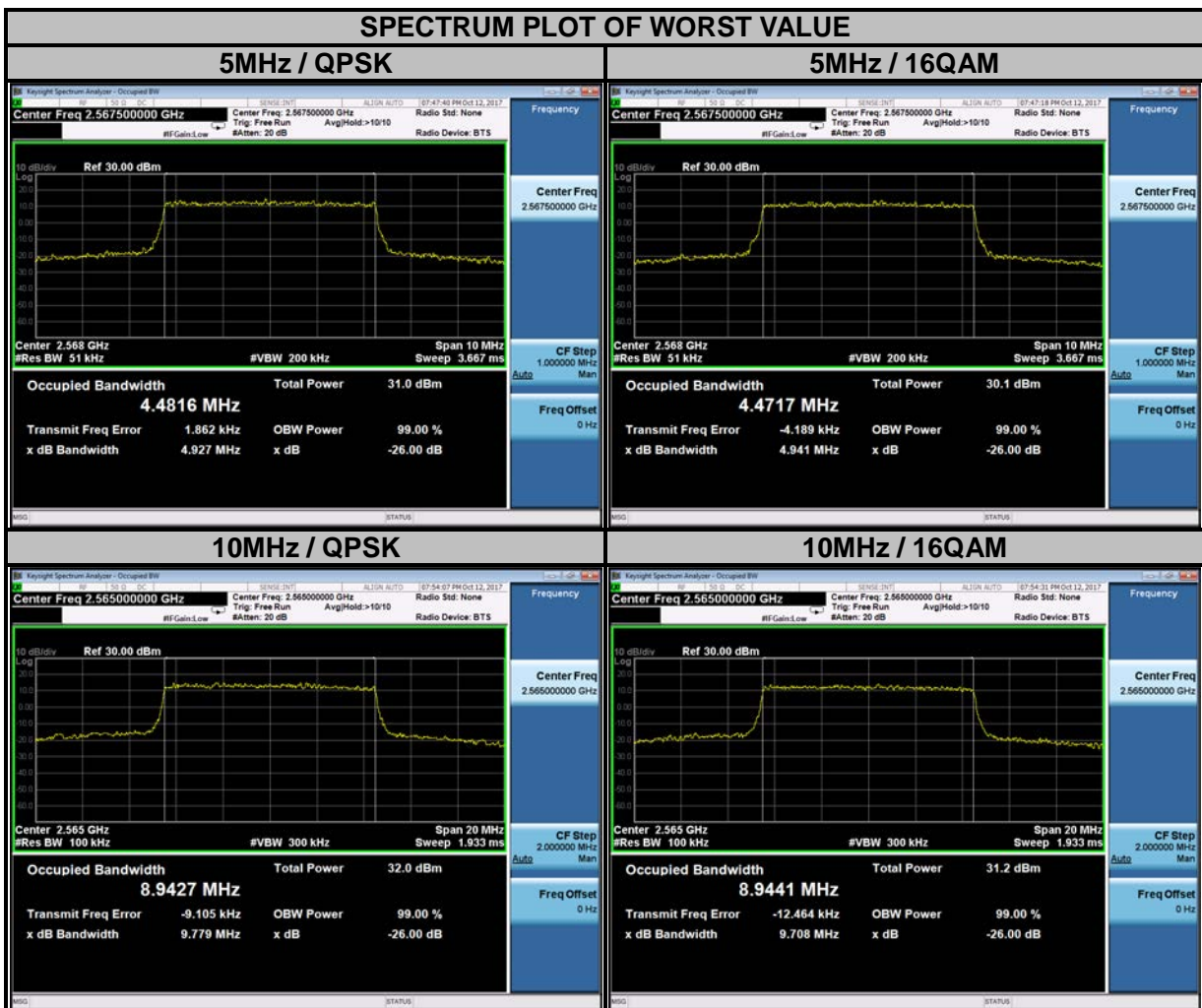

LTE BAND 7							
CHANNEL BANDWIDTH: 15MHz				CHANNEL BANDWIDTH: 20MHz			
CHANNEL	FREQUENCY (MHz)	99% OCCUPIED BANDWIDTH (MHz)		CHANNEL	FREQUENCY (MHz)	99% OCCUPIED BANDWIDTH (MHz)	
		QPSK	16QAM			QPSK	16QAM
20825	2507.5	13.38	13.39	20850	2510	17.91	17.82
21100	2535	13.37	13.37	21100	2535	17.91	17.83
21375	2562.5	13.37	13.39	21350	2560	17.86	17.80

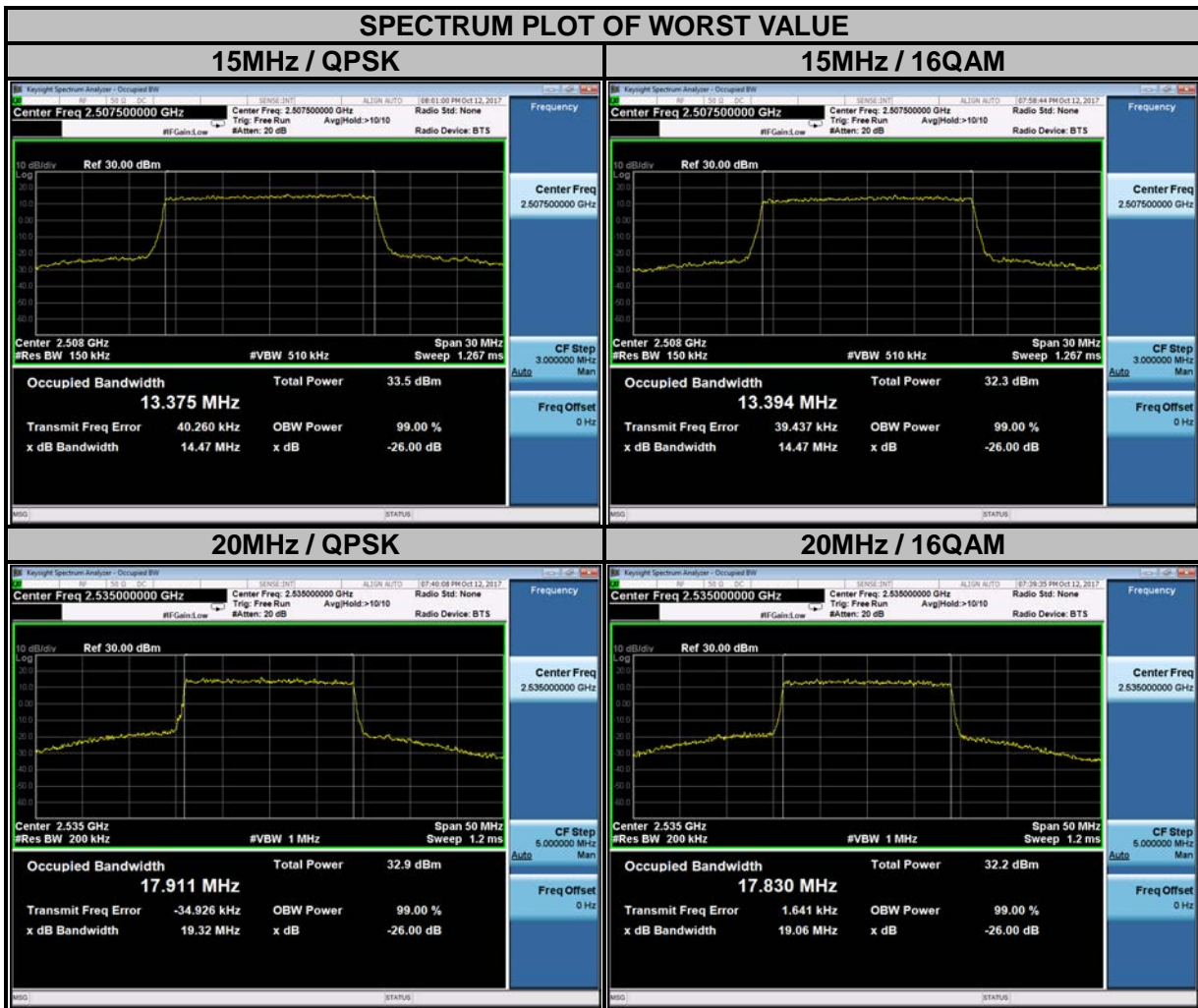

## 4.4 PEAK TO AVERAGE RATIO

### 4.4.1 LIMITS OF PEAK TO AVERAGE RATIO MEASUREMENT

In measuring transmissions in this band using an average power technique, the peak to-average ratio (PAR) of the transmission may not exceed 13 dB.

### 4.4.2 TEST SETUP

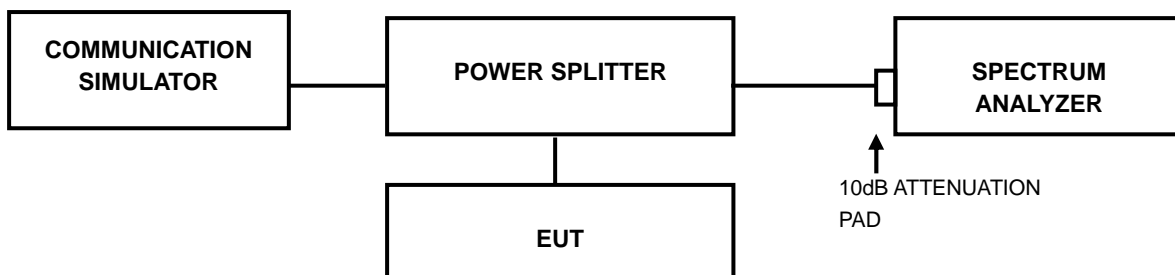

### 4.4.3 TEST PROCEDURES

1. Set resolution/measurement bandwidth  $\geq$  signal's occupied bandwidth;
2. Set the number of counts to a value that stabilizes the measured CCDF curve;
3. Record the maximum PAPR level associated with a probability of 0.1%.

### 4.4.4 TEST RESULTS

#### LTE BAND 7

CHANNEL BANDWIDTH: 5MHz				CHANNEL BANDWIDTH: 10MHz			
CHANNEL	FREQUENCY (MHz)	PEAK TO AVERAGE RATIO (dB)		CHANNEL	FREQUENCY (MHz)	PEAK TO AVERAGE RATIO (dB)	
		QPSK	16QAM			QPSK	16QAM
20775	2502.5	4.64	5.38	20800	2505	4.65	5.98
21100	2535	4.59	5.39	21100	2535	4.63	5.90
21425	2567.5	4.37	5.15	21400	2565	4.61	5.78

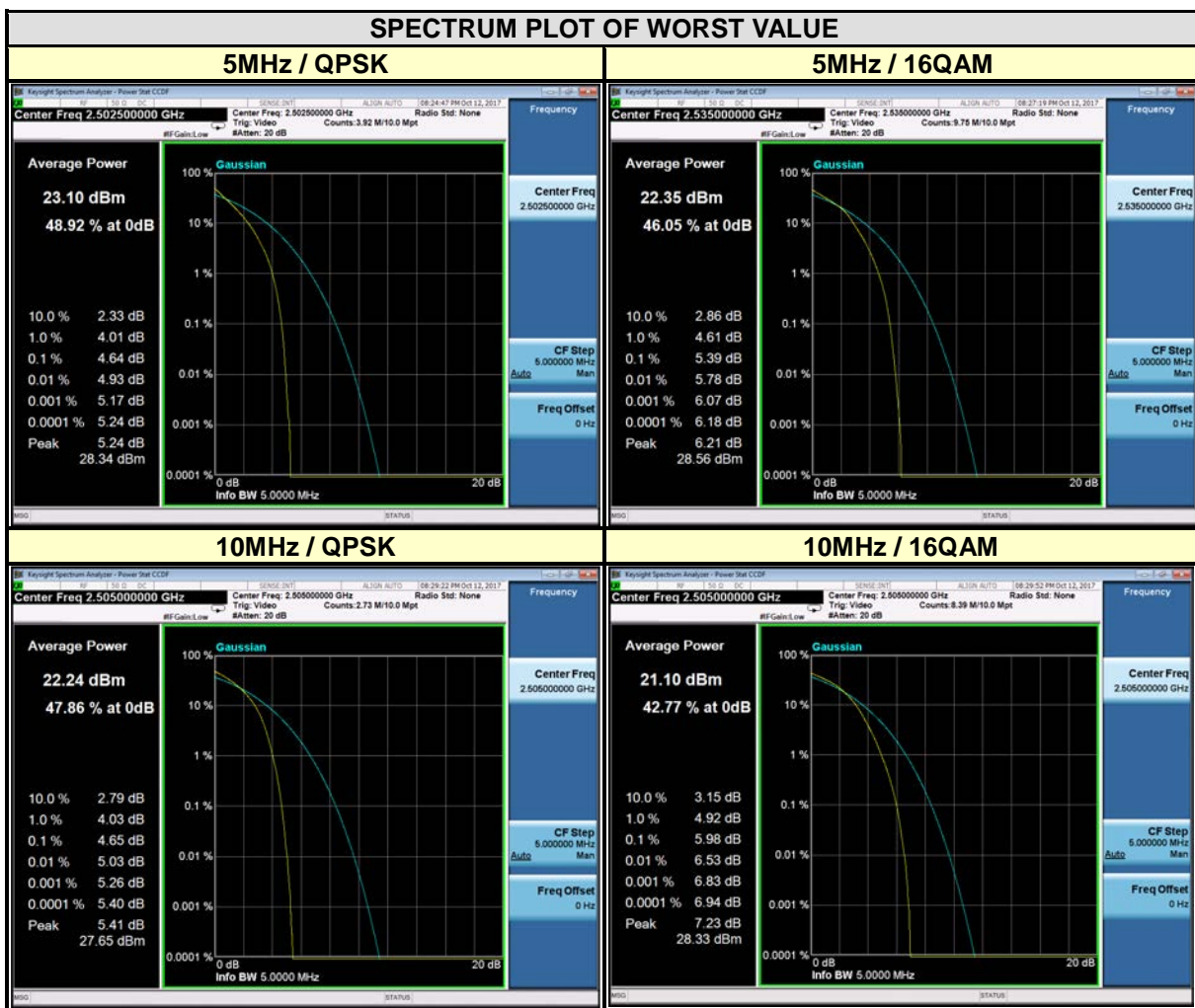

CHANNEL BANDWIDTH: 15MHz				CHANNEL BANDWIDTH: 20MHz			
CHANNEL	FREQUENCY (MHz)	PEAK TO AVERAGE RATIO (dB)		CHANNEL	FREQUENCY (MHz)	PEAK TO AVERAGE RATIO (dB)	
		QPSK	16QAM			QPSK	16QAM
20825	2507.5	5.82	6.77	20850	2510	6.52	7.12
21100	2535	5.80	6.71	21100	2535	6.44	7.01
21375	2562.5	5.80	6.63	21350	2560	6.50	7.01

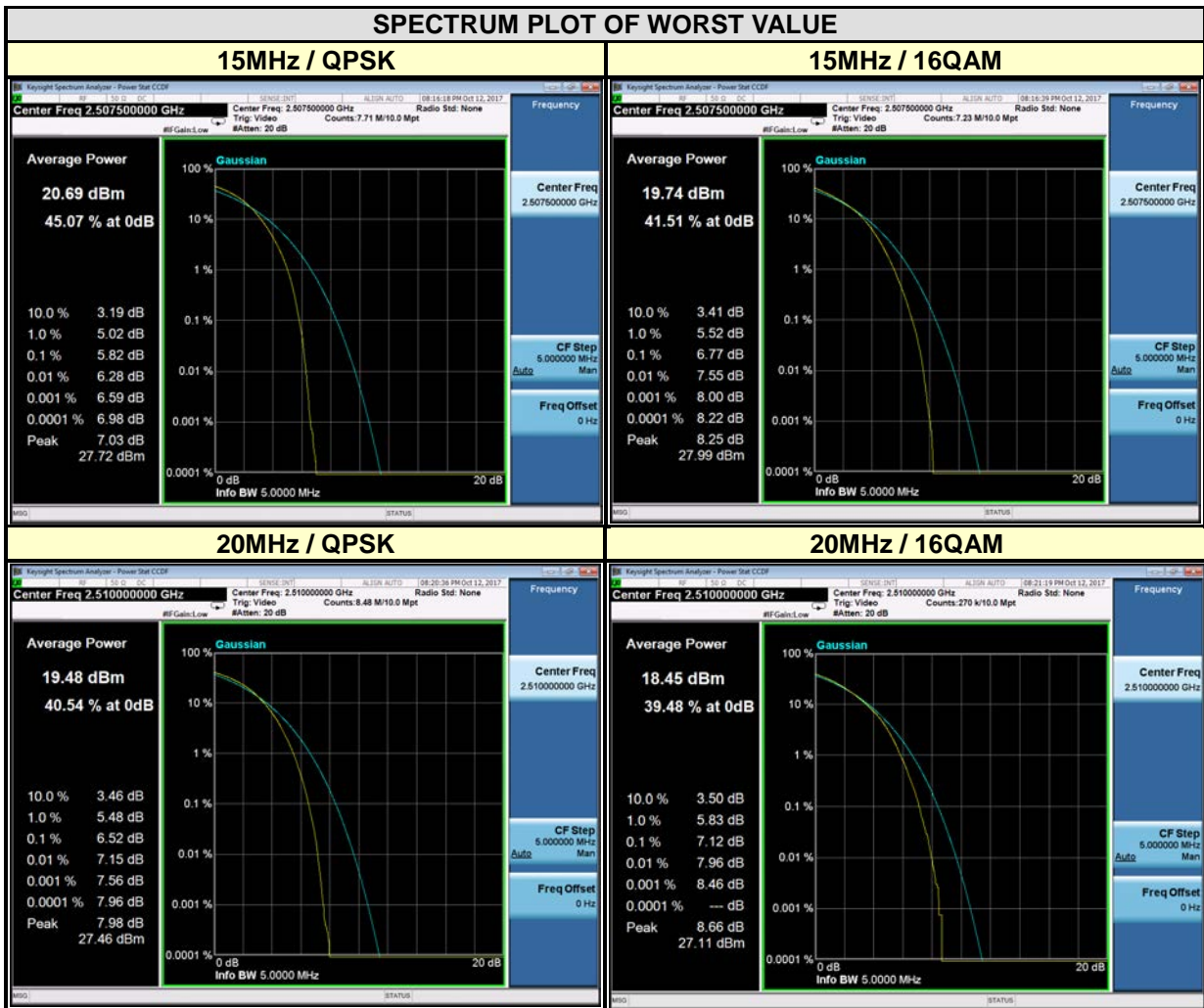



## 4.5 BAND EDGE MEASUREMENT

### 4.5.1 LIMITS OF BAND EDGE MEASUREMENT

According to FCC 27.53(m)(4) specified that For mobile digital stations, the attenuation factor shall be not less than  $40 + 10 \log (P)$  dB on all frequencies between the channel edge and 5 megahertz from the channel edge,  $43 + 10 \log (P)$  dB on all frequencies between 5 megahertz and X megahertz from the channel edge, and  $55 + 10 \log (P)$  dB on all frequencies more than X megahertz from the channel edge, where X is the greater of 6 megahertz or the actual emission bandwidth as defined in paragraph (m)(6) of this section. In addition, the attenuation factor shall not be less that  $43 + 10 \log (P)$  dB on all frequencies between 2490.5 MHz and 2496 MHz and  $55 + 10 \log (P)$  dB at or below 2490.5 MHz. Mobile Satellite Service licensees operating on frequencies below 2495 MHz may also submit a documented interference complaint against BRS licensees operating on channel BRS Channel 1 on the same terms and conditions as adjacent channel BRS or EBS licensees. For mobile digital stations, in the 1 megahertz bands immediately outside and adjacent to the frequency block a resolution bandwidth of at least two percent may be employed.

### 4.5.2 TEST SETUP

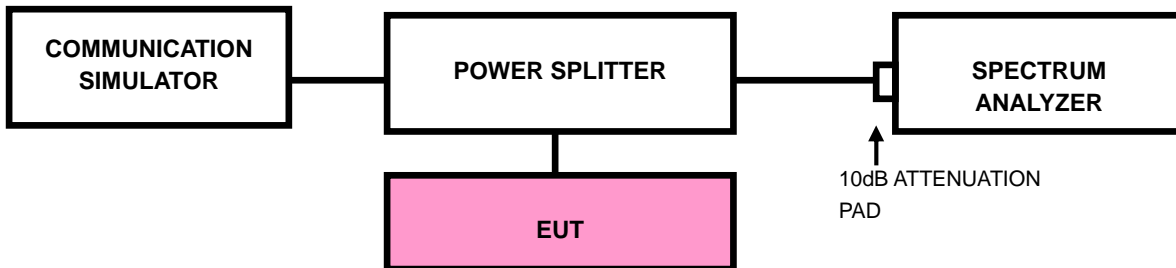



#### 4.5.3 TEST PROCEDURES

- a. The EUT was set up for the maximum peak power with LTE link data modulation. The power was measured with R&S Spectrum Analyzer. All measurements were done at 2 channels (low and high operational frequency range.).
- b. The band edge measurement used the power splitter via EUT RF power connector between simulation base station and spectrum analyzer.
- c. The center frequency of spectrum is the band edge frequency and span is 35MHz. RBW of the spectrum is 100kHz and VBW of the spectrum is 300kHz (Channel bandwidth 5MHz).
- d. The center frequency of spectrum is the band edge frequency and span is 50MHz. RBW of the spectrum is 200kHz and VBW of the spectrum is 1MHz (Channel bandwidth 10MHz).
- e. The center frequency of spectrum is the band edge frequency and span is 60MHz. RBW of the spectrum is 300kHz and VBW of the spectrum is 1MHz (Channel bandwidth 15MHz).
- f. The center frequency of spectrum is the band edge frequency and span is 80MHz. RBW of the spectrum is 500kHz and VBW of the spectrum is 2MHz (Channel bandwidth 20MHz).
- g. Record the max trace plot into the test report.

### 4.5.4 TEST RESULTS







Test Report No.: RF170829W003-7

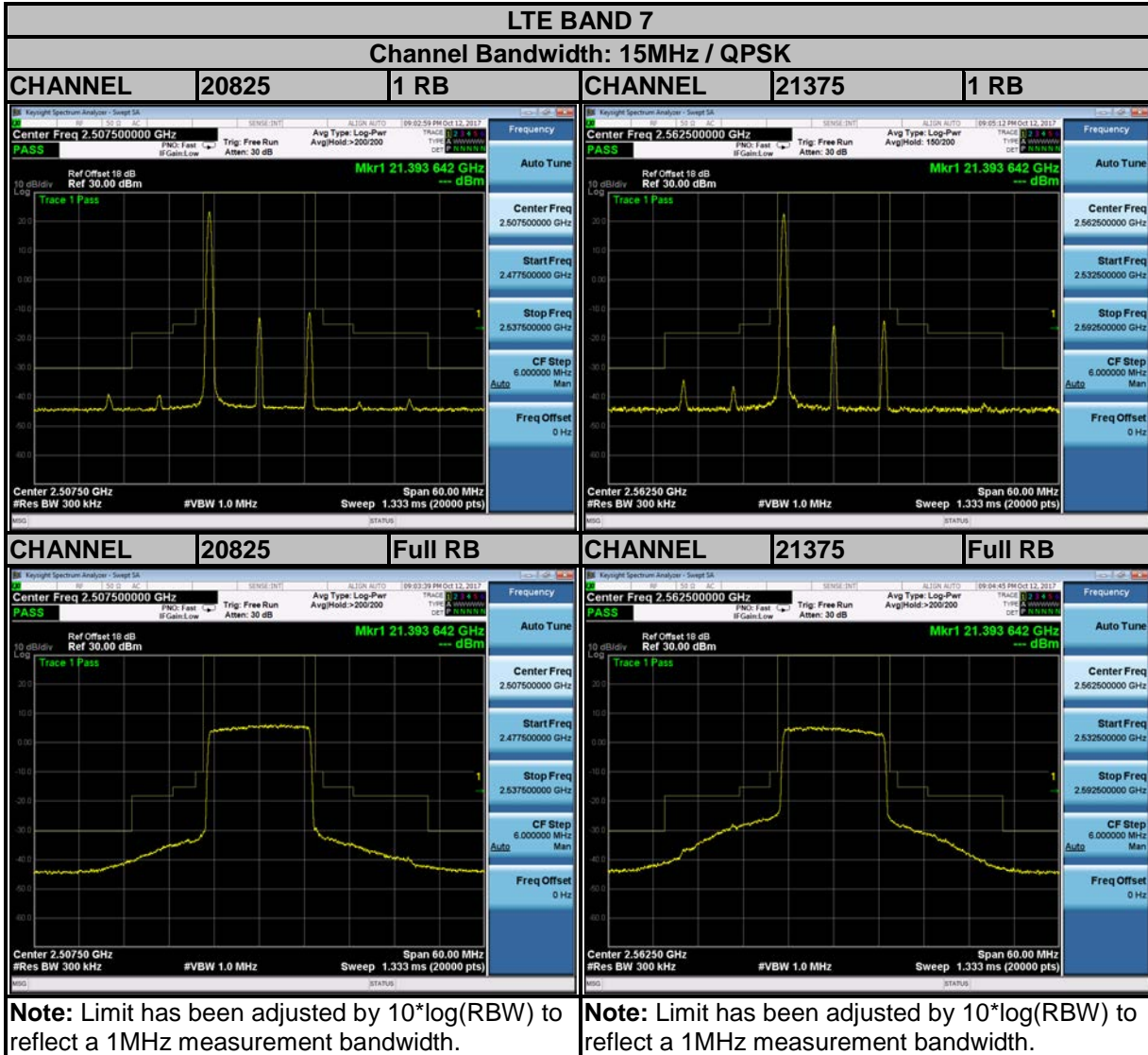



Test Report No.: RF170829W003-7

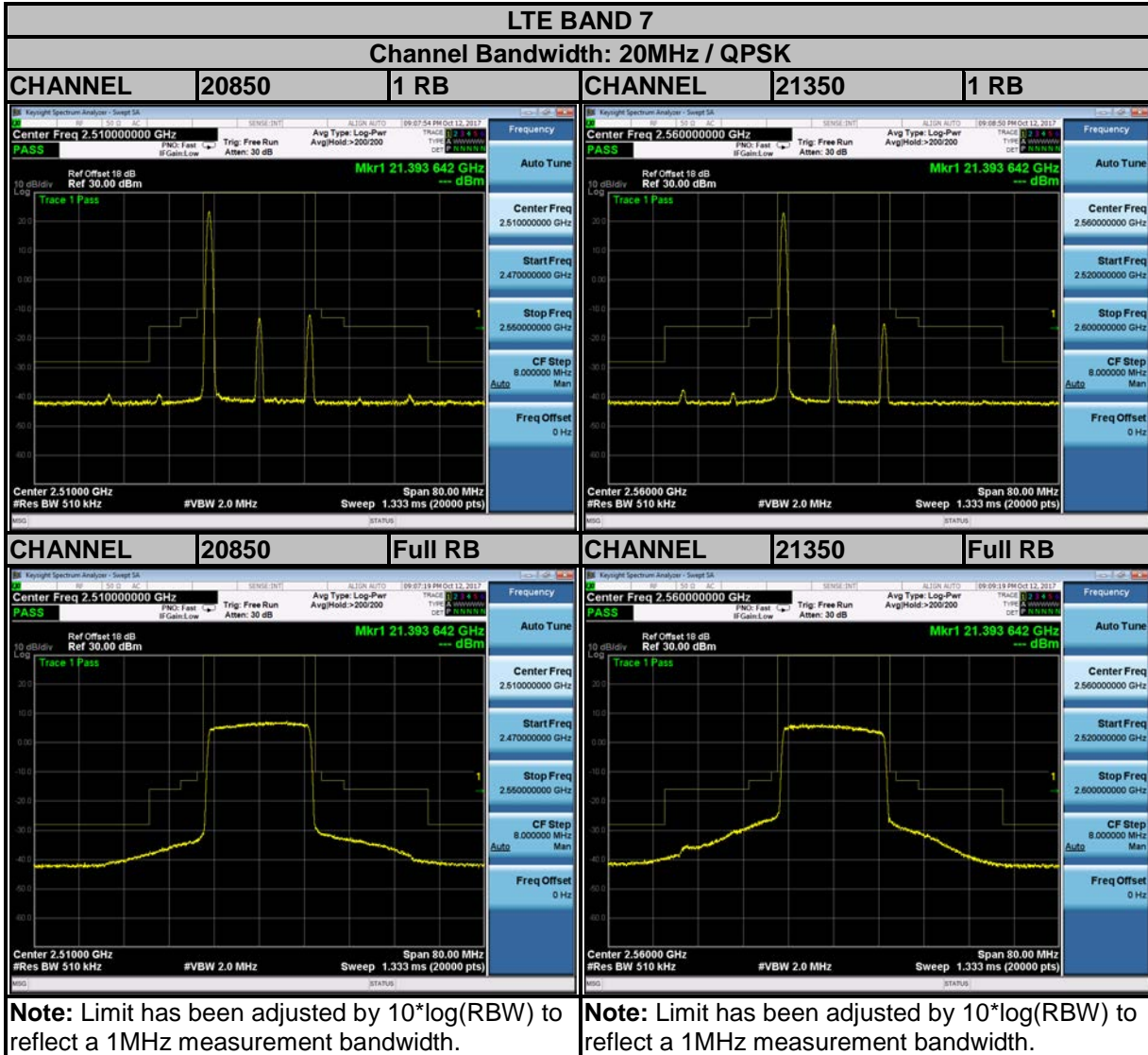



## 4.6 CONDUCTED SPURIOUS EMISSIONS

### 4.6.1 LIMITS OF CONDUCTED SPURIOUS EMISSIONS MEASUREMENT

The power of any emission outside a licensee's frequency block shall be attenuated below the transmitter power (P) by at least  $55 + 10 \log_{10}(P)$  dB. The limit of emission is equal to -25dBm.

### 4.6.2 TEST PROCEDURE

- a. The EUT makes a phone call to the communication simulator. All measurements were done at low, middle and high operational frequency range.
- b. Measuring frequency range is from 30MHz to 25.7GHz for LTE Band 7. 10dB attenuation pad is connected with spectrum. RBW=1MHz and VBW=3MHz are used for conducted emission measurement.

### 4.6.3 TEST SETUP

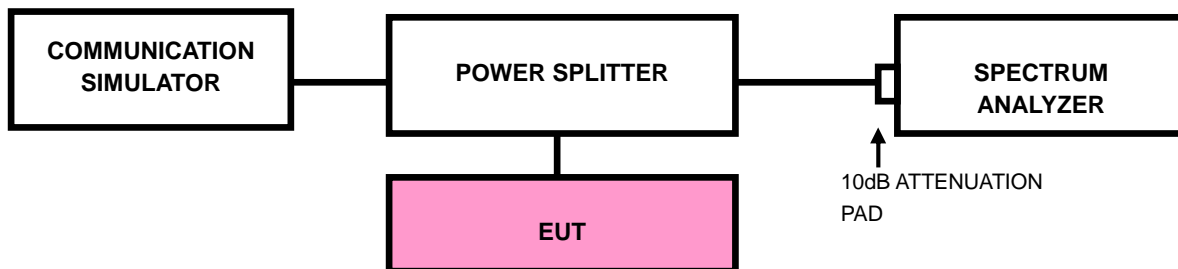



BUREAU VERITAS

Test Report No.: RF170829W003-7

### 4.6.4 TEST RESULTS

#### LTE BAND 7

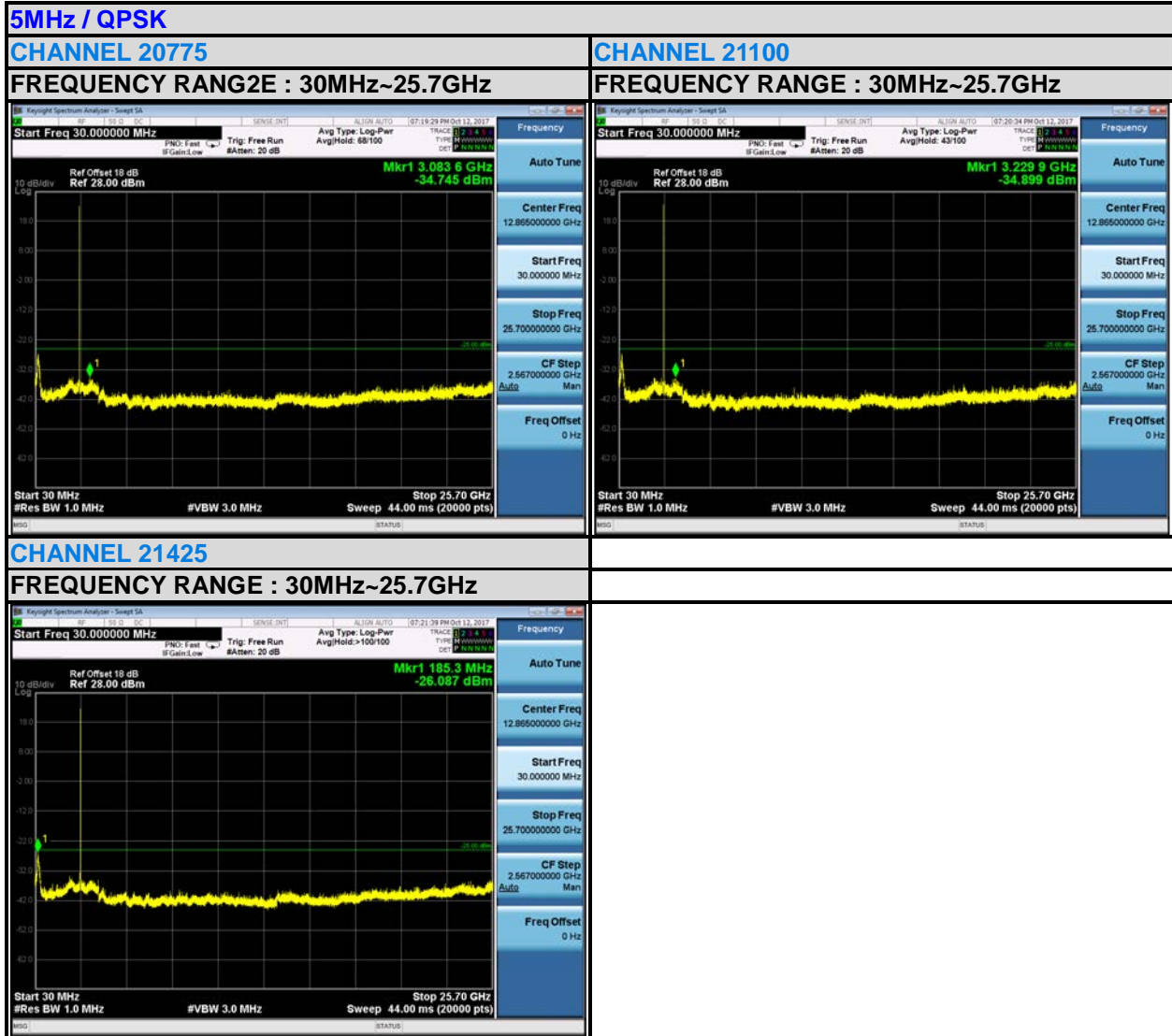



Test Report No.: RF170829W003-7

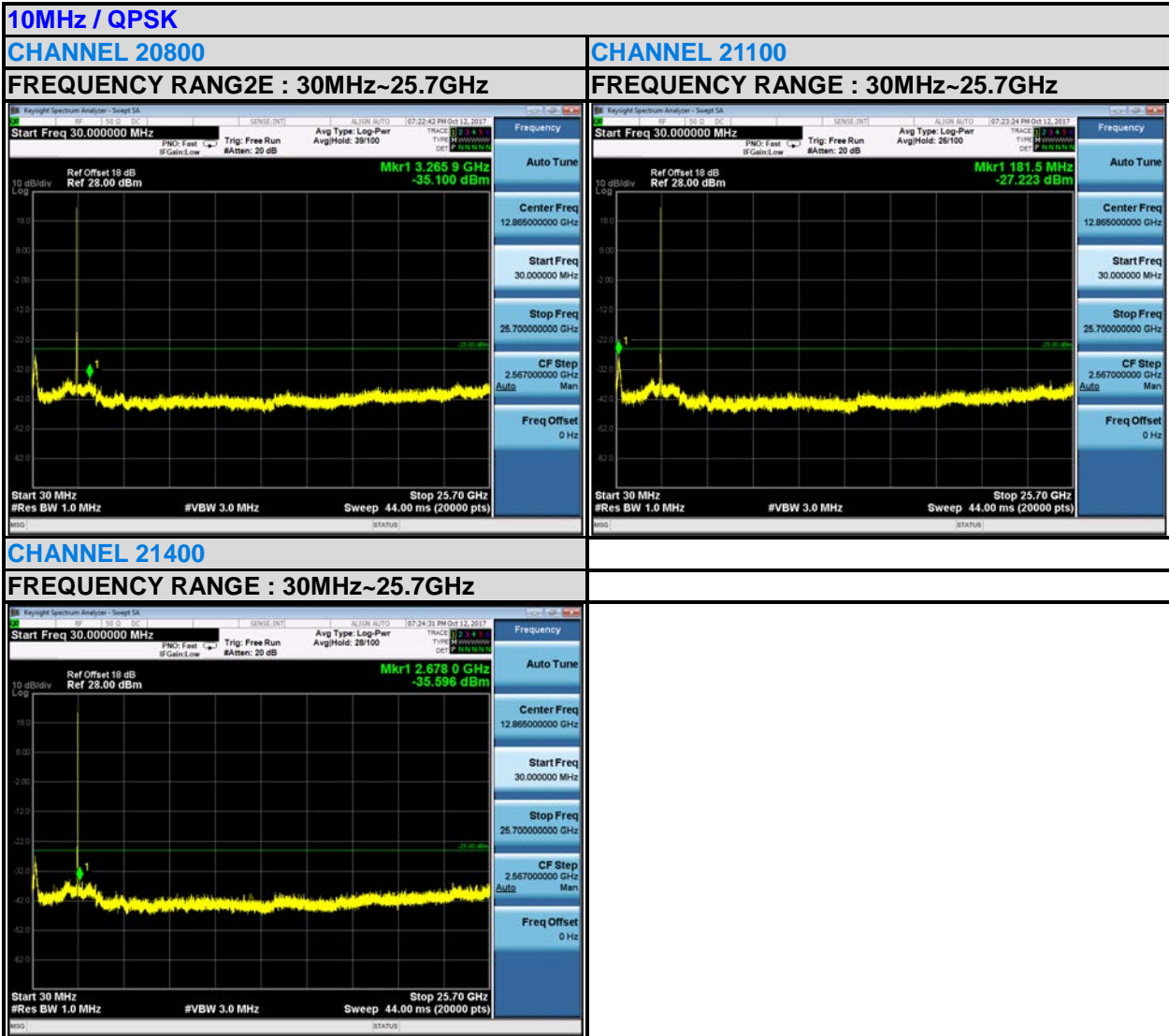





Test Report No.: RF170829W003-7

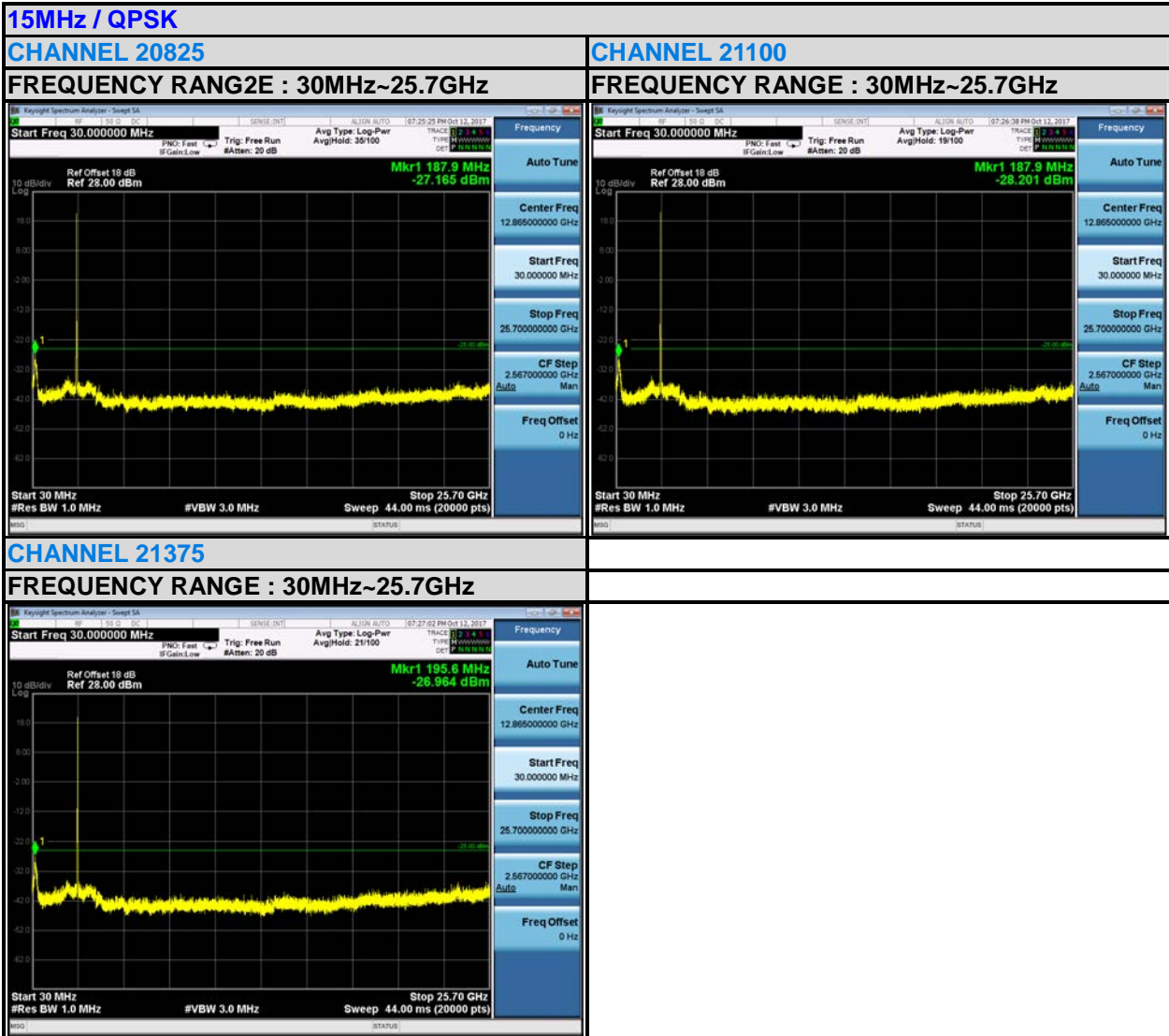



Test Report No.: RF170829W003-7

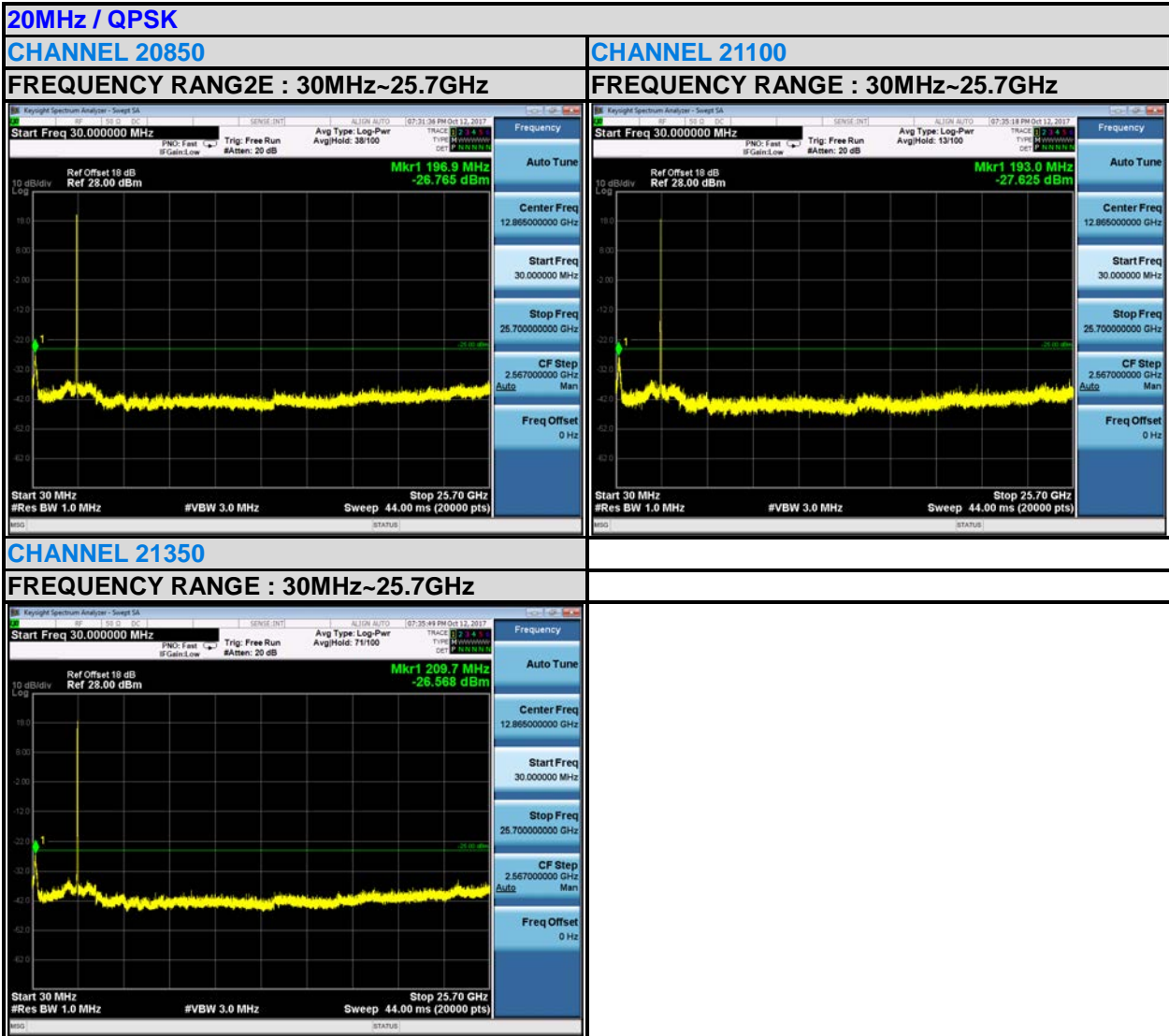

## 4.7 RADIATED EMISSION MEASUREMENT

### 4.7.1 LIMITS OF RADIATED EMISSION MEASUREMENT

The power of any emission outside a licensee's frequency block shall be attenuated below the transmitter power (P) by at least  $55 + 10 \log_{10}(P)$  dB. The limit of emission is equal to -25dBm.

### 4.7.2 TEST PROCEDURES

- a. Substitution method is used for E.I.R.P measurement. In the semi-anechoic chamber, EUT placed on the 0.8m height of Turn Table, rotated the table around 360 degrees to search the maximum radiation power and receiver antenna shall be rotated vertical and horizontal polarization and moved height from 1m to 4m to find the maximum polar radiated power. The "Read Value" is the spectrum reading the maximum power value.
- b. The substitution horn antenna is substituted for EUT at the same position and signals generator export the CW signal to the substitution antenna via a TX cable. Rotated the Turn Table and moved receiving antenna to find the maximum radiation power. Adjust output power level of S.G to get a Value of spectrum reading equal to "Read Value " of step a. Record the power level of S.G.
- c.  $EIRP = \text{Output power level of S.G} - \text{TX cable loss} + \text{Antenna gain of substitution horn}$ .
- d. E.R.P power can be calculated form E.I.R.P power by subtracting the gain of dipole,  $E.R.P \text{ power} = E.I.P.R \text{ power} - 2.15\text{dBi}$ .

**NOTE:** The resolution bandwidth of spectrum analyzer is 1 MHz and the video bandwidth is 3 MHz.

### 4.7.3 DEVIATION FROM TEST STANDARD

No deviation

#### 4.7.4 TEST SETUP

<Below 30MHz>

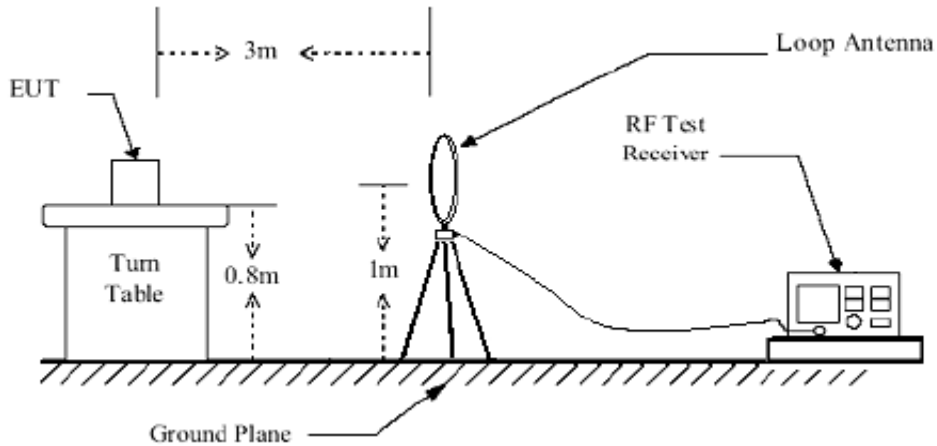

<Above 30MHz>

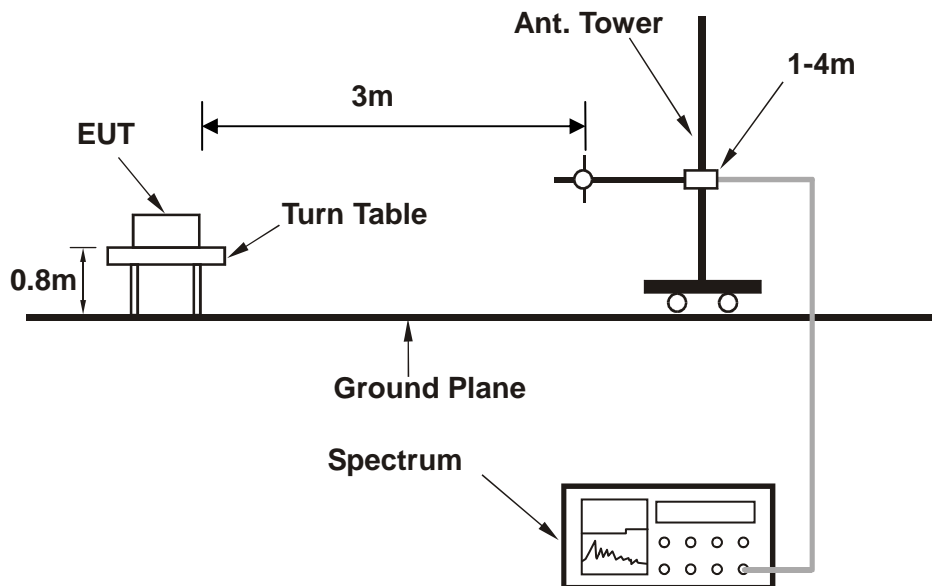

For the actual test configuration, please refer to the attached file (Test Setup Photo).



BUREAU VERITAS

Test Report No.: RF170829W003-7

### 4.7.5 TEST RESULTS

#### BELOW 1GHz WORST-CASE DATA

**9 KHz – 30 KHz data:** the amplitude of spurious emissions attenuated more than 20 dB below the permissible value is not required in the report.

**30 MHz – 1GHz data:**

#### LTE Band 7:

MODE	TX channel 21100	FREQUENCY RANGE	Below 1000MHz
ENVIRONMENTAL CONDITIONS	23deg. C, 70%RH	INPUT POWER	DC 5V from adapter
TESTED BY	Simon Yang		
<b>ANTENNA POLARITY &amp; TEST DISTANCE: HORIZONTAL AT 3 M</b>			

	Freq	Level	Read Level	Limit Line	Over Limit	Factor	Remark	Pol/Phase
	MHz	dBm/m	dBm	dBm/m	dB	dB/m		
1	PP	30.000	-41.66	-61.00	-25.00	-16.66	19.34 Peak	Horizontal
2		43.580	-47.37	-56.31	-25.00	-22.37	8.94 Peak	Horizontal
3		96.930	-58.10	-47.59	-25.00	-33.10	-10.51 Peak	Horizontal
4		106.630	-57.94	-45.40	-25.00	-32.94	-12.54 Peak	Horizontal
5		165.800	-63.13	-44.87	-25.00	-38.13	-18.26 Peak	Horizontal
6		189.080	-58.38	-40.86	-25.00	-33.38	-17.52 Peak	Horizontal

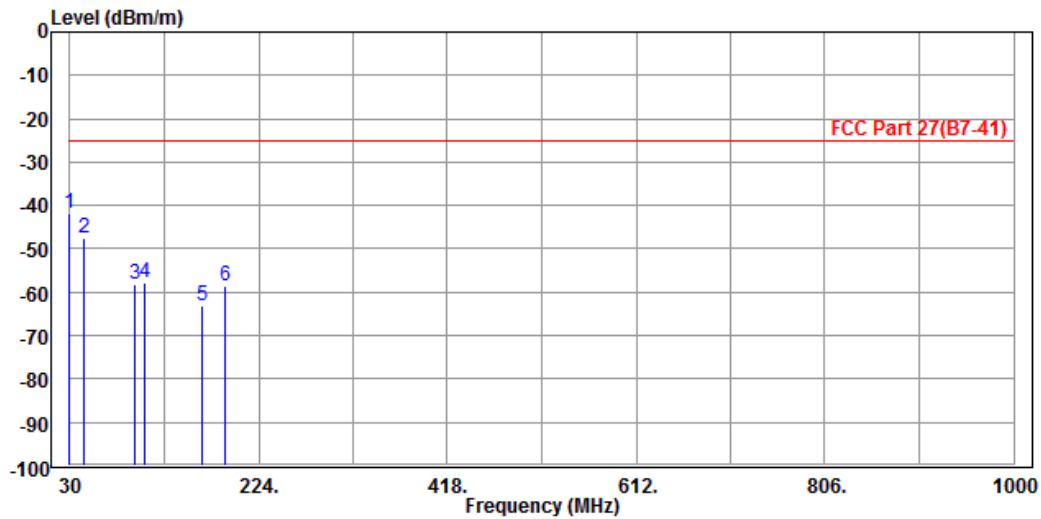



Test Report No.: RF170829W003-7

<b>MODE</b>	TX channel 21100	<b>FREQUENCY RANGE</b>	Below 1000MHz
<b>ENVIRONMENTAL CONDITIONS</b>	23deg. C, 70%RH	<b>INPUT POWER</b>	DC 5V from adapter
<b>TESTED BY</b>	Simon Yang		
<b>ANTENNA POLARITY &amp; TEST DISTANCE: VERTICAL AT 3 M</b>			

	Freq	Level	Read Level	Limit Line	Over Limit	Factor	Remark	Pol/Phase
	MHz	dBm/m	dBm	dBm/m	dB	dB/m		
1	47.460	-40.92	-36.98	-25.00	-15.92	-3.94	Peak	Vertical
2	68.800	-59.72	-44.53	-25.00	-34.72	-15.19	Peak	Vertical
3	96.930	-53.79	-43.16	-25.00	-28.79	-10.63	Peak	Vertical
4	137.670	-64.10	-49.28	-25.00	-39.10	-14.82	Peak	Vertical
5	164.830	-60.71	-45.95	-25.00	-35.71	-14.76	Peak	Vertical
6	188.110	-60.59	-48.45	-25.00	-35.59	-12.14	Peak	Vertical

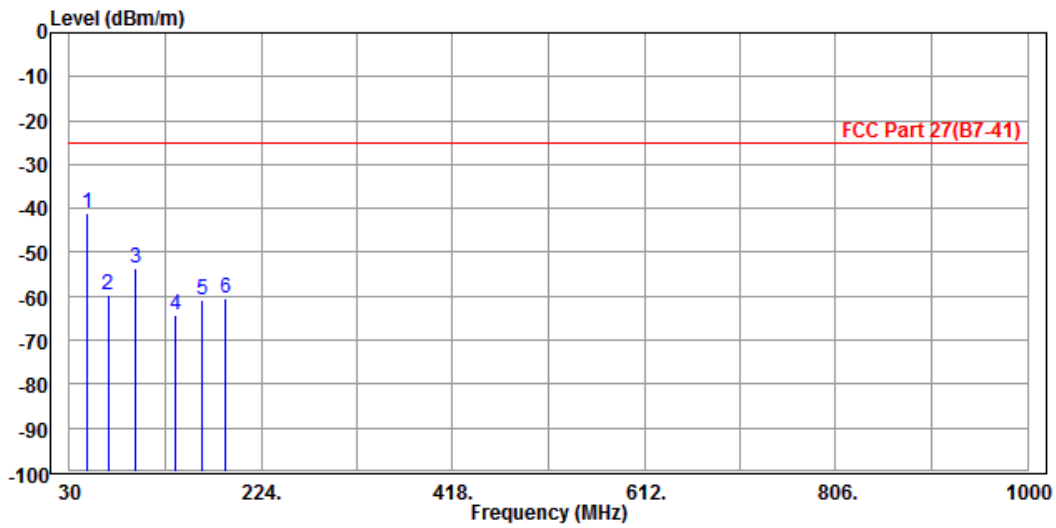



Test Report No.: RF170829W003-7

**ABOVE 1GHz**

**Note:** For higher frequency, the emission is too low to be detected.

**LTE Band 7**

**CHANNEL BANDWIDTH: 5MHz / QPSK**

<b>MODE</b>	TX channel 21100	<b>FREQUENCY RANGE</b>	Above 1000MHz
<b>ENVIRONMENTAL CONDITIONS</b>	23deg. C, 70%RH	<b>INPUT POWER</b>	DC 5V from adapter
<b>TESTED BY</b>	Simon Yang		
<b>ANTENNA POLARITY &amp; TEST DISTANCE: HORIZONTAL AT 3 M</b>			

	Freq	Level	Read Level	Limit Line	Over Limit	Factor	Remark	Pol/Phase
	MHz	dBm/m	dBm	dBm/m	dB	dB/m		
1 PP	5056.000	-44.74	-53.18	-25.00	-19.74	8.44	Peak	Horizontal
2	7605.000	-45.65	-59.13	-25.00	-20.65	13.48	Peak	Horizontal

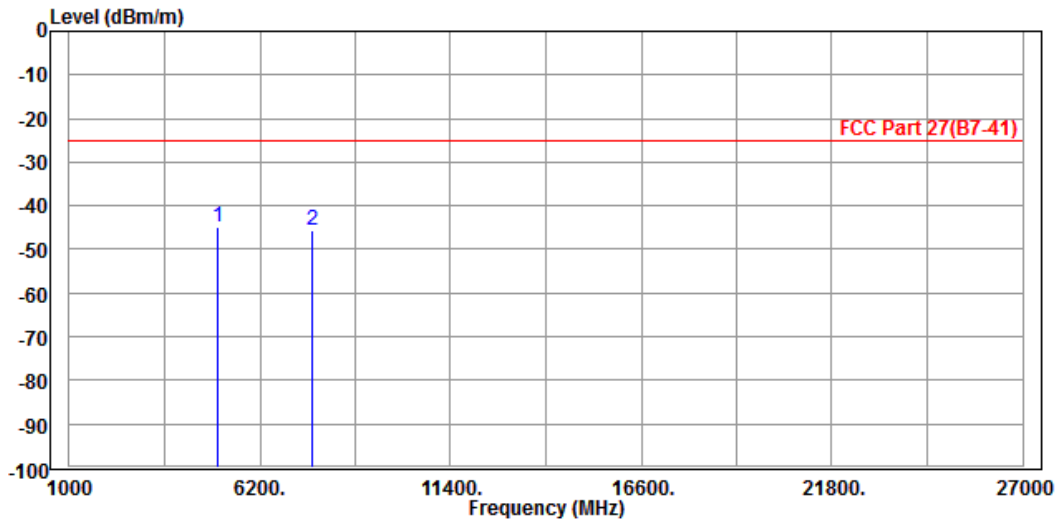



Test Report No.: RF170829W003-7

<b>MODE</b>	TX channel 21100	<b>FREQUENCY RANGE</b>	Above 1000MHz
<b>ENVIRONMENTAL CONDITIONS</b>	23deg. C, 70%RH	<b>INPUT POWER</b>	DC 5V from adapter
<b>TESTED BY</b>	Simon Yang		
<b>ANTENNA POLARITY &amp; TEST DISTANCE: VERTICAL AT 3 M</b>			

	Freq	Level	Read Level	Limit Line	Over Limit	Factor	Remark	Pol/Phase
	MHz	dBm/m	dBm	dBm/m	dB	dB/m		
1	5056.000	-45.91	-53.90	-25.00	-20.91	7.99	Peak	Vertical
2	PP 7605.000	-44.94	-57.93	-25.00	-19.94	12.99	Peak	Vertical

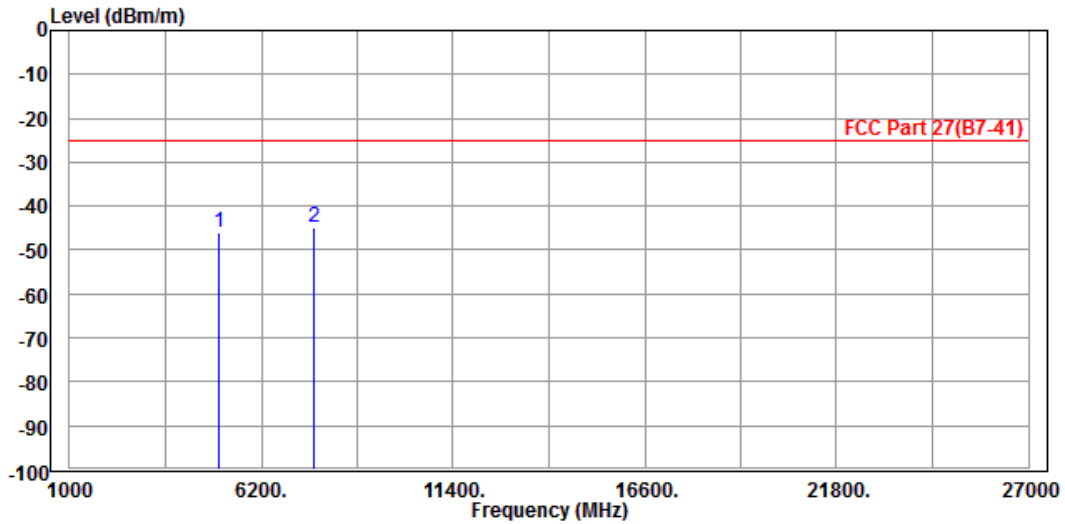





Test Report No.: RF170829W003-7

CHANNEL BANDWIDTH: 10MHz / QPSK

CH 20800

MODE	TX channel 20800	FREQUENCY RANGE	Above 1000MHz
ENVIRONMENTAL CONDITIONS	23deg. C, 70%RH	INPUT POWER	DC 5V from adapter
TESTED BY	Simon Yang		
<b>ANTENNA POLARITY &amp; TEST DISTANCE: HORIZONTAL AT 3 M</b>			

	Freq	Level	Read Level	Limit Line	Over Limit	Factor	Remark	Pol/Phase
	MHz	dBm/m	dBm	dBm/m	dB	dB/m		
1	PP 5004.000	-42.97	-51.35	-25.00	-17.97	8.38	Peak	Horizontal
2	7515.000	-46.58	-59.93	-25.00	-21.58	13.35	Peak	Horizontal

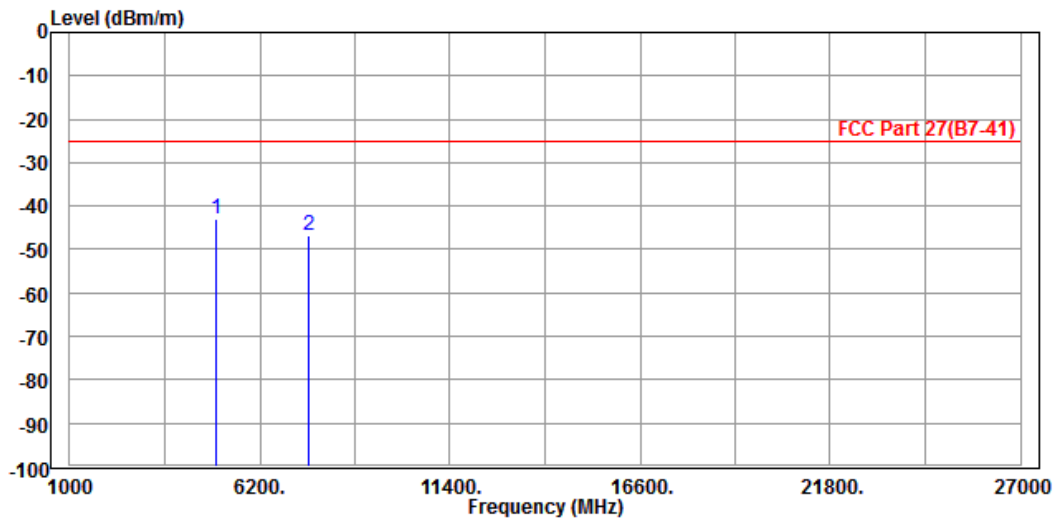



Test Report No.: RF170829W003-7

<b>MODE</b>	TX channel 20800	<b>FREQUENCY RANGE</b>	Above 1000MHz
<b>ENVIRONMENTAL CONDITIONS</b>	23deg. C, 70%RH	<b>INPUT POWER</b>	DC 5V from adapter
<b>TESTED BY</b>	Simon Yang		
<b>ANTENNA POLARITY &amp; TEST DISTANCE: VERTICAL AT 3 M</b>			

	Freq	Level	Read Level	Limit Line	Over Limit	Factor	Remark	Pol/Phase
	MHz	dBm/m	dBm	dBm/m	dB	dB/m		
1	5004.000	-47.80	-55.79	-25.00	-22.80	7.99	Peak	Vertical
2 PP	7515.000	-46.90	-59.73	-25.00	-21.90	12.83	Peak	Vertical

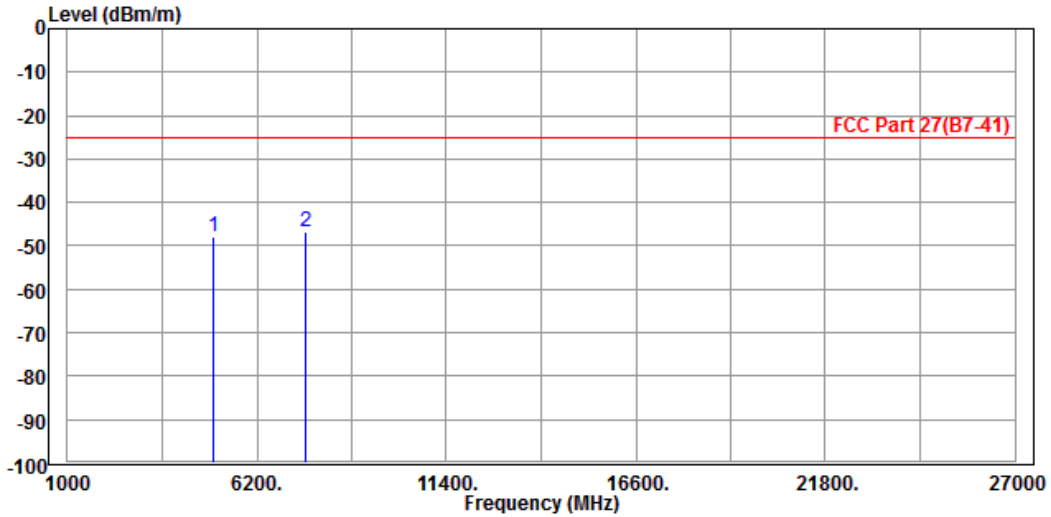



Test Report No.: RF170829W003-7

CH 21100

<b>MODE</b>	TX channel 21100	<b>FREQUENCY RANGE</b>	Above 1000MHz
<b>ENVIRONMENTAL CONDITIONS</b>	23deg. C, 70%RH	<b>INPUT POWER</b>	DC 5V from adapter
<b>TESTED BY</b>	Simon Yang		
<b>ANTENNA POLARITY &amp; TEST DISTANCE: HORIZONTAL AT 3 M</b>			

	Freq	Level	Read Level	Limit Line	Over Limit	Factor	Remark	Pol/Phase
	MHz	dBm/m	dBm	dBm/m	dB	dB/m		
1	PP 5056.000	-42.42	-50.86	-25.00	-17.42	8.44	Peak	Horizontal
2	7605.000	-45.29	-58.77	-25.00	-20.29	13.48	Peak	Horizontal

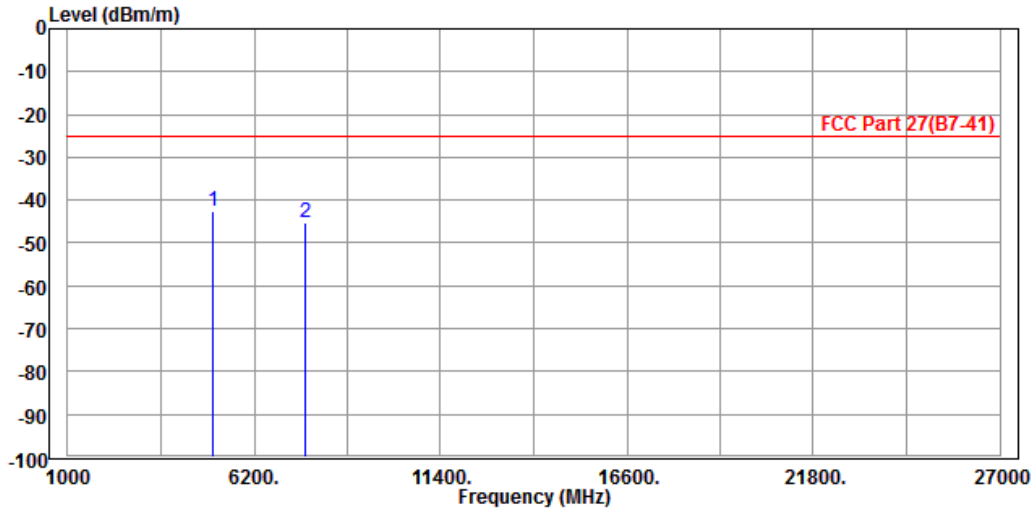



Test Report No.: RF170829W003-7

<b>MODE</b>	TX channel 21100	<b>FREQUENCY RANGE</b>	Above 1000MHz
<b>ENVIRONMENTAL CONDITIONS</b>	23deg. C, 70%RH	<b>INPUT POWER</b>	DC 5V from adapter
<b>TESTED BY</b>	Simon Yang		
<b>ANTENNA POLARITY &amp; TEST DISTANCE: VERTICAL AT 3 M</b>			

	Freq	Level	Read Level	Limit Line	Over Limit	Factor	Remark	Pol/Phase
	MHz	dBm/m	dBm	dBm/m	dB	dB/m		
1	PP 5056.000	-44.49	-52.48	-25.00	-19.49	7.99	Peak	Vertical
2	7605.000	-45.27	-58.26	-25.00	-20.27	12.99	Peak	Vertical

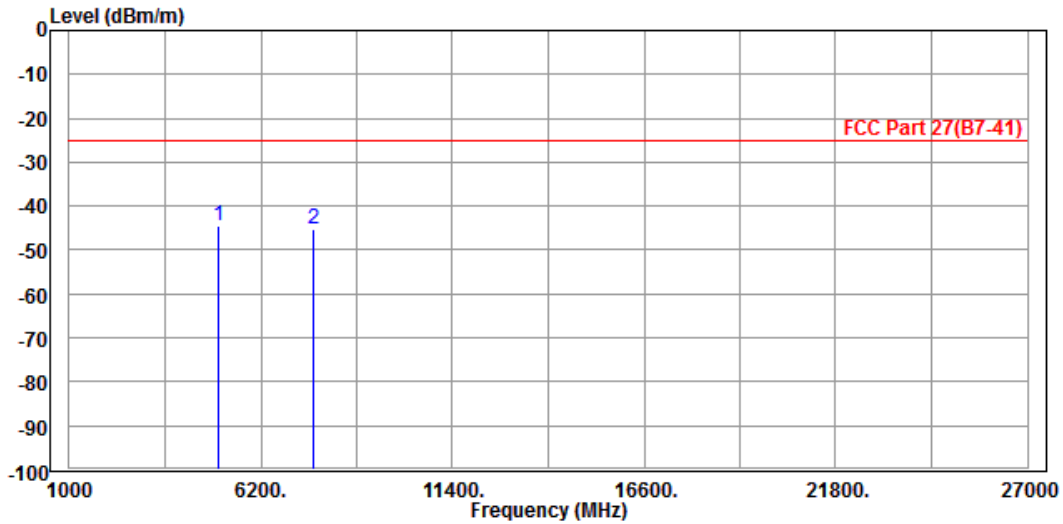



Test Report No.: RF170829W003-7

CH 21400

MODE	TX channel 21400	FREQUENCY RANGE	Above 1000MHz
ENVIRONMENTAL CONDITIONS	23deg. C, 70%RH	INPUT POWER	DC 5V from adapter
TESTED BY	Simon Yang		
ANTENNA POLARITY & TEST DISTANCE: HORIZONTAL AT 3 M			

	Freq	Level	Read Level	Limit Line	Over Limit	Factor	Remark	Pol/Phase
	MHz	dBm/m	dBm	dBm/m	dB	dB/m		
1	5134.000	-48.31	-56.84	-25.00	-23.31	8.53	Peak	Horizontal
2 PP	7695.000	-45.24	-58.85	-25.00	-20.24	13.61	Peak	Horizontal

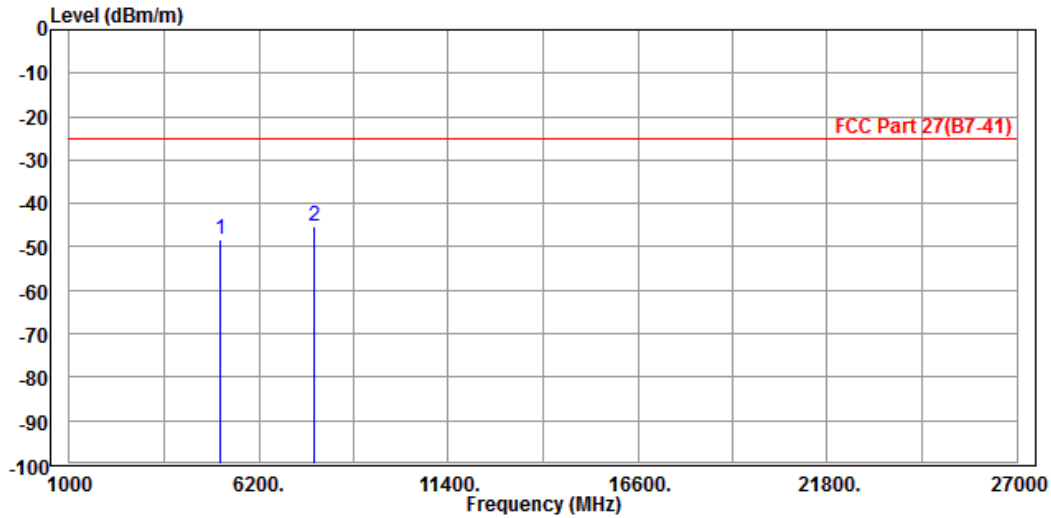



Test Report No.: RF170829W003-7

<b>MODE</b>	TX channel 21400	<b>FREQUENCY RANGE</b>	Above 1000MHz
<b>ENVIRONMENTAL CONDITIONS</b>	23deg. C, 70%RH	<b>INPUT POWER</b>	DC 5V from adapter
<b>TESTED BY</b>	Simon Yang		
<b>ANTENNA POLARITY &amp; TEST DISTANCE: VERTICAL AT 3 M</b>			

	Freq	Level	Read Level	Limit Line	Over Limit	Factor	Remark	Pol/Phase
	MHz	dBm/m	dBm	dBm/m	dB	dB/m		
1	5134.000	-48.14	-56.13	-25.00	-23.14	7.99	Peak	Vertical
2 PP	7695.000	-45.68	-58.83	-25.00	-20.68	13.15	Peak	Vertical

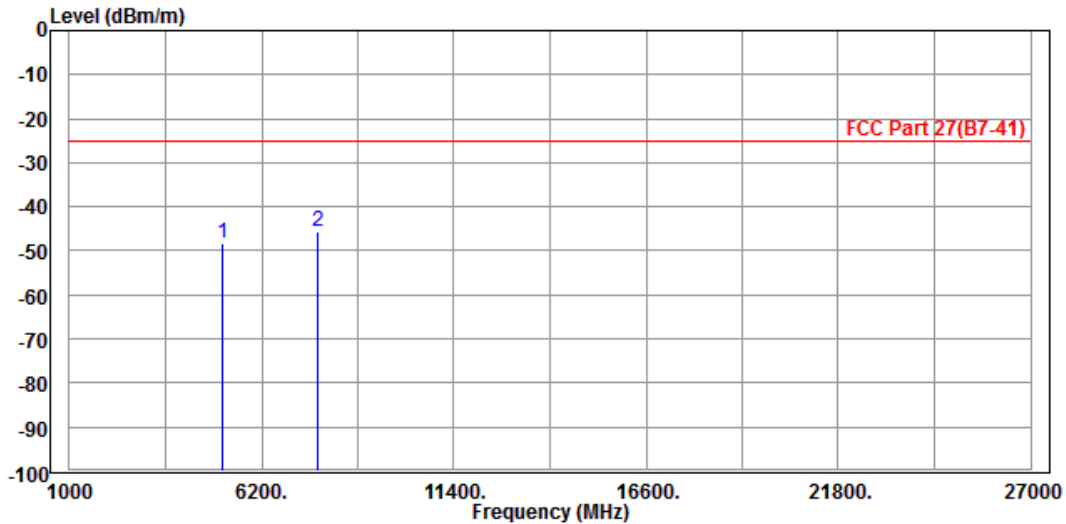



Test Report No.: RF170829W003-7

**CHANNEL BANDWIDTH: 15MHz / QPSK**

<b>MODE</b>	TX channel 21100	<b>FREQUENCY RANGE</b>	Above 1000MHz
<b>ENVIRONMENTAL CONDITIONS</b>	23deg. C, 70%RH	<b>INPUT POWER</b>	DC 5V from adapter
<b>TESTED BY</b>	Simon Yang		
<b>ANTENNA POLARITY &amp; TEST DISTANCE: HORIZONTAL AT 3 M</b>			

	Freq	Level	Read Level	Limit Line	Over Limit	Factor	Remark	Pol/Phase
	MHz	dBm/m	dBm	dBm/m	dB	dB/m		
1	PP 5056.000	-44.32	-52.76	-25.00	-19.32	8.44	Peak	Horizontal
2	7605.000	-45.94	-59.42	-25.00	-20.94	13.48	Peak	Horizontal

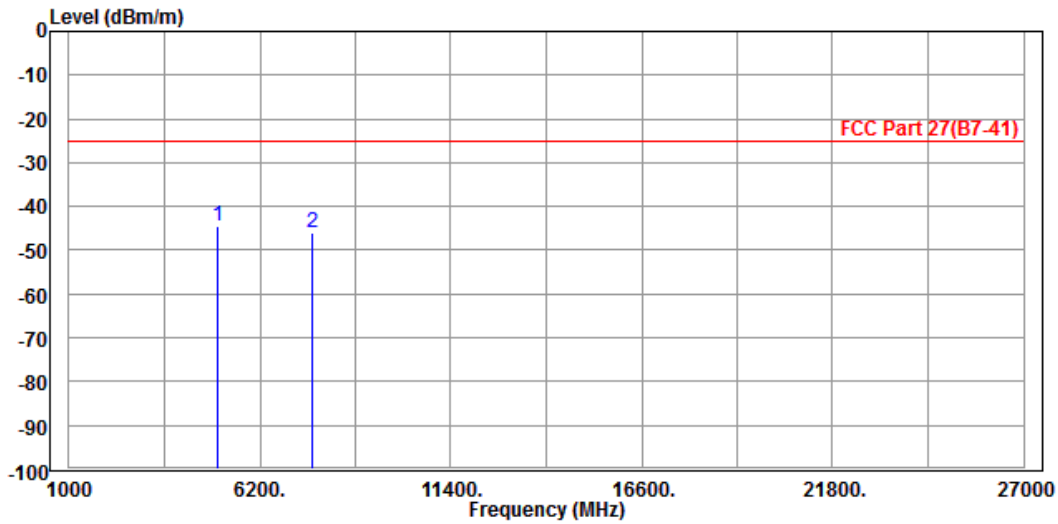



Test Report No.: RF170829W003-7

<b>MODE</b>	TX channel 21100	<b>FREQUENCY RANGE</b>	Above 1000MHz
<b>ENVIRONMENTAL CONDITIONS</b>	23deg. C, 70%RH	<b>INPUT POWER</b>	DC 5V from adapter
<b>TESTED BY</b>	Simon Yang		
<b>ANTENNA POLARITY &amp; TEST DISTANCE: VERTICAL AT 3 M</b>			

	Freq	Level	Read Level	Limit Line	Over Limit	Factor	Remark	Pol/Phase
	MHz	dBm/m	dBm	dBm/m	dB	dB/m		
1	5056.000	-45.90	-53.89	-25.00	-20.90	7.99	Peak	Vertical
2 PP	7605.000	-45.80	-58.79	-25.00	-20.80	12.99	Peak	Vertical

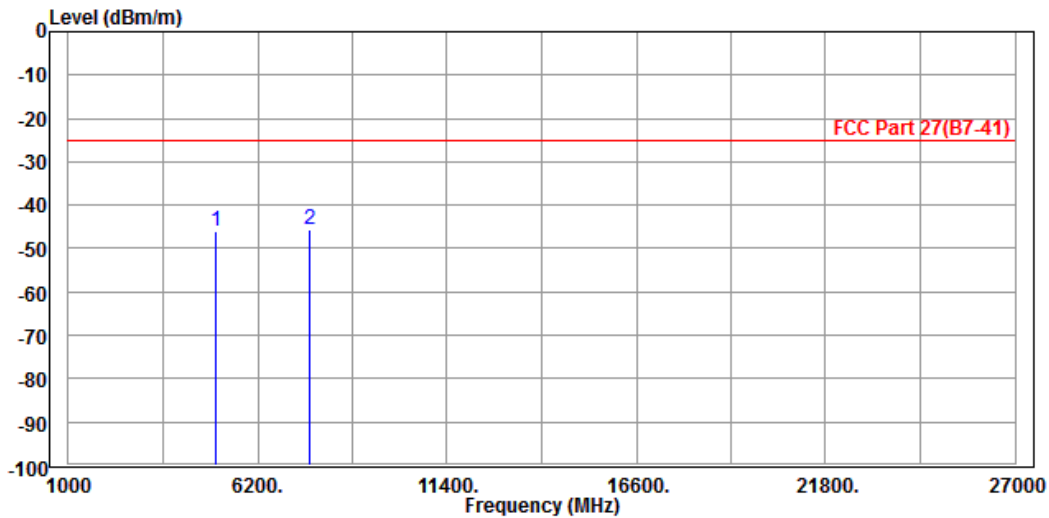





Test Report No.: RF170829W003-7

**CHANNEL BANDWIDTH: 20MHz / QPSK**

<b>MODE</b>	TX channel 21100	<b>FREQUENCY RANGE</b>	Above 1000MHz
<b>ENVIRONMENTAL CONDITIONS</b>	23deg. C, 70%RH	<b>INPUT POWER</b>	DC 5V from adapter
<b>TESTED BY</b>	Simon Yang		
<b>ANTENNA POLARITY &amp; TEST DISTANCE: HORIZONTAL AT 3 M</b>			

	Freq	Level	Read Level	Limit Line	Over Limit	Factor	Remark	Pol/Phase
	MHz	dBm/m	dBm	dBm/m	dB	dB/m		
1	5056.000	-45.26	-53.70	-25.00	-20.26	8.44	Peak	Horizontal
2	7605.000	-45.06	-58.54	-25.00	-20.06	13.48	Peak	Horizontal

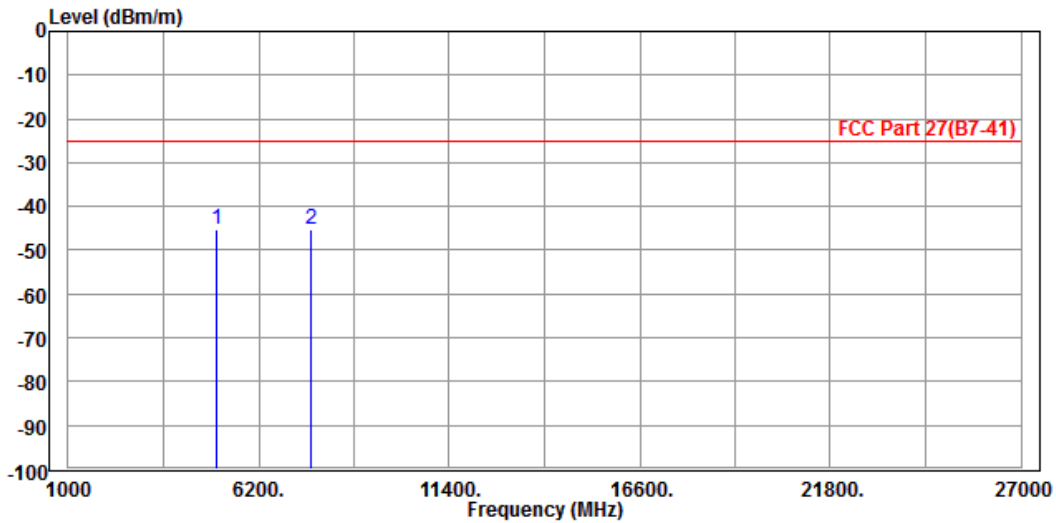



Test Report No.: RF170829W003-7

<b>MODE</b>	TX channel 21100	<b>FREQUENCY RANGE</b>	Above 1000MHz
<b>ENVIRONMENTAL CONDITIONS</b>	23deg. C, 70%RH	<b>INPUT POWER</b>	DC 5V from adapter
<b>TESTED BY</b>	Simon Yang		
<b>ANTENNA POLARITY &amp; TEST DISTANCE: VERTICAL AT 3 M</b>			

	Freq	Level	Read Level	Limit Line	Over Limit	Factor	Remark	Pol/Phase
	MHz	dBm/m	dBm	dBm/m	dB	dB/m		
1	PP 5056.000	-43.48	-51.47	-25.00	-18.48	7.99	Peak	Vertical
2	7605.000	-45.82	-58.81	-25.00	-20.82	12.99	Peak	Vertical

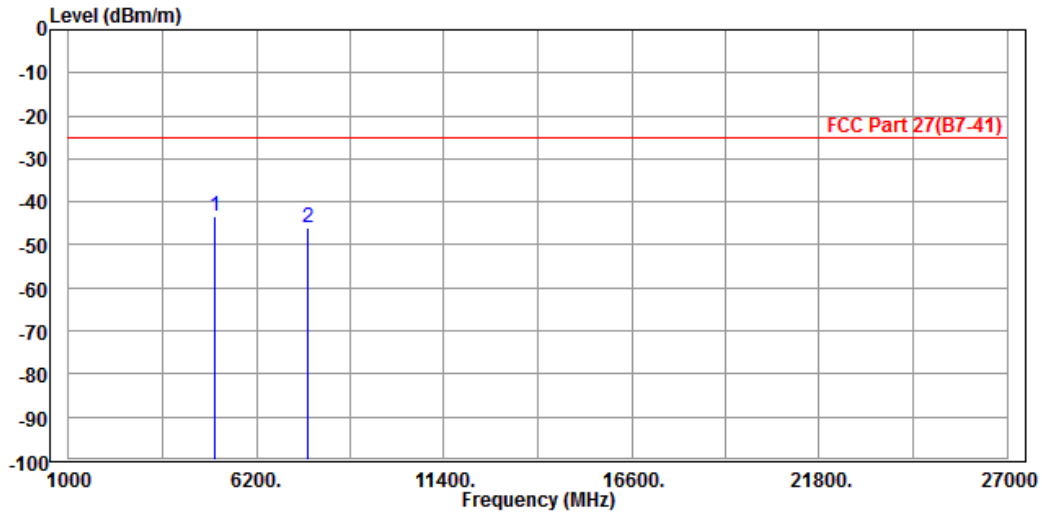



Test Report No.: RF170829W003-7

## 5 INFORMATION ON THE TESTING LABORATORIES

We, BV 7LAYERS COMMUNICATIONS TECHNOLOGY (SHENZHEN) CO. LTD., were founded in 2015 to provide our best service in EMC, Radio, Telecom and Safety consultation. Our laboratories are accredited and approved according to ISO/IEC 17025.

If you have any comments, please feel free to contact us at the following:

**Shenzhen EMC/RF Lab:**

Tel: +86-755-88696566

Fax: +86-755-88696577

**Email:** [customerservice.dg@cn.bureauveritas.com](mailto:customerservice.dg@cn.bureauveritas.com)

**Web Site:** [www.adt.com.tw](http://www.adt.com.tw)

The address and road map of all our labs can be found in our web site also.



Test Report No.: RF170829W003-7

## 6 APPENDIX A – MODIFICATIONS RECORDERS FOR ENGINEERING CHANGES TO THE EUT BY THE LAB

No any modifications are made to the EUT by the lab during the test.

---END---