

LTE Cat NB1 Band 71. QPSK. BW=15 kHz. Tone Number=12. Tone Offset=0. MSC/TBS=5.

Low Channel:

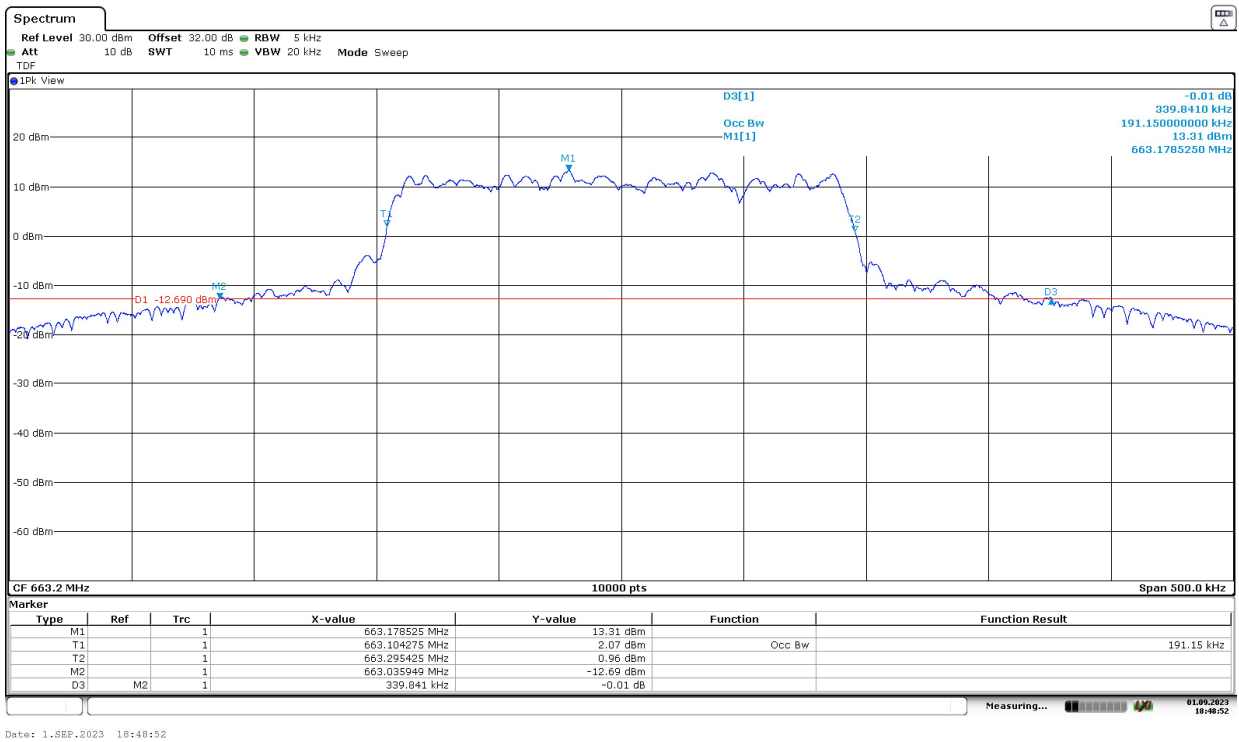

Middle Channel:

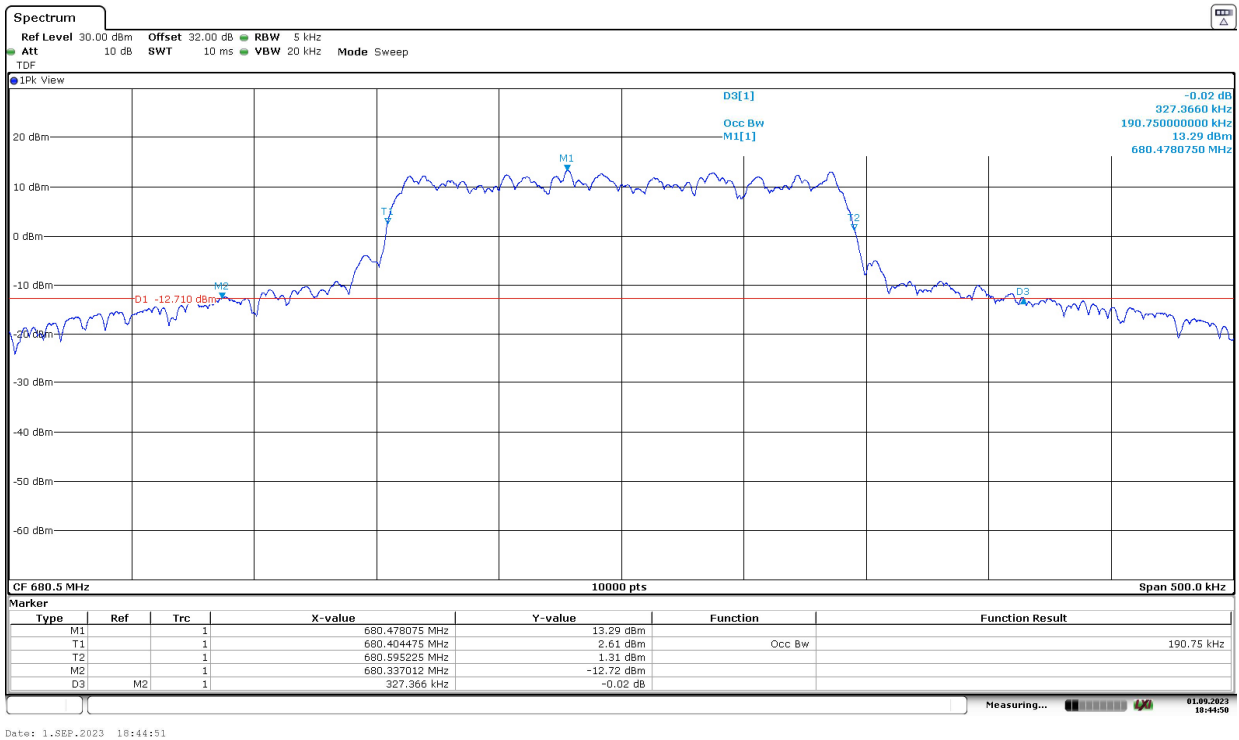

High Channel:

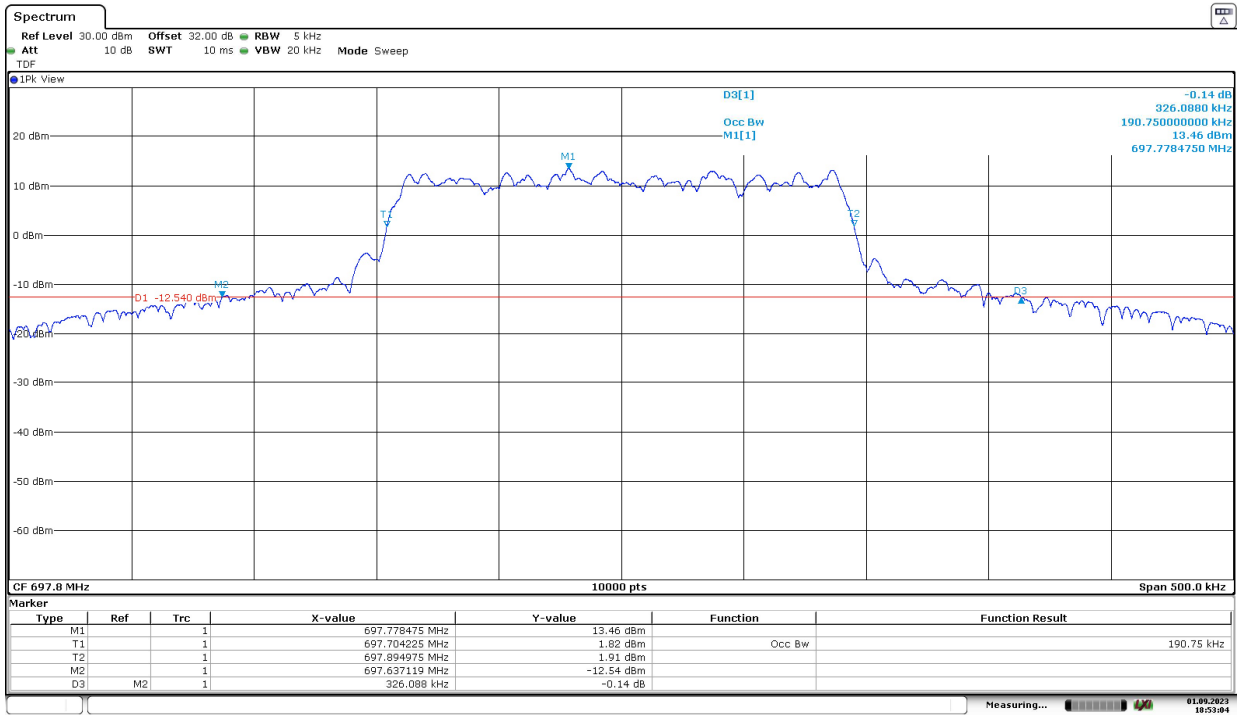

Date: 1.SEP.2023 18:53:05

LTE Cat NB1 Band 85:

LTE Cat NB1 Band 85. Pi/2-BPSK. BW=3.75 kHz. Tone Number=1. Tone Offset=23. MSC/TBS=0.

	Low Channel	Middle Channel	High Channel
99% Occupied Bandwidth (kHz)	57.510	58.200	58.380
-26 dBc Bandwidth (kHz)	40.991	37.457	39.841
Measurement uncertainty (kHz)	<±0.35		

LTE Cat NB1 Band 85. Pi/4-QPSK. BW=3.75 kHz. Tone Number=1. Tone Offset=23. MSC/TBS=3.

	Low Channel	Middle Channel	High Channel
99% Occupied Bandwidth (kHz)	62.610	63.000	62.910
-26 dBc Bandwidth (kHz)	41.797	41.814	42.084
Measurement uncertainty (kHz)	<±0.35		

LTE Cat NB1 Band 85. Pi/2-BPSK. BW=3.75 kHz. Tone Number=1. Tone Offset=23. MSC/TBS=0.

Low Channel:

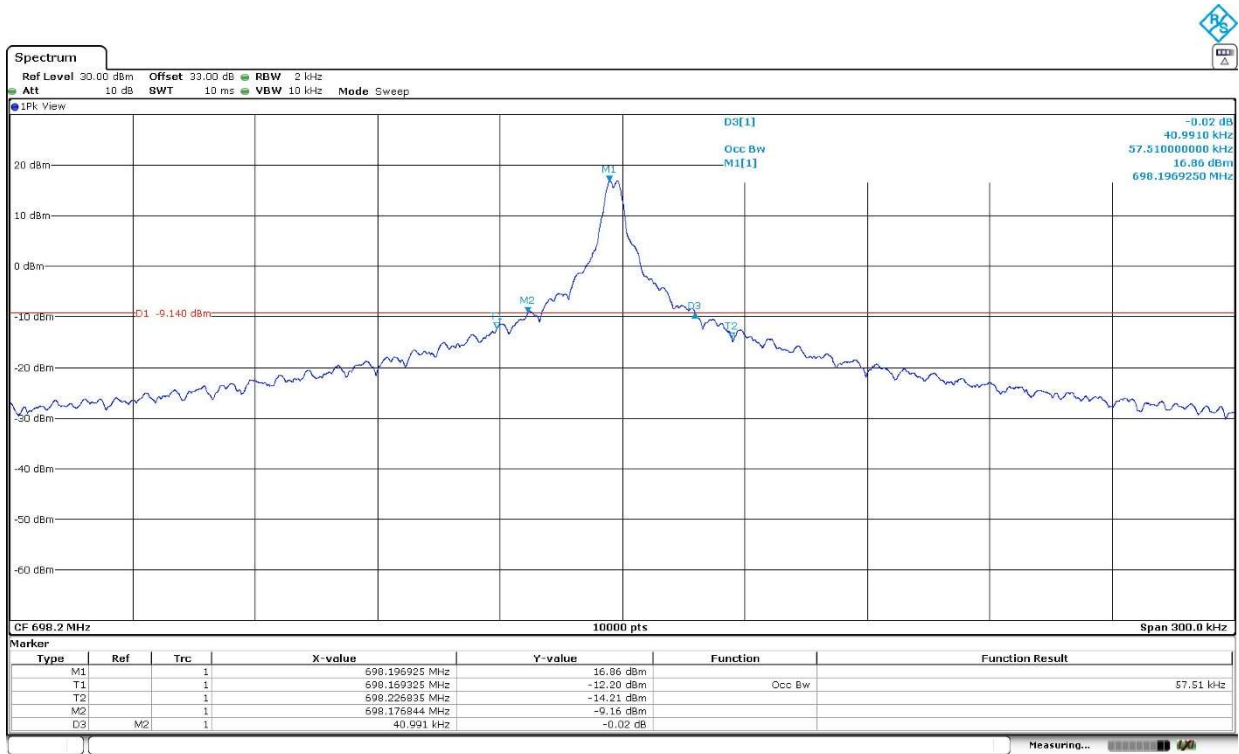

Middle Channel:

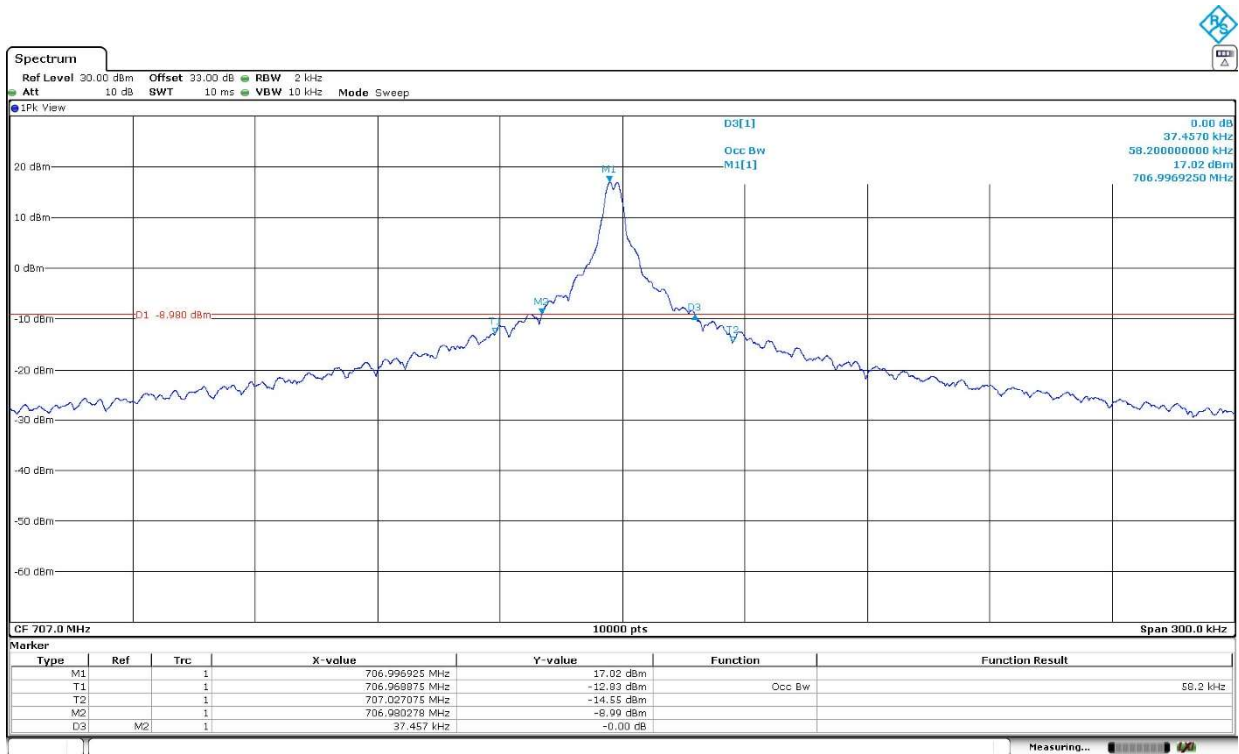

High Channel:

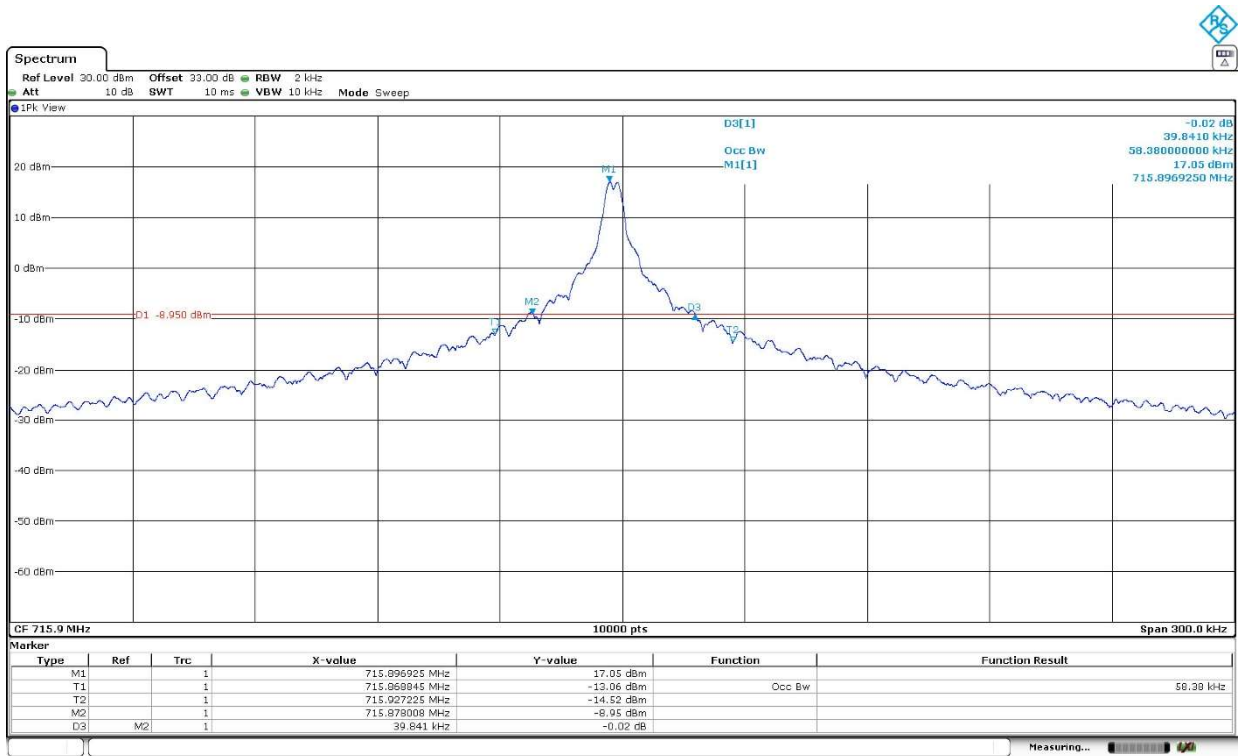

LTE Cat NB1 Band 85. Pi/4-QPSK. BW=3.75 kHz. Tone Number=1. Tone Offset=23. MSC/TBS=3.

Low Channel:

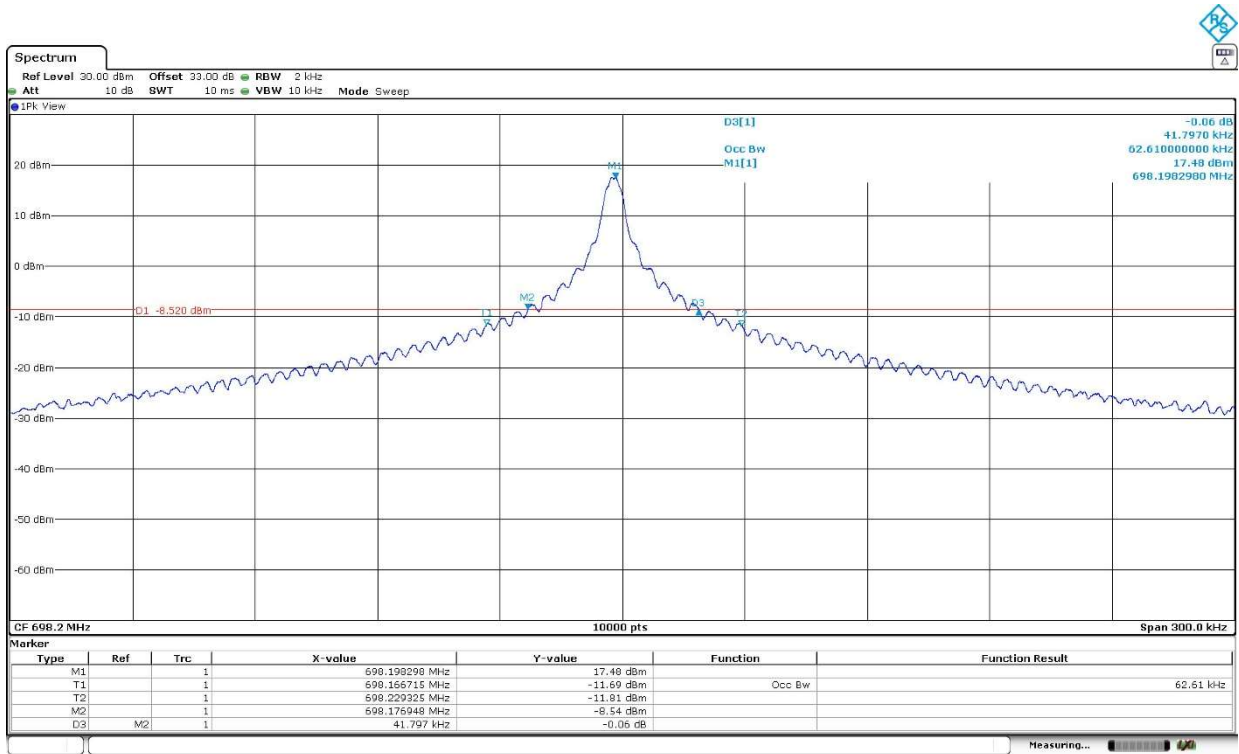

Middle Channel:

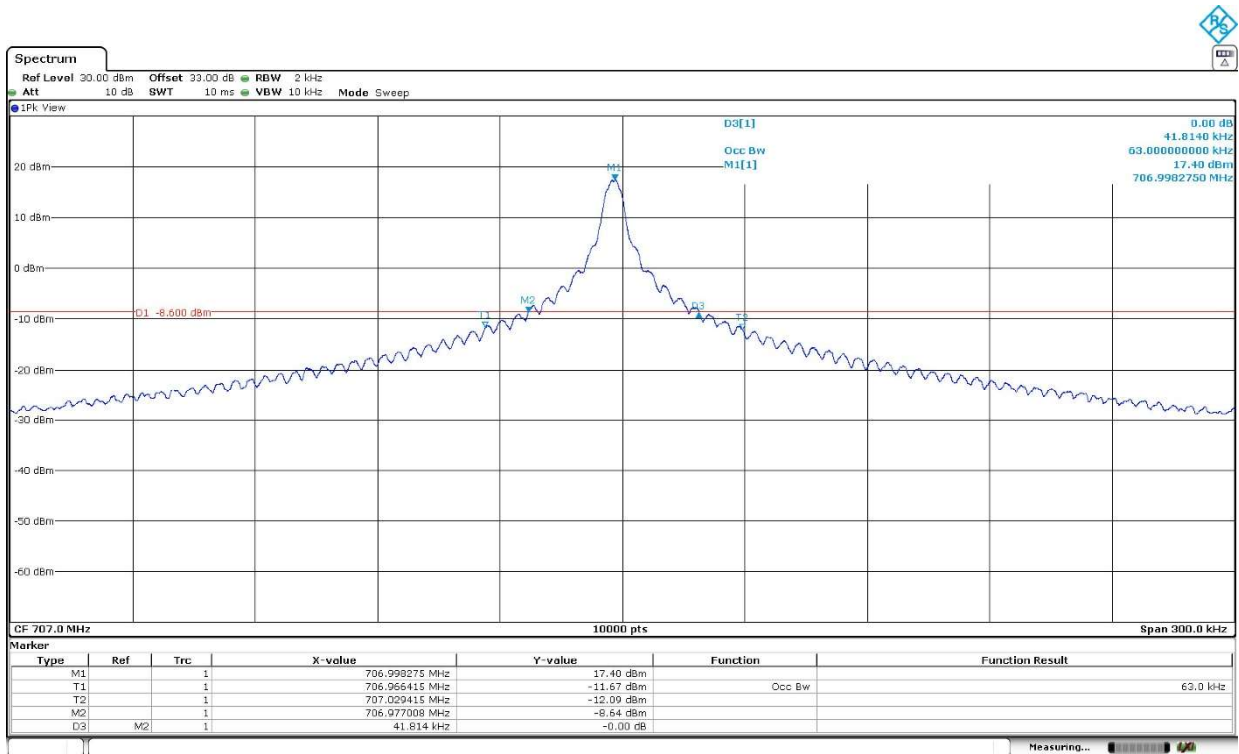

High Channel:

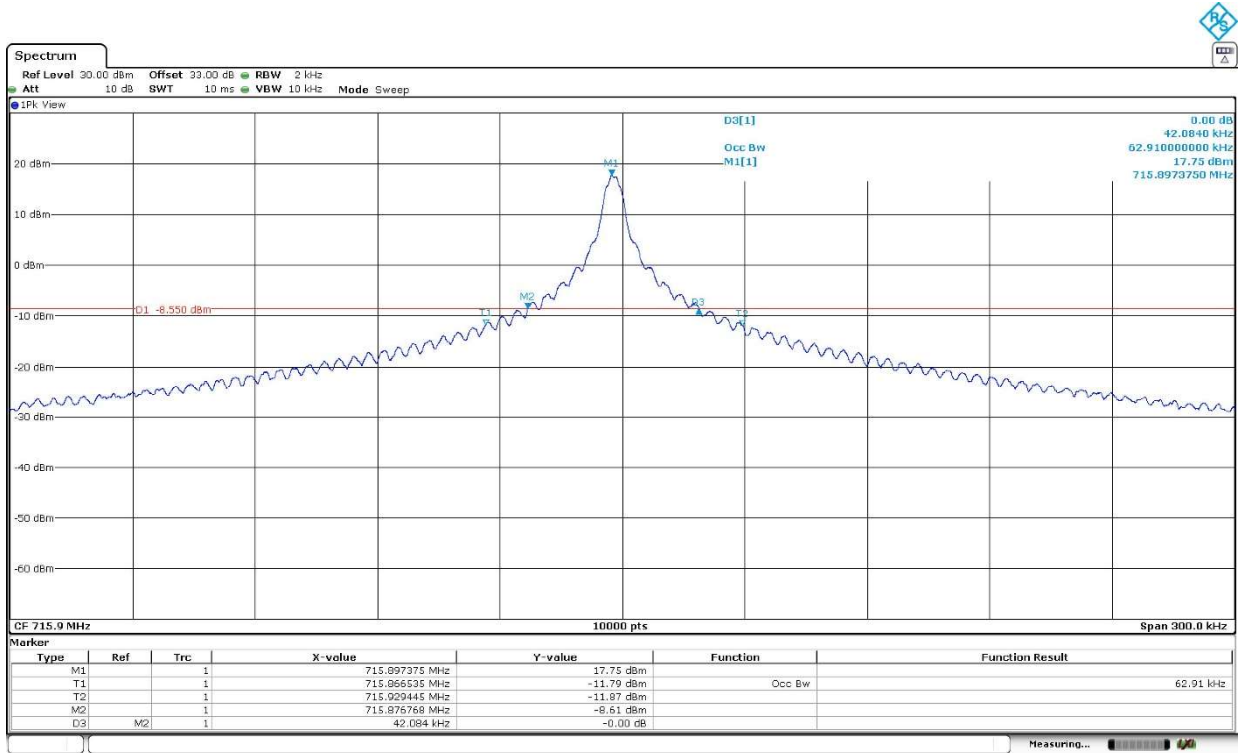

LTE Cat NB1 Band 85. Pi/2-BPSK. BW=15 kHz. Tone Number=1. Tone Offset=5. MSC/TBS=0.

	Low Channel	Middle Channel	High Channel
99% Occupied Bandwidth (kHz)	124.740	124.920	125.400
-26 dBc Bandwidth (kHz)	123.102	122.845	123.175
Measurement uncertainty (kHz)	<±0.58		

LTE Cat NB1 Band 85. QPSK. BW=15 kHz. Tone Number=12. Tone Offset=0. MSC/TBS=5.

	Low Channel	Middle Channel	High Channel
99% Occupied Bandwidth (kHz)	189.950	189.800	190.150
-26 dBc Bandwidth (kHz)	313.124	335.930	312.272
Measurement uncertainty (kHz)	<±0.58		

LTE Cat NB1 Band 85. Pi/2-BPSK. BW=15 kHz. Tone Number=1. Tone Offset=5. MSC/TBS=0.

Low Channel:

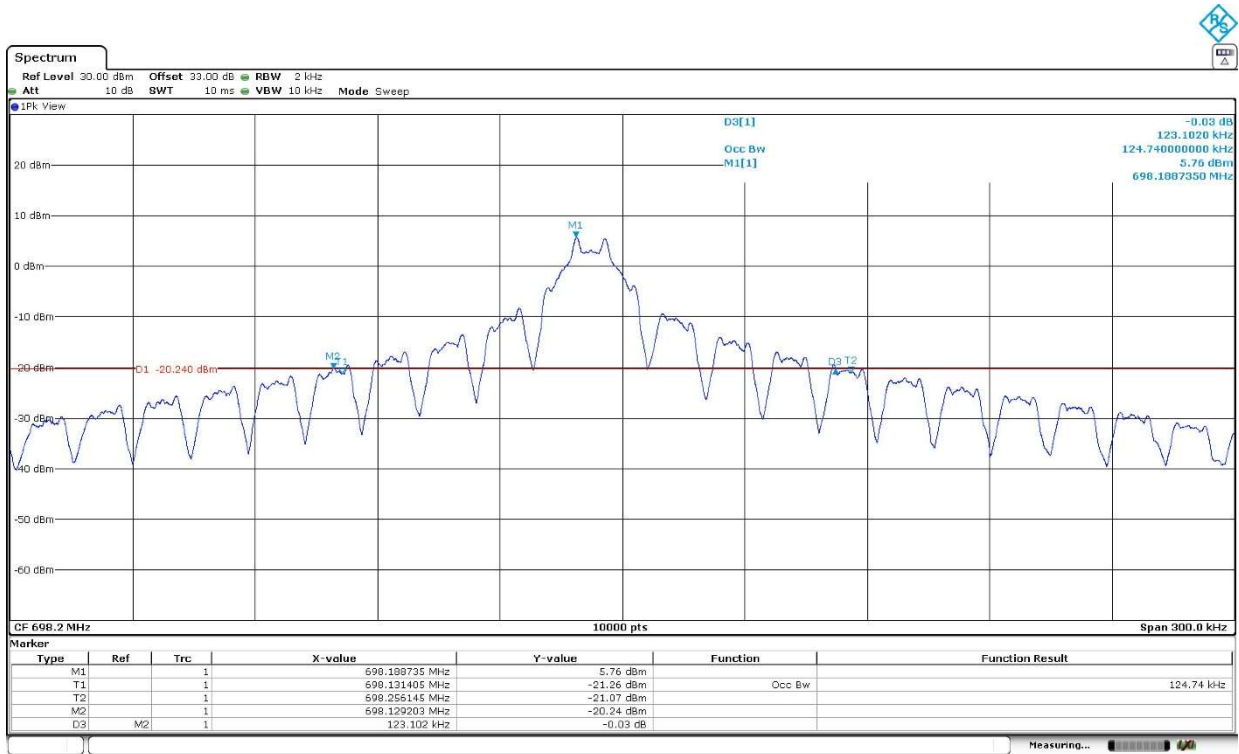

Middle Channel:

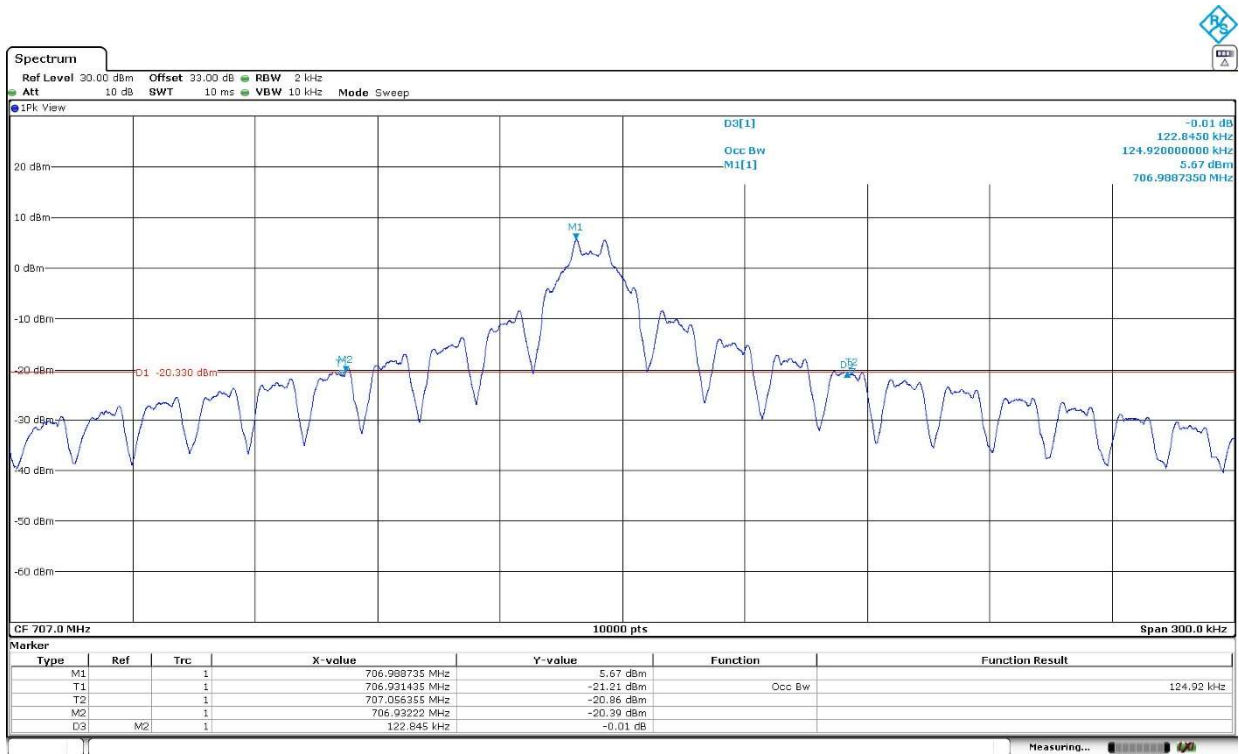

High Channel:

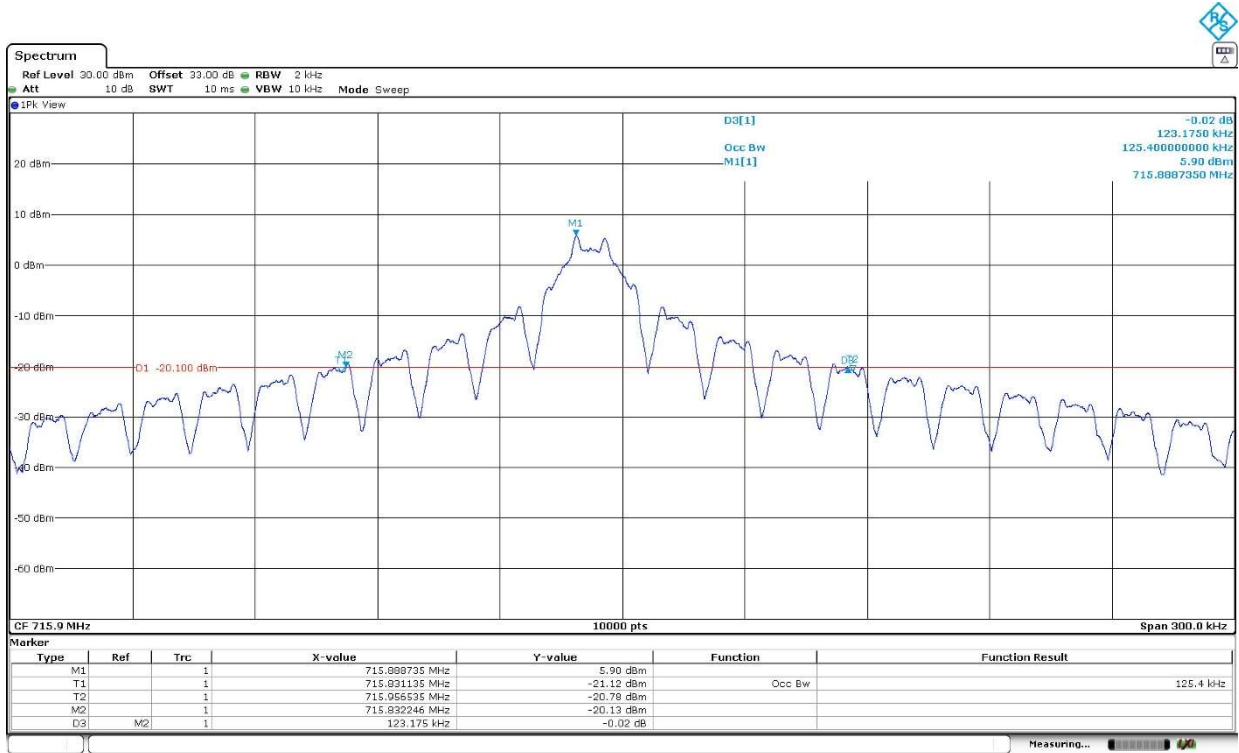

LTE Cat NB1 Band 85. QPSK. BW=15 kHz. Tone Number=12. Tone Offset=0. MSC/TBS=5.

Low Channel:

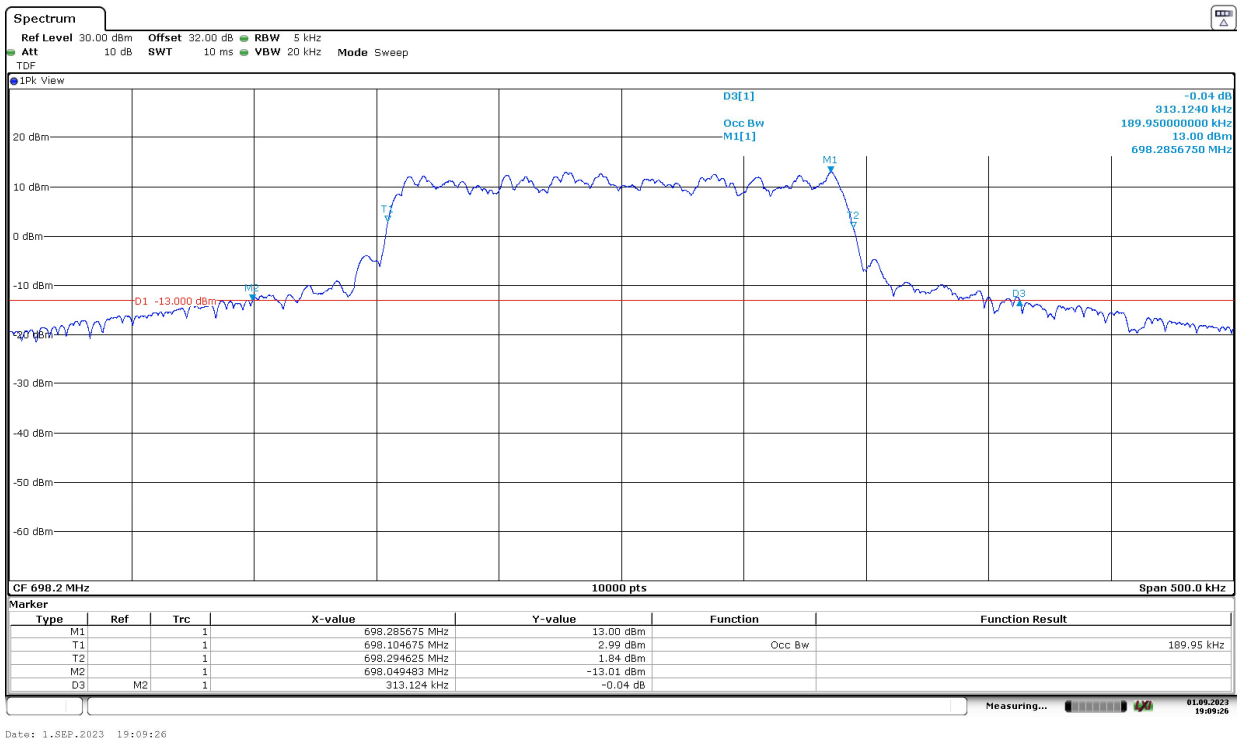

Middle Channel:

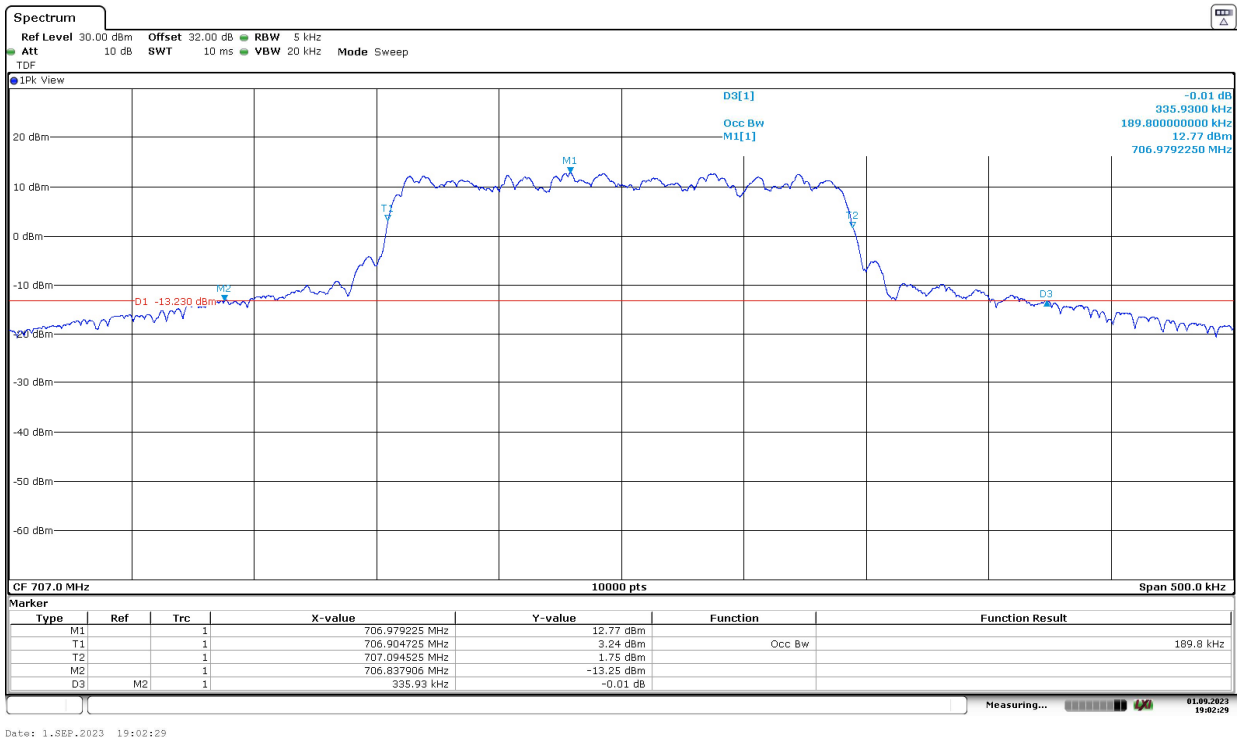

High Channel:

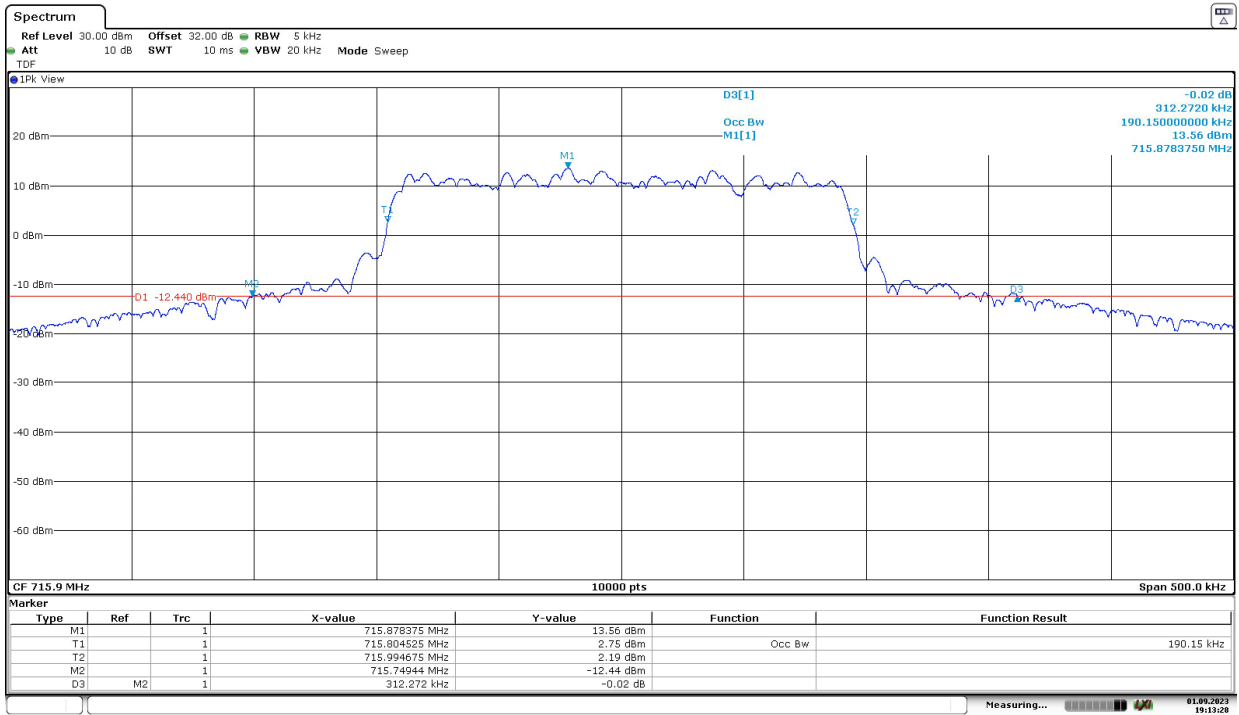

Date: 1.SEP.2023 19:13:29

Spurious emissions at antenna terminals

Limits

1. LTE Cat NB1 Band 8. FCC §27.1509 (a).

FCC §27.1509 (a):

The power of any emission outside a licensee's frequency band(s) of operation shall be attenuated below the transmitter power (P) in watts by at least the following amounts:

- (a) For 900 MHz broadband operations in 897.5–900.5 MHz band by at least $43 + 10 \log (P)$ dB.

2. LTE Cat NB1 Band 13.

FCC §27.53 (c):

On any frequency outside the 776-788 MHz band, the power of any emission shall be attenuated outside the band below the transmitter power (P) by at least $43 + 10 \log (P)$ dB. Compliance is based on the use of measurement instrumentation employing a resolution bandwidth of 100 kHz or greater.

On all frequencies between 763-775 MHz and 793-805 MHz, by a factor not less than $65 + 10 \log (P)$ dB in a 6.25 kHz band segment, for mobile and portable stations. Compliance is based on the use of measurement instrumentation such that the reading taken with any resolution bandwidth setting should be adjusted to indicate spectral energy in a 6.25 kHz segment.

RSS-130, Clause 4.7.2:

The power of any unwanted emissions in any 6.25 kHz bandwidth for all frequencies between 763-775 MHz and 793-806 MHz shall be attenuated below the transmitter power, P (dBW), by at least $65 + 10 \log_{10} p(\text{watts})$, dB, for mobile and portable equipment.

3. LTE Cat NB1 Band 66.

FCC §27.53 (h), RSS-139, Clause 6.6:

According to specification, for operations in the 1695-1710 MHz, 1710-1755 MHz, 1755-1780 MHz, 1915-1920 MHz, 1995-2000 MHz, 2000-2020 MHz, 2110-2155 MHz, 2155-2180 MHz, and 2180-2200 bands, the power of any emission outside a licensee's frequency block shall be attenuated below the transmitter power (P) in watts by at least $43 + 10 \log_{10} (P)$ dB. Compliance with this provision is based on the use of measurement instrumentation employing a resolution bandwidth of 1 megahertz or greater.

4. LTE Cat NB1 Band 71 & LTE Cat NB1 Band 85.

FCC §27.53 (g):

For operations in the 600 MHz band and the 698-746 MHz band, the power of any emission outside a licensee's frequency band(s) of operation shall be attenuated below the transmitter power (P) within the licensed band(s) of operation, measured in watts, by at least $43 + 10 \log (P)$ dB. Compliance with this provision is based on the use of measurement instrumentation employing a resolution bandwidth of 100 kilohertz or greater.

RSS-130, Clause 4.7.1:

The unwanted emissions in any 100 kHz bandwidth on any frequency outside the low frequency edge and the high frequency edge of each frequency block range(s), shall be attenuated below the transmitter power, P (dBW), by at least $43 + 10 \log_{10} p(\text{watts})$, dB.

At P_o transmitting power, the specified minimum attenuation becomes $43+10 \log (P_o)$, and the level in dBm relative to P_o becomes:

$$P_o \text{ (dBm)} - [43 + 10 \log (P_o \text{ in mW}) - 30] = -13 \text{ dBm}$$

At P_o transmitting power, the specified minimum attenuation becomes $65+10 \log (P_o)$, and the level in dBm relative to P_o becomes:

$$P_o \text{ (dBm)} - [65 + 10 \log (P_o \text{ in mW}) - 30] = -35 \text{ dBm}$$

Method

The EUT RF output connector was connected to a spectrum analyser and to the Universal Radio Communication tester R&S CMW500 (selecting maximum transmission power of the EUT and different modes of modulation) using a 50-Ohm attenuator and a power divider.

The spectrum was investigated from 9 kHz to 10 GHz for LTE Cat NB1 Bands 8, 13, 71 & 85 and from 9 kHz to 20 GHz for LTE Cat NB1 Band 66.

The reading of the spectrum analyser is corrected with the attenuation loss of connection between output terminal of EUT and input of the spectrum analyser.

The configuration of Resource Blocks and modulation which is the worst case for conducted power was used.

Test Setup

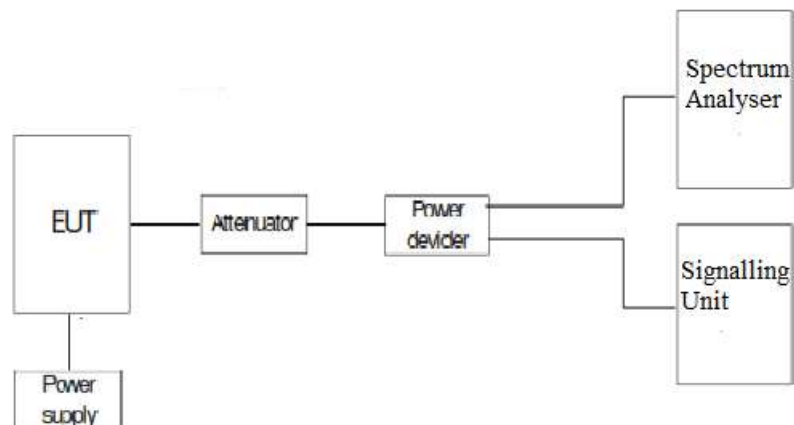

Results

The next results are for the worst-case configuration for each LTE Cat NB1 Band.

LTE Cat NB1 Band 8:

A preliminary scan determined the worst-case:

Pi/2-BPSK. BW=15 kHz. Tone Number=3. Tone Offset=0. MSC/TBS=0.

Frequency range 9 KHz - 10 GHz:

- Low Channel: No spurious frequencies at less than 20 dB below the limit.
- High Channel: No spurious frequencies at less than 20 dB below the limit.

LTE Cat NB1 Band 13:

A preliminary scan determined the worst-case:

Pi/2-BPSK. BW=15 kHz. Tone Number=1. Tone Offset=0. MSC/TBS=0.

Frequency range 9 KHz - 10 GHz:

- Low Channel: No spurious frequencies at less than 20 dB below the limit.
- High Channel: No spurious frequencies at less than 20 dB below the limit.

LTE Cat NB1 Band 66:

A preliminary scan determined the worst-case:

Pi/2-BPSK. BW=3.75 kHz. Tone Number=1. Tone Offset=0. MSC/TBS=0.

Frequency range 9 KHz - 18 GHz:

- Low Channel: No spurious frequencies at less than 20 dB below the limit.
- Middle Channel: No spurious frequencies at less than 20 dB below the limit.
- High Channel: No spurious frequencies at less than 20 dB below the limit.

LTE Cat NB1 Band 71:

A preliminary scan determined the worst-case:

Pi/2-BPSK. BW=15 kHz. Tone Number=1. Tone Offset=11. MSC/TBS=0.

Frequency range 9 KHz - 10 GHz:

- Low Channel: No spurious frequencies at less than 20 dB below the limit.
- Middle Channel: No spurious frequencies at less than 20 dB below the limit.
- High Channel: No spurious frequencies at less than 20 dB below the limit.

LTE Cat NB1 Band 85:

A preliminary scan determined the worst-case:

Pi/2-BPSK. BW=3.75 kHz. Tone Number=1. Tone Offset=47. MSC/TBS=0.

Frequency range 9 KHz - 10 GHz:

- Low Channel: No spurious frequencies at less than 20 dB below the limit.
- Middle Channel: No spurious frequencies at less than 20 dB below the limit.
- High Channel: No spurious frequencies at less than 20 dB below the limit.

Measurement uncertainty (dB): $<\pm 2.76$

Verdict: PASS

LTE Cat-NB1 Band 8: Pi/2-BPSK. BW=15 kHz. Tone Number=3. Tone Offset=0. MSC/TBS=0.

Low Channel:

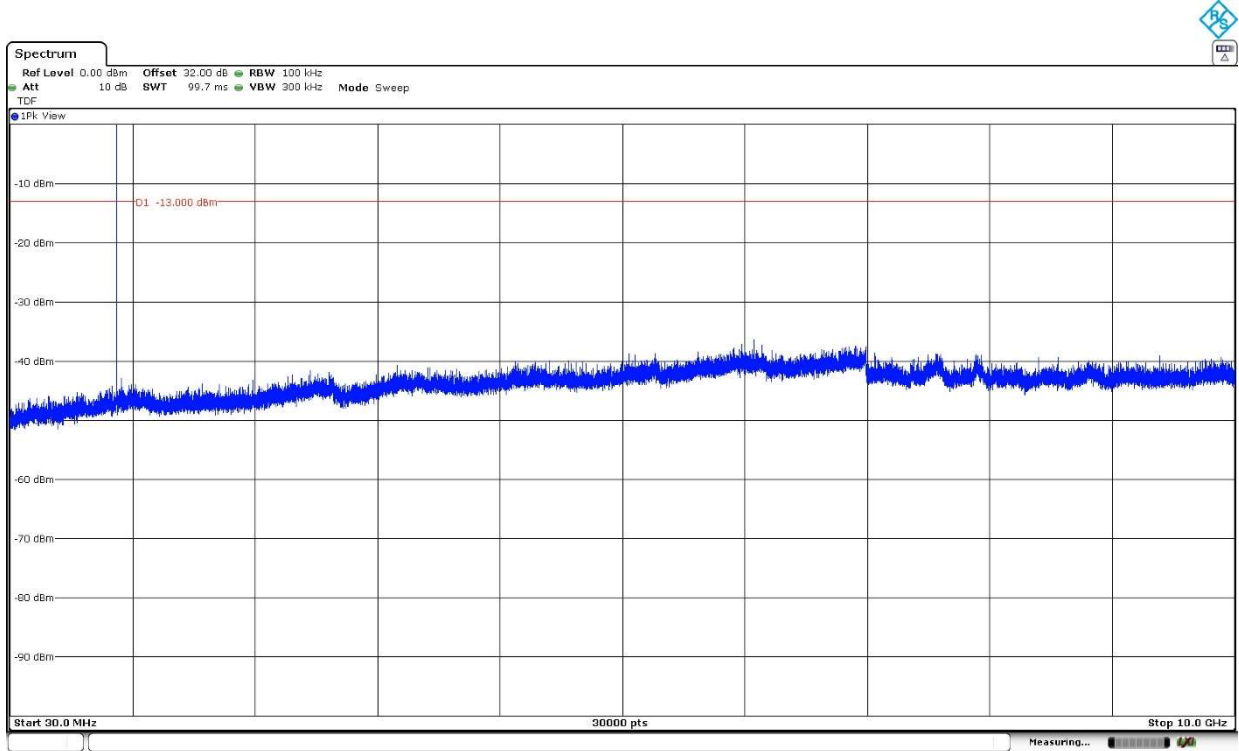

The peak above the limit is the carrier frequency.

High Channel:

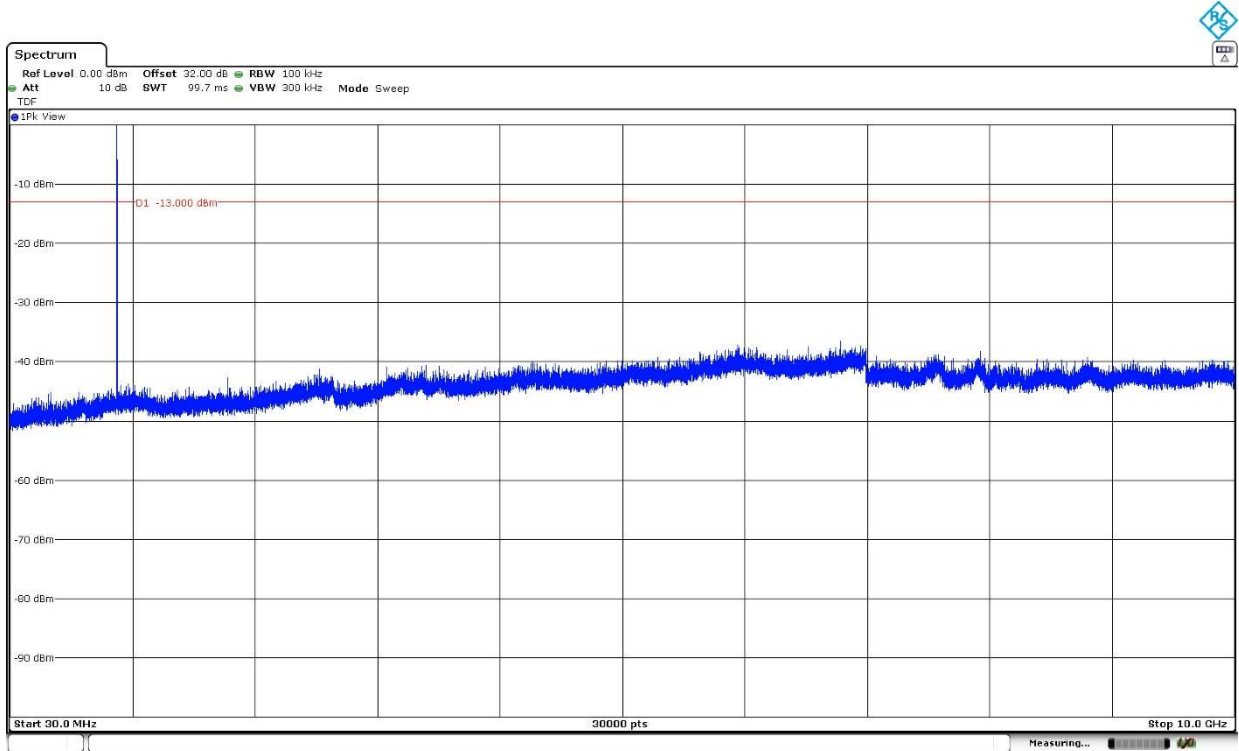

The peak above the limit is the carrier frequency.

LTE Cat-NB1 Band 13: Pi/2-BPSK. BW=15 kHz. Tone Number=1. Tone Offset=0. MSC/TBS=0.

Low Channel:

- Frequency Range 9 kHz – 10 GHz

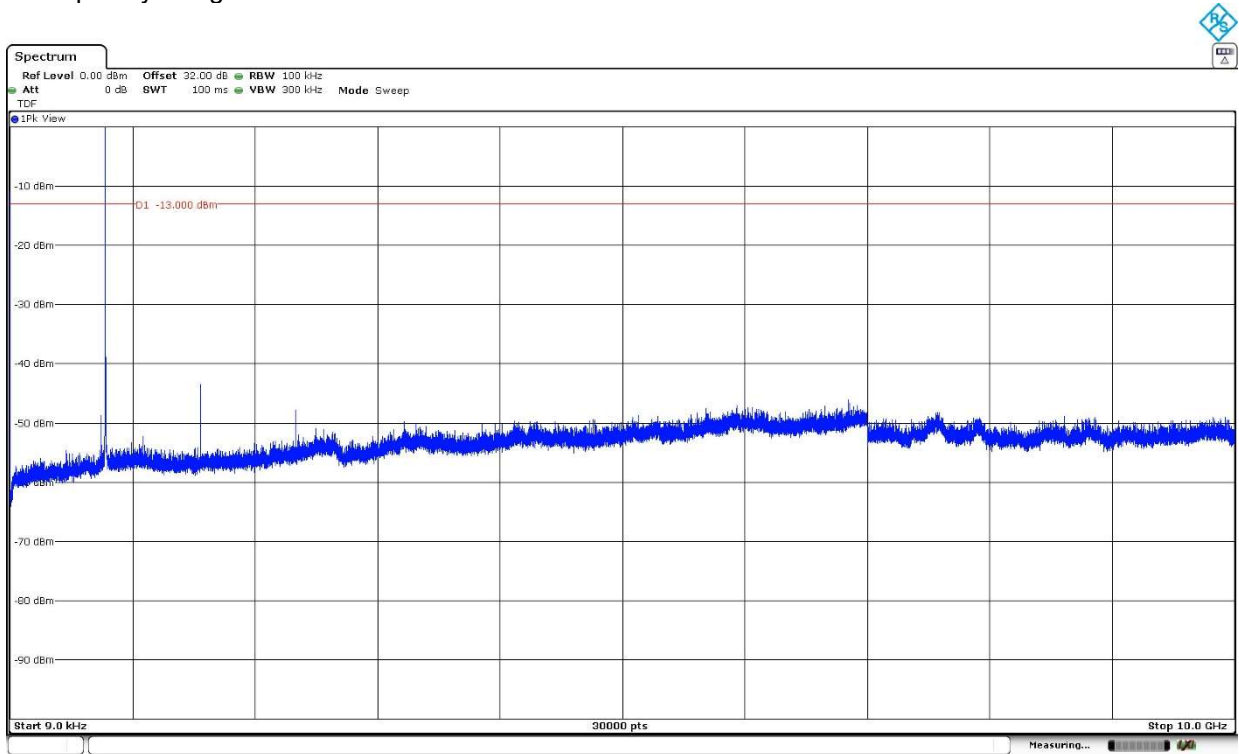

The peak above the limit is the carrier frequency.

- Frequency Range 763 MHz – 775 MHz

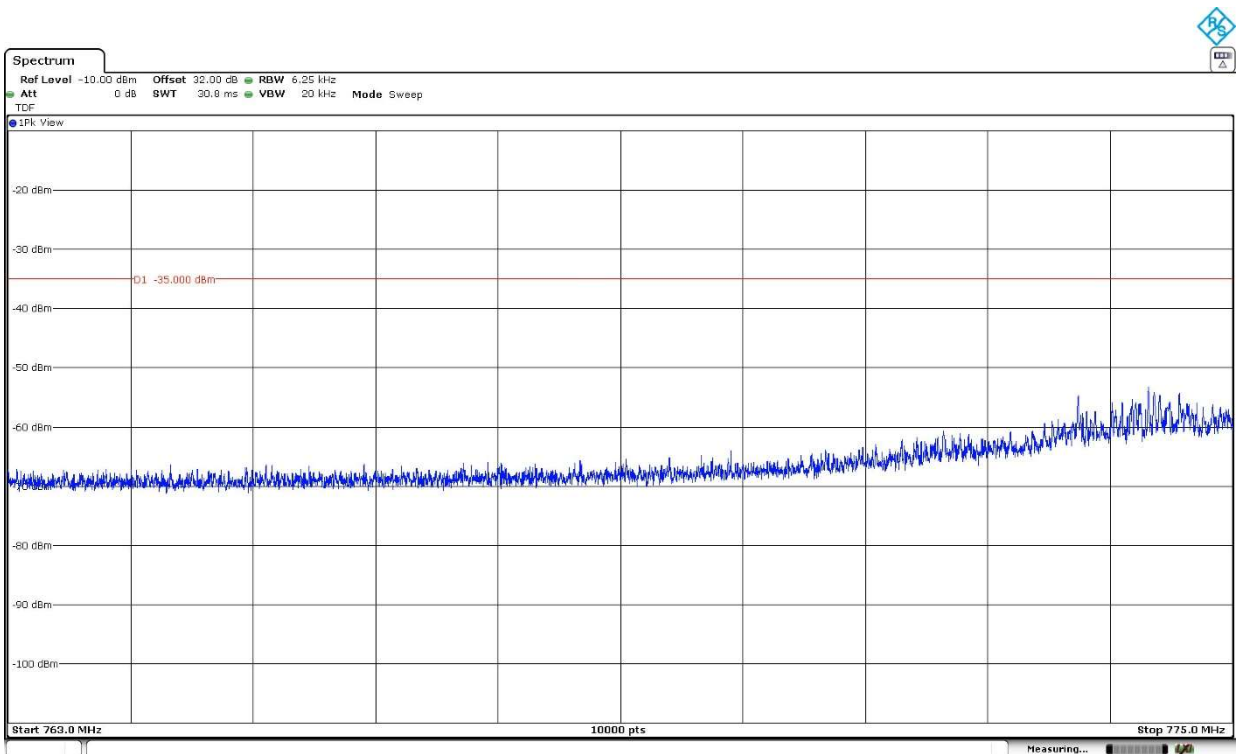

- Frequency Range 793 MHz – 806 MHz

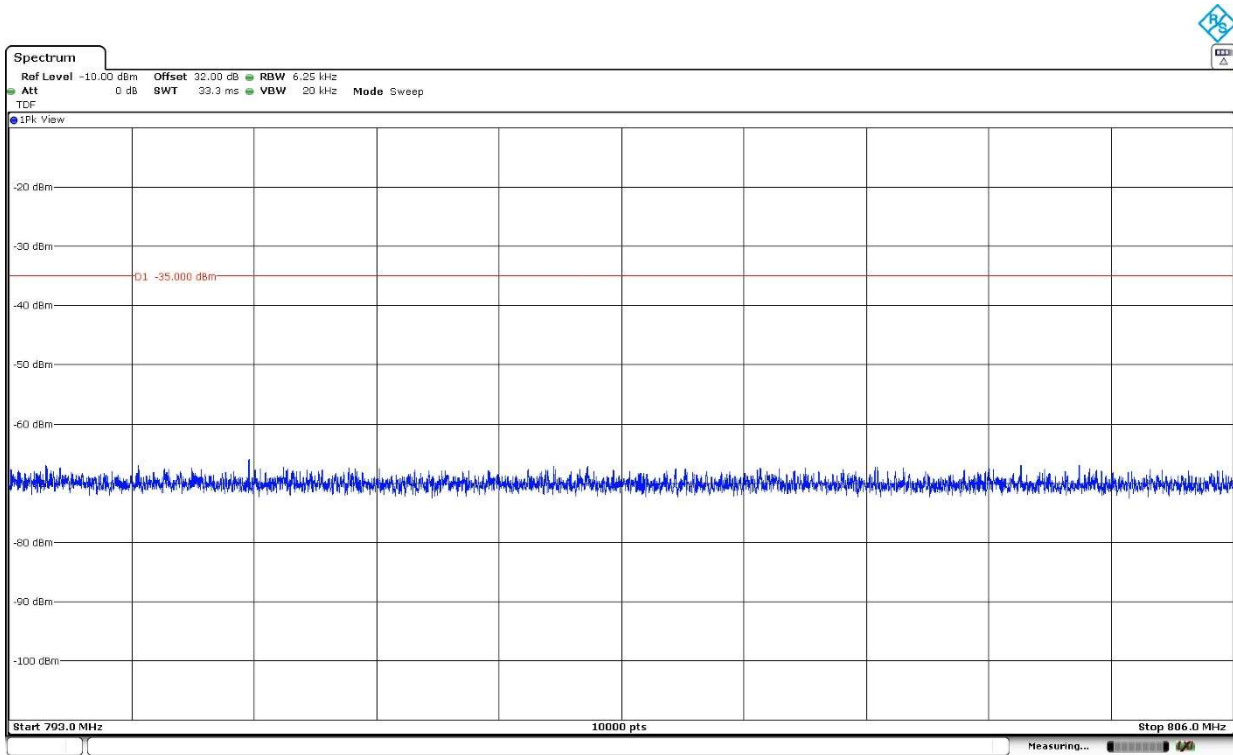

Middle Channel:

- Frequency Range 9 kHz – 10 GHz

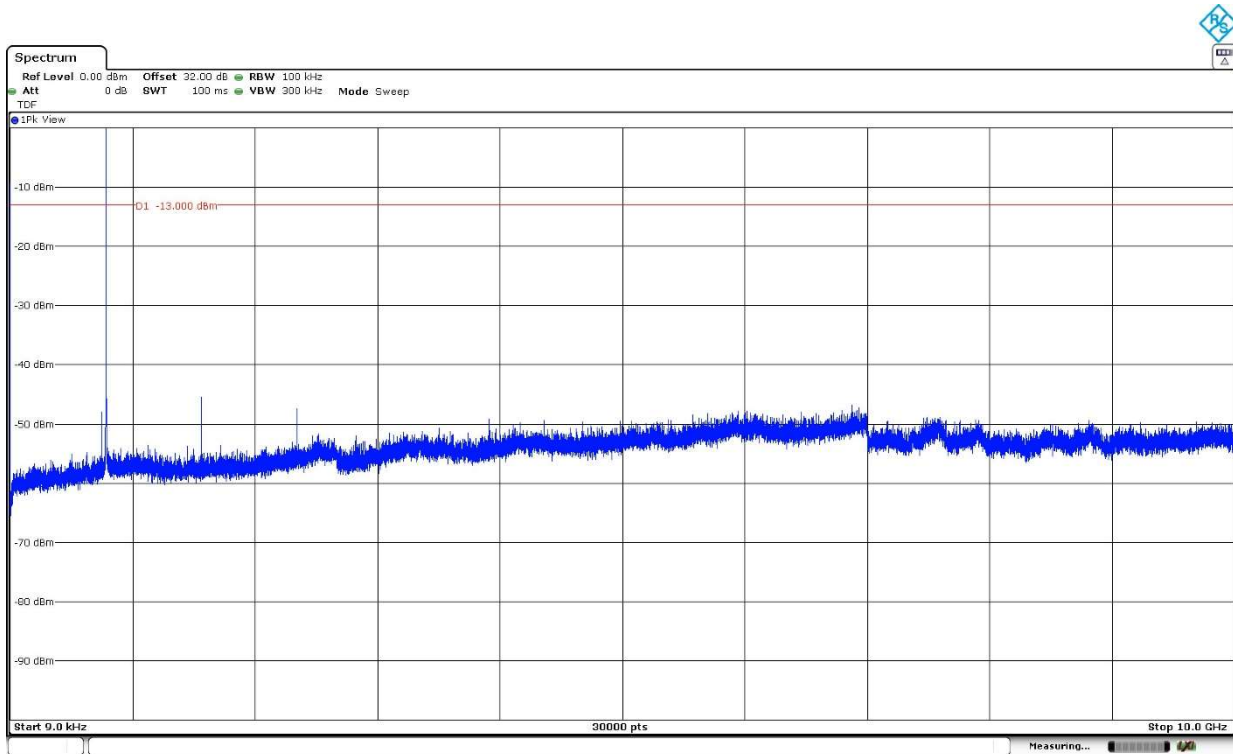

The peak above the limit is the carrier frequency.

- Frequency Range 763 MHz – 775 MHz

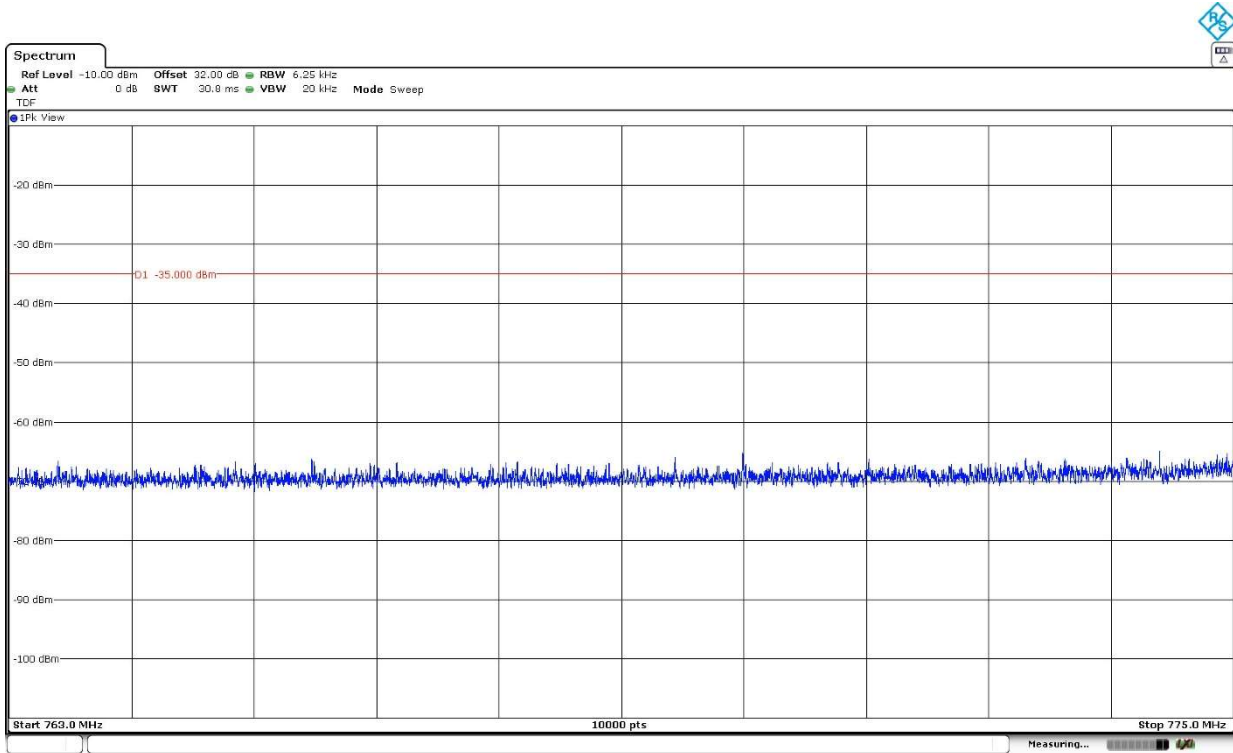

- Frequency Range 793 MHz – 806 MHz

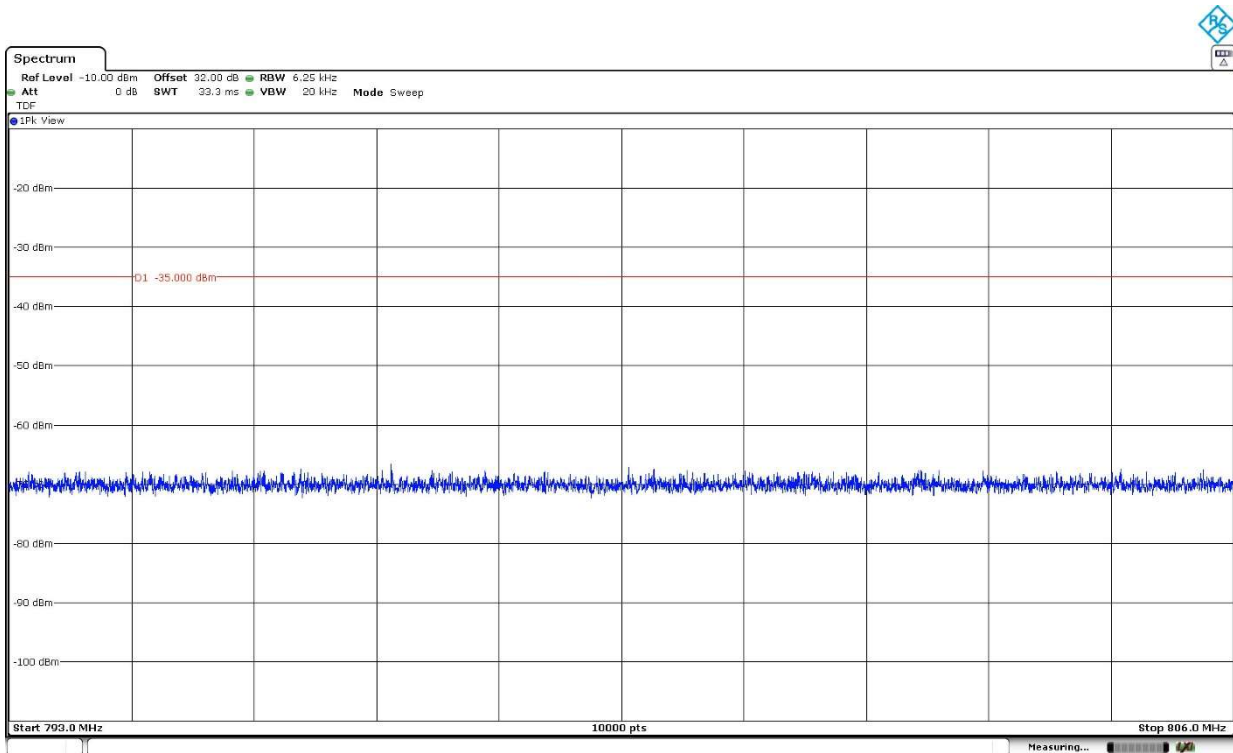

High Channel:

- Frequency Range 9 kHz – 10 GHz

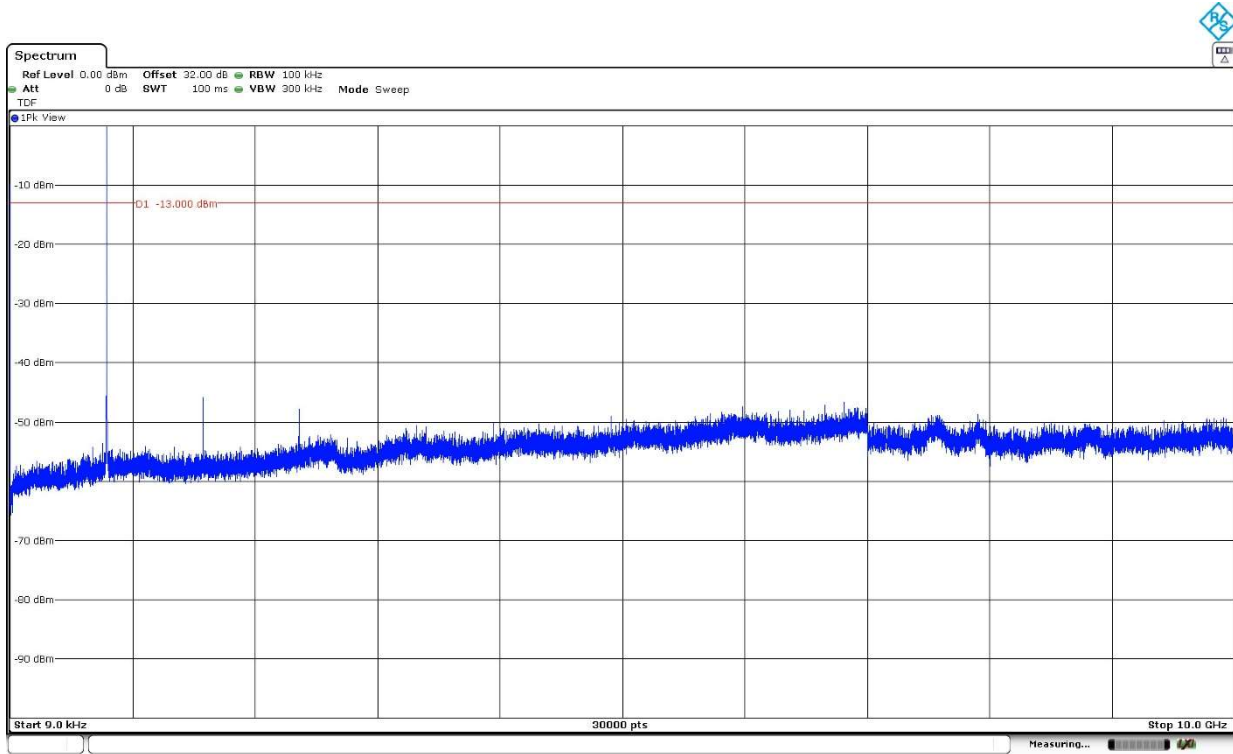

The peak above the limit is the carrier frequency.

- Frequency Range 763 MHz – 775 MHz

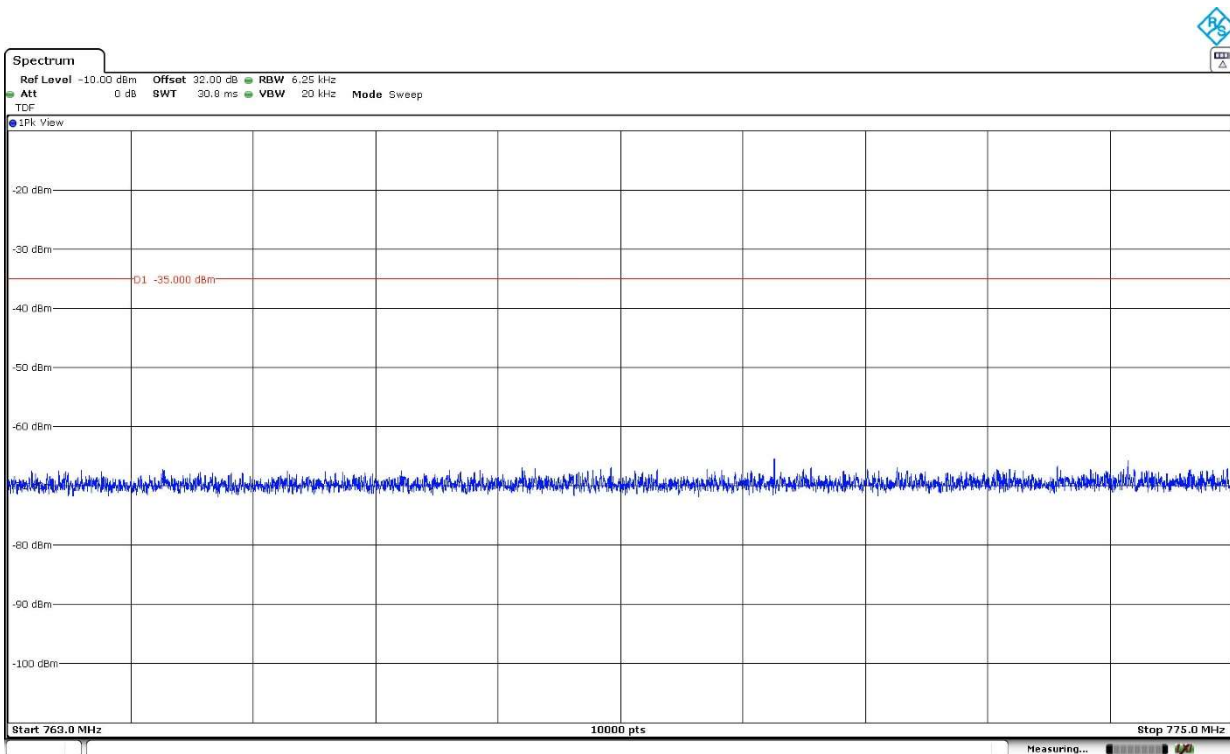

- Frequency Range 793 MHz – 806 MHz

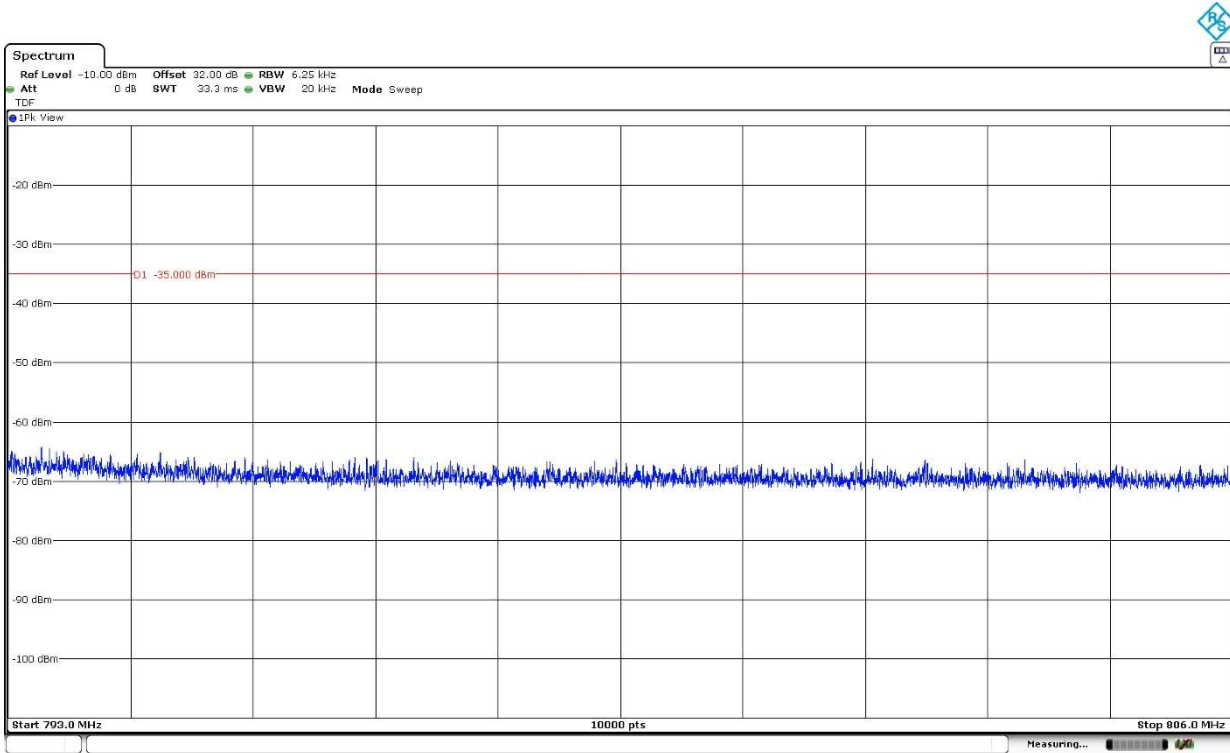

LTE Cat-NB1 Band 66: Pi/2-BPSK. BW=3.75 kHz. Tone Number=1. Tone Offset=0. MSC/TBS=0.

Low Channel:

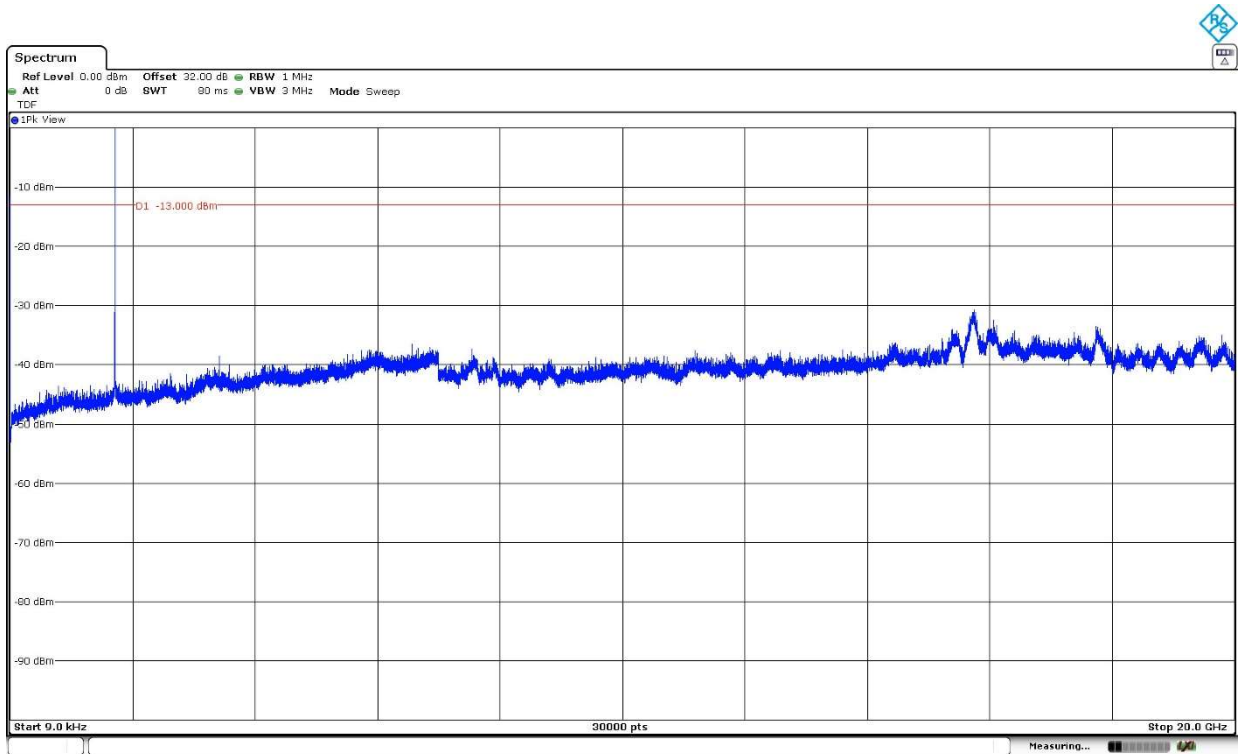

The peak above the limit is the carrier frequency.

Middle Channel:

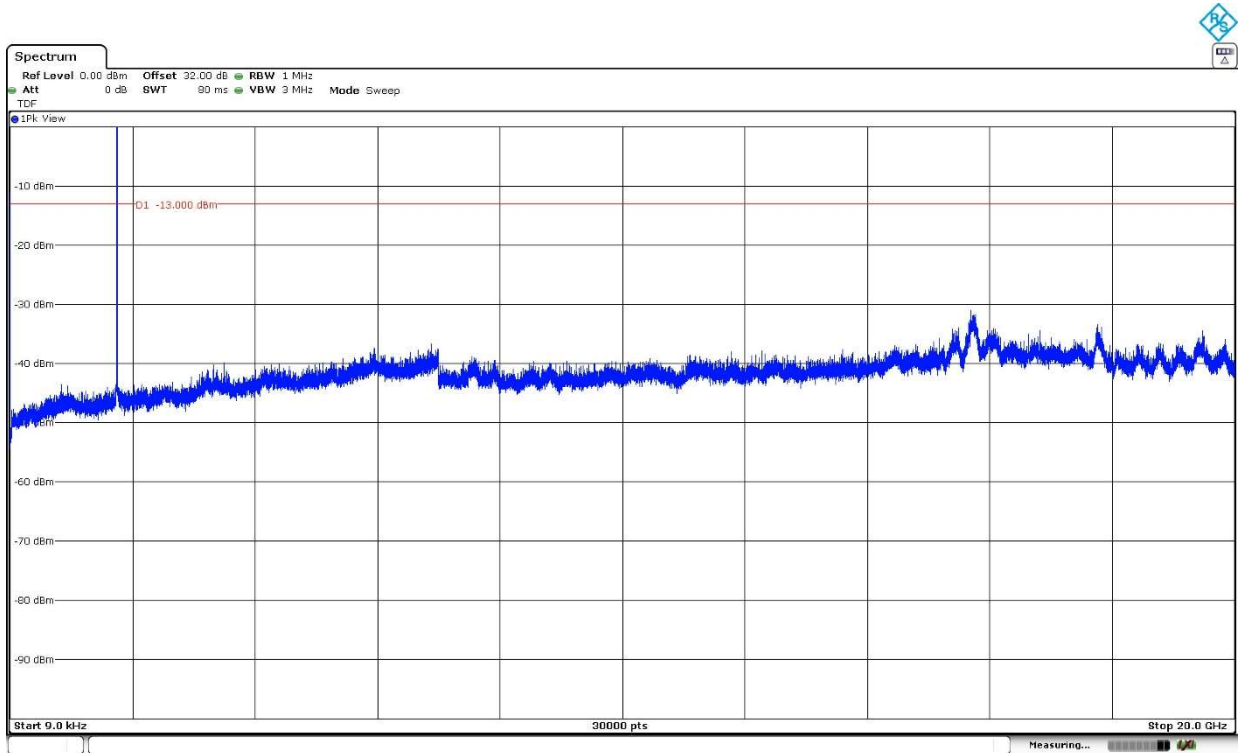

The peak above the limit is the carrier frequency.

High Channel:

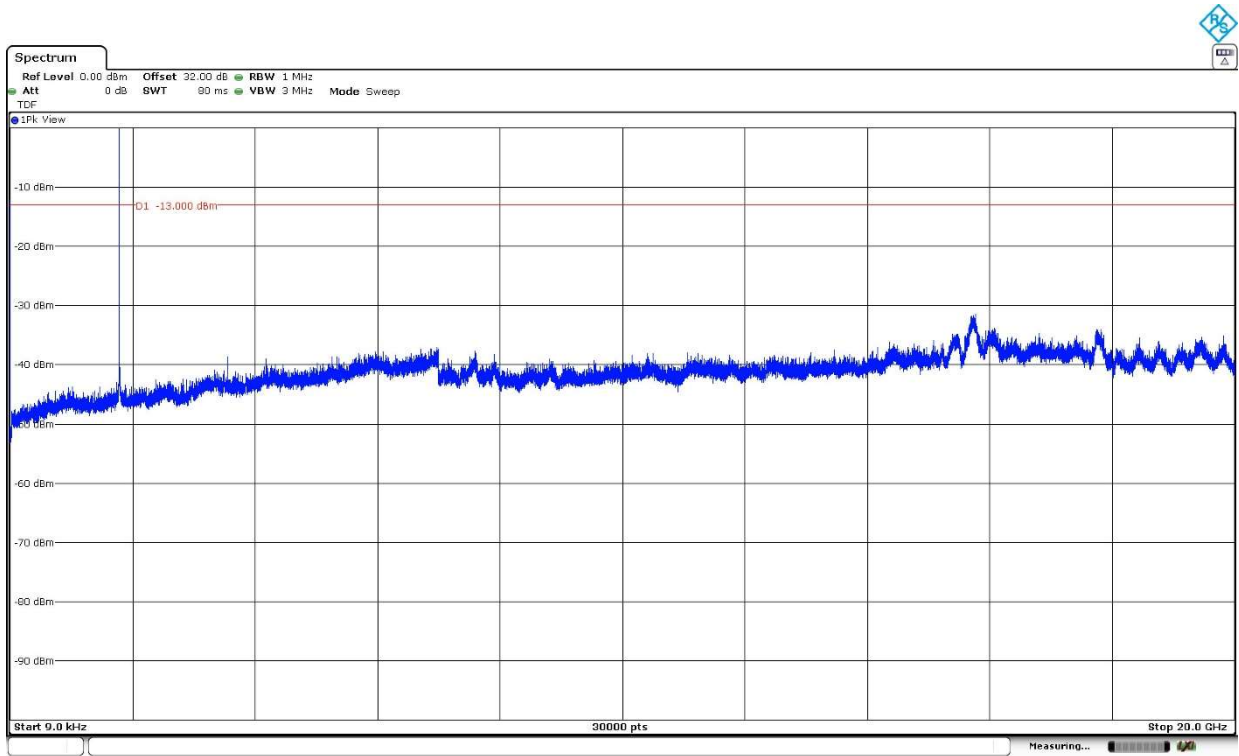

The peak above the limit is the carrier frequency.

LTE Cat-NB1 Band 71: Pi/2-BPSK. BW=15 kHz. Tone Number=1. Tone Offset=11. MSC/TBS=0.

Low Channel:

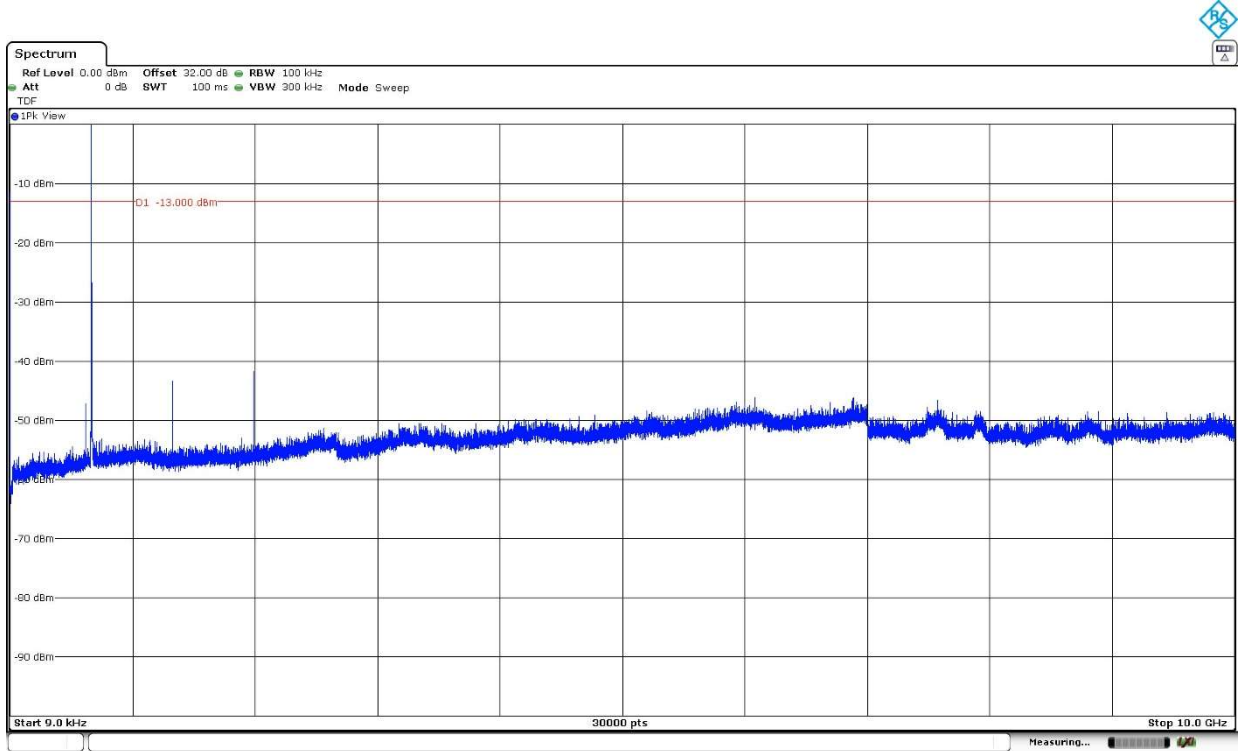

The peak above the limit is the carrier frequency.

Middle Channel:

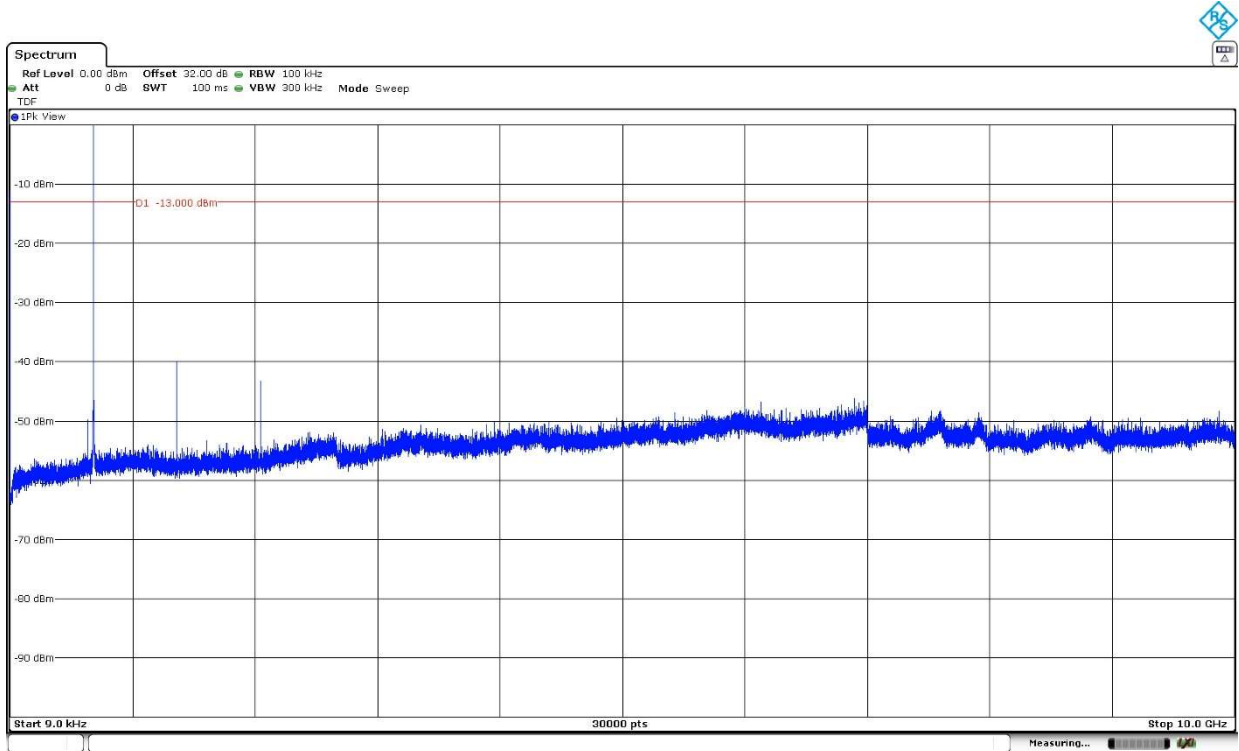

The peak above the limit is the carrier frequency.