

High Channel:

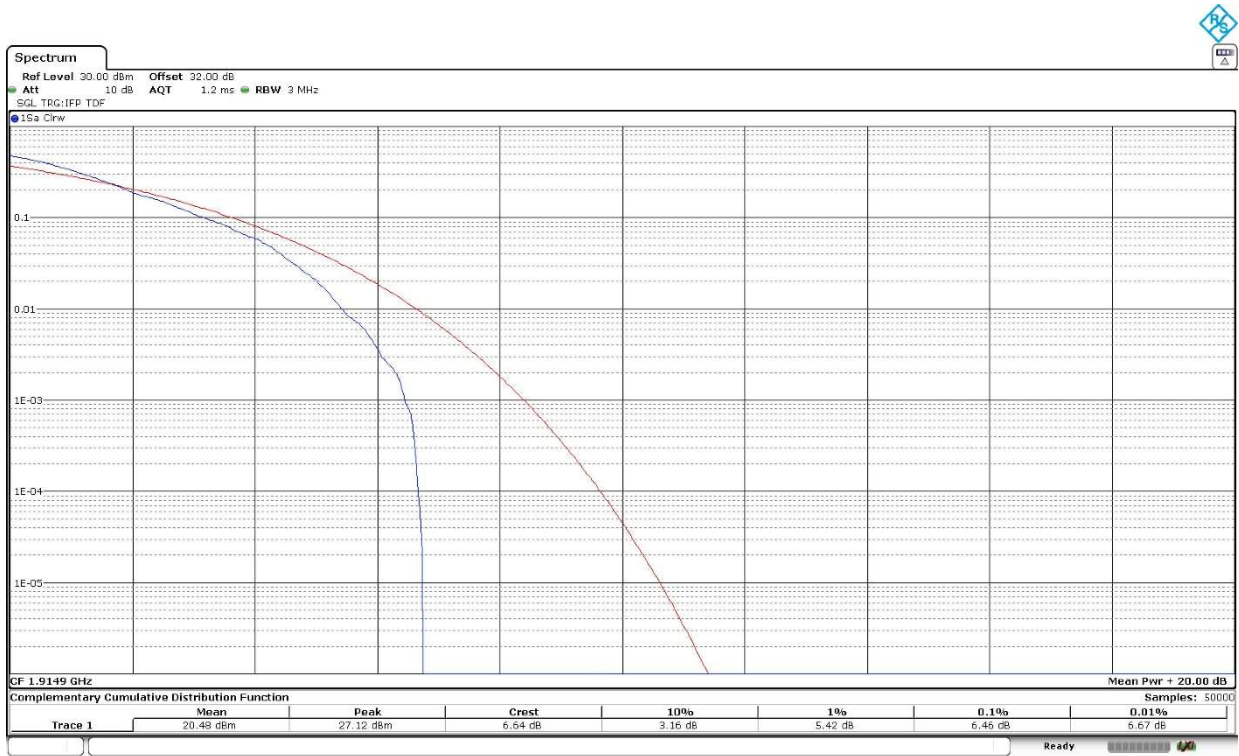

16QAM	Low	Middle	High
PAPR (dB)	6.43	7.77	6.46

Verdict

Pass

Frequency Stability

Limits

FCC §2.1055 and §24.235. The frequency stability shall be sufficient to ensure that the fundamental emission stays within the authorized frequency block.

RSS-133. Clause 6.3. The carrier frequency shall not depart from the reference frequency in excess of ± 2.5 ppm for mobile stations.

Method

The frequency tolerance measurements over temperature variations were made over the temperature range of -30°C to $+50^{\circ}\text{C}$. The EUT was placed inside a climatic chamber and the temperature was raised hourly in 10°C steps from -30°C up to $+50^{\circ}\text{C}$.

The supply voltage was varied between 85% and 115% of nominal voltage.

Temperature and voltage range of testing has been extended to the maximum and minimum values declared by customer.

The EUT was set in "Radio Resource Control (RRC) mode" in the middle channel using the Universal Radio Communication tester R&S CMW500 and the maximum frequency error was measured using the built-in calibrated frequency meter.

The worst case NB-IoT mode for conducted power was used for the test.

In order to check that the frequency stability is sufficient such that the fundamental emissions stay within the authorized bands of operation, a reference point is established at the applicable unwanted emissions limit using a RBW equal to the RBW required by the unwanted emissions specification of the applicable regulatory standard. These reference points measured using the Low and High channel of operation are identified as fL and fH respectively. The worst-case frequency offset determined in the above methods is added or subtracted from the values of fL and fH to check that the resulting frequencies remain within the band.

The reference point measurements were made at the RF output terminals of the EUT using an attenuator, power splitter and spectrum analyser. The EUT was controlled via the Universal Radio Communication tester R&S CMW500 selecting maximum transmission power of the EUT and different modes of modulation.

Test Setup

Frequency tolerance.

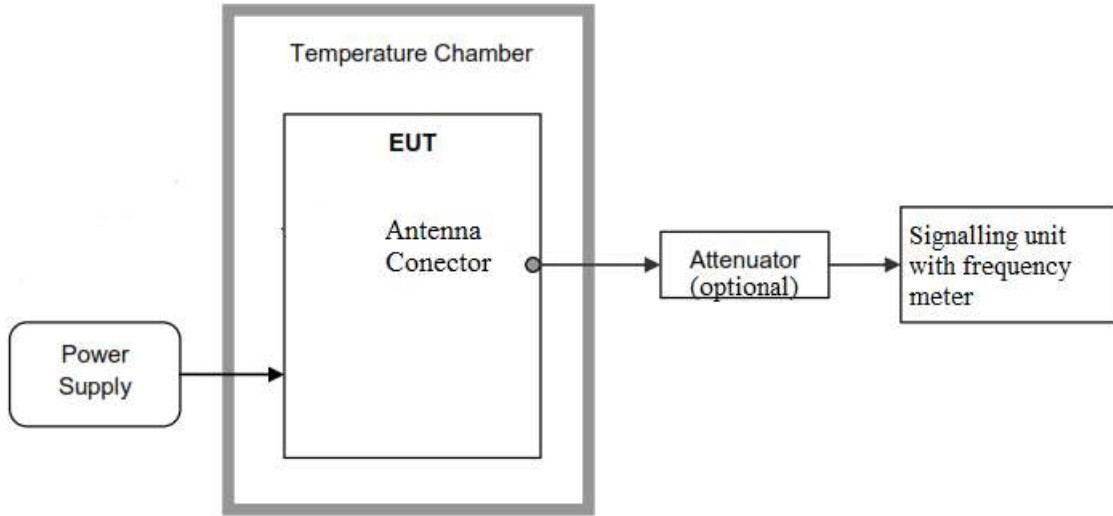

Reference points f_L and f_H .

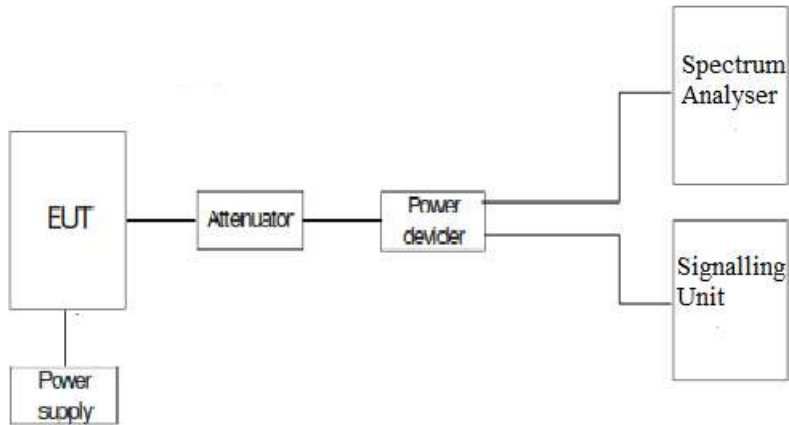

Results

LTE Cat NB1 Band 25:

The worst case modulation in terms of Frequency Stability is QPSK, BW=15 kHz, Tone Number=3, Tone Offset=6, MSC/TBS=5.

1. Frequency Tolerance:

- **Frequency Stability over Temperature Variations:**

Temperature (°C)	Frequency Error (Hz)	Frequency Error (ppm)
+85	23,16	0,012302789
+80	-8,76	-0,004653386
+70	-8,64	-0,004589641
+60	-5,42	-0,00287915
+50	-8,67	-0,004605578
+40	-9,07	-0,004818061
+30	-25,35	-0,013466135
+20	-20,23	-0,010746348
+10	2,80	0,001487384
0	-5,89	-0,003128818
-10	3,53	0,001875166
-20	9,18	0,004876494
-30	1,69	0,000897742
-40	-24,62	-0,013078353

- **Frequency Stability over Voltage Variations.**

Supply voltage	Voltage (V)	Frequency Error (Hz)	Frequency Error (ppm)
Vmax	5.5	-13.48	-0.007160691
Vmin	3	-7,48	-0,00397344

2. Reference Frequency Points fL and fH:

The worst-case frequency offsets added or subtracted per band and bandwidth:

fL (MHz)	1850.0358
fH (MHz)	1914.9762

The reference frequency points fL and fH stay within the authorized blocks for the band above.

Measurement uncertainty (Hz) $\leq \pm 249.55$

Verdict: PASS

Modulation Characteristics

Limits

FCC §2.1047.

RSS-133. Clause 6.2. Equipment certified under this standard shall use digital modulation.

Method

For LTE NB1 the EUT operates with $\pi/2$ -BPSK, $\pi/4$ -QPSK and QPSK modulations in which the information is digitized and coded into a bit stream. The RF transmission is multiplexed using *Orthogonal Frequency Division Multiplexing (OFDM)* using different possible arrangement of subcarriers (Resource Blocks RB).

Test Setup

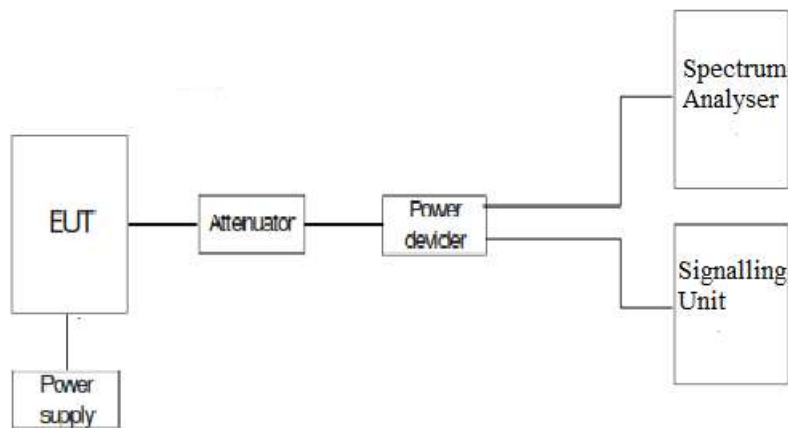

Results

The following plot shows the modulation schemes in the EUT.

LTE Cat NB1 Band 25: Pi/2-BPSK. Middle Channel. BW=3.75 kHz. Tone Number=1. Tone Offset=0. MSC/TBS=0.

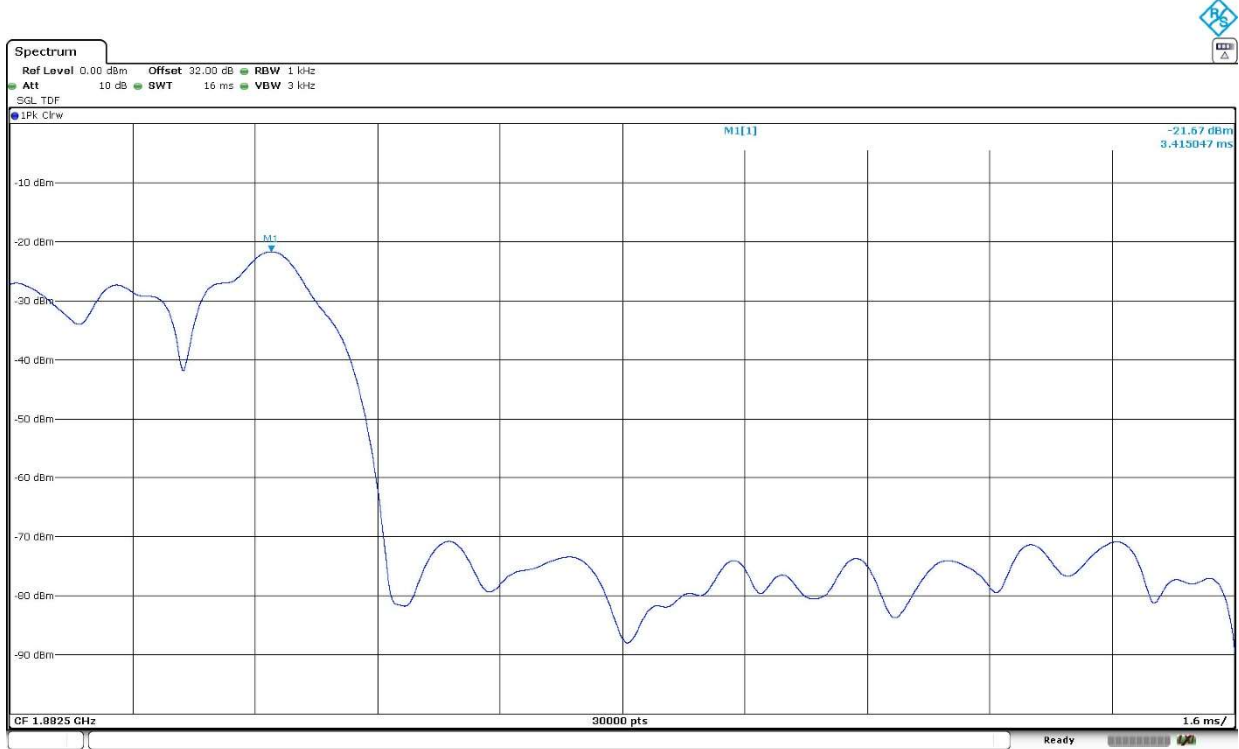

LTE Cat NB1 Band 25: Pi/4-QPSK. Middle Channel. BW=3.75 kHz. Tone Number=1. Tone Offset=0. MSC/TBS=3.

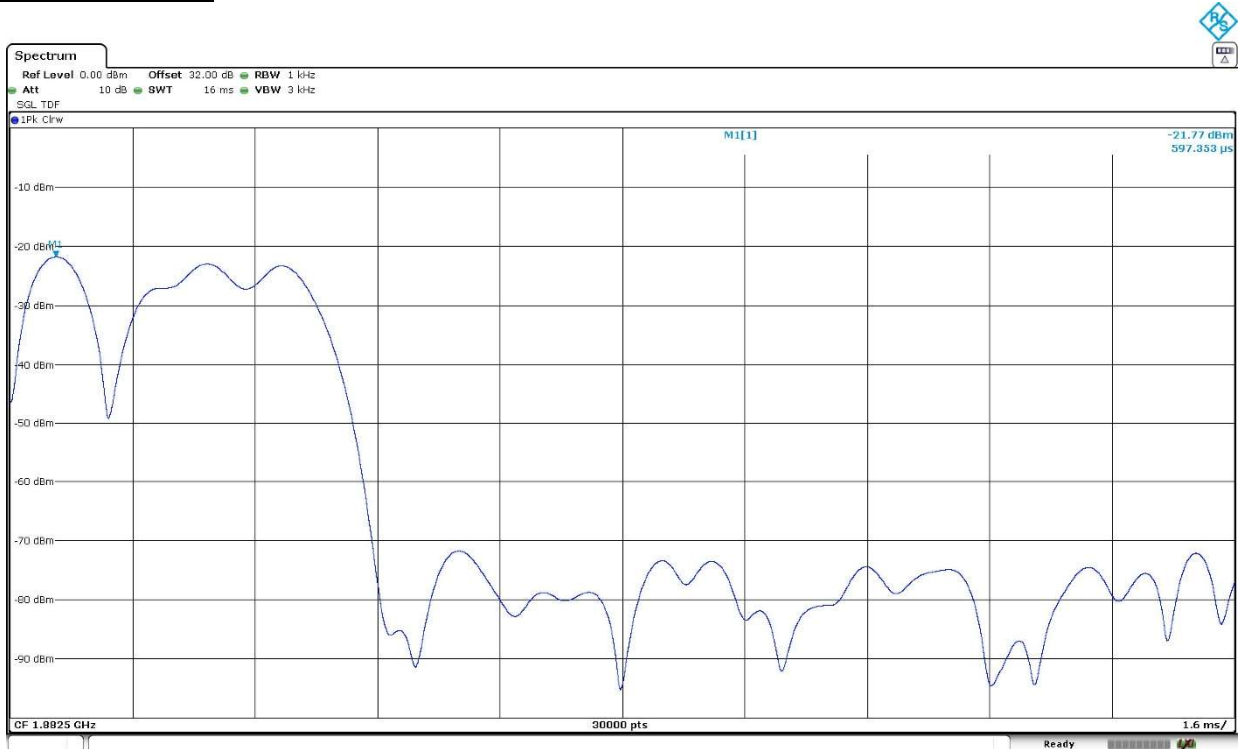

Occupied Bandwidth

Limits

FCC §2.1049. Measurements required: Occupied bandwidth.

RSS-Gen, Clause 6.7.

Method

The occupied bandwidth measurement was performed at the output terminals of the EUT using an attenuator, power splitter and spectrum analyser. The EUT was controlled via the Universal Radio Communication tester R&S CMW500 selecting maximum transmission power of the EUT and different modes of modulation. The 99% occupied bandwidth and the -26 dBc bandwidth were measured directly using the built-in bandwidth measuring option of spectrum analyser.

Test Setup

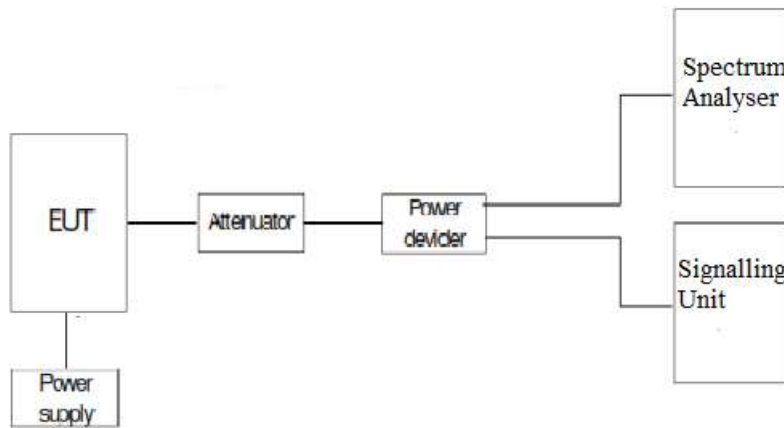

Results

The worst case per modulation is:

LTE Cat NB1 Band 25:

LTE Cat NB1 Band 25. Pi/2-BPSK. BW=3.75 kHz. Tone Number=1. Tone Offset=23. MSC/TBS=0.

	Low Channel	Middle Channel	High Channel
99% Occupied Bandwidth (kHz)	43.83000	45.02000	44.22000
-26 dBc Bandwidth (kHz)	35.01100	36.73100	34.95500
Measurement uncertainty (kHz)	<±0.25		

LTE Cat NB1 Band 25. Pi/4-QPSK. BW=3.75 kHz. Tone Number=1. Tone Offset=23. MSC/TBS=3.

	Low Channel	Middle Channel	High Channel
99% Occupied Bandwidth (kHz)	67.38000	66.48000	65.22000
-26 dBc Bandwidth (kHz)	41.75200	41.88800	41.87400
Measurement uncertainty (kHz)	<±0.25		

LTE Cat NB1 Band 25. Pi/2-BPSK. BW=3.75 kHz. Tone Number=1. Tone Offset=23. MSC/TBS=0.

Low Channel:

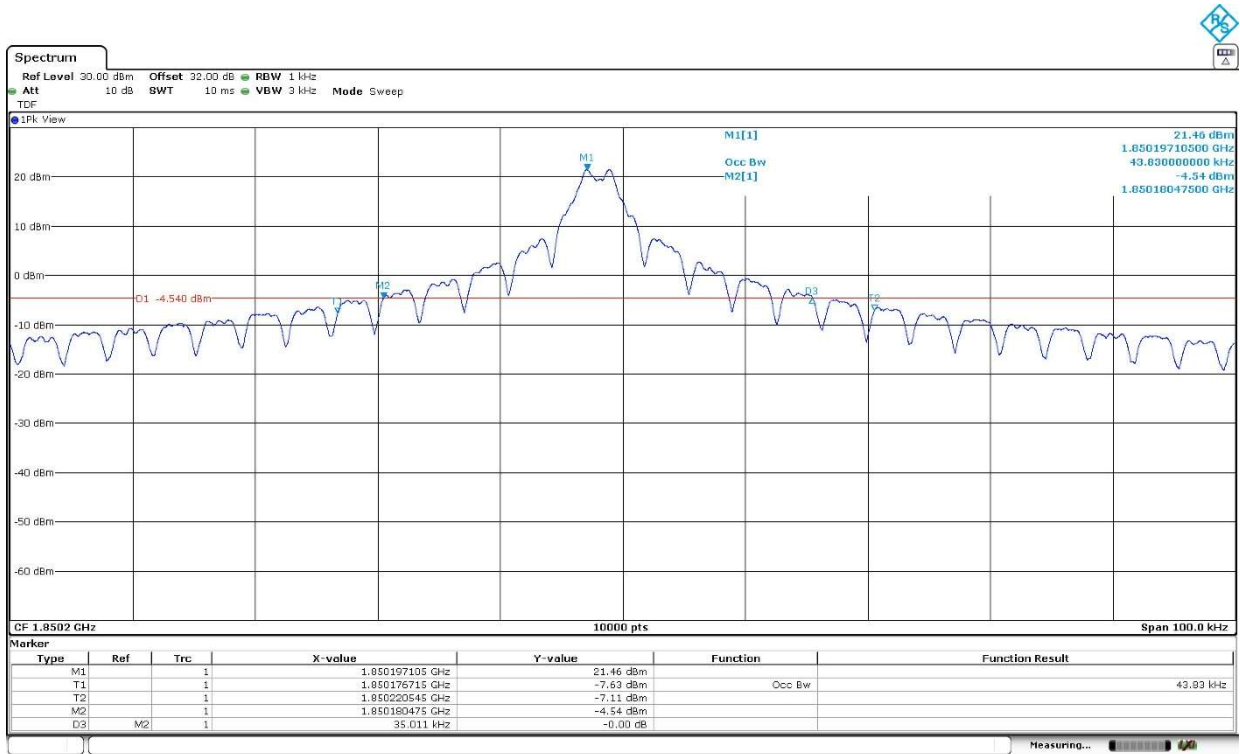

Middle Channel:

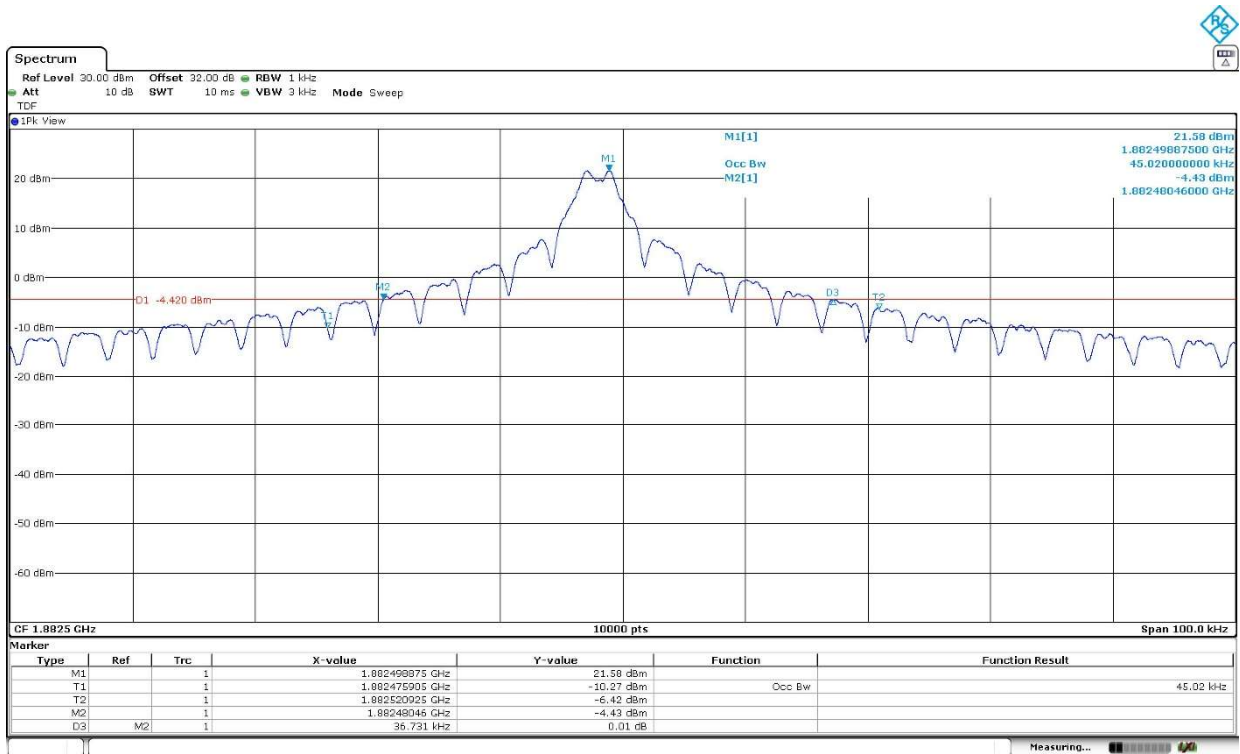

High Channel:

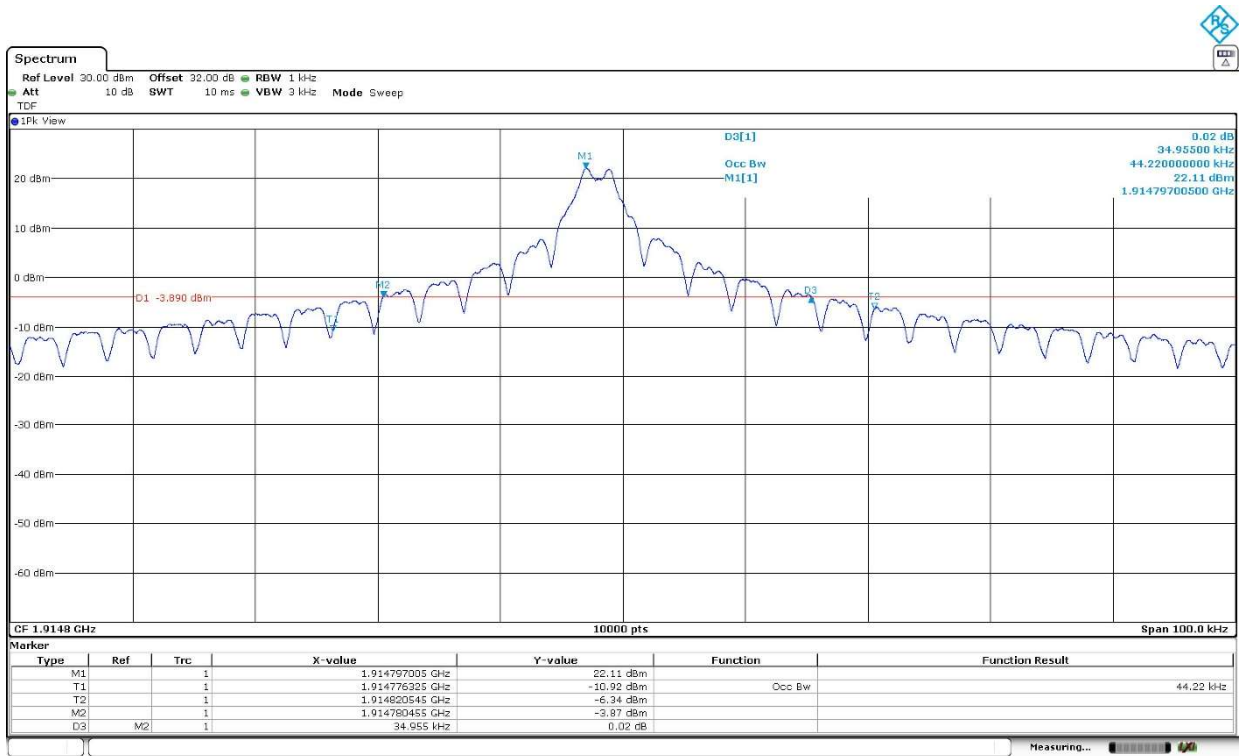

LTE Cat NB1 Band 25. Pi/4-QPSK. BW=3.75 kHz. Tone Number=1. Tone Offset=23. MSC/TBS=3.

Low Channel:

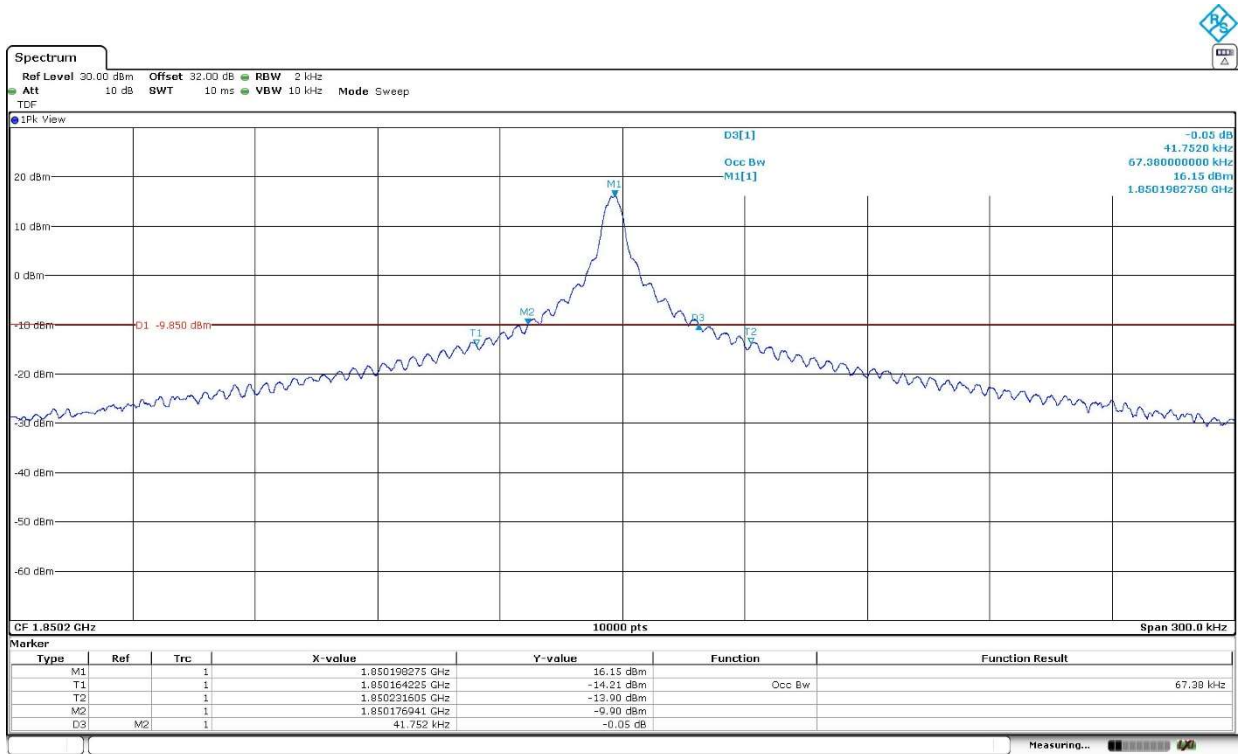

Middle Channel:

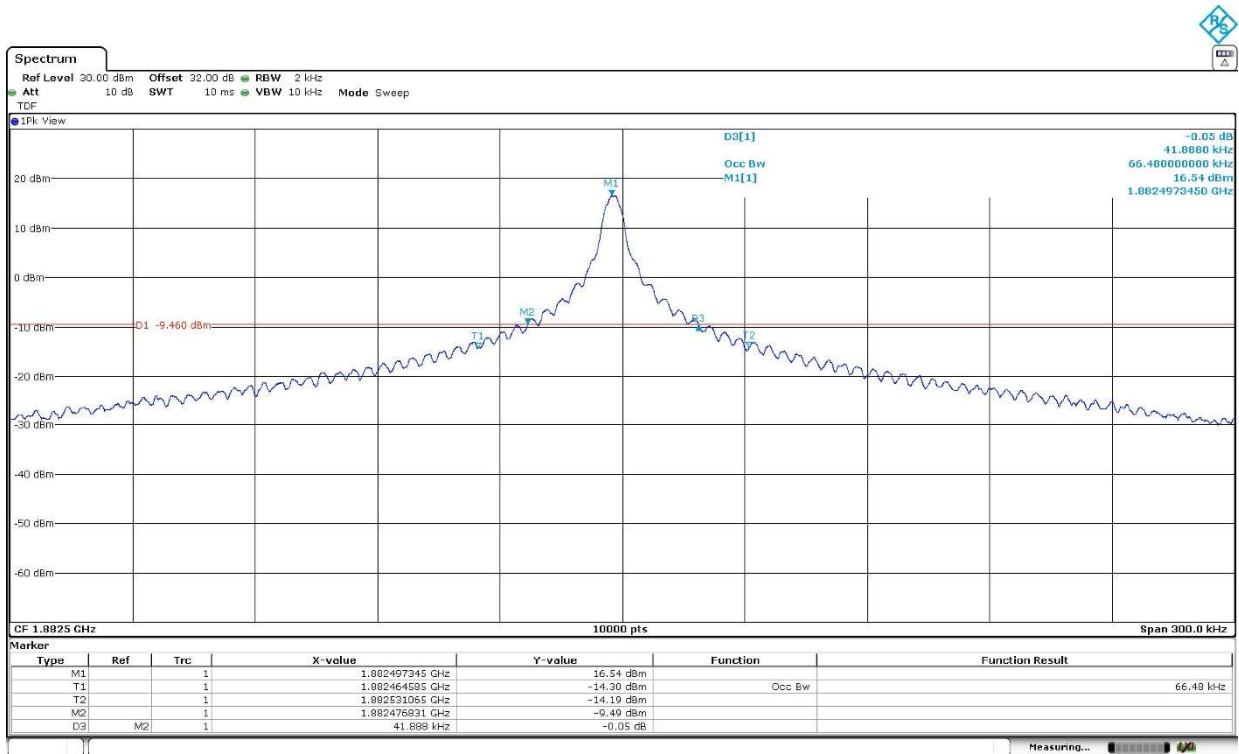

High Channel:

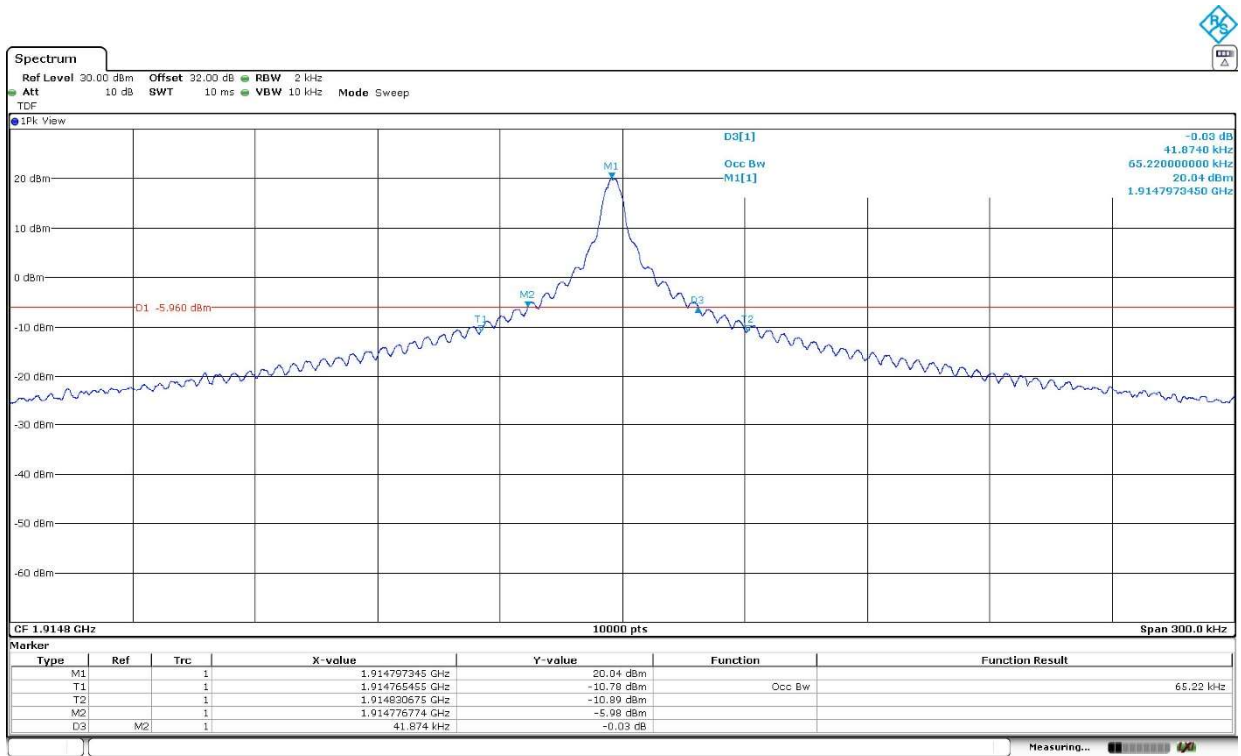

LTE Cat NB1 Band 25. Pi/2-BPSK. BW=15 kHz. Tone Number=1. Tone Offset=5. MSC/TBS=0.

	Low Channel	Middle Channel	High Channel
99% Occupied Bandwidth (kHz)	126.75000	126.66000	125.43000
-26 dBc Bandwidth (kHz)	130.76200	122.92200	112.59800
Measurement uncertainty (kHz)	<±0.25		

LTE Cat NB1 Band 25. QPSK. BW=15 kHz. Tone Number=12. Tone Offset=0. MSC/TBS=5.

	Low Channel	Middle Channel	High Channel
99% Occupied Bandwidth (kHz)	189.45000	190.00000	189.40000
-26 dBc Bandwidth (kHz)	315.41700	327.27500	314.08400
Measurement uncertainty (kHz)	<±0.25		

LTE Cat NB1 Band 25. Pi/2-BPSK. BW=15 kHz. Tone Number=1. Tone Offset=5. MSC/TBS=0.

Low Channel:

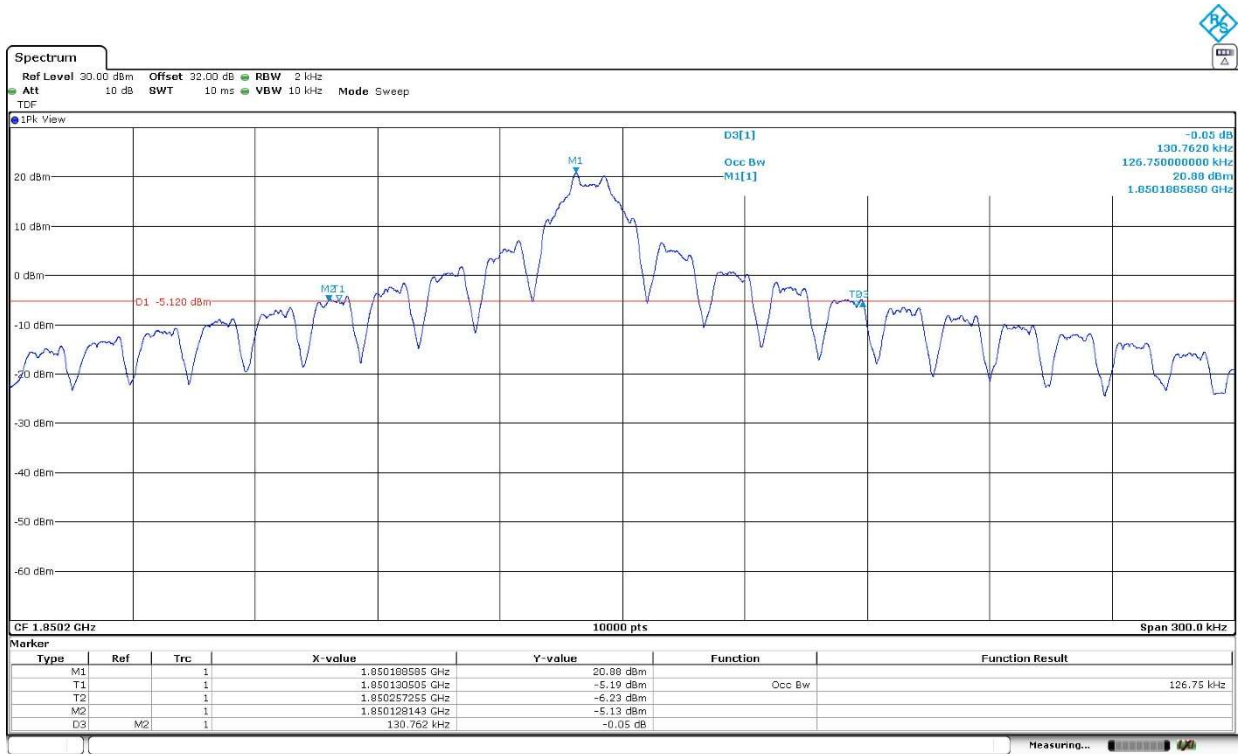

Middle Channel:

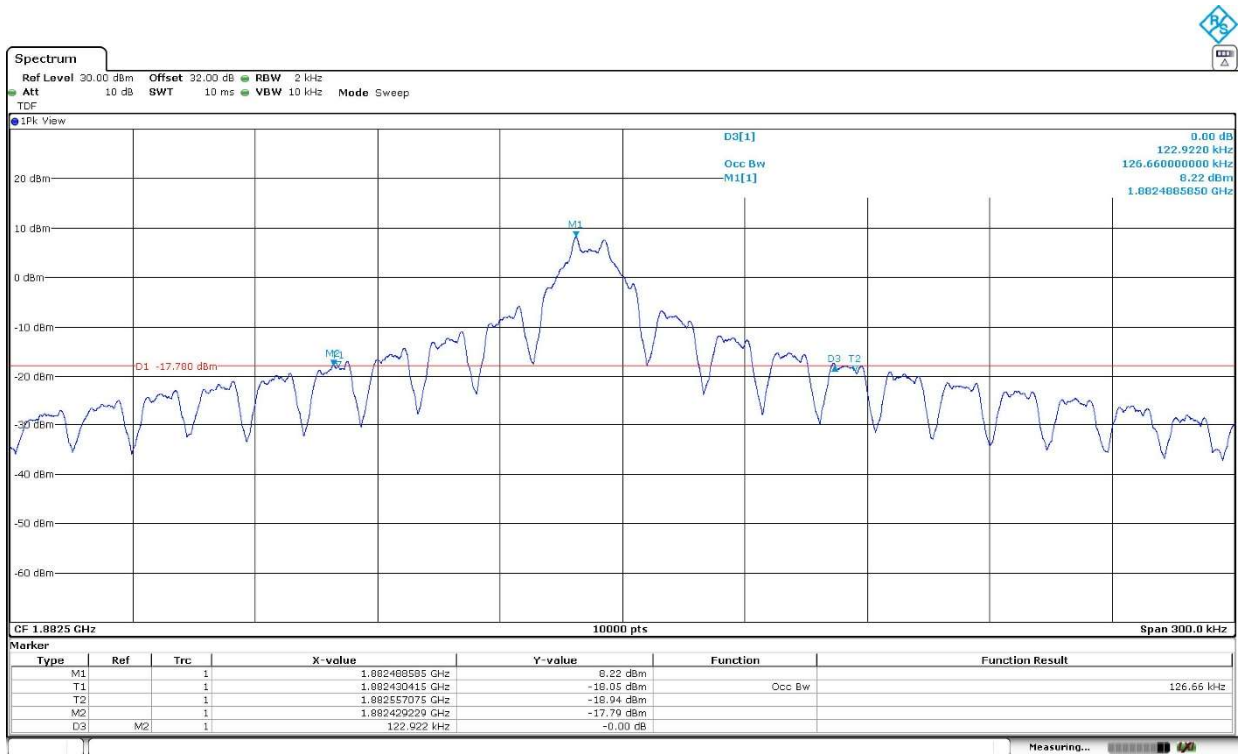

High Channel:

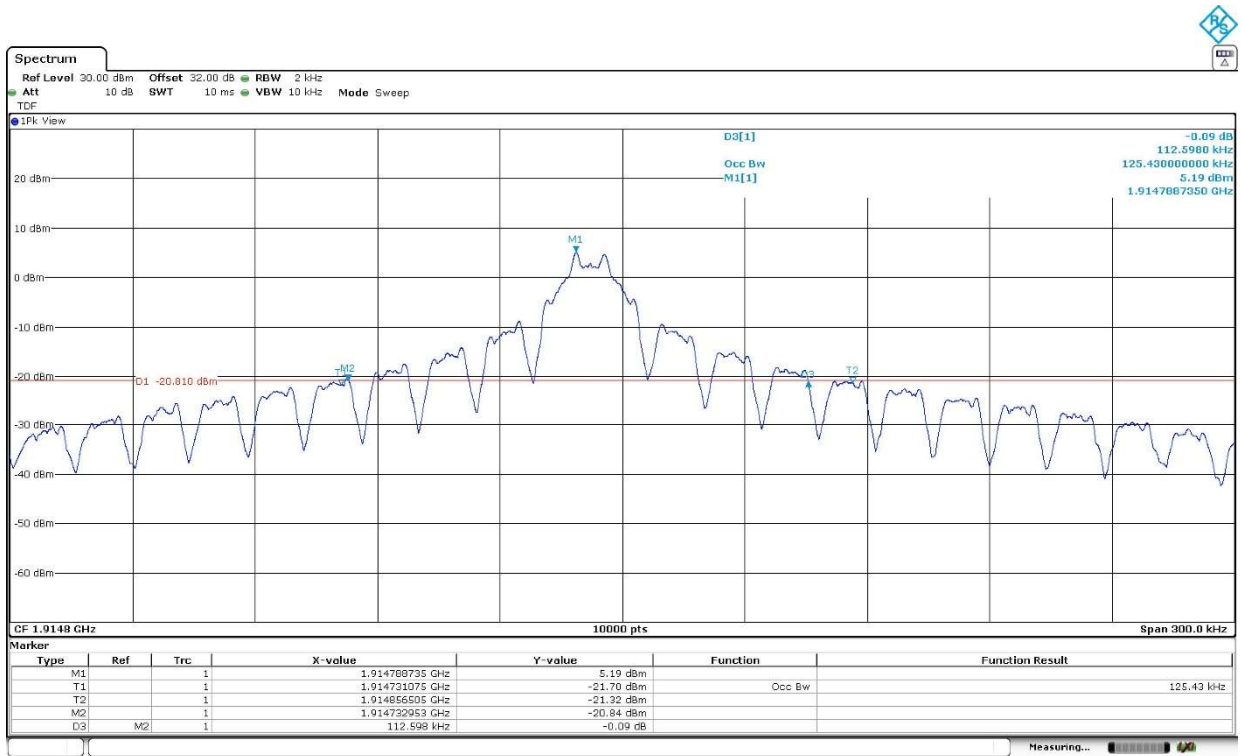

LTE Cat NB1 Band 25. QPSK. BW=15 kHz. Tone Number=12. Tone Offset=0. MSC/TBS=5.

Low Channel:

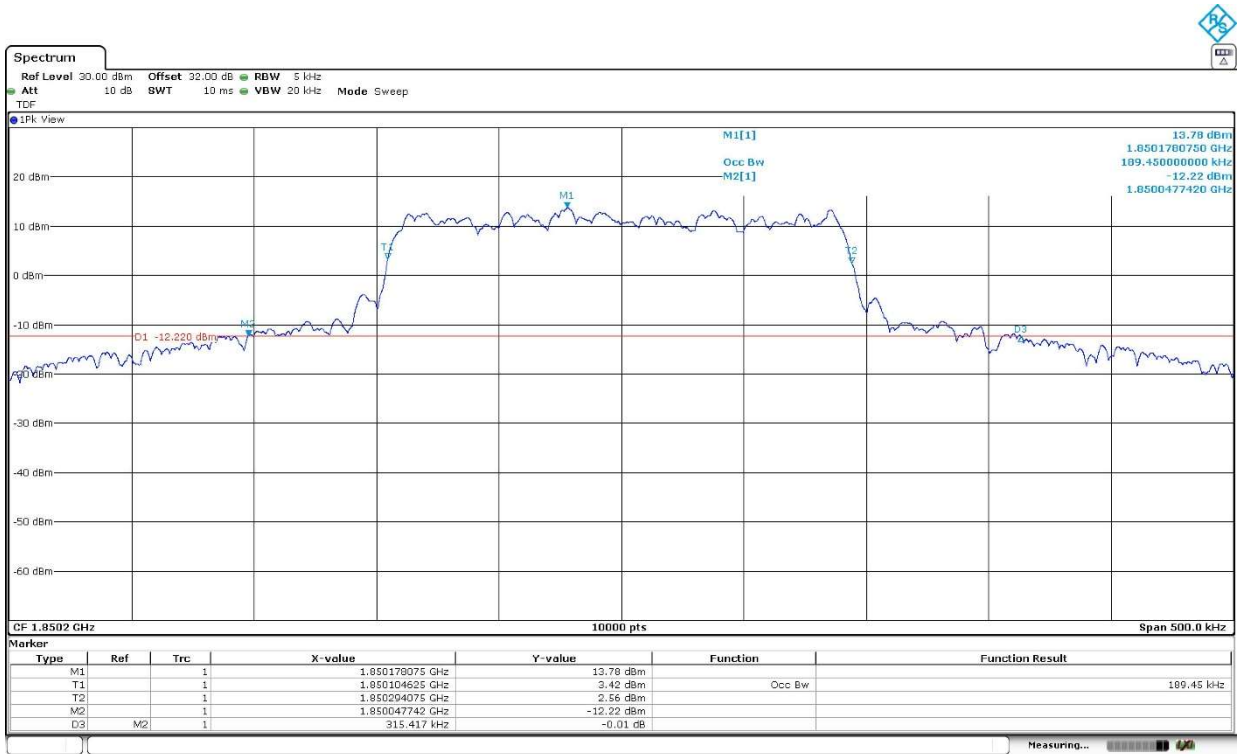

Middle Channel:

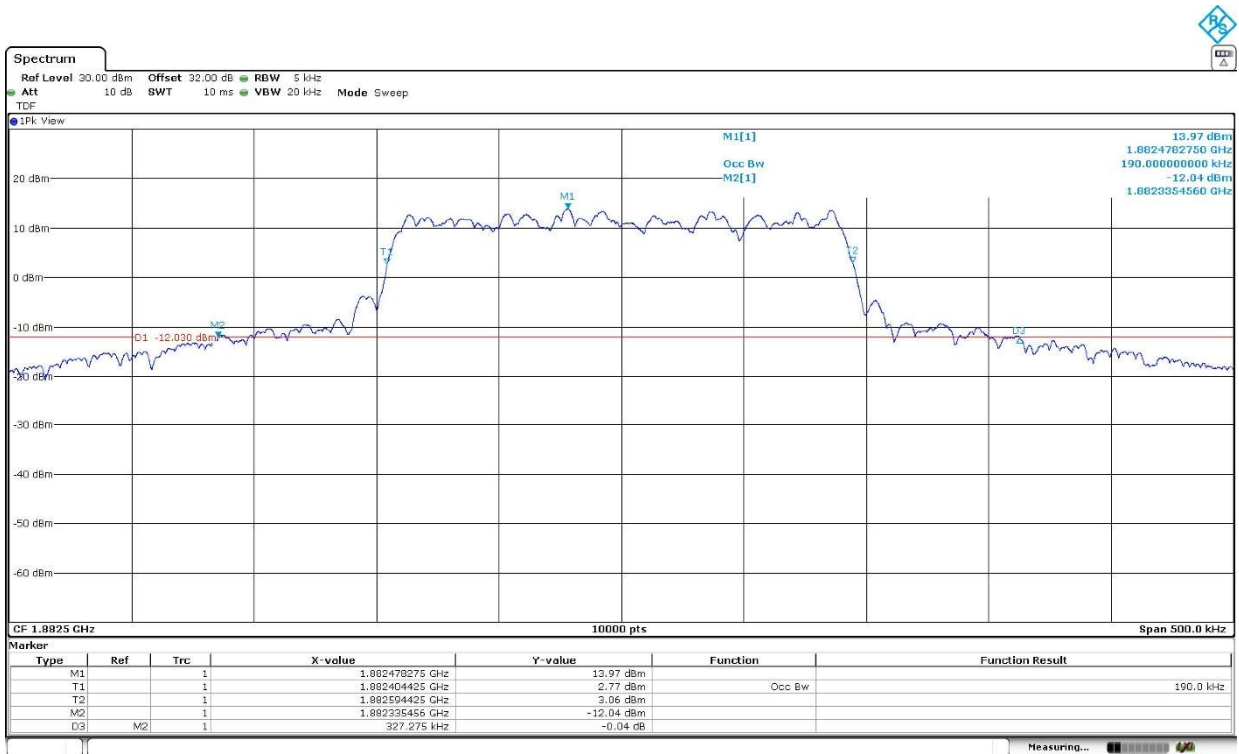

High Channel:

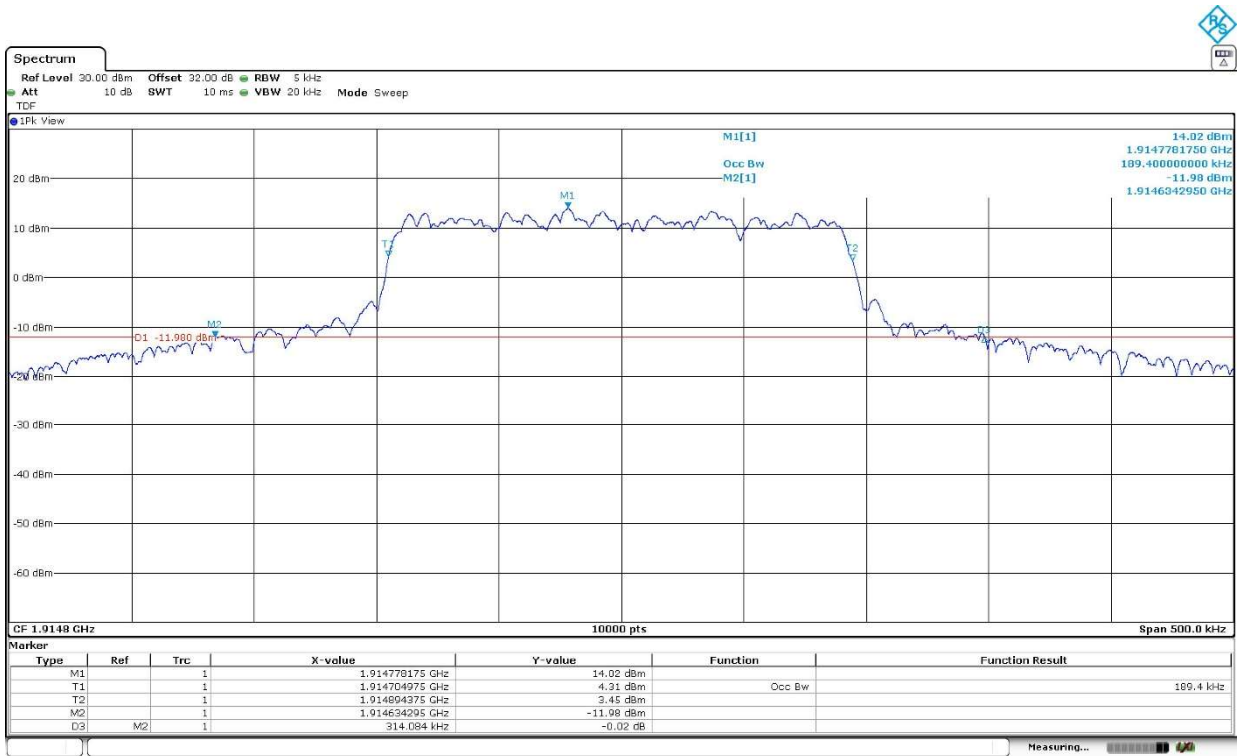

Spurious emissions at antenna terminals

Limits

FCC §2.1051 and §24.238. RSS-133. Clause 6.5.

The power of emissions shall be attenuated below the transmitter power (P) by a factor of at least $43 + 10 \log (P)$ dB. P in watts.

At P_o transmitting power, the specified minimum attenuation becomes $43+10 \log (P_o)$, and the level in dBm relative P_o becomes:

$P_o \text{ (dBm)} - [43 + 10 \log (P_o \text{ in mwatts}) - 30] = -13 \text{ dBm}$.

Method

The EUT RF output connector was connected to a spectrum analyser and to the Universal Radio Communication tester R&S CMW500 (selecting maximum transmission power of the EUT and different modes of modulation) using a 50 ohm attenuator and a power divider.

The spectrum was investigated from 9 kHz to 20 GHz for NB-IoT Band 25.

The reading of the spectrum analyser is corrected with the attenuation loss of connection between output terminal of EUT and input of the spectrum analyser.

The configuration of Resource Blocks and modulation which is the worst case for conducted power was used.

Measurement Limit:

According to specification, the power of emissions shall be attenuated below the transmitter power (P) by a factor of at least $43 + 10 \log (P)$ dB. P in watts.

At P_o transmitting power, the specified minimum attenuation becomes $43+10 \log (P_o)$, and the level in dBm relative P_o becomes:

$$P_o \text{ (dBm)} - [43 + 10 \log (P_o \text{ in mwatts}) - 30] = -13 \text{ dBm}$$

Test Setup

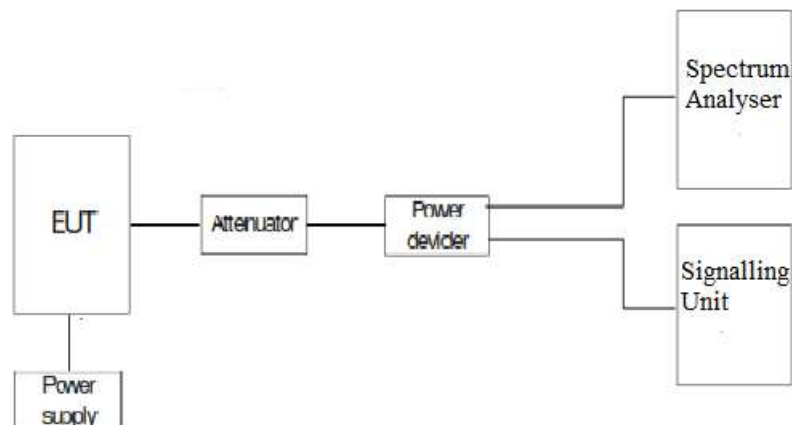

Results

LTE Cat NB1 Band 25:

A preliminary scan determined the worst-case:

Pi/4-QPSK. BW=3.75 kHz. Tone Number=1. Tone Offset=0. MSC/TBS=3.

The next results are for this worst-case configuration.

Frequency range 9 KHz - 20 GHz:

- Low Channel: No spurious frequencies at less than 20 dB below the limit.
- Middle Channel: No spurious frequencies at less than 20 dB below the limit.
- High Channel: No spurious frequencies at less than 20 dB below the limit.

Measurement uncertainty (dB): $<\pm 2.76$

Verdict: PASS

LTE Cat-NB1 Band 25: Pi/4-QPSK. BW=3.75 kHz. Tone Number=1. Tone Offset=0. MSC/TBS=3.

Low Channel:

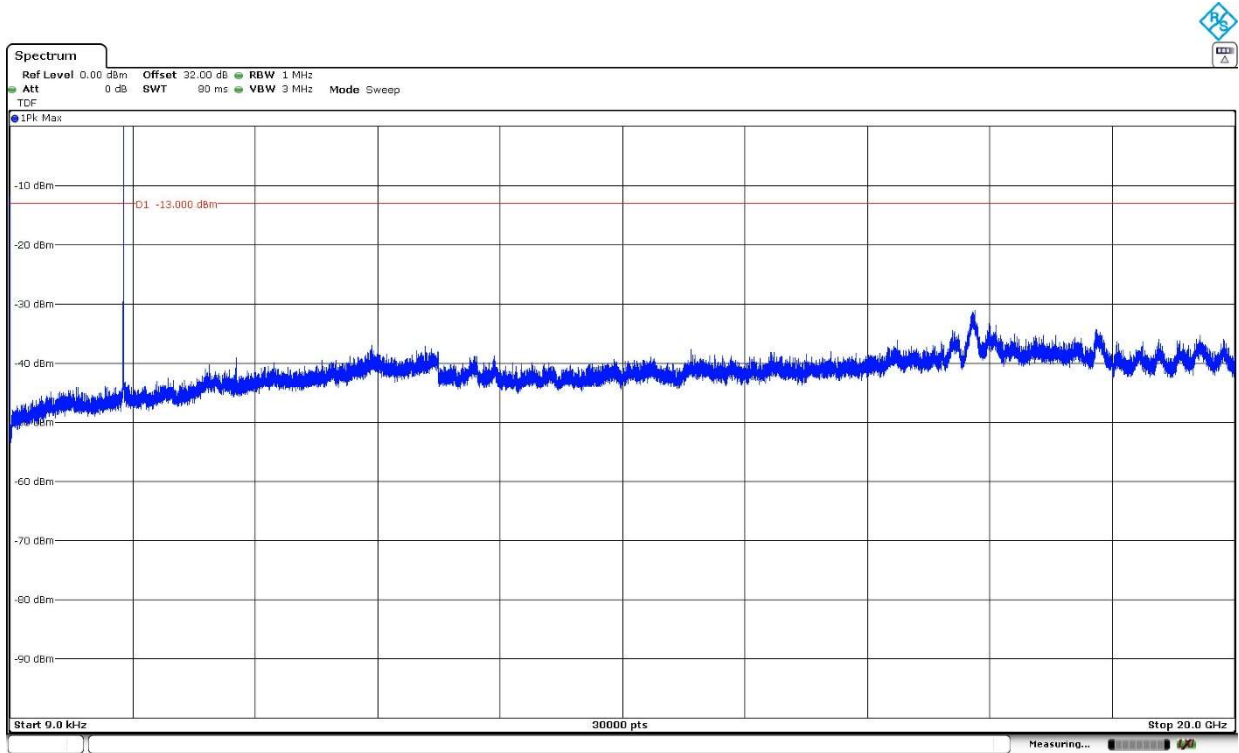

The peak above the limit is the carrier frequency.

Middle Channel:

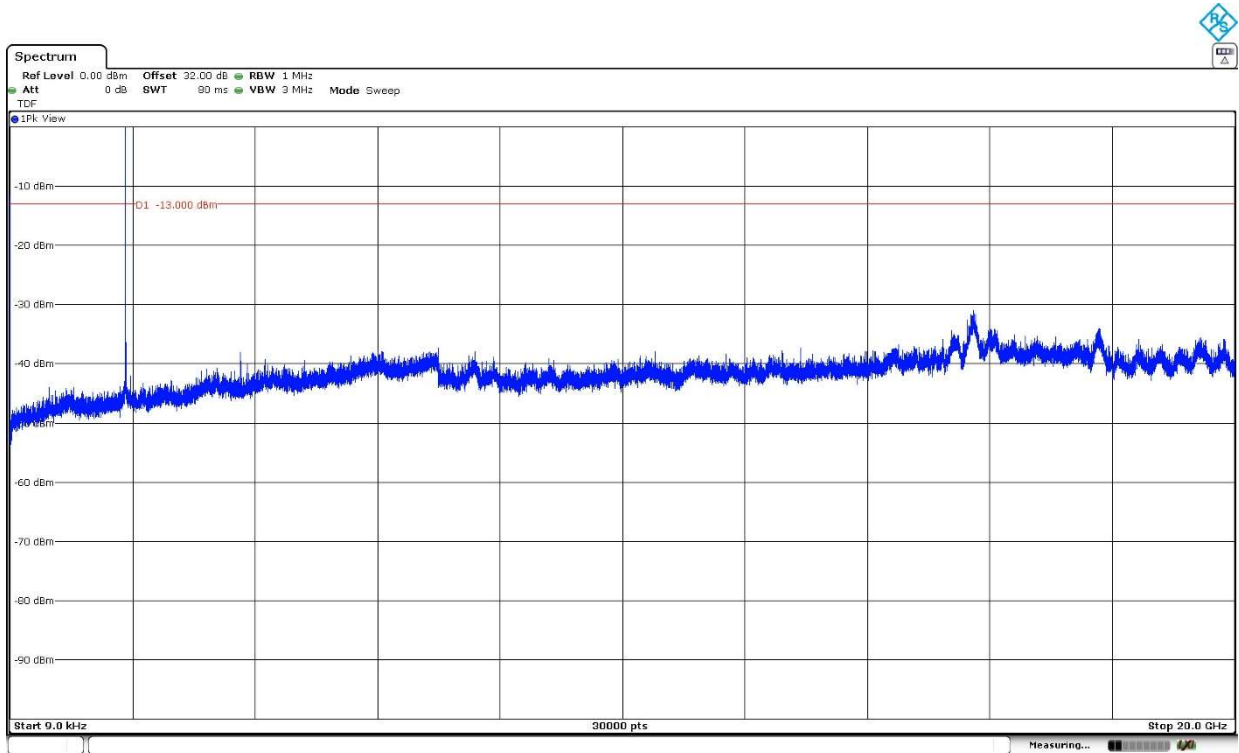

The peak above the limit is the carrier frequency.

High Channel:

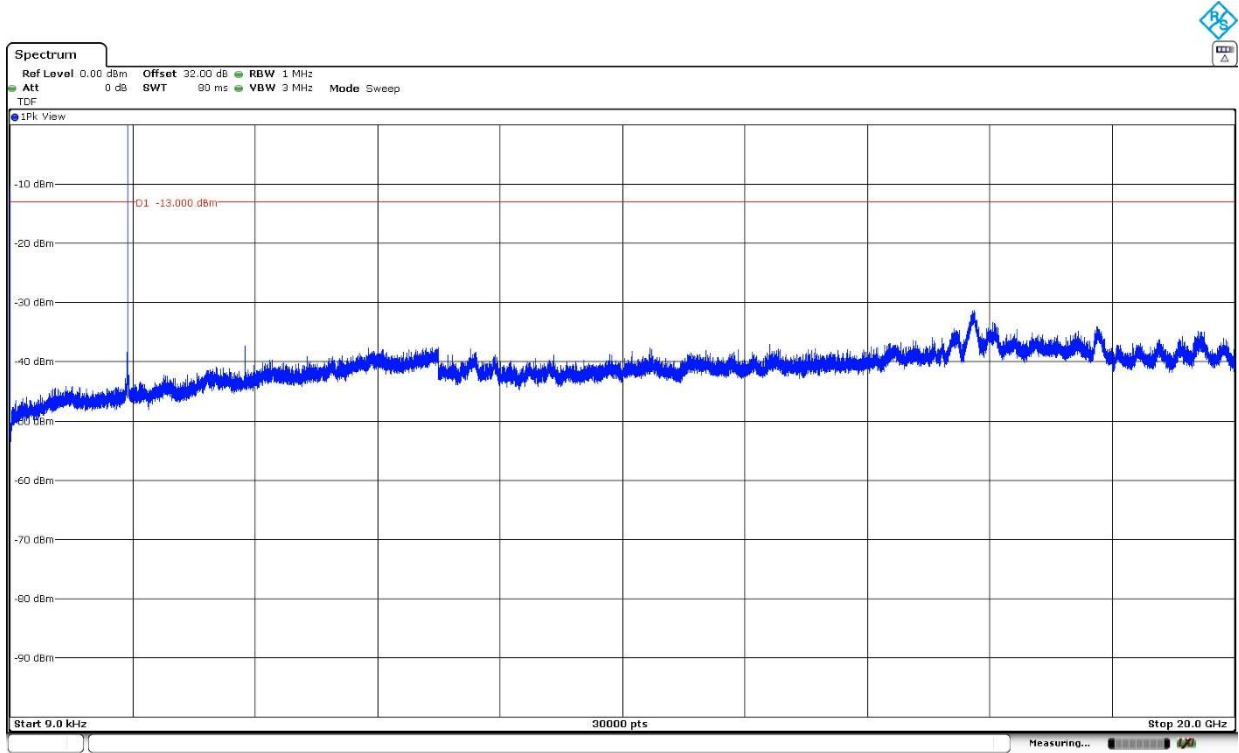

The peak above the limit is the carrier frequency.

Spurious emissions at antenna terminals at Block Edges

Limits

FCC §2.1051 and §24.238. RSS-133 Clause 6.5.:

The power of any emission outside of the authorized operating frequency ranges must be attenuated below the transmitting power (P) by a factor of at least $43 + 10 \log(P)$ dB.

At P_o transmitting power, the specified minimum attenuation becomes $43+10 \log (P_o)$, and the level in dBm relative to P_o becomes:

$$P_o \text{ (dBm)} - [43 + 10 \log (P_o \text{ in mW}) - 30] = -13 \text{ dBm}$$

Method

The EUT RF output connector was connected to a spectrum analyser and to the Universal Radio Communication tester R&S CMW500 (selecting maximum transmission power of the EUT and different modes of modulation) using a 50 ohm attenuator and a power splitter.

The reading of the spectrum analyser is corrected with the attenuation loss of connection between output terminal of EUT and input of the spectrum analyser.

The configuration of modulation which is the worst case for conducted power was used.

As indicated in FCC part 24. in the 1 MHz bands immediately outside and adjacent to the licensee's frequency block. a resolution bandwidth of at least one percent of the emission bandwidth/occupied bandwidth of the fundamental emission of the transmitter may be employed.

Measurement Limit:

According to specification. the power of emissions shall be attenuated below the transmitter power (P) by a factor of at least $43 + 10 \log (P)$ dB. P in watts.

At P_o transmitting power. the specified minimum attenuation becomes $43+10\log (P_o)$. and the level in dBm relative P_o becomes:

$$P_o \text{ (dBm)} - [43 + 10 \log (P_o \text{ in mwatts}) - 30] = - 13 \text{ dBm}$$

Test Setup

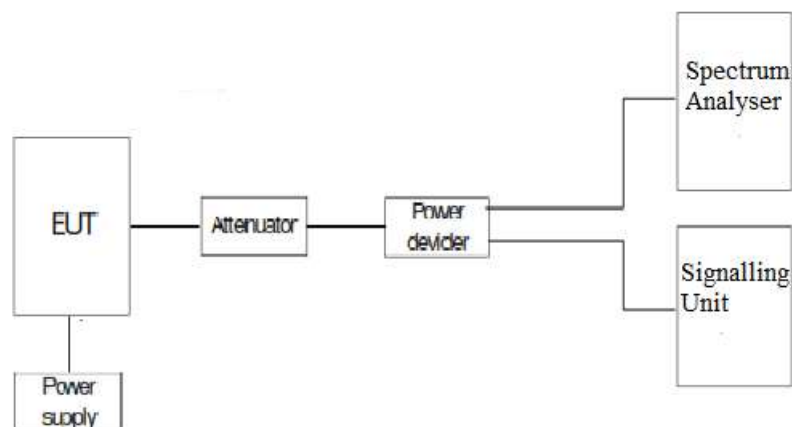

Results

LTE Cat NB1 Band 25:

Preliminary measurements determined the worst-case. Results attached are for this worst-case configuration.

LTE Cat NB1 Band 25	Pi/4-QPSK BW=3.75 kHz Tone Number=1 Tone Offset=0 MSC/TBS=3	Pi/4-QPSK BW=15 kHz Tone Number=1 Tone Offset=0 MSC/TBS=3	QPSK BW=15 kHz Tone Number=12 Tone Offset=0 MSC/TBS=5
Maximum measured level at <u>Low Block Edge</u> at antenna port (dBm)	-15.75	-25.01	-29.63

LTE Cat NB1 Band 25	Pi/4-QPSK BW=3.75 kHz Tone Number=1 Tone Offset=47 MSC/TBS=3	Pi/4-QPSK BW=15 kHz Tone Number=1 Tone Offset=11 MSC/TBS=3	QPSK BW=15 kHz Tone Number=12 Tone Offset=0 MSC/TBS=5
Maximum measured level at <u>High Block Edge</u> at antenna port (dBm)	-15.15	-21.78	-29.05

Measurement uncertainty (dB): ± 2.76

Verdict

Pass

LTE Cat NB1 Band 25. Pi/4-QPSK. BW=3.75 kHz. Tone Number=1. Tone Offset=0. MSC/TBS=0. Low Channel:

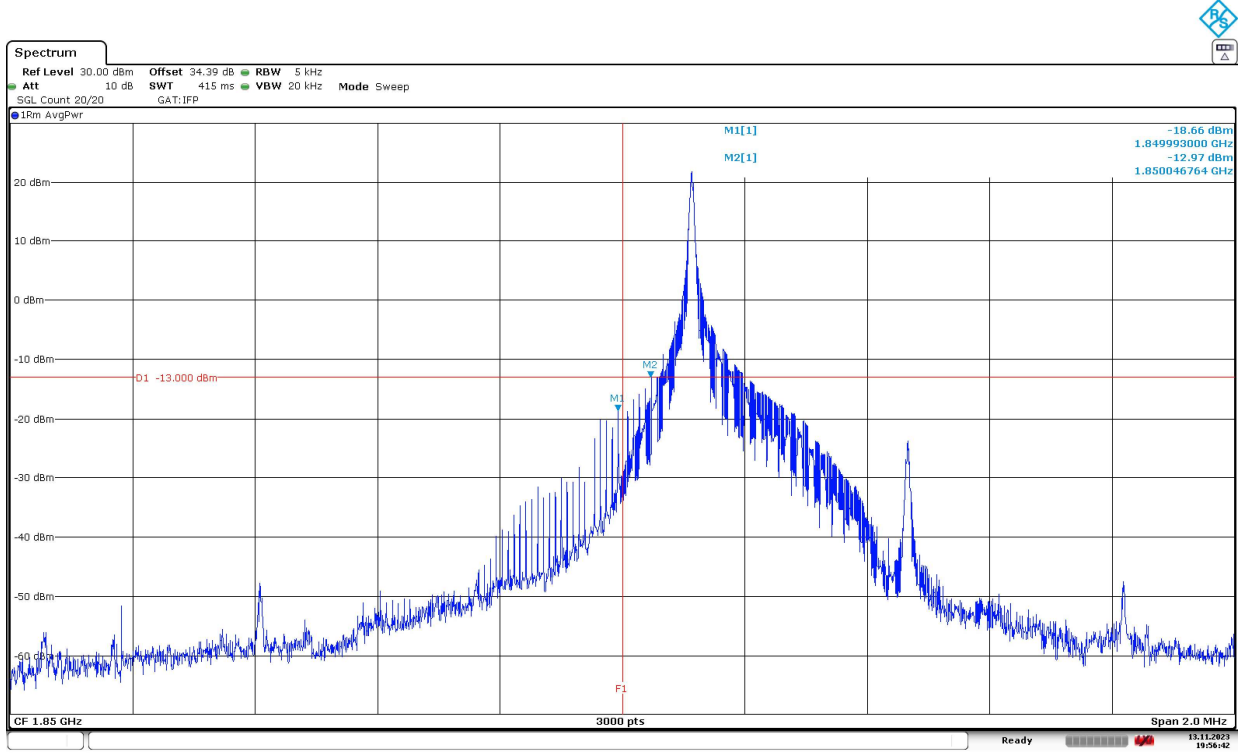

The equipment transmits at the maximum output power

LTE Cat NB1 Band 25. Pi/4-QPSK. BW=3.75 kHz. Tone Number=1. Tone Offset=47. MSC/TBS=0. High Channel:

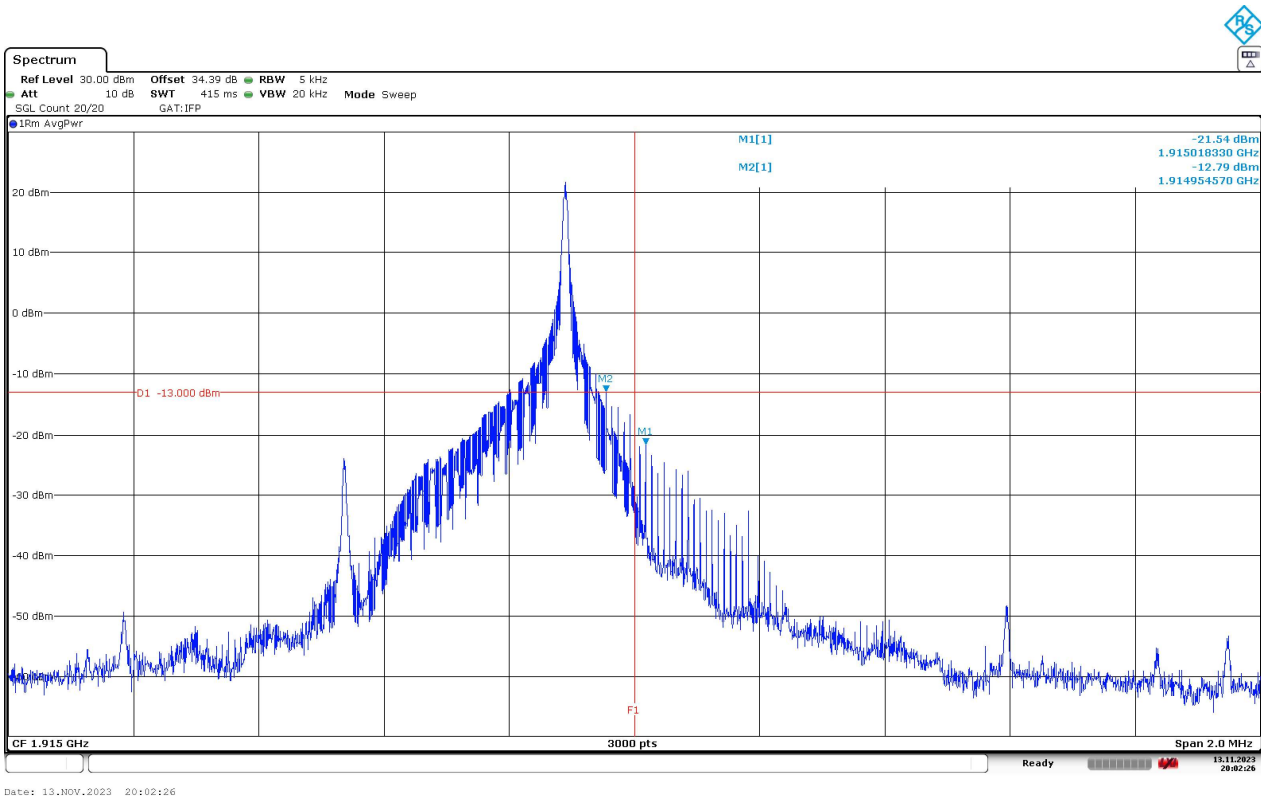

The equipment transmits at the maximum output power

LTE Cat NB1 Band 25. Pi/4-QPSK. BW=15 kHz. Tone Number=1. Tone Offset=0. MSC/TBS=0. Low Channel:

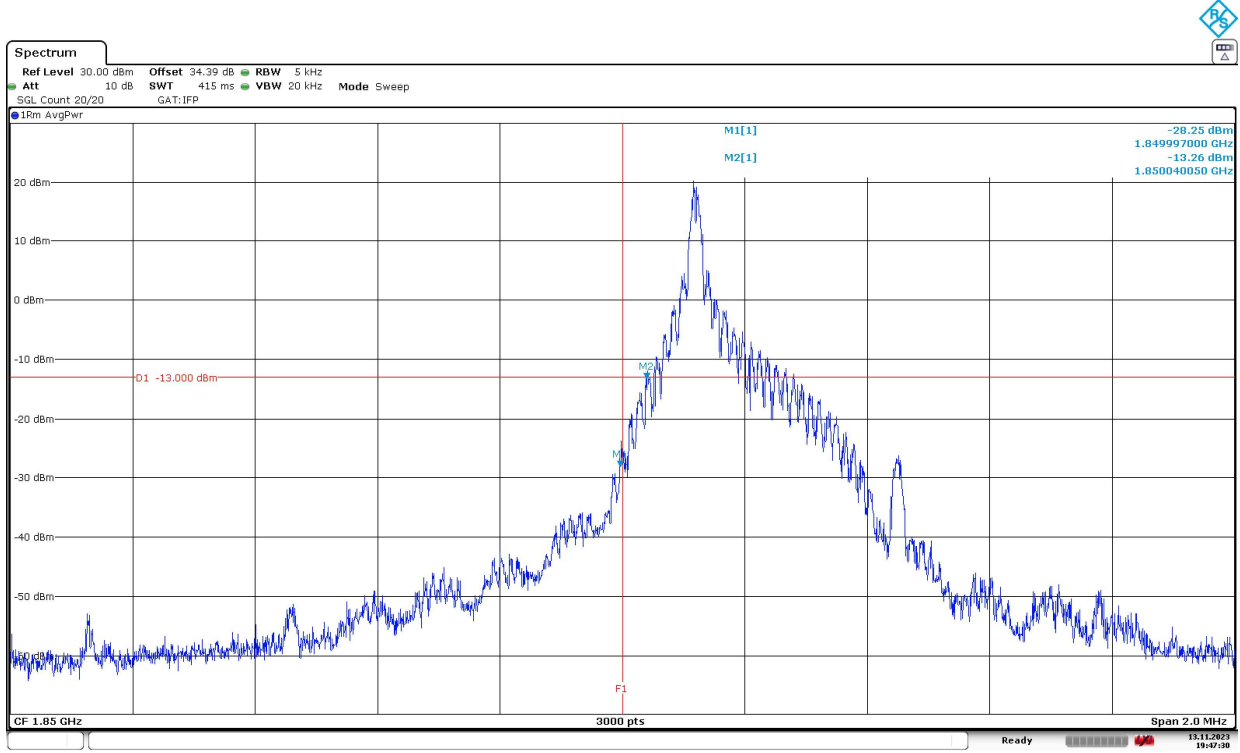

The equipment transmits at the maximum output power

LTE Cat NB1 Band 25. Pi/4-QPSK. BW=15 kHz. Tone Number=1. Tone Offset=11. MSC/TBS=0. High Channel:

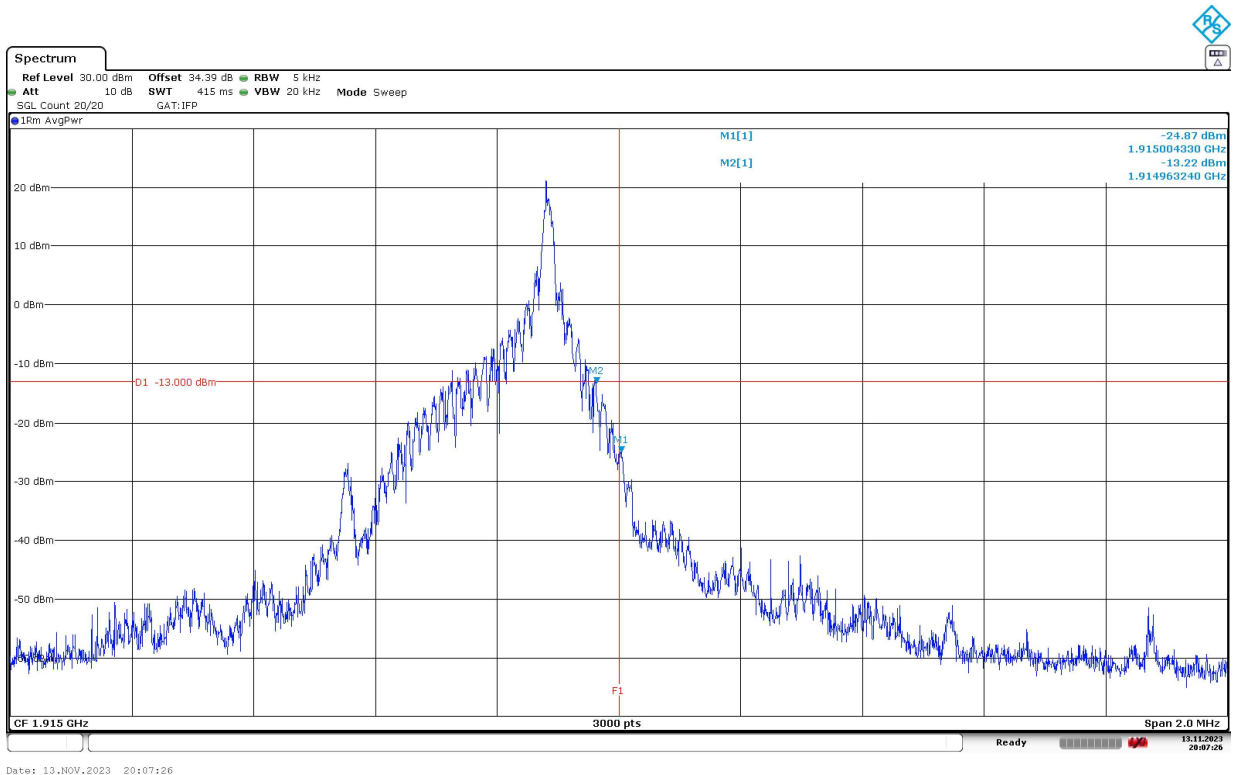

The equipment transmits at the maximum output power

LTE Cat NB1 Band 25. QPSK. BW=15 kHz. Tone Number=12. Tone Offset=0. MSC/TBS=5. Low Channel:

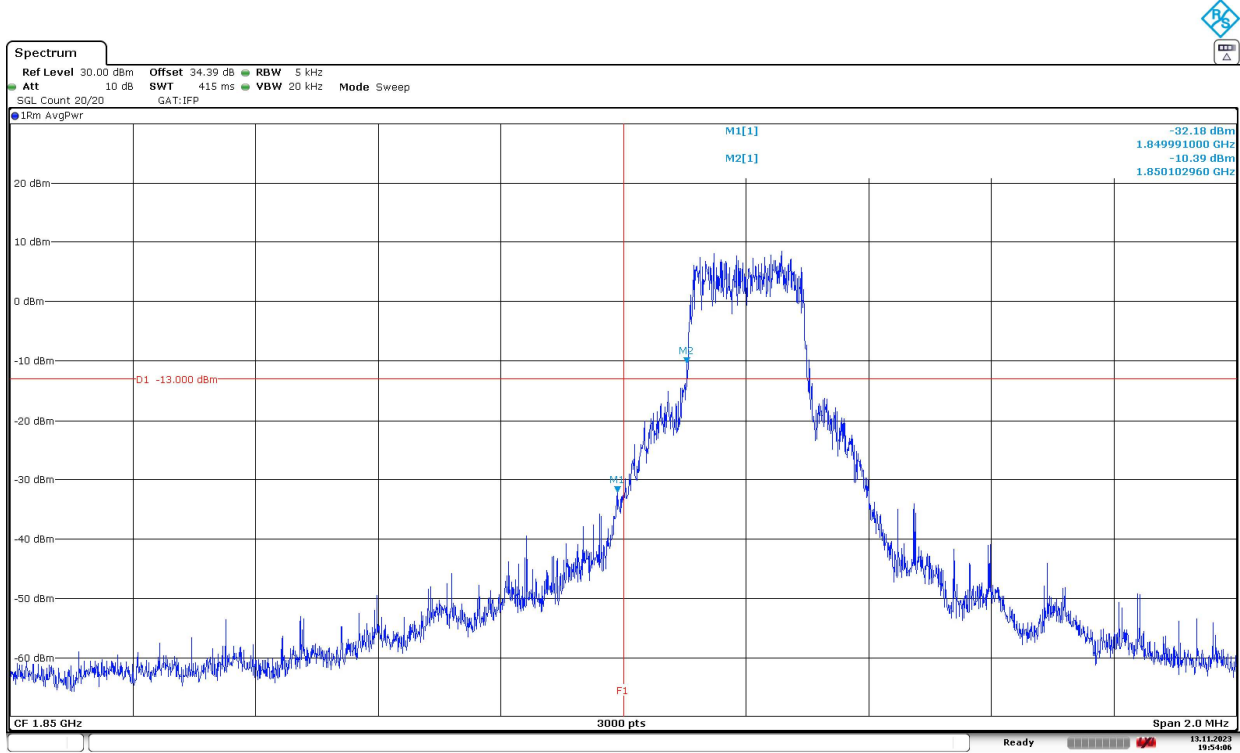

The equipment transmits at the maximum output power

LTE Cat NB1 Band 25. QPSK. BW=15 kHz. Tone Number=12. Tone Offset=0. MSC/TBS=5. High Channel:

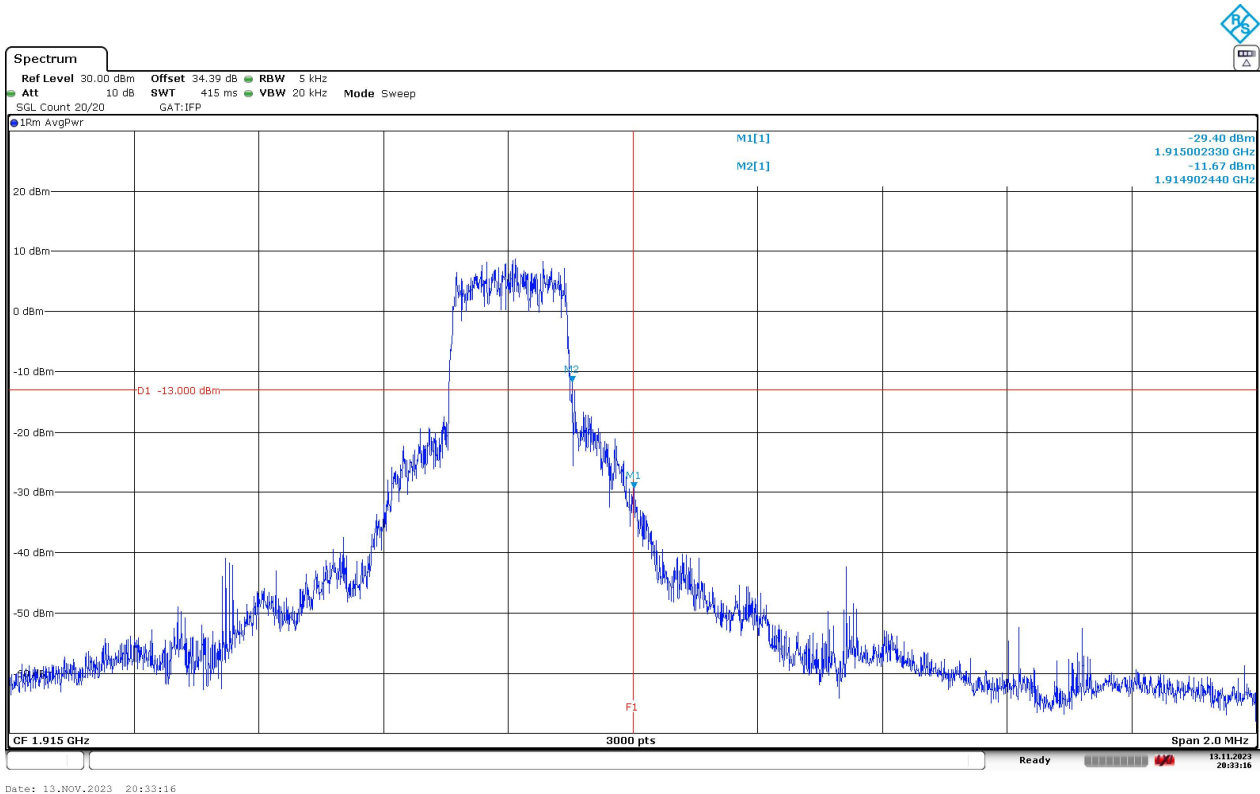

The equipment transmits at the maximum output power