

## TEST CONDITIONS

(\*): Data provided by the Applicant.

### POWER SUPPLY (\*):

Vnormal: 5 Vdc.

Vmin 3 Vdc

Vmax 5.5Vdc

Type of Power Supply: Internal DC.

### ANTENNA (\*):

Bands	Gain (dBi)	Type
LTE Cat NB1 Band 5	+2.7	SMD
LTE Cat NB1 Band 26	+2.7	SMD

### TEST FREQUENCIES:

LTE Cat NB1 Band 5. Pi/2-BPSK, Pi/4-QPSK, QPSK Modulations:

Channel. Number (Frequency, MHz)		
Low	Middle	High
20402 (824.20)*	20525 (836.50)	20648 (848.80)*
*The outermost channel which is in compliance with Block edge testing.		

NOTE: The 824-849 MHz sub-band of the LTE Cat-NB1 Band 5 is completely included in the LTE Cat-NB1 Band 26, so the LTE Cat-M1 Band 26 channels were tested to give conformity to the assigned block.

LTE Cat NB1 Band 26. Pi/2-BPSK, Pi/4-QPSK, QPSK modulations:

Channel. Number (Frequency, MHz)		
Low	Middle	High
20402 (824.20)*	20525 (836.50)	20648 (848.80)*
*The outermost channel which is in compliance with Block edge testing.		

## RF Output Power

### Limits

FCC §2.1046 and FCC §22.913. The Effective Radiated Power (E.R.P) of mobile transmitter and auxiliary test transmitter must not exceed 7 Watts (38.45 dBm E.R.P.).

RSS-132. Clause 5.4. The equivalent isotropically radiated power (e.i.r.p.) for mobile equipment shall not exceed 11.5 watts (38.45 dBm E.R.P.).

In addition, the peak-to-average power ratio (PAPR) of the transmitter shall not exceed 13 dB for more than 0.1% of the time using a signal corresponding to the High PAPR during periods of continuous transmission.

### Method

The conducted RF output power measurements were made at the RF output terminals of the EUT using the power meter of the Universal Radio Communication tester R&S CMW500, selecting maximum transmission power of the EUT and different modes of modulation.

The peak-to-average power ratio (PAPR) is measured using an attenuator, power splitter and spectrum analyser with a Complementary Cumulative Distribution Function implemented.

The maximum equivalent isotropically radiated power (e.i.r.p.) is calculated by adding the declared maximum antenna gain (dBi).

The maximum effective radiated power e.r.p. is calculated from the maximum equivalent isotropically radiated power (e.i.r.p.) by subtracting 2.15 dB:

$$E.R.P. = E.I.R.P. - 2.15 \text{ dB}$$

### Test Setup

#### 3. CONDUCTED AVERAGE POWER:



#### 4. PEAK-TO-AVERAGE POWER RATIO (PAPR) and Conducted Average power:

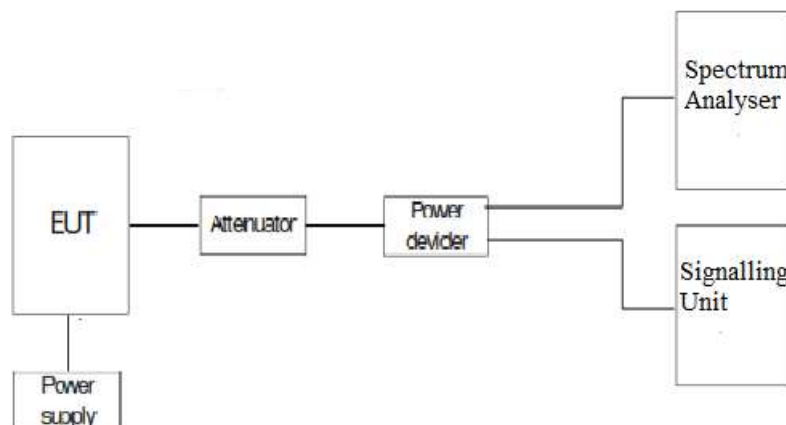

## Results

### 1. CONDUCTED AVERAGE POWER

LTE Cat NB1 Band 26:

Preliminary measurements determined the worst case of RF Power is Low Channel, Pi/2-BPSK, BW=3.75 kHz, Tone Number=1, Tone Offset=0, MSC/TBS=0.

CHANNEL	FREQUENCY (MHz)	MODULATION	BW	Tone Number	Tone Offset (Start SubCarrier)	MCS / TBS	AVERAGE POWER (dBm)	
Low 26792	824.,2 MHz	Pi/2-BPSK	3.75 kHz	1	0	0	23.07	
				1	47	0	22.96	
			15 kHz	1	0	0	23.01	
				1	11	0	23.01	
		Pi/4-QPSK	3.75 kHz	1	0	3	23.10	
				1	47	3	23.03	
			15 kHz	1	0	3	22.96	
				1	11	3	22.93	
			QPSK	15 kHz	3	0	5	22.70
					3	6	5	22.69
		6			0	5	22.00	
		6			6	5	21.88	
					12	0	5	20.95
		Middle 26915	836.50 MHz	Pi/2-BPSK	3.75 kHz	1	0	0
1	47					0	21.78	
15 kHz	1				0	0	22.99	
	1				11	0	22.99	
Pi/4-QPSK	3.75 kHz			1	0	3	22.98	
				1	47	3	21.59	
	15 kHz			1	0	3	22.93	
				1	11	3	22.91	
	QPSK			15 kHz	3	0	5	22.64
					3	6	5	22.79
6					0	5	21.82	
6					6	5	21.84	
					12	0	5	20.82
High 27038	848.8 MHz			Pi/2-BPSK	3.75 kHz	1	0	0
		1	47			0	23.00	
		15 kHz	1		0	0	22.95	
			1		11	0	23.22	
		Pi/4-QPSK	3.75 kHz	1	0	3	23.11	
				1	47	3	22.97	
			15 kHz	1	0	3	22.88	
				1	11	3	22.9	
			QPSK	15 kHz	3	0	5	22.62
					3	6	5	22.73
		6			0	5	21.82	
		6			6	5	21.86	
					12	0	5	20.83

MAX POWER	COND. POWER AVG (dBm)	ANTENNA GAIN (dBi)	RAD. POWER AVG (dBm)	RAD. POWER AVG ERP (dBm)
LOW	23.07	2.7	25.77	23.62
MIDDLE	22.99	2.7	25.69	23.54
HIGH	23.04	2.7	25.74	23.59
MAX:	23.07		25.77	

## 2. PEAK-TO-AVERAGE POWER RATIO (PAPR)

### LTE Cat NB1 Band 26:

Preliminary measurements determined the worst-case of PAPR is Middle Channel, 16QAM, BW=15 kHz, Tone Number=12, Tone Offset=0, MSC/TBS=5.

#### Low Channel:

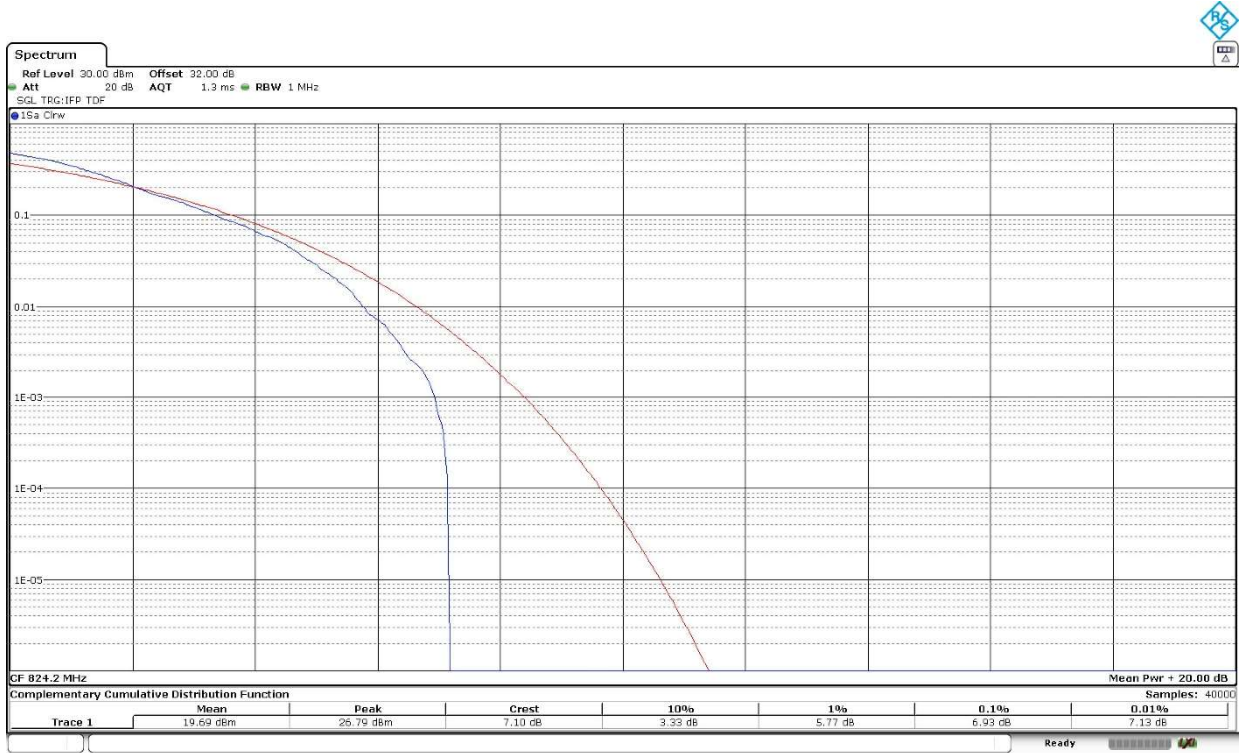

#### Middle Channel:

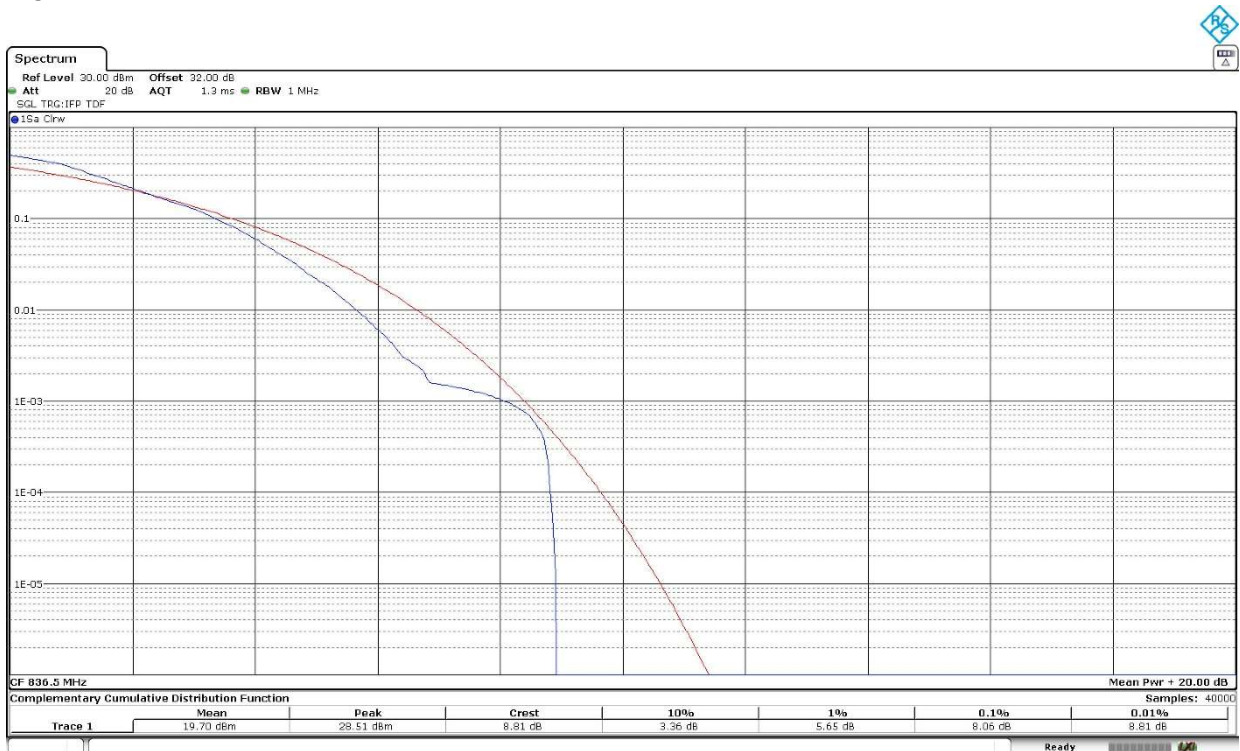

High Channel:

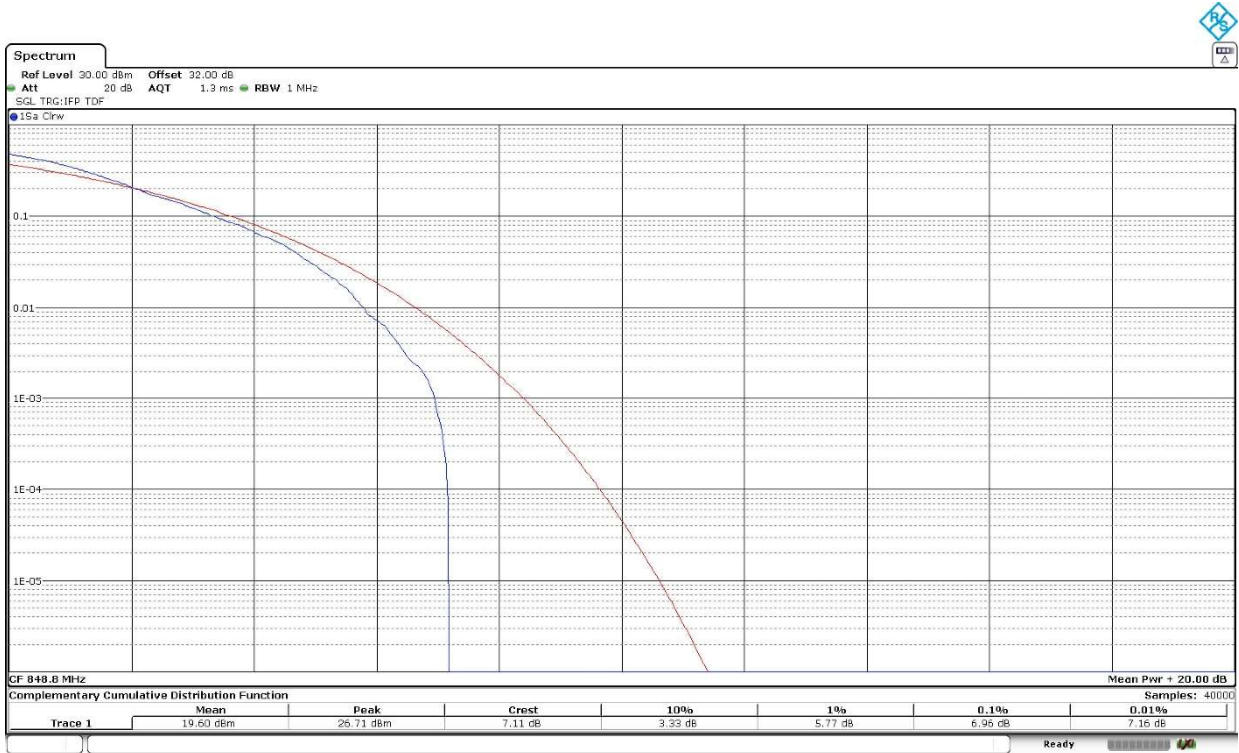

16QAM	Low	Middle	High
PAPR (dB)	6.93	8.06	6.96

Measurement uncertainty (dB)  $<\pm 1.11$

**Verdict**

Pass

## Frequency Stability

### **Limits**

FCC §2.1055 and §22.355.  $\pm 2.5$  ppm for mobile stations operating in the range 821 to 896 MHz.

RSS-132. Clause 5.3. The carrier frequency shall not depart from the reference frequency in excess of  $\pm 2.5$  ppm for mobile stations.

### **Method**

The frequency tolerance measurements over temperature variations were made over the temperature range of  $-30^{\circ}\text{C}$  to  $+50^{\circ}\text{C}$ . The EUT was placed inside a climatic chamber and the temperature was raised hourly in  $10^{\circ}\text{C}$  steps from  $-30^{\circ}\text{C}$  up to  $+50^{\circ}\text{C}$ .

The supply voltage was varied between 85% and 115% of nominal voltage.

Temperature and voltage range of testing has been extended to the maximum and minimum values declared by customer.

The EUT was set in "Radio Resource Control (RRC) mode" on the middle channel using the Universal Radio Communication tester R&S CMW500 and the maximum frequency error was measured using the built-in calibrated frequency meter.

The worst-case LTE mode for conducted power was used for the test.

In order to check that the frequency stability is sufficient such that the fundamental emissions stay within the authorized bands of operation, a reference point is established at the applicable unwanted emissions limit using a RBW equal to the RBW required by the unwanted emissions specification of the applicable regulatory standard. These reference points measured using the Low and High channels of operation are identified as fL and fH respectively. The worst-case frequency offset determined in the above methods is added or subtracted from the values of fL and fH to check that the resulting frequencies remain within the band.

The reference point measurements were made at the RF output terminals of the EUT using an attenuator, power splitter and spectrum analyser. The EUT was controlled via the Universal Radio Communication tester R&S CMW500 selecting maximum transmission power of the EUT and different modes of modulation.

### Test Setup

Frequency tolerance:

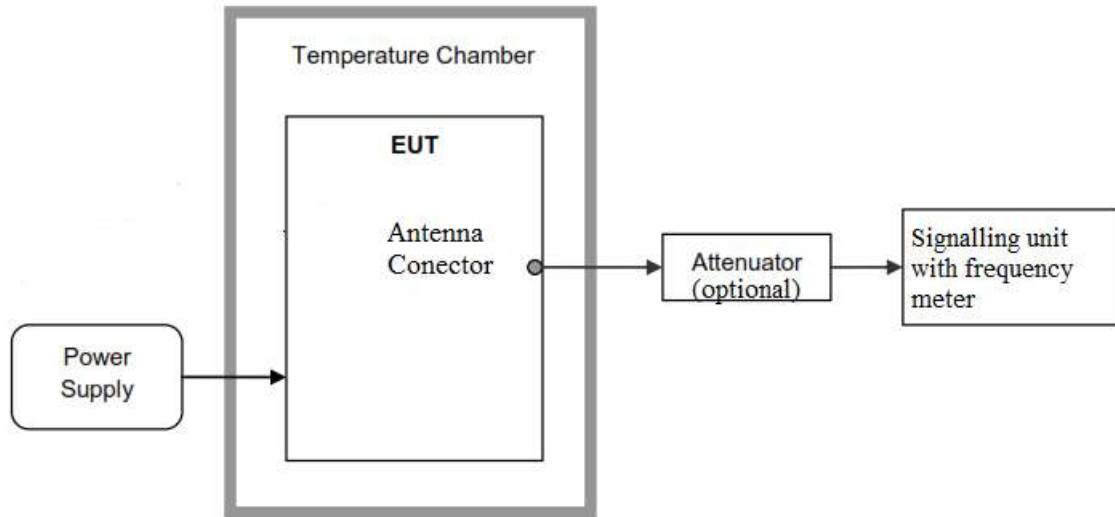

Reference points  $f_L$  and  $f_H$ :

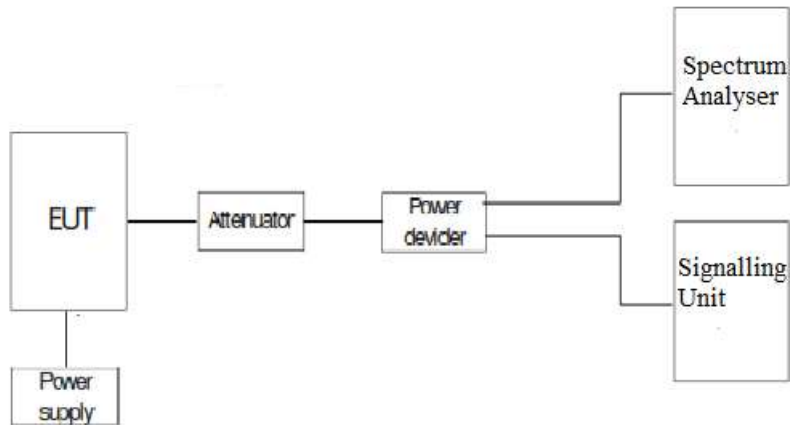



## Results

### LTE Cat NB1 Band 26:

The worst case modulation in terms of Frequency Stability is QPSK, BW=15 kHz, Tone Number=3, Tone Offset=6, MSC/TBS=5.

#### 1. Frequency Tolerance:

- **Frequency Stability over Temperature Variations:**

Temperature (°C)	Frequency Error (Hz)	Frequency Error (ppm)
+85	-3,13	-0,003741781
+80	-8,76	-0,010472206
+70	-8,64	-0,010328751
+60	-5,42	-0,006479378
+50	-6,77	-0,008093246
+40	-8,75	-0,010460251
+30	-4,53	-0,005415421
+20	7,24	0,008655111
+10	-9,91	-0,011846981
0	-5,72	-0,006838016
-10	-0,2	-0,000239091
-20	-8,11	-0,009695158
-30	-8,47	-0,010125523
-40	-16,58	-0,019820681

- **Frequency Stability over Voltage Variations.**

Supply voltage	Voltage (V)	Frequency Error (Hz)	Frequency Error (ppm)
Vmax	5.5	-9.81	-0.011727436
Vmin	3	-1,24	-0,001482367

#### 2. Reference Frequency Points fL and fH:

The worst-case frequency offsets added or subtracted per band and bandwidth:

f <sub>L</sub> (MHz)	824.0137
f <sub>H</sub> (MHz)	848.9918

The reference frequency points f<sub>L</sub> and f<sub>H</sub> stay within the authorized blocks for the band above.

Measurement uncertainty (Hz) <± 249.55

Verdict: PASS

## Modulation Characteristics

### Limits

FCC §2.1047.

RSS-132. Clause 5.2: Equipment certified under this standard shall use digital modulation.

### Method

For LTE NB1 the EUT operates with  $\pi/2$ -BPSK,  $\pi/4$ -QPSK modulations in which the information is digitized and coded into a bit stream. The RF transmission is multiplexed using *Orthogonal Frequency Division Multiplexing (OFDM)* using different possible arrangement of subcarriers (Resource Blocks RB).

### Test Setup

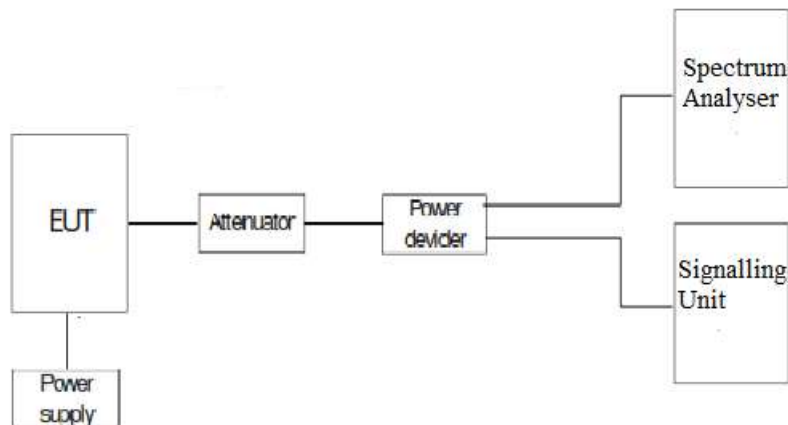

## Results

The following plots show the modulation schemes in the EUT.

**LTE Cat NB1 Band 26:** Pi/2-BPSK. Middle Channel. BW=3.75 kHz. Tone Number=1. Tone Offset=0. MSC/TBS=0.

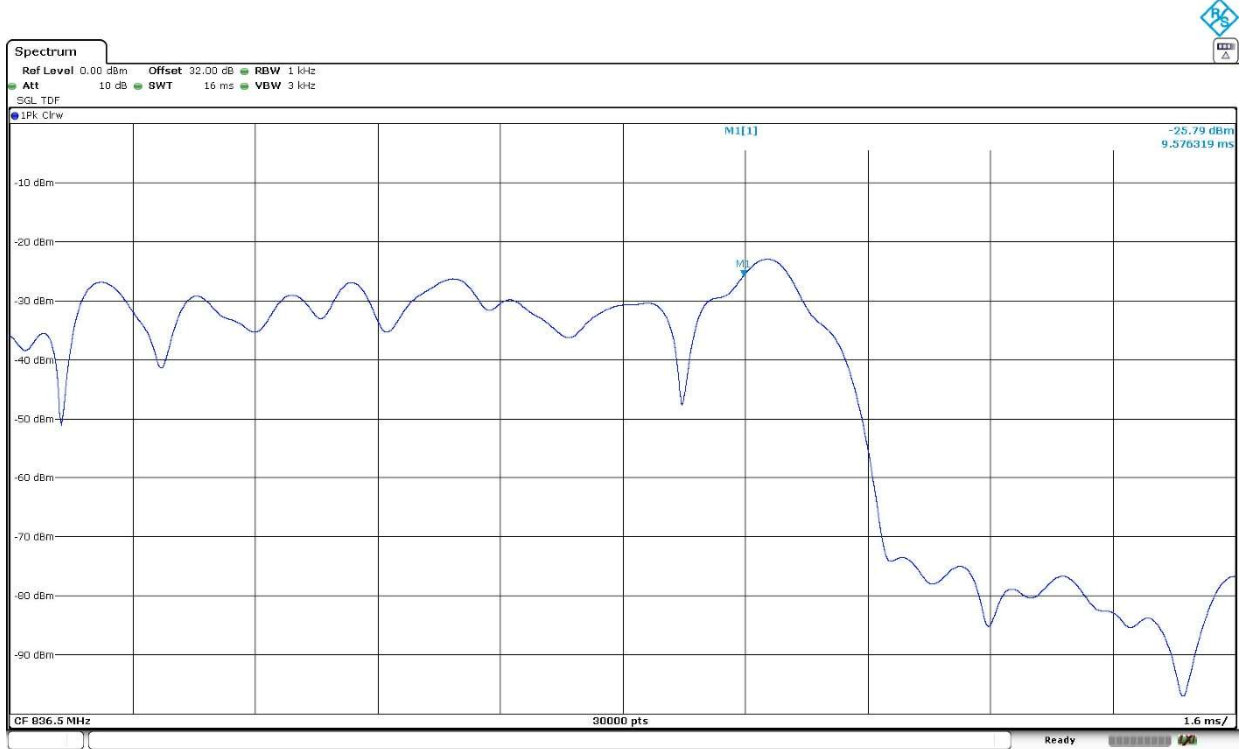

**LTE Cat NB1 Band 26:** Pi/4-QPSK. Middle Channel. BW=3.75 kHz. Tone Number=1. Tone Offset=0. MSC/TBS=3.

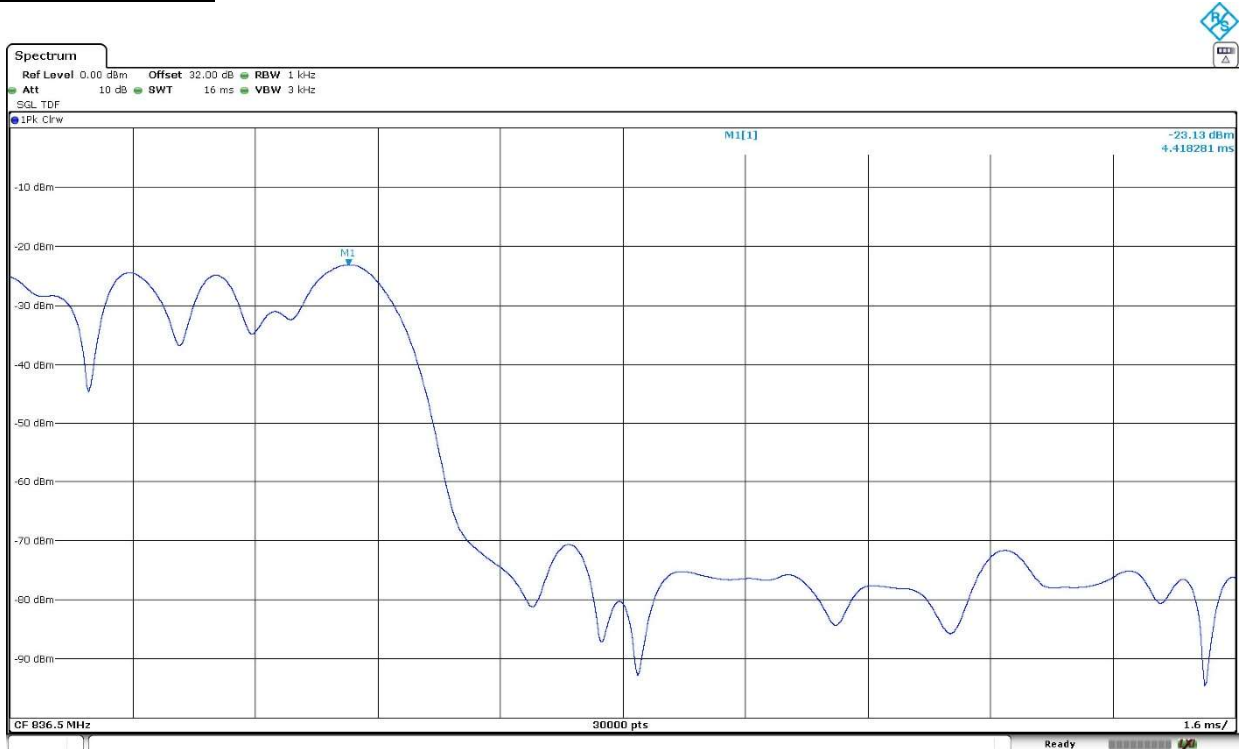

## Occupied Bandwidth

### Limits

FCC §2.1049. Measurements required: Occupied bandwidth.

RSS-Gen, Clause 6.7.

### Method

The occupied bandwidth measurement was performed at the output terminals of the EUT using an attenuator, power splitter and spectrum analyser. The EUT was controlled via the Universal Radio Communication tester R&S CMW500 selecting maximum transmission power of the EUT and different modes of modulation. The 99% occupied bandwidth and the -26 dBc bandwidth were measured directly using the built-in bandwidth measuring option of spectrum analyser.

### Test Setup

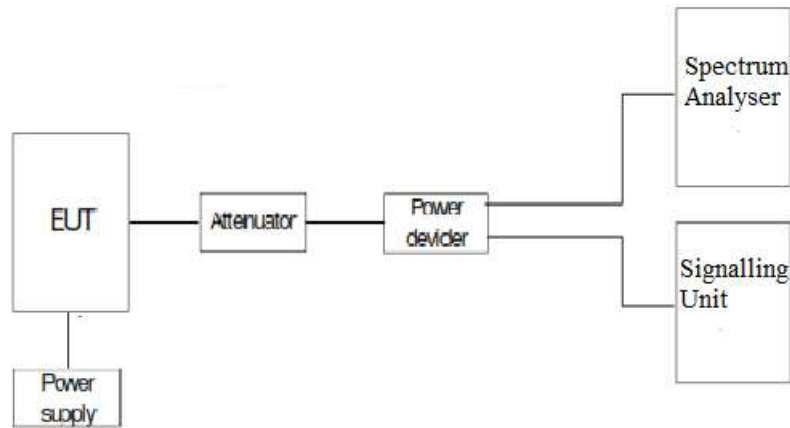

### Results

The worst case per modulation is:

#### LTE Cat NB1 Band 26:

LTE Cat NB1 Band 26. Pi/2-BPSK. BW=3.75 kHz. Tone Number=1. Tone Offset=23. MSC/TBS=0.

	Low Channel	Middle Channel	High Channel
99% Occupied Bandwidth (kHz)	61.65000	60.66000	62.22000
-26 dBc Bandwidth (kHz)	37.73700	40.95400	39.90700
Measurement uncertainty (kHz)	<±3.75		

LTE Cat NB1 Band 26. Pi/4-QPSK. BW=3.75 kHz. Tone Number=1. Tone Offset=23. MSC/TBS=3.

	Low Channel	Middle Channel	High Channel
99% Occupied Bandwidth (kHz)	65.97000	65.82000	70.65000
-26 dBc Bandwidth (kHz)	41.82700	41.82400	48.66900
Measurement uncertainty (kHz)	<±3.75		

LTE Cat NB1 Band 26. Pi/2-BPSK. BW=3.75 kHz. Tone Number=1. Tone Offset=23. MSC/TBS=0.

Low Channel:

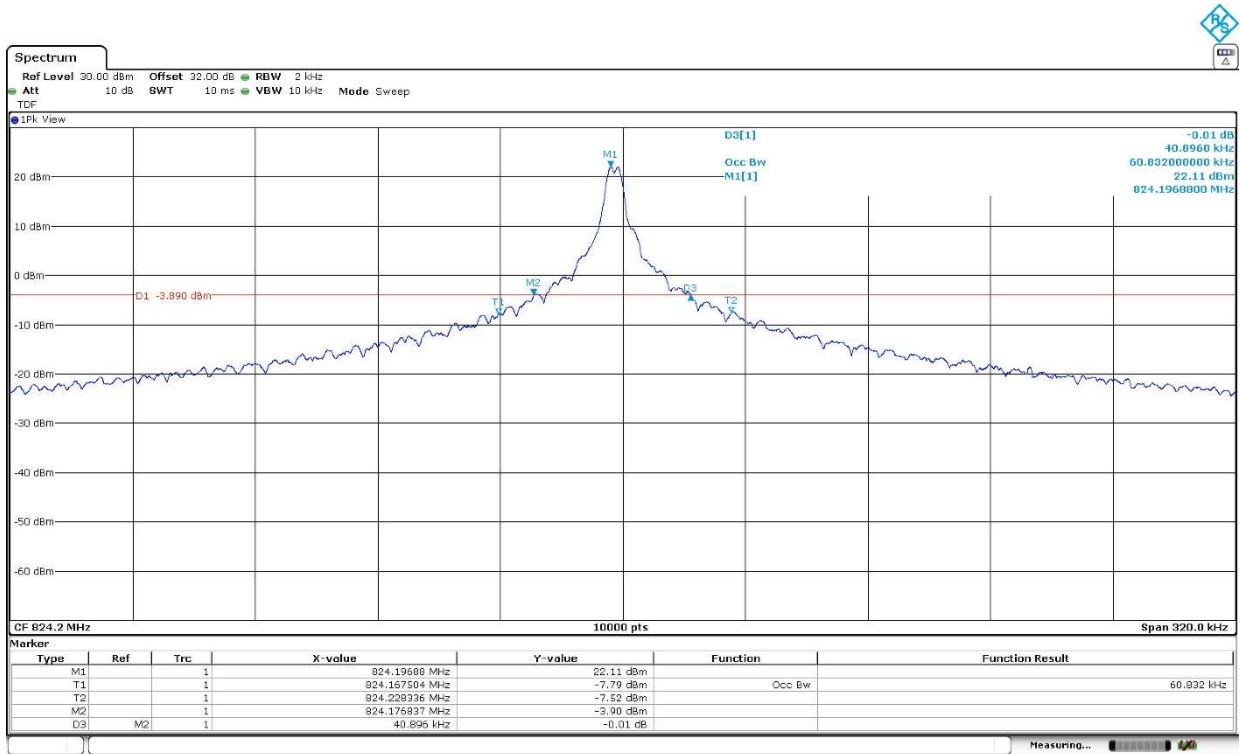

Middle Channel:

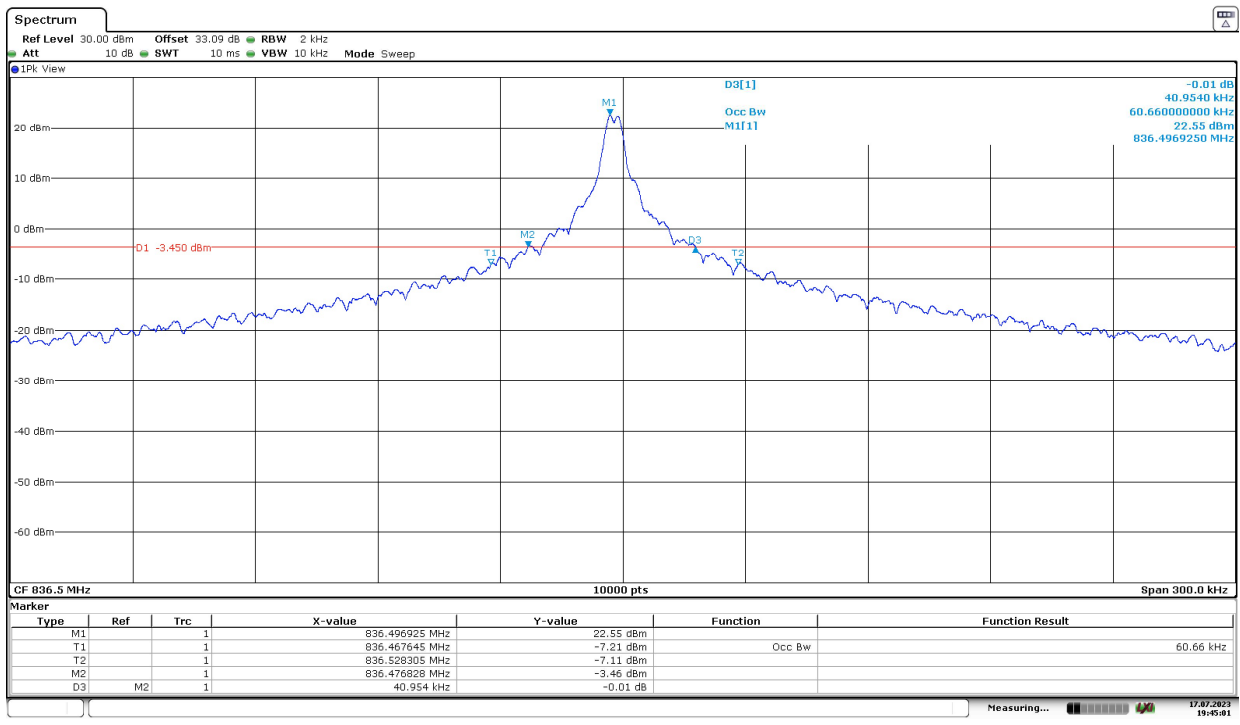

Date: 17. JUL. 2023 19:45:02

High Channel:

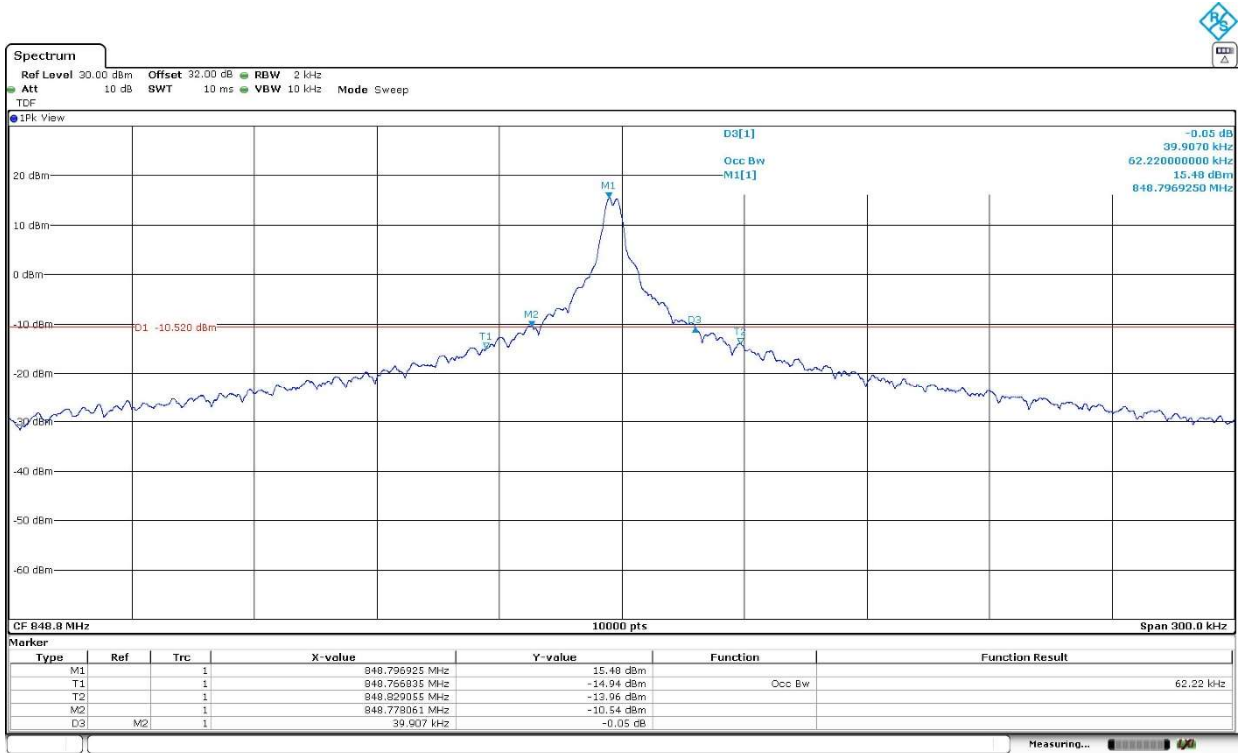

LTE Cat NB1 Band 26. Pi/4-QPSK. BW=3.75 kHz. Tone Number=1. Tone Offset=23. MSC/TBS=3.

Low Channel:

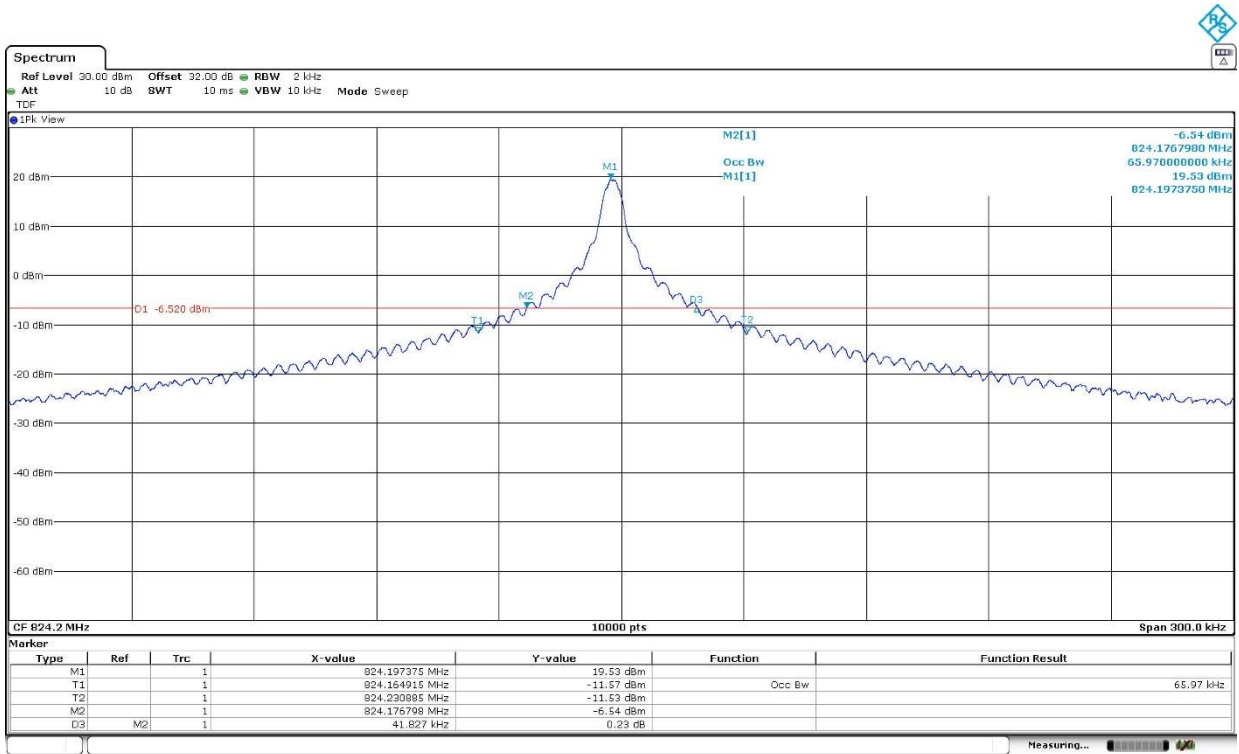

Middle Channel:

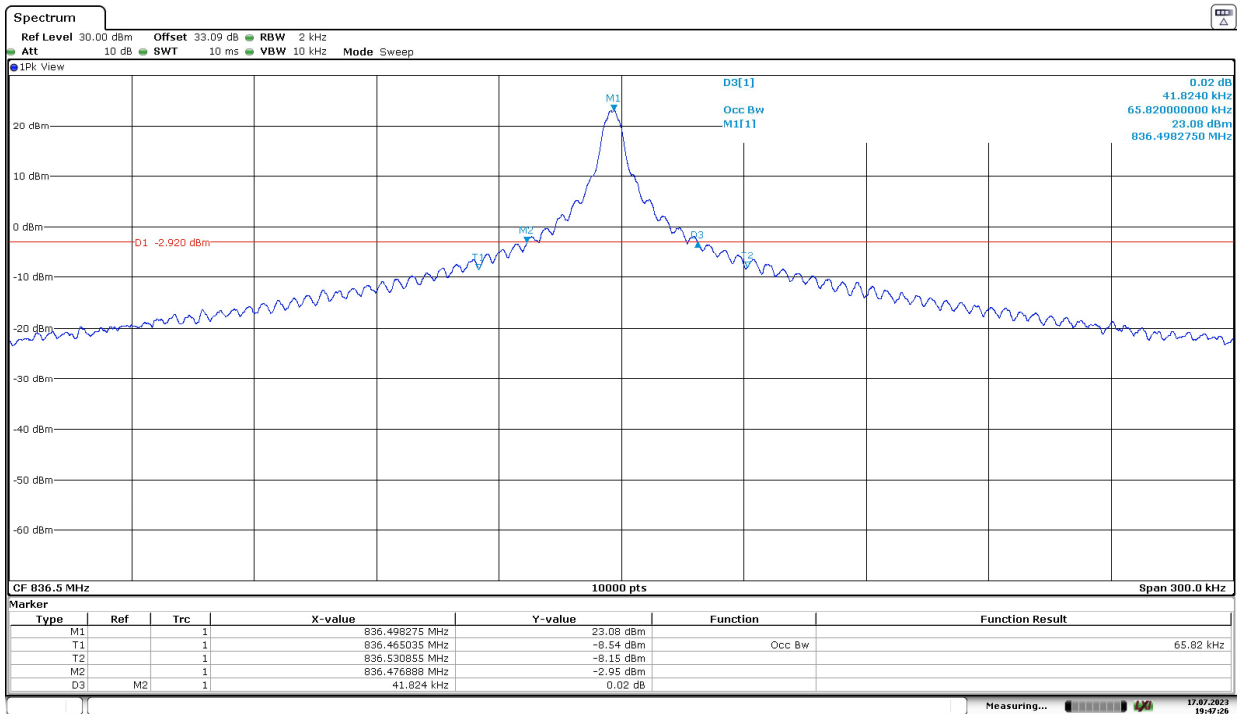

Date: 17. JUL. 2023 19:47:26

High Channel:

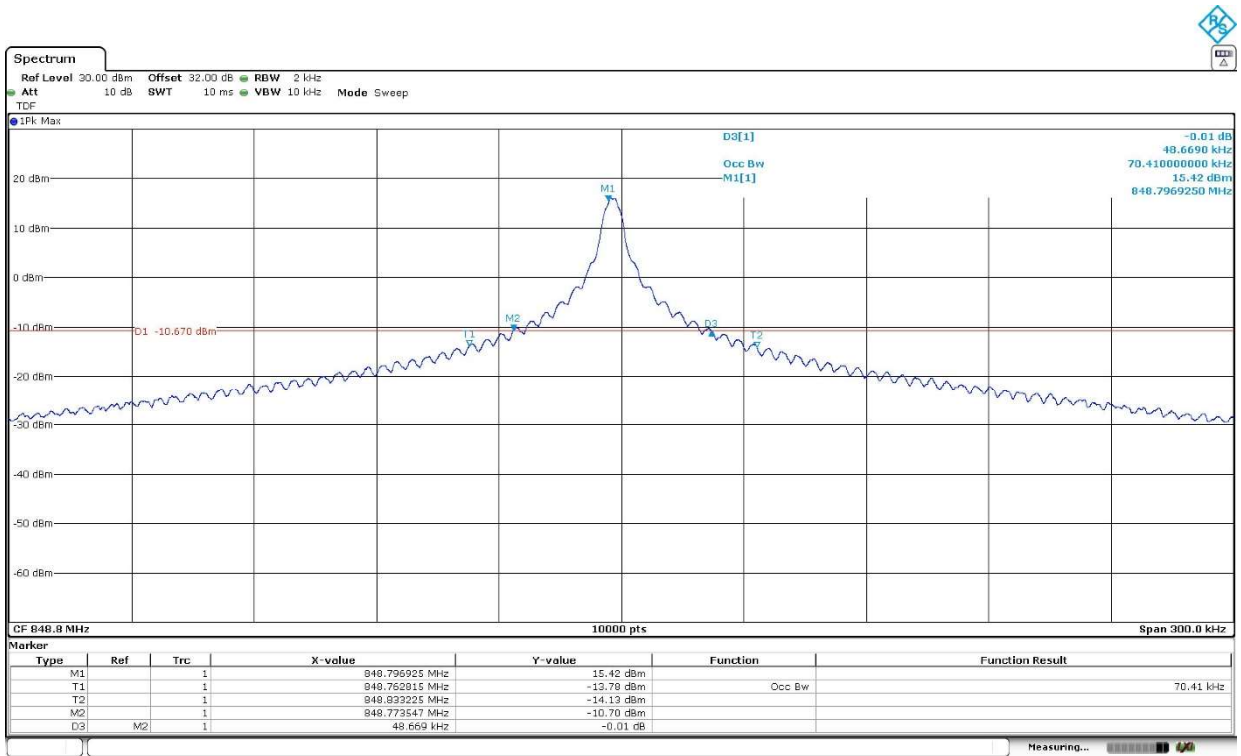



LTE Cat NB1 Band 26. Pi/2-BPSK. BW=15 kHz. Tone Number=1. Tone Offset=5. MSC/TBS=0.

	Low Channel	Middle Channel	High Channel
99% Occupied Bandwidth (kHz)	126.45000	126.24000	126.96000
-26 dBc Bandwidth (kHz)	126.75500	126.35800	129.93670
Measurement uncertainty (kHz)	<±3.75		

LTE Cat NB1 Band 26. QPSK. BW=15 kHz. Tone Number=12. Tone Offset=0. MSC/TBS=5.

	Low Channel	Middle Channel	High Channel
99% Occupied Bandwidth (kHz)	187.12000	186.64000	186.68000
-26 dBc Bandwidth (kHz)	290.76300	290.81400	291.06500
Measurement uncertainty (kHz)	<±3.75		

LTE Cat NB1 Band 26. Pi/2-BPSK. BW=15 kHz. Tone Number=1. Tone Offset=5. MSC/TBS=0.

Low Channel:

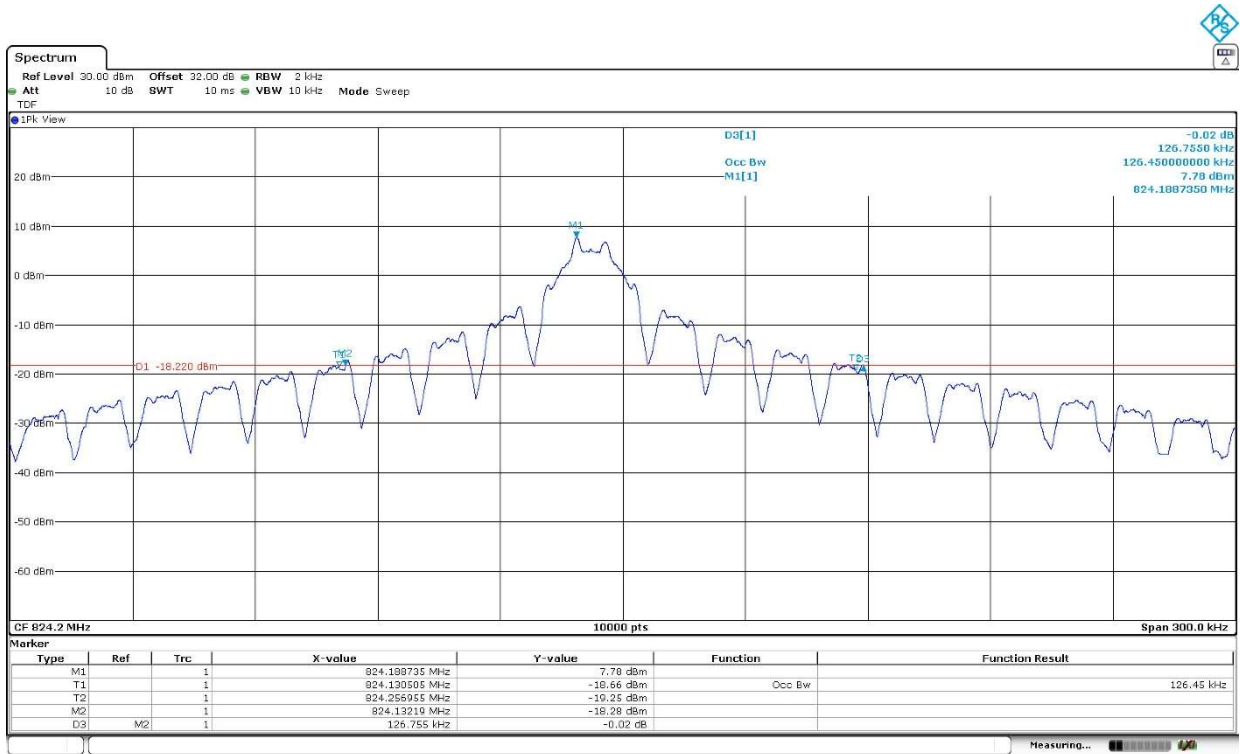

Middle Channel:

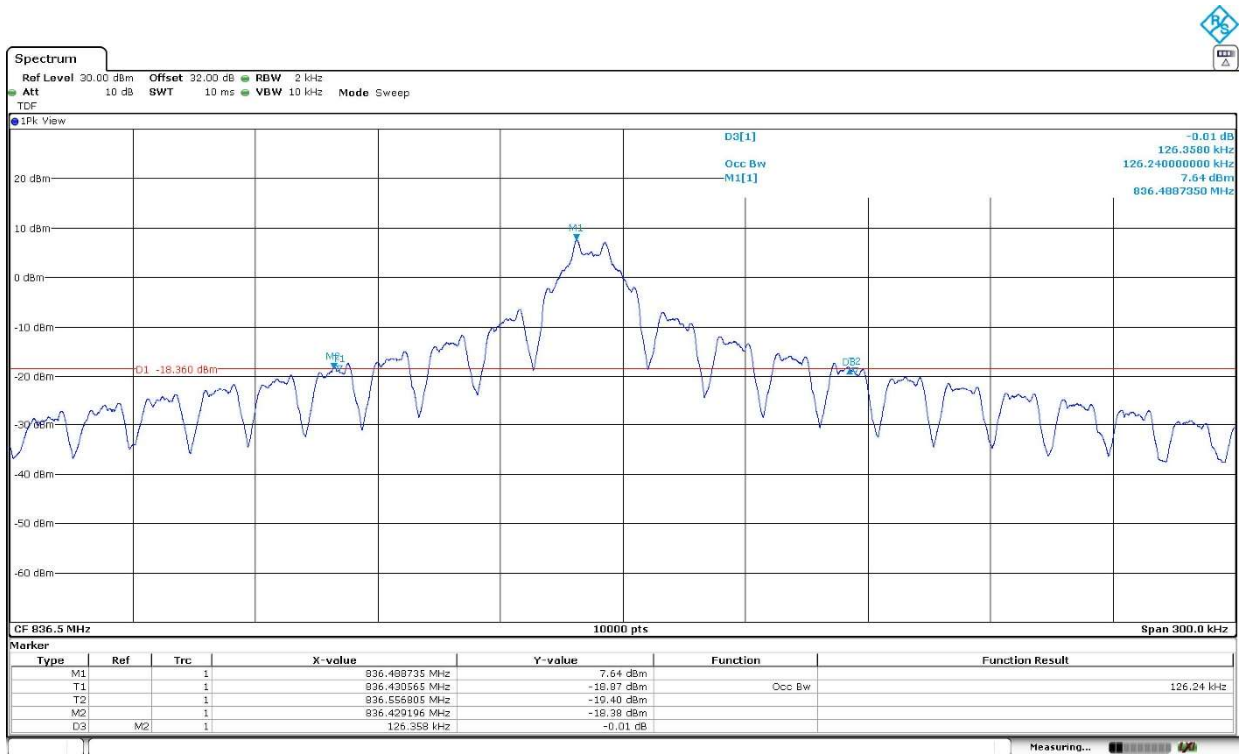

High Channel:

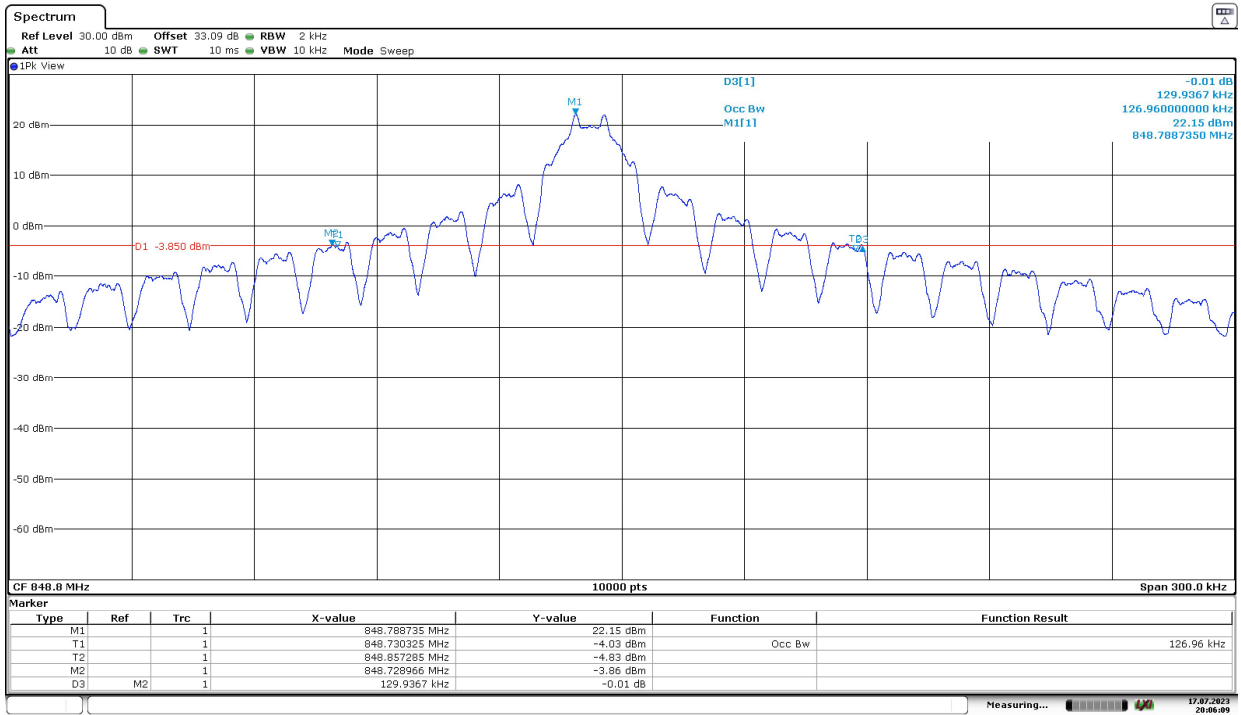

Date: 17.JUL.2023 20:06:10

LTE Cat NB1 Band 26. QPSK. BW=15 kHz. Tone Number=12. Tone Offset=0. MSC/TBS=5.

Low Channel:

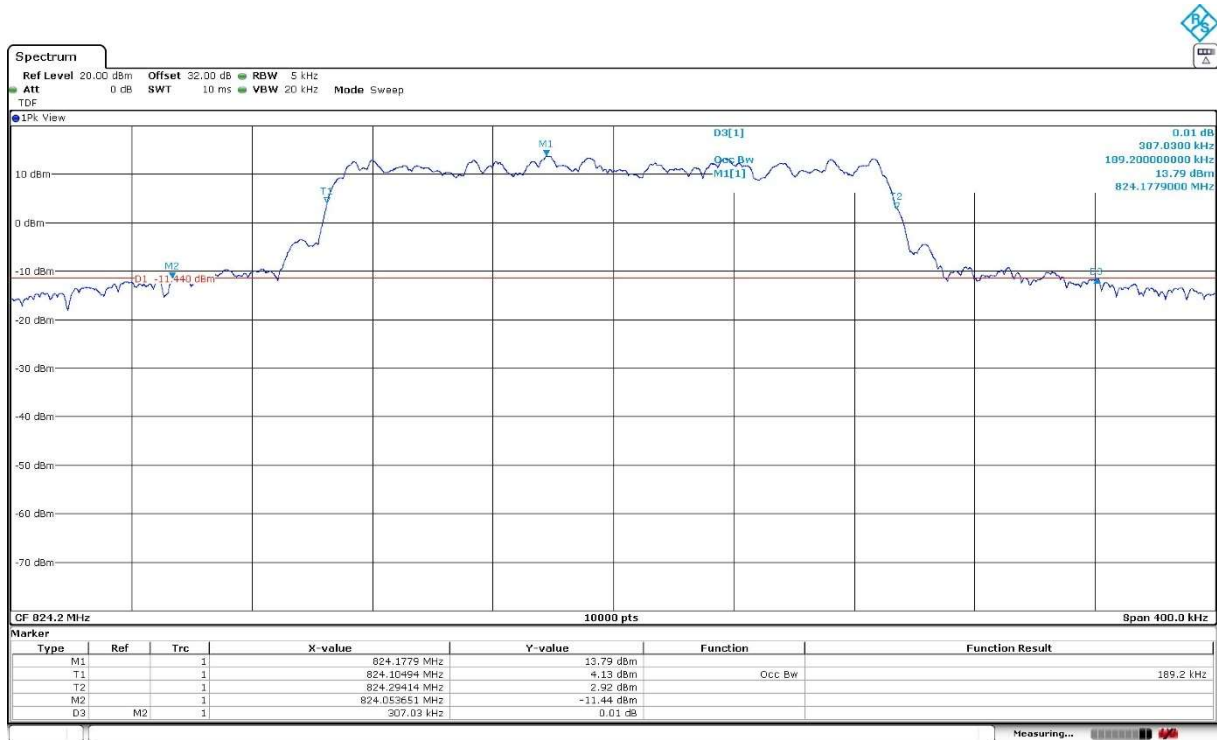

Middle Channel:

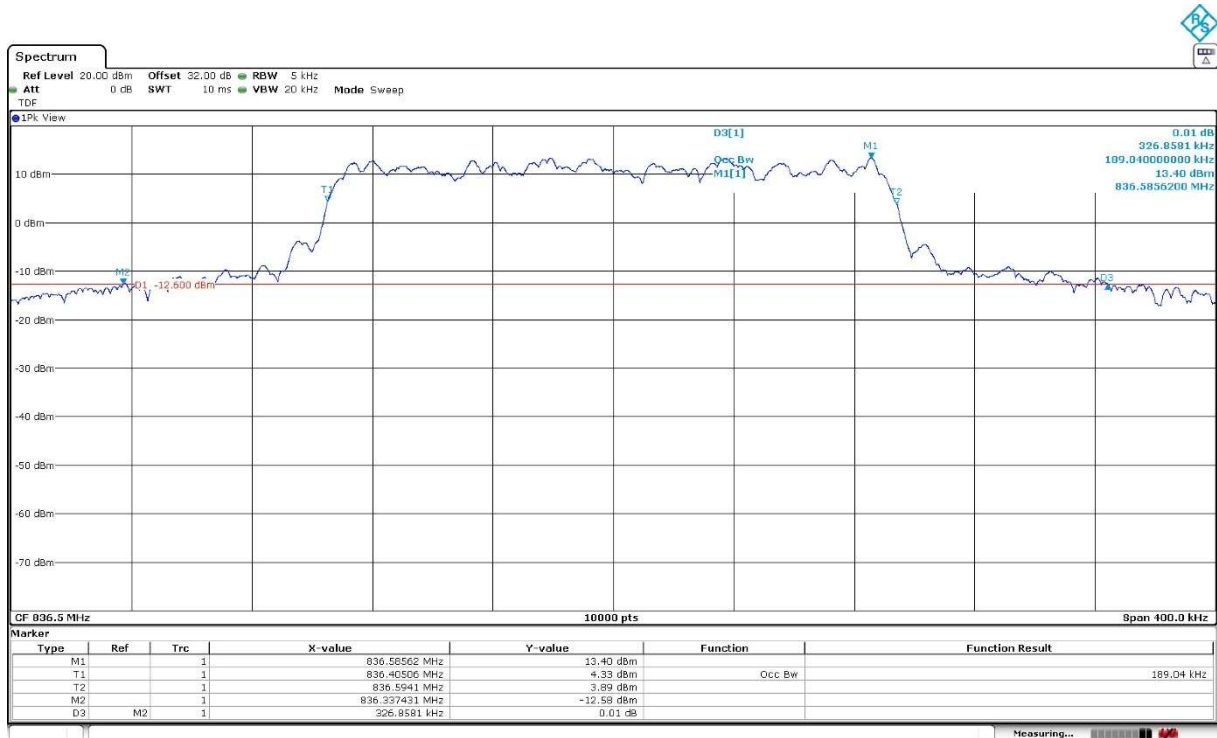

High Channel:

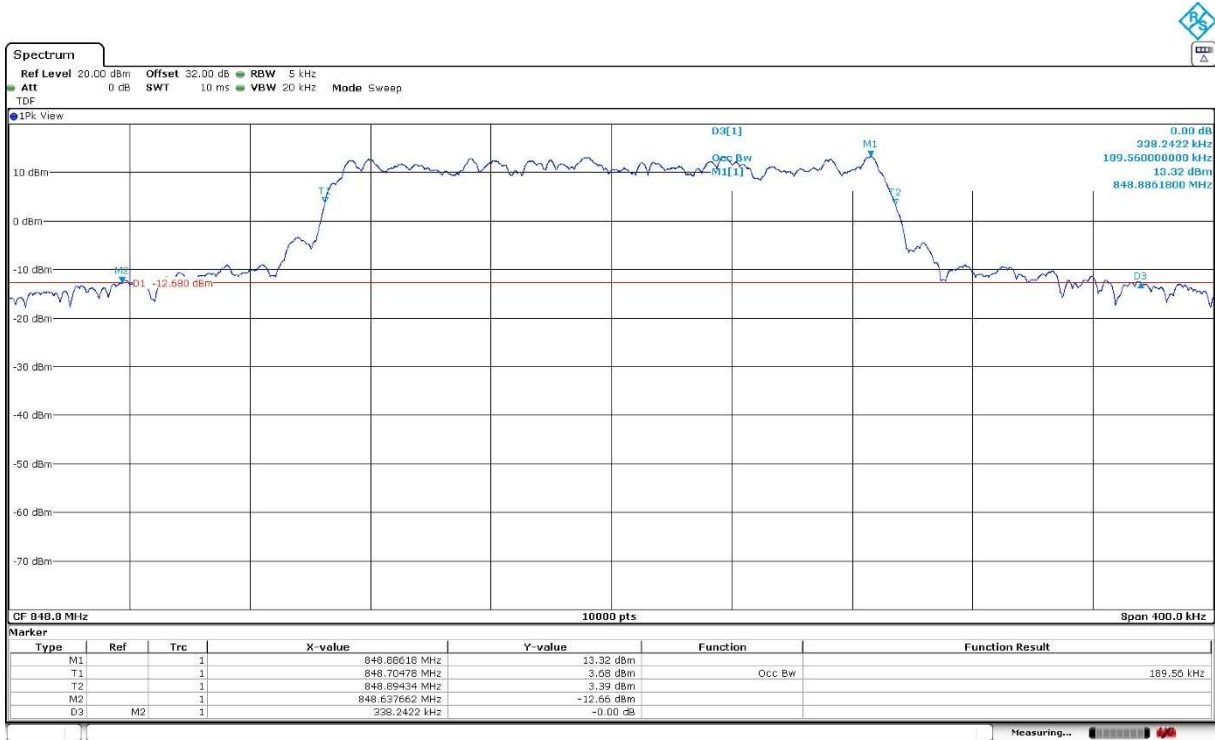

## Spurious Emissions at Antenna Terminals

### Limits

FCC §2.1051 and §22.917. RSS-132 Clause 5.5.

The power of emissions shall be attenuated below the transmitter power (P) by a factor of at least  $43 + 10 \log(P)$  dB. P in watts.

In the spectrum below 1 GHz, instrumentation should employ a reference bandwidth of 100 kHz or greater. In the spectrum above 1 GHz, instrumentation should employ a reference bandwidth of 1 MHz.

At  $P_o$  transmitting power, the specified minimum attenuation becomes  $43 + 10 \log(P_o)$ , and the level in dBm relative to  $P_o$  becomes:

$$P_o \text{ (dBm)} - [43 + 10 \log(P_o \text{ in mW}) - 30] = -13 \text{ dBm}$$

### Method

The EUT RF output connector was connected to a spectrum analyser and to the Universal Radio Communication tester R&S CMW500 (selecting maximum transmission power of the EUT and different modes of modulation) using a 50-Ohm attenuator and a power divider.

The spectrum was investigated from 9 kHz to 8.5 GHz.

The reading of the spectrum analyser is corrected with the attenuation loss of connection between output terminal of EUT and input of the spectrum analyser.

The configuration of Resource Blocks and modulation which is the worst case for conducted power was used.

### Test Setup

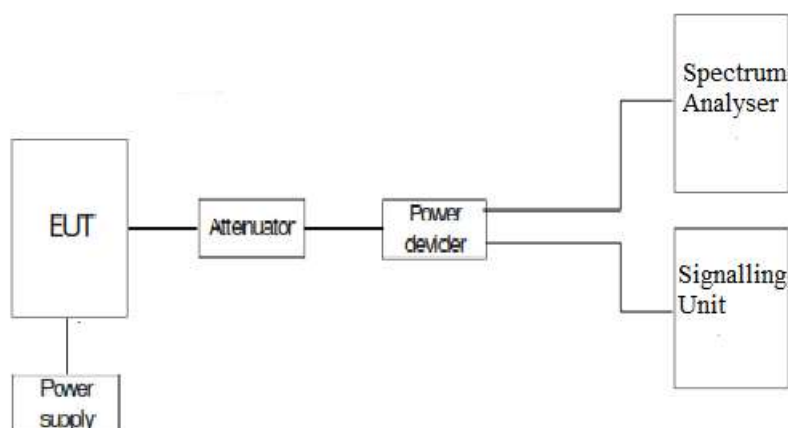

## Results

### LTE Cat NB1 Band 26:

A preliminary scan determined the worst-case:

PI/2-BPSK. BW=3.75 kHz. Tone Number=1. Tone Offset=0. MSC/TBS=0.

The next results are for this worst-case configuration,

#### **Frequency range 9 KHz - 10 GHz:**

- Low Channel: No spurious frequencies at less than 20 dB below the limit.
- Middle Channel: No spurious frequencies at less than 20 dB below the limit.
- High Channel: No spurious frequencies at less than 20 dB below the limit.

Measurement uncertainty (dB):  $<\pm 2.76$

Verdict: PASS

**LTE Cat-NB1 Band 26:Pi/2-BPSK. BW=3.75 kHz. Tone Number=1. Tone Offset=0. MSC/TBS=0.**

Low Channel:

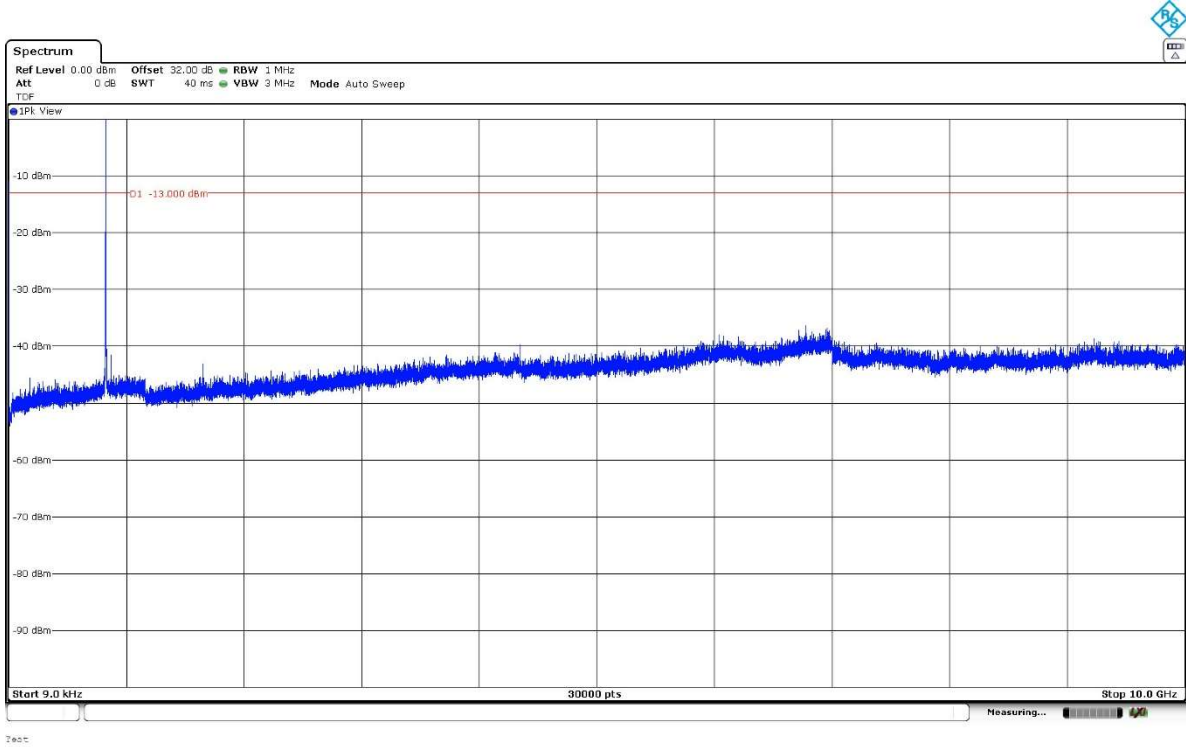

The peak above the limit is the carrier frequency.

Middle Channel:

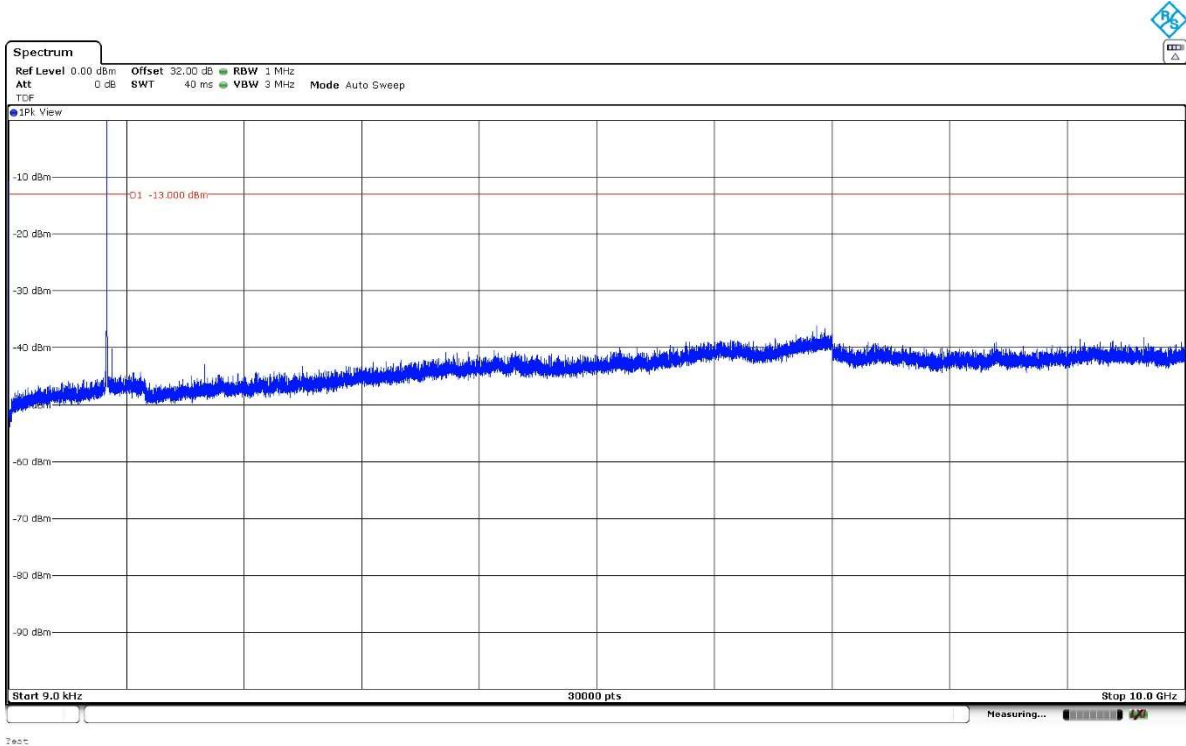

The peak above the limit is the carrier frequency.



High Channel:

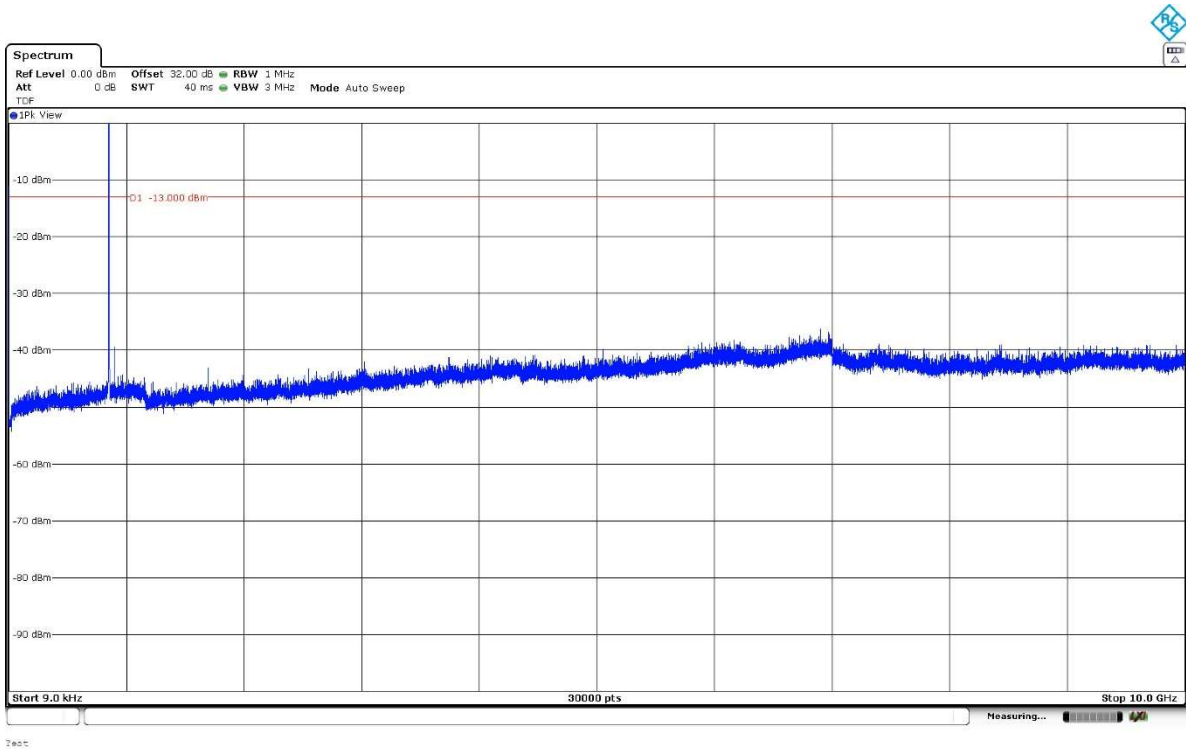

The peak above the limit is the carrier frequency.