

High Channel:

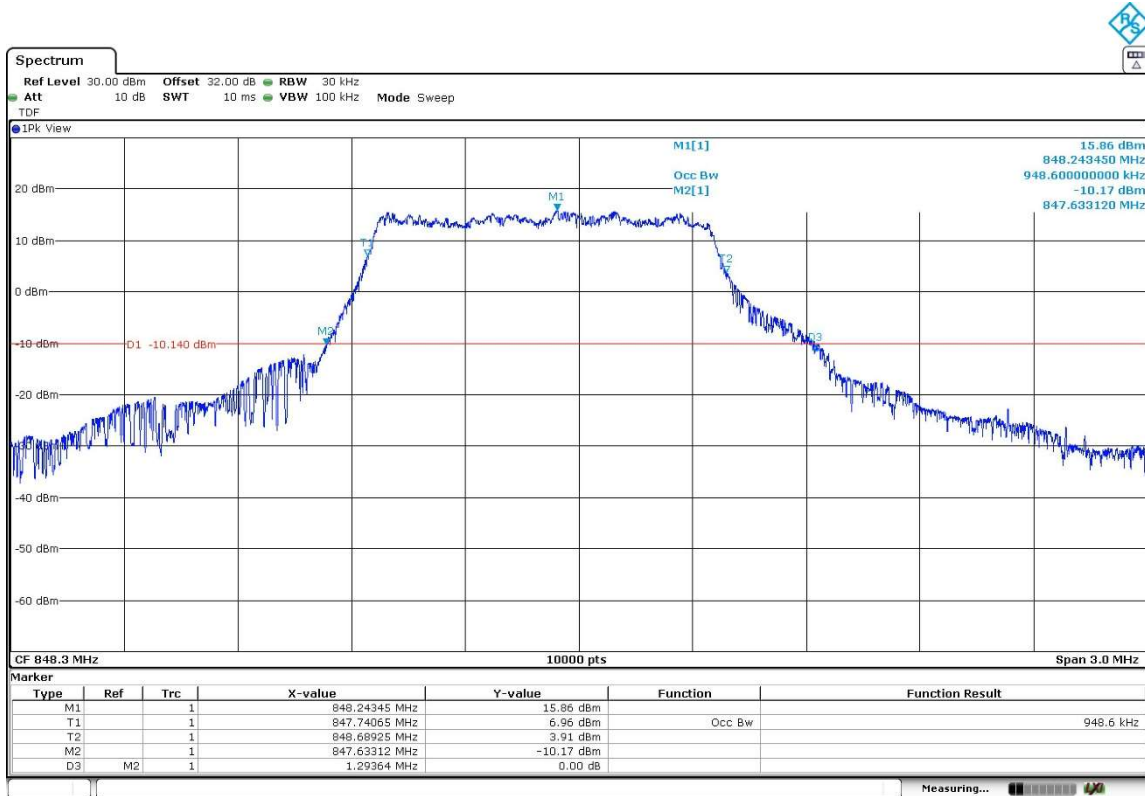

Spurious Emissions at Antenna Terminals

Limits

FCC §2.1051 and §22.917. RSS-132 Clause 5.5.

The power of emissions shall be attenuated below the transmitter power (P) by a factor of at least $43 + 10 \log(P)$ dB. P in watts.

In the spectrum below 1 GHz, instrumentation should employ a reference bandwidth of 100 kHz or greater. In the spectrum above 1 GHz, instrumentation should employ a reference bandwidth of 1 MHz.

At P_o transmitting power, the specified minimum attenuation becomes $43 + 10 \log(P_o)$, and the level in dBm relative to P_o becomes:

$$P_o \text{ (dBm)} - [43 + 10 \log(P_o \text{ in mW}) - 30] = -13 \text{ dBm}$$

Method

The EUT RF output connector was connected to a spectrum analyser and to the Universal Radio Communication tester R&S CMW500 (selecting maximum transmission power of the EUT and different modes of modulation) using a 50-Ohm attenuator and a power divider.

The spectrum was investigated from 9 kHz to 8.5 GHz.

The reading of the spectrum analyser is corrected with the attenuation loss of connection between output terminal of EUT and input of the spectrum analyser.

The configuration of Resource Blocks and modulation which is the worst case for conducted power was used.

Test Setup

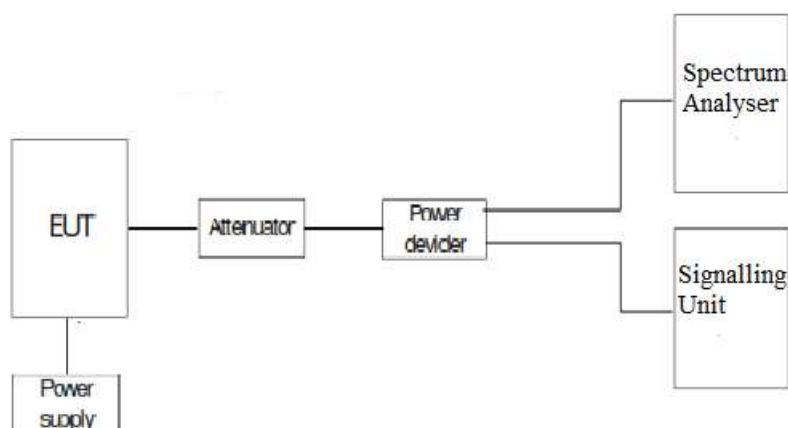

Results

LTE Cat-M1 Band 26:

A preliminary scan determined the worst-case:

BW=15 MHz. 16QAM. RB Size=1. RB Offset=2. Narrow Band=11.

The next results are for this worst-case configuration.

Frequency range 9 KHz - 10 GHz:

- Low Channel: No spurious frequencies at less than 20 dB below the limit.
- Middle Channel: No spurious frequencies at less than 20 dB below the limit.
- High Channel: No spurious frequencies at less than 20 dB below the limit.

Measurement uncertainty (dB): $<\pm 2.76$

Verdict: PASS

LTE Cat-M1 Band 26: BW=15 MHz. 16QAM. RB Size 1. Offset 2. Narrow Band 11.

Low Channel:

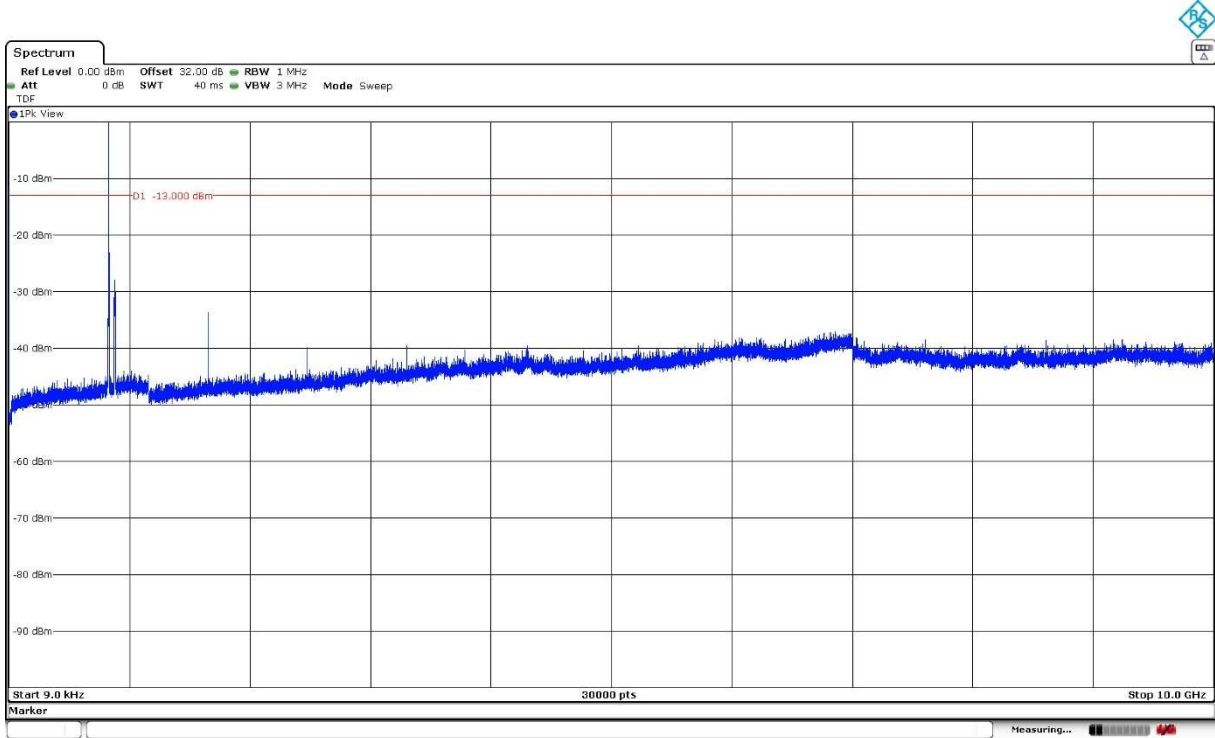

The peak above the limit is the carrier frequency.

Middle Channel:

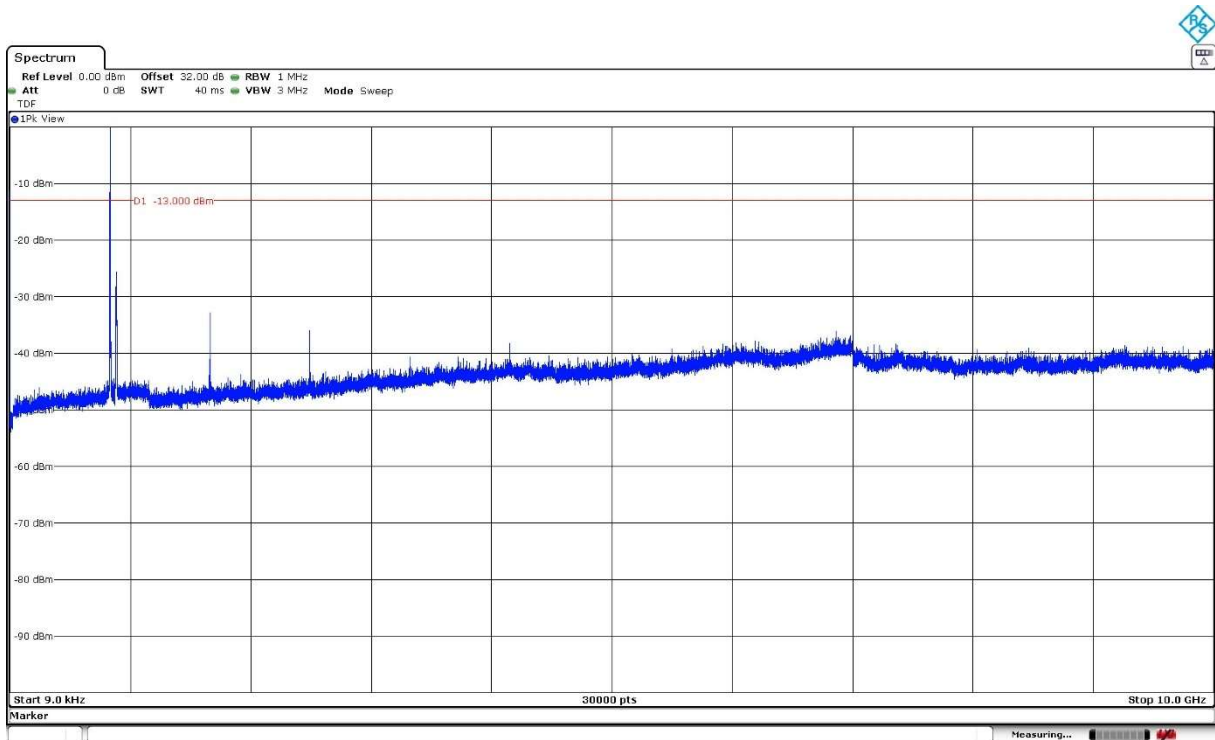

The peak above the limit is the carrier frequency.

High Channel:

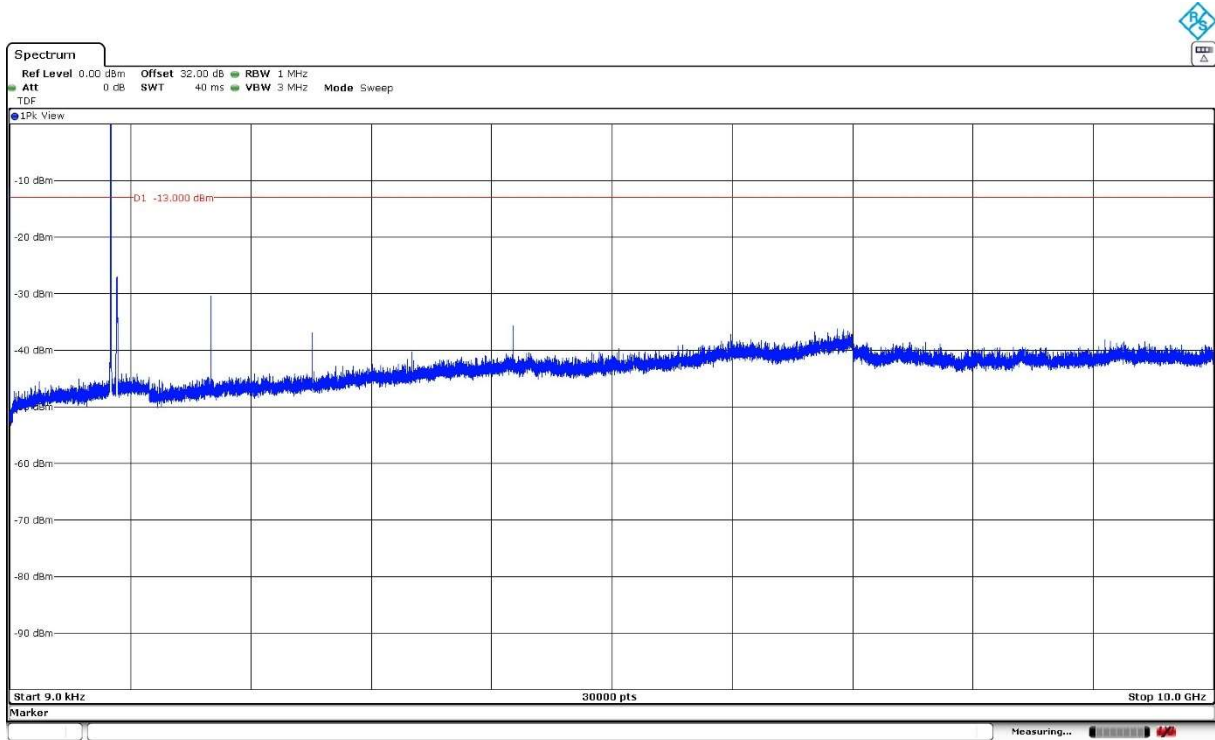

The peak above the limit is the carrier frequency.

Spurious Emissions at Antenna Terminals at Block Edges

Limits

FCC § 2.1051 and § 22.917:

The power of any emission outside of the authorized operating frequency ranges must be attenuated below the transmitting power (P) by a factor of at least $43 + 10 \log(P)$ dB.

Compliance with these rules is based on the use of measurement instrumentation employing a reference bandwidth as follows:

In the spectrum below 1 GHz, instrumentation should employ a reference bandwidth of 100 kHz or greater. In the 1 MHz bands immediately outside and adjacent to the frequency block, a resolution bandwidth of at least one percent of the emission bandwidth of the fundamental emission of the transmitter may be employed.

RSS-132. Clause 5.5:

Mobile and base station equipment shall comply with the limits below.

In the first 1.0 MHz band immediately outside and adjacent to each of the sub-bands, the power of emissions per any 1% of the occupied bandwidth shall be attenuated (in dB) below the transmitter output power P (dBW) by at least $43 + 10 \log 10 p$ (watts).

Method

The EUT RF output connector was connected to a spectrum analyzer and to the Universal Radio Communication tester R&S CMW500 (selecting maximum transmission power of the EUT and different modes of modulation) using a 50-Ohm attenuator and a power splitter.

The reading of the spectrum analyser is corrected with the path loss of the connection between the output terminal of the EUT and the input of the spectrum analyzer.

The configuration of modulation which is the worst case for conducted power was used.

As stated in FCC part 22.917 / RSS-132 Clause 5.5, in the 1 MHz bands immediately outside and adjacent to the frequency block or band a resolution bandwidth of at least one percent of the emission bandwidth of the fundamental emission of the transmitter may be employed.

Measurement Limit:

At P_o transmitting power, the specified minimum attenuation $43 + 10 \log 10 p$ (watts) becomes:

$$P_o \text{ (dBm)} - [43 + 10 \log (P_o \text{ in mwatts}) - 30] = -13 \text{ dBm}$$

Test Setup

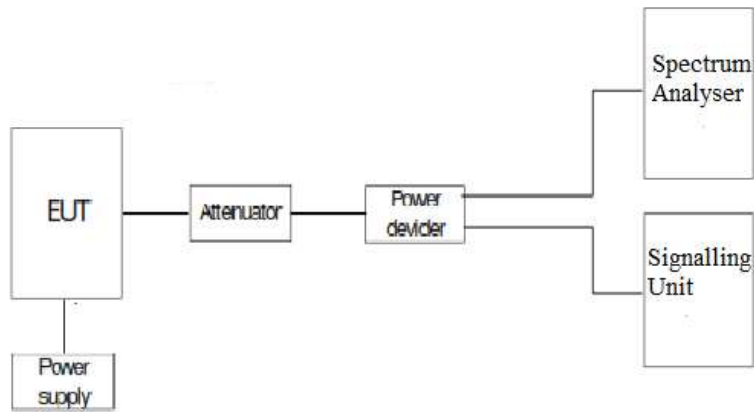

Results

LTE Cat-M1 Band 26:

Preliminary measurements determined 16QAM as the worst case. Results attached are for this worst-case configuration.

LTE Cat-M1 Band 26. 16QAM.	RB=1. Offset=0. BW=1.4 MHz	RB=1. Offset =0. BW = 3 MHz	RB=1. Offset =0. BW=5 MHz	RB=1. Offset =0. BW=10 MHz	RB=1. Offset =0. BW=15 MHz
Maximum measured level at <u>Low Block Edge</u> at antenna port (dBm)	-21.61	-40.36	-33.8	-46.68	-11.37

LTE Cat-M1 Band 26. 16QAM.	RB=5. Offset=0. BW=1.4 MHz	RB=5. Offset=0. BW = 3 MHz	RB=5. Offset=0. BW=5 MHz	RB=5. Offset=0. BW=10 MHz	RB=5. Offset=0. BW=15 MHz
Maximum measured level at <u>Low Block Edge</u> at antenna port (dBm)	-24.47	-33.46	-30.35	-34.81	-33.75

LTE Cat-M1 Band 26. 16QAM.	RB=1. Offset=Max. BW=1.4 MHz	RB=1. Offset =Max. BW = 3 MHz	RB=1. Offset =Max. BW=5 MHz	RB=1. Offset =Max. BW=10 MHz	RB=1. Offset =Max. BW=15 MHz
Maximum measured level at <u>High Block Edge</u> at antenna port (dBm)	-21.64	-22.43	-34.94	-48.94	-48.73

LTE Cat-M1 Band 26. 16QAM.	RB=5. Offset=1. BW=1.4 MHz	RB=5. Offset=1. BW = 3 MHz	RB=5. Offset=1. BW=5 MHz	RB=5. Offset=1. BW=10 MHz	RB=5. Offset=1. BW=15 MHz
Maximum measured level at <u>High Block Edge</u> at antenna port (dBm)	-27.61	-33.92	-29.32	-34.46	-33.02

Measurement uncertainty (dB): ± 2.76

Verdict

Pass

LTE Cat-M1 Band 26. BW=1.4 MHz. 16QAM. RB Size=1. RB Offset=0. Low Block Edge:

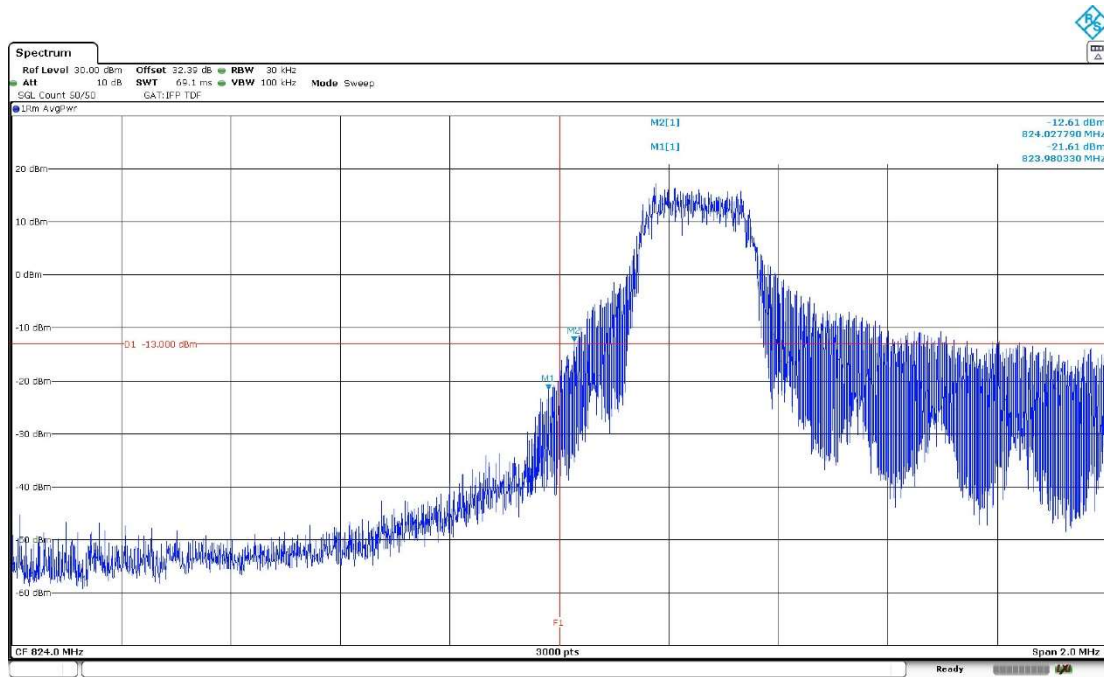

The equipment transmits at the maximum output power.

LTE Cat-M1 Band 26. BW=1.4 MHz. 16QAM. RB Size=1. RB Offset=Max. High Block Edge:

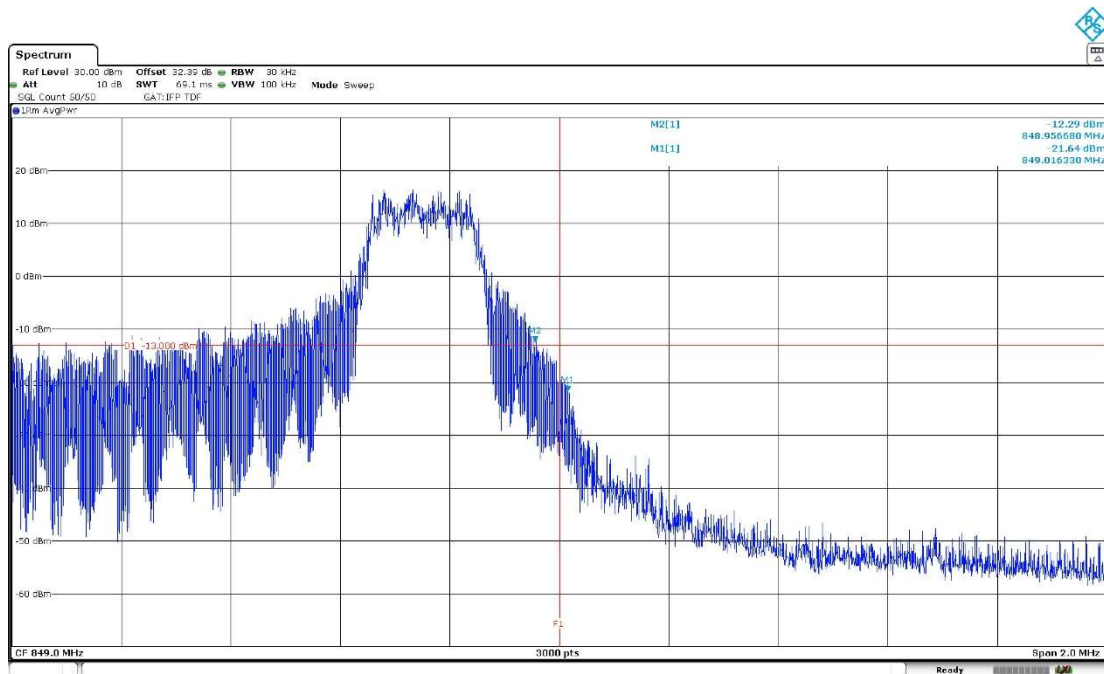

The equipment transmits at the maximum output power.

LTE Cat-M1 Band 26. BW=1.4 MHz. 16QAM. RB Size=5. RB Offset=0. Low Block Edge:

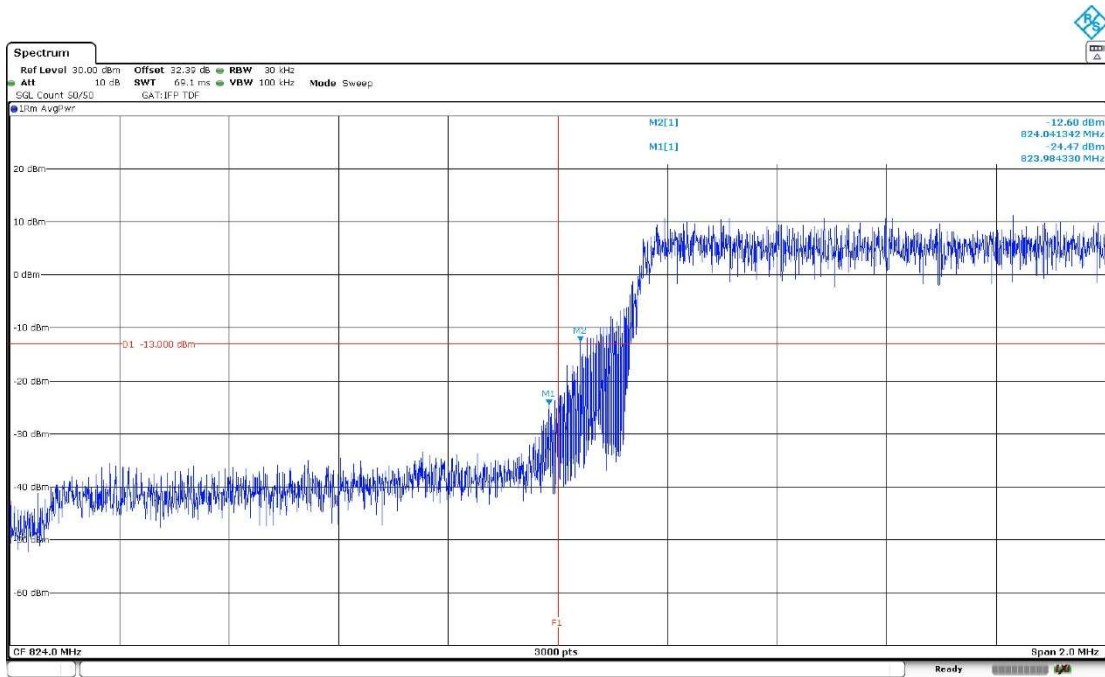

The equipment transmits at the maximum output power.

LTE Cat-M1 Band 26. BW=1.4 MHz. 16QAM. RB Size=5. RB Offset=0. High Block Edge:

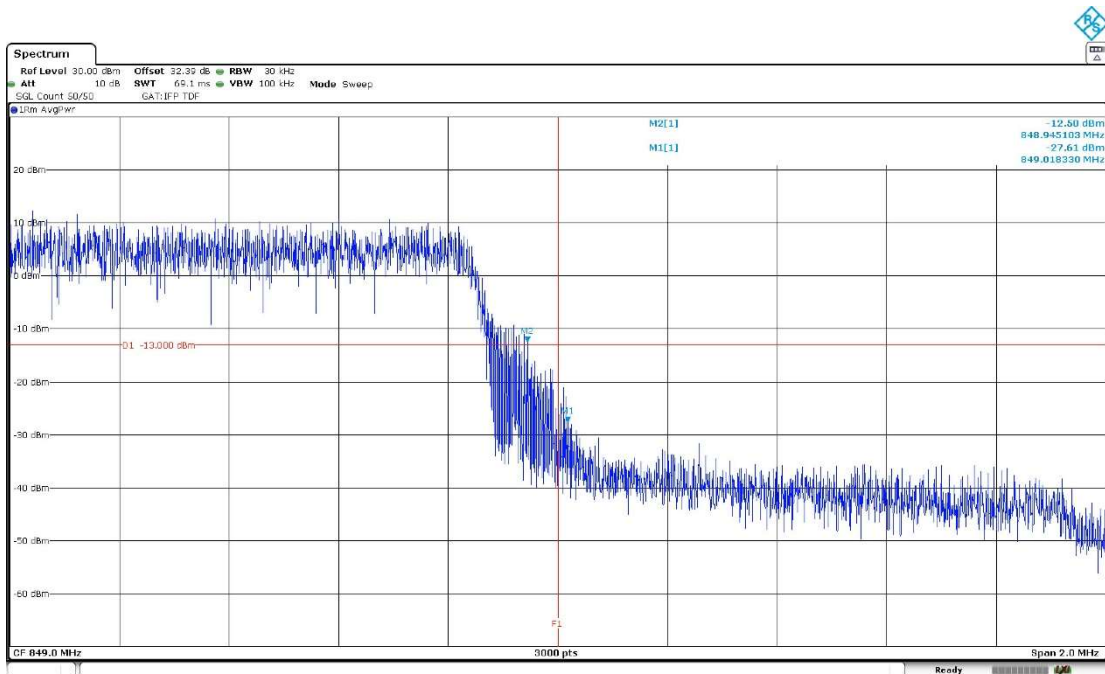

The equipment transmits at the maximum output power.

Verdict: PASS

LTE Cat-M1 Band 26. BW=3 MHz. 16QAM. RB Size= 1. RB Offset = 0. Low Block Edge:

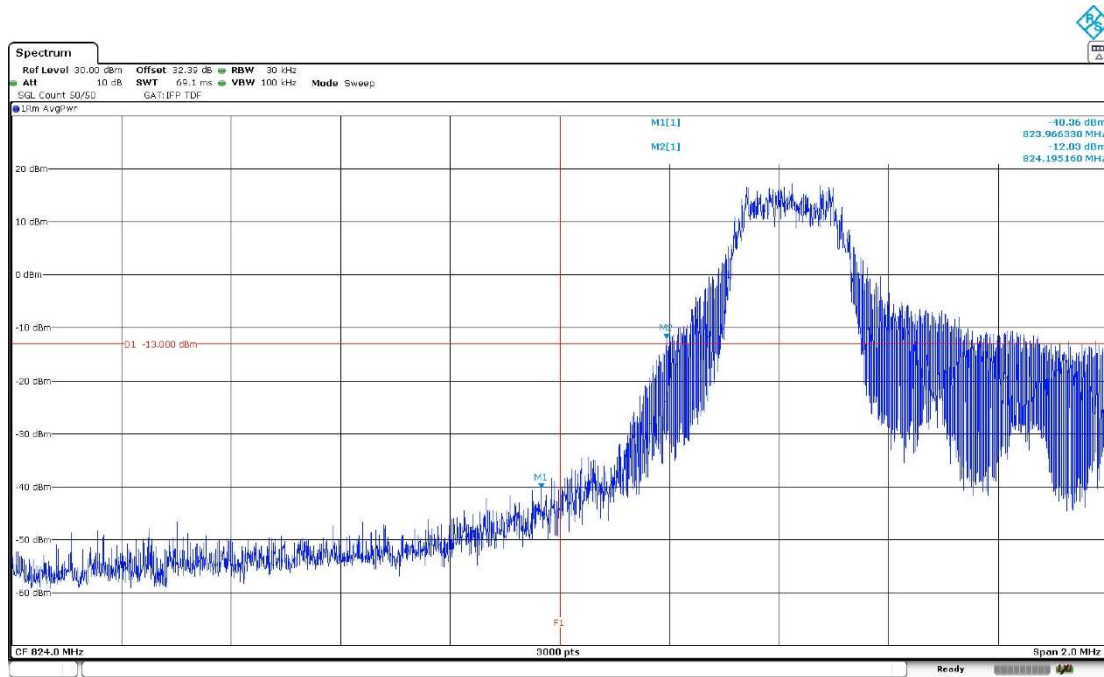

The equipment transmits at the maximum output power.

LTE Cat-M1 Band 26. BW=3 MHz. 16QAM. RB Size=1. RB Offset=Max. High Block Edge:

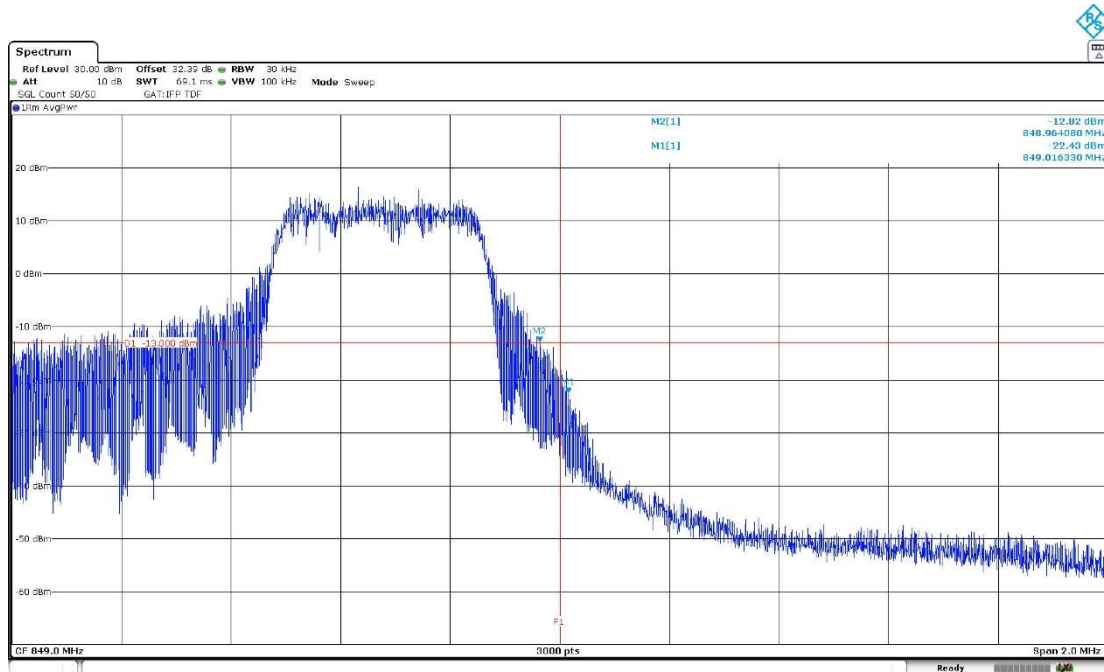

The equipment transmits at the maximum output power.

LTE Cat-M1 Band 26. BW=3 MHz. 16QAM. RB Size=5. RB Offset=0. Low Block Edge:

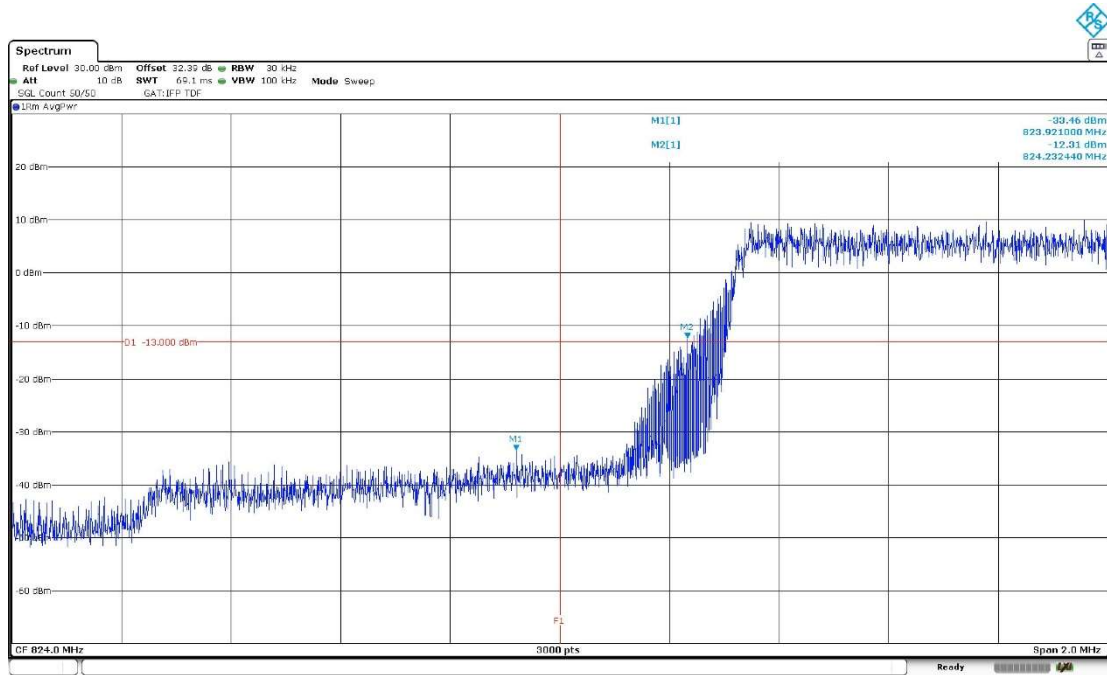

The equipment transmits at the maximum output power.

LTE Cat-M1 Band 26. BW=3 MHz. 16QAM. RB Size=5. RB Offset=0. High Block Edge:

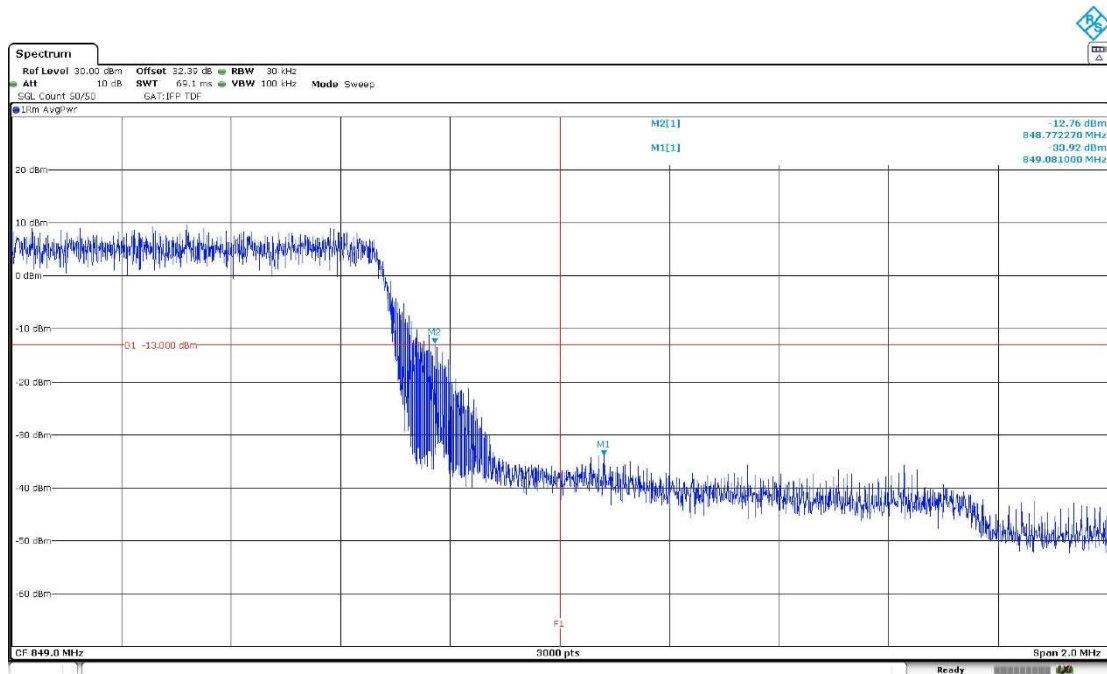

The equipment transmits at the maximum output power.

Verdict: PASS

LTE Cat-M1 Band 26. BW=5 MHz. 16QAM. RB Size=1. RB Offset=0. Low Block Edge:

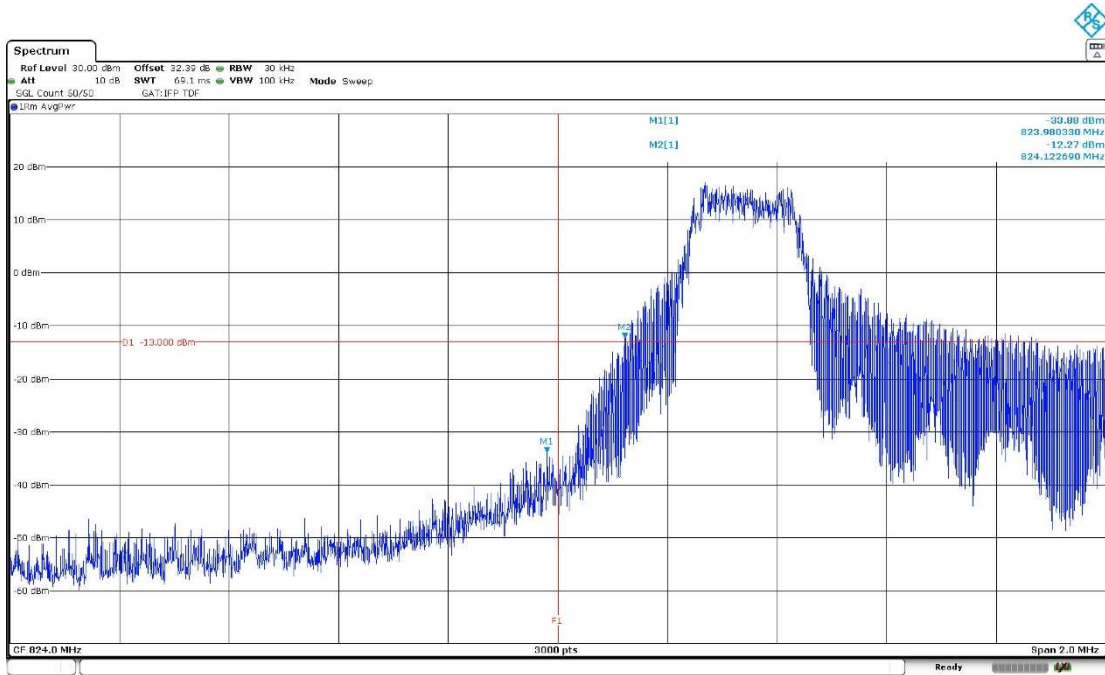

The equipment transmits at the maximum output power.

LTE Cat-M1 Band 26. BW=5 MHz. 16QAM. RB Size=1. RB Offset=Max. High Block Edge:

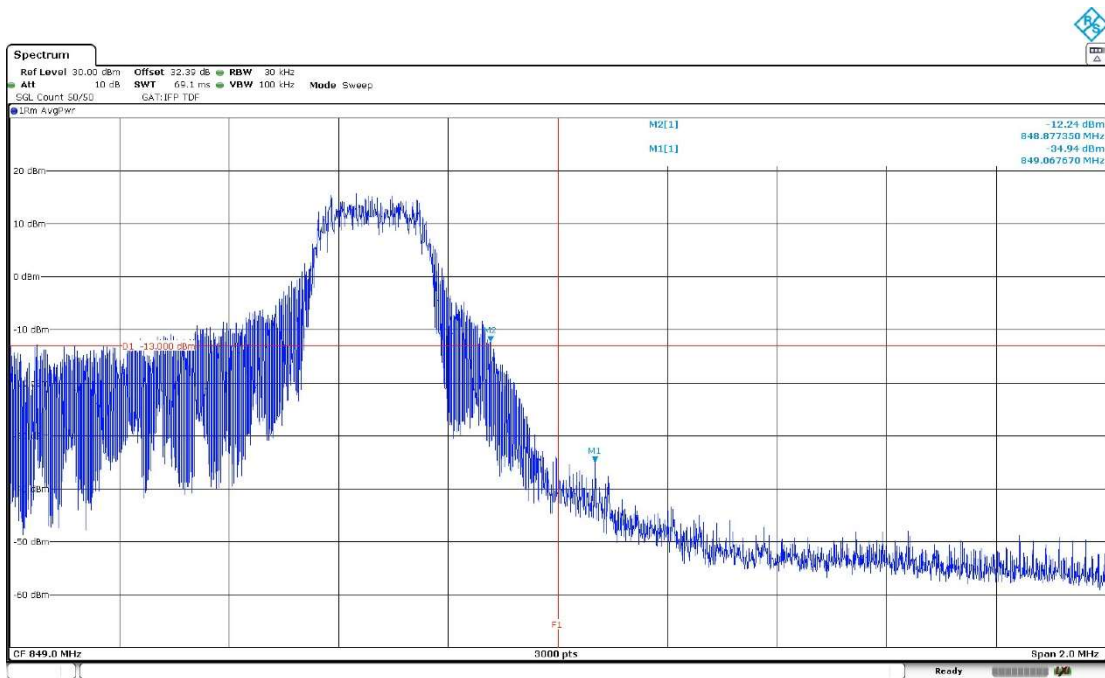

The equipment transmits at the maximum output power.

LTE Cat-M1 Band 26. BW=5 MHz. 16QAM. RB Size=5. RB Offset=0. Low Block Edge:

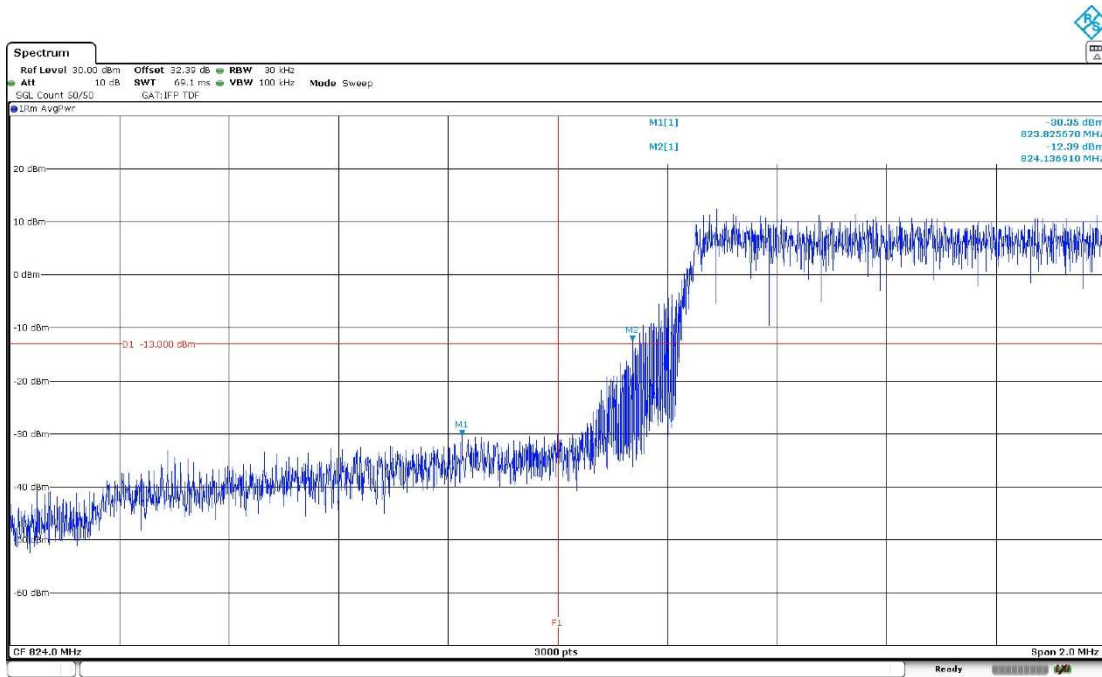

The equipment transmits at the maximum output power.

LTE Cat-M1 Band 26. BW=5 MHz. 16QAM. RB Size=5. RB Offset=0. High Block Edge:

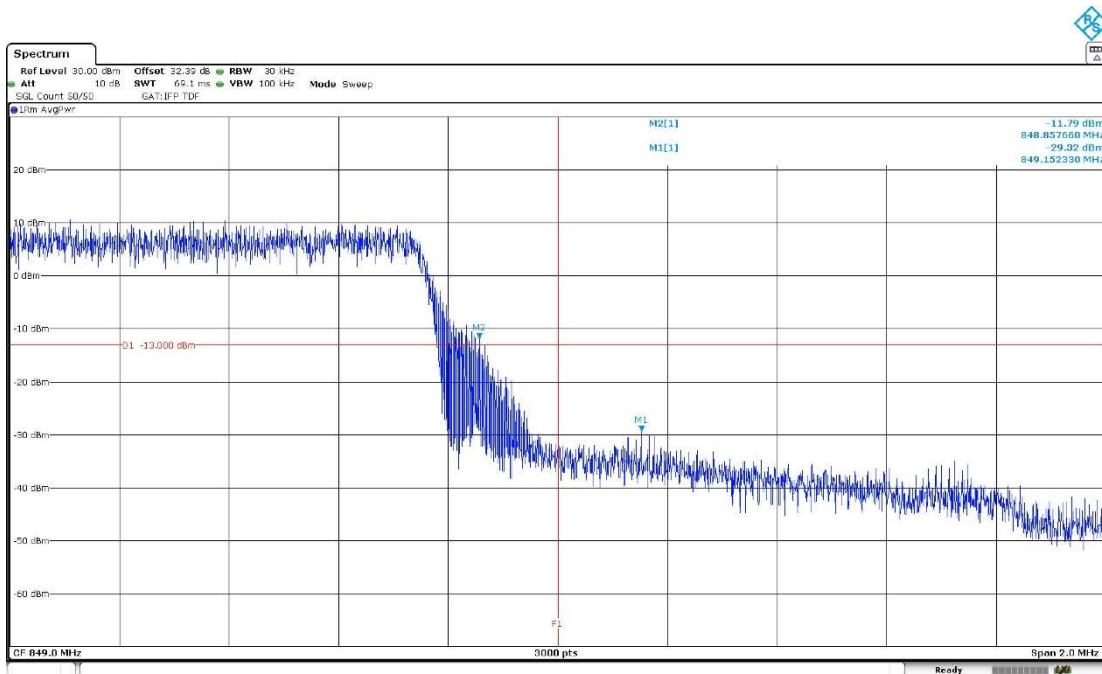

The equipment transmits at the maximum output power.

Verdict: PASS

LTE Cat-M1 Band 26. BW=10 MHz. 16QAM. RB Size=1. RB Offset=0. Low Block Edge:

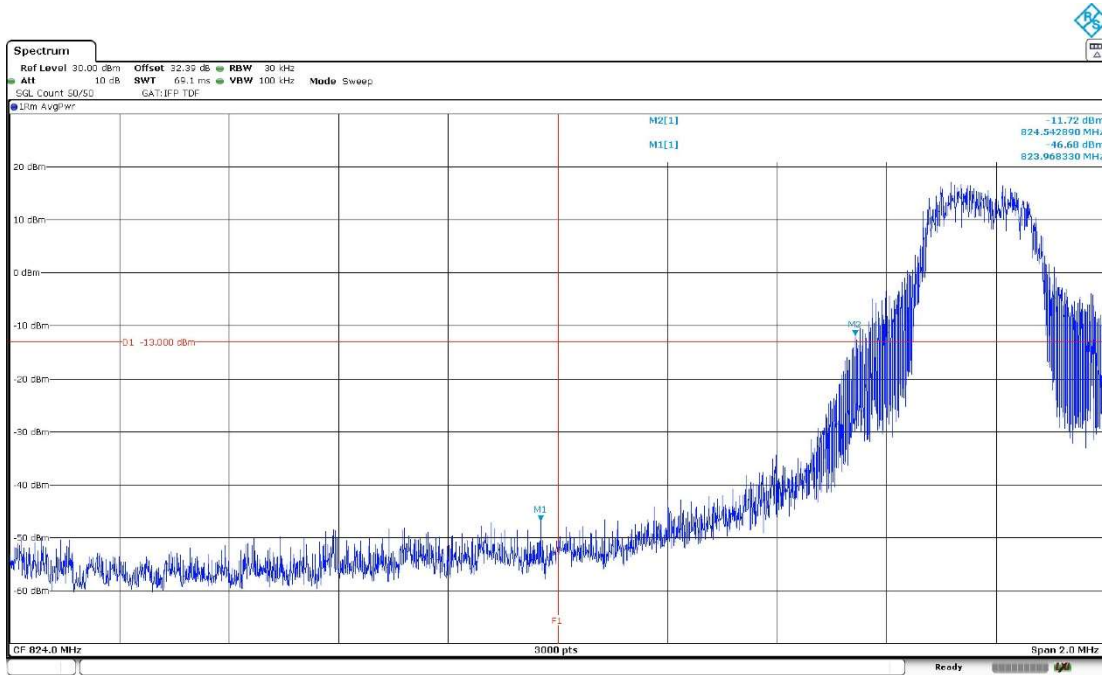

The equipment transmits at the maximum output power.

LTE Cat-M1 Band 26. BW=10 MHz. 16QAM. RB Size=1. RB Offset=Max. High Block Edge:

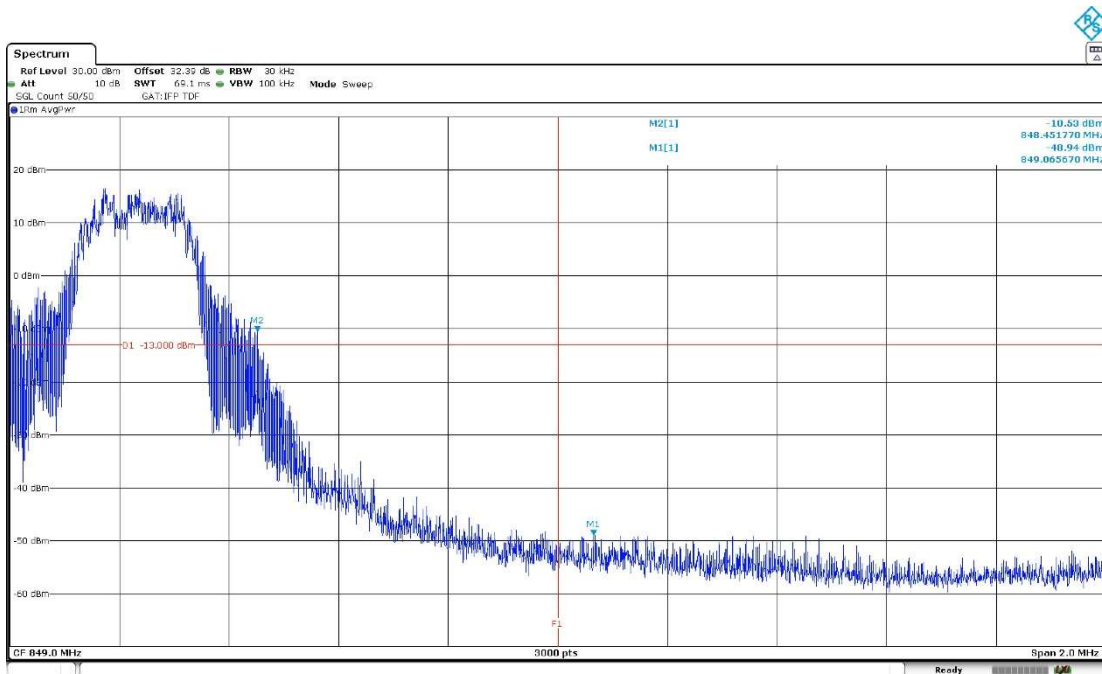

The equipment transmits at the maximum output power.

LTE Cat-M1 Band 26. BW=10 MHz. 16QAM. RB Size=5. RB Offset=0. Low Block Edge:

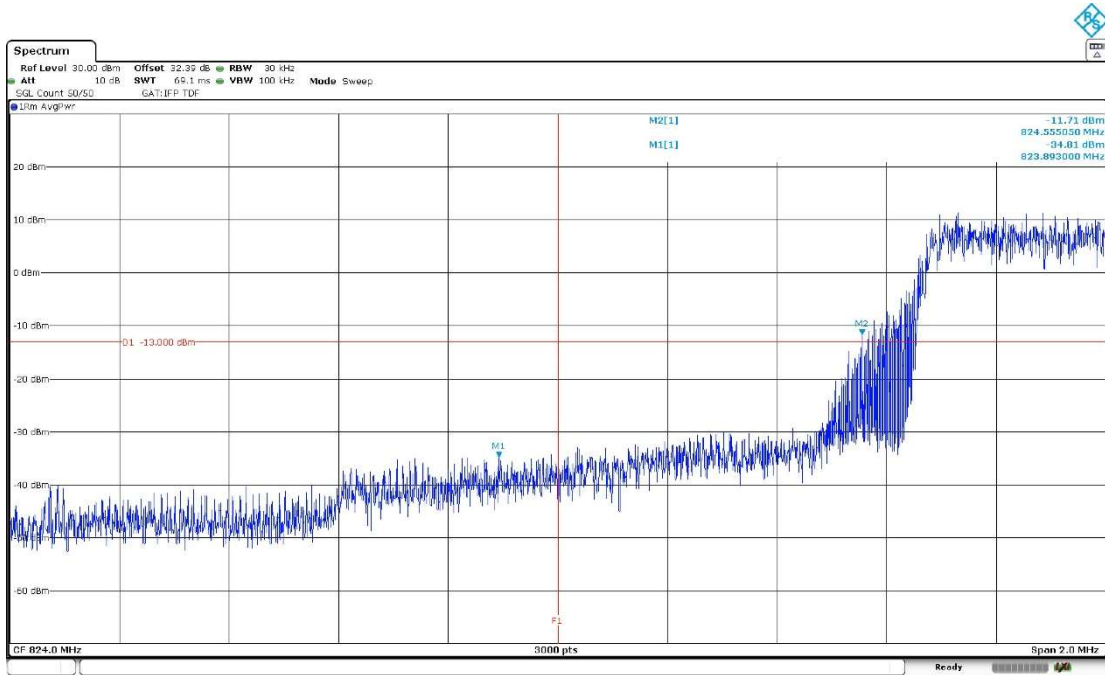

The equipment transmits at the maximum output power.

LTE Cat-M1 Band 26. BW=10 MHz. 16QAM. RB Size=5. RB Offset=0. High Block Edge:

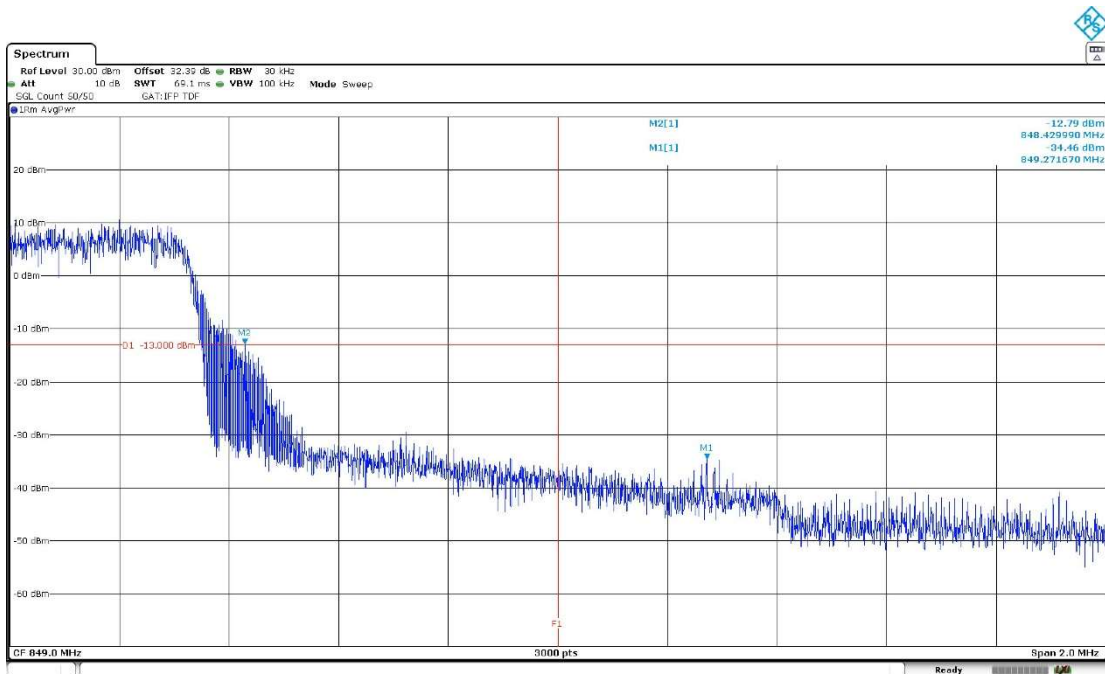

The equipment transmits at the maximum output power.

Verdict: PASS

LTE Cat-M1 Band 26. BW=15 MHz. 16QAM. RB Size=1. RB Offset=0. Low Block Edge:

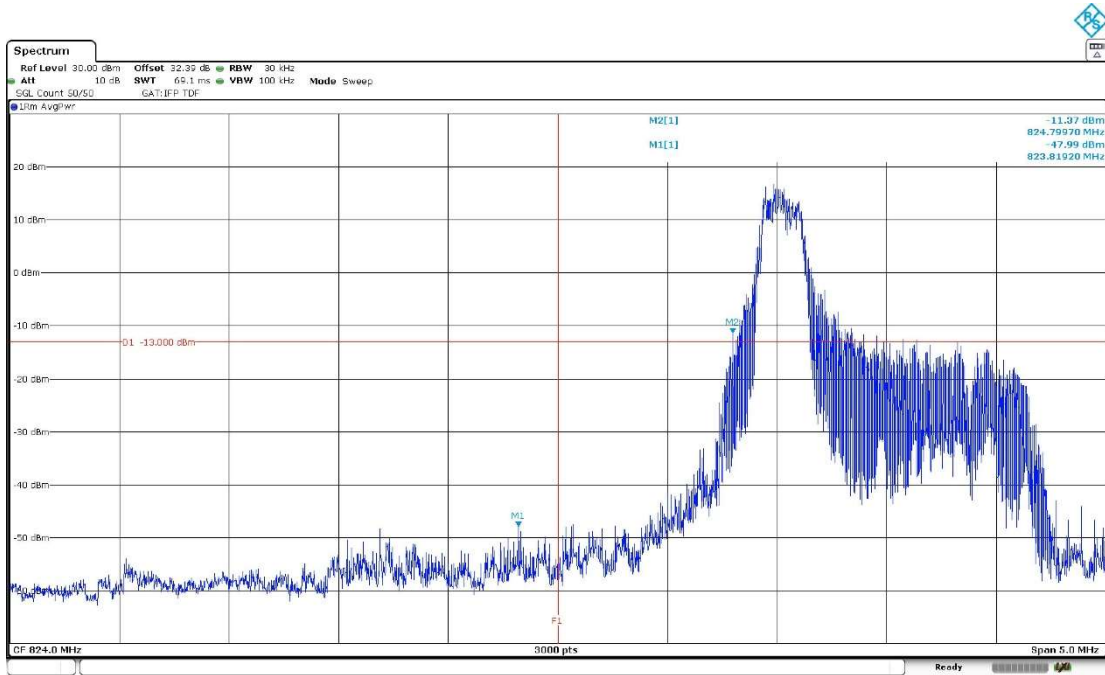

The equipment transmits at the maximum output power.

LTE Cat-M1 Band 26. BW=15 MHz. 16QAM. RB Size=1. RB Offset=Max. High Block Edge:

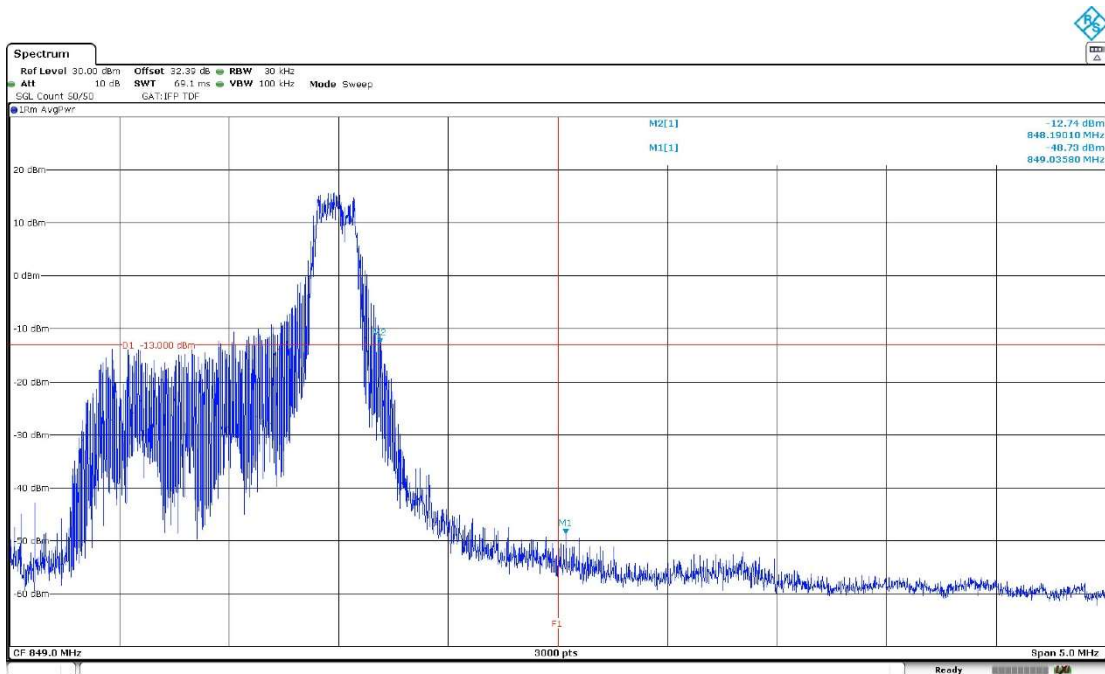

The equipment transmits at the maximum output power.

LTE Cat-M1 Band 26. BW=15 MHz. 16QAM. RB Size=5. RB Offset=0. Low Block Edge:

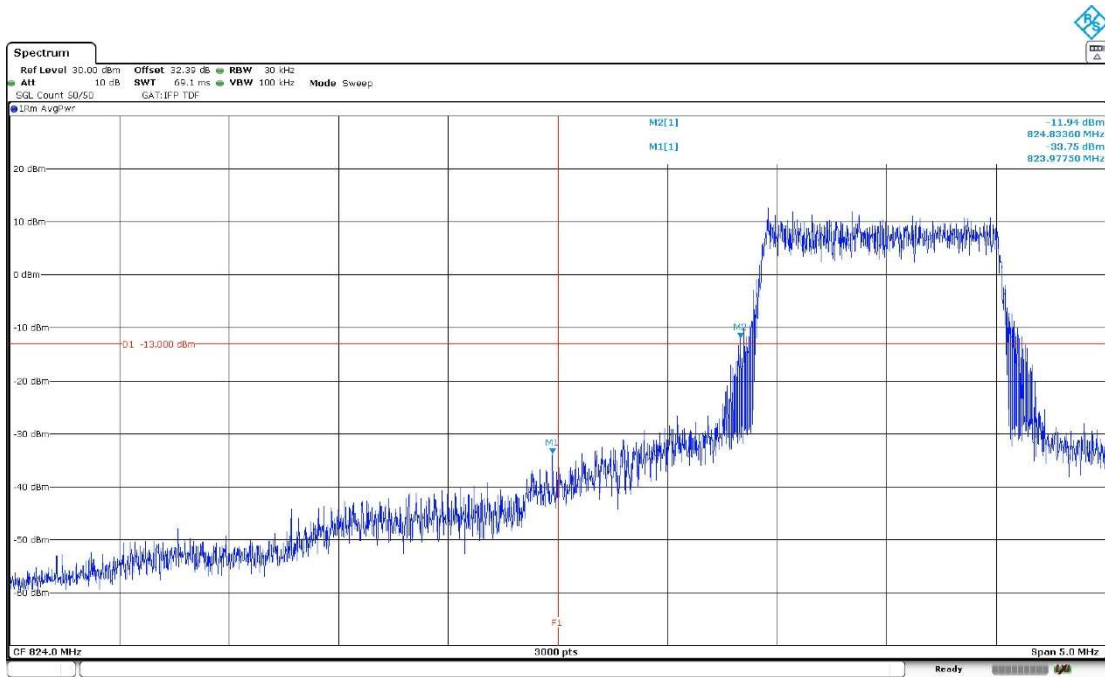

The equipment transmits at the maximum output power.

LTE Cat-M1 Band 26. BW=15 MHz. 16QAM. RB Size=5. RB Offset=0. High Block Edge:

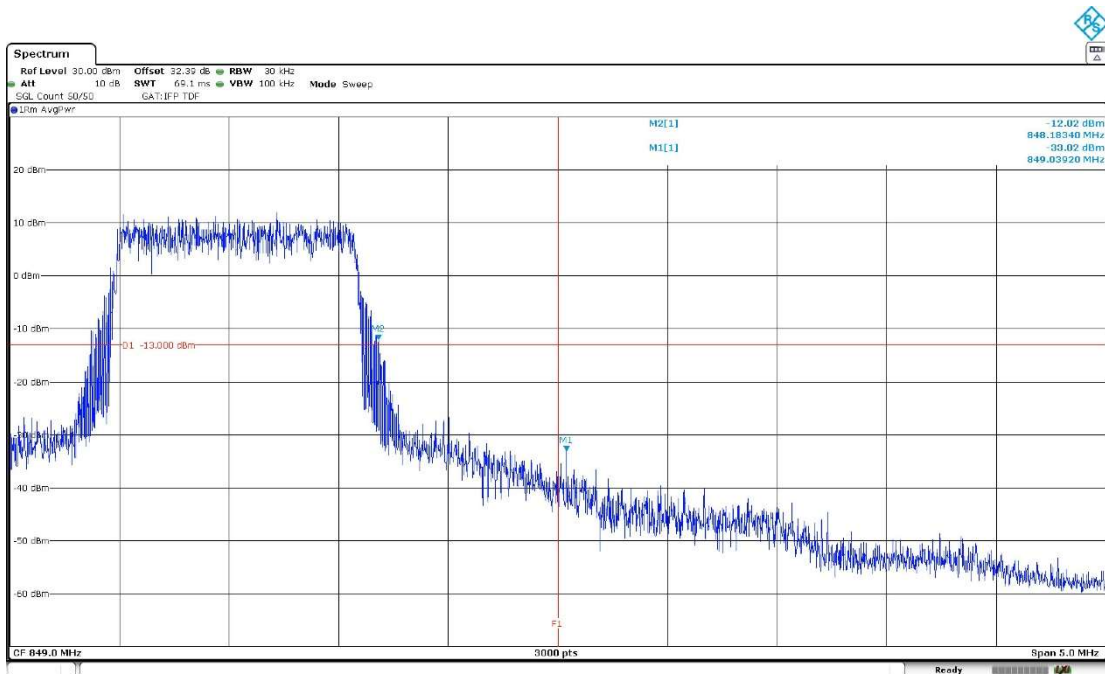

The equipment transmits at the maximum output power.

Verdict: PASS

Radiated Emissions

Limits

* FCC §2.1051 and §22.917: The power of any emission outside of the authorized operating frequency ranges must be attenuated below the transmitting power (P) by a factor of at least $43 + 10 \log(P)$ dB.

- * RSS-132. 5.5: Mobile and base station equipment shall comply with the limits in (i) and (ii) below.
- i. In the first 1.0 MHz band immediately outside and adjacent to each of the sub-bands specified in Section 5.1, the power of emissions per any 1% of the occupied bandwidth shall be attenuated (in dB) below the transmitter output power P (dBW) by at least $43 + 10 \log_{10} P$ (watts).
 - ii. After the first 1.0 MHz immediately outside and adjacent to each of the sub-bands, the power of emissions in any 100 kHz bandwidth shall be attenuated (in dB) below the transmitter output power P (dBW) by at least $43 + 10 \log_{10} P$ (watts). If the measurement is performed using 1% of the occupied bandwidth, power integration over 100 kHz is required.

Method

The measurement was performed with the EUT inside an anechoic chamber. The spectrum was scanned from 30 MHz to at least the 10th harmonic of the HIGH frequency generated within the equipment.

The EUT was placed on a 1 meter high non-conductive stand at a 3 meter distance from the measuring antenna. Detected emissions were maximized at each frequency by rotating the EUT and adjusting the height and polarization of the measuring antenna. The maximum meter reading was recorded.

Measurement Limit:

According to specification, the power of emissions shall be attenuated below the transmitter power (P) by a factor of at least $43 + 10 \log (P)$ dB, P in watts.

At P_o transmitting power, the specified minimum attenuation becomes $43+10\log (P_o)$, and the level in dBm relative P_o becomes:

$$P_o \text{ (dBm)} - [43 + 10 \log (P_o \text{ in mwatts}) - 30] = - 13 \text{ dBm}$$

The maximum field strength (dB μ V/m) of each detected emission at less than 20 dB respect to the limit is converted to an equivalent EIRP level (dBm) according to ANSI C63.26 with the formula:

$EIRP \text{ (dBm)} = E \text{ (dB}\mu\text{V/m)} + 20 \log(D) - 104.8$; where D is the measurement distance (in the far field region) in m. D = 3 m

Test Setup

Radiated measurements below 1 GHz:

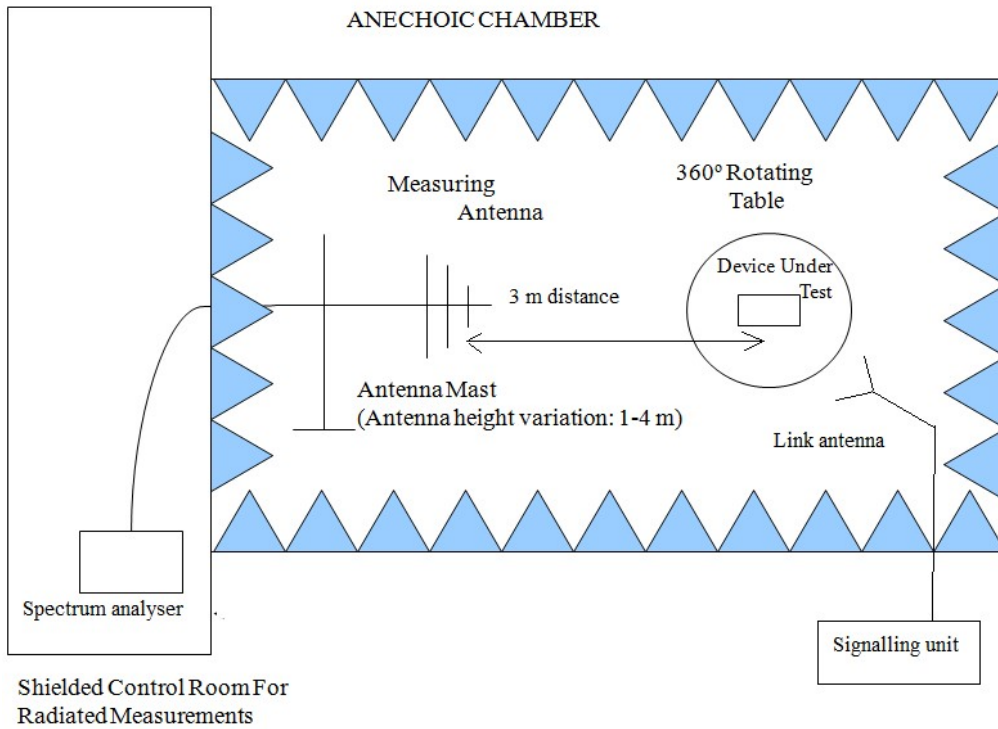

Radiated measurements above 1 GHz:

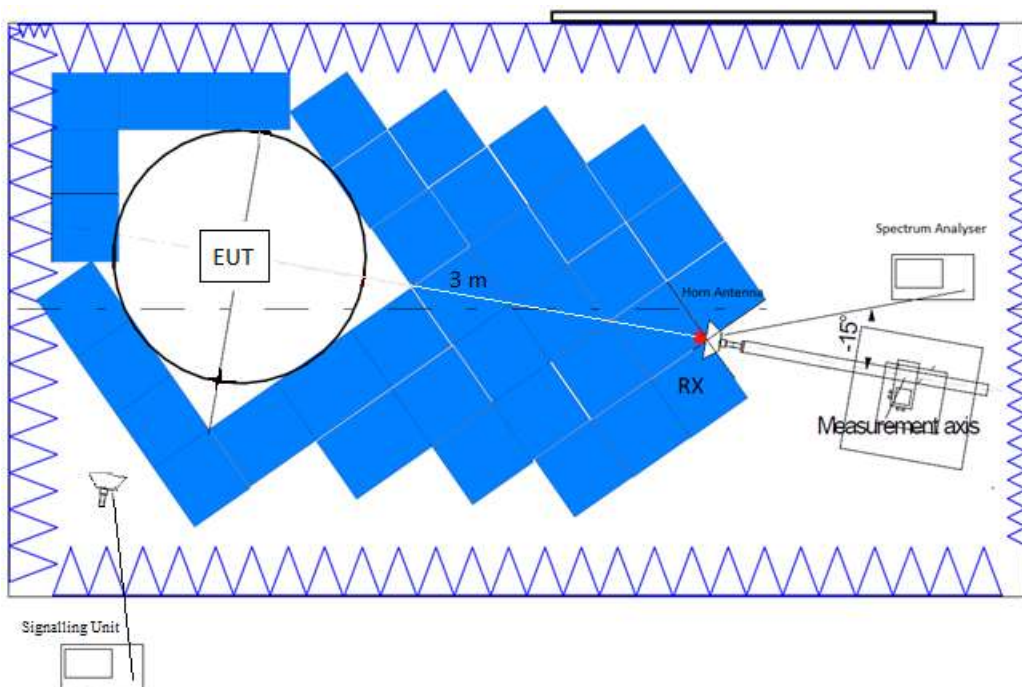

Results

LTE Cat-M1 Band 26:

A preliminary scan determined the BW=15 MHz, 16QAM, RB Size=1, RB Offset=2, Narrow Band=11 as the worst case. The following results are for this worst-case configuration.

- LOW CHANNEL:

Frequency range 30 MHz - 1 GHz:

No spurious frequencies at less than 20 dB below the limit.

Frequency range 1 - 8.5 GHz:

No spurious frequencies at less than 20 dB below the limit.

- MIDDLE CHANNEL:

Frequency range 30 MHz - 1 GHz:

No spurious frequencies at less than 20 dB below the limit.

Frequency range 1 - 8.5 GHz:

No spurious frequencies at less than 20 dB below the limit.

- HIGH CHANNEL:

Frequency range 30 MHz - 1 GHz:

No spurious frequencies at less than 20 dB below the limit.

Frequency range 1 - 8.5 GHz:

No spurious frequencies at less than 20 dB below the limit.

Measurement uncertainty (dB): $<\pm 5.03$ for $f \geq 30$ MHz up to 1 GHz
 $<\pm 4.32$ for $f \geq 1$ GHz up to 8.5 GHz

Verdict: PASS

Subrange	Step Size	Detectors	Bandwidth	Sweep Time	Preamp
30 MHz - 1 GHz	30.312 kHz	PK+	1 MHz	1 s	0 dB
1 GHz - 8.5 GHz	234.375 kHz	PK+	1 MHz	1 s	0 dB

FREQUENCY RANGE 30 MHz - 1 GHz:

- LOW CHANNEL:

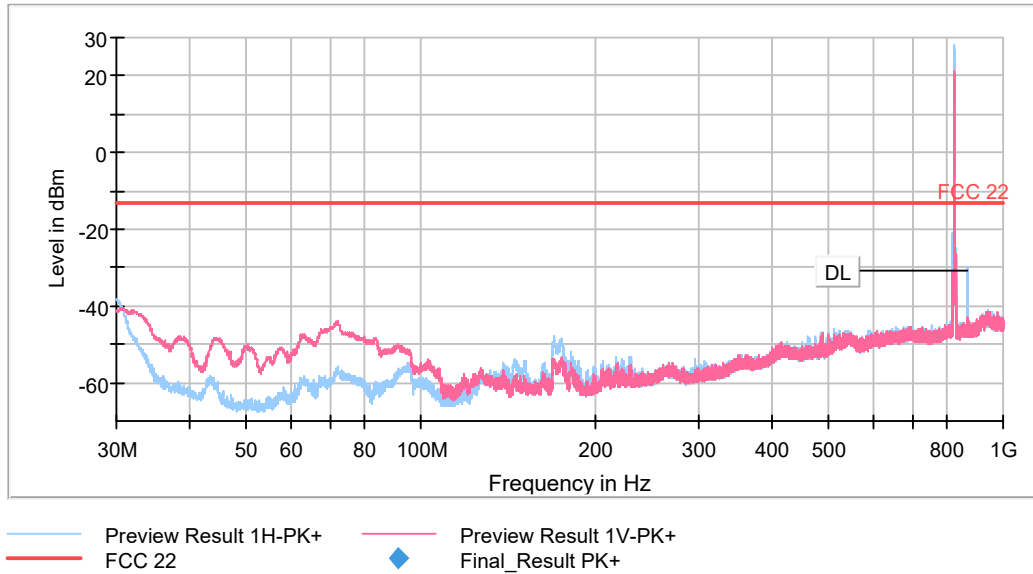

The peak above the limit is the carrier frequency.

- MIDDLE CHANNEL:

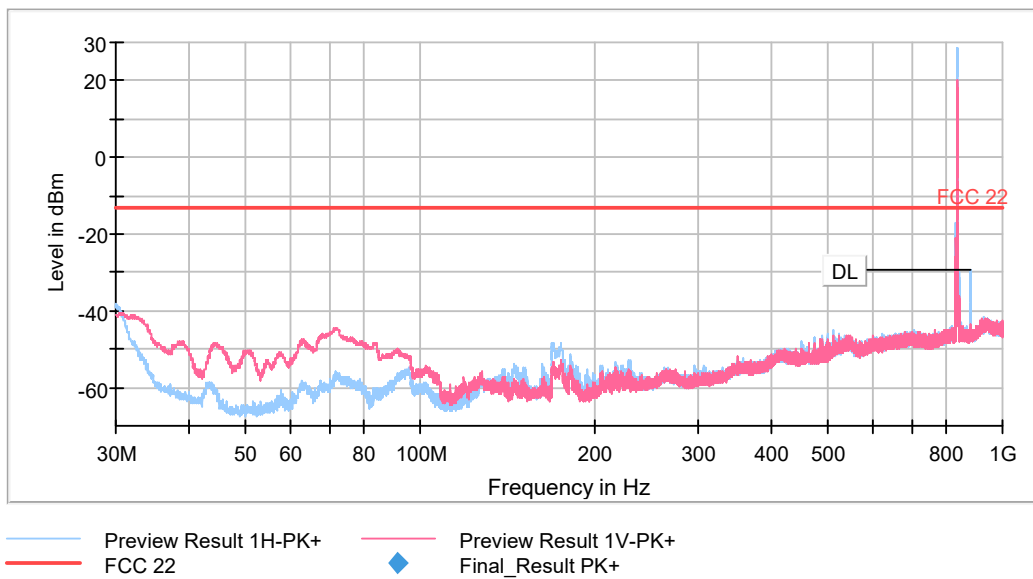

The peak above the limit is the carrier frequency.

- HIGH CHANNEL:

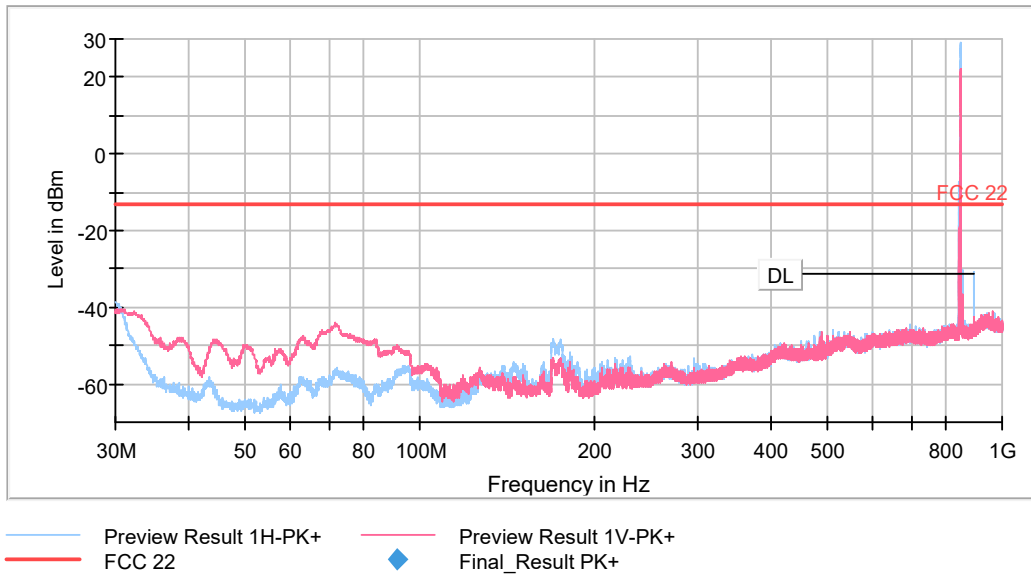

The peak above the limit is the carrier frequency.

FREQUENCY RANGE 1 - 8.5 GHz:

- LOW CHANNEL:

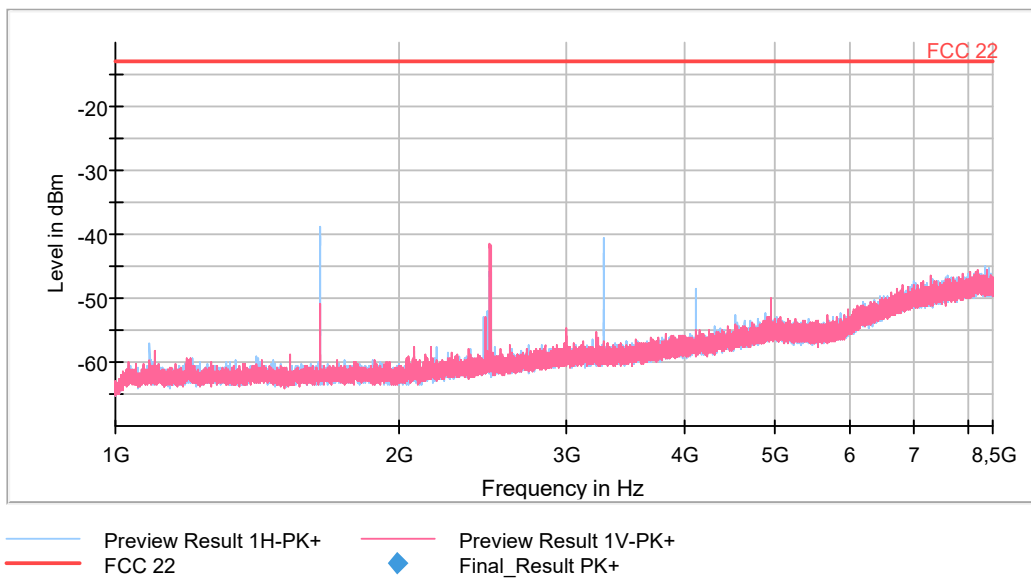

- MIDDLE CHANNEL:

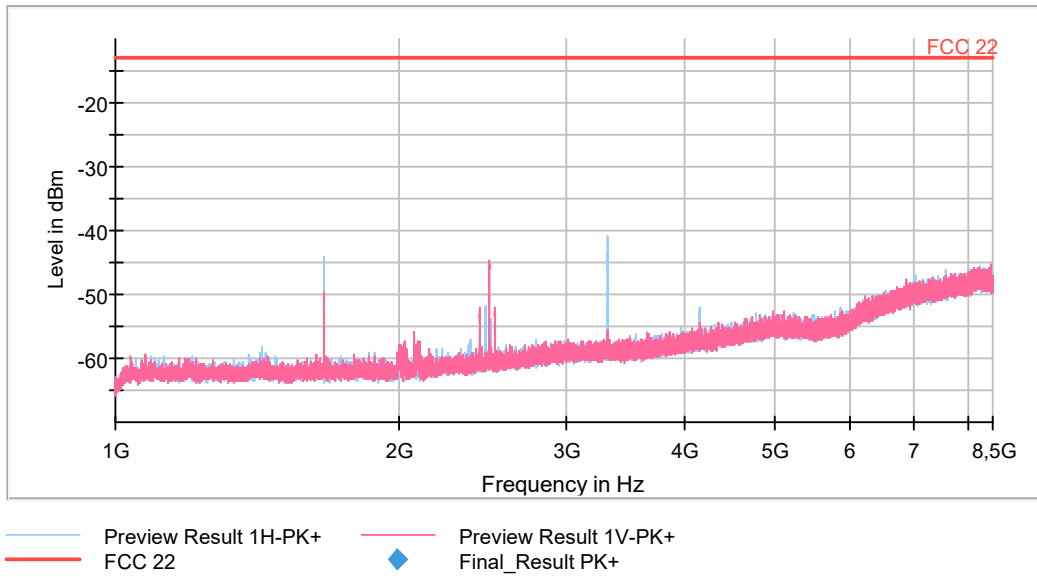

- HIGH CHANNEL:

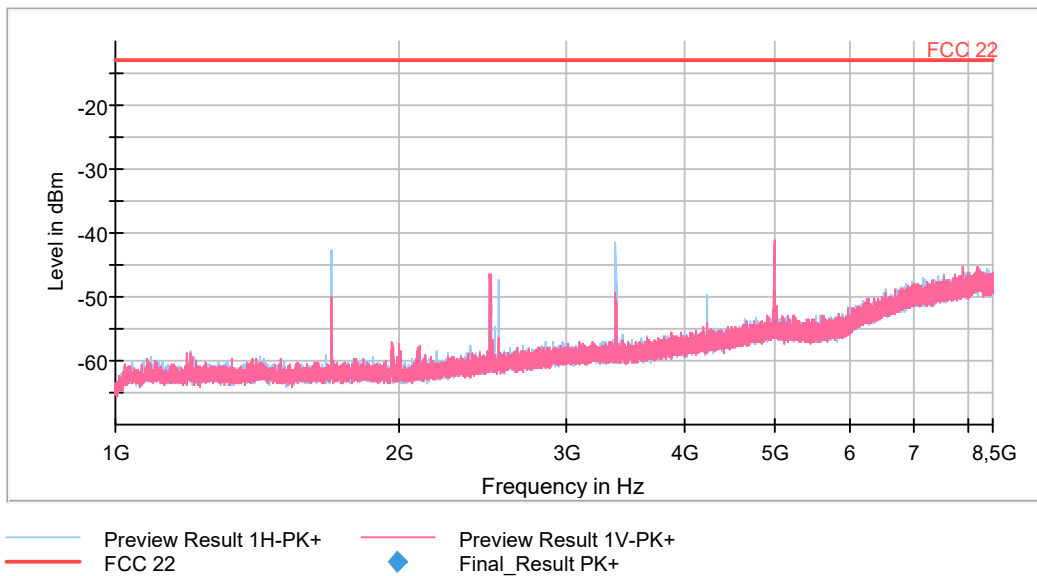

Appendix B: Test results for FCC 22 / RSS-132: LTE Cat NB1 Bands 5, 26

INDEX

TEST CONDITIONS	51
RF Output Power	52
Frequency Stability	56
Modulation Characteristics	60
Occupied Bandwidth	62
Spurious Emissions at Antenna Terminals	72
Spurious Emissions at Antenna Terminals at Block Edges	76
Radiated Emissions	81