

  <p>ENSAYOS Nº 51/LE147</p>	FCC LISTED, REGISTRATION NUMBER: 720267  ISED LISTED REGISTRATION NUMBER ISED 4621A-4	Test report No: NIE: 59675RRF.003
<h2>Test report</h2> <p><b>REFERENCE STANDARD:                  USA FCC Part 22 &amp; Part 90                  CANADA IC RSS-132</b></p>		
Identification of item tested	IOT Module	
Trademark	nRF91	
Model and /or type reference	nRF9160	
Other identification of the product	FCC ID: 2ANPO00NRF9160 IC: 24529-NRF9160 IMEI TAC: 35265610	
Features	LTE Cat-M1, LTE-NB1, GPS	
Applicant	Nordic Semiconductor ASA Otto Nielsens Vei 12, 7052 Trondheim, NORWAY	
Test method requested, standard	USA FCC Part 22 10-1-18 Edition. USA FCC Part 90 10-1-18 Edition. CANADA IC RSS-132 Issue 3, Jan. 2013. ANSI C63.26 – 2015 ANSI/TIA-603-E: 2016	
Summary	IN COMPLIANCE	
Approved by (name / position & signature)	A. Llamas RF Lab. Manager	
Date of issue	2019-05-15	
Report template No	FDT08_21	

## Index

Competences and guarantees .....	3
General conditions .....	3
Uncertainty .....	3
Usage of samples .....	4
Data provided by the client.....	4
Test sample description .....	4
Identification of the client.....	6
Testing period and place.....	6
Document history .....	6
Environmental conditions .....	6
Remarks and comments .....	7
Testing verdicts.....	8
Summary .....	8
Appendix A: Test results for FCC Part 22 & 90 / RSS-132 .....	9

## Competences and guarantees

---

DEKRA Testing and Certification is a testing laboratory accredited by the National Accreditation Body (ENAC - Entidad Nacional de Acreditación), to perform the tests indicated in the Certificate No. 51/LE 147.

DEKRA Testing and Certification is a laboratory with a measurement facility in compliance with the requirements of Section 2.948 of the FCC rules and has been added to the list of facilities whose measurements data will be accepted in conjunction with applications for Certification under Parts 15 or 18 of the Commission's Rules. Registration Number: 720267.

DEKRA Testing and Certification is a laboratory with a measurement site in compliance with the requirements of RSS 212, Issue 1 (Provisional) and has been added to the list of filed sites of the Canadian Certification and Engineering Bureau. Reference File Number: ISED 4621A-4.

In order to assure the traceability to other national and international laboratories, DEKRA Testing and Certification has a calibration and maintenance program for its measurement equipment.

DEKRA Testing and Certification guarantees the reliability of the data presented in this report, which is the result of the measurements and the tests performed to the item under test on the date and under the conditions stated on the report and, it is based on the knowledge and technical facilities available at DEKRA Testing and Certification at the time of performance of the test.

DEKRA Testing and Certification is liable to the client for the maintenance of the confidentiality of all information related to the item under test and the results of the test.

The results presented in this Test Report apply only to the particular item under test established in this document.

**IMPORTANT:** No parts of this report may be reproduced or quoted out of context, in any form or by any means, except in full, without the previous written permission of DEKRA Testing and Certification.

## General conditions

---

1. This report is only referred to the item that has undergone the test.
2. This report does not constitute or imply on its own an approval of the product by the Certification Bodies or competent Authorities.
3. This document is only valid if complete; no partial reproduction can be made without previous written permission of DEKRA Testing and Certification.
4. This test report cannot be used partially or in full for publicity and/or promotional purposes without previous written permission of DEKRA Testing and Certification and the Accreditation Bodies.

## Uncertainty

---

Uncertainty (factor  $k=2$ ) was calculated according to the DEKRA Testing and Certification internal document PODT000.

## Usage of samples

Samples undergoing test have been selected by: the client.

Sample S/01 is composed of the following elements:

Control Nº	Description	Model	Serial Nº	Date of reception
59678C/004	IOT Module	nRF9160	IMEI: 352656100030561	2019-01-15

1. Sample S/01 has undergone the following test(s):

All tests indicated in appendix A.

## Data provided by the client

The sample consist of a IOT Module that has Application CPU, LTE Cat-M1, Cat-NB1 Radio and GPS Receiver.

DEKRA declines any responsibility with respect to the information provided by the client and that may affect the validity of results.

## Test sample description

Ports..... :	Port name and description	Cable				
		Specified length [m]	Attached during test	Shielded		
	LTE RF	2	<input checked="" type="checkbox"/>	<input checked="" type="checkbox"/>		
	GPS	2	<input checked="" type="checkbox"/>	<input checked="" type="checkbox"/>		
			<input type="checkbox"/>	<input type="checkbox"/>		
		<input type="checkbox"/>	<input type="checkbox"/>			
Supplementary information to the ports..... :	N/A					
Rated power supply .....	Voltage and Frequency	Reference poles				
		L1	L2	L3	N	PE
	<input type="checkbox"/>	AC:	<input type="checkbox"/>	<input type="checkbox"/>	<input type="checkbox"/>	<input type="checkbox"/>
	<input checked="" type="checkbox"/>	DC: 3.1 – 5.5Vdc.				
<input type="checkbox"/>	DC:					
Rated Power .....	1W					
Clock frequencies .....	32kHz, 32MHz					
Other parameters..... :	---					
Software version .....	mfw_nrf9160_0.7.0-29.alpha					

Hardware version.....:	DEV2.1.6		
Dimensions in cm (L x W x D) .....	11x16x1.1mm		
Mounting position.....:	<input type="checkbox"/>	Table top equipment	
	<input type="checkbox"/>	Wall/Ceiling mounted equipment	
	<input type="checkbox"/>	Floor standing equipment	
	<input type="checkbox"/>	Hand-held equipment	
	<input checked="" type="checkbox"/>	Other: SMD Module	
Modules/parts .....	Module/parts of test item	Type	Manufacturer
	N/A		
Accessories (not part of the test item) .....	Description	Type	Manufacturer
	N/A		
	N/A		
	N/A		
Documents as provided by the applicant.....:	Description	File name	Issue date
	User manual	4418_1177-0.3.1-20180905-140910-nRF9160_Objective_Product_Spec	23-Oct-2018
	Cover markings	SiP marking	23-Oct-2018

Copy of marking plate:



## Identification of the client

Nordic Semiconductor ASA  
Otto Nielsens Vei 12, 7052 Trondheim, NORWAY

## Testing period and place

Test Location	DEKRA Testing and Certification S.A.U.
Date (start)	2018-01-30
Date (finish)	2018-04-25

## Document history

Report number	Date	Description
59675RRF.003	2019-05-15	First release

## Environmental conditions

In the control chamber, the following limits were not exceeded during the test:

Temperature	Min. = 15 °C Max. = 35 °C
Relative humidity	Min. = 20 % Max. = 75 %

In the semianechoic chamber, the following limits were not exceeded during the test.

Temperature	Min. = 15 °C Max. = 35 °C
Relative humidity	Min. = 20 % Max. = 75 %

In the chamber for conducted measurements, the following limits were not exceeded during the test:

Temperature	Min. = 15 °C Max. = 35 °C
Relative humidity	Min. = 20 % Max. = 35 %

## Remarks and comments

---

The tests have been performed by the technical personnel: José Alberto Aranda.

Used instrumentation:

### Conducted Measurements

	Last Cal. date	Cal. due date
1. Spectrum analyser Agilent E4440A	2017/10	2019/10
2. Vector signal analyzer Rohde & Schwarz FSQ8	2018/08	2020/08
3. Climatic chamber HERAEUS VM 04/35	2018/06	2020/06
4. DC power supply R&S NGPE 40/40	2018/02	2021/02
5. Universal Radio communication Tester R&S CMW50	2019/02	2020/02
6. Spectrum analyser Rohde & Schwarz FSV40	2017/07	2019/07

### Radiated Measurements

	Last Cal. date	Cal. due date
1. Semianechoic Absorber Lined Chamber ETS FACT3 200STP	N.A.	N.A.
2. BiconicalLog antenna ETS LINDGREN 3142E	2017/09	2020/09
3. Multi Device Controller MESSTECHNIK DAV-RR	N.A.	N.A.
4. Double-ridge Guide Horn antenna 1-18 GHz SCHWARZBECK BBHA 9120 D	2018/01	2021/01
5. Spectrum analyser Rohde & Schwarz FSV40	2018/02	2020/02
6. EMI Test Receiver R&S ESR7	2018/10	2020/10
7. RF pre-amplifier 1-18 GHz Bonn Elektronik BLMA 0118-3A	2019/04	2020/04

## Testing verdicts

Not applicable :	N/A
Pass :	P
Fail :	F
Not measured :	N/M

## Summary

FCC PART 22/IC RSS-132 PARAGRAPH		
Requirement – Test case	Verdict	Remark
Clause 22.913/RSS-132 Clause 5.4: RF output power	P	
Clause 2.1047/RSS-132 Clause 5.2: Modulation characteristics	P	
Clause 22.355/RSS-132 Clause 5.3: Frequency stability	P	
Clause 2.1049: Occupied Bandwidth	P	
Clause 22.917/RSS-132 Clause 5.5: Spurious emissions at antenna terminals	P	
Clause 22.917/RSS-132 Clause 5.5: Radiated emissions	P	
<u>Supplementary information and remarks:</u>		
None		

FCC PART 90 PARAGRAPH		
Requirement – Test case	Verdict	Remark
Clause 90.635 (b): RF output power	P	
Clause 2.1047: Modulation characteristics	P	
Clause 90.213 Frequency stability	P	
Clause 2.1049: Occupied Bandwidth	P	
Clause 90.691 Spurious emissions at antenna terminals (Emission mask requirements for EA-based systems)	P	
Clause 90.691: Radiated emissions	P	
<u>Supplementary information and remarks:</u>		
None		



## **Appendix A: Test results for FCC Part 22 & 90 / RSS-132**

## INDEX

TEST CONDITIONS.....	11
RF Output Power .....	13
Frequency Stability .....	18
Modulation Characteristics .....	21
Occupied Bandwidth .....	24
Spurious emissions at antenna terminals.....	32
Spurious emissions at antenna terminals at Block Edges.....	37
Radiated emissions.....	43

## TEST CONDITIONS

Power supply (V):

Vnominal = 3.8 Vdc

Vmax = 4.37 Vdc

Vmin = 3.23 Vdc

The subscripts nom, min and max indicate voltage test conditions (nominal, minimum and maximum respectively, as declared by the applicant).

Type of power supply = DC Voltage from external power supply

Type of antenna = Integral antenna.

Declared Gain for antenna = +2.6 dBi.

TEST FREQUENCIES:

### **814-824MHz Band:**

LTE. QPSK AND 16QAM MODULATION (BAND 26)

	Channel (Frequency, MHz)				
	BW = 1.4 MHz	BW = 3 MHz	BW = 5 MHz	BW = 10 MHz	BW = 15 MHz
Lowest	26697 (814.70)	26705 (815.5)	26715 (816.5)	---	---
Middle	26740 (819)	26740 (819)	26740 (819)	26740 (819)	---
Highest	26783 (823.30)	26775 (822.50)	26765 (821.50)	---	---

### **Cross-rule channel (824MHz):**

LTE. QPSK AND 16QAM MODULATION (BAND 26)

Channel (Frequency, MHz)				
BW = 1.4 MHz	BW = 3 MHz	BW = 5 MHz	BW = 10 MHz	BW = 15 MHz
26790 (824)	26790 (824)	26790 (824)	26790 (824)	26790 (824)

**824-849MHz Band:**

LTE. QPSK AND 16QAM MODULATION (BAND 5)

	Channel (Frequency, MHz)			
	BW = 1.4 MHz	BW = 3 MHz	BW = 5 MHz	BW = 10 MHz
Lowest	20407 (824.70)	20415 (825.50)	20425 (826.50)	20450 (829.00)
Middle	20525 (836.50)	20525 (836.50)	20525 (836.50)	20525 (836.50)
Highest	20643 (848.30)	20635 (847.50)	20625 (846.50)	20600 (844.00)

LTE. QPSK AND 16QAM MODULATION (BAND 26)

	Channel (Frequency, MHz)				
	BW = 1.4 MHz	BW = 3 MHz	BW = 5 MHz	BW = 10 MHz	BW = 15 MHz
Lowest	26797 (824.70)	26805 (825.50)	26815 (826.50)	26840 (829.00)	26865 (831.50)
Middle	26915 (836.50)	26915 (836.50)	26915 (836.50)	26915 (836.50)	26915 (836.50)
Highest	27033 (848.30)	27025 (847.50)	27015 (846.50)	26990 (844.00)	26965 (841.50)

NOTE: Band 26 is completely included in band 5, so the channels of band 5 were tested to give conformity to the assigned block.

## RF Output Power

### SPECIFICATION

FCC §2.1046 and §22.913. The Effective Radiated Power (E.R.P.) of mobile transmitter and auxiliary test transmitter must not exceed 7 Watts (38.45 dBm E.R.P.).

RSS-132. Clause 5.4. The equivalent isotropically radiated power (e.i.r.p.) for mobile equipment shall not exceed 11.5 watts (38.45 dBm E.R.P.).

In addition, the peak-to-average power ratio (PAPR) of the transmitter shall not exceed 13 dB for more than 0.1% of the time using a signal corresponding to the highest PAPR during periods of continuous transmission.

FCC §90.635. The maximum output power of the transmitter for mobile stations is 100 watts (20 dBw).

### METHOD

The conducted RF output power measurements were made at the RF output terminals of the EUT using the power meter of the Universal Radio Communication tester R&S CMU200 and CMW500, selecting maximum transmission power of the EUT and different modes of modulation.

The peak-to-average power ratio (PAPR) is measured using an attenuator, power splitter and spectrum analyser with a Complementary Cumulative Distribution Function implemented.

The maximum equivalent isotropically radiated power (e.i.r.p.) is calculated by adding the declared maximum antenna gain (dBi).

The maximum effective radiated power e.r.p. is calculated from the maximum equivalent isotropically radiated power (e.i.r.p.) by subtracting 2.15 dB:

$$\text{E.R.P.} = \text{E.I.R.P.} - 2.15 \text{ dB}$$

### TEST SETUP

Conducted average power.



### Peak-to-average power ratio (PAPR)

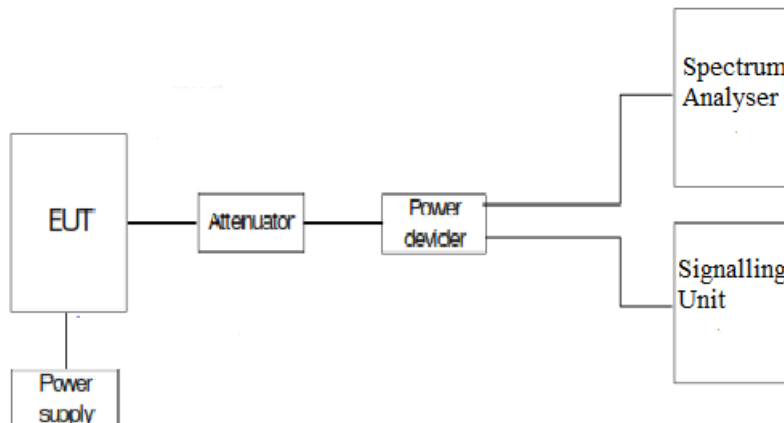

## RESULTS

### MAXIMUM OUTPUT POWER (CONDUCTED).

#### 814-824 MHz Band:

Preliminary measurements determined the narrow band = 1 and nominal bandwidth of 5 MHz as the worst case. The results in the next tables shows the results for this configuration.

Narrow band = 1

BANDWIDTH (MHz)	CHANNEL	FREQUENCY (MHz)	MODULATION	RB SIZE	RB OFFSET	AVERAGE POWER (dBm)
5	26715	816.5	QPSK	1	0	22.84
				6	0	22.06
			16-QAM	1	0	21.83
				5	0	21.05
	26765	821.5	QPSK	1	0	22.84
				6	0	21.93
16-QAM	1	0	21.85			
	5	0	20.87			

#### Cross-rule channel (824MHz):

Preliminary measurements determined the narrow band = 1 and nominal bandwidth of 1.4 MHz as the worst case. The results in the next tables shows the results for this configuration.

BANDWIDTH (MHz)	CHANNEL	FREQUENCY (MHz)	MODULATION	RB SIZE	RB OFFSET	AVERAGE POWER (dBm)
1.4	26790	824	QPSK	1	0	22.98
				6	0	21.06
			16-QAM	1	0	21.87
				5	0	21.14

#### 824-849MHz Band:

Preliminary measurements determined the narrow band = 1 and nominal bandwidth of 3 MHz as the worst case. The results in the next tables shows the results for this configuration.

BANDWIDTH (MHz)	CHANNEL	FREQUENCY (MHz)	MODULATION	RB SIZE	RB OFFSET	AVERAGE POWER (dBm)	PAPR (dB)
3	20415	825.5	QPSK	1	0	22.97	4.65
				6	0	20.75	
			16-QAM	1	0	21.89	
				5	0	21.08	
	20525	836.5	QPSK	1	0	22.99	4.68
				6	0	21.07	
			16-QAM	1	0	21.86	
				5	0	20.99	
	20635	847.5	QPSK	1	0	22.99	4.76
				6	0	21.08	
			16-QAM	1	0	21.73	
				5	0	20.33	

PEAK-TO-AVERAGE POWER RATIO (PAPR).

**824-849MHz Band:**

Preliminary measurements determined the narrow band = 1, nominal bandwidth of 3 MHz, 16-QAM modulation and 5 RB size offset 0 as the worst case. The results in the next tables shows the results for this configuration.

Channel Low:

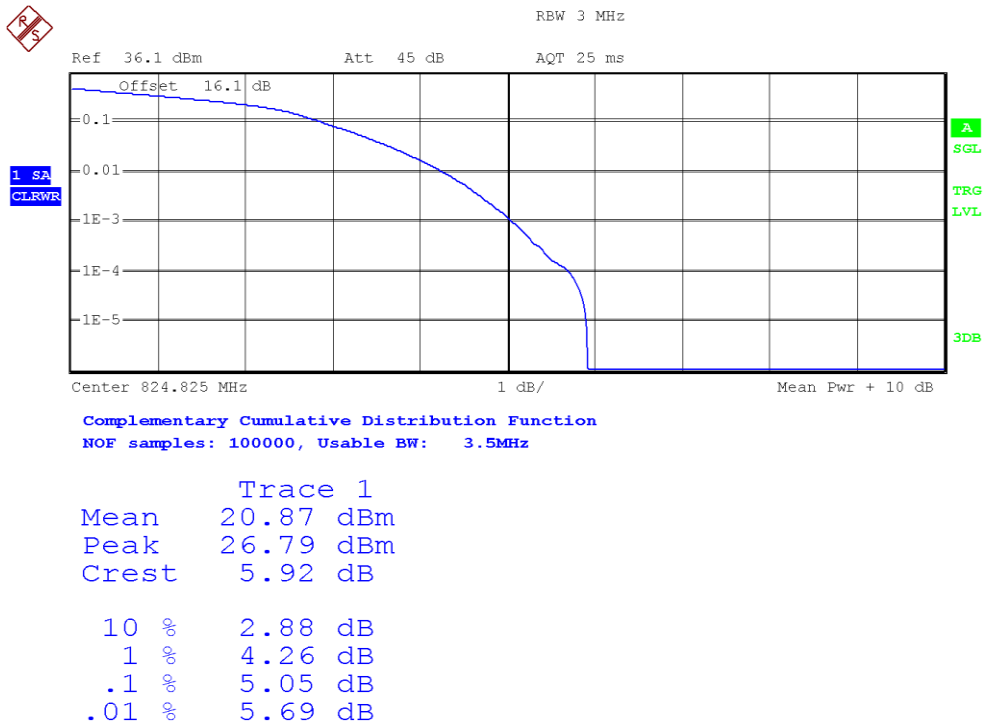

Channel Middle:

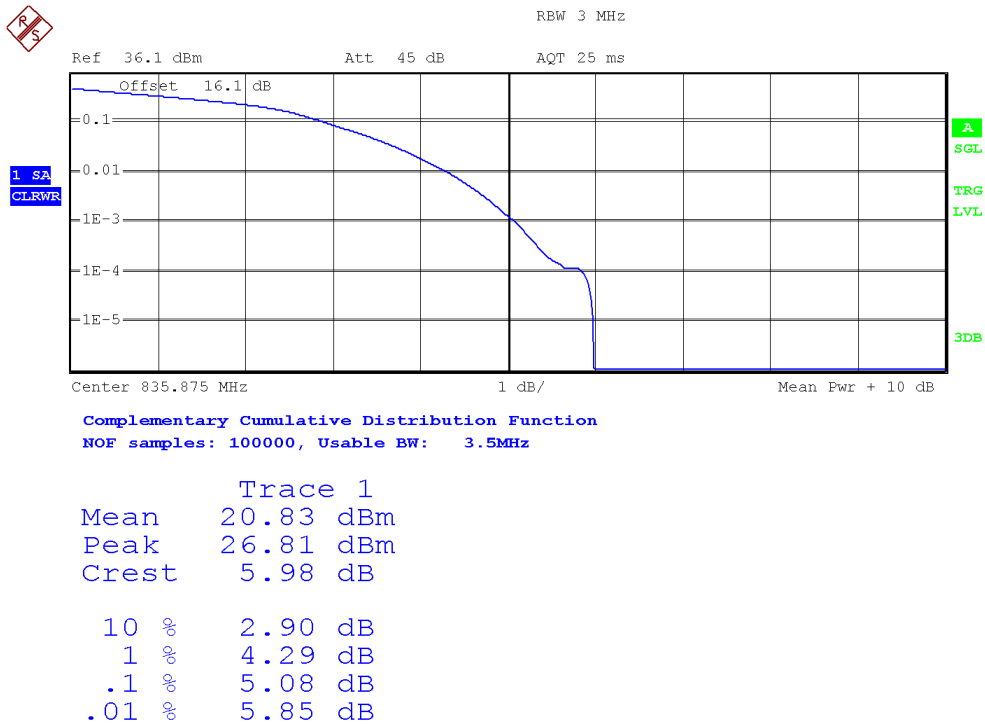

Channel High:

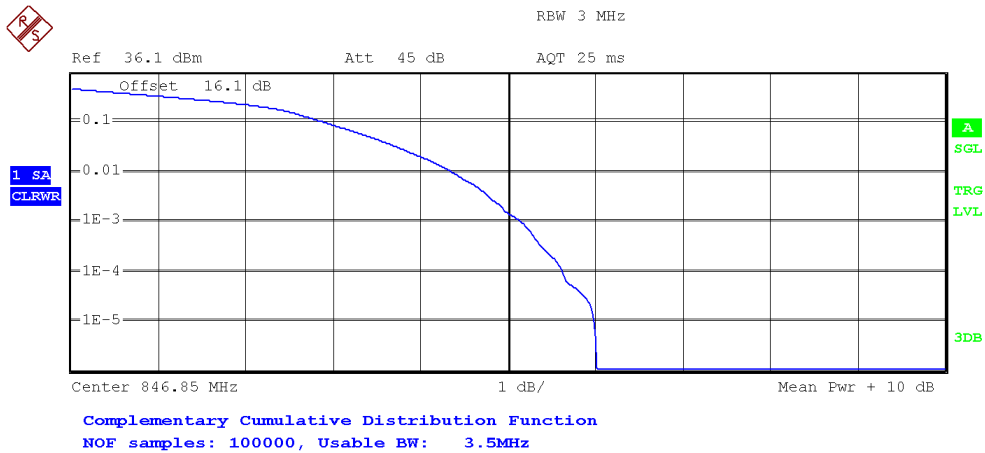

Center 846.85 MHz 1 dB/ Mean Pwr + 10 dB  
 Complementary Cumulative Distribution Function  
 NOF samples: 100000, Usable BW: 3.5MHz

Trace 1  
 Mean 20.82 dBm  
 Peak 26.83 dBm  
 Crest 6.02 dB  
 10 % 2.90 dB  
 1 % 4.36 dB  
 .1 % 5.14 dB  
 .01 % 5.63 dB

**814-824 MHz Band:**

Channel	Measured maximum average power (dBm) at antenna port	Maximum declared antenna gain (dBi)	Maximum equivalent isotropically radiated power (E.I.R.P.) (dBm)	Maximum effective radiated power E.R.P. (dBm)
Lowest	22.84	+2.6	25.44	23.29
Highest	22.84	+2.6	25.44	23.29
Measurement uncertainty (dB)	<±1.11			

**Cross-rule channel (824MHz):**

Channel	Measured maximum average power (dBm) at antenna port	Maximum declared antenna gain (dBi)	Maximum equivalent isotropically radiated power (E.I.R.P.) (dBm)	Maximum effective radiated power E.R.P. (dBm)
26790 (824)	22.98	+2.6	25.58	23.43
Measurement uncertainty (dB)	<±1.11			



**824-849MHz Band:**

Channel	Measured maximum average power (dBm) at antenna port	Maximum declared antenna gain (dBi)	Maximum equivalent isotropically radiated power (E.I.R.P.) (dBm)	Maximum effective radiated power E.R.P. (dBm)	PAPR (dB)
Lowest	22.97	+2.6	25.57	23.42	5.05
Middle	22.99	+2.6	25.59	23.44	5.08
Highest	22.99	+2.6	25.59	23.44	5.14
Measurement uncertainty (dB)	<±1.11				

Verdict: PASS

## Frequency Stability

### SPECIFICATION

FCC §2.1055 and §22.355.  $\pm 2.5$  ppm for mobile stations operating in the range 821 to 896 MHz.

FCC §2.1055 and §90.213.  $\pm 2.5$  ppm for mobile stations operating in the range 809 to 824 MHz.

RSS-132. Clause 5.3. The carrier frequency shall not depart from the reference frequency in excess of  $\pm 2.5$  ppm for mobile stations.

### METHOD

The frequency tolerance measurements over temperature variations were made over the temperature range of  $-30^{\circ}\text{C}$  to  $+50^{\circ}\text{C}$ . The EUT was placed inside a climatic chamber and the temperature was raised hourly in  $10^{\circ}\text{C}$  steps from  $-30^{\circ}\text{C}$  up to  $+50^{\circ}\text{C}$ .

The supply voltage was varied between 85% and 115% of nominal voltage.

The EUT was set in "Radio Resource Control (RRC) mode" in the middle channel using the Universal Radio Communication tester R&S CMW500 and the maximum frequency error was measured using the built-in calibrated frequency meter.

The worst case LTE mode for conducted power was used for the test.

The reference point measurements were made at the RF output terminals of the EUT using an attenuator, power splitter and spectrum analyser. The EUT was controlled via the Universal Radio Communication tester R&S CMW500 selecting maximum transmission power of the EUT and different modes of modulation.

### TEST SETUP

Frequency tolerance.

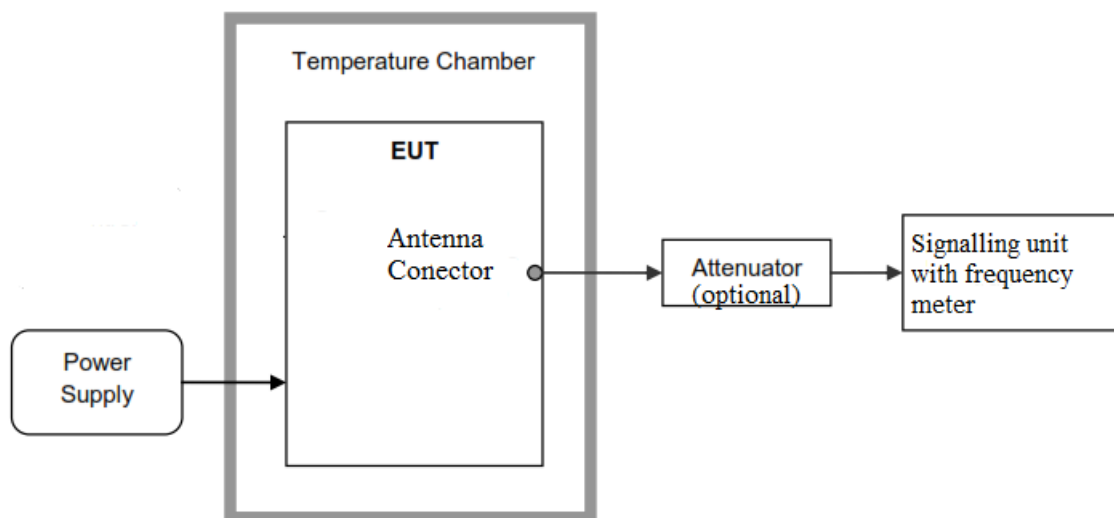

## RESULTS

Frequency stability over temperature variations.

LTE Band 5 QPSK MODULATION. BW = 1.4 MHz

Temperature (°C)	Frequency Error (Hz)	Frequency Error (ppm)
+50	-4.55	-0.00544
+40	-2.57	-0.00307
+30	2.52	0.00301
+20	-6.01	-0.00718
+10	-6.75	-0.00806
0	-0.9	-0.00107
-10	6.14	0.00734
-20	-6.68	-0.00798
-30	3.89	0.00465

LTE Band 26 QPSK MODULATION. BW = 1.4 MHz

Temperature (°C)	Frequency Error (Hz)	Frequency Error (ppm)
+50	3.75	0.00457
+40	2.78	0.00340
+30	0.34	0.00041
+20	6.39	0.00780
+10	1.67	0.00203
0	5.49	0.00670
-10	-8.01	-0.00978
-20	-3.85	-0.00470
-30	-9.13	-0.01114

Frequency stability over voltage variations.

LTE Band 5 QPSK MODULATION. BW = 1.4 MHz

Battery Supply voltage	Voltage (V)	Frequency Error (Hz)	Frequency Error (ppm)
Vmax	4.37	-10.21	-0.01221
Vmin	3.23	-8.45	-0.01011

LTE Band 26 QPSK MODULATION. BW = 1.4 MHz

Battery Supply voltage	Voltage (V)	Frequency Error (Hz)	Frequency Error (ppm)
Vmax	4.37	0.94	0.00114
Vmin	3.23	2.89	0.00353

Verdict: PASS

## Modulation Characteristics

### SPECIFICATION

FCC §2.1047

RSS-132. Clause 5.2. Equipment certified under this standard shall use digital modulation.

### METHOD

For LTE the EUT operates with QPSK and 16QAM modulation modes in which the information is digitised and coded into a bit stream. The RF transmission is multiplexed using *Orthogonal Frequency Division Multiplexing (OFDM)* using different possible arrangement of subcarriers (Resource Blocks RB).

### TEST SETUP

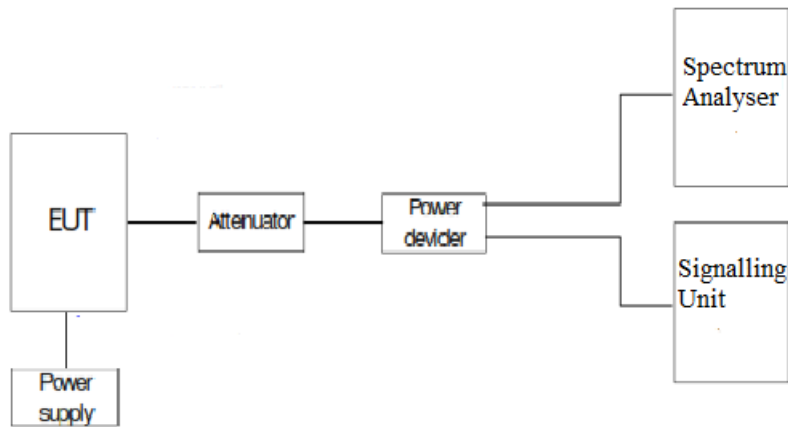

### RESULTS

The following plot shows the modulation schemes in the EUT.

LTE MODULATION (Band 5). QPSK.

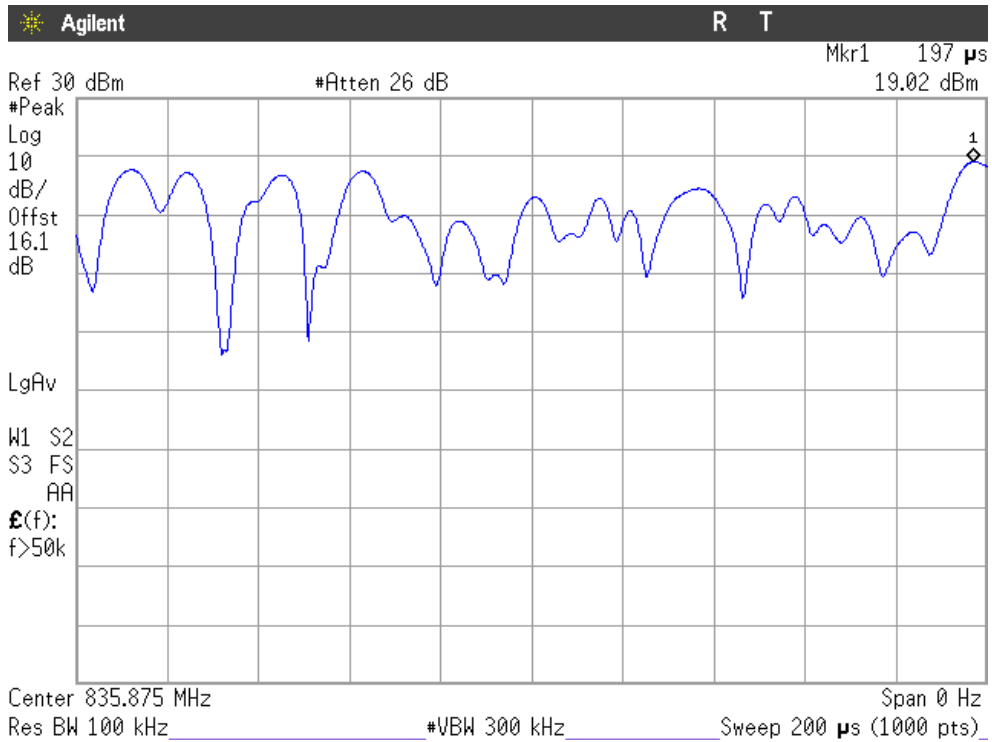

LTE MODULATION (Band 5). 16QAM.

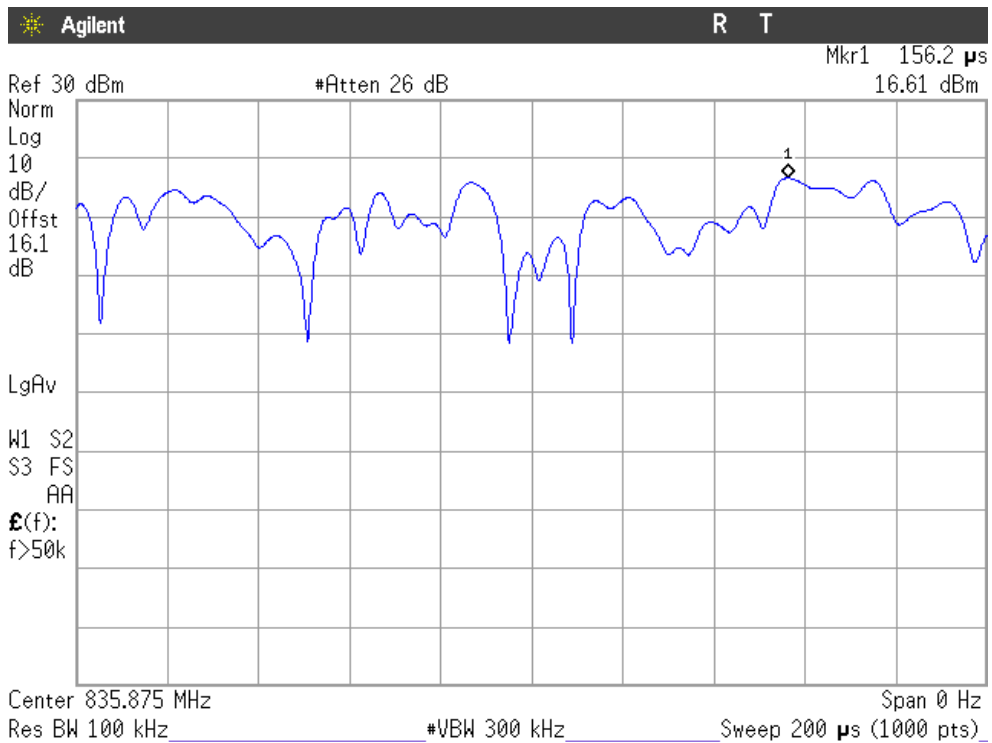

LTE MODULATION (Band 26). QPSK.

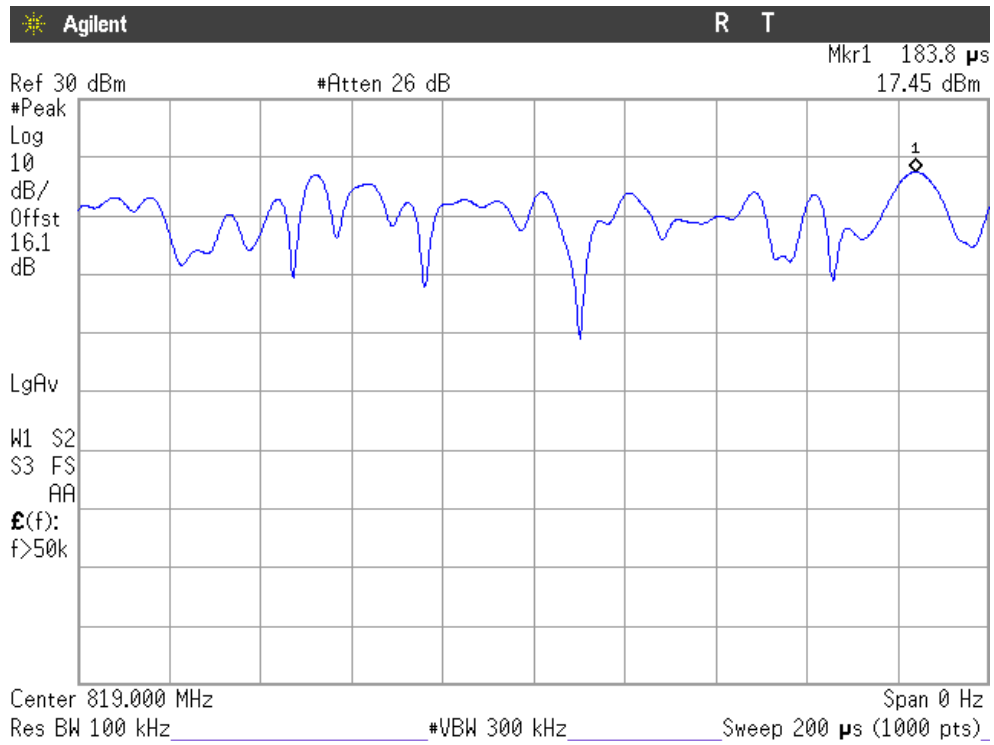

LTE MODULATION (Band 26). 16QAM.

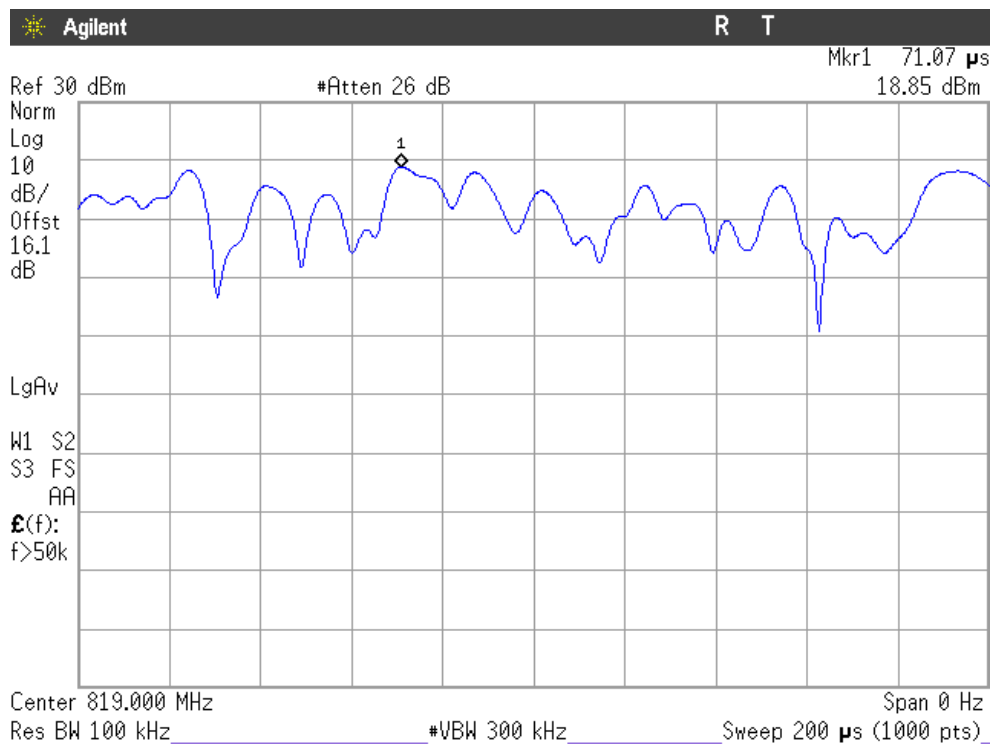

## Occupied Bandwidth

### SPECIFICATION

§2.1049

### METHOD

The occupied bandwidth measurement was performed at the output terminals of the EUT using an attenuator, power splitter and spectrum analyser. The EUT was controlled via the Universal Radio Communication tester R&S CMW500 selecting maximum transmission power of the EUT and different modes of modulation. The 99% occupied bandwidth and the -26 dBc bandwidth were measured directly using the built-in bandwidth measuring option of spectrum analyser.

### TEST SETUP

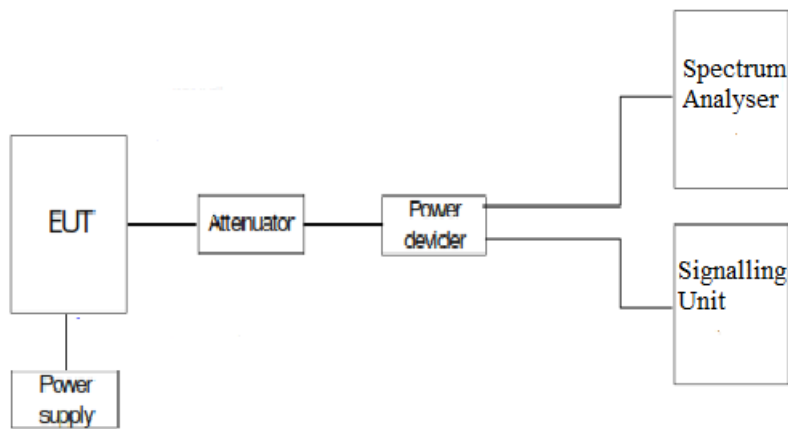

### RESULTS (see next plots)

The worst case of occupied bandwidth corresponds to all Resource Blocks (RB) offset 0 regardless either the Narrow band position or the nominal bandwidth selected.

#### **814-824MHz Band:**

LTE QPSK MODULATION. BW = 1.4 MHz (Band 26). Narrow band: 1.

Channel	Lowest	Highest
99% Occupied bandwidth (MHz)	1.113	1.115
-26 dBc bandwidth (MHz)	1.375	1.378
Measurement uncertainty (kHz)	<±8.33	

LTE 16QAM MODULATION. BW = 1.4 MHz (Band 26). Narrow band: 1.

Channel	Lowest	Highest
99% Occupied bandwidth (kHz)	965.958	940.756
-26 dBc bandwidth (MHz)	1.386	1.367
Measurement uncertainty (kHz)	<±8.33	



**Cross-rule channel (824MHz):**

LTE QPSK MODULATION. BW = 1.4 MHz (Band 26). Narrow band: 1.

Channel	26790
99% Occupied bandwidth (MHz)	1.113
-26 dBc bandwidth (MHz)	1.400
Measurement uncertainty (kHz)	<±1.13

LTE 16QAM MODULATION. BW = 1.4 MHz (Band 26). Narrow band: 1.

Channel	26790
99% Occupied bandwidth (kHz)	963.330
-26 dBc bandwidth (MHz)	1.438
Measurement uncertainty (kHz)	<±1.13

**824-849MHz Band:**

LTE QPSK MODULATION. BW = 1.4 MHz (Band 5). Narrow band: 1.

Channel	Lowest	Middle	Highest
99% Occupied bandwidth (MHz)	1.103	1.105	1.105
-26 dBc bandwidth (MHz)	1.349	1.368	1.326
Measurement uncertainty (kHz)	<±8.33		

LTE 16QAM MODULATION. BW = 1.4 MHz (Band 5). Narrow band: 1.

Channel	Lowest	Middle	Highest
99% Occupied bandwidth (kHz)	954.521	957.446	953.694
-26 dBc bandwidth (MHz)	1.453	1.324	1.409
Measurement uncertainty (kHz)	<±8.33		

**814-824MHz Band:**

LTE QPSK MODULATION. BW = 1.4 MHz (Band 26)

Lowest Channel

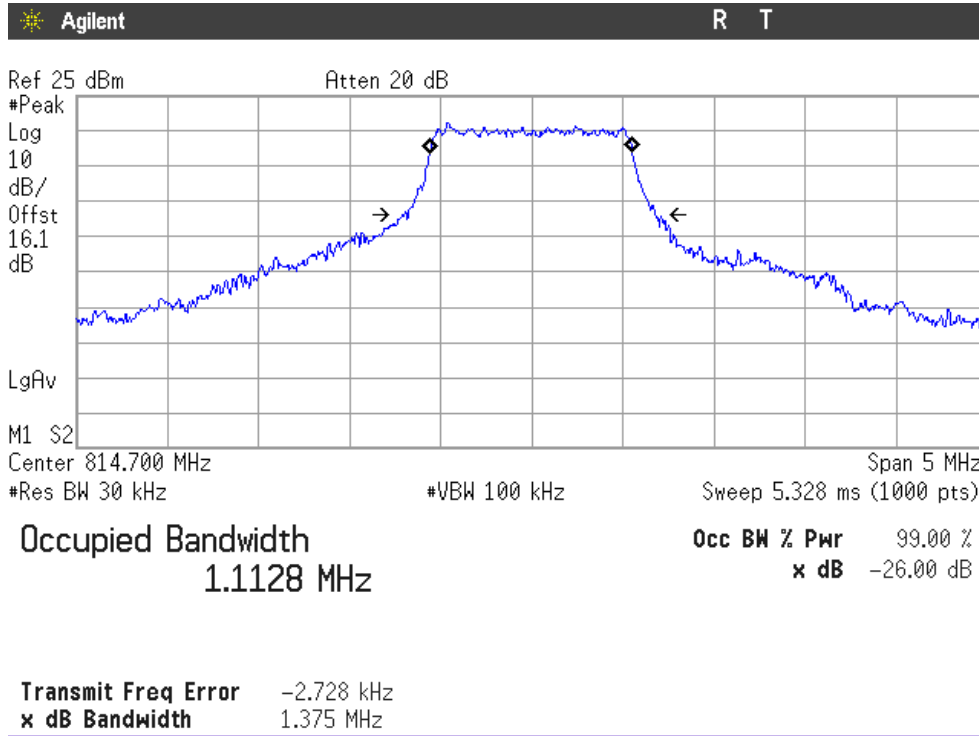

Highest Channel

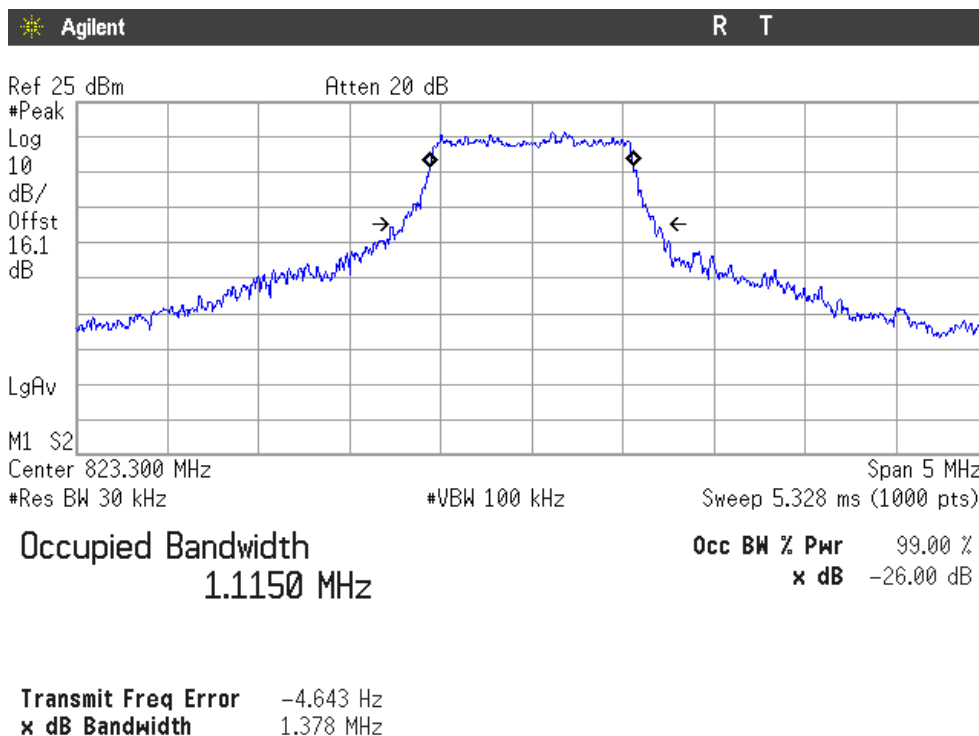

LTE 16QAM MODULATION. BW = 1.4 MHz (Band 26)

Lowest Channel

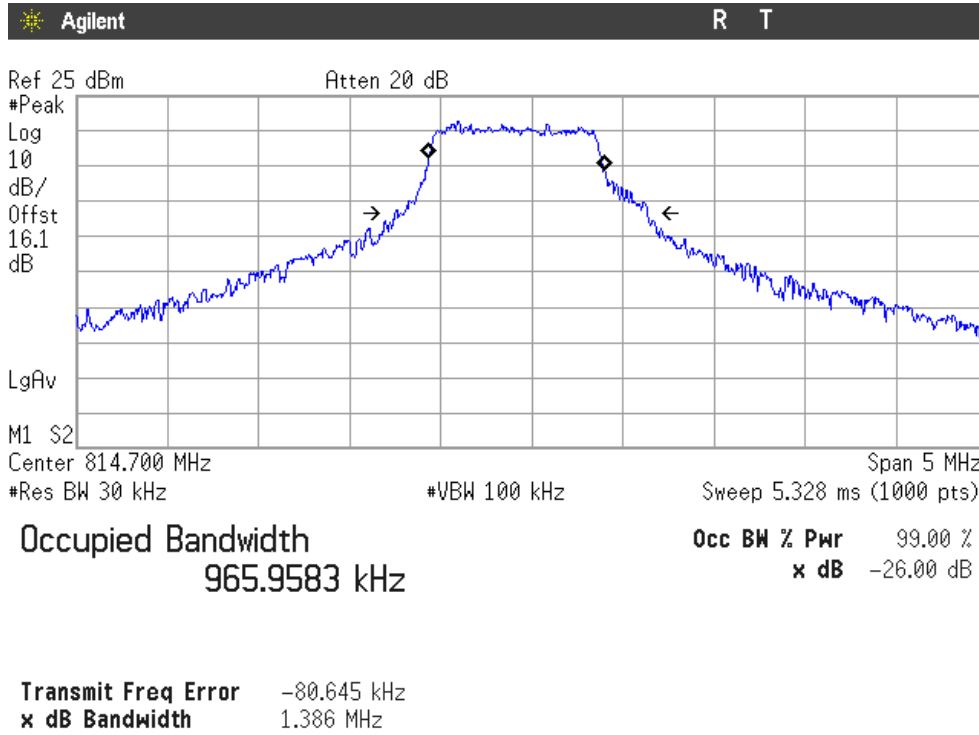

Highest Channel

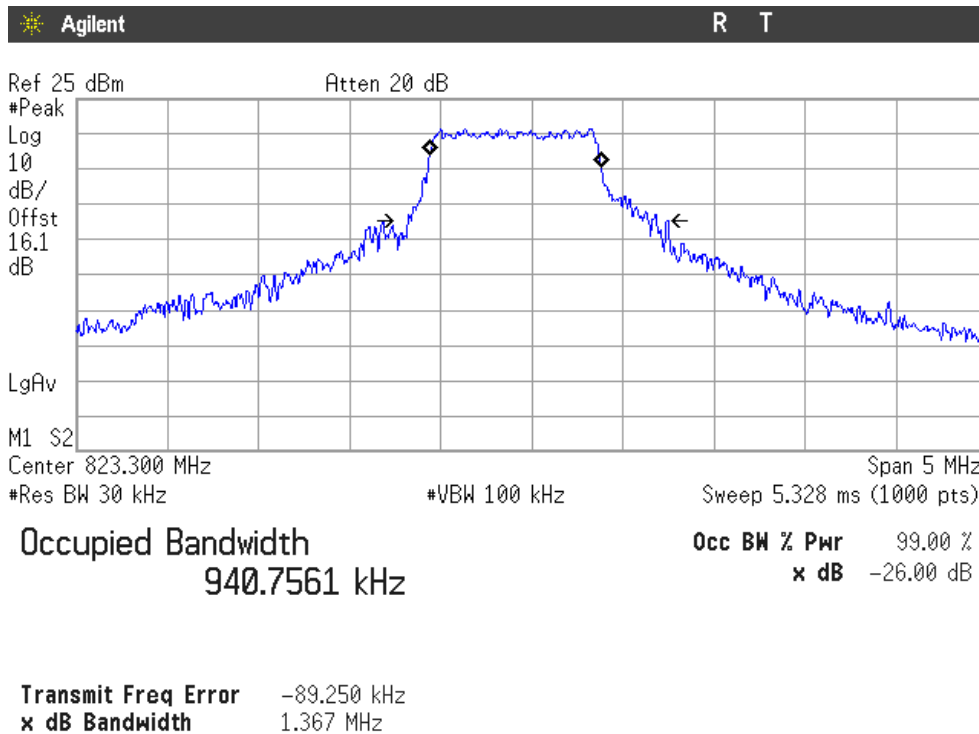

**Cross-rule channel (824MHz):**

LTE QPSK MODULATION. BW = 1.4 MHz

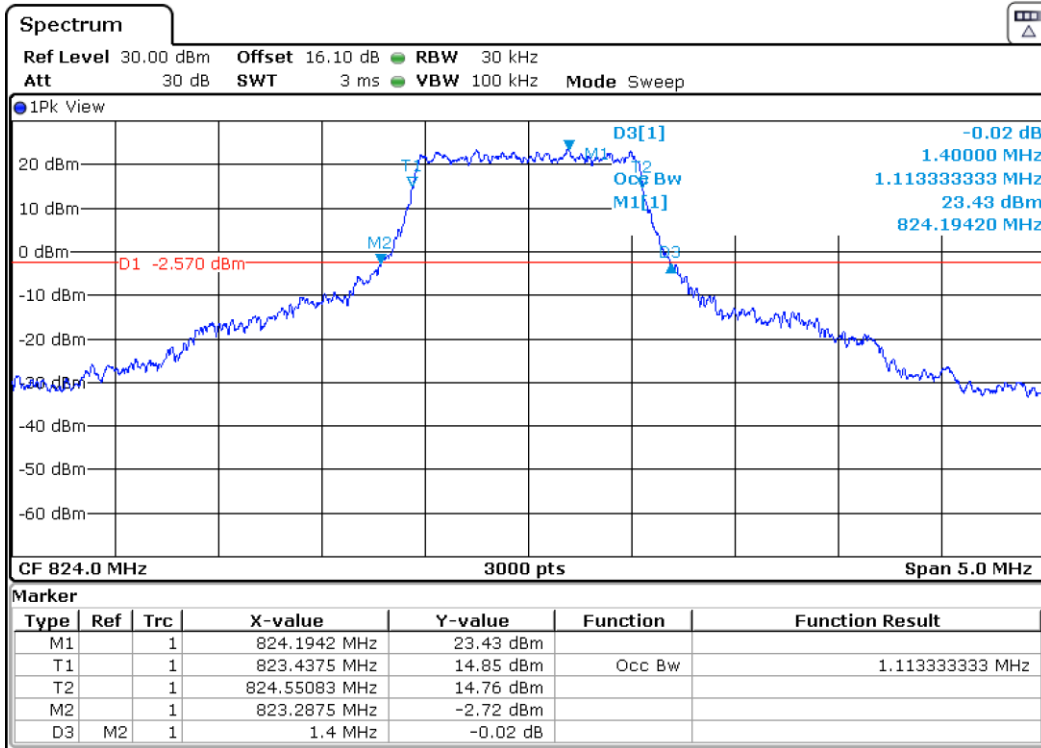

LTE 16QAM MODULATION. BW = 1.4 MHz

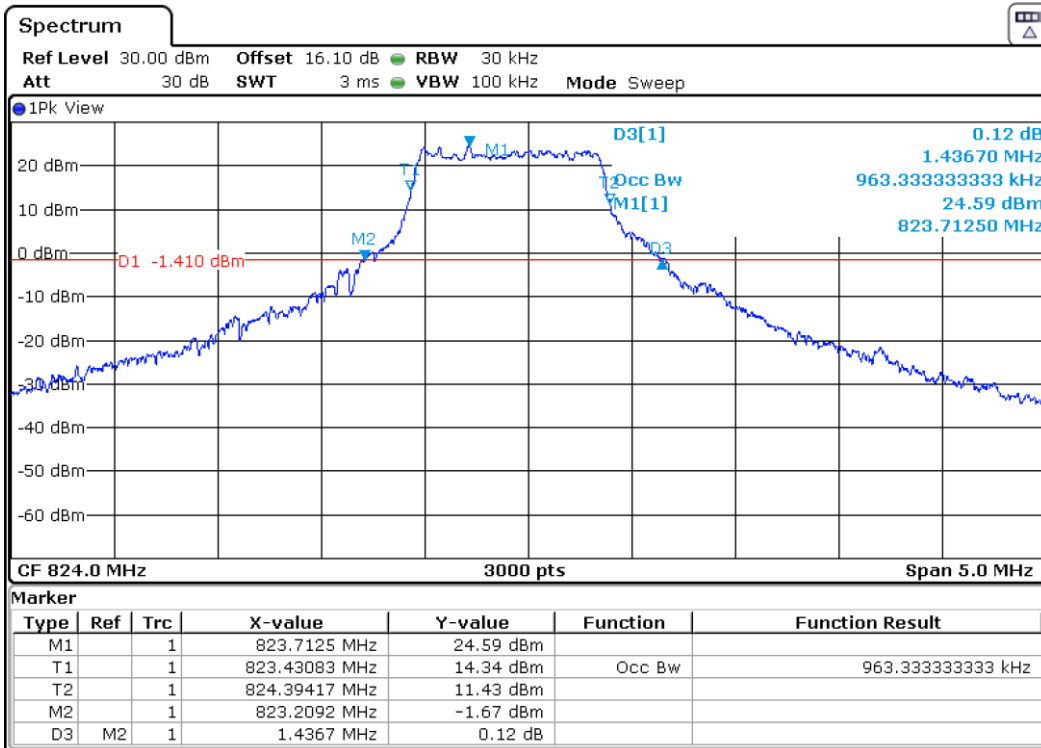

**824-849MHz Band:**

LTE QPSK MODULATION. BW = 3 MHz (Band 5)

Lowest Channel

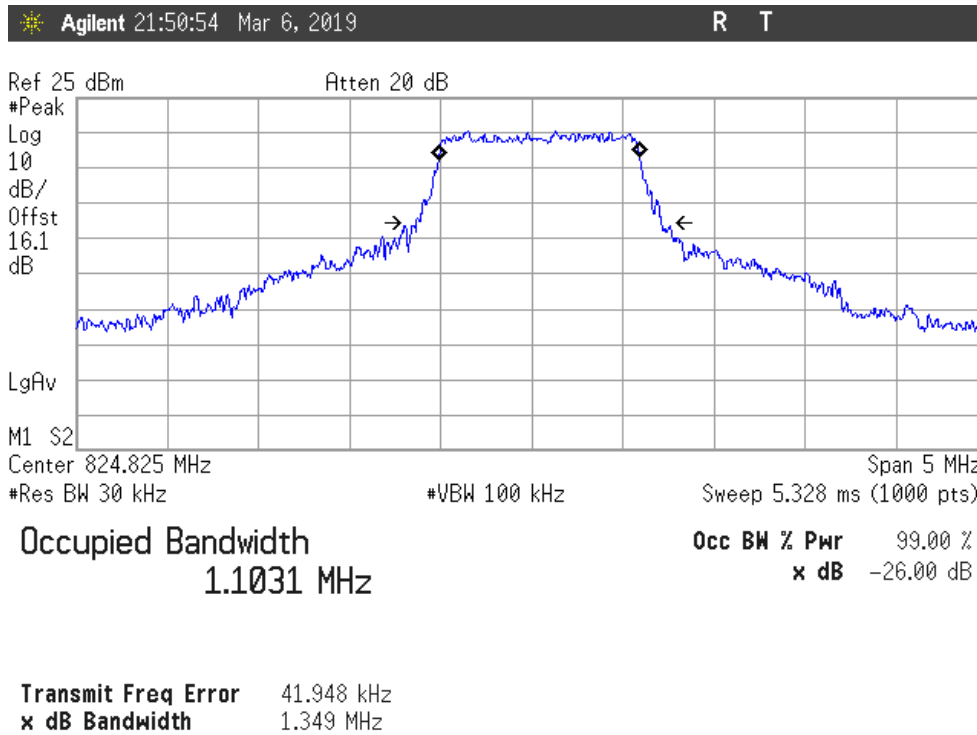

Middle Channel

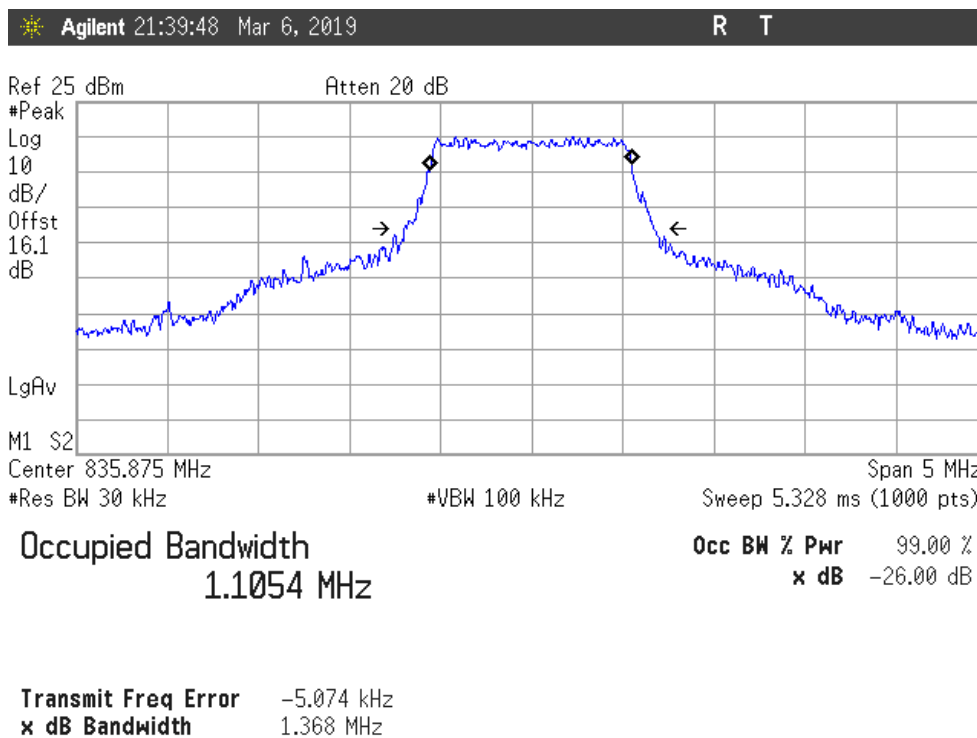

### Highest Channel

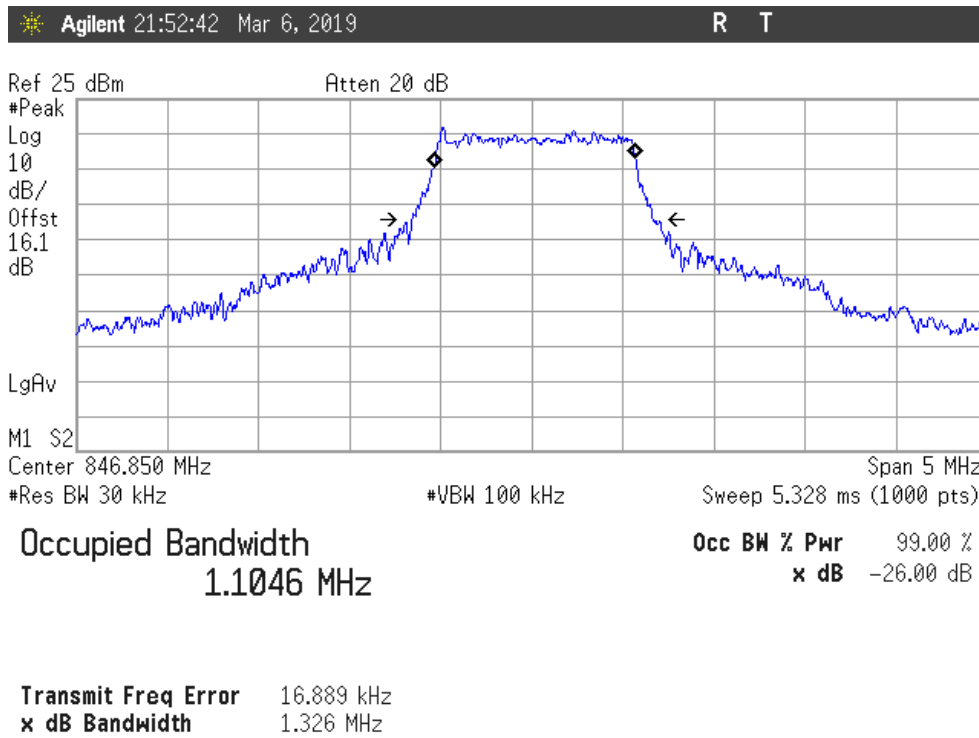

### LTE 16QAM MODULATION. BW = 1.4 MHz (Band 5)

### Lowest Channel

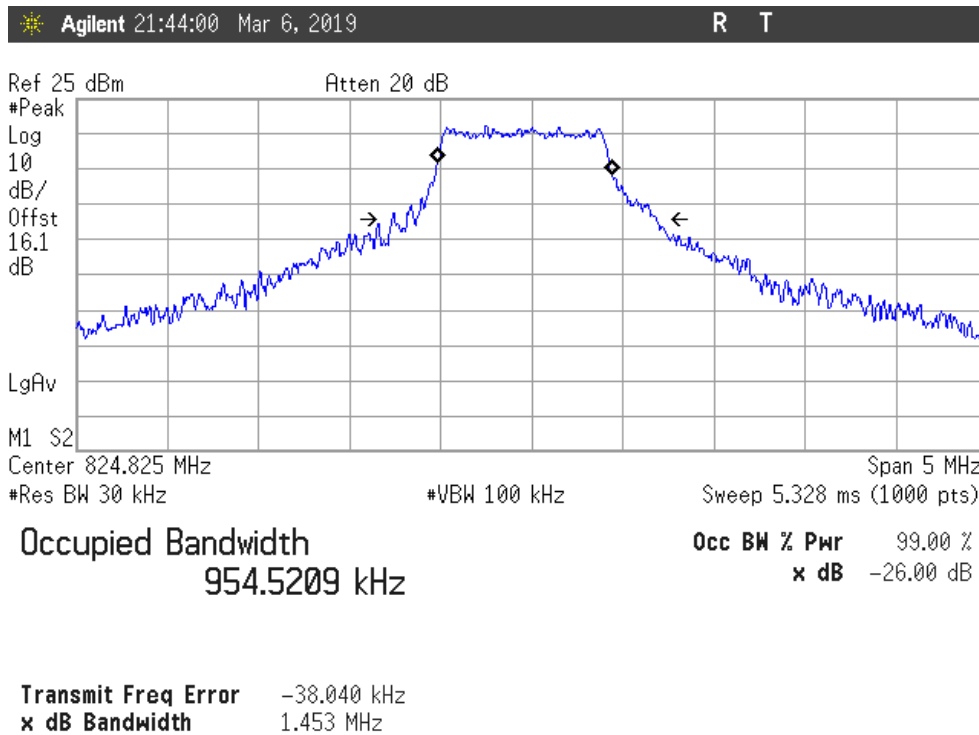

### Middle Channel

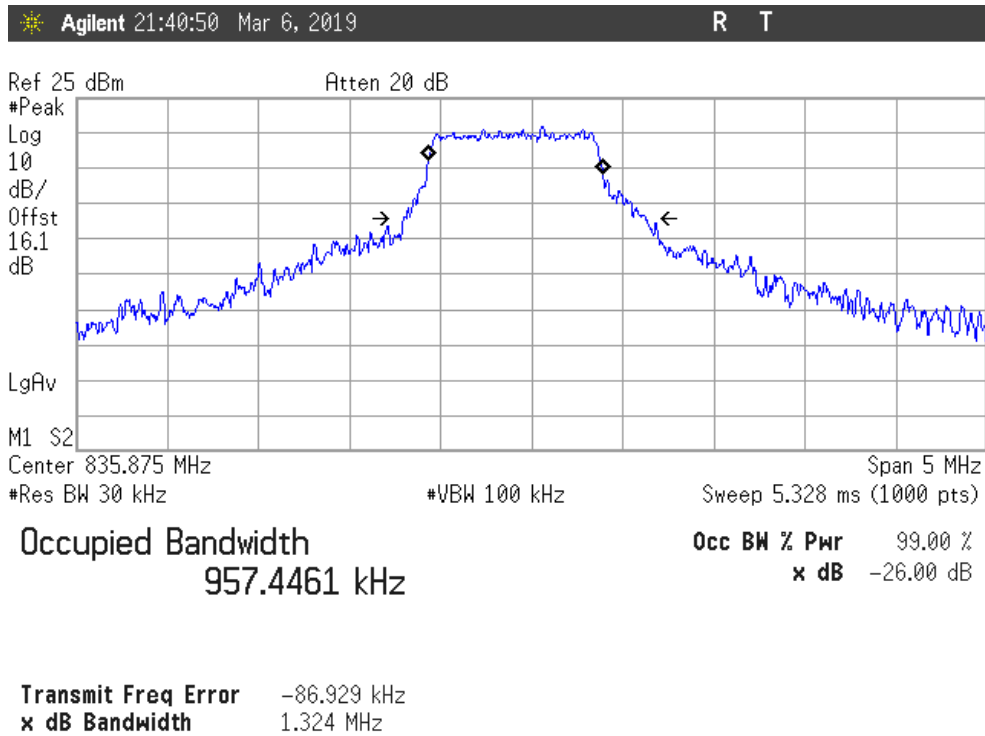

### Highest Channel

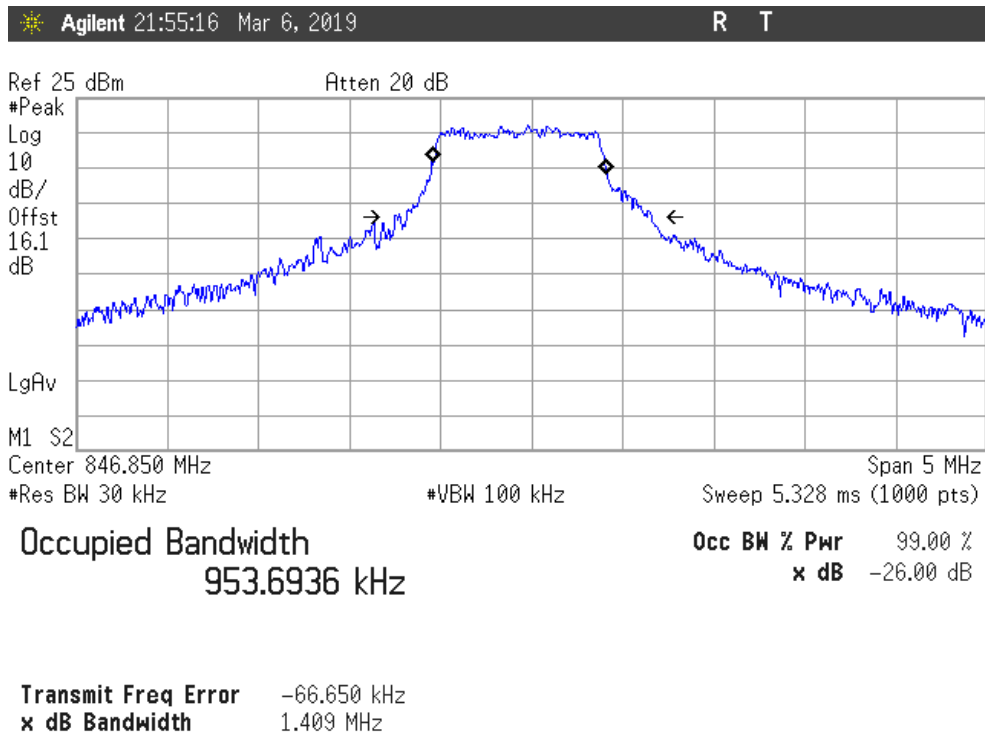

## Spurious emissions at antenna terminals

### SPECIFICATION

FCC §2.1051 and §22.917

RSS-132. Clause 5.5.

The power of emissions shall be attenuated below the transmitter power (P) by a factor of at least  $43 + 10 \log(P)$  dB. P in watts.

### METHOD

The EUT RF output connector was connected to a spectrum analyser and to the Universal Radio Communication tester R&S CMW500 (selecting maximum transmission power of the EUT and different modes of modulation) using a 50 ohm attenuator and a power divider.

The spectrum was investigated from 9 kHz to 10<sup>th</sup> harmonic for LTE Band 5 and 26.

The reading of the spectrum analyser is corrected with the attenuation loss of connection between output terminal of EUT and input of the spectrum analyser.

The configuration of Resource Blocks and modulation which is the worst case for conducted power was used.

Measurement Limit:

According to specification, the power of emissions shall be attenuated below the transmitter power (P) by a factor of at least  $43 + 10 \log(P)$  dB. P in watts.

At  $P_o$  transmitting power, the specified minimum attenuation becomes  $43 + 10 \log(P_o)$ , and the level in dBm relative  $P_o$  becomes:

$$P_o \text{ (dBm)} - [43 + 10 \log(P_o \text{ in mwatts}) - 30] = -13 \text{ dBm}$$

### TEST SETUP

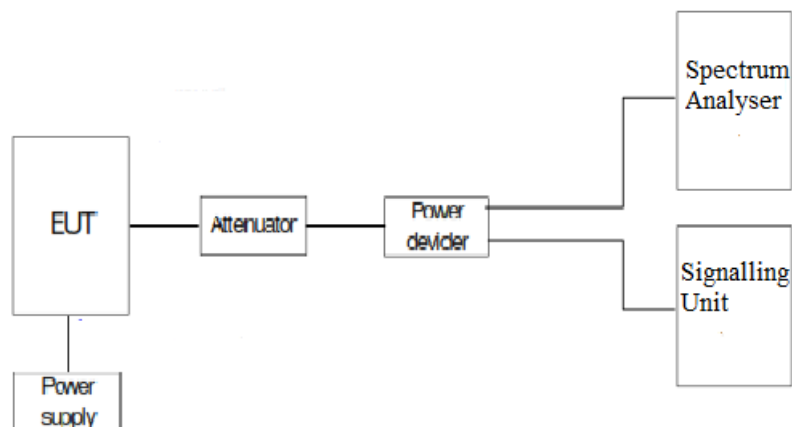



RESULTS (see plots in next pages)

**814-824MHz Band:**

LTE Band 26 (QPSK MODULATION. BW = 5 MHz)

1. CHANNEL: LOWEST

No spurious signals were found at less than 20dB respect to the limit in all the range.

2. CHANNEL: HIGHEST

No spurious signals were found at less than 20dB respect to the limit in all the range.

**Cross-rule channel (824MHz):**

LTE Band 26 (QPSK MODULATION. BW = 1.4 MHz)

1. CHANNEL (26790) 824MHz:

No spurious signals were found at less than 20dB respect to the limit in all the range.

**824-849MHz Band:**

LTE Band 5 (QPSK MODULATION. BW = 3 MHz)

1. CHANNEL: LOWEST

No spurious signals were found at less than 20dB respect to the limit in all the range.

2. CHANNEL: MIDDLE

No spurious signals were found at less than 20dB respect to the limit in all the range.

3. CHANNEL: HIGHEST

No spurious signals were found at less than 20dB respect to the limit in all the range.

Verdict: PASS

**814-824MHz Band:**

**1. CHANNEL: LOWEST**

Frequency Range 9 kHz – 9 GHz

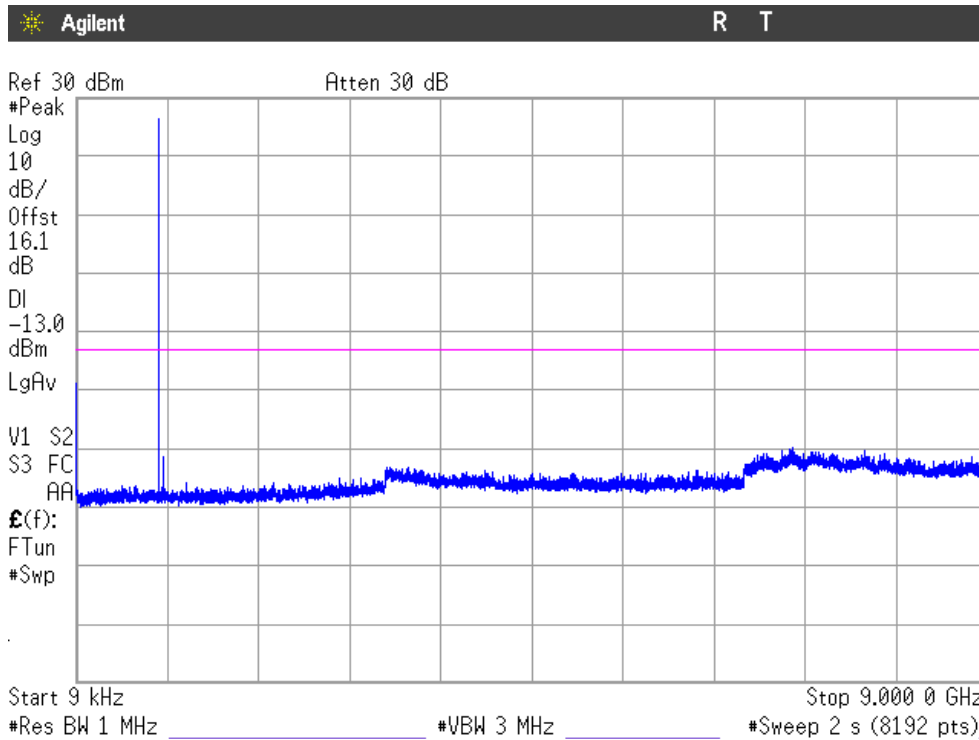

Note: The peak above the limit is the carrier frequency.

**2. CHANNEL: HIGHEST**

Frequency Range 9 kHz – 9 GHz

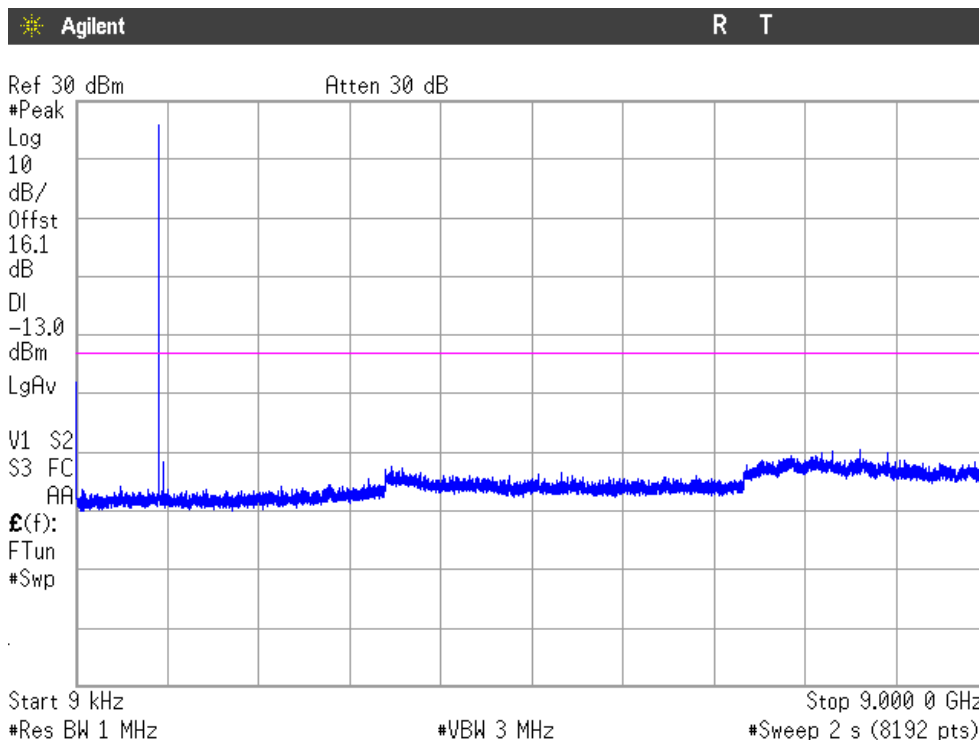

Note: The peak above the limit is the carrier frequency.

**Cross-rule channel (824MHz):**

1. CHANNEL: LOWEST

Frequency Range 9 kHz – 9 GHz

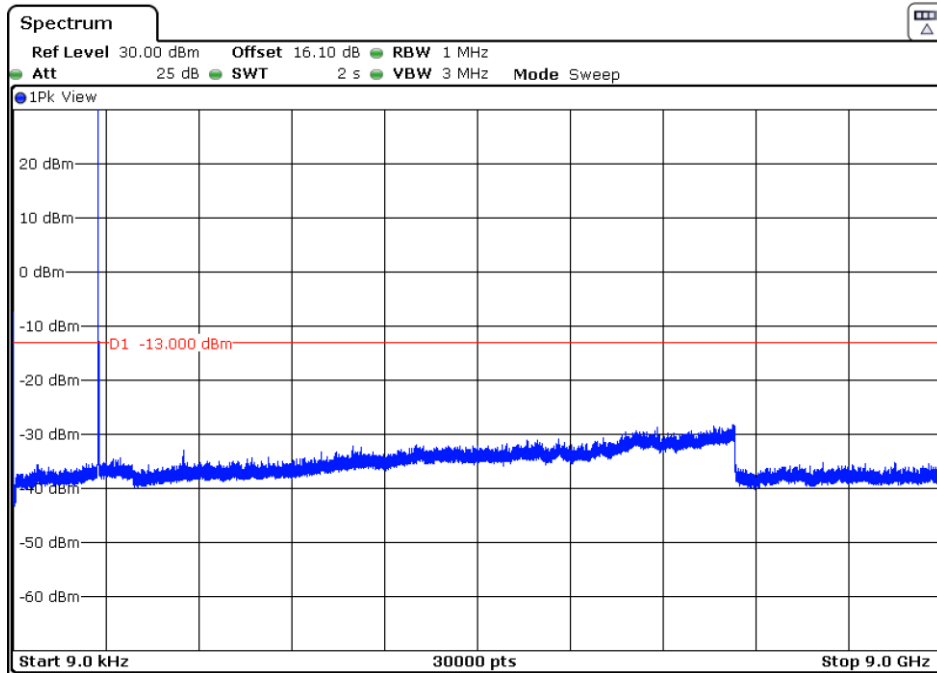

Note: The peak above the limit is the carrier frequency.

**824-849MHz Band:**

1. CHANNEL: LOWEST

Frequency Range 9 kHz – 10 GHz

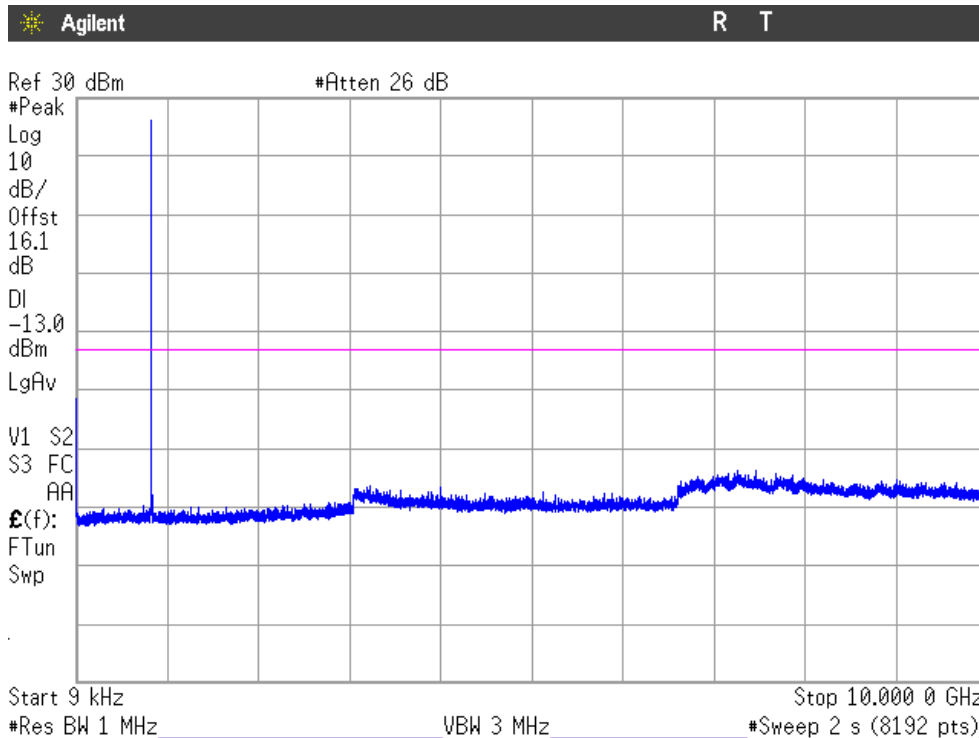

Note: The peak above the limit is the carrier frequency.

## 2. CHANNEL: MIDDLE

Frequency Range 9 kHz – 10 GHz

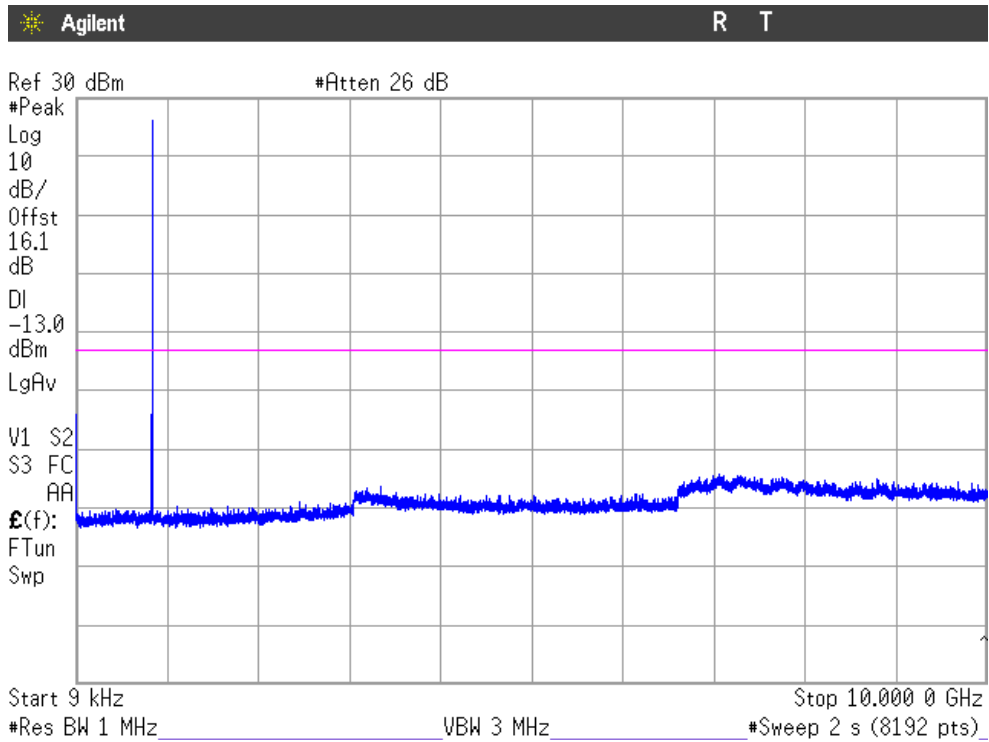

Note: The peak above the limit is the carrier frequency.

## 3. CHANNEL: HIGHEST

Frequency Range 9 kHz – 10 GHz

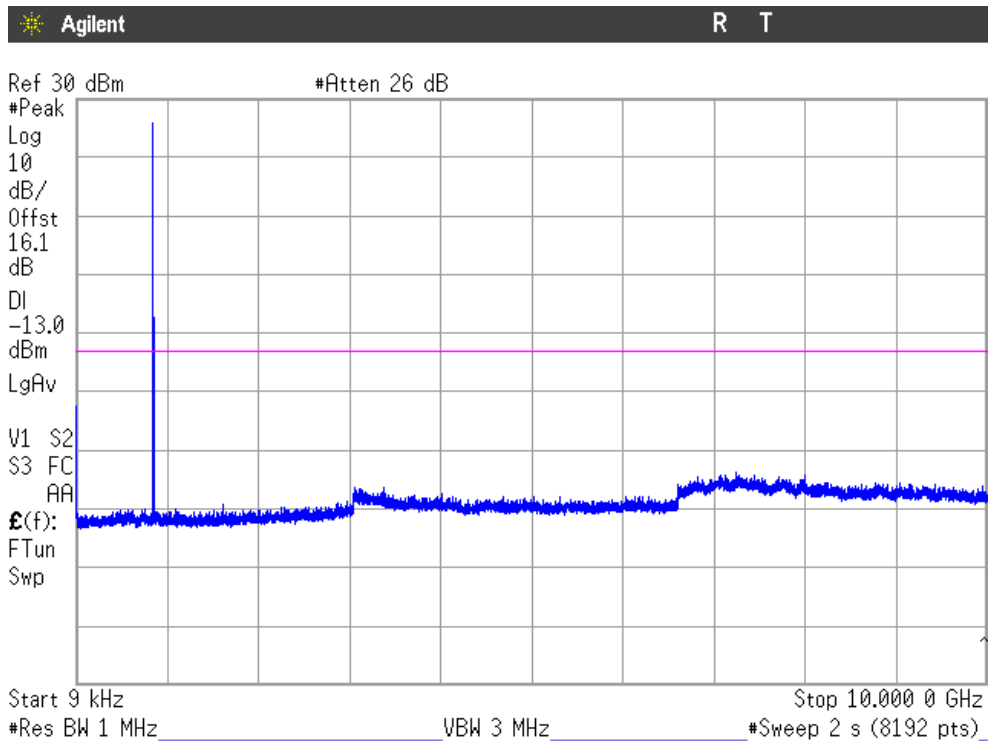

Note: The peak above the limit is the carrier frequency.

## Spurious emissions at antenna terminals at Block Edges

### SPECIFICATION

FCC §2.1051 and §22.917  
RSS-132. Clause 5.5.

The power of emissions shall be attenuated below the transmitter power (P) by a factor of at least  $43 + 10 \log (P)$  dB. P in watts.

FCC §90.691. Emission mask requirements for EA-based systems. Out-of-band emission requirement shall apply only to the “outer” channels included in an EA license and to spectrum adjacent to interior channels used by incumbent licensees. The emission limits are as follows:

(1) For any frequency removed from the EA licensee's frequency block by up to and including 37.5 kHz, the power of any emission shall be attenuated below the transmitter power (P) in watts by at least  $116 \text{ Log}_{10}(f/6.1)$  decibels or  $50 + 10 \text{ Log}_{10}(P)$  decibels or 80 decibels, whichever is the lesser attenuation, where f is the frequency removed from the center of the outer channel in the block in kilohertz and where f is greater than 12.5 kHz.

(2) For any frequency removed from the EA licensee's frequency block greater than 37.5 kHz, the power of any emission shall be attenuated below the transmitter power (P) in watts by at least  $43 + 10 \text{ Log}_{10}(P)$  decibels or 80 decibels, whichever is the lesser attenuation, where f is the frequency removed from the center of the outer channel in the block in kilohertz and where f is greater than 37.5 kHz.

### METHOD

The EUT RF output connector was connected to a spectrum analyser and to the Universal Radio Communication tester R&S CMW500 (selecting maximum transmission power of the EUT and different modes of modulation) using a 50 ohm attenuator and a power splitter.

The reading of the spectrum analyser is corrected with the attenuation loss of connection between output terminal of EUT and input of the spectrum analyser.

The configuration of modulation which is the worst case for conducted power was used.

As indicated in FCC part 22, in the 1 MHz bands immediately outside and adjacent to the frequency block or band a resolution bandwidth of at least one percent of the emission bandwidth of the fundamental emission of the transmitter may be employed.

Measurement Limit:

According to specification. the power of emissions shall be attenuated below the transmitter power (P) by a factor of at least  $43 + 10 \log (P)$  dB. P in watts.

At  $P_o$  transmitting power. the specified minimum attenuation becomes  $43+10\log (P_o)$ . and the level in dBm relative  $P_o$  becomes:

$$P_o \text{ (dBm)} - [43 + 10 \log (P_o \text{ in mwatts}) - 30] = - 13 \text{ dBm}$$

### TEST SETUP

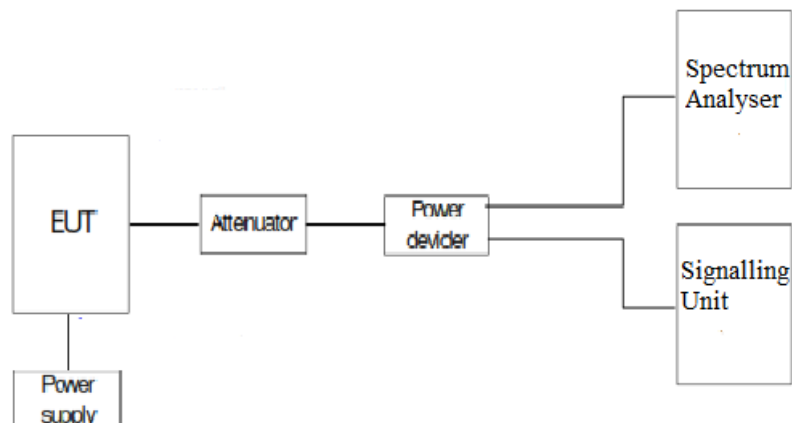

RESULTS (see plots in next pages)

**824-849MHz Band:**

Preliminary measurements determined the narrow band = 1 and nominal bandwidth of 1.4 MHz as the worst case. The results in the next tables shows the results for this configuration.

(Channels in Band 5):	RB=1. Offset=0. Narrow band = 1 BW=1.4 MHz	RB= All. Offset=0. Narrow band = 1 BW=1.4 MHz
Maximum measured level at lowest Block Edge at antenna port (dBm)	-17.22	-25.66

(Channels in Band 5):	RB= 1. Offset=Max. Narrow band = 1 BW=1.4 MHz	RB= All. Offset=0. Narrow band = 1 BW=1.4 MHz
Maximum measured level at highest Block Edge at antenna port (dBm)	-20.07	-27.14

Measurement uncertainty =  $\pm 1.20$  dB.

Verdict: PASS

**814-824MHz Band “EA MASK”:**

Narrow band = 1. RB = 1. Offset = 0. BW = 1.4 MHz

CHANNEL LOWEST

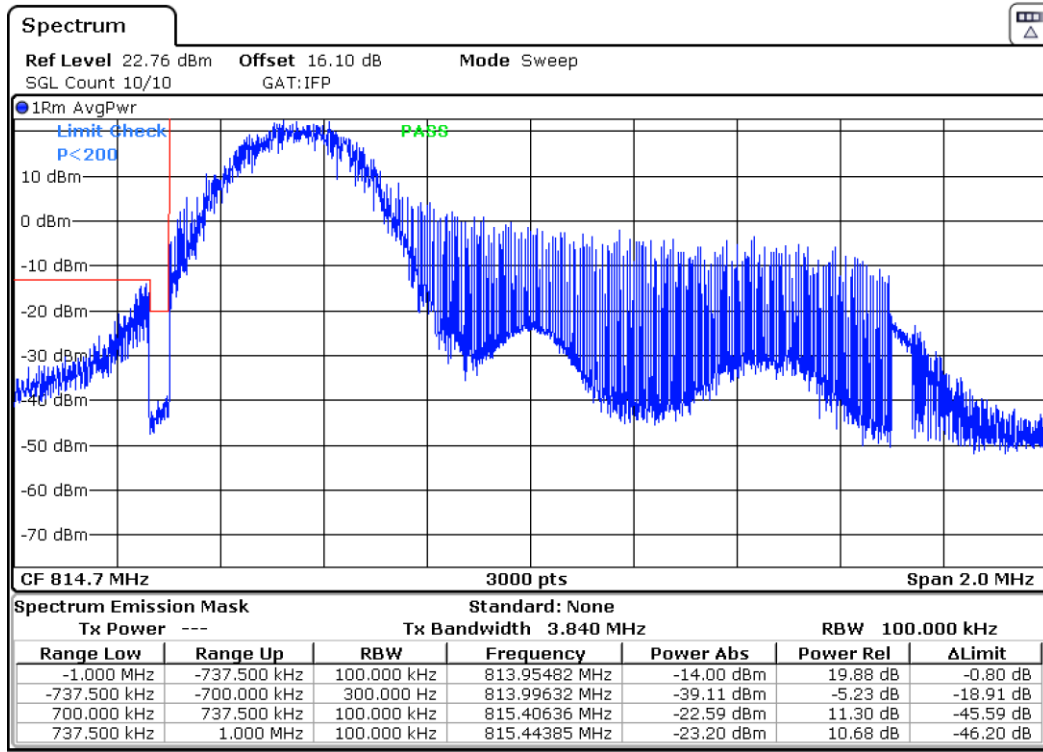

NOTE: The equipment transmits at the maximum output power

Narrow band = 1. RB = 1. Offset = Max. BW = 1.4 MHz

CHANNEL HIGHEST

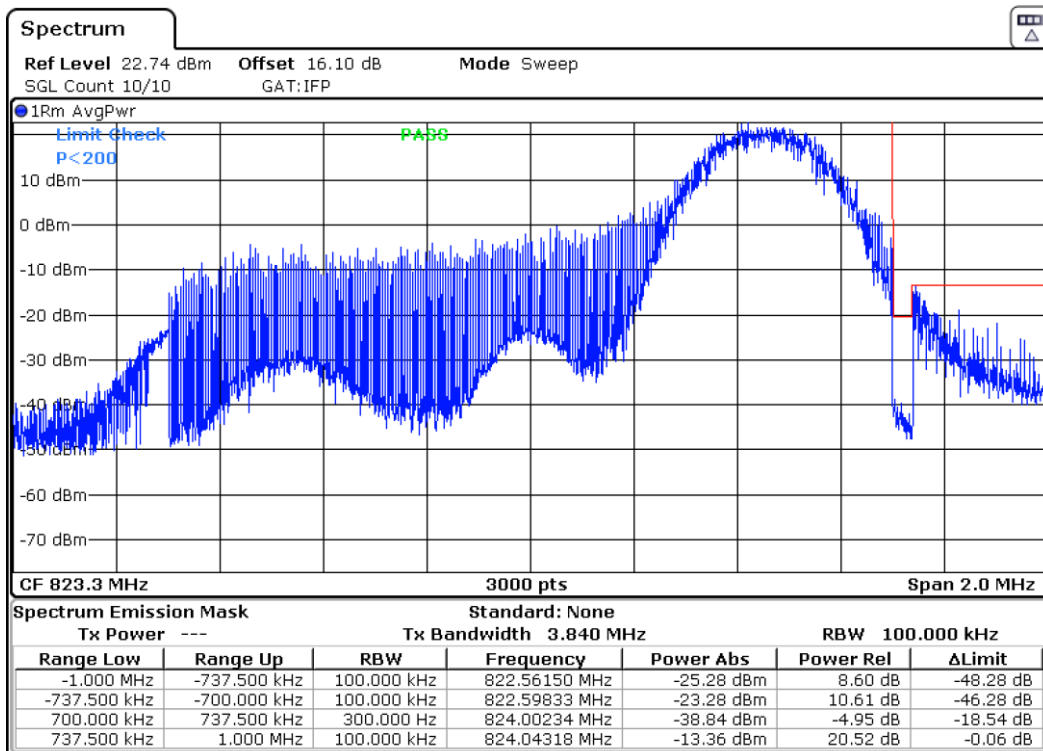

Narrow band = 1. RB = All. Offset = 0. BW = 1.4 MHz

CHANNEL LOWEST

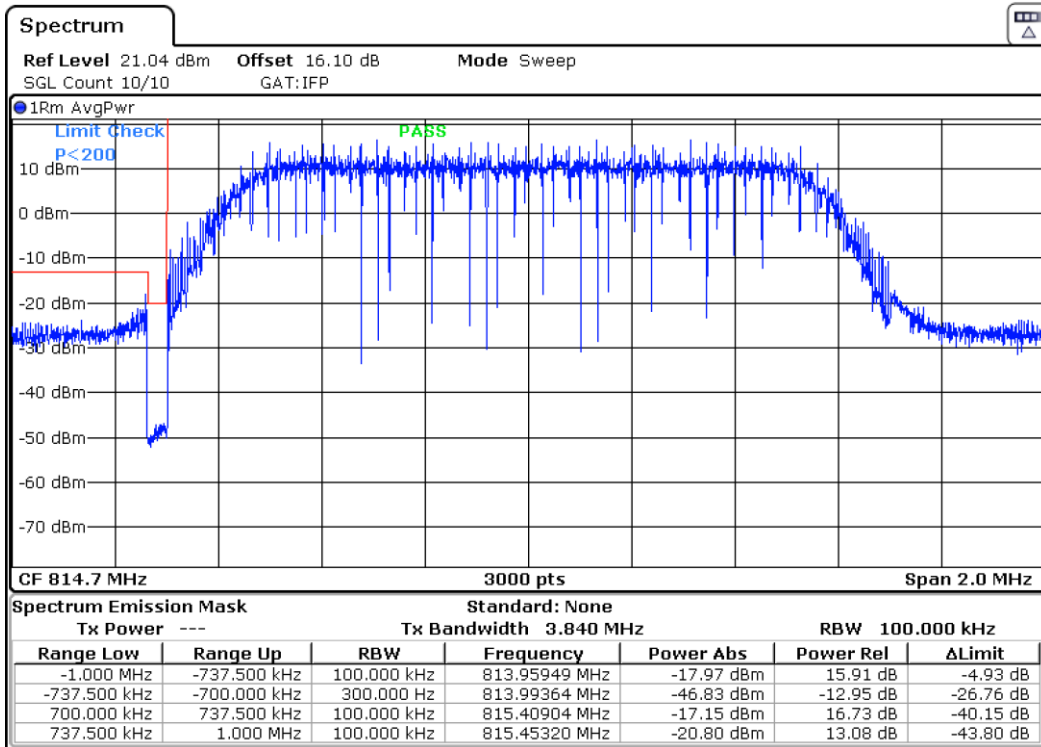

NOTE: The equipment transmits at the maximum output power

Narrow band = 1. RB = All. Offset = 0. BW = 1.4 MHz

CHANNEL HIGHEST

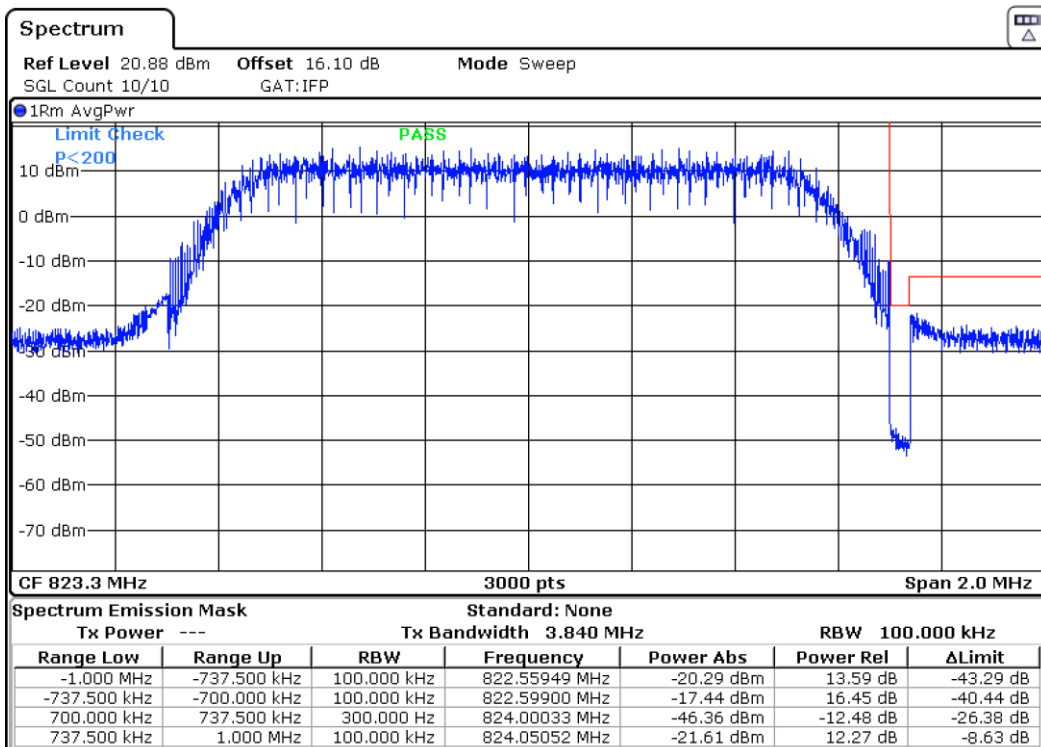

NOTE: The equipment transmits at the maximum output power

Verdict: PASS



**824-849MHz Band:**

Narrow band = 1. RB = 1. Offset = 0. BW = 1.4 MHz

**CHANNEL LOWEST**

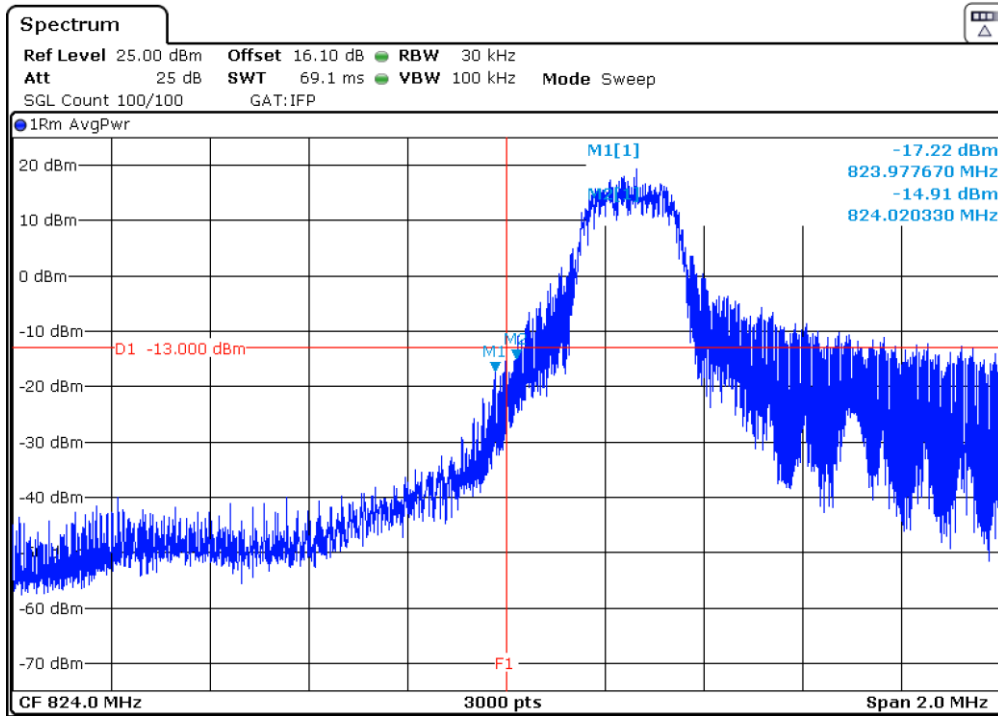

NOTE: The equipment transmits at the maximum output power

Narrow band = 1. RB = 1. Offset = Max. BW = 1.4 MHz

**CHANNEL HIGHEST**

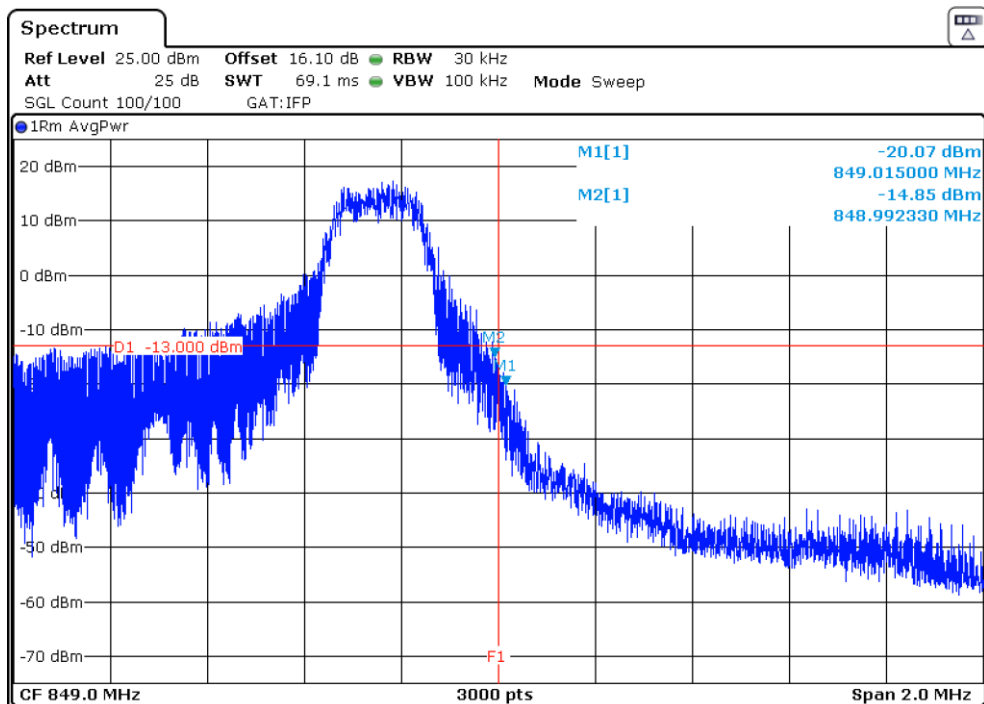

Narrow band = 1. RB = All. Offset = 0. BW = 1.4 MHz

CHANNEL LOWEST

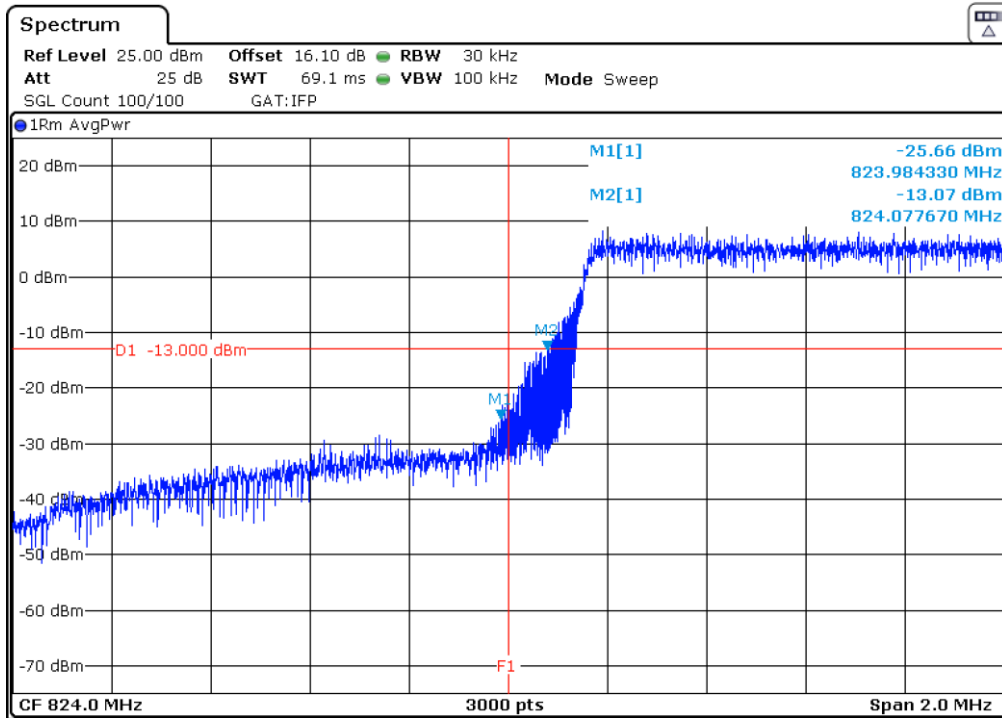

NOTE: The equipment transmits at the maximum output power

Narrow band = 1. RB = All. Offset = 0. BW = 1.4 MHz

CHANNEL HIGHEST

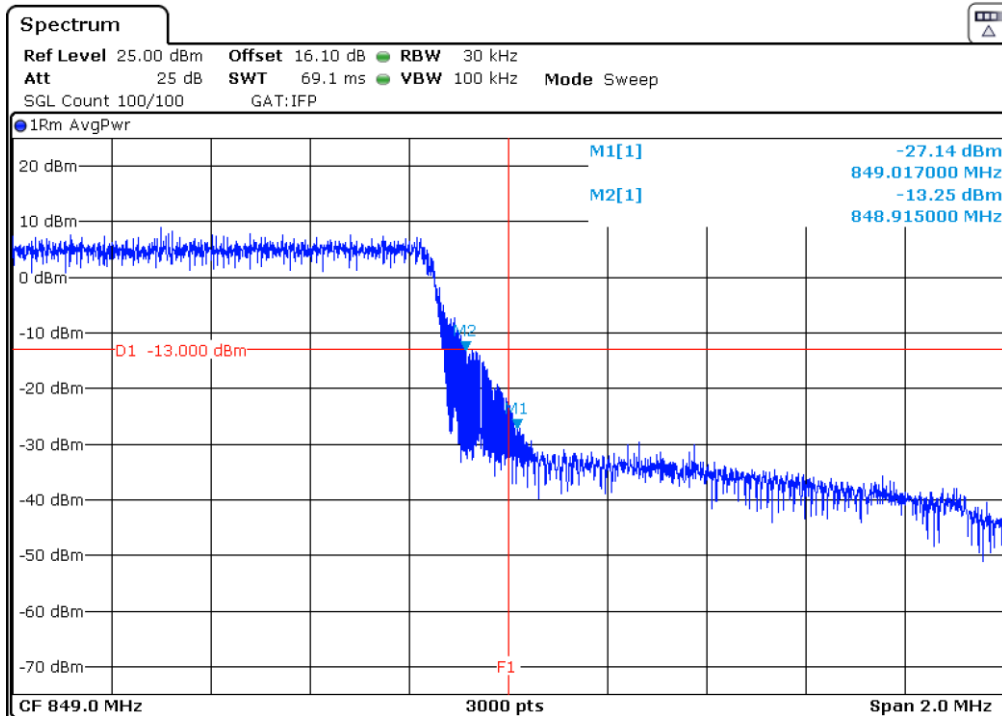

NOTE: The equipment transmits at the maximum output power

Verdict: PASS

## Radiated emissions

### SPECIFICATION

FCC § 22.917

RSS-132. Clause 5.5.

FCC §2.1051, §90.691

Emission mask requirements for EA-based systems.

For any frequency removed from the EA licensee's frequency block greater than 37.5 kHz, the power of any emission shall be attenuated below the transmitter power (P) in watts by at least  $43 + 10\log_{10}(P)$  decibels or 80 decibels, whichever is the lesser attenuation, where f is the frequency removed from the center of the outer channel in the block in kilohertz and where f is greater than 37.5 kHz.

### METHOD

The measurement was performed with the EUT inside an anechoic chamber. The spectrum was scanned from 30 MHz to at least the 10th harmonic of the highest frequency generated within the equipment.

The EUT was placed on a 1 meter high non-conductive stand at a 3 meter distance from the measuring antenna for measurements below 1 GHz and at 1 m distance for measurements above 1 GHz.

Detected emissions were maximized at each frequency by rotating the EUT and adjusting the measuring antenna height and polarization. The maximum meter reading was recorded. The radiated emissions were measured with peak detector and 1 MHz bandwidth.

Each detected emission is substituted by the Substitution method, in accordance with the ANSI/TIA/EIA-603-C: 2004.

Measurement Limit:

According to specification. the power of emissions shall be attenuated below the transmitter power (P) by a factor of at least  $43 + 10 \log (P)$  dB. P in watts.

At  $P_o$  transmitting power. the specified minimum attenuation becomes  $43+10\log (P_o)$ . and the level in dBm relative  $P_o$  becomes:

$$P_o \text{ (dBm)} - [43 + 10 \log (P_o \text{ in mwatts}) - 30] = - 13 \text{ dBm}$$

**TEST SETUP**

Radiated measurements below 1 GHz.

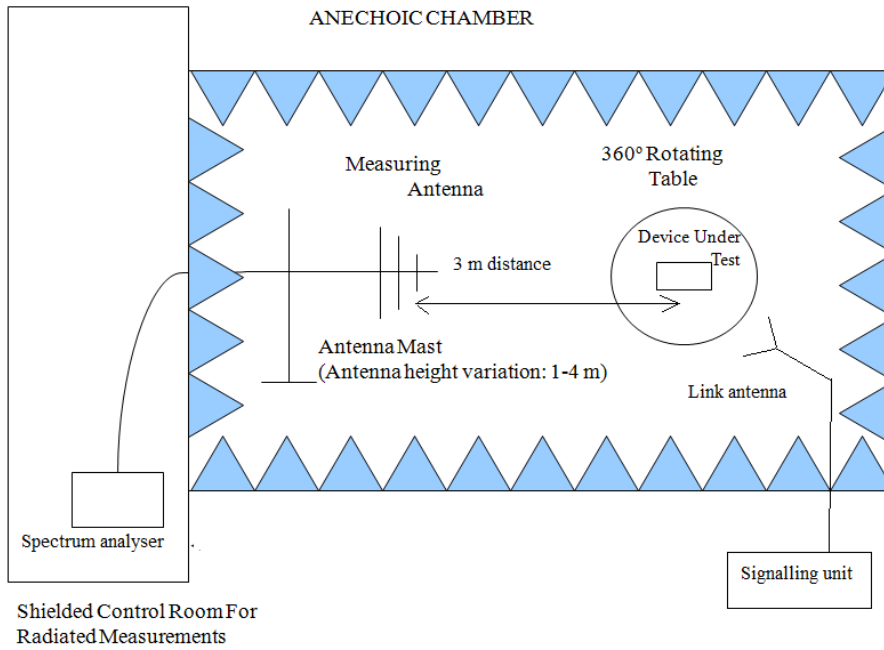

Radiated measurements above 1 GHz.

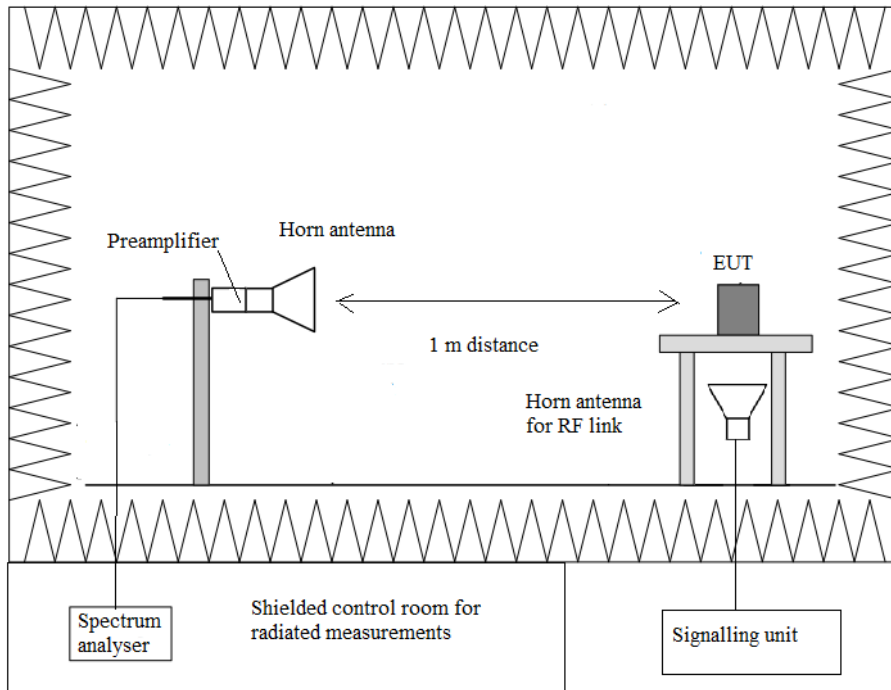

## RESULTS

### **814-824MHz Band:**

LTE QPSK AND 16QAM MODULATION. BW = 1.4 MHz, 3 MHz, 5 MHz, 10 MHz.

A preliminary scan determined the QPSK modulation with 5 MHz bandwidth as the worst case. The configuration of Resource Blocks which is the worst case for conducted power was used.

The following tables and plots show the results for this configuration.

#### 1. CHANNEL: LOWEST

##### **Frequency range 30 MHz-1000 MHz.**

No radiated spurious signals were detected at less than 20 dB respect to the limit.

##### **Frequency range 1 GHz-10 GHz.**

No radiated spurious signals were detected at less than 20 dB respect to the limit.

#### 2. CHANNEL: HIGHEST

##### **Frequency range 30 MHz-1000 MHz.**

No radiated spurious signals were detected at less than 20 dB respect to the limit.

##### **Frequency range 1 GHz-10 GHz.**

No radiated spurious signals were detected at less than 20 dB respect to the limit.

Verdict: PASS

### **824-849MHz Band:**

LTE QPSK AND 16QAM MODULATION. BW = 1.4 MHz, 3 MHz, 5 MHz, 10 MHz and 15MHz.

A preliminary scan determined the QPSK modulation with 3 MHz bandwidth as the worst case. The configuration of Resource Blocks which is the worst case for conducted power was used.

The following tables and plots show the results for this configuration.

#### 1. CHANNEL: LOWEST

##### **Frequency range 30 MHz-1000 MHz.**

No radiated spurious signals were detected at less than 20 dB respect to the limit.

##### **Frequency range 1 GHz-10 GHz.**

No radiated spurious signals were detected at less than 20 dB respect to the limit.

#### 2. CHANNEL: MIDDLE

##### **Frequency range 30 MHz-1000 MHz.**

No radiated spurious signals were detected at less than 20 dB respect to the limit.

##### **Frequency range 1 GHz-10 GHz.**

No radiated spurious signals were detected at less than 20 dB respect to the limit.

#### 3. CHANNEL: HIGHEST

##### **Frequency range 30 MHz-1000 MHz.**

No radiated spurious signals were detected at less than 20 dB respect to the limit.

##### **Frequency range 1 GHz-10 GHz.**

No radiated spurious signals were detected at less than 20 dB respect to the limit.

Verdict: PASS

**814-824MHz Band:**

**FREQUENCY RANGE 30 MHz-1000 MHz.**

**LTE QPSK MODULATION. BW=5 MHz**

**CHANNEL: LOWEST**

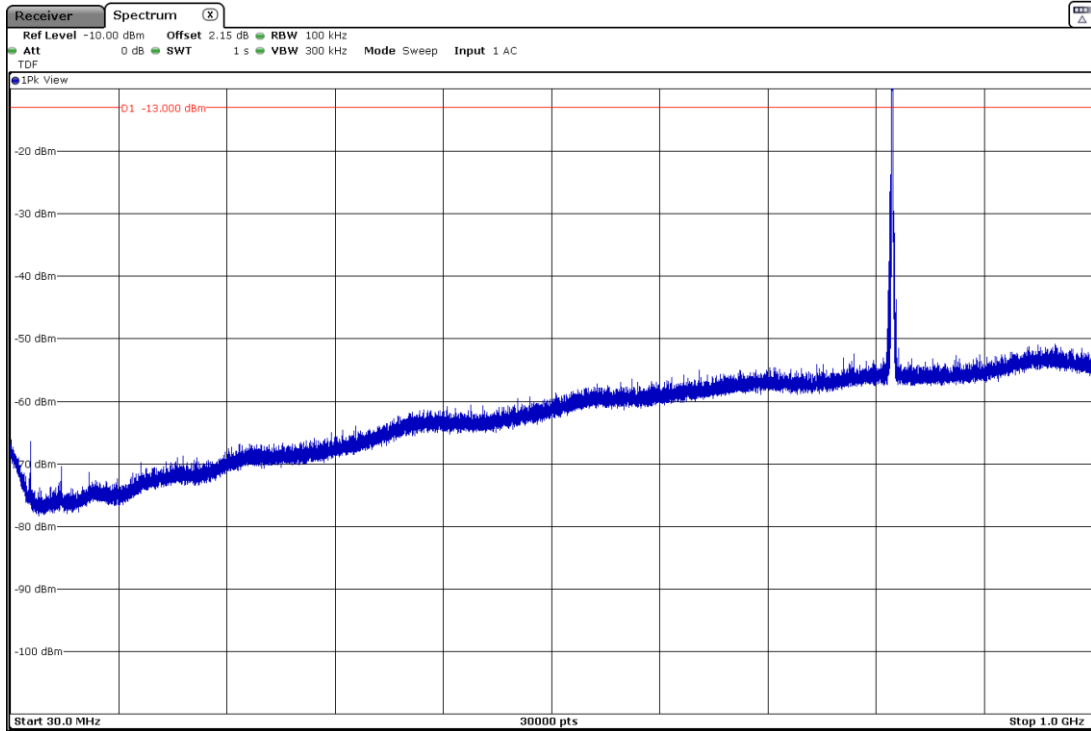

Note: The peak above the limit is the carrier frequency.

**CHANNEL: HIGHEST**

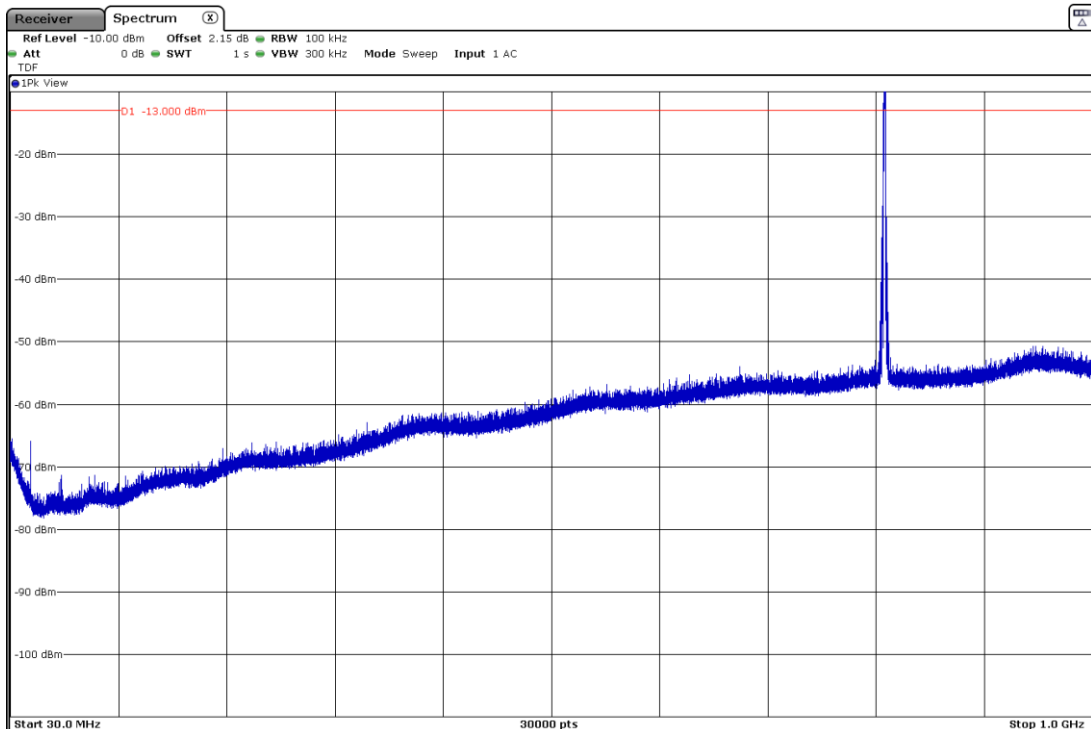

Note: The peak above the limit is the carrier frequency.

FREQUENCY RANGE 1 GHz to 10 GHz.

**LTE QPSK MODULATION. BW=5 MHz**

CHANNEL: LOWEST

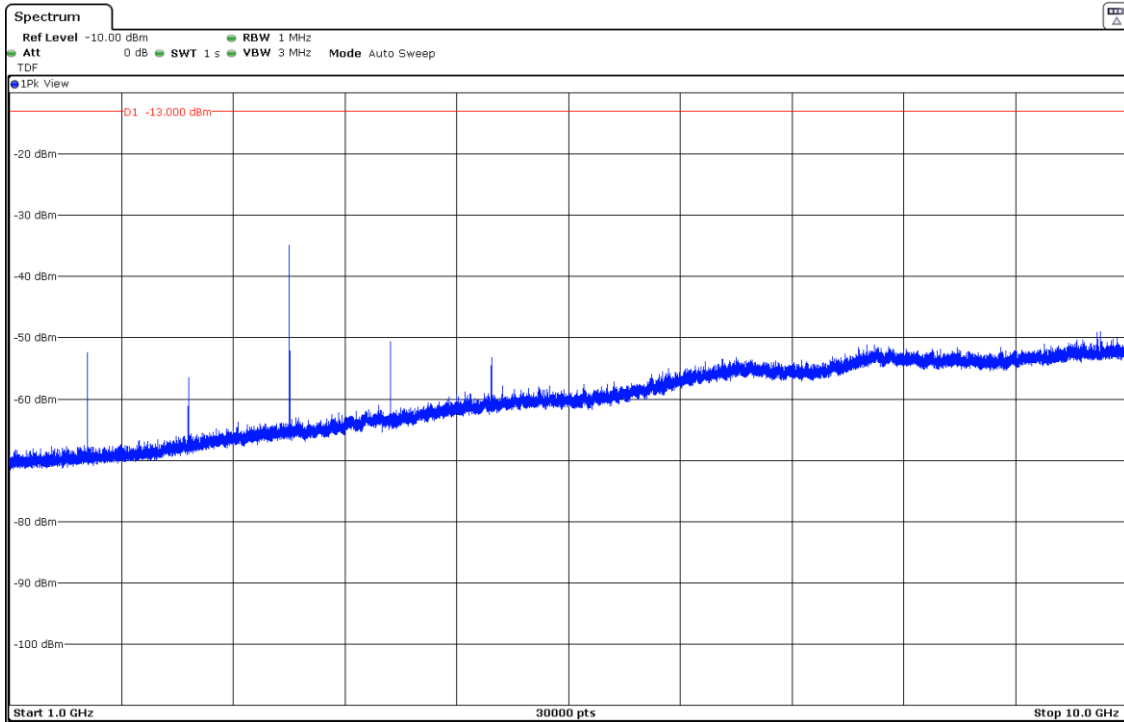

CHANNEL: HIGHEST

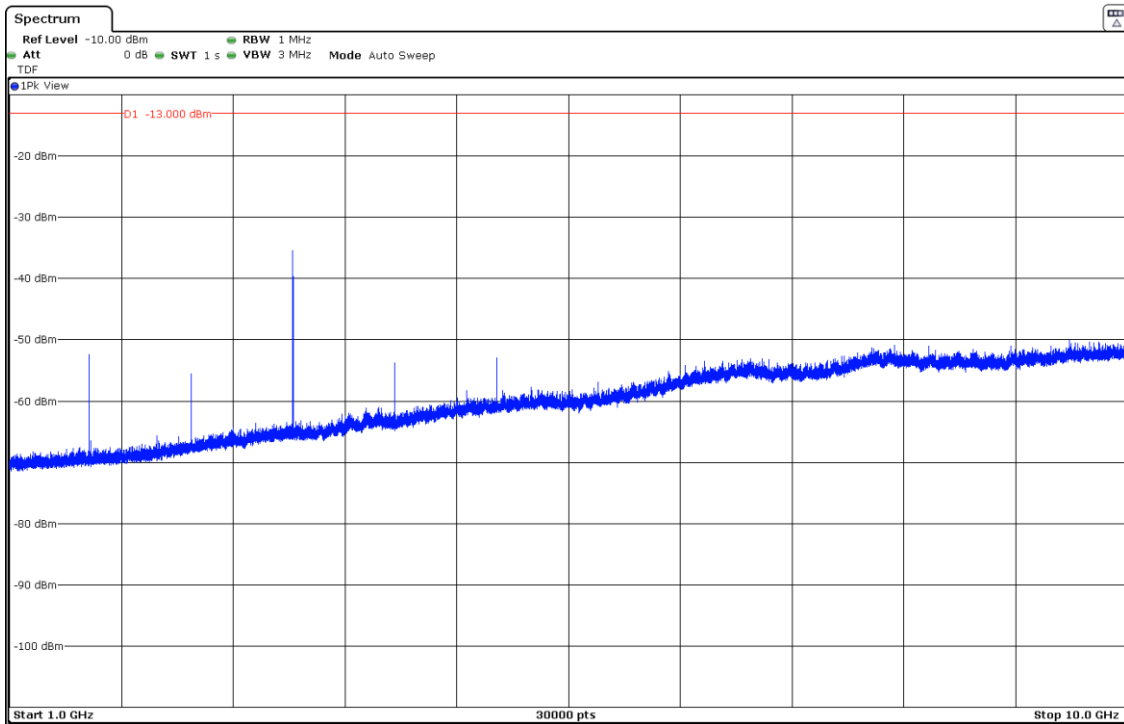



**824-849MHz Band:**

**FREQUENCY RANGE 30 MHz-1000 MHz.**

**LTE QPSK MODULATION. BW=3 MHz**

**CHANNEL: LOWEST**

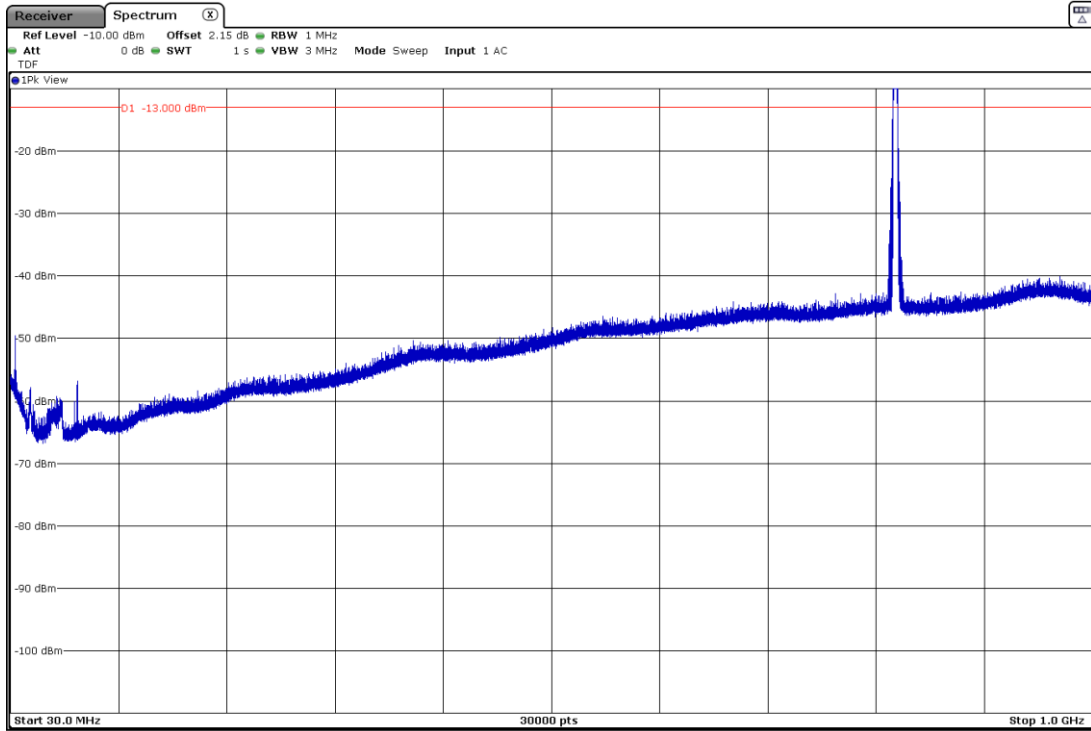

Note: The peak above the limit is the carrier frequency.

**CHANNEL: MIDDLE**

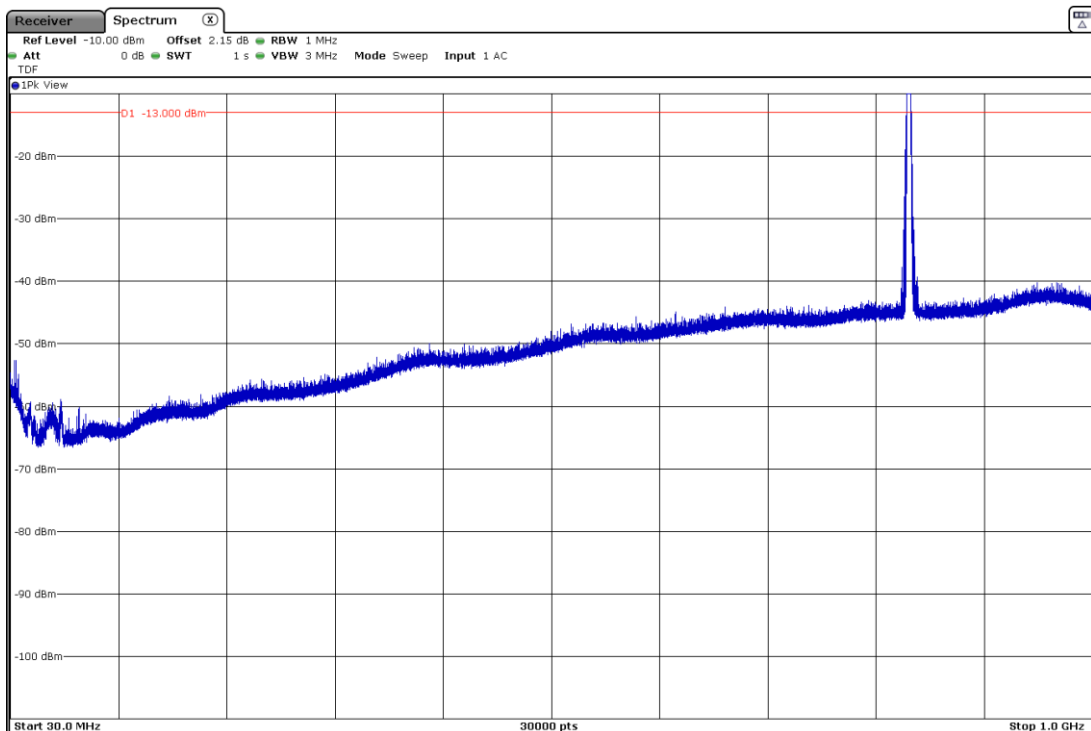

Note: The peak above the limit is the carrier frequency.

CHANNEL: HIGHEST

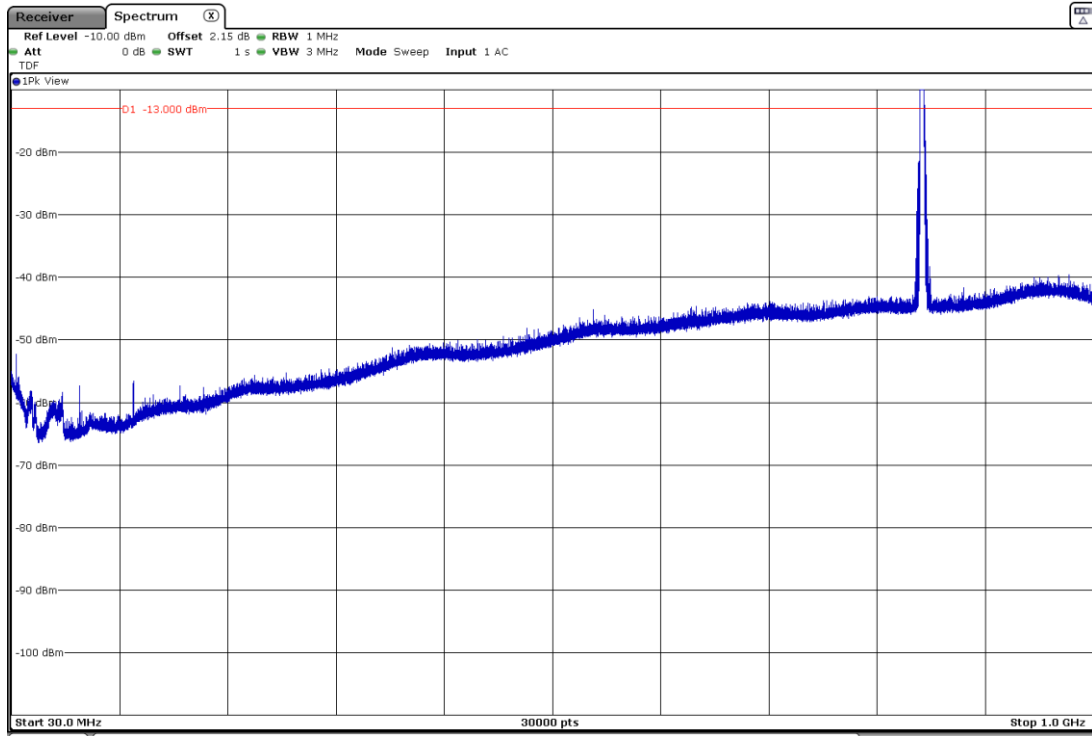

Note: The peak above the limit is the carrier frequency.

FREQUENCY RANGE 1 GHz to 10 GHz.

**LTE QPSK MODULATION. BW=3 MHz**

CHANNEL: LOWEST

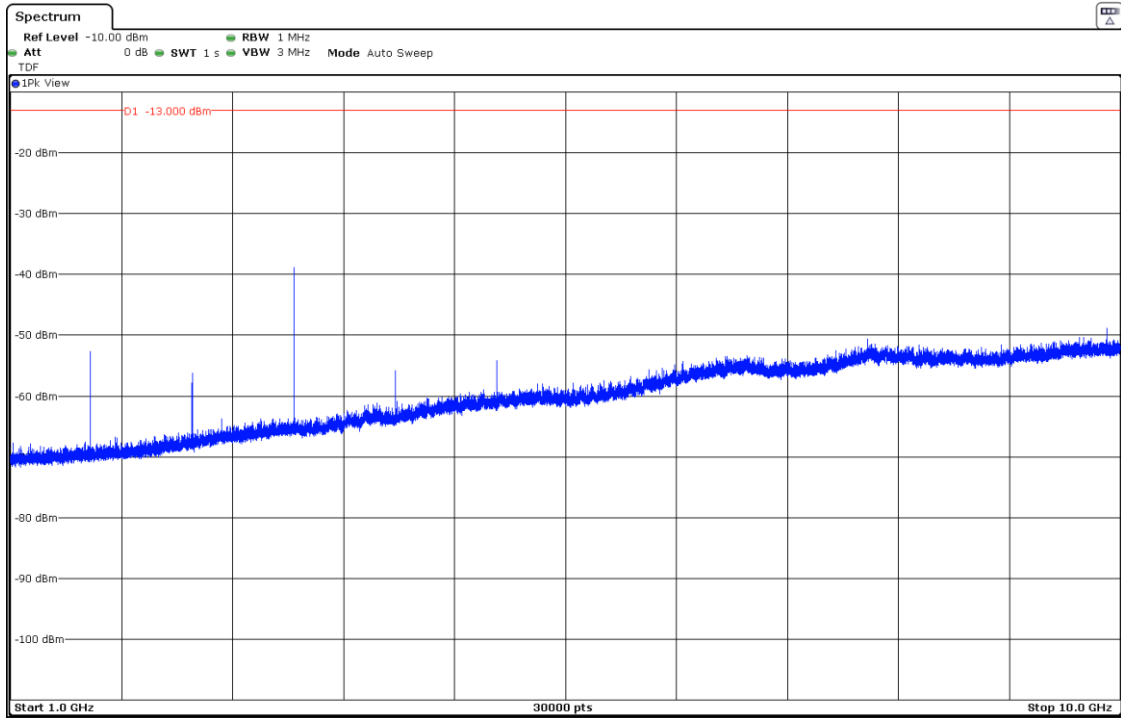

CHANNEL: MIDDLE

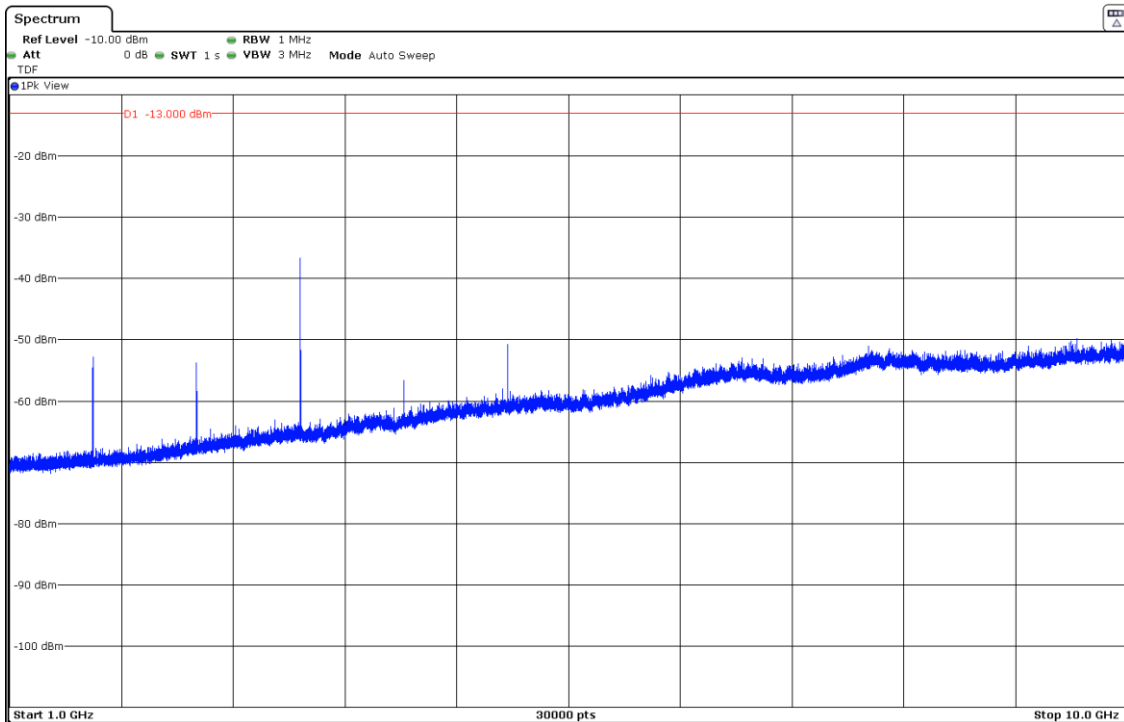

CHANNEL: HIGHEST

