

  <p>ENSAYOS Nº 51/LE147</p>	FCC LISTED, REGISTRATION NUMBER: 720267	Test report No: NIE: 59675RRF.001
	ISED LISTED REGISTRATION NUMBER ISED 4621A-4	

Test report
REFERENCE STANDARD:
USA FCC Part 24 & Part 27
CANADA IC RSS-130, RSS-133, RSS-139

Identification of item tested	IOT Module
Trademark	nRF91
Model and /or type reference	nRF9160
Other identification of the product	FCC ID: 2ANPO00NRF9160 IC: 24529-NRF9160 IMEI TAC: 35265610
Features	LTE Cat-M1, LTE-NB1, GPS
Applicant	Nordic Semiconductor ASA Otto Nielsens Vei 12, 7052 Trondheim, NORWAY
Test method requested, standard	USA FCC Part 24 10-1-18 Edition. USA FCC Part 27 10-1-18 Edition. CANADA IC RSS-130 Issue 1, Oct. 2013. CANADA IC RSS-133 Issue 6, Jan. 2013. CANADA IC RSS-139 Issue 3, Jul. 2015. ANSI C63.26 – 2015.
Summary	IN COMPLIANCE
Approved by (name / position & signature)	A. Llamas RF Lab. Manager
Date of issue	2019-05-15
Report template No	FDT08_21

Index

Competences and guarantees	3
General conditions	3
Uncertainty	3
Usage of samples	4
Data provided by the client.....	4
Test sample description	4
Identification of the client.....	6
Testing period and place.....	6
Document history	6
Environmental conditions	6
Remarks and comments	7
Testing verdicts.....	8
Summary	8
Appendix A: Test results for FCC Part 24 / RSS-133	9
Appendix B: Test results for FCC Part 27 / RSS-139 / RSS-130	41

Competences and guarantees

DEKRA Testing and Certification is a testing laboratory accredited by the National Accreditation Body (ENAC - Entidad Nacional de Acreditación), to perform the tests indicated in the Certificate No. 51/LE 147.

DEKRA Testing and Certification is a laboratory with a measurement facility in compliance with the requirements of Section 2.948 of the FCC rules and has been added to the list of facilities whose measurements data will be accepted in conjunction with applications for Certification under Parts 15 or 18 of the Commission's Rules. Registration Number: 720267.

DEKRA Testing and Certification is a laboratory with a measurement site in compliance with the requirements of RSS 212, Issue 1 (Provisional) and has been added to the list of filed sites of the Canadian Certification and Engineering Bureau. Reference File Number: ISED 4621A-4.

In order to assure the traceability to other national and international laboratories, DEKRA Testing and Certification has a calibration and maintenance program for its measurement equipment.

DEKRA Testing and Certification guarantees the reliability of the data presented in this report, which is the result of the measurements and the tests performed to the item under test on the date and under the conditions stated on the report and, it is based on the knowledge and technical facilities available at DEKRA Testing and Certification at the time of performance of the test.

DEKRA Testing and Certification is liable to the client for the maintenance of the confidentiality of all information related to the item under test and the results of the test.

The results presented in this Test Report apply only to the particular item under test established in this document.

IMPORTANT: No parts of this report may be reproduced or quoted out of context, in any form or by any means, except in full, without the previous written permission of DEKRA Testing and Certification.

General conditions

1. This report is only referred to the item that has undergone the test.
2. This report does not constitute or imply on its own an approval of the product by the Certification Bodies or competent Authorities.
3. This document is only valid if complete; no partial reproduction can be made without previous written permission of DEKRA Testing and Certification.
4. This test report cannot be used partially or in full for publicity and/or promotional purposes without previous written permission of DEKRA Testing and Certification and the Accreditation Bodies.

Uncertainty

Uncertainty (factor $k=2$) was calculated according to the DEKRA Testing and Certification internal document PODT000.

Usage of samples

Samples undergoing test have been selected by: the client.

Sample S/01 is composed of the following elements:

Control Nº	Description	Model	Serial Nº	Date of reception
59678C/004	IOT Module	nRF9160	IMEI: 352656100030561	2019-01-15

1. Sample S/01 has undergone the following test(s):

All tests indicated in appendixes A and B.

Data provided by the client

The sample consist of a IOT Module that has Application CPU, LTE Cat-M1, Cat-NB1 Radio and GPS Receiver.

DEKRA declines any responsibility with respect to the information provided by the client and that may affect the validity of results.

Test sample description

Ports..... :	Port name and description	Cable				
		Specified length [m]	Attached during test	Shielded		
	LTE RF	2	<input checked="" type="checkbox"/>	<input checked="" type="checkbox"/>		
	GPS	2	<input checked="" type="checkbox"/>	<input checked="" type="checkbox"/>		
			<input type="checkbox"/>	<input type="checkbox"/>		
		<input type="checkbox"/>	<input type="checkbox"/>			
Supplementary information to the ports..... :	N/A					
Rated power supply	Voltage and Frequency	Reference poles				
		L1	L2	L3	N	PE
	<input type="checkbox"/>	AC:	<input type="checkbox"/>	<input type="checkbox"/>	<input type="checkbox"/>	<input type="checkbox"/>
	<input checked="" type="checkbox"/>	DC: 3.1 – 5.5Vdc.				
<input type="checkbox"/>	DC:					
Rated Power	1W					
Clock frequencies	32kHz, 32MHz					

Other parameters.....:	---		
Software version.....:	mfw_nrf9160_0.7.0-29.alpha		
Hardware version.....:	DEV2.1.6		
Dimensions in cm (L x W x D)	11x16x1.1mm		
Mounting position.....:	<input type="checkbox"/>	Table top equipment	
	<input type="checkbox"/>	Wall/Ceiling mounted equipment	
	<input type="checkbox"/>	Floor standing equipment	
	<input type="checkbox"/>	Hand-held equipment	
	<input checked="" type="checkbox"/>	Other: SMD Module	
Modules/parts	Module/parts of test item	Type	Manufacturer
	N/A		
Accessories (not part of the test item)	Description	Type	Manufacturer
	N/A		
	N/A		
	N/A		
Documents as provided by the applicant.....:	Description	File name	Issue date
	User manual	4418_1177-0.3.1-20180905-140910-nRF9160_Objective_Product_Spec	23-Oct-2018
	Cover markings	SiP marking	23-Oct-2018

Copy of marking plate:



Identification of the client

Nordic Semiconductor ASA
Otto Nielsens Vei 12, 7052 Trondheim, NORWAY

Testing period and place

Test Location	DEKRA Testing and Certification S.A.U.
Date (start)	2018-01-30
Date (finish)	2018-03-20

Document history

Report number	Date	Description
59675RRF.001	2019-05-15	First release

Environmental conditions

In the control chamber, the following limits were not exceeded during the test:

Temperature	Min. = 15 °C Max. = 35 °C
Relative humidity	Min. = 20 % Max. = 75 %

In the semianechoic chamber, the following limits were not exceeded during the test.

Temperature	Min. = 15 °C Max. = 35 °C
Relative humidity	Min. = 20 % Max. = 75 %

In the chamber for conducted measurements, the following limits were not exceeded during the test:

Temperature	Min. = 15 °C Max. = 35 °C
Relative humidity	Min. = 20 % Max. = 35 %

Remarks and comments

The tests have been performed by the technical personnel: José Alberto Aranda.

Used instrumentation:

Conducted Measurements

	Last Cal. date	Cal. due date
1. Spectrum analyser Agilent E4440A	2017/10	2019/10
2. Vector signal analyzer Rohde & Schwarz FSQ8	2018/08	2020/08
3. Climatic chamber HERAEUS VM 04/35	2018/06	2020/06
4. DC power supply R&S NGPE 40/40	2018/02	2021/02
5. Universal Radio communication Tester R&S CMW50	2019/02	2020/02
6. Spectrum analyser Rohde & Schwarz FSV40	2017/07	2019/07

Radiated Measurements

	Last Cal. date	Cal. due date
1. Semianechoic Absorber Lined Chamber ETS FACT3 200STP	N.A.	N.A.
2. BiconicalLog antenna ETS LINDGREN 3142E	2017/09	2020/09
3. Multi Device Controller MESSTECHNIK DAV-RR	N.A.	N.A.
4. Double-ridge Guide Horn antenna 1-18 GHz SCHWARZBECK BBHA 9120 D	2018/01	2021/01
5. Broadband Horn antenna 18-40 GHz SCHWARZBECK BBHA 9170	2018/07	2021/07
6. Spectrum analyser Rohde & Schwarz FSV40	2018/02	2020/02
7. EMI Test Receiver R&S ESU26	2018/02	2020/02
8. RF pre-amplifier 1-18 GHz Bonn Elektronik BLMA 0118-3A	2019/04	2020/04
9. RF pre-amplifier 18-40 GHz NARDA JS44-18004000-33-8P	2019/02	2020/02
10. RF pre-amplifier 30-6 GHz Bonn Elektronik BLMA 0160-01N	2019/02	2020/08

Testing verdicts

Not applicable :	N/A
Pass :	P
Fail :	F
Not measured :	N/M

Summary

FCC PART 24/IC RSS-133 PARAGRAPH		
Requirement – Test case	Verdict	Remark
Clause 24.232/RSS-133 Clause 6.4: RF output power	P	
Clause 2.1047/RSS-133 Clause 6.2: Modulation characteristics	P	
Clause 24.235/RSS-133 Clause 6.3: Frequency stability	P	
Clause 2.1049: Occupied Bandwidth	P	
Clause 24.238/RSS-133 Clause 6.5: Spurious emissions at antenna terminals	P	
Clause 24.238/RSS-133 Clause 6.5: Radiated emissions	P	
<u>Supplementary information and remarks:</u>		
None		

FCC PART 27 / RSS-139 / RSS-130 PARAGRAPH		
Requirement – Test case	Verdict	Remark
Clause 27.50 / RSS-139 Clause 6.5. / RSS-130 Clause 4.4.: RF output power	P	
Clause 2.1047 / RSS-139 Clause 6.2. / RSS-130 Clause 4.1.: Modulation characteristics	P	
Clause 27.54 / RSS-139 Clause 6.4. / RSS-130 Clause 4.3.: Frequency stability	P	
Clause 2.1049: Occupied Bandwidth	P	
Clause 27.53 / RSS-139 Clause 6.6. / RSS-130 Clause 4.6.: Spurious emissions at antenna terminals	P	
Clause 27.53 / RSS-139 Clause 6.6. / RSS-130 Clause 4.6.: Radiated emissions	P	
<u>Supplementary information and remarks:</u>		
None.		

Appendix A: Test results for FCC Part 24 / RSS-133

INDEX

TEST CONDITIONS.....	11
RF Output Power	12
Frequency Stability	16
Modulation Characteristics	20
Occupied Bandwidth	22
Spurious emissions at antenna terminals.....	26
Spurious emissions at antenna terminals at Block Edges.....	30
Radiated emissions.....	34

TEST CONDITIONS

Power supply (V):

Vnominal = 3.8 Vdc

Vmax = 4.37 Vdc

Vmin = 3.23 Vdc

The subscripts nom, min and max indicate voltage test conditions (nominal, minimum and maximum respectively, as declared by the applicant).

Type of power supply = DC Voltage from external power supply

Type of antenna = Integral antenna.

Declared Gain for antenna = +4.4 dBi.

TEST FREQUENCIES:

LTE. QPSK AND 16QAM MODULATION (BAND 2)

	Channel (Frequency. MHz)					
	BW = 1.4 MHz	BW = 3 MHz	BW = 5 MHz	BW = 10 MHz	BW = 15 MHz	BW = 20 MHz
Lowest	18607 (1850.7)	18615 (1851.5)	18625 (1852.5)	18650 (1855.0)	18675 (1857.5)	18700 (1860.0)
Middle	28900 (1880.0)	28900 (1880.0)	28900 (1880.0)	28900 (1880.0)	28900 (1880.0)	28900 (1880.0)
Highest	19193 (1909.3)	19185 (1908.5)	19175 (1907.5)	19150 (1905.0)	19125 (1902.5)	19100 (1900.0)

NOTE: Band 2 is completely included in band 25, so the channels of band 25 were tested to give conformity to the assigned block.

LTE. QPSK AND 16QAM MODULATION (BAND 25)

	Channel (Frequency. MHz)					
	BW = 1.4 MHz	BW = 3 MHz	BW = 5 MHz	BW = 10 MHz	BW = 15 MHz	BW = 20 MHz
Lowest	26047 (1850.70)	26055 (1851.5)	26065 (1852.5)	26090 (1855.0)	26115 (1857.5)	26140 (1860.0)
Middle	26365 (1882.5)	26365 (1882.5)	26365 (1882.5)	26365 (1882.5)	26365 (1882.5)	26365 (1882.5)
Highest	26683 (1914.3)	26675 (1913.5)	26665 (1912.5)	26640 (1910.0)	26615 (1907.50)	26590 (1905.0)

RF Output Power

SPECIFICATION

FCC §2.1046 and §24.232

Mobile/portable stations are limited to 2 Watts (33 dBm) Effective Isotropic Radiated Power (E.I.R.P.).
The peak-to-average ratio (PAR) of the transmission shall not exceed 13 dB.

RSS-133. Clause 6.4.

The peak-to-average power ratio (PAPR) shall not exceed 13 dB for more than 0.1% of the time using a signal corresponding to the highest PAPR during periods of continuous transmission.

METHOD

The conducted RF output power measurements were made at the RF output terminals of the EUT using the power meter of the Universal Radio Communication tester R&S CMW500, selecting maximum transmission power of the EUT and different modes of modulation.

The maximum equivalent isotropically radiated power (e.i.r.p.) is calculated by adding the declared maximum antenna gain (dBi).

The peak-to-average power ratio (PAPR) is measured using an attenuator, power splitter and spectrum analyser with a Complementary Cumulative Distribution Function implemented.

The EUT was controlled via the Universal Radio Communication tester R&S CMW500 selecting maximum transmission power of the EUT and different modes of modulation.

TEST SETUP

Conducted average power.



Peak-to-average power ratio (PAPR)

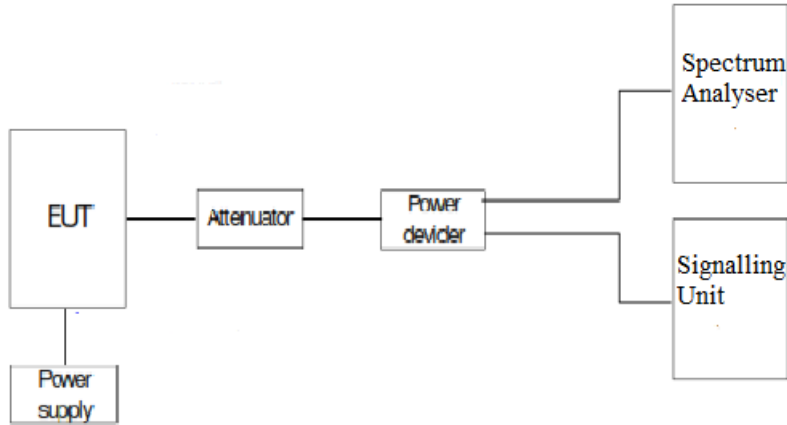

RESULTS

MAXIMUM OUTPUT POWER (CONDUCTED).

LTE. BAND 25.

Preliminary measurements determined the narrow band = 1 and nominal bandwidth of 3 MHz as the worst case. The results in the next tables shows the results for this configuration.

Narrow band = 1

BANDWIDTH (MHz)	CHANNEL	FREQUENCY (MHz)	MODULATION	RB SIZE	RB OFFSET	AVERAGE POWER (dBm)	PAPR (dB)
3	26055	1851.5	QPSK	1	0	22,86	4.66
			16-QAM	6	0	20,91	
	26365	1882.5	QPSK	1	0	21,52	5.26
			16-QAM	5	0	20,91	
	26675	1913.5	QPSK	1	0	22,99	4.54
			16-QAM	6	0	21,14	
			QPSK	1	0	21,99	5.1
			16-QAM	5	0	20,08	
			QPSK	1	0	22,98	4.41
			16-QAM	6	0	21,28	
			QPSK	1	0	21,94	5
			16-QAM	5	0	21,22	

PEAK-TO-AVERAGE POWER RATIO (PAPR).

LTE. BAND 25

Preliminary measurements determined the narrow band = 1, nominal bandwidth of 3 MHz, 16-QAM modulation and 5 RB size offset 0 as the worst case. The results in the next tables shows the results for this configuration.

Channel Low:

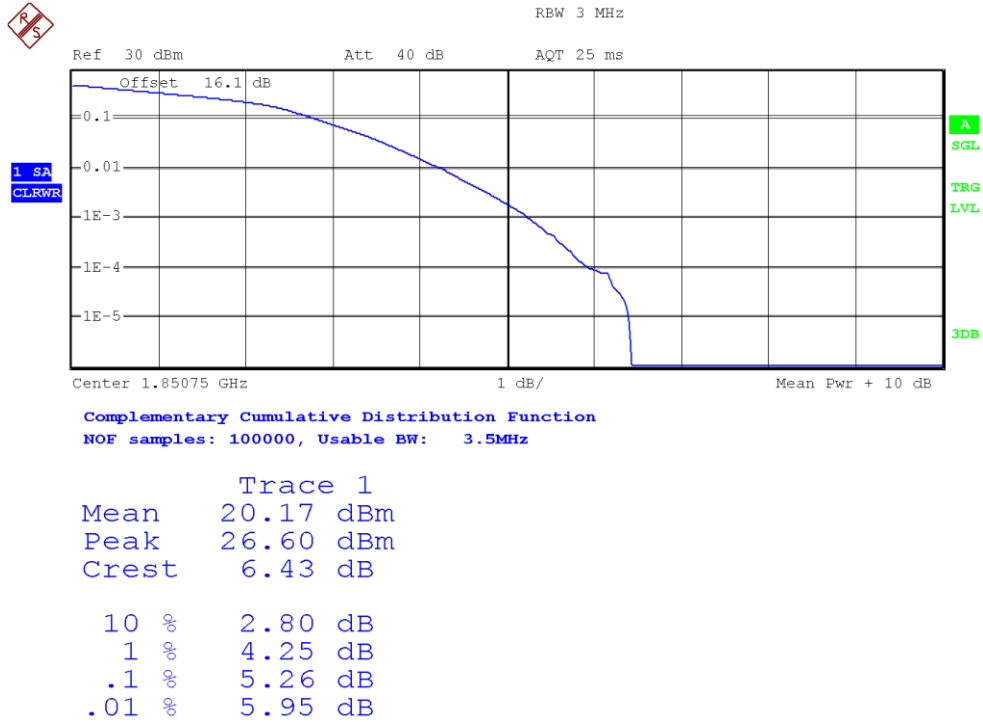

Channel Middle:

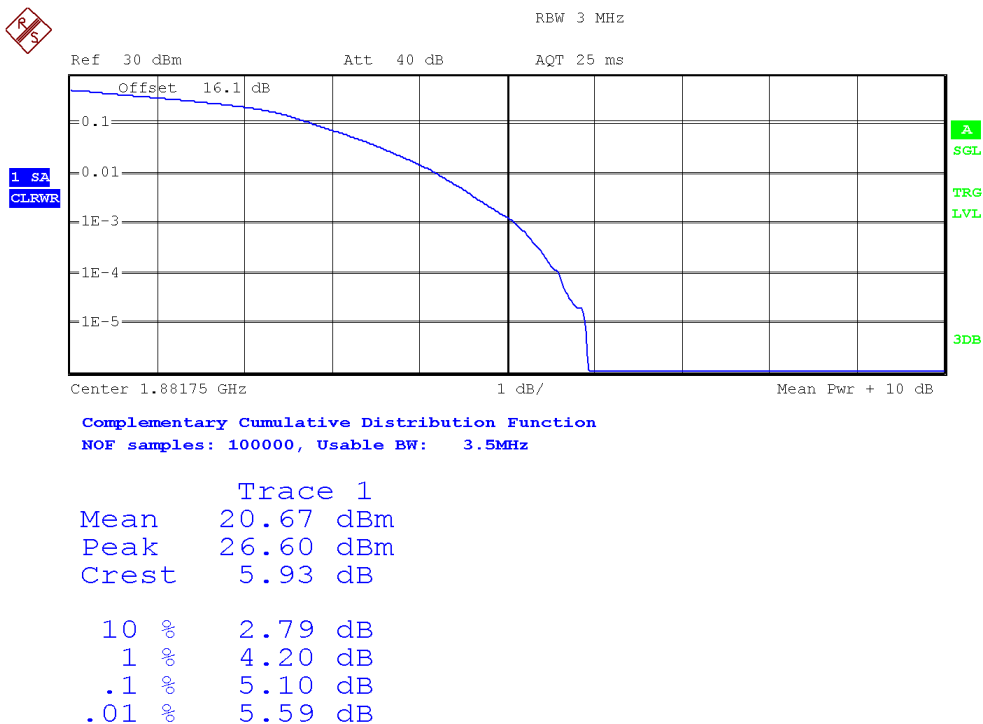

Channel High:

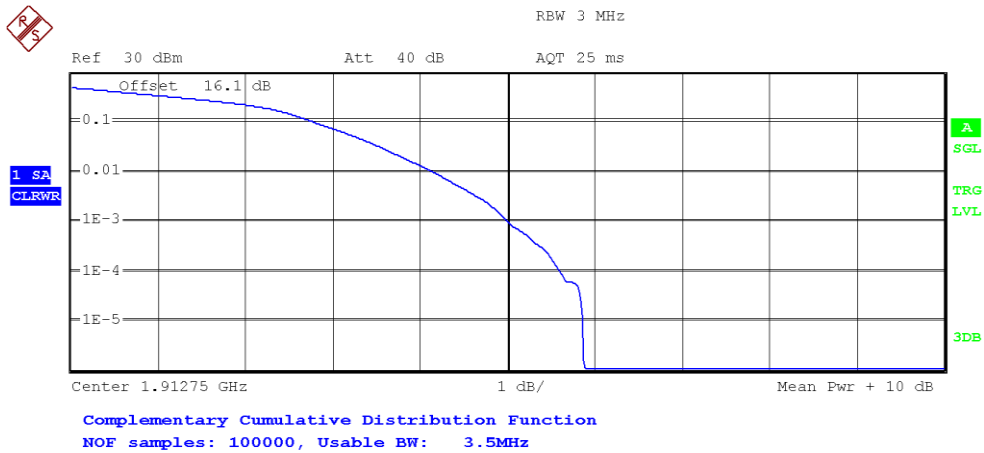

Trace 1	
Mean	21.01 dBm
Peak	26.88 dBm
Crest	5.87 dB
10 %	2.77 dB
1 %	4.15 dB
.1 %	5.00 dB
.01 %	5.61 dB

LTE BAND 25.

Channel	Measured maximum average power (dBm) at antenna port	Maximum declared antenna gain (dBi)	Maximum equivalent isotropically radiated power (E.I.R.P.) (dBm)	Maximum effective radiated power E.R.P. (dBm)	PAPR (dB)
Lowest	22.86	4.4	27.26	25.11	5.26
Middle	22.99	4.4	27.39	25.24	5.10
Highest	22.98	4.4	27.38	25.23	5.00
Measurement uncertainty (dB)	<±1.11				

Verdict: PASS

Frequency Stability

SPECIFICATION

FCC §2.1055 and §24.235. The frequency stability shall be sufficient to ensure that the fundamental emission stays within the authorized frequency block.

RSS-133. Clause 6.3. The carrier frequency shall not depart from the reference frequency in excess of ± 2.5 ppm for mobile stations.

METHOD

The frequency tolerance measurements over temperature variations were made over the temperature range of -30°C to $+50^{\circ}\text{C}$. The EUT was placed inside a climatic chamber and the temperature was raised hourly in 10°C steps from -30°C up to $+50^{\circ}\text{C}$.

The supply voltage was varied between 85% and 115% of nominal voltage.

The EUT was set in "Radio Resource Control (RRC) mode" in the middle channel using the Universal Radio Communication tester R&S CMW500 and the maximum frequency error was measured using the built-in calibrated frequency meter.

The worst case LTE mode for conducted power was used for the test.

In order to check that the frequency stability is sufficient such that the fundamental emissions stay within the authorized bands of operation, a reference point is established at the applicable unwanted emissions limit using a RBW equal to the RBW required by the unwanted emissions specification of the applicable regulatory standard. These reference points measured using the lowest and highest channel of operation are identified as fL and fH respectively. The worst-case frequency offset determined in the above methods is added or subtracted from the values of fL and fH to check that the resulting frequencies remain within the band.

The reference point measurements were made at the RF output terminals of the EUT using an attenuator, power splitter and spectrum analyser. The EUT was controlled via the Universal Radio Communication tester R&S CMW500 selecting maximum transmission power of the EUT and different modes of modulation.

TEST SETUP

Frequency tolerance.

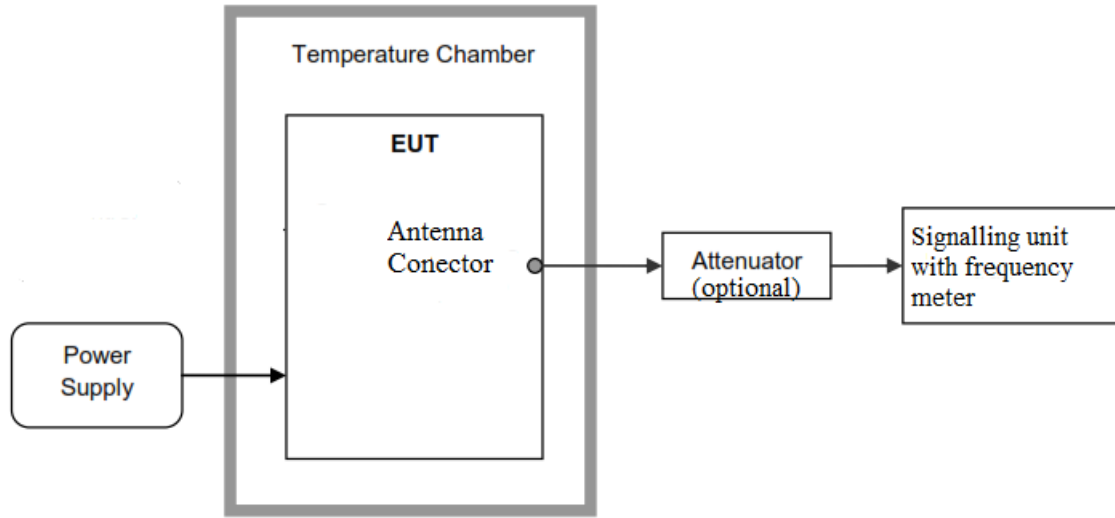

Reference points f_L and f_H .

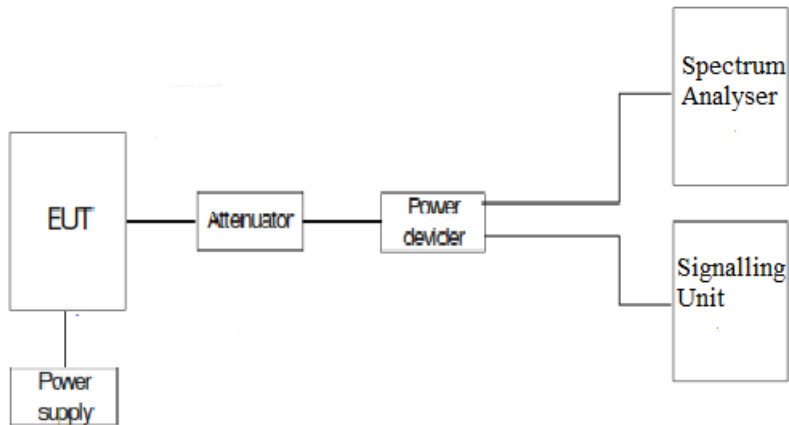

RESULTS

Frequency stability over temperature variations.

LTE Band 25

Temperature (°C)	Frequency Error (Hz)	Frequency Error (ppm)
+50	2,63	0,001397078
+40	-8,08	-0,004292165
+30	3,76	0,001997344
+20	-1,87	-0,00099336
+10	-6,54	-0,003474104
0	4,48	0,002379814
-10	-8,24	-0,004377158
-20	-2,7	-0,001434263
-30	-8,64	-0,004589641

Frequency stability over voltage variations.

LTE Band 25

Battery Supply voltage	Voltage (V)	Frequency Error (Hz)	Frequency Error (ppm)
Vmax	4.37	-11,07	-0,005880478
Vmin	3.23	-8,6	-0,004568393

Reference points established at the applicable unwanted emissions limit (worst case):

	LTE Band 25
f_L (MHz)	1850,0250
f_H (MHz)	1914,9850

Reference points f_L and f_H with the worst-case frequency offsets added or subtracted:

	LTE Band 25
f_L (MHz)	1850,0250
f_H (MHz)	1914,9850

The reference frequency points stay within the authorized blocks.

Verdict: PASS

Modulation Characteristics

SPECIFICATION

FCC §2.1047

RSS-133. Clause 6.2. Equipment certified under this standard shall use digital modulation.

METHOD

For LTE the EUT operates with QPSK and 16QAM modulation modes in which the information is digitised and coded into a bit stream. The RF transmission is multiplexed using *Orthogonal Frequency Division Multiplexing (OFDM)* using different possible arrangement of subcarriers (Resource Blocks RB).

TEST SETUP

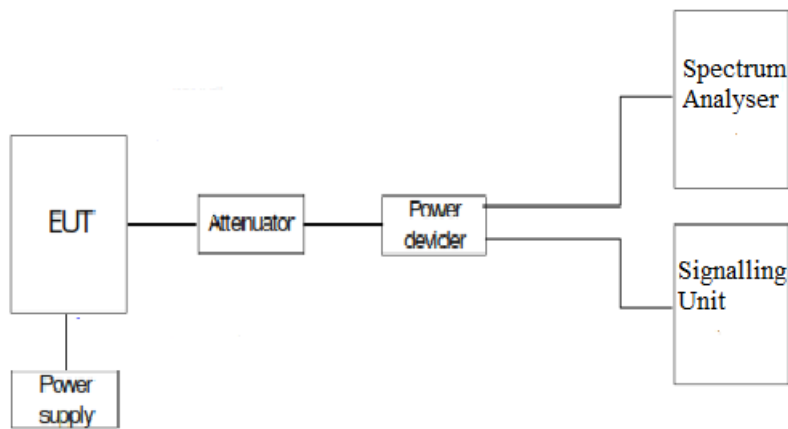

RESULTS

The following plot shows the modulation schemes in the EUT.

LTE MODULATION (Band 25). QPSK.

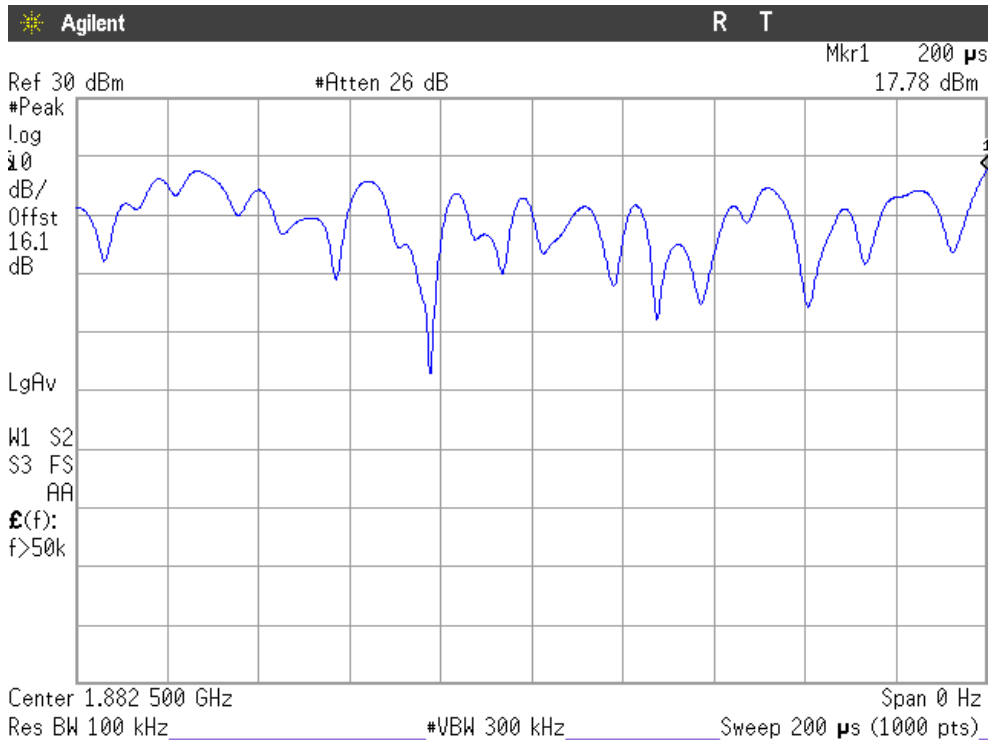

LTE MODULATION (Band 25). 16QAM.

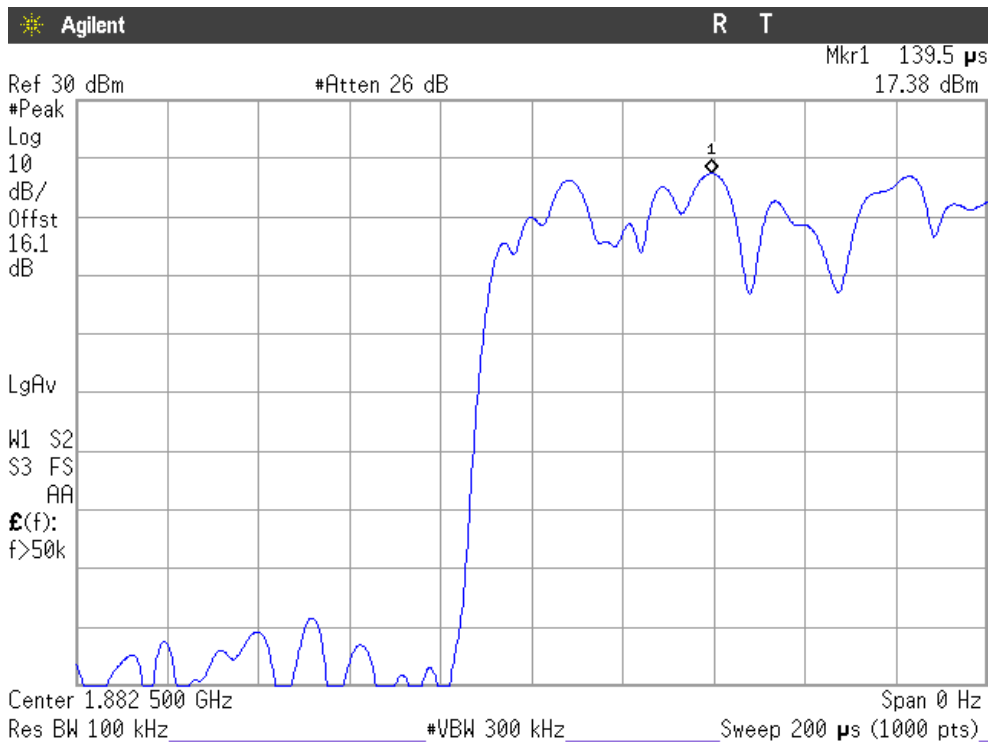

Occupied Bandwidth

SPECIFICATION

§2.1049

METHOD

The occupied bandwidth measurement was performed at the output terminals of the EUT using an attenuator, power splitter and spectrum analyser. The EUT was controlled via the Universal Radio Communication tester R&S CMW500 selecting maximum transmission power of the EUT and different modes of modulation. The 99% occupied bandwidth and the -26 dBc bandwidth were measured directly using the built-in bandwidth measuring option of spectrum analyser.

TEST SETUP

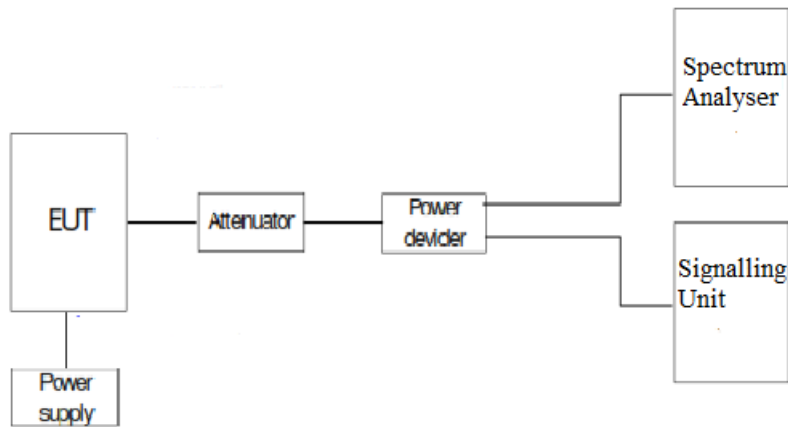

RESULTS (see next plots)

The worst case of occupied bandwidth corresponds to all Resource Blocks (RB) offset 0 regardless either the Narrow band position or the nominal bandwidth selected.

LTE QPSK MODULATION. BW = 1.4 MHz (Band 25). Narrow band: 1.

Channel	Lowest	Middle	Highest
99% Occupied bandwidth (MHz)	1.121	1.112	1.117
-26 dBc bandwidth (MHz)	1.440	1.493	1.446
Measurement uncertainty (kHz)	<±4.67		

LTE 16QAM MODULATION. BW = 1.4 MHz (Band 25). Narrow band: 1.

Channel	Lowest	Middle	Highest
99% Occupied bandwidth (KHz)	955.762	948.564	945.327
-26 dBc bandwidth (MHz)	1.425	1.319	1.332
Measurement uncertainty (kHz)	<±4.67		

LTE QPSK MODULATION. BW = 5 MHz (Band 25)

Lowest Channel

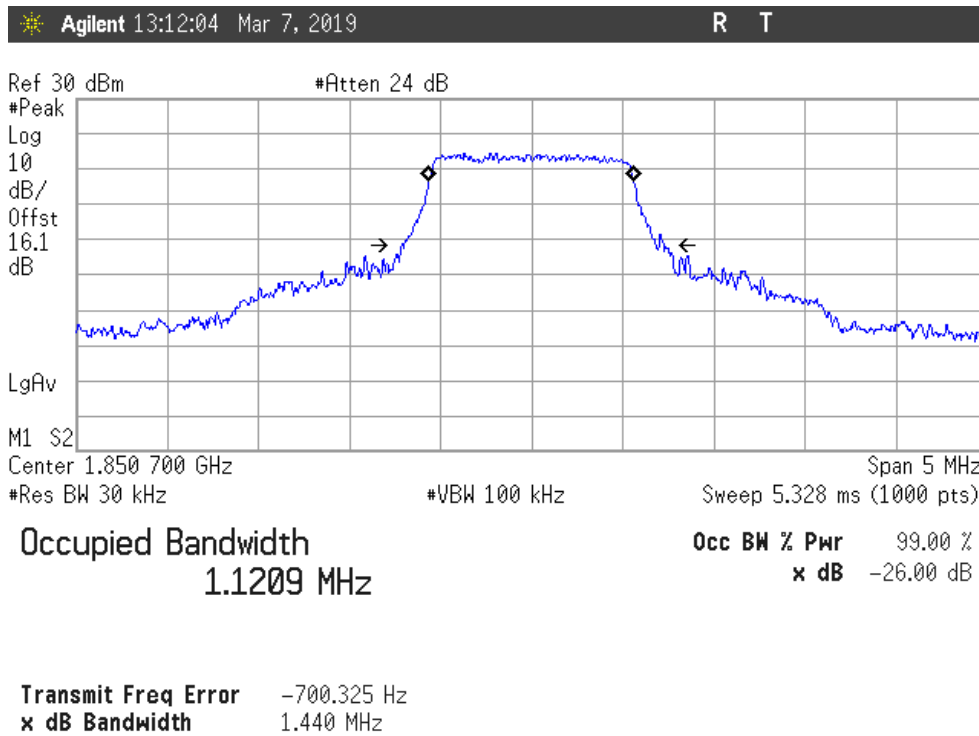

Middle Channel

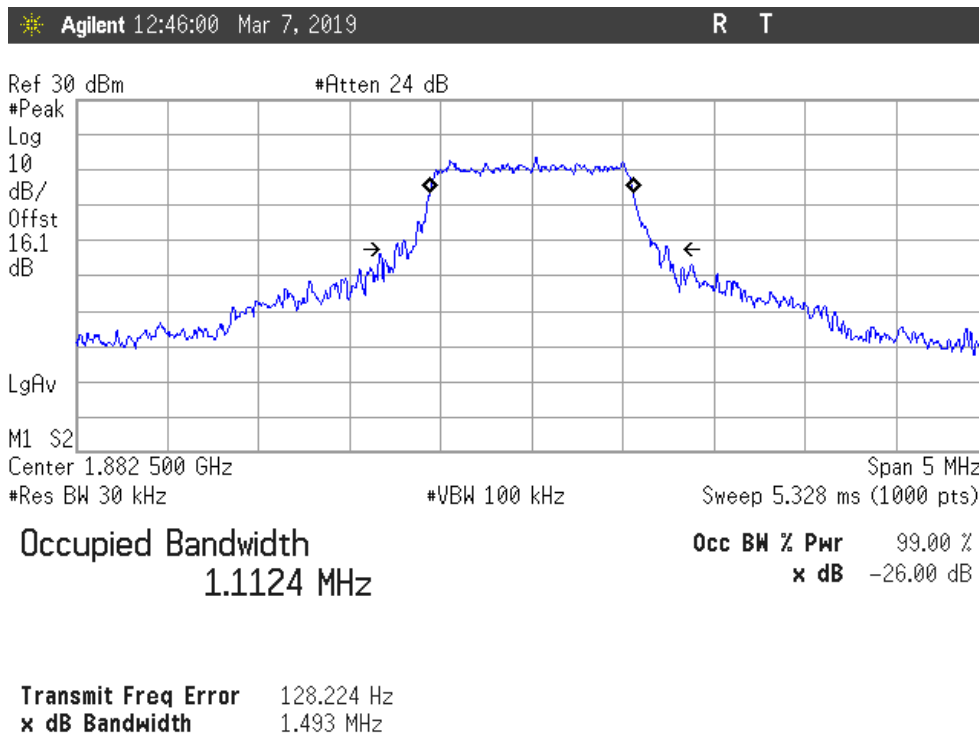

Highest Channel

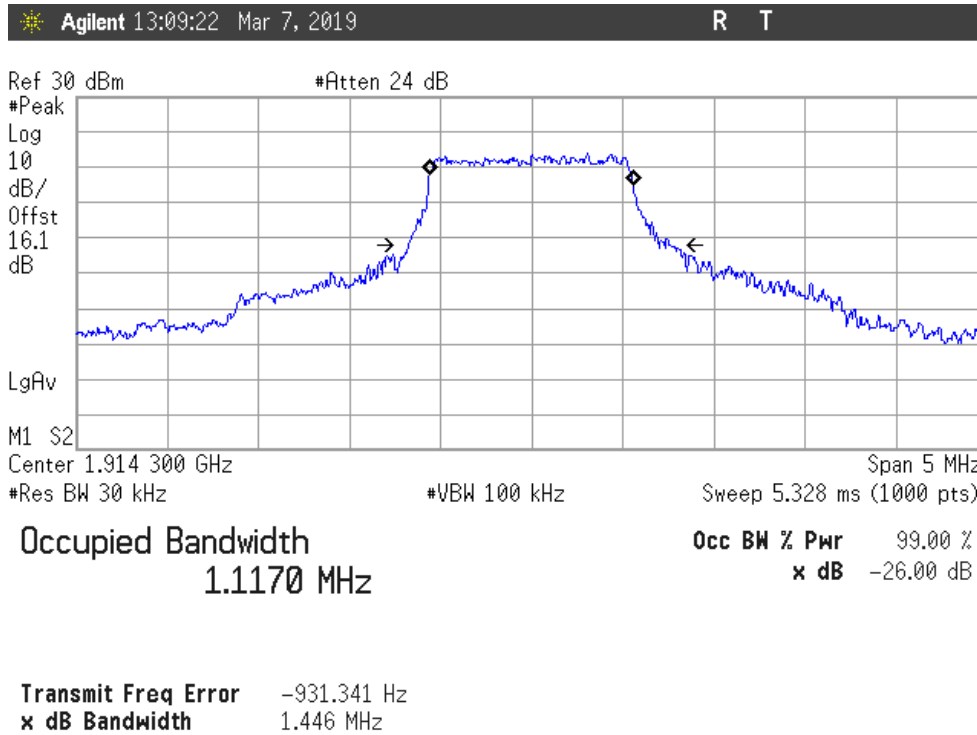

LTE 16QAM MODULATION. BW = 5 MHz (Band 25)

Lowest Channel

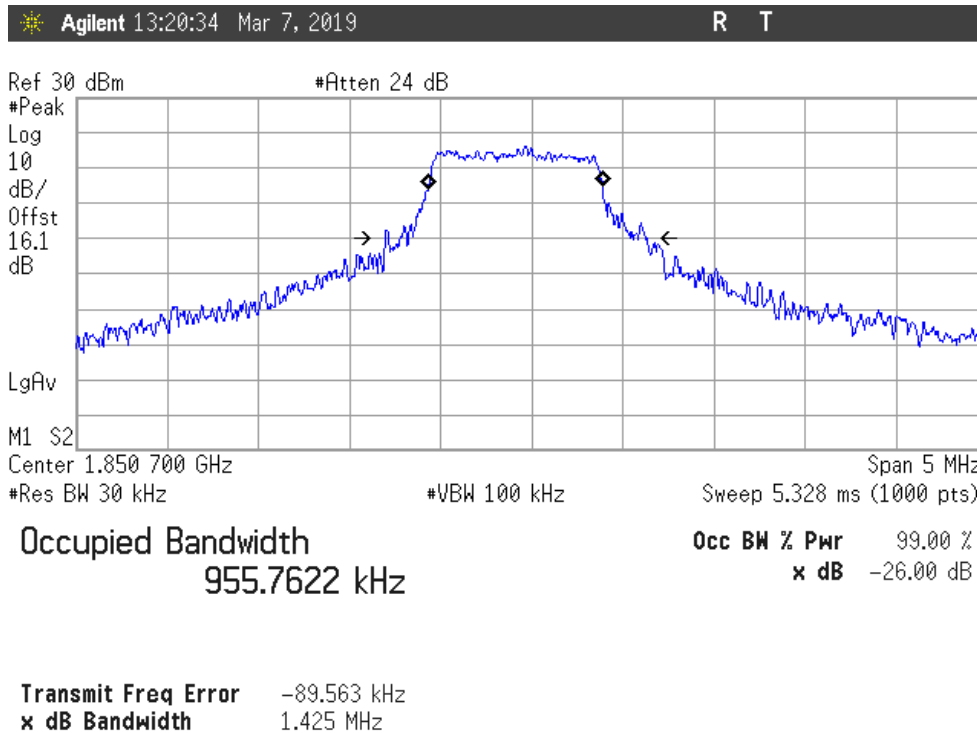

Middle Channel

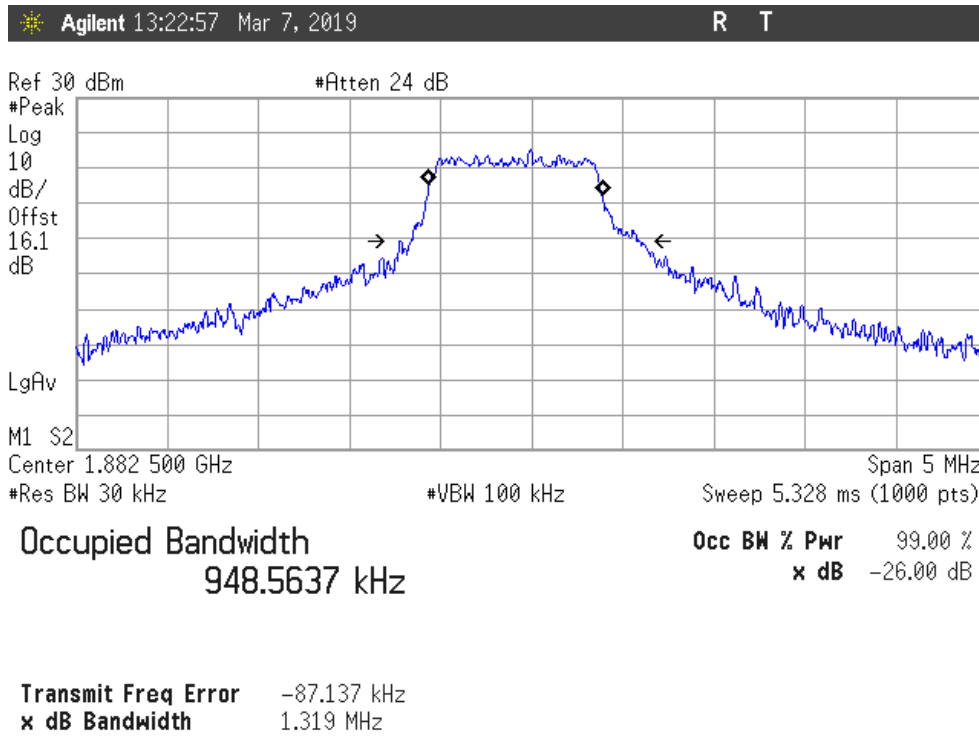

Highest Channel

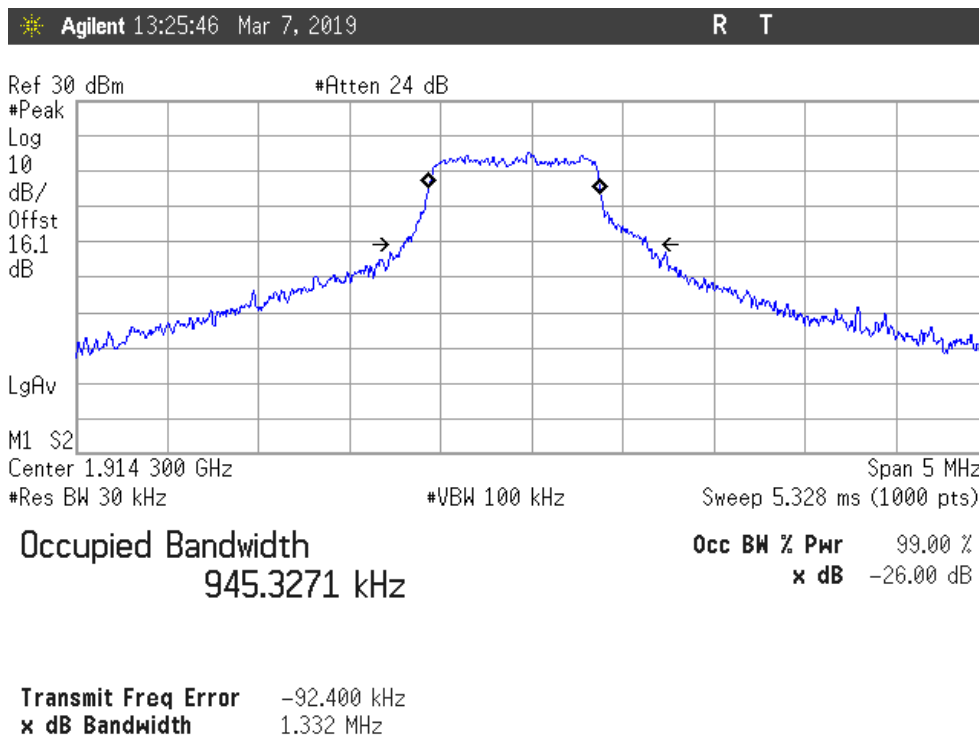

Spurious emissions at antenna terminals

SPECIFICATION

FCC §2.1051 and §24.238. RSS-133. Clause 6.5.

The power of emissions shall be attenuated below the transmitter power (P) by a factor of at least $43 + 10 \log (P)$ dB. P in watts.

At P_o transmitting power, the specified minimum attenuation becomes $43+10 \log (P_o)$, and the level in dBm relative P_o becomes:

$$P_o \text{ (dBm)} - [43 + 10 \log (P_o \text{ in mwatts}) - 30] = -13 \text{ dBm.}$$

METHOD

The EUT RF output connector was connected to a spectrum analyser and to the Universal Radio Communication tester R&S CMW500 (selecting maximum transmission power of the EUT and different modes of modulation) using a 50 ohm attenuator and a power divider.

The spectrum was investigated from 9 kHz to 20 GHz for LTE Band 25.

The reading of the spectrum analyser is corrected with the attenuation loss of connection between output terminal of EUT and input of the spectrum analyser.

The configuration of Resource Blocks and modulation which is the worst case for conducted power was used.

Measurement Limit:

According to specification. the power of emissions shall be attenuated below the transmitter power (P) by a factor of at least $43 + 10 \log (P)$ dB. P in watts.

At P_o transmitting power. the specified minimum attenuation becomes $43+10 \log (P_o)$. and the level in dBm relative P_o becomes:

$$P_o \text{ (dBm)} - [43 + 10 \log (P_o \text{ in mwatts}) - 30] = -13 \text{ dBm}$$

TEST SETUP

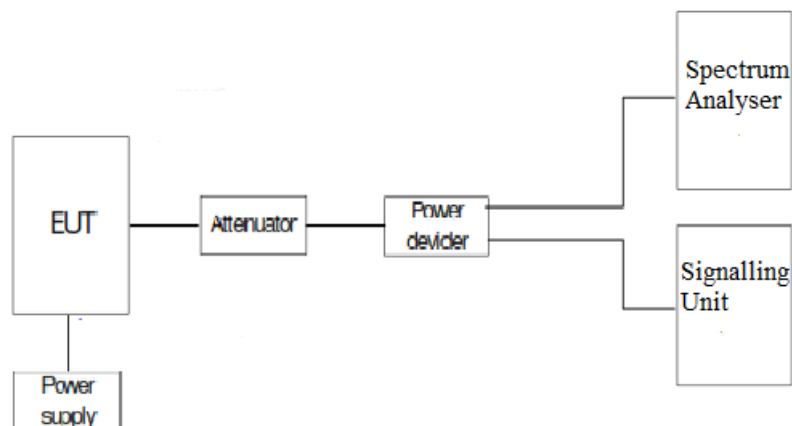

RESULTS (see plots in next pages)

LTE Band 25

1. CHANNEL: LOWEST

No spurious signals were found at less than 20dB respect to the limit in all the range.

2. CHANNEL: MIDDLE

No spurious signals were found at less than 20dB respect to the limit in all the range.

3. CHANNEL: HIGHEST

No spurious signals were found at less than 20dB respect to the limit in all the range.

Verdict: PASS

LTE Band 25

1. CHANNEL: LOWEST

Frequency Range 9 kHz – 20 GHz

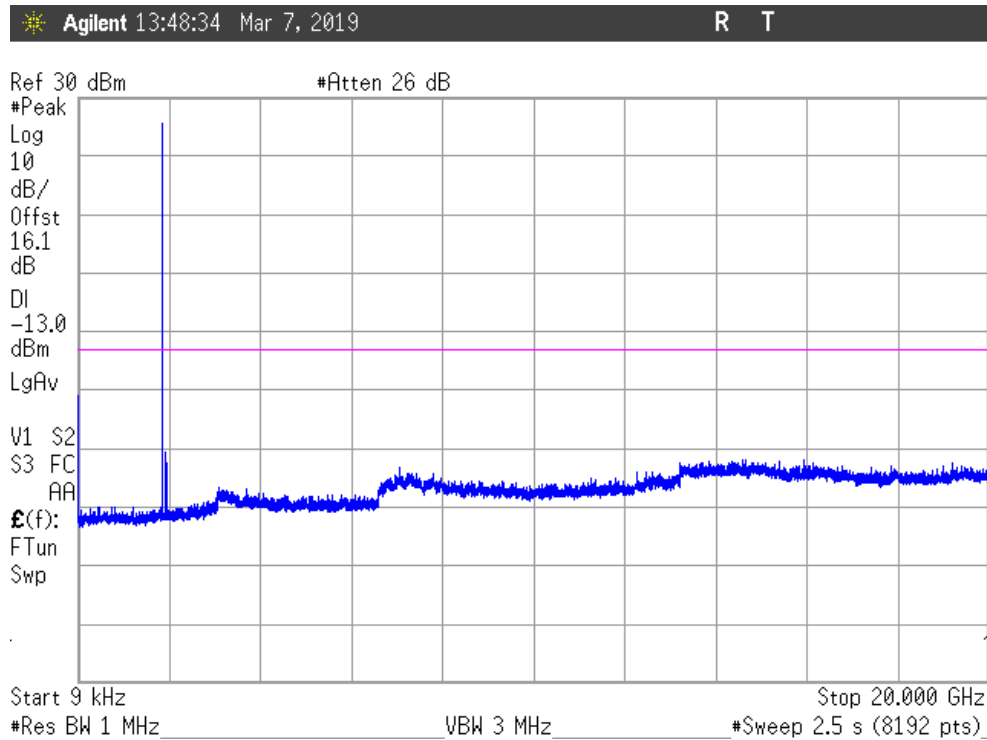

Note: The peak above the limit is the carrier frequency.

2. CHANNEL: MIDDLE

Frequency Range 9 kHz – 20 GHz

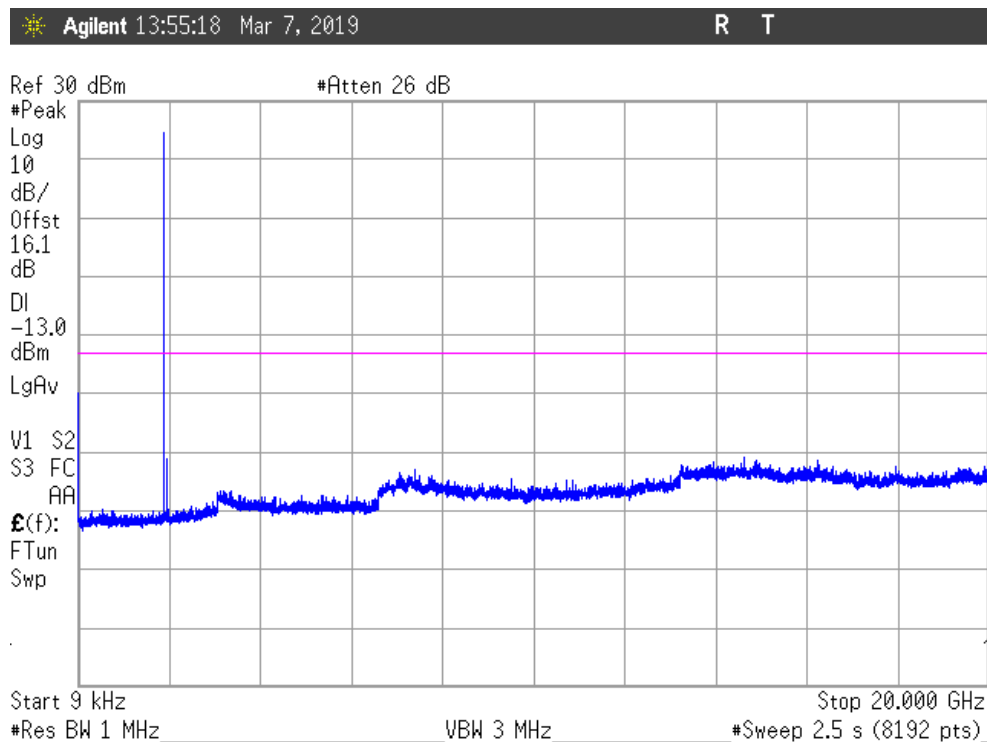

Note: The peak above the limit is the carrier frequency.

3. CHANNEL: HIGHEST

Frequency Range 9 kHz – 20 GHz

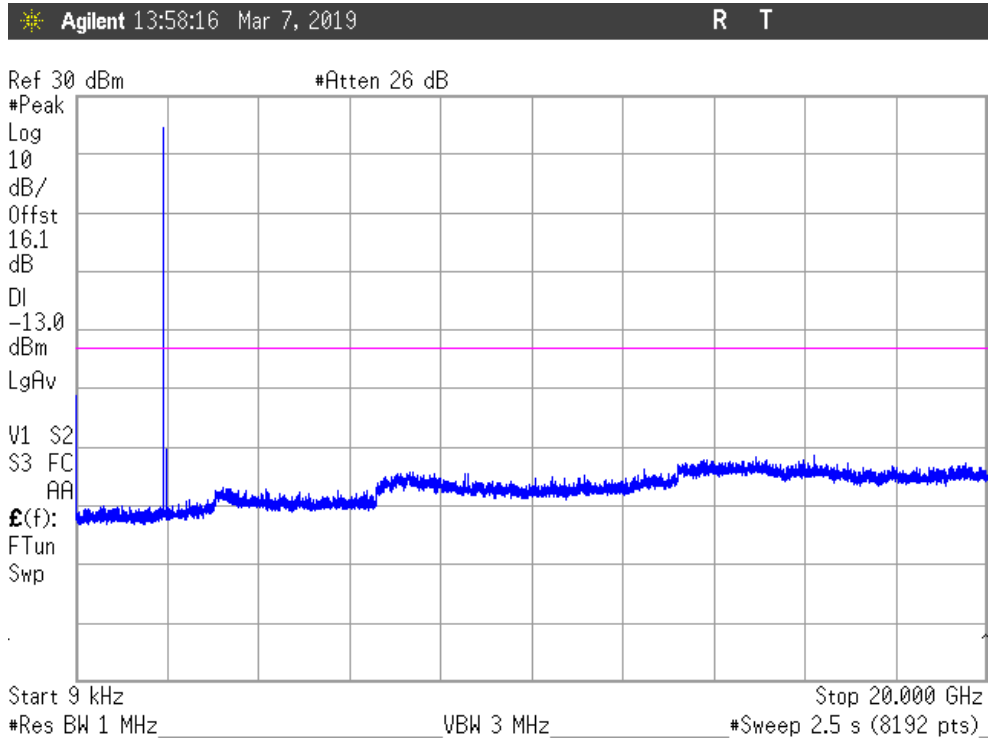

Note: The peak above the limit is the carrier frequency.

Spurious emissions at antenna terminals at Block Edges

SPECIFICATION

FCC §2.1051 and §24.238. RSS-133 Clause 6.5.

METHOD

The EUT RF output connector was connected to a spectrum analyser and to the Universal Radio Communication tester R&S CMW500 (selecting maximum transmission power of the EUT and different modes of modulation) using a 50 ohm attenuator and a power splitter.

The reading of the spectrum analyser is corrected with the attenuation loss of connection between output terminal of EUT and input of the spectrum analyser.

The configuration of modulation which is the worst case for conducted power was used.

As indicated in FCC part 24, in the 1 MHz bands immediately outside and adjacent to the licensee's frequency block, a resolution bandwidth of at least one percent of the emission bandwidth/occupied bandwidth of the fundamental emission of the transmitter may be employed.

Measurement Limit:

According to specification. the power of emissions shall be attenuated below the transmitter power (P) by a factor of at least $43 + 10 \log (P)$ dB. P in watts.

At P_o transmitting power. the specified minimum attenuation becomes $43+10\log (P_o)$. and the level in dBm relative P_o becomes:

$$P_o \text{ (dBm)} - [43 + 10 \log (P_o \text{ in mwatts}) - 30] = - 13 \text{ dBm}$$

TEST SETUP

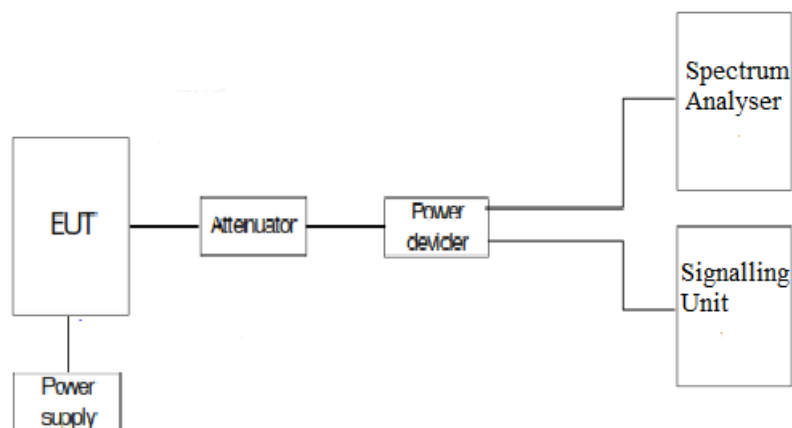

RESULTS (see plots in next pages)

LTE. BAND 25.

Preliminary measurements determined the narrow band = 1 and nominal bandwidth of 1.4 MHz as the worst case. The results in the next tables shows the results for this configuration.

(Channels in Band 25):	RB=1. Offset=0. Narrow band = 1 BW=1.4 MHz	RB= All. Offset=0. Narrow band = 1 BW=1.4 MHz
Maximum measured level at lowest Block Edge at antenna port (dBm)	-19.48	-25.94

(Channels in Band 25):	RB= 1. Offset=Max. Narrow band = 1 BW=1.4 MHz	RB= All. Offset=0. Narrow band = 1 BW=1.4 MHz
Maximum measured level at highest Block Edge at antenna port (dBm)	-17.46	-22.19

Measurement uncertainty = ± 1.20 dB.

Verdict: PASS

LTE. BAND 25.

Narrow band = 1. RB = 1. Offset = 0. BW = 1.4 MHz

CHANNEL LOWEST

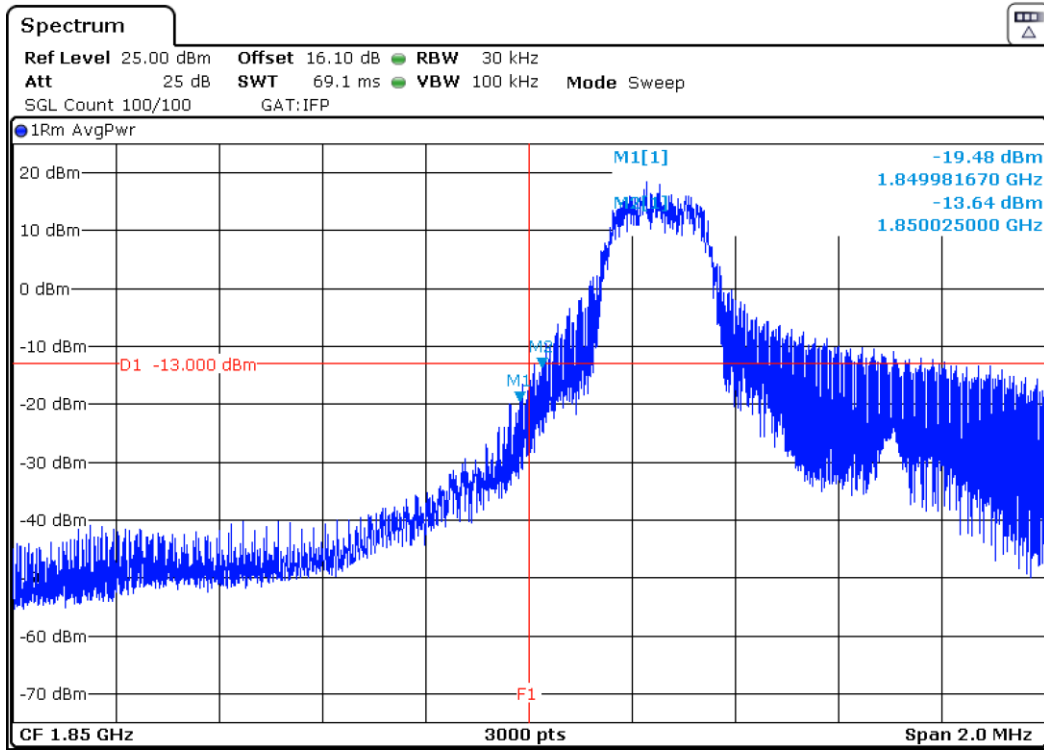

NOTE: The equipment transmits at the maximum output power

Narrow band = 1. RB = 1. Offset = Max. BW = 1.4 MHz

CHANNEL HIGHEST

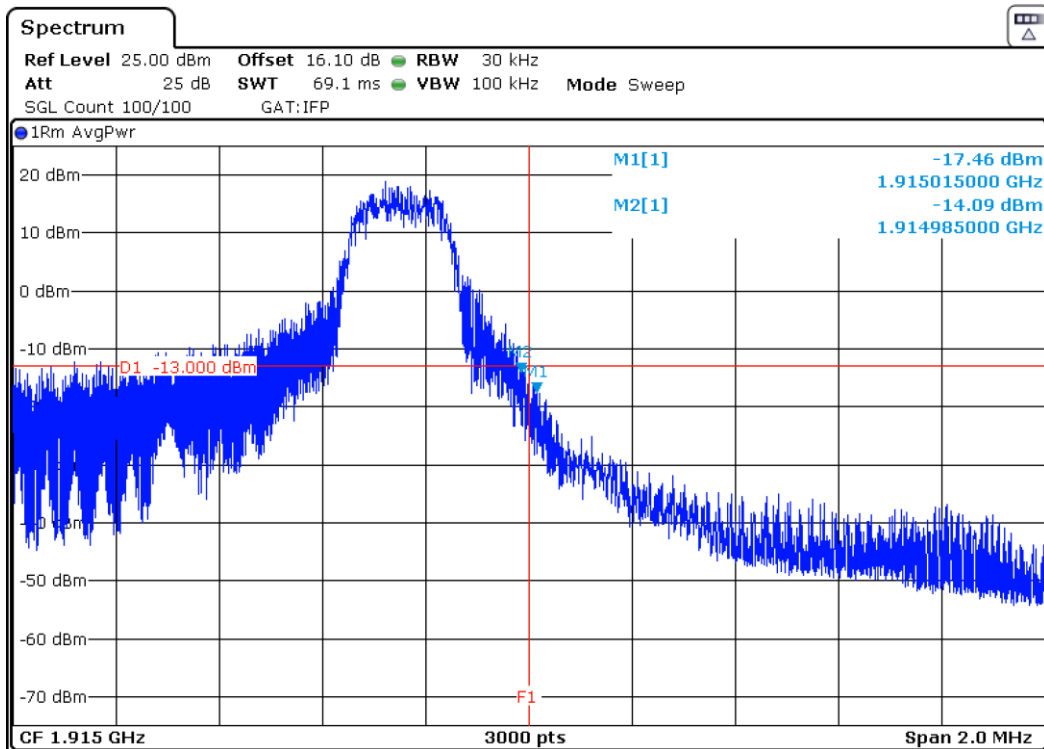

Narrow band = 1. RB = All. Offset = 0. BW = 1.4 MHz

CHANNEL LOWEST

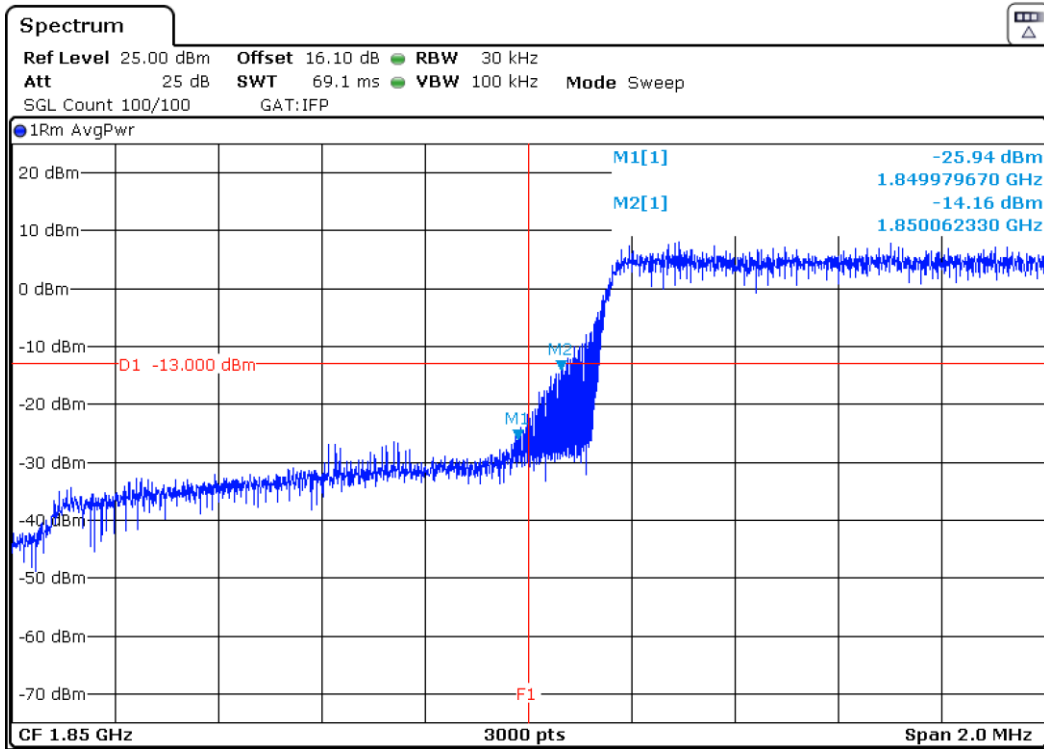

NOTE: The equipment transmits at the maximum output power

Narrow band = 1. RB = All. Offset = 0. BW = 1.4 MHz

CHANNEL HIGHEST

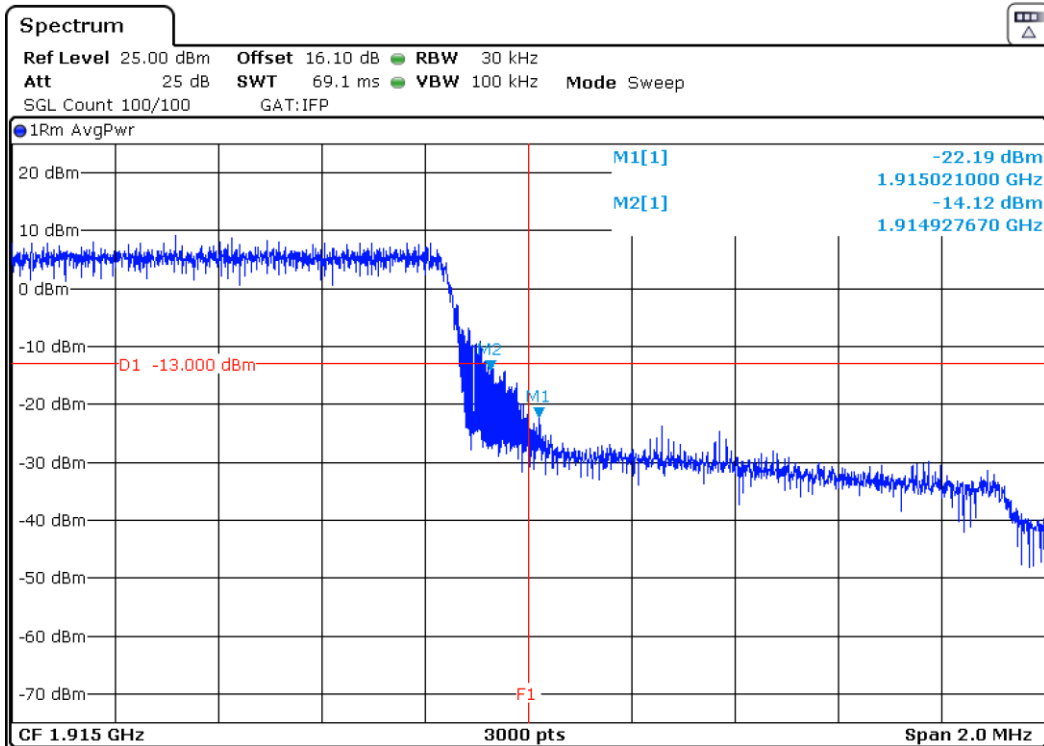

NOTE: The equipment transmits at the maximum output power

Verdict: PASS

Radiated emissions

SPECIFICATION

FCC § 24.238. RSS-133 Clause 6.5.

The power of emissions shall be attenuated below the transmitter power (P) by a factor of at least $43 + 10 \log (P)$ dB. P in watts.

METHOD

The measurement was performed with the EUT inside an anechoic chamber. The spectrum was scanned from 30 MHz to at least the 10th harmonic of the highest frequency generated within the equipment.

The EUT was placed on a non-conductive stand at a 3 meter distance from the measuring antenna for measurements below 1 GHz and at 1 m distance for measurements above 1 GHz.

Detected emissions were maximized at each frequency by rotating the EUT and adjusting the measuring antenna height and polarization. The maximum meter reading was recorded.

Each detected emission at less than 20 dB respect to the limit is substituted by the Substitution method in accordance with the ANSI/TIA-603-E: 2016.

Measurement Limit:

According to specification. the power of emissions shall be attenuated below the transmitter power (P) by a factor of at least $43 + 10 \log (P)$ dB. P in watts.

At P_o transmitting power. the specified minimum attenuation becomes $43+10\log (P_o)$ and the level in dBm relative P_o becomes:

$$P_o \text{ (dBm)} - [43 + 10 \log (P_o \text{ in mwatts}) - 30] = - 13 \text{ dBm}$$

TEST SETUP

Radiated measurements below 1 GHz.

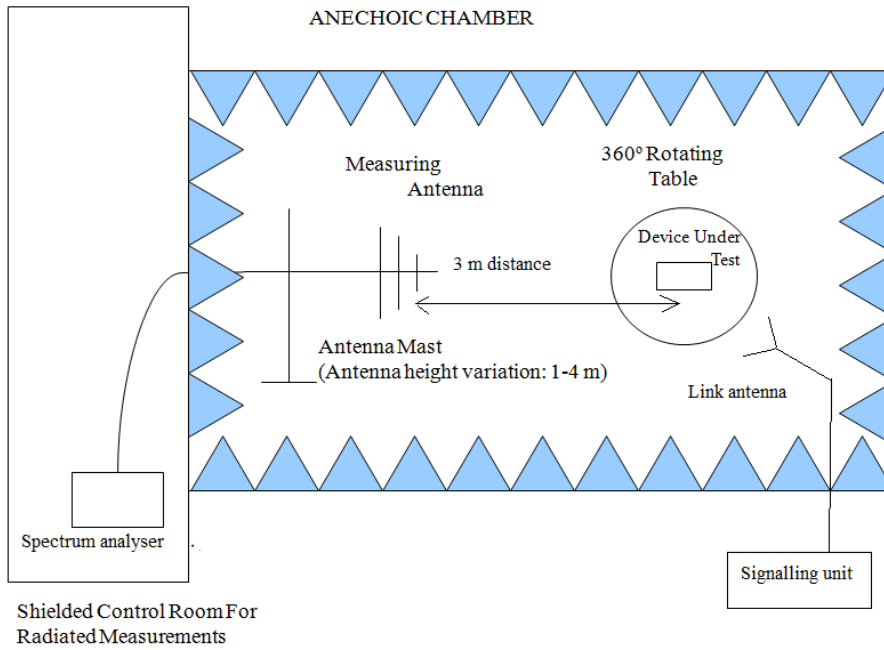

Radiated measurements above 1 GHz.

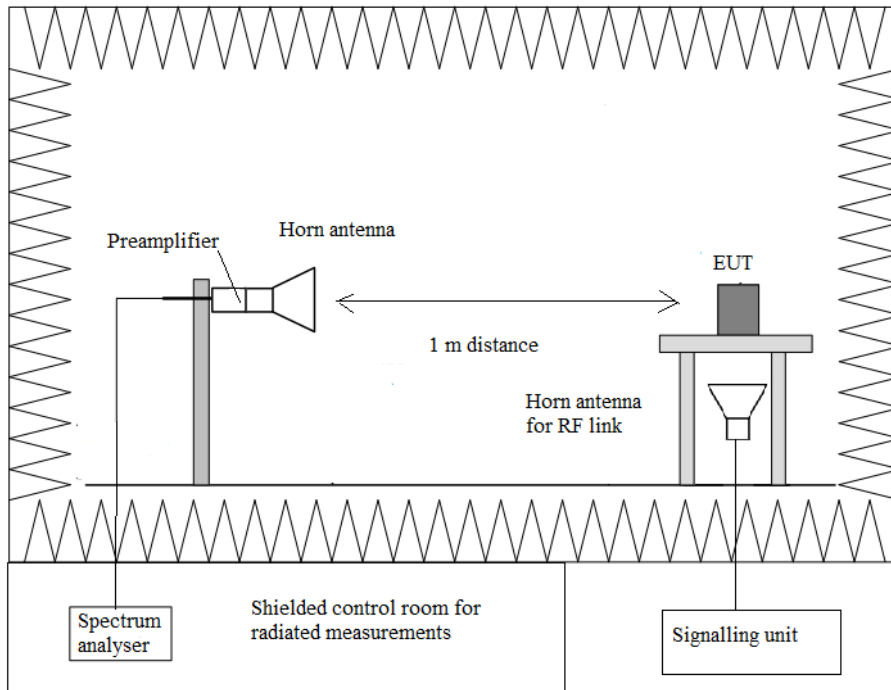

RESULTS

LTE. BAND 25.

A preliminary scan determined the QPSK 3 MHz bandwidth, Narrow band =1, RB = 1, as the worst case.

The following tables and plots show the results for this configuration.

1. CHANNEL: LOWEST

Frequency range 30 MHz-1000 MHz.

No radiated spurious signals were detected at less than 20 dB respect to the limit.

Frequency range 1 GHz-18 GHz.

No radiated spurious signals were detected at less than 20 dB respect to the limit.

Frequency range 18 GHz-20 GHz.

No radiated spurious signals were detected at less than 20 dB respect to the limit.

2. CHANNEL: MIDDLE

Frequency range 30 MHz-1000 MHz.

No radiated spurious signals were detected at less than 20 dB respect to the limit.

Frequency range 1 GHz-18 GHz.

No radiated spurious signals were detected at less than 20 dB respect to the limit.

Frequency range 18 GHz-20 GHz.

No radiated spurious signals were detected at less than 20 dB respect to the limit.

3. CHANNEL: HIGHEST

Frequency range 30 MHz-1000 MHz.

No radiated spurious signals were detected at less than 20 dB respect to the limit.

Frequency range 1 GHz-18 GHz.

No radiated spurious signals were detected at less than 20 dB respect to the limit.

Frequency range 18 GHz-20 GHz.

No radiated spurious signals were detected at less than 20 dB respect to the limit.

Verdict: PASS

Frequency range 30 MHz-1000 MHz.

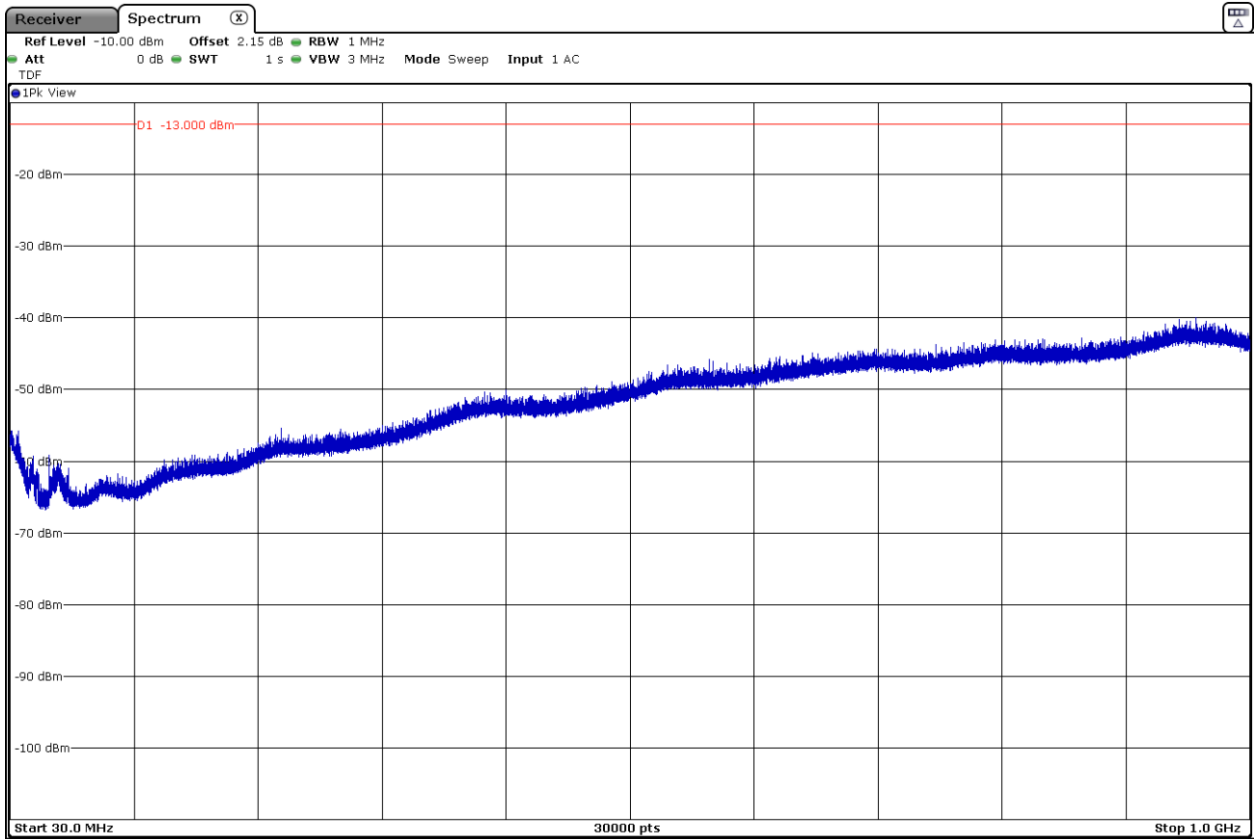

(This plot is valid for all three channels)

Frequency range 1 GHz to 3 GHz

CHANNEL: LOWEST

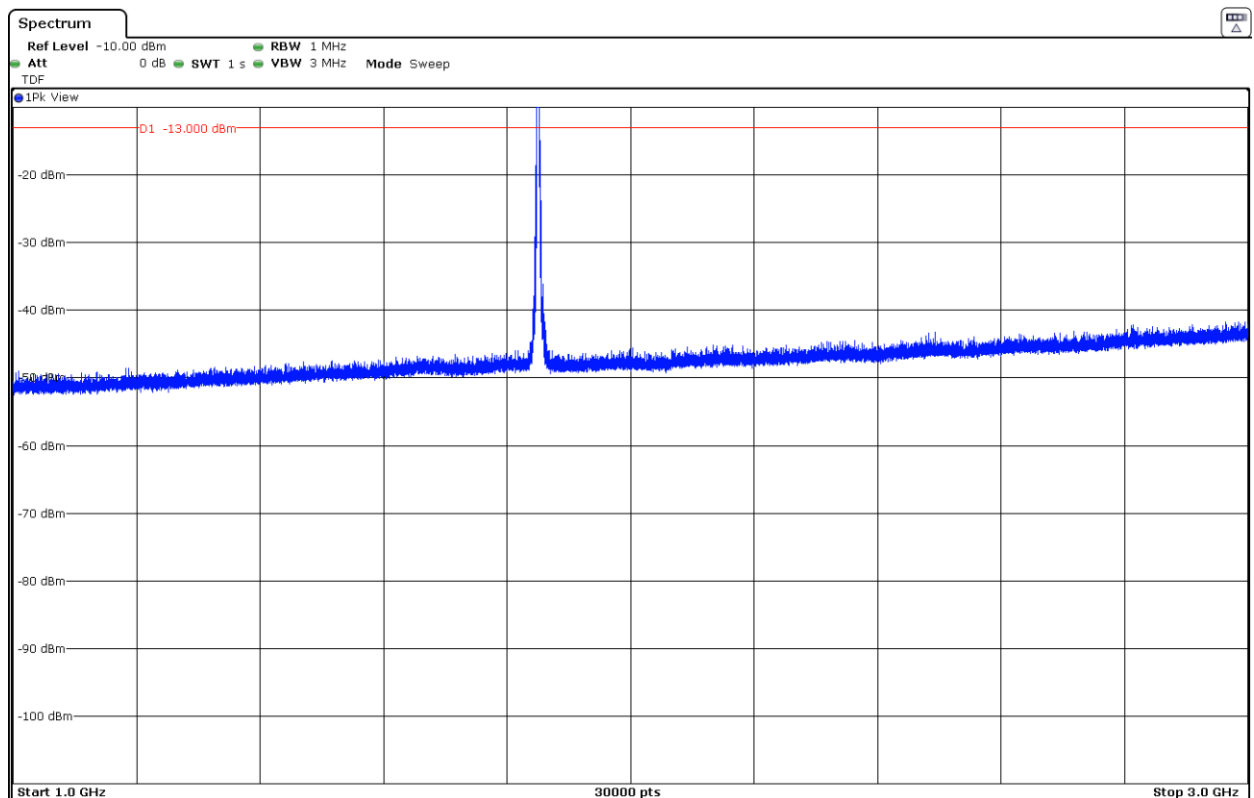

Note: The peak above the limit is the carrier frequency.

CHANNEL: MIDDLE

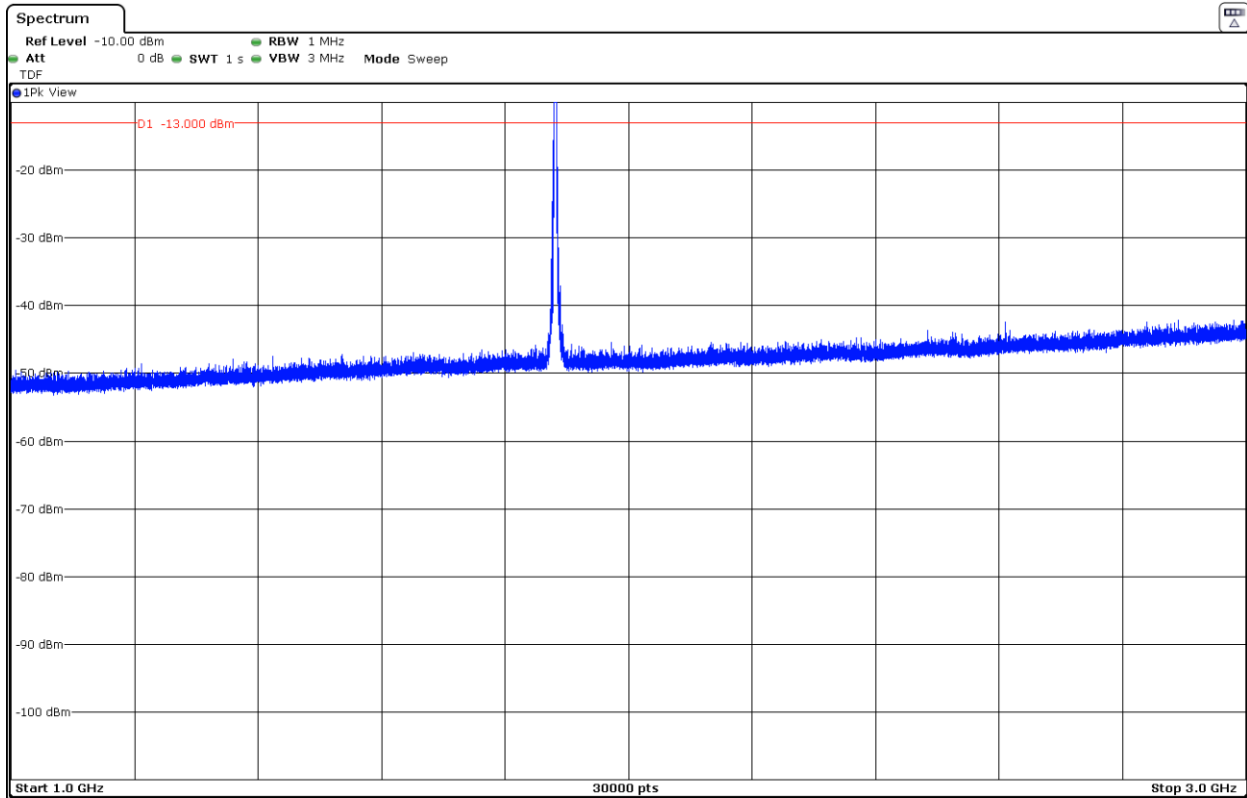

Note: The peak above the limit is the carrier frequency.

CHANNEL: HIGHEST

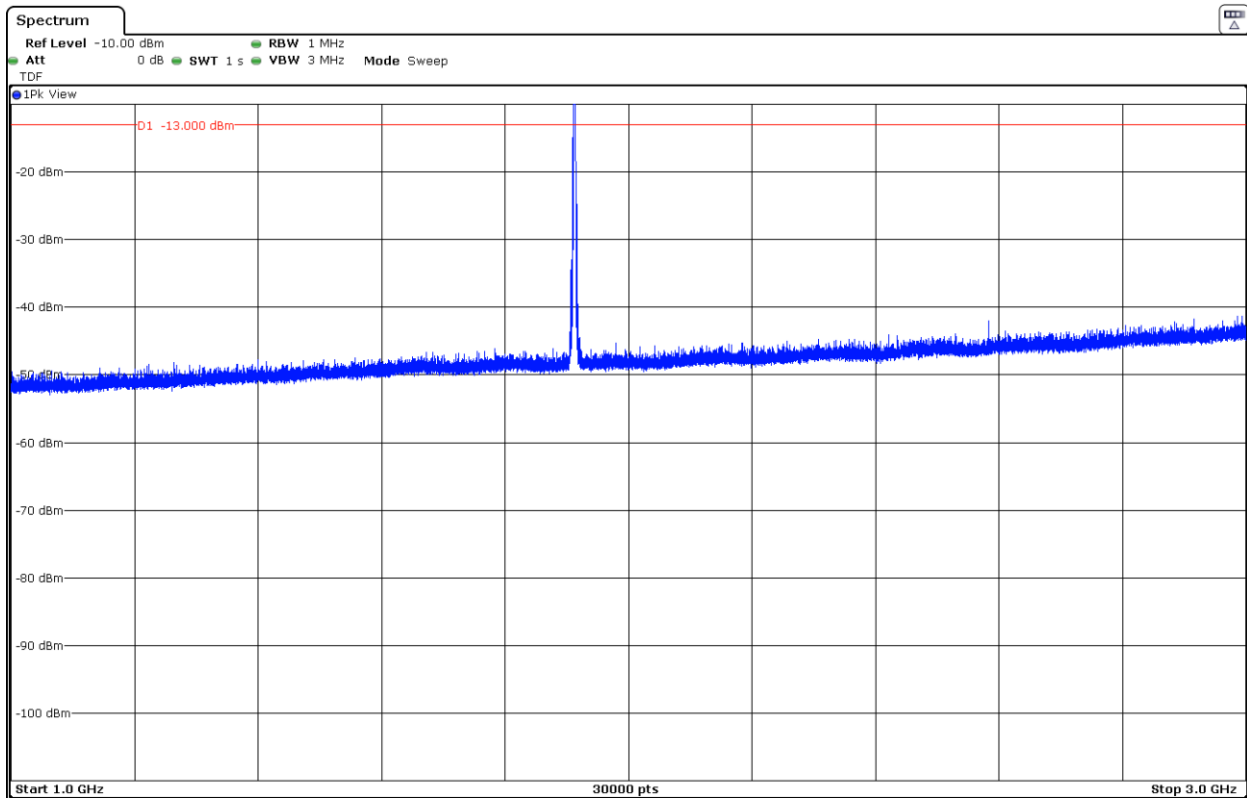

Note: The peak above the limit is the carrier frequency.

Frequency range 3 GHz to 18 GHz

CHANNEL: LOWEST

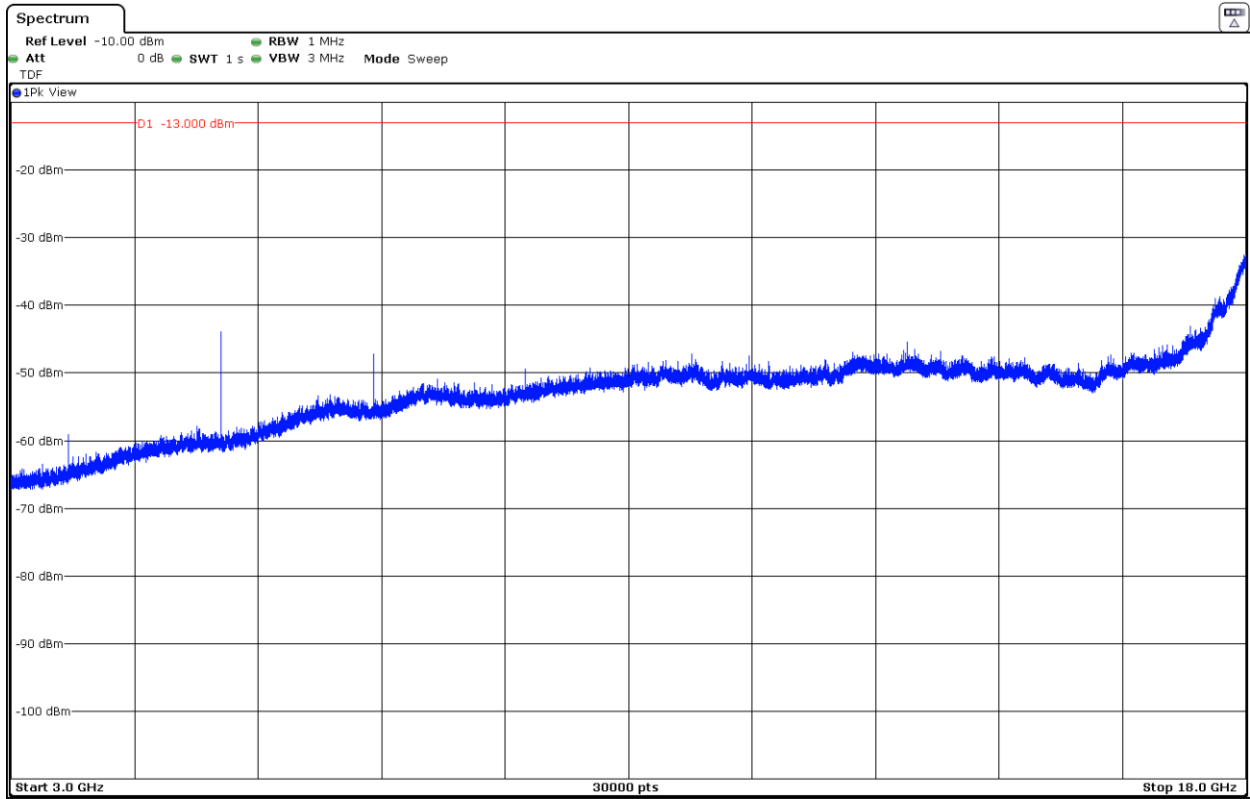

CHANNEL: MIDDLE

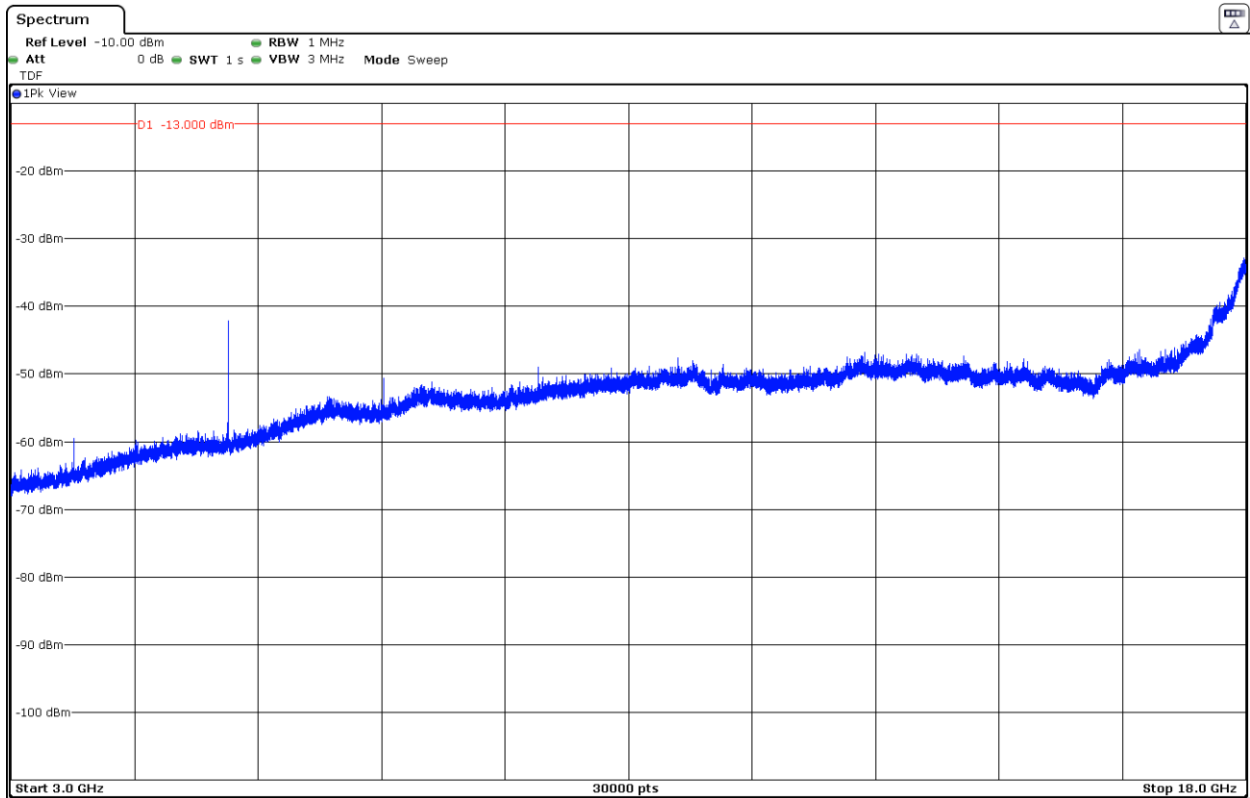

CHANNEL: HIGHEST

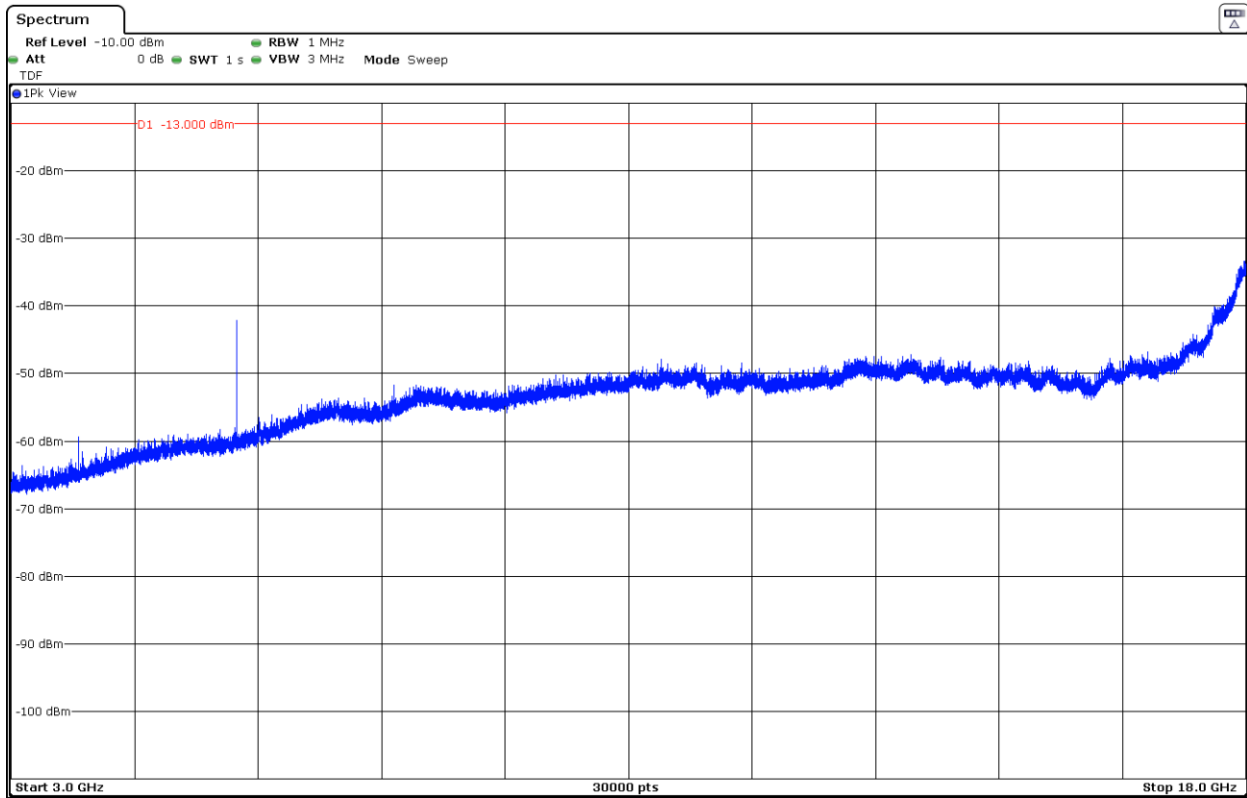

Frequency range 18 GHz to 20 GHz

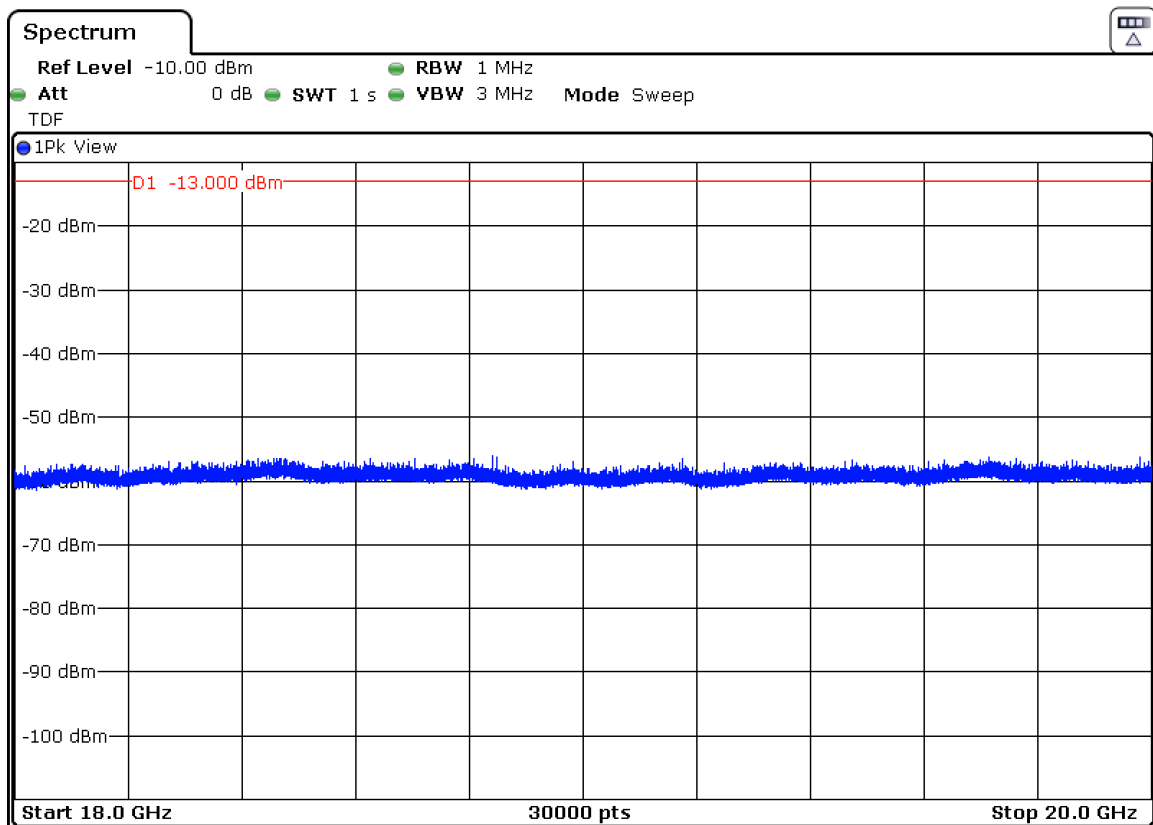

(This plot is valid for all three channels)

Appendix B: Test results for FCC Part 27 / RSS-139 / RSS-130

INDEX

TEST CONDITIONS.....	43
RF Output Power	45
Frequency Stability	52
Modulation Characteristics	56
Occupied Bandwidth	59
Spurious emissions at antenna terminals.....	67
Spurious emissions at antenna terminals at Block Edges.....	72
Radiated emissions.....	80

TEST CONDITIONS

Power supply (V):

Vnominal = 3.8 Vdc

Vmax = 4.37 Vdc

Vmin = 3.23 Vdc

The subscripts nom, min and max indicate voltage test conditions (nominal, minimum and maximum respectively, as declared by the applicant).

Type of power supply = DC Voltage from external power supply

Type of antenna = Integral antenna.

Declared Gain for antenna = +2.6 dBi for Band 12 and Band 17 and +4.4 dBi for Band 66

TEST FREQUENCIES:

LTE. QPSK AND 16QAM MODULATION (BAND 12)

	Channel (Frequency. MHz)			
	BW = 1.4 MHz	BW = 3 MHz	BW = 5 MHz	BW = 10 MHz
Lowest	23017 (699.7)	23025 (700.5)	23035 (701.5)	23060 (704.0)
Middle	23095 (707.5)	23095 (707.5)	23095 (707.5)	23095 (707.5)
Highest	23173 (715.3)	23165 (714.5)	23155 (713.5)	23130 (711.0)

LTE. QPSK AND 16QAM MODULATION (BAND 17)

	Channel (Frequency. MHz)	
	BW = 5 MHz	BW = 10 MHz
Lowest	23755 (706.5)	23780 (709.0)
Middle	23790 (710.0)	23790 (710.0)
Highest	23825 (713.5)	23800 (711.0)

NOTE: Band 17 is completely included in band 12, so the channels of band 12 were tested to give conformity to the assigned block.

LTE. QPSK AND 16QAM MODULATION (BAND 66)

	Channel (Frequency. MHz)					
	BW = 1.4 MHz	BW = 3 MHz	BW = 5 MHz	BW = 10 MHz	BW = 15 MHz	BW = 20 MHz
Lowest	131979 (1710.7)	131987 (1711.5)	131997 (1712.5)	132022 (1715.0)	132047 (1717.5)	132072 (1720.0)
Middle	132322 (1745.0)	132322 (1745.0)	132322 (1745.0)	132322 (1745.0)	132322 (1745.0)	132322 (1745.0)
Highest	132665 (1779.3)	132657 (1778.5)	132647 (1777.5)	132622 (1775.0)	132597 (1772.5)	132572 (1770.0)

RF Output Power

SPECIFICATION

FCC §27.50 (c) (10).

Portable stations (hand-held devices) in the 600 MHz uplink band and the 698-746 MHz band, and fixed and mobile stations in the 600 MHz uplink band are limited to 3 watts ERP.

RSS-130 Clause 4.4.

The e.i.r.p. shall not exceed 50 watts (46.99 dBm) for mobile equipment or for outdoor fixed subscriber equipment nor shall it exceed 5 watts (36.99 dBm) for portable equipment or for indoor fixed subscriber equipment.

The peak-to-average power ratio (PAPR) of the transmission shall not exceed 13 dB.

FCC §27.50 (d) (4) & (5). RSS-139 Clause 6.5.

Fixed, mobile, and portable (hand-held) stations operating in the 1710-1755 MHz band are limited to 1 watt EIRP (30 dBm). Fixed stations operating in the 1710-1755 MHz band are limited to a maximum antenna height of 10 meters above ground. Mobile and portable stations operating in these bands must employ a means for limiting power to the minimum necessary for successful communications.

The peak-to-average ratio (PAR) of the transmission shall not exceed 13 dB.

METHOD

The conducted RF output power measurements were made at the RF output terminals of the EUT using the power meter of the Universal Radio Communication tester R&S CMW500, selecting maximum transmission power of the EUT and different modes of modulation.

The maximum equivalent isotropically radiated power (e.i.r.p.) is calculated by adding the declared maximum antenna gain (dBi).

The maximum effective radiated power e.r.p. is calculated from the maximum equivalent isotropically radiated power (e.i.r.p.) by subtracting 2.15 dB:

$$E.R.P. = E.I.R.P. - 2.15 \text{ dB}$$

The peak-to-average power ratio (PAPR) is measured using an attenuator, power splitter and spectrum analyser with a Complementary Cumulative Distribution Function implemented.

The EUT was controlled via the Universal Radio Communication tester R&S CMW500 selecting maximum transmission power of the EUT and different modes of modulation.

TEST SETUP

Conducted average power.



Peak-to-average power ratio (PAPR)

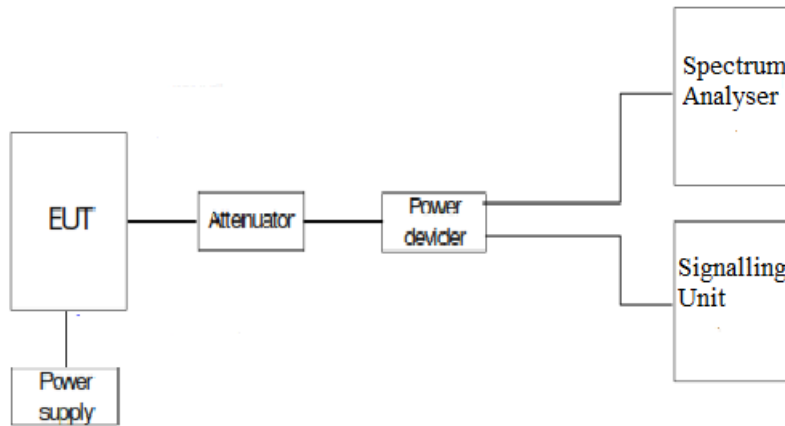

RESULTS

MAXIMUM OUTPUT POWER (CONDUCTED).

LTE. BAND 12.

Preliminary measurements determined the narrow band = 1 and nominal bandwidth of 10 MHz as the worst case. The results in the next tables shows the results for this configuration.

Narrow band = 1

BANDWIDTH (MHz)	CHANNEL	FREQUENCY (MHz)	MODULATION	RB SIZE	RB OFFSET	AVERAGE POWER (dBm)	PAPR (dB)
10	23060	704	QPSK	1	0	22.65	4.52
			16-QAM	6	0	21.65	
	23095	707.5	QPSK	1	0	21.58	5.4
			16-QAM	5	0	21.67	
	23130	711	QPSK	1	0	22.74	4.49
			16-QAM	6	0	21.73	
23130	711	QPSK	1	0	21.62	5.29	
		16-QAM	5	0	21.68		
23130	711	QPSK	1	0	22.7	4.49	
		16-QAM	6	0	21.71		
23130	711	QPSK	1	0	21.67	5.3	
		16-QAM	5	0	21.71		

LTE. BAND 66.

Preliminary measurements determined the narrow band = 1 and nominal bandwidth of 5 MHz as the worst case. The results in the next tables shows the results for this configuration.

Narrow band = 1

BANDWIDTH (MHz)	CHANNEL	FREQUENCY (MHz)	MODULATION	RB SIZE	RB OFFSET	AVERAGE POWER (dBm)	PAPR (dB)
5	131997	1712.5	QPSK	1	0	22.77	4.63
			16-QAM	6	0	21.79	
	132322	1745	QPSK	1	0	21.68	4.95
			16-QAM	5	0	20.72	
	132647	1777.5	QPSK	1	0	22.88	4.79
			16-QAM	6	0	21.93	
132647	1777.5	QPSK	1	0	21.83	5.37	
		16-QAM	5	0	20.87		
132647	1777.5	QPSK	1	0	22.88	4.86	
		16-QAM	6	0	21.82		
132647	1777.5	QPSK	1	0	21.77	5.38	
		16-QAM	5	0	20.83		

PEAK-TO-AVERAGE POWER RATIO (PAPR).

LTE. BAND 12.

Preliminary measurements determined the narrow band = 1, nominal bandwidth of 10 MHz, 16-QAM modulation and 5 RB size offset 0 as the worst case. The results in the next tables shows the results for this configuration.

Bandwidth = 10 MHz. Modulation 16-QAM. RB Size: 5. RB Offset: 0.

Channel Low:

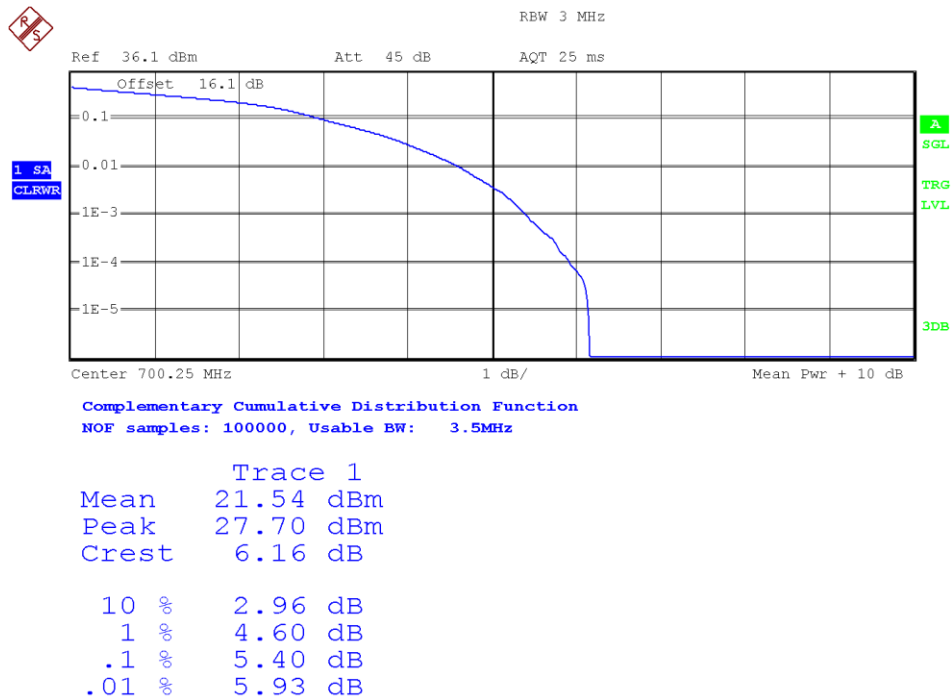

Channel Middle:

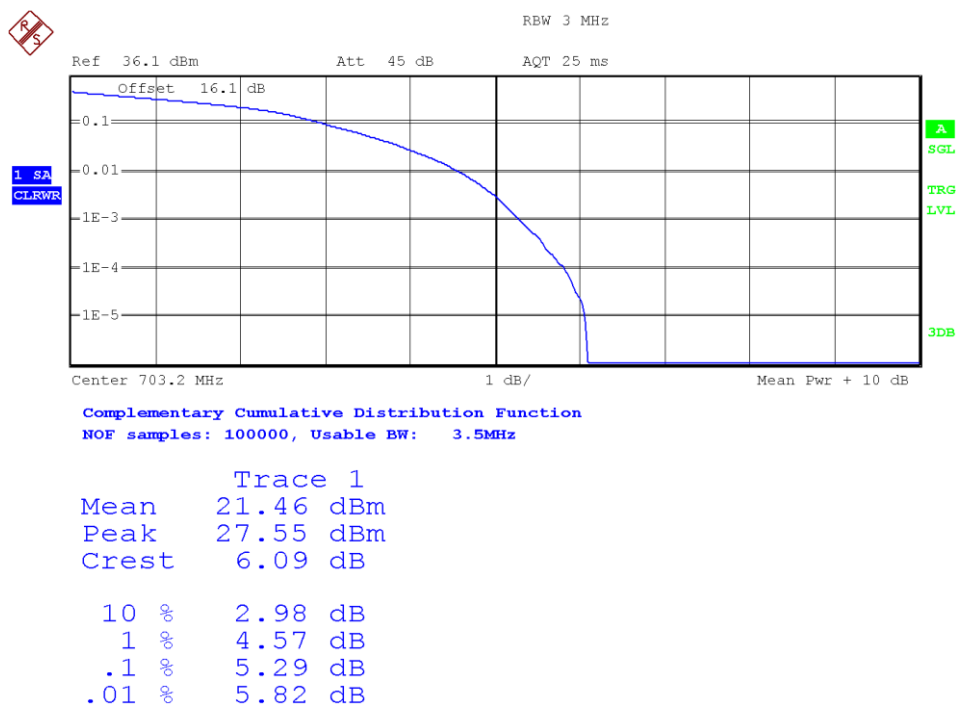

Channel High:

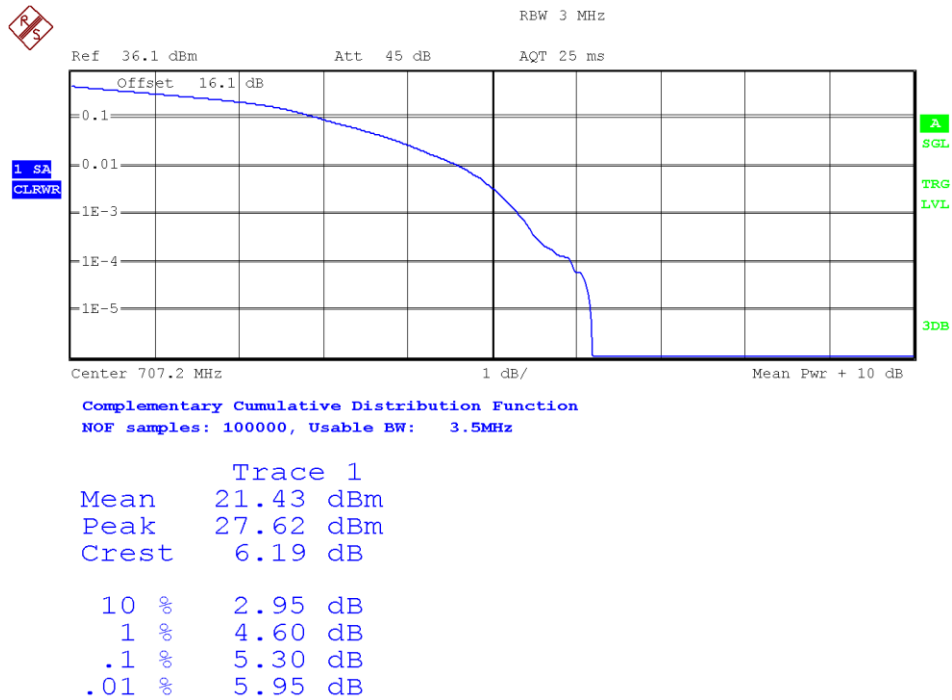

LTE. BAND 66.

Preliminary measurements determined the narrow band = 1, nominal bandwidth of 5 MHz, 16-QAM modulation and 5 RB size offset 0 as the worst case. The results in the next tables shows the results for this configuration

Bandwidth = 5 MHz. Modulation 16 QAM. RB Size: 5. RB Offset: 0.

Channel Low:

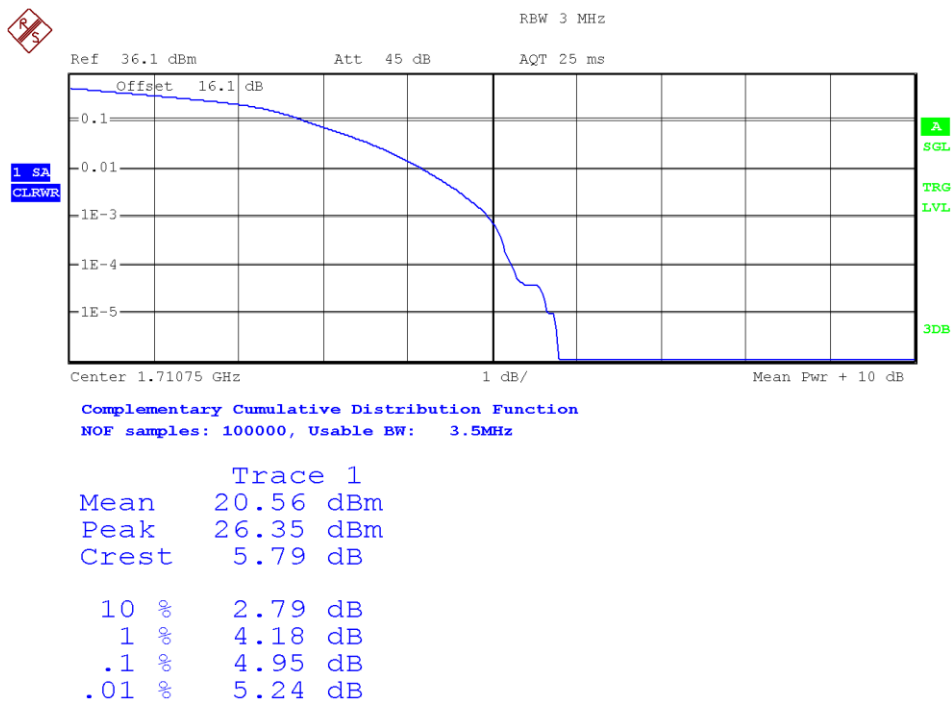

Channel Middle:

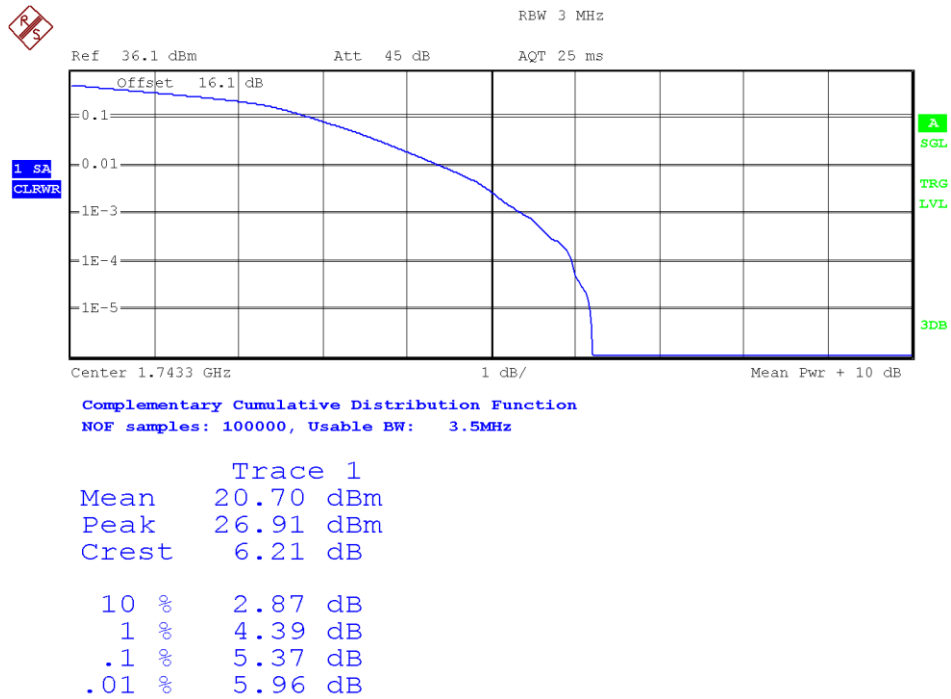

Channel High:

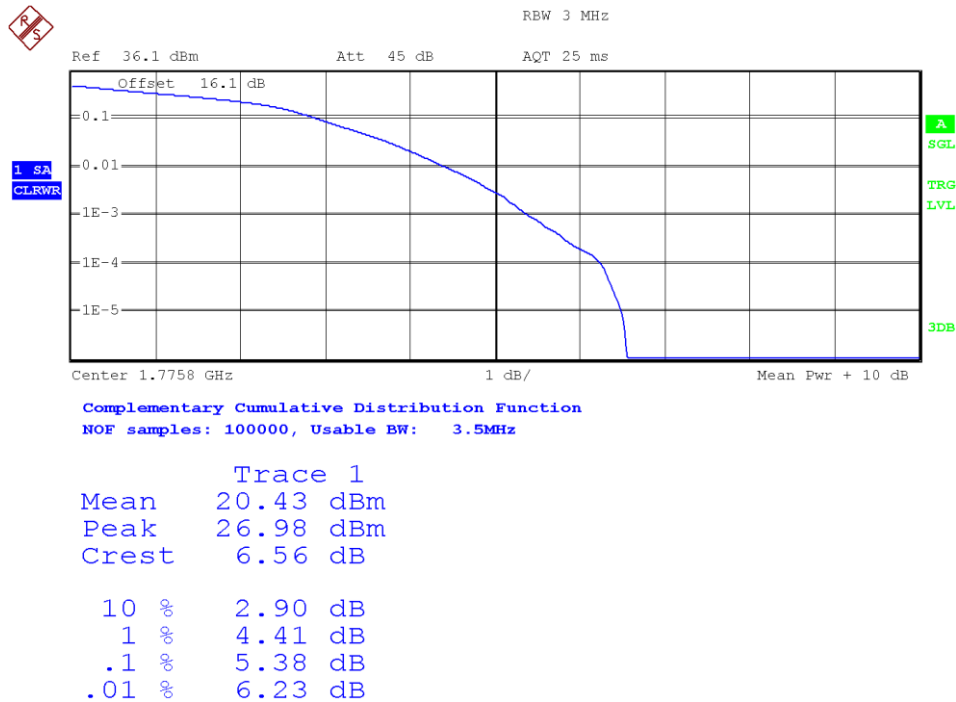

LTE BAND 12.

Channel	Measured maximum average power (dBm) at antenna port	Maximum declared antenna gain (dBi)	Maximum equivalent isotropically radiated power (E.I.R.P.) (dBm)	Maximum effective radiated power E.R.P. (dBm)	PAPR (dB)
Lowest	22.65	2.6	25.25	23.10	5.40
Middle	22.74	2.6	25.34	23.19	5.29
Highest	22.7	2.6	25.30	23.15	5.30
Measurement uncertainty (dB)	<±1.11				

LTE BAND 66.

Channel	Measured maximum average power (dBm) at antenna port	Maximum declared antenna gain (dBi)	Maximum equivalent isotropically radiated power (E.I.R.P.) (dBm)	Maximum effective radiated power E.R.P. (dBm)	PAPR (dB)
Lowest	22.77	4.4	27.17	25.02	4.95
Middle	22.88	4.4	27.28	25.13	5.37
Highest	22.88	4.4	27.28	23.13	5.38
Measurement uncertainty (dB)	<±1.11				

Verdict: PASS

Frequency Stability

SPECIFICATION

FCC §2.1055 and §27.54.

The frequency stability shall be sufficient to ensure that the fundamental emission stays within the authorized frequency block.

RSS-139 Clause 6.4.

The frequency stability shall be sufficient to ensure that the occupied bandwidth stays within the operating frequency block when tested to the temperature and supply voltage variations specified in RSS-Gen.

RSS-130. Clause 4.3.

The applicant shall ensure frequency stability by showing that f_L minus the frequency offset and f_H plus the frequency offset shall be within the frequency range in which the equipment is designed to operate.

METHOD

The frequency tolerance measurements over temperature variations were made over the temperature range of -30°C to $+50^{\circ}\text{C}$. The EUT was placed inside a climatic chamber and the temperature was raised hourly in 10°C steps from -30°C up to $+50^{\circ}\text{C}$.

The supply voltage was varied between 85% and 115% of nominal voltage.

The EUT was set in "Radio Resource Control (RRC) mode" in the middle channel using the Universal Radio Communication tester R&S CMW500 and the maximum frequency error was measured using the built-in calibrated frequency meter.

The worst case LTE mode for conducted power was used for the test.

In order to check that the frequency stability is sufficient such that the fundamental emissions stay within the authorized bands of operation, a reference point is established at the applicable unwanted emissions limit using a RBW equal to the RBW required by the unwanted emissions specification of the applicable regulatory standard. These reference points measured using the lowest and highest channel of operation are identified as f_L and f_H respectively. The worst-case frequency offset determined in the above methods is added or subtracted from the values of f_L and f_H to check that the resulting frequencies remain within the band.

The reference point measurements were made at the RF output terminals of the EUT using an attenuator, power splitter and spectrum analyser. The EUT was controlled via the Universal Radio Communication tester R&S CMW500 selecting maximum transmission power of the EUT and different modes of modulation.

TEST SETUP

Frequency tolerance.

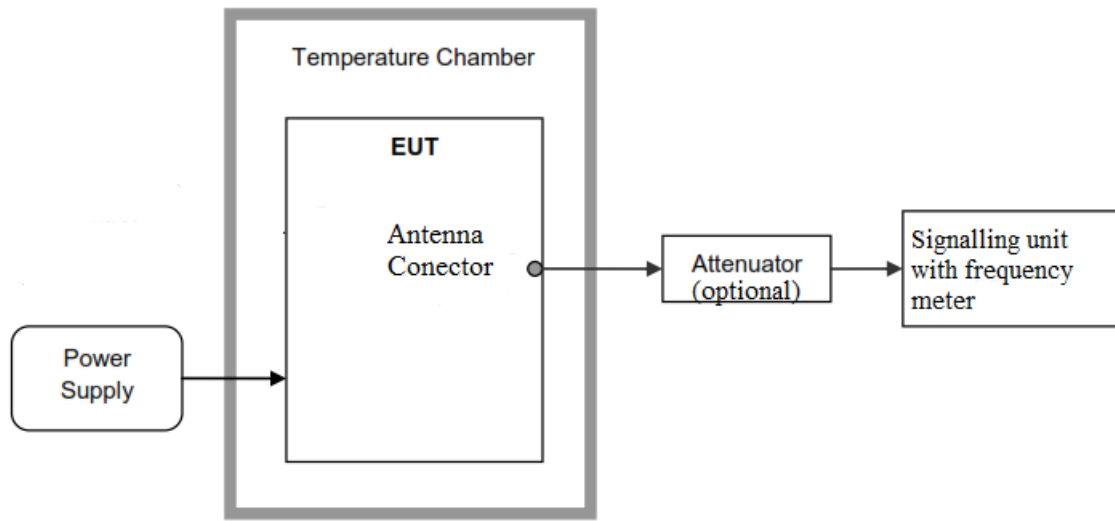

Reference points f_L and f_H .

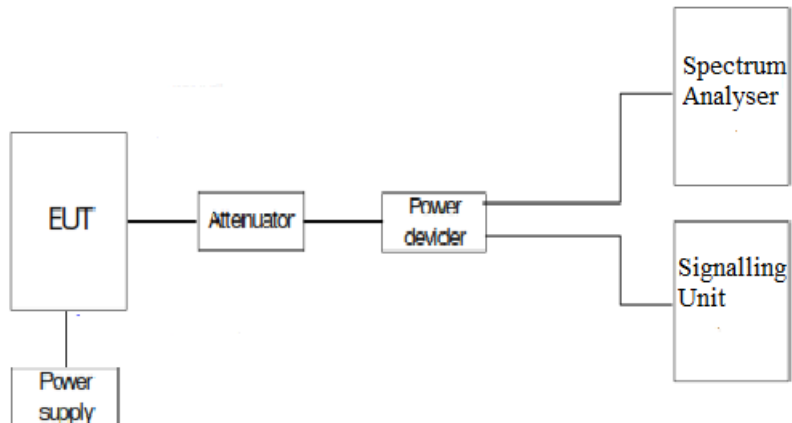

RESULTS

Frequency stability over temperature variations.

LTE Band 12

Temperature (°C)	Frequency Error (Hz)	Frequency Error (ppm)
+50	0.39	0.0005
+40	3.12	0.0044
+30	3.82	0.0054
+20	-9.33	-0.0132
+10	-9.46	-0.0133
0	5.11	0.0072
-10	1.53	0.0022
-20	3.10	0.0044
-30	-8.54	-0.0120

LTE Band 66

Temperature (°C)	Frequency Error (Hz)	Frequency Error (ppm)
+50	-0.57	-0.0003
+40	-2.32	-0.0013
+30	-4.48	-0.0025
+20	-5.01	-0.0029
+10	2.03	0.0012
0	1.79	0.0010
-10	4.33	0.0025
-20	0.46	0.0002
-30	2.47	0.0014

Frequency stability over voltage variations.

LTE Band 12

Battery Supply voltage	Voltage (V)	Frequency Error (Hz)	Frequency Error (ppm)
Vmax	4.37	-2.29	-0.0032
Vmin	3.23	-0.47	-0.0006

LTE Band 66

Battery Supply voltage	Voltage (V)	Frequency Error (Hz)	Frequency Error (ppm)
Vmax	4.37	-2.32	-0.0013
Vmin	3.23	-0.14	-0.00008

Reference points established at the applicable unwanted emissions limit (worst case):

	LTE Band 12
f_L (MHz)	698.9217
f_H (MHz)	715.9914

	LTE Band 66
f_L (MHz)	1710.0281
f_H (MHz)	1779.9507

Reference points f_L and f_H with the worst-case frequency offsets added or subtracted:

	LTE Band 12
f_L (MHz)	698.9217
f_H (MHz)	715.9914

	LTE Band 66
f_L (MHz)	1710.0281
f_H (MHz)	1779.9507

The reference frequency points stay within the authorized blocks.

Verdict: PASS

Modulation Characteristics

SPECIFICATION

FCC §2.1047

RSS-130. Clause 4.1 and RSS-133. Clause 6.2. Equipment certified under this standard shall use digital modulation.

METHOD

For LTE the EUT operates with QPSK and 16QAM modulation modes in which the information is digitised and coded into a bit stream. The RF transmission is multiplexed using *Orthogonal Frequency Division Multiplexing (OFDM)* using different possible arrangement of subcarriers (Resource Blocks RB).

TEST SETUP

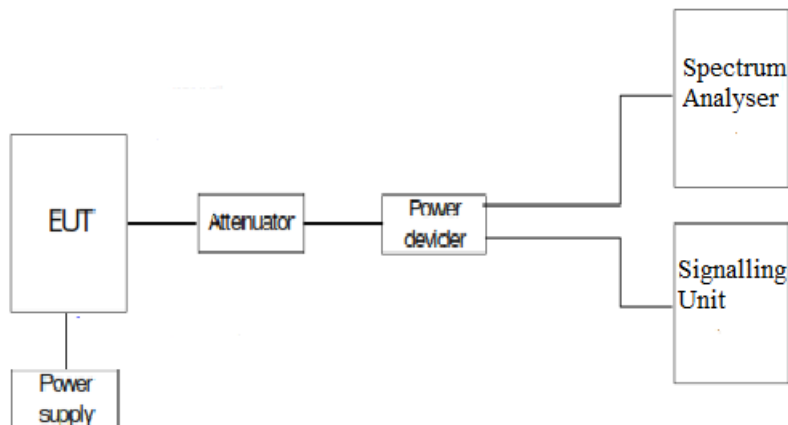

RESULTS

The following plot shows the modulation schemes in the EUT.

LTE MODULATION (Band 12). QPSK.

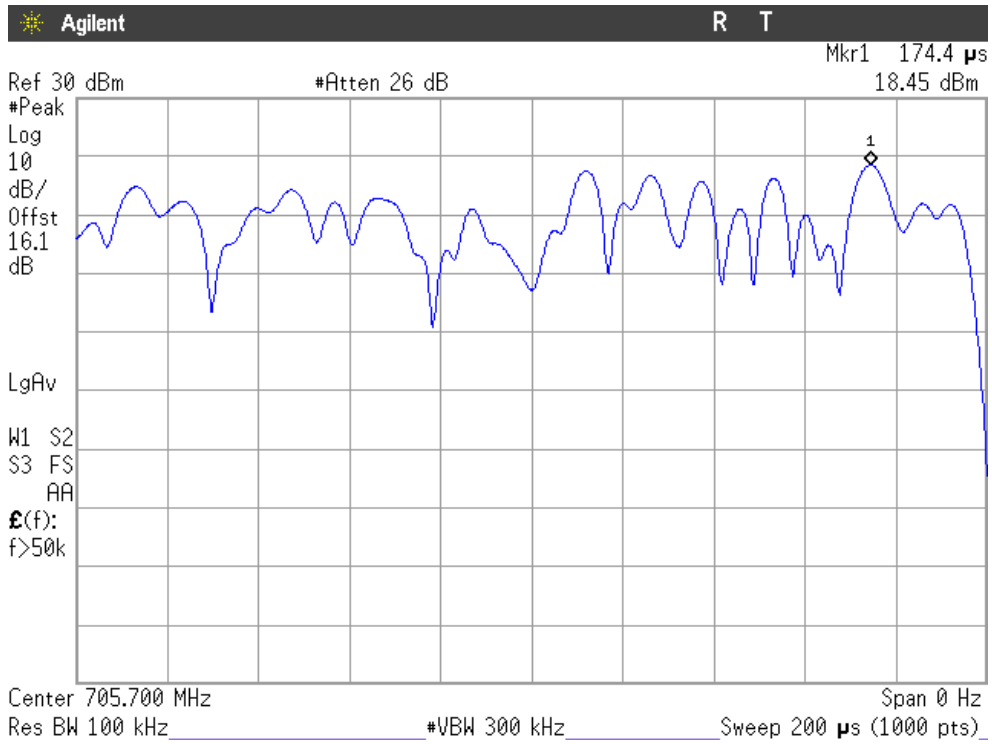

LTE MODULATION (Band 12). 16QAM.

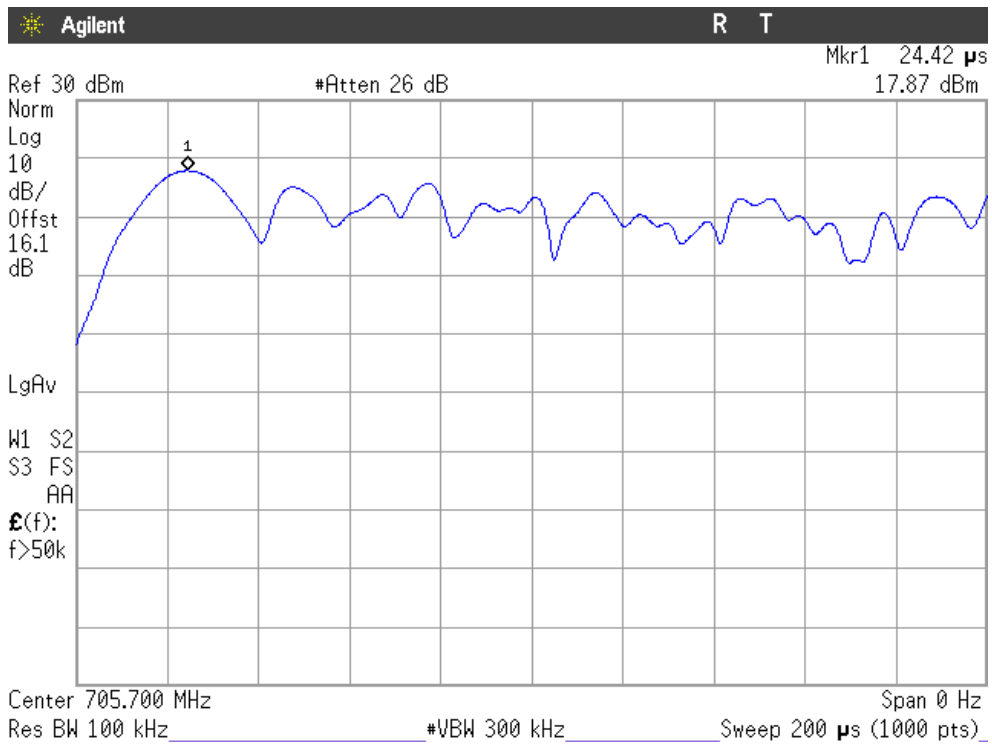

LTE MODULATION (Band 66). QPSK.

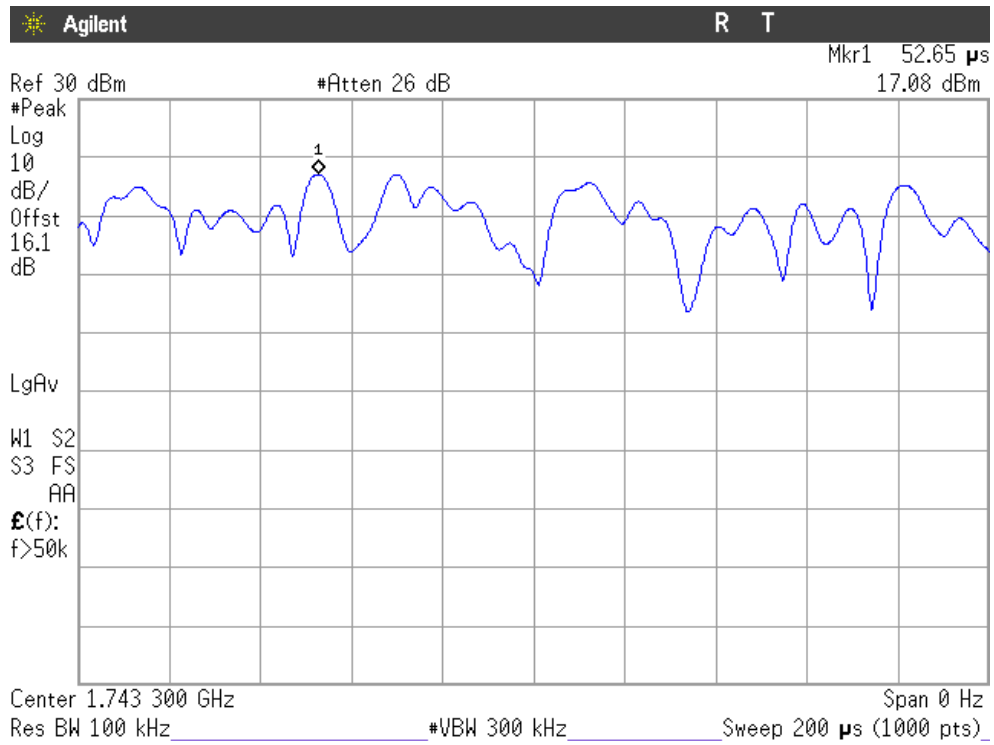

LTE MODULATION (Band 66). 16QAM.

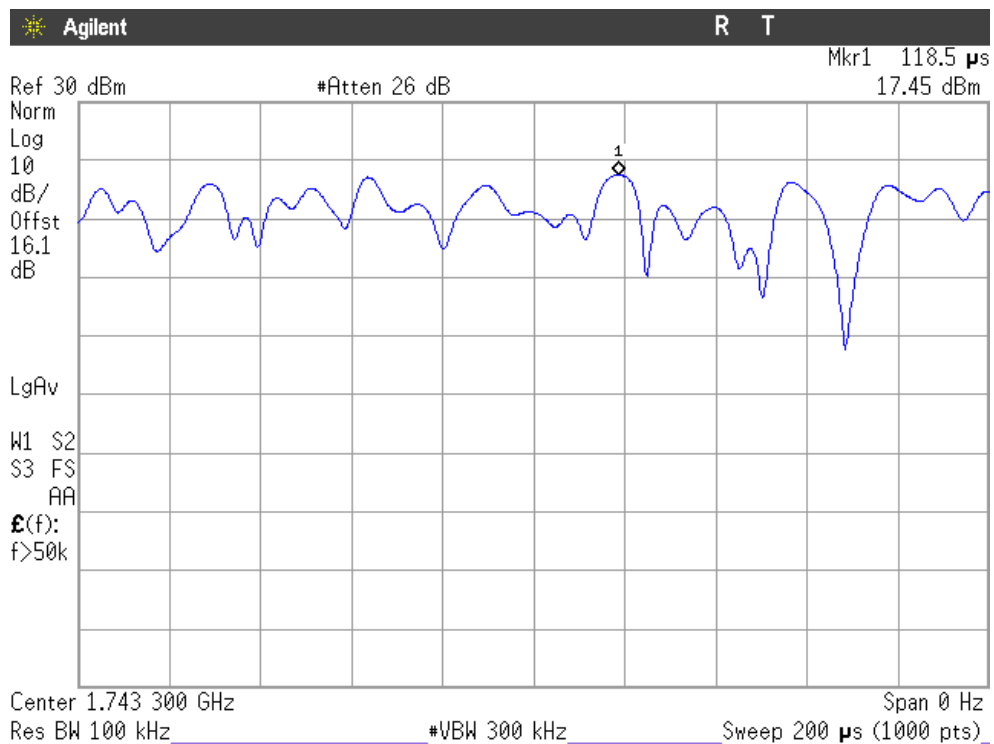

Occupied Bandwidth

SPECIFICATION

§2.1049

METHOD

The occupied bandwidth measurement was performed at the output terminals of the EUT using an attenuator, power splitter and spectrum analyser. The EUT was controlled via the Universal Radio Communication tester R&S CMW500 selecting maximum transmission power of the EUT and different modes of modulation. The 99% occupied bandwidth and the -26 dBc bandwidth were measured directly using the built-in bandwidth measuring option of spectrum analyser.

TEST SETUP

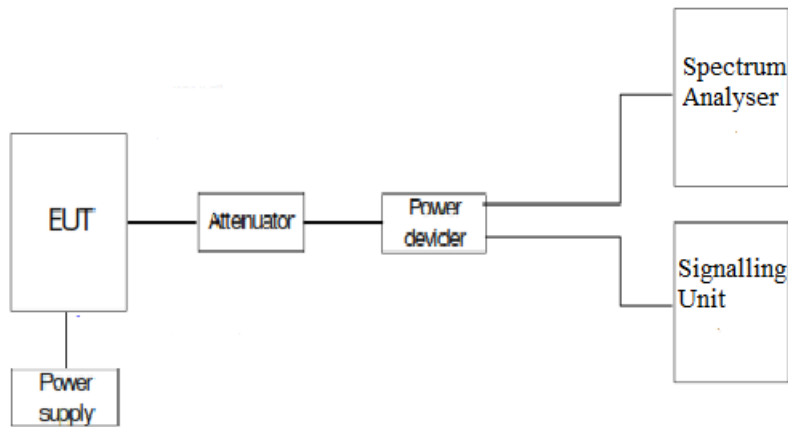

RESULTS (see next plots)

The worst case of occupied bandwidth corresponds to all Resource Blocks (RB) offset 0 regardless either the Narrow band position or the nominal bandwidth selected.

LTE QPSK MODULATION. BW = 5 MHz (Band 12). Narrow band: 1.

Channel	Lowest	Middle	Highest
99% Occupied bandwidth (MHz)	1.116	1.138	1.108
-26 dBc bandwidth (MHz)	1.362	1.459	1.385
Measurement uncertainty (kHz)	<±16.67		

LTE 16QAM MODULATION. BW = 5 MHz (Band 12). Narrow band: 1.

Channel	Lowest	Middle	Highest
99% Occupied bandwidth (MHz)	0.965	0.953	0.949
-26 dBc bandwidth (MHz)	1.377	1.405	1.340
Measurement uncertainty (kHz)	<±16.67		

LTE QPSK MODULATION. BW = 5 MHz (Band 66). Narrow band: 1.

Channel	Lowest	Middle	Highest
99% Occupied bandwidth (MHz)	1.110	1.105	1.113
-26 dBc bandwidth (MHz)	1.422	1.450	1.438
Measurement uncertainty (kHz)	<±16.67		

LTE 16QAM MODULATION. BW = 5 MHz (Band 66). Narrow band: 1.

Channel	Lowest	Middle	Highest
99% Occupied bandwidth (MHz)	0.952	0.938	0.932
-26 dBc bandwidth (MHz)	1.465	1.330	1.313
Measurement uncertainty (kHz)	<±16.67		

LTE QPSK MODULATION. BW = 5 MHz (Band 12)

Lowest Channel

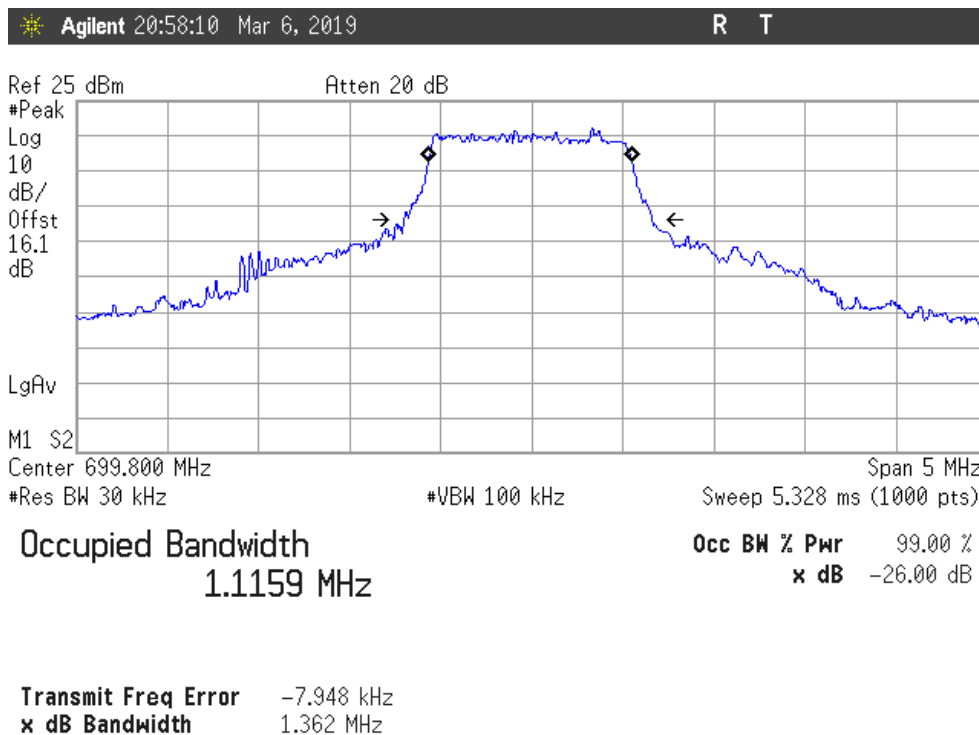

Middle Channel

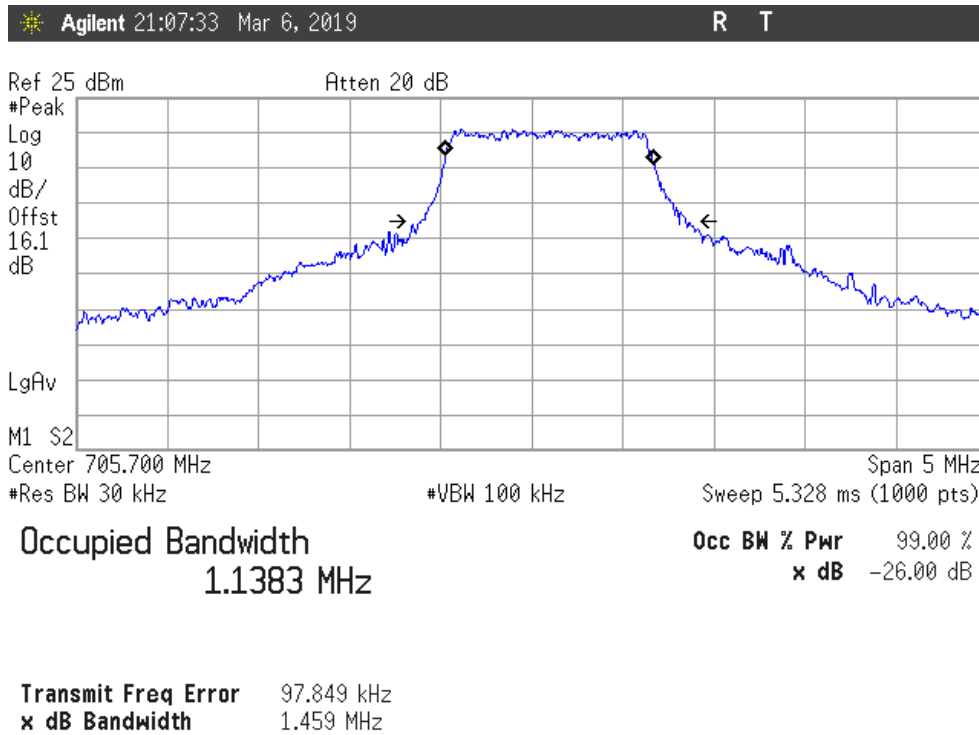

Highest Channel

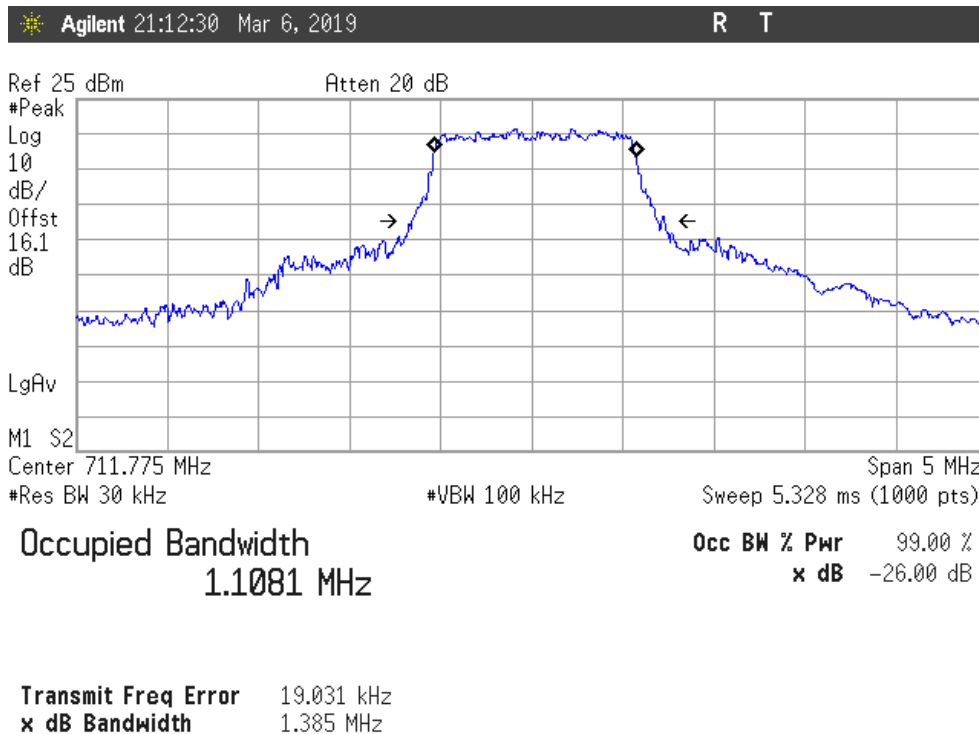

LTE 16QAM MODULATION. BW = 5 MHz (Band 12)

Lowest Channel

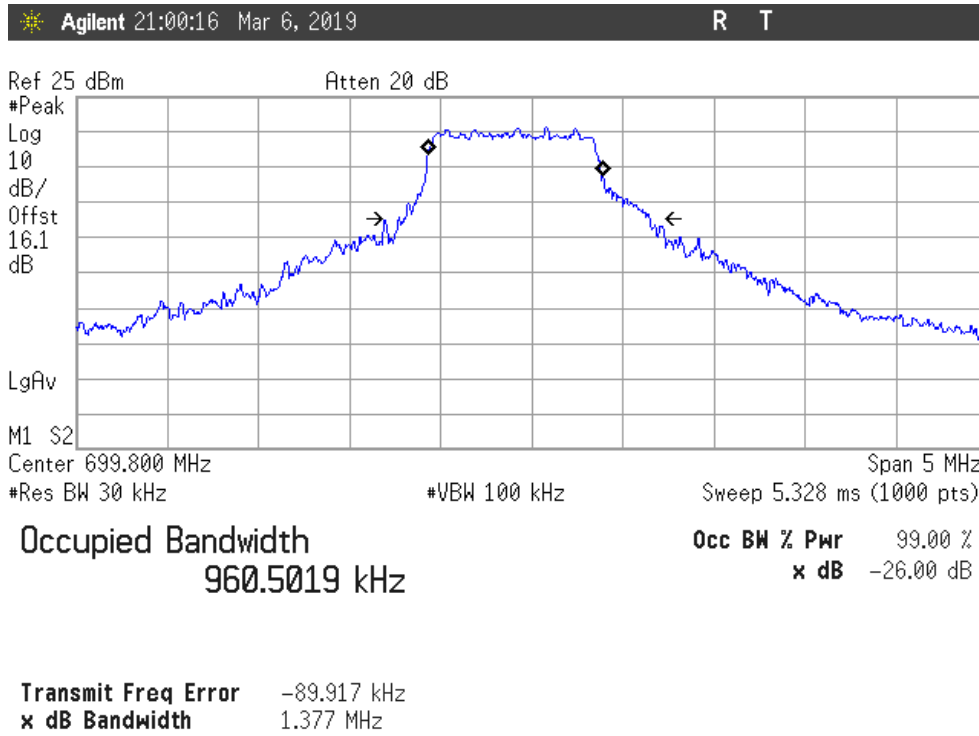

Middle Channel

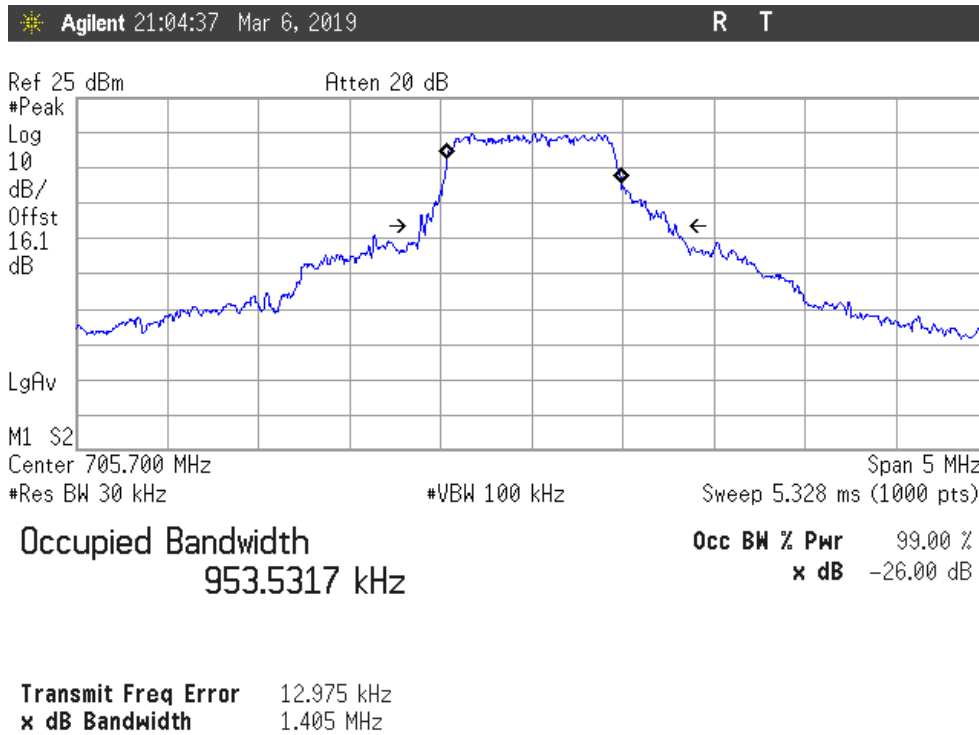

Highest Channel

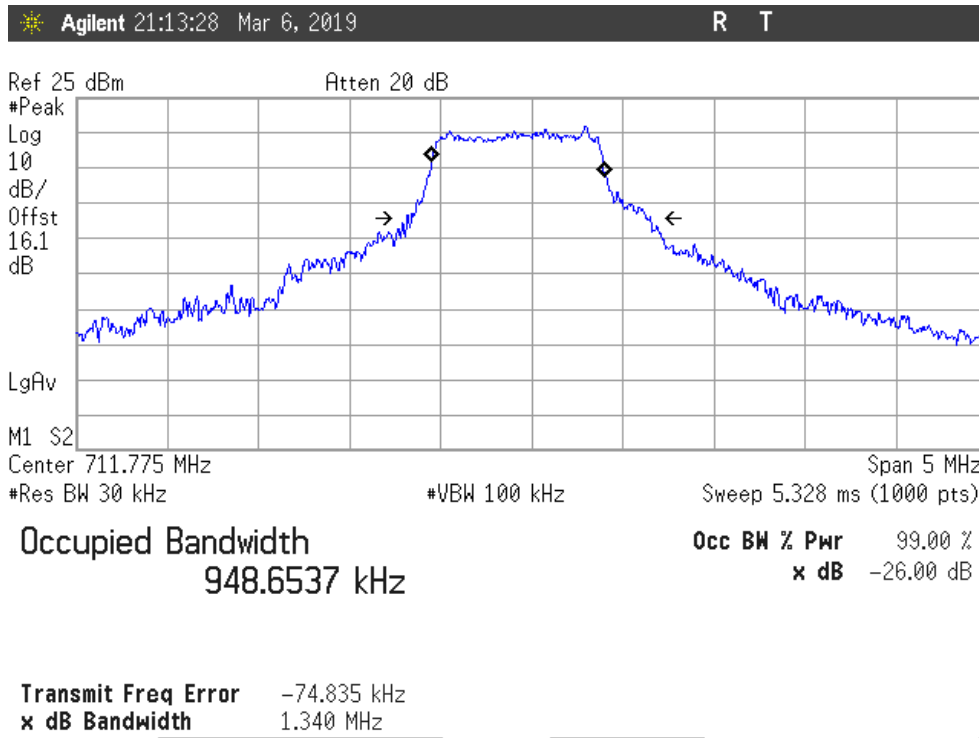

LTE QPSK MODULATION. BW = 5 MHz (Band 66)

Lowest Channel

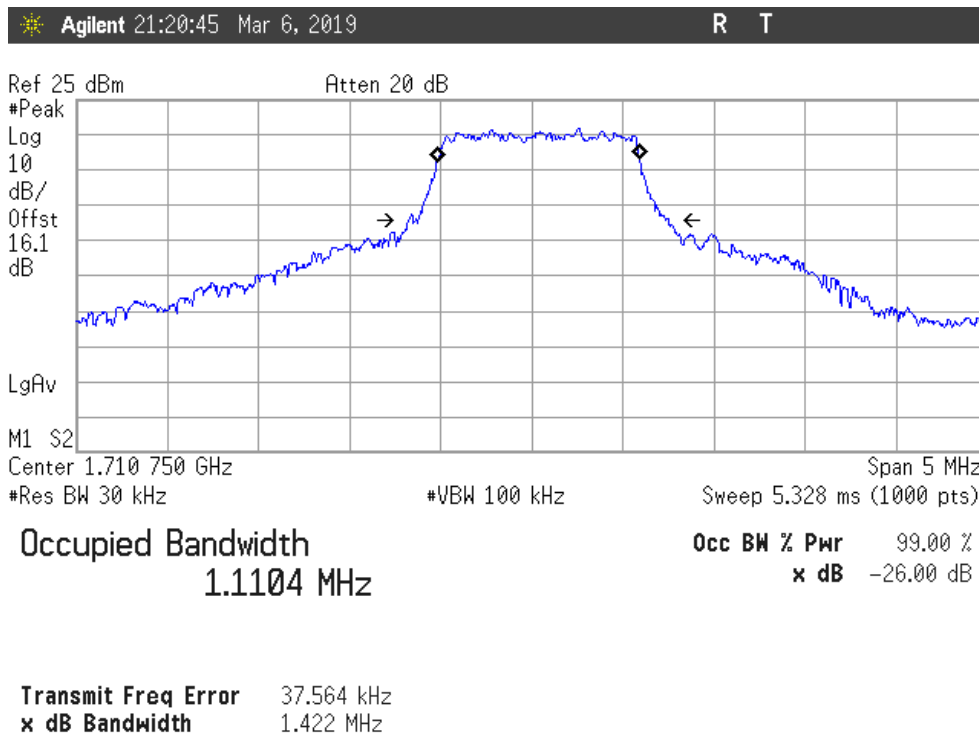

Middle Channel

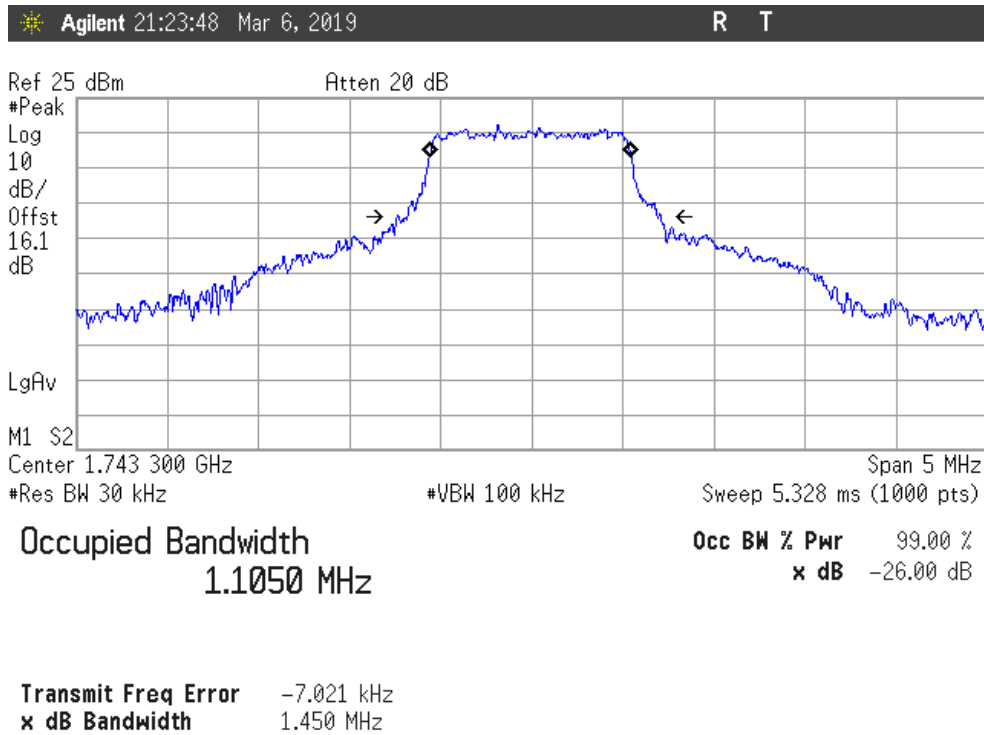

Highest Channel

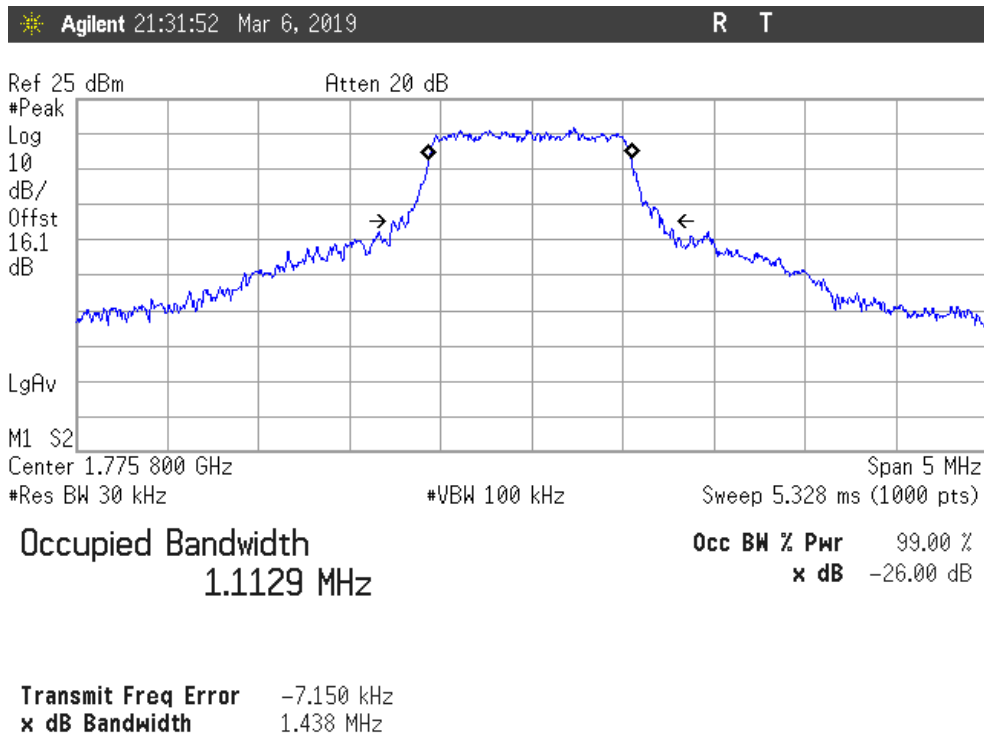

LTE 16QAM MODULATION. BW = 5 MHz (Band 66)

Lowest Channel

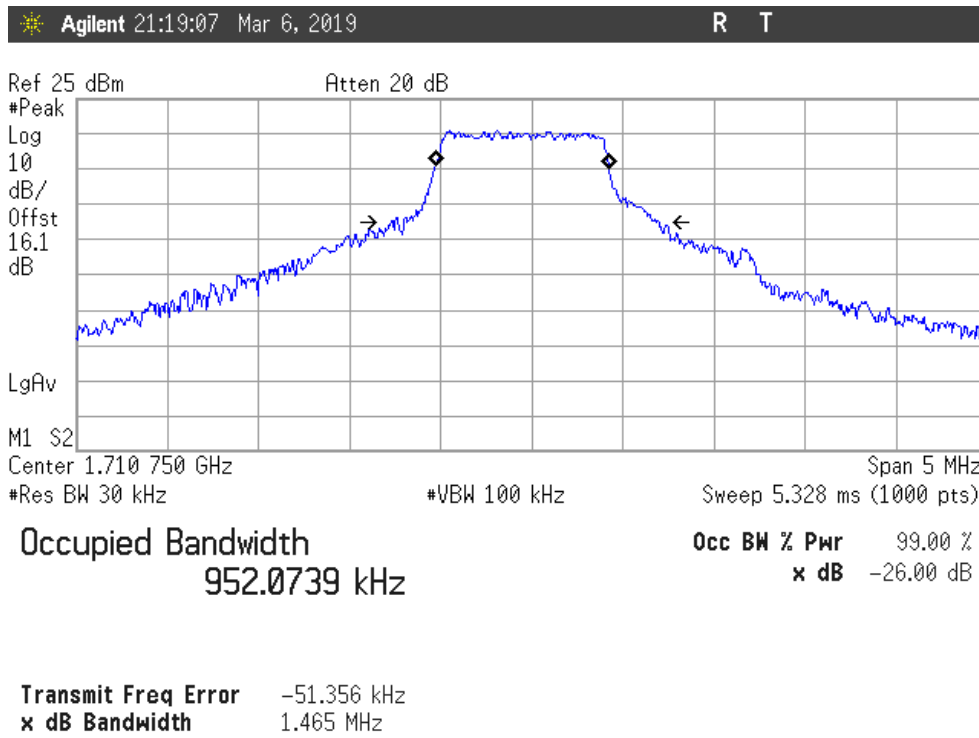

Middle Channel

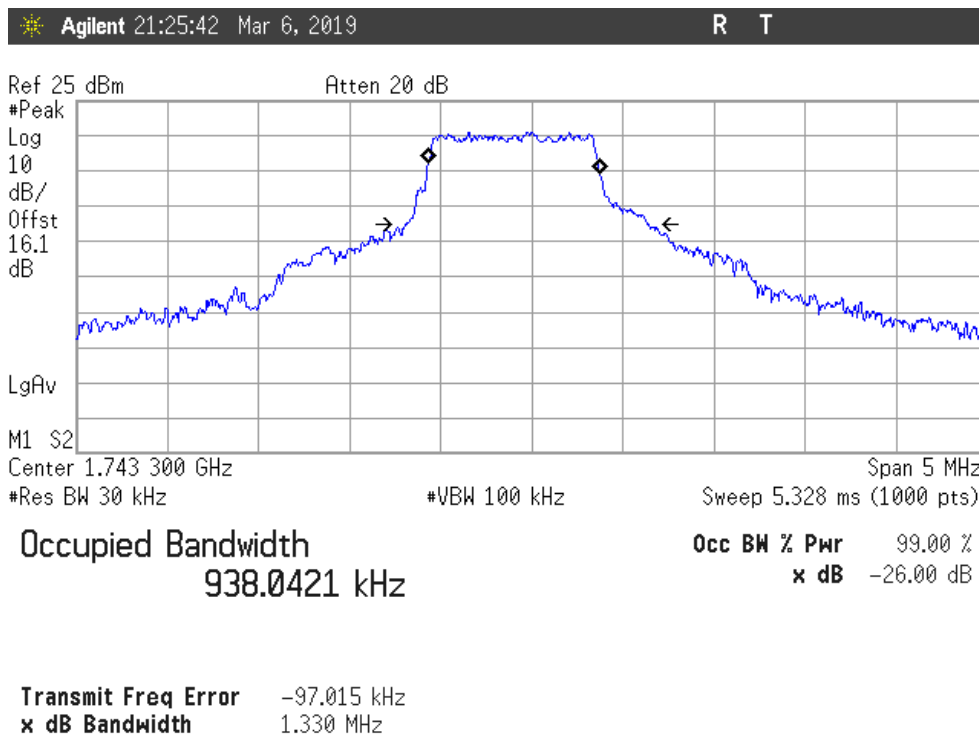

Highest Channel

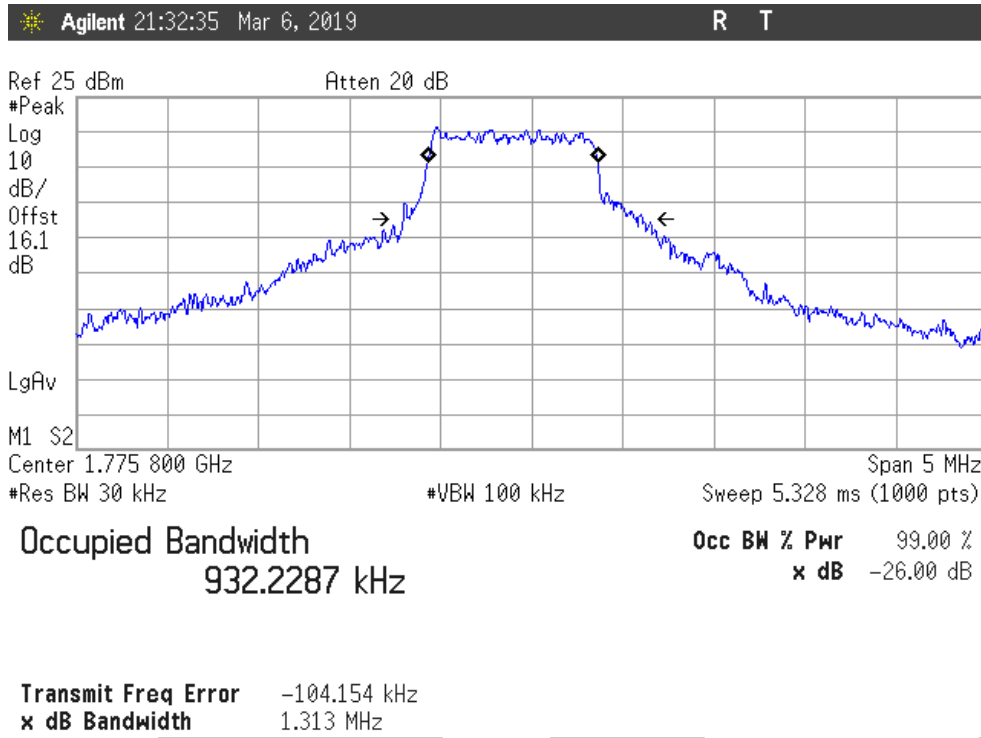

Spurious emissions at antenna terminals

SPECIFICATION

LTE BAND 12.

FCC §27.53 (g).

For operations in the 600 MHz band and the 698-746 MHz band, the power of any emission outside a licensee's frequency band(s) of operation shall be attenuated below the transmitter power (P) within the licensed band(s) of operation, measured in watts, by at least $43 + 10 \log (P)$ dB. Compliance with this provision is based on the use of measurement instrumentation employing a resolution bandwidth of 100 kilohertz or greater. However, in the 100 kilohertz bands immediately outside and adjacent to a licensee's frequency block, a resolution bandwidth of at least 30 kHz may be employed

RSS-130 Clause 4.6.

The power of any unwanted emissions in any 100 kHz bandwidth on any frequency outside the frequency range(s) within which the equipment is designed to operate shall be attenuated below the transmitter power, P (dBW), by at least $43 + 10 \log_{10} p$ (watts), dB.

LTE BAND 66.

FCC §27.53 (h). RSS-139 Clause 6.6.

According to specification. the power of emissions shall be attenuated below the transmitter power (P) by a factor of at least $43 + 10 \log (P)$ dB. P in watts.

At P_o transmitting power, the specified minimum attenuation becomes $43+10 \log (P_o)$, and the level in dBm relative P_o becomes:

P_o (dBm) – $[43 + 10 \log (P_o \text{ in mwatts}) - 30] = -13$ dBm.

METHOD

The EUT RF output connector was connected to a spectrum analyser and to the Universal Radio Communication tester R&S CMW500 (selecting maximum transmission power of the EUT and different modes of modulation) using a 50 ohm attenuator and a power divider.

The spectrum was investigated from 9 kHz to 18 GHz for LTE Band 66 and from 9 kHz to 8 GHz for LTE Band 12.

The reading of the spectrum analyser is corrected with the attenuation loss of connection between output terminal of EUT and input of the spectrum analyser.

The configuration of Resource Blocks and modulation which is the worst case for conducted power was used.

TEST SETUP

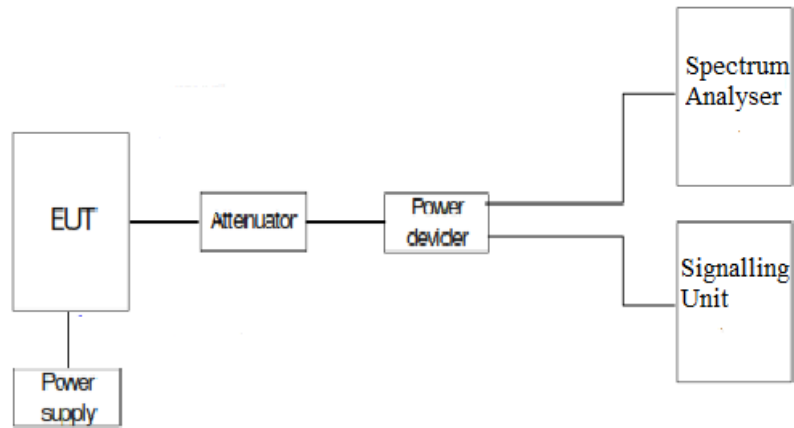

RESULTS (see plots in next pages)

LTE Band 12

1. CHANNEL: LOWEST

No spurious signals were found at less than 20dB respect to the limit in all the range.

2. CHANNEL: MIDDLE

No spurious signals were found at less than 20dB respect to the limit in all the range.

3. CHANNEL: HIGHEST

No spurious signals were found at less than 20dB respect to the limit in all the range.

LTE Band 66

1. CHANNEL: LOWEST

No spurious signals were found at less than 20dB respect to the limit in all the range.

2. CHANNEL: MIDDLE

No spurious signals were found at less than 20dB respect to the limit in all the range.

3. CHANNEL: HIGHEST

No spurious signals were found at less than 20dB respect to the limit in all the range.

Verdict: PASS

LTE Band 12

1. CHANNEL: LOWEST

Frequency Range 9 kHz – 8 GHz

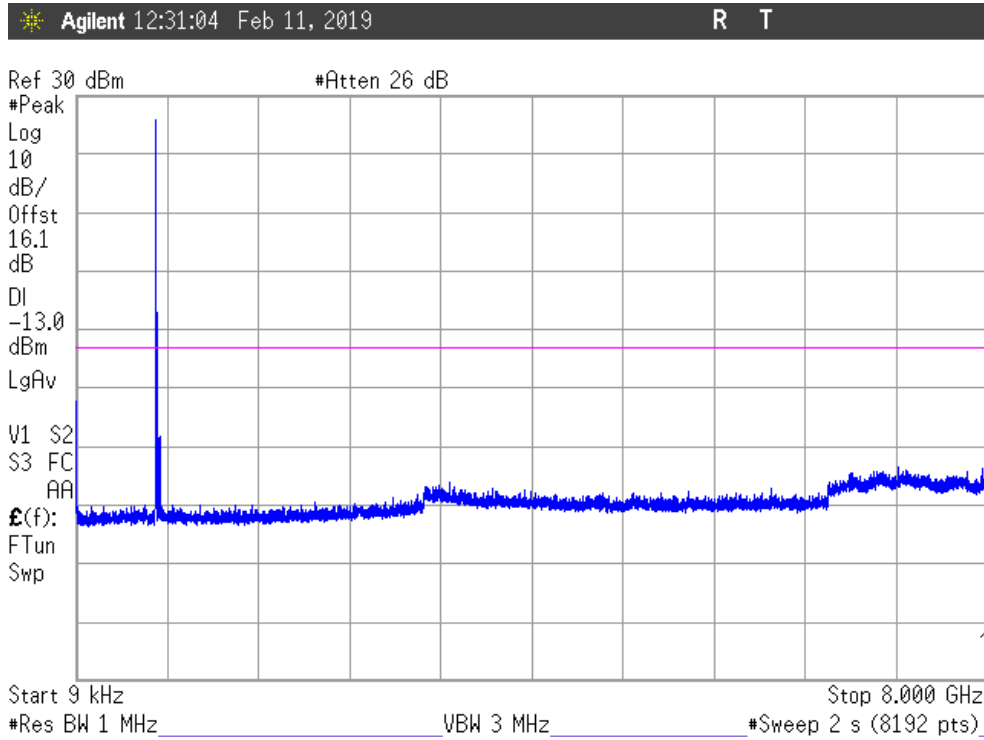

Note: The peak above the limit is the carrier frequency.

2. CHANNEL: MIDDLE

Frequency Range 9 kHz – 8 GHz

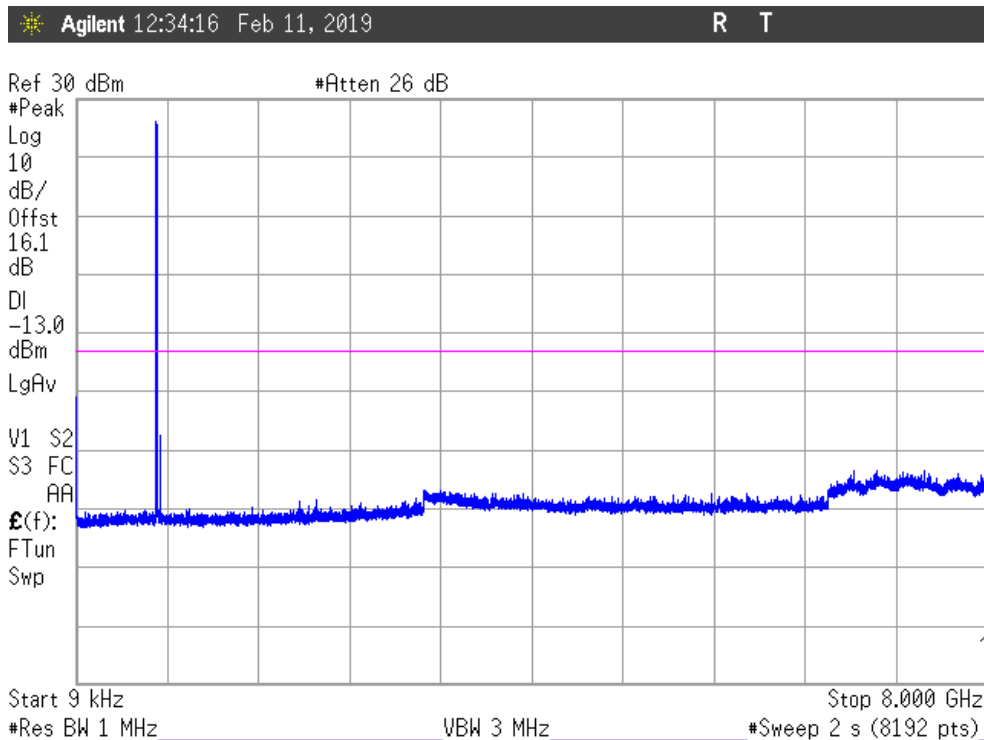

Note: The peak above the limit is the carrier frequency.

3. CHANNEL: HIGHEST

Frequency Range 9 kHz – 8 GHz

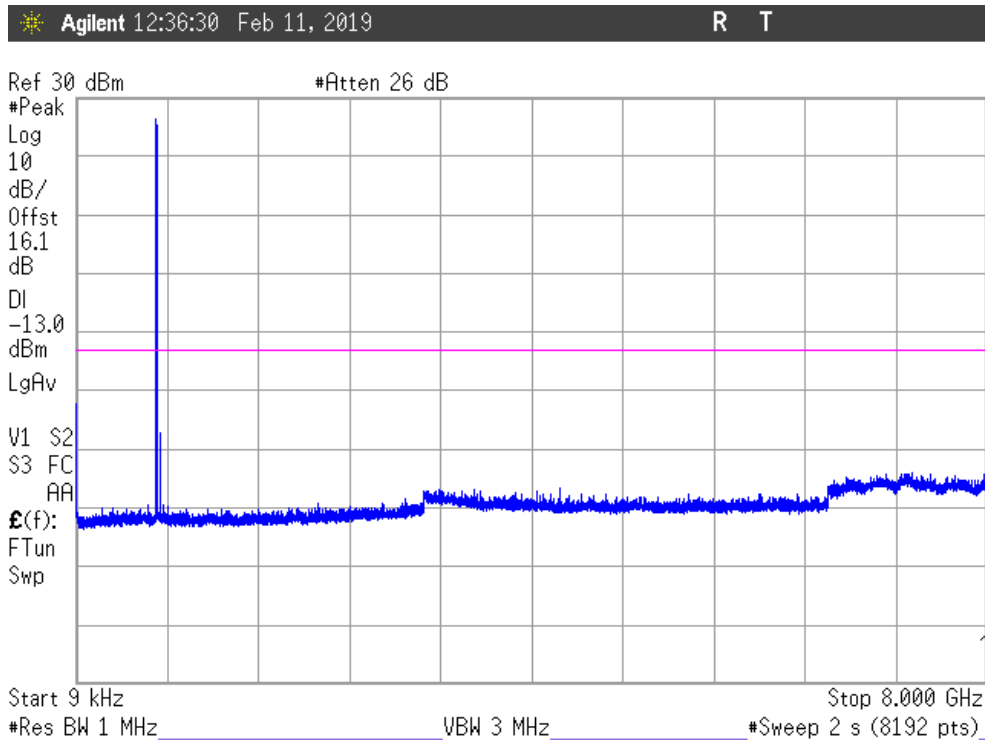

Note: The peak above the limit is the carrier frequency.

LTE Band 66

1. CHANNEL: LOWEST

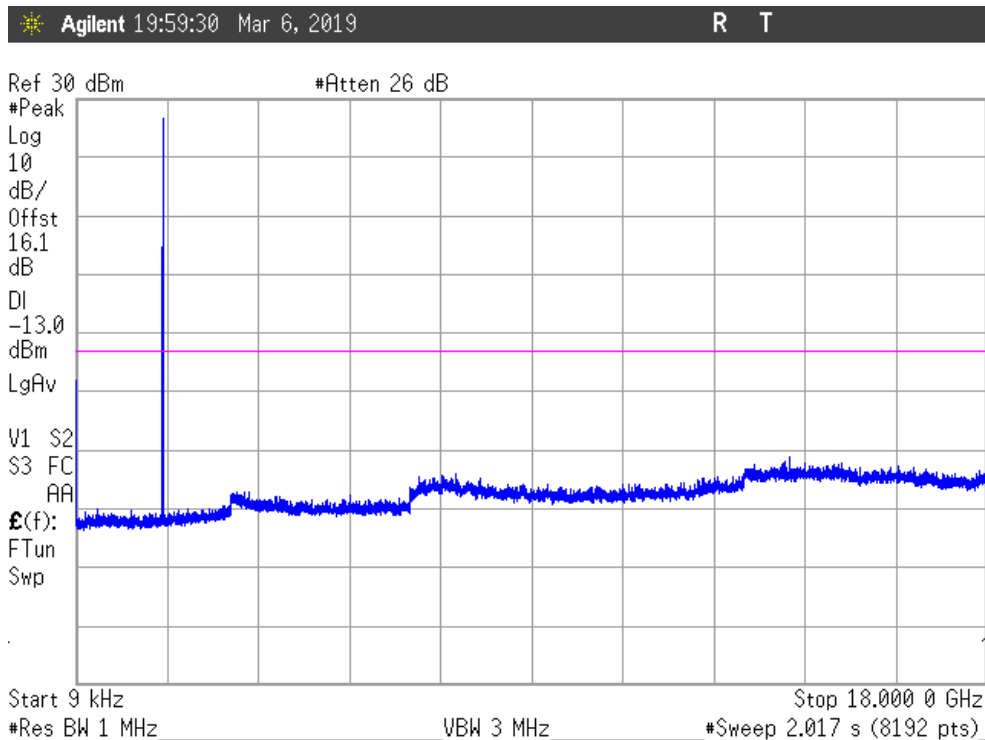

Note: The peak above the limit is the carrier frequency.

2. CHANNEL: MIDDLE

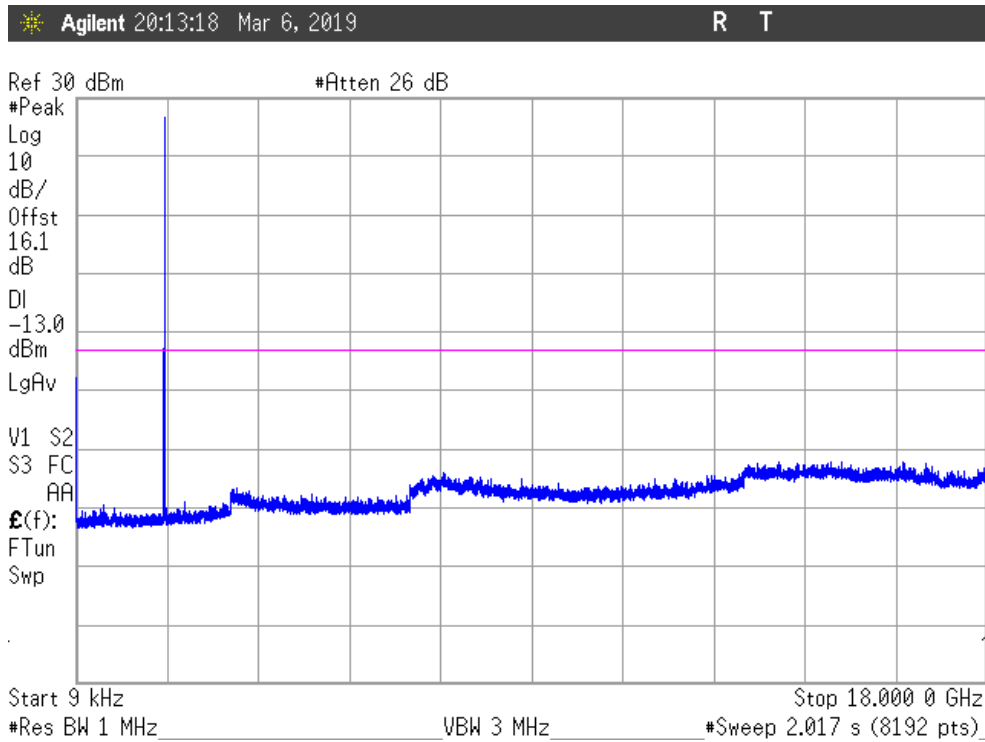

Note: The peak above the limit is the carrier frequency.

3. CHANNEL: HIGHEST

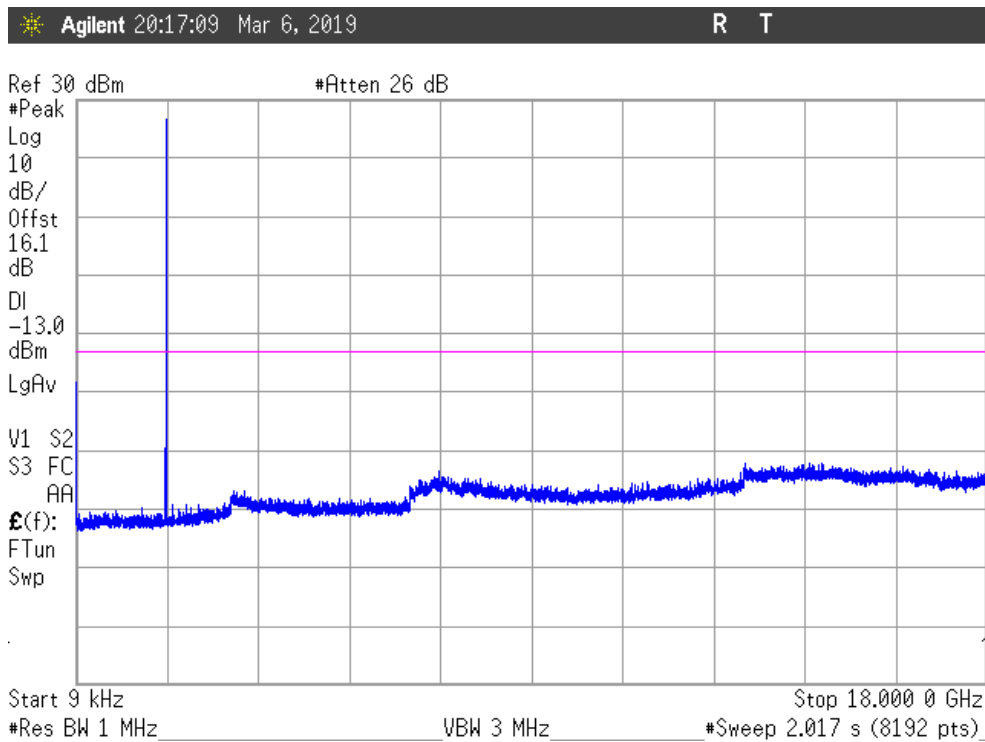

Note: The peak above the limit is the carrier frequency.

Spurious emissions at antenna terminals at Block Edges

SPECIFICATION

FCC §27.53. RSS-130 Clause 4.6. RSS-139 Clause 6.6.

According to specification. the power of emissions shall be attenuated below the transmitter power (P) by a factor of at least $43 + 10 \log (P)$ dB. P in watts.

At P_o transmitting power. the specified minimum attenuation becomes $43+10\log (P_o)$. and the level in dBm relative P_o becomes:

$$P_o \text{ (dBm)} - [43 + 10 \log (P_o \text{ in mwatts}) - 30] = -13 \text{ dBm}$$

METHOD

The EUT RF output connector was connected to a spectrum analyser and to the Universal Radio Communication tester R&S CMW500 (selecting maximum transmission power of the EUT and different modes of modulation) using a 50 ohm attenuator and a power splitter.

The reading of the spectrum analyser is corrected with the attenuation loss of connection between output terminal of EUT and input of the spectrum analyser.

The configuration of modulation which is the worst case for conducted power was used.

For LTE Band12, as indicated in FCC part 27.53 (g) /RSS-130 Clause 4.6., in the 100 kHz bands immediately outside and adjacent to the licensee's frequency block or band, a resolution bandwidth of 30 kHz may be employed.

For LTE Band 66, as indicated in FCC part 27.53 (h) (3) /RSS-139 Clause 6.6., in the 1 MHz bands immediately outside and adjacent to the licensee's frequency block, a resolution bandwidth of at least one percent of the emission bandwidth/occupied bandwidth of the fundamental emission of the transmitter may be employed.

TEST SETUP

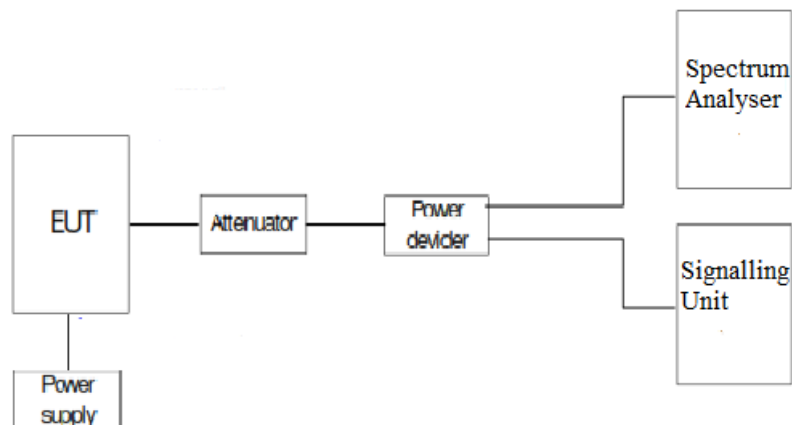

RESULTS (see plots in next pages)

LTE. BAND 12.

Preliminary measurements determined the narrow band = 1 and nominal bandwidth of 1.4 MHz as the worst case. The results in the next tables shows the results for this configuration.

(Channels in Band 12):	RB=1. Offset=0. Narrow band = 1 BW=1.4 MHz	RB= All. Offset=0. Narrow band = 1 BW=1.4 MHz
Maximum measured level at lowest Block Edge at antenna port (dBm)	-36.98	-32.25

(Channels in Band 12):	RB= 1. Offset=Max. Narrow band = 1 BW=1.4 MHz	RB= All. Offset=0. Narrow band = 1 BW=1.4 MHz
Maximum measured level at highest Block Edge at antenna port (dBm)	-13.91	-24.24

LTE. BAND 66.

Preliminary measurements determined the narrow band = 1 and nominal bandwidth of 1.4 MHz as the worst case. The results in the next tables shows the results for this configuration.

(Channels in Band 66):	RB=1. Offset=0. Narrow band = 1 BW=1.4 MHz	RB= All. Offset=0. Narrow band = 1 BW=1.4 MHz
Maximum measured level at lowest Block Edge at antenna port (dBm)	-17.13	-19.72

(Channels in Band 66):	RB= 1. Offset=Max. Narrow band = 1 BW=1.4 MHz	RB= All. Offset=0. Narrow band = 1 BW=1.4 MHz
Maximum measured level at highest Block Edge at antenna port (dBm)	-18.37	-16.44

Measurement uncertainty = ± 1.20 dB.

Verdict: PASS

LTE. BAND 12.

Narrow band = 1. RB = 1. Offset = 0. BW = 1.4 MHz

CHANNEL LOWEST

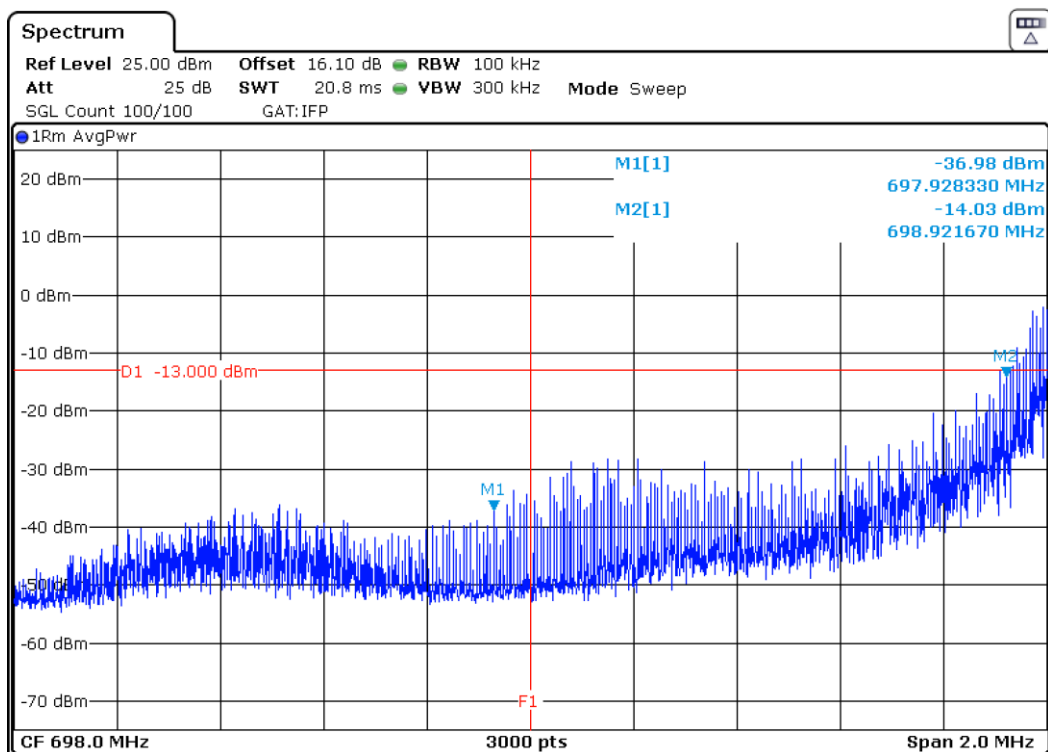

NOTE: The equipment transmits at the maximum output power

Narrow band = 1. RB = 1. Offset = Max. BW = 1.4 MHz

CHANNEL HIGHEST

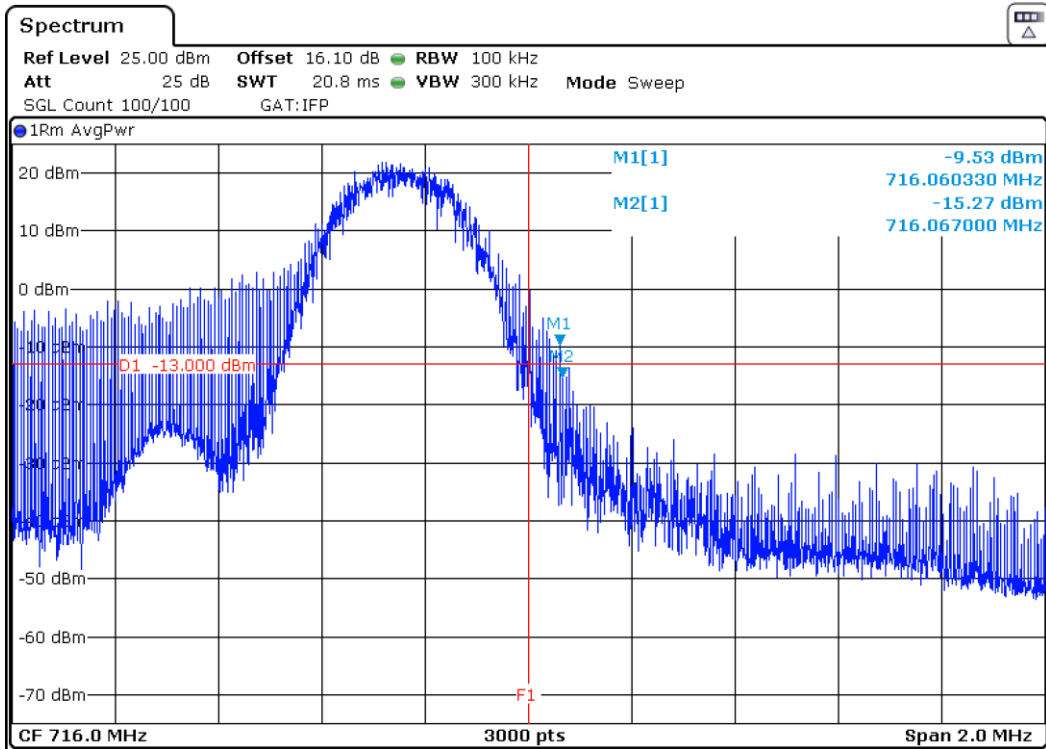

NOTE: The equipment transmits at the maximum output power

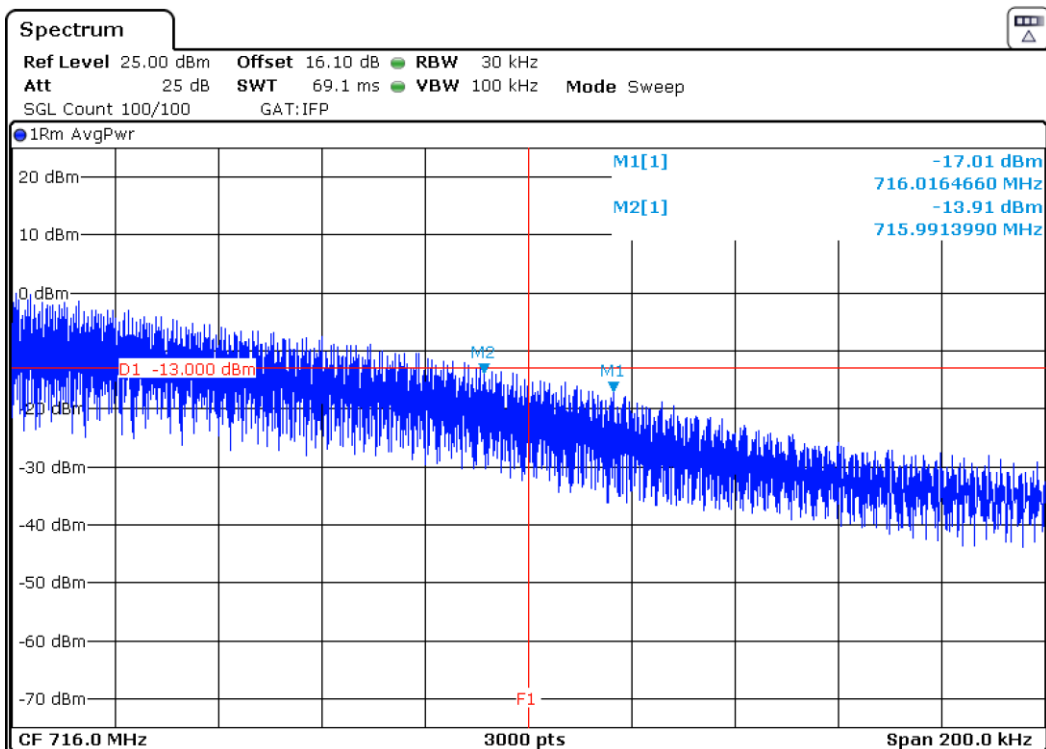

NOTE: Zoom (100KHz) with RBW=30KHz.

Narrow band = 1. RB = All. Offset = 0. BW = 1.4 MHz

CHANNEL LOWEST

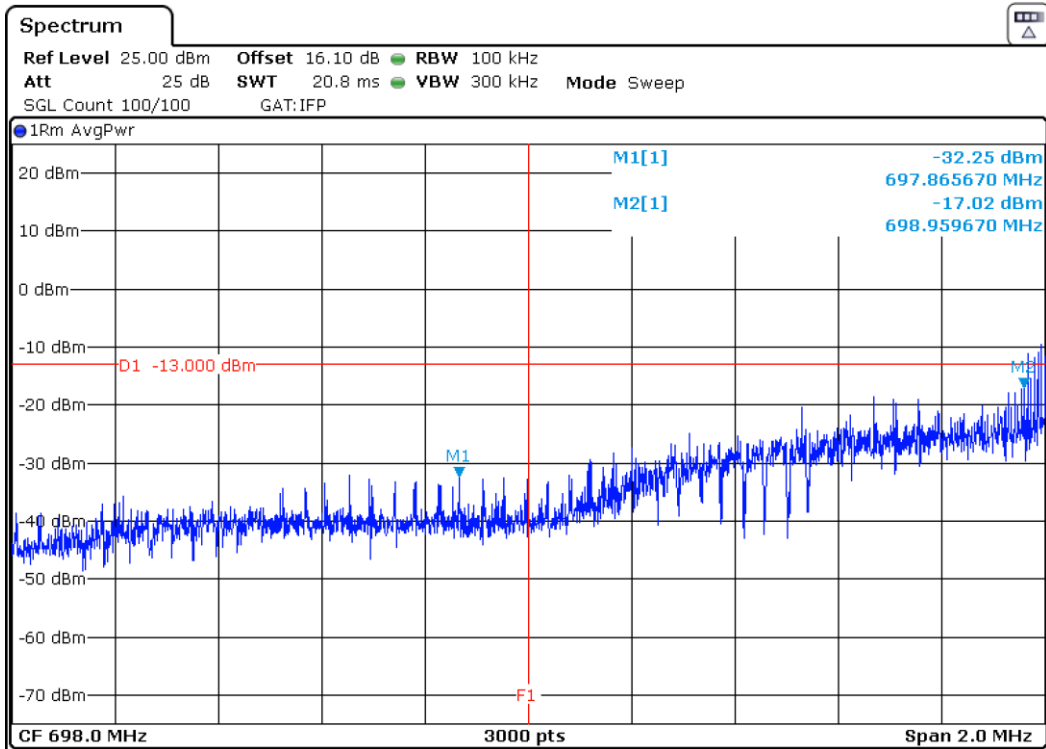

NOTE: The equipment transmits at the maximum output power

Narrow band = 1. RB = All. Offset = 0. BW = 1.4 MHz

CHANNEL HIGHEST

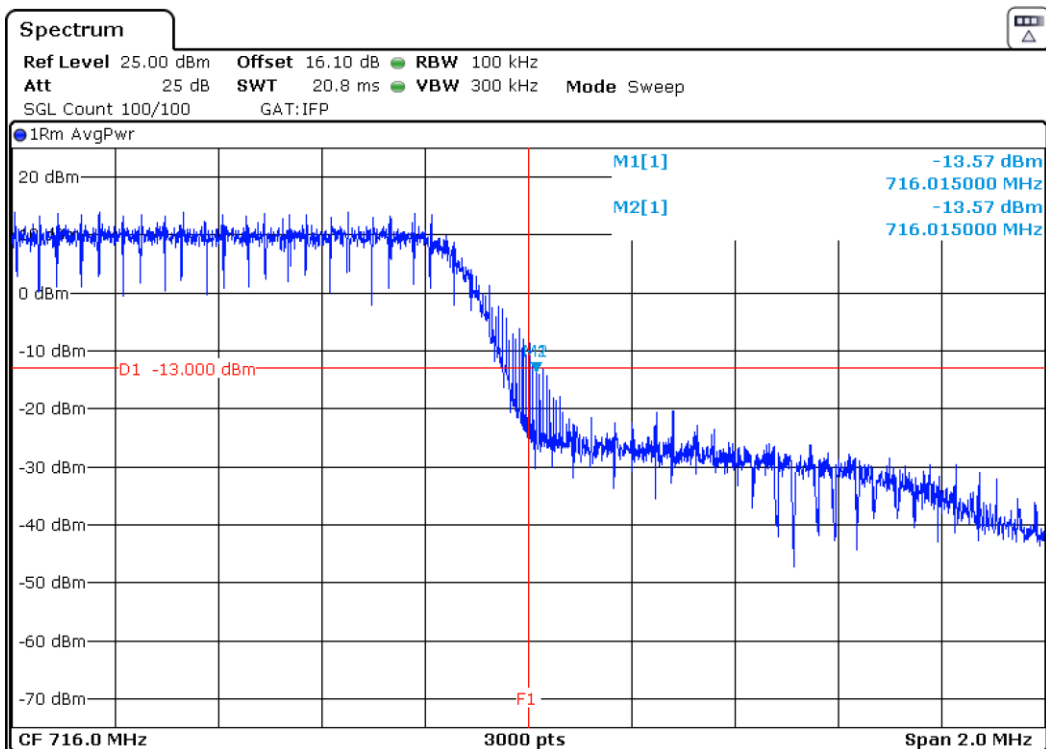

NOTE: The equipment transmits at the maximum output power

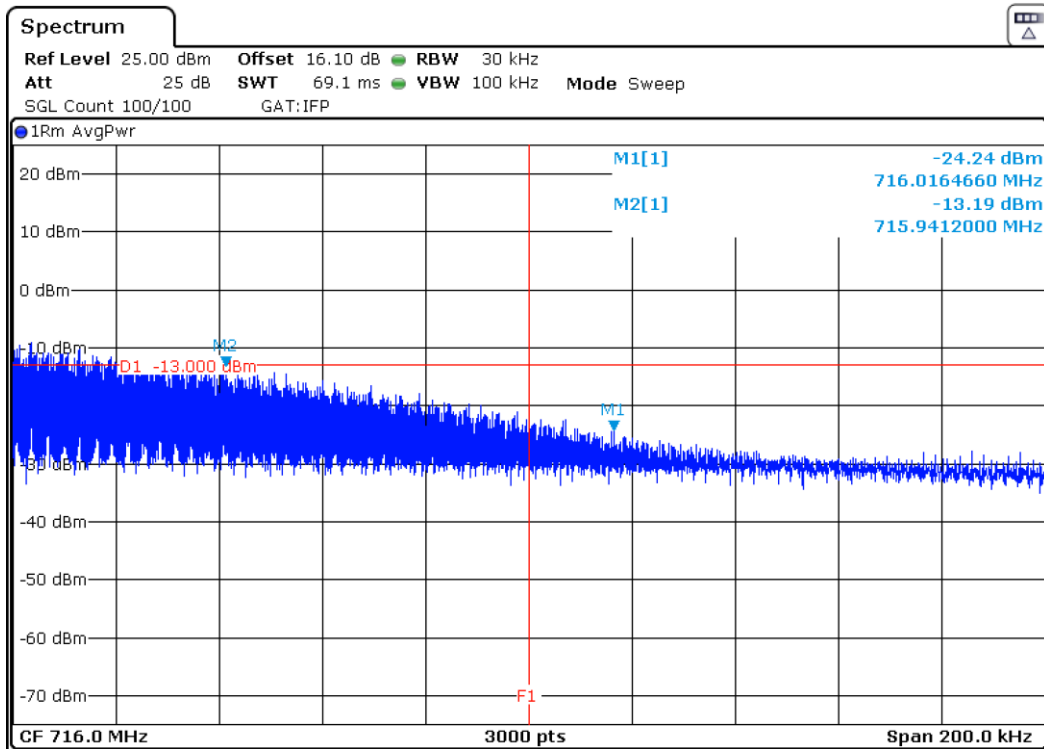

NOTE: Zoom (100KHz) with RBW=30KHz.

Verdict: PASS

LTE. BAND 66.

Narrow band = 1. RB = 1. Offset = 0. BW = 1.4 MHz

CHANNEL LOWEST

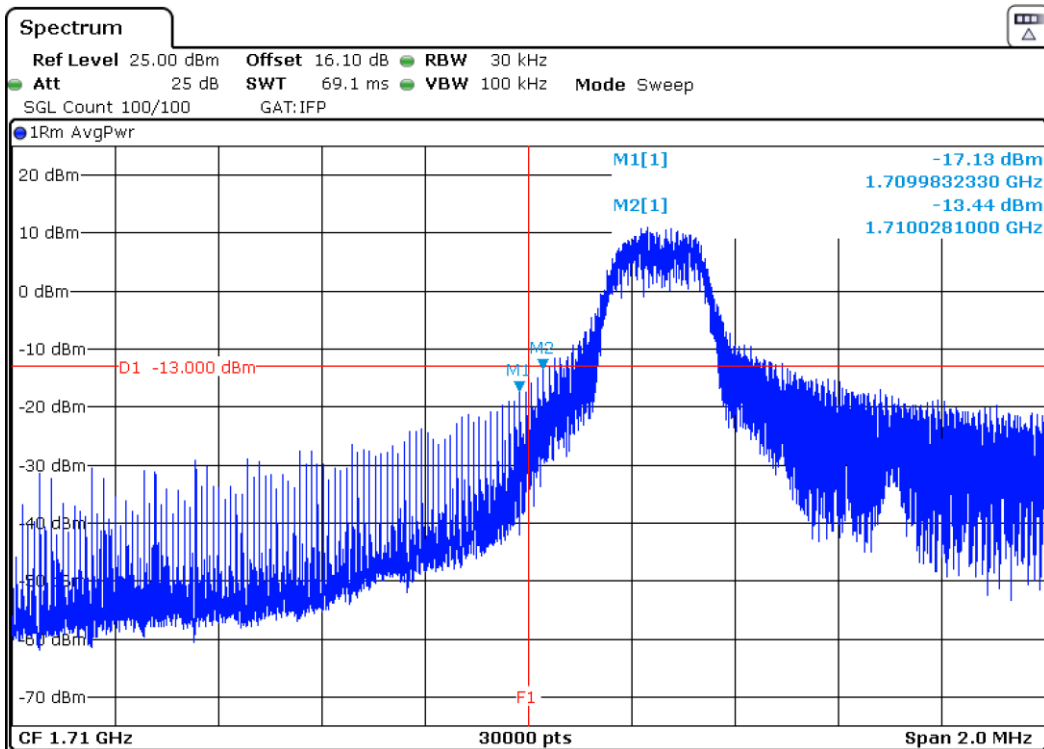

NOTE: The equipment transmits at the maximum output power

Narrow band = 1. RB = 1. Offset = Max. BW = 1.4 MHz

CHANNEL HIGHEST

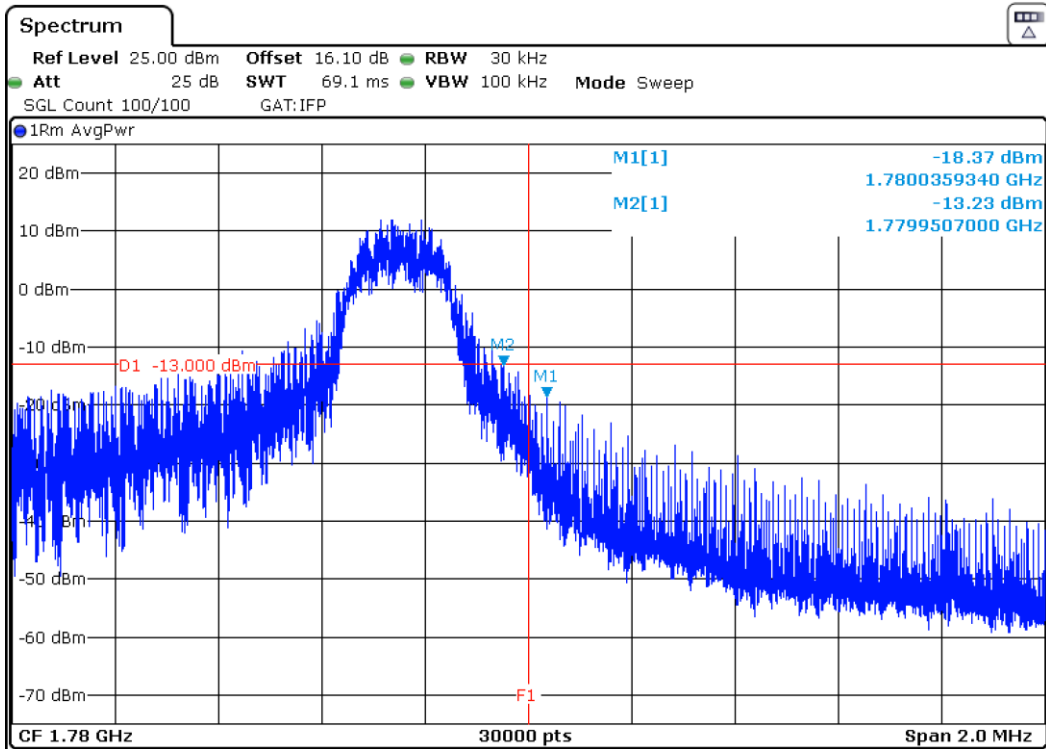

NOTE: The equipment transmits at the maximum output power

Narrow band = 1. RB = Max. Offset = 0. BW = 1.4 MHz

CHANNEL LOWEST

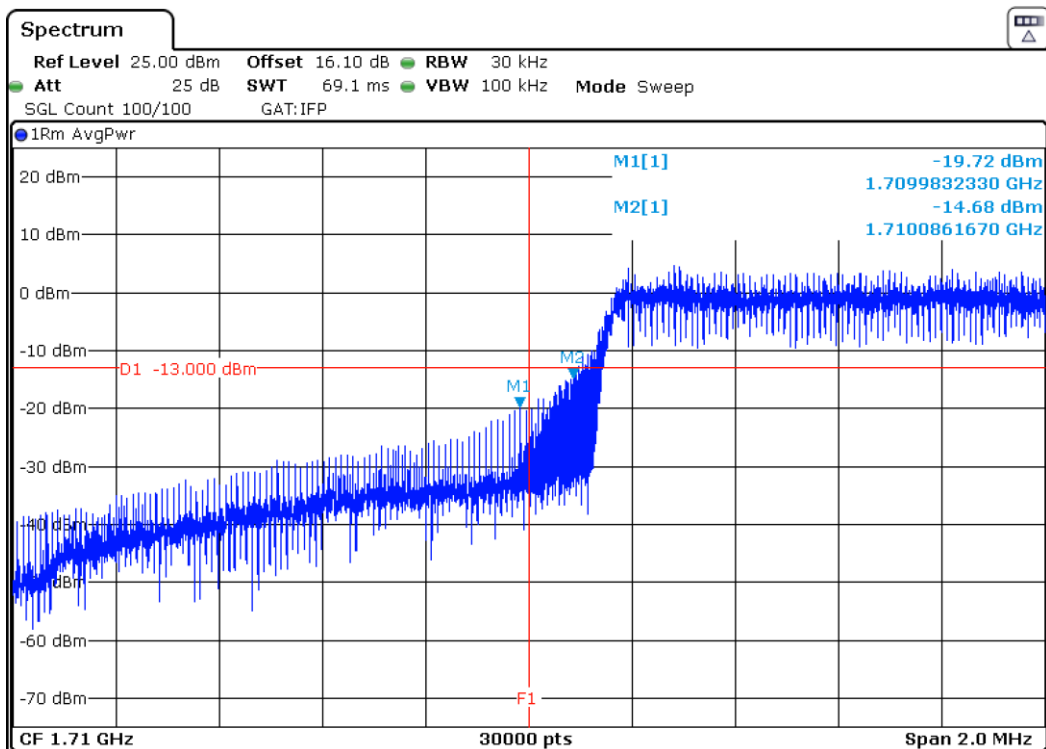

NOTE: The equipment transmits at the maximum output power

Narrow band = 1. RB = Max. Offset = 0. BW = 1.4 MHz

CHANNEL HIGHEST.

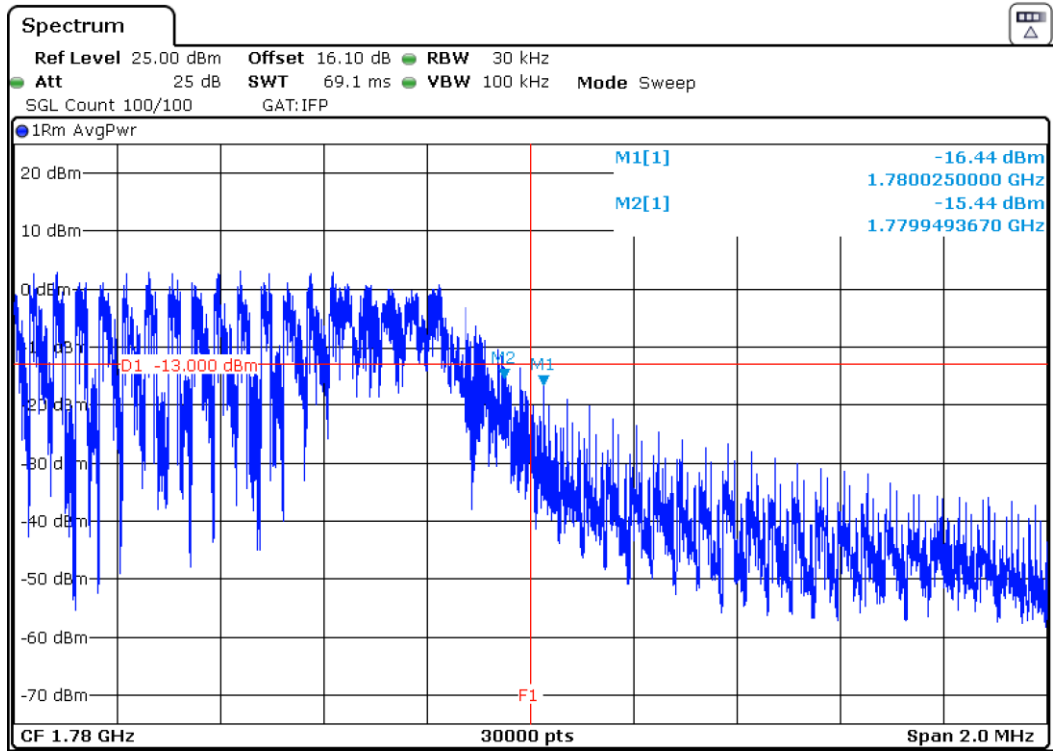

NOTE: The equipment transmits at the maximum output power

Verdict: PASS

Radiated emissions

SPECIFICATION

LTE BAND 12.

FCC §27.53 (g).

For operations in the 600 MHz band and the 698-746 MHz band, the power of any emission outside a licensee's frequency band(s) of operation shall be attenuated below the transmitter power (P) within the licensed band(s) of operation, measured in watts, by at least $43 + 10 \log (P)$ dB. Compliance with this provision is based on the use of measurement instrumentation employing a resolution bandwidth of 100 kilohertz or greater. However, in the 100 kilohertz bands immediately outside and adjacent to a licensee's frequency block, a resolution bandwidth of at least 30 kHz may be employed

RSS-130 Clause 4.6.

The power of any unwanted emissions in any 100 kHz bandwidth on any frequency outside the frequency range(s) within which the equipment is designed to operate shall be attenuated below the transmitter power, P (dBW), by at least $43 + 10 \log_{10} p$ (watts), dB.

LTE BAND 66.

FCC §27.53 (h). RSS-139 Clause 6.6.

According to specification, the power of emissions shall be attenuated below the transmitter power (P) by a factor of at least $43 + 10 \log (P)$ dB. P in watts.

At P_o transmitting power, the specified minimum attenuation becomes $43+10 \log (P_o)$, and the level in dBm relative P_o becomes:

P_o (dBm) – $[43 + 10 \log (P_o \text{ in mwatts}) - 30] = -13$ dBm.

METHOD

The measurement was performed with the EUT inside an anechoic chamber. The spectrum was scanned from 30 MHz to at least the 10th harmonic of the highest frequency generated within the equipment.

The EUT was placed on a non-conductive stand at a 3 meter distance from the measuring antenna for measurements below 1 GHz and at 1 m distance for measurements above 1 GHz.

Detected emissions were maximized at each frequency by rotating the EUT and adjusting the measuring antenna height and polarization. The maximum meter reading was recorded.

Each detected emission at less than 20 dB respect to the limit is substituted by the Substitution method in accordance with the ANSI/TIA-603-E: 2016.

TEST SETUP

Radiated measurements below 1 GHz.

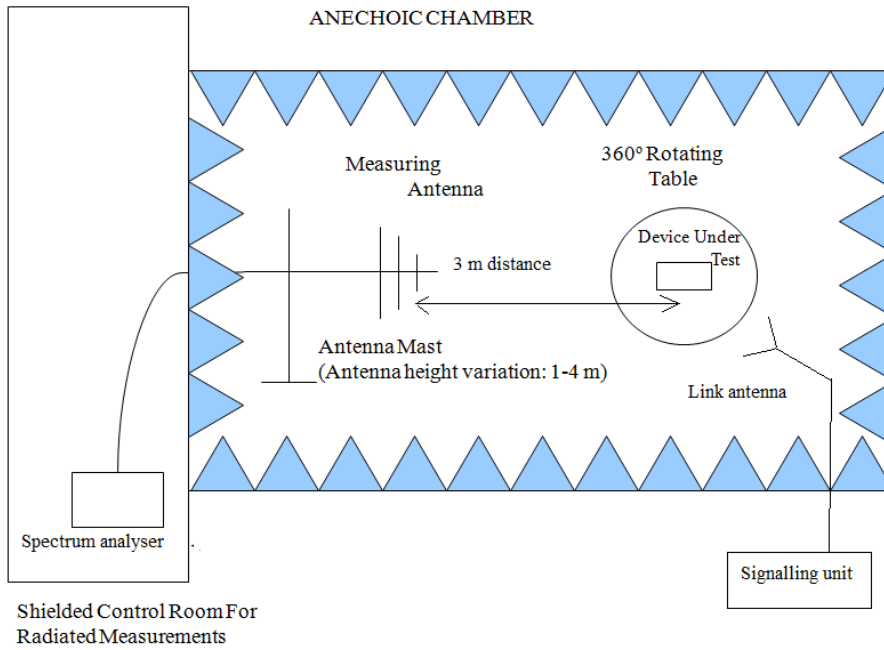

Radiated measurements above 1 GHz.

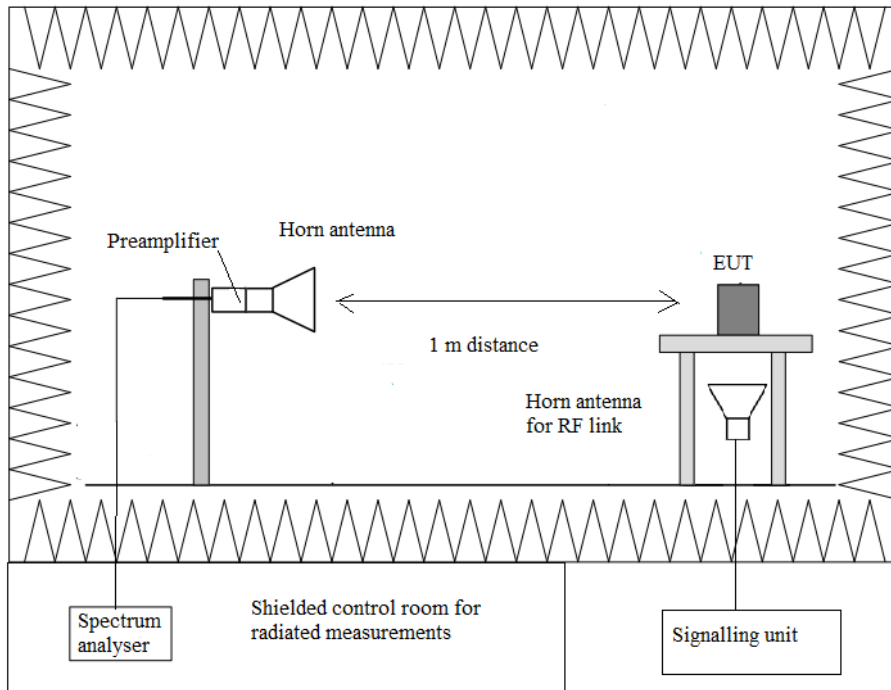

RESULTS

LTE. BAND 12.

A preliminary scan determined the QPSK 10 MHz bandwidth, Narrow band =1, RB = 1, as the worst case. The following tables and plots show the results for this configuration.

1. CHANNEL: LOWEST

Frequency range 30 MHz-1000 MHz.

No radiated spurious signals were detected at less than 20 dB respect to the limit.

Frequency range 1 GHz-8 GHz.

No radiated spurious signals were detected at less than 20 dB respect to the limit.

2. CHANNEL: MIDDLE

Frequency range 30 MHz-1000 MHz.

No radiated spurious signals were detected.

Frequency range 1 GHz-8 GHz.

No radiated spurious signals were detected at less than 20 dB respect to the limit.

3. CHANNEL: HIGHEST

Frequency range 30 MHz-1000 MHz.

No radiated spurious signals were detected.

Frequency range 1 GHz-8 GHz.

No radiated spurious signals were detected at less than 20 dB respect to the limit.

LTE. BAND 66.

A preliminary scan determined the QPSK 5 MHz bandwidth, Narrow band =1, RB = 1, as the worst case. The following tables and plots show the results for this configuration.

1. CHANNEL: LOWEST

Frequency range 30 MHz-1000 MHz.

No radiated spurious signals were detected at less than 20 dB respect to the limit.

Frequency range 1 GHz-18 GHz.

No radiated spurious signals were detected at less than 20 dB respect to the limit.

2. CHANNEL: MIDDLE

Frequency range 30 MHz-1000 MHz.

No radiated spurious signals were detected at less than 20 dB respect to the limit.

Frequency range 1 GHz-18 GHz.

Frequency (MHz)	Instrument reading (dBm)	Polarization	(1) Generator output (dBm)	(2) Cable loss (dB)	(3) Substitution antenna gain Gi (respect to isotropic radiator) (dB)	E.I.R.P. (dBm) = (1) – (2) + (3)
5228.75	-35.26	Horizontal	-39.94	1.70	12.15	-29.49

3. CHANNEL: HIGHEST

Frequency range 30 MHz-1000 MHz.

No radiated spurious signals were detected at less than 20 dB respect to the limit.

Frequency range 1 GHz-18 GHz.

Frequency (MHz)	Instrument reading (dBm)	Polarization	(1) Generator output (dBm)	(2) Cable loss (dB)	(3) Substitution antenna gain G_i (respect to isotropic radiator) (dB)	E.I.R.P. (dBm) = (1) – (2) + (3)
5326.25	-33.43	Horizontal	-38.01	1.73	12.40	-27.34
7101.25	-42.96	Horizontal	-39.16	2.13	10.05	-31.24

Verdict: PASS

FREQUENCY RANGE 30 MHz-1000 MHz.

LTE Band 12

CHANNEL: LOWEST

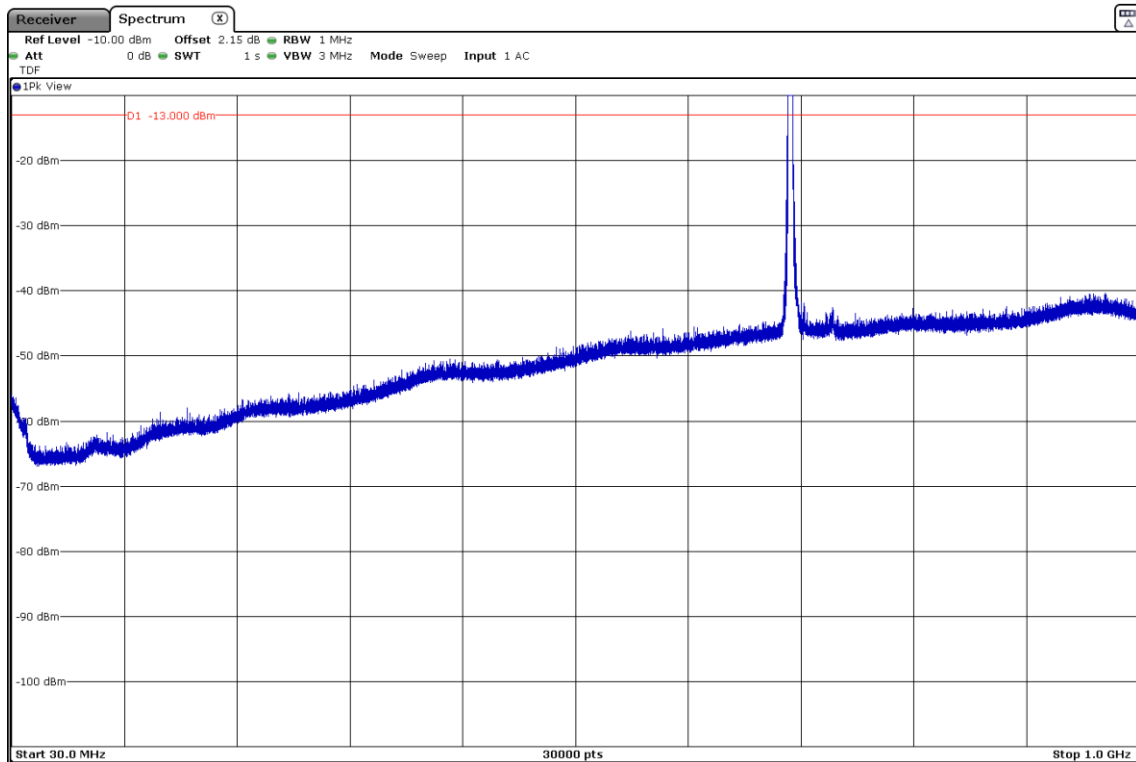

Note: The peak above the limit is the carrier frequency.

CHANNEL: MIDDLE

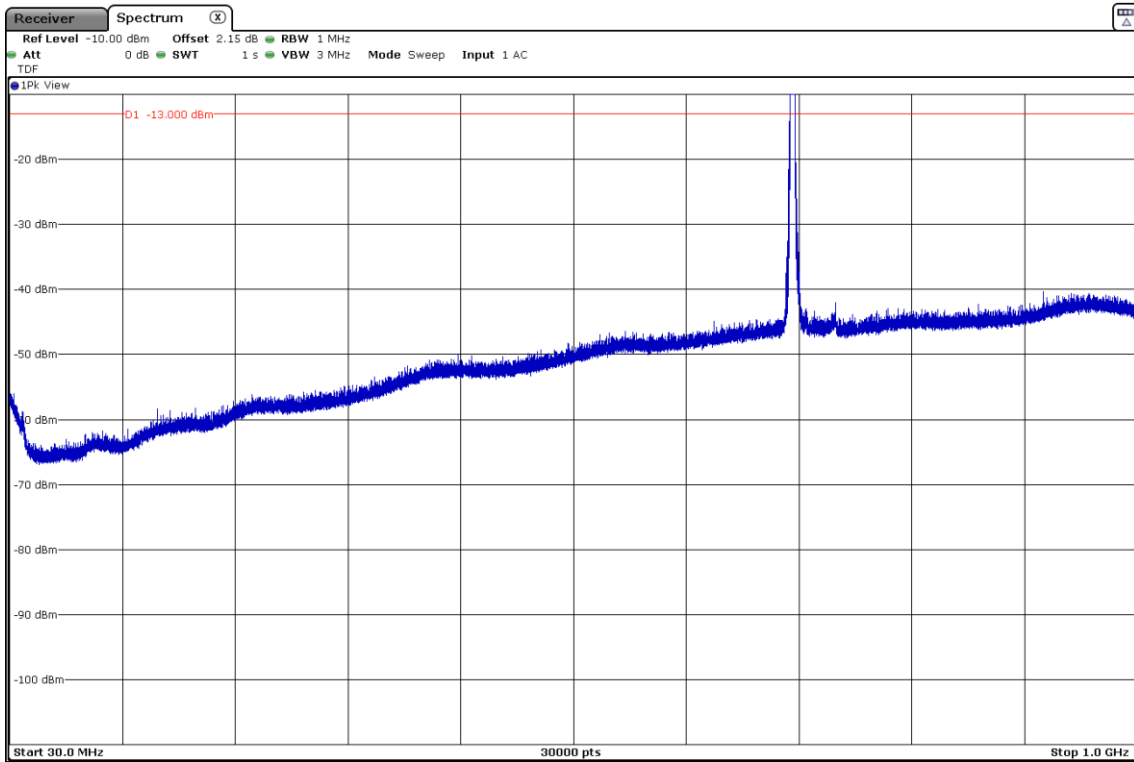

Note: The peak above the limit is the carrier frequency.

CHANNEL: HIGHEST

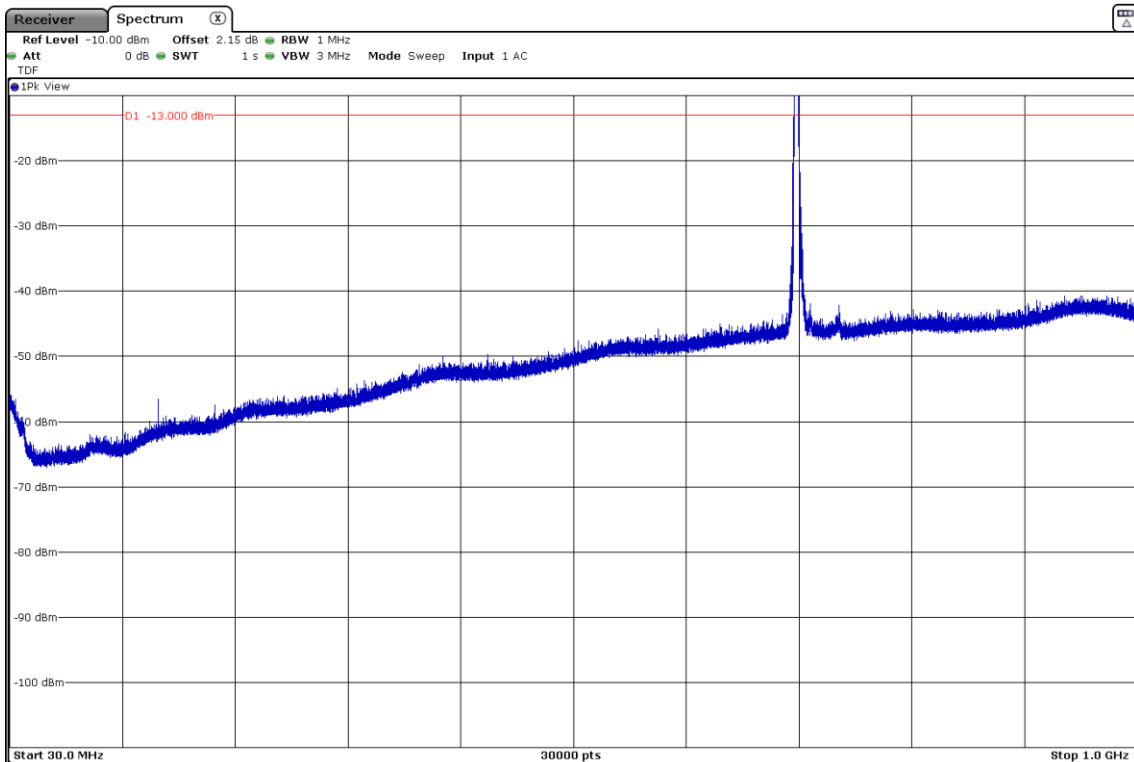

Note: The peak above the limit is the carrier frequency.

LTE Band 66

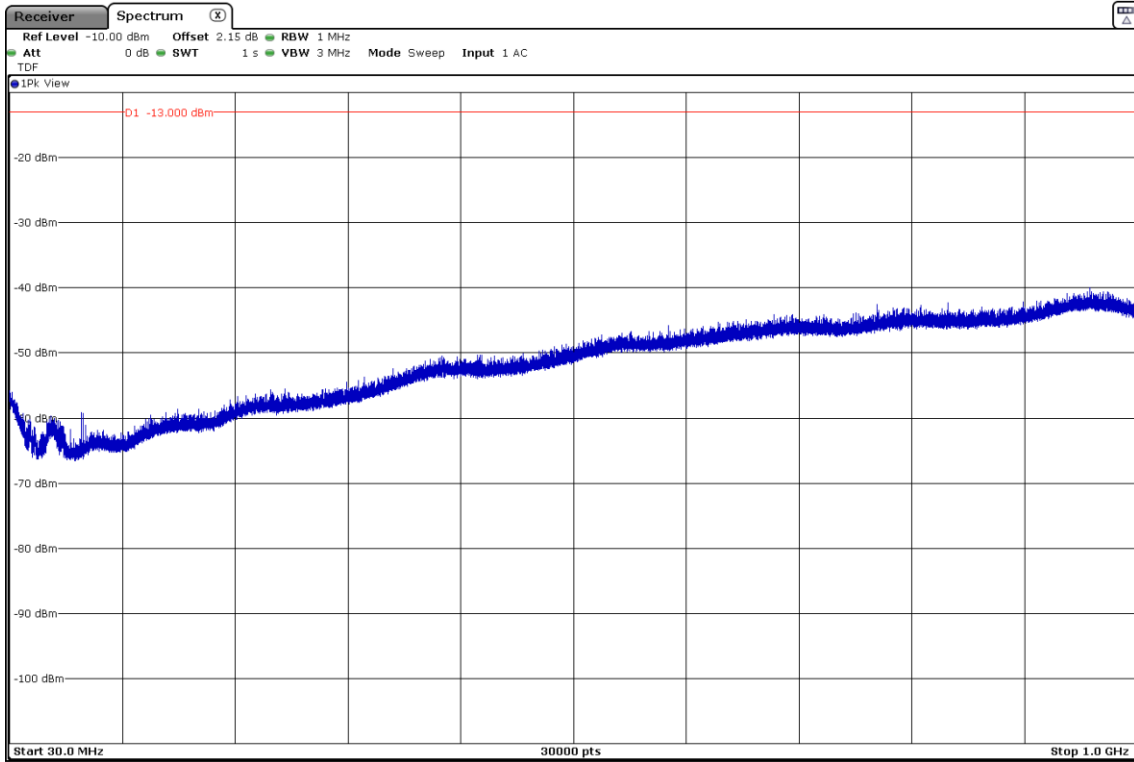

(This plot is valid for all three channels)

LTE Band 12. Frequency range 1 GHz to 8 GHz.

CHANNEL: LOWEST

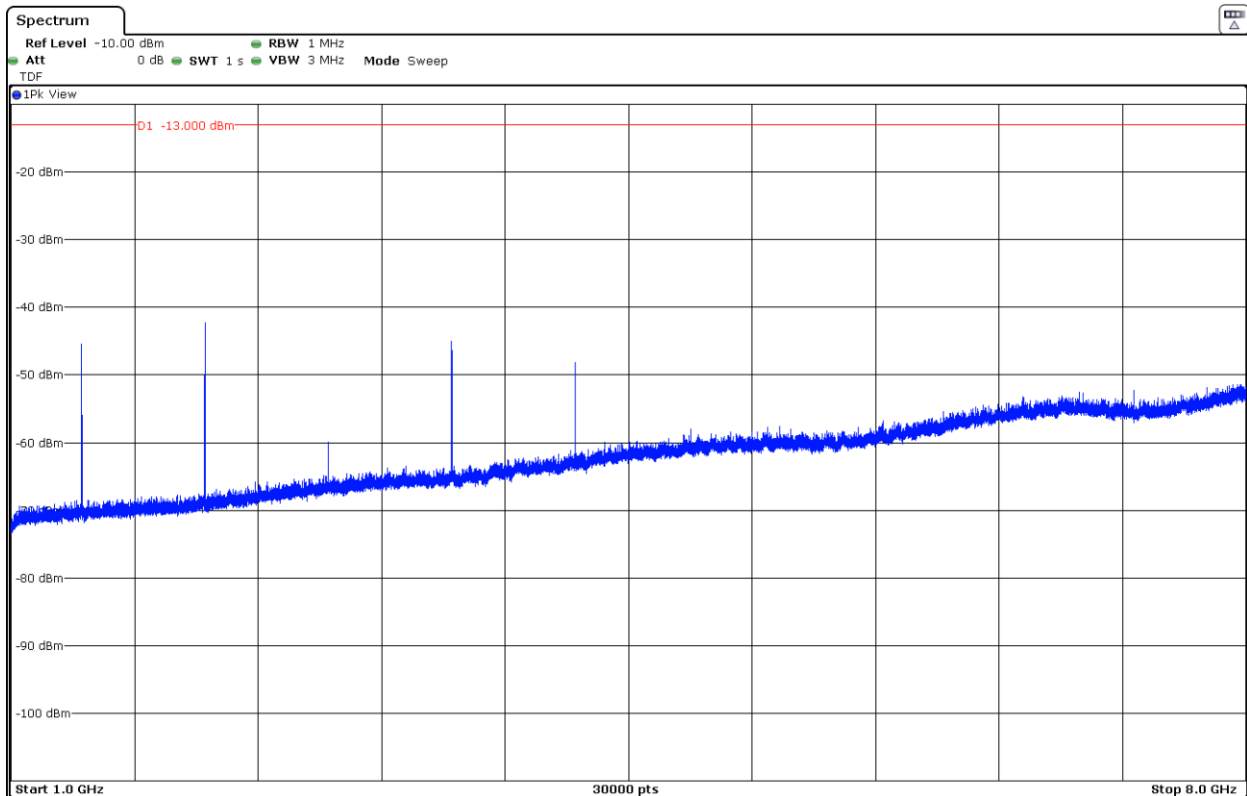

CHANNEL: MIDDLE

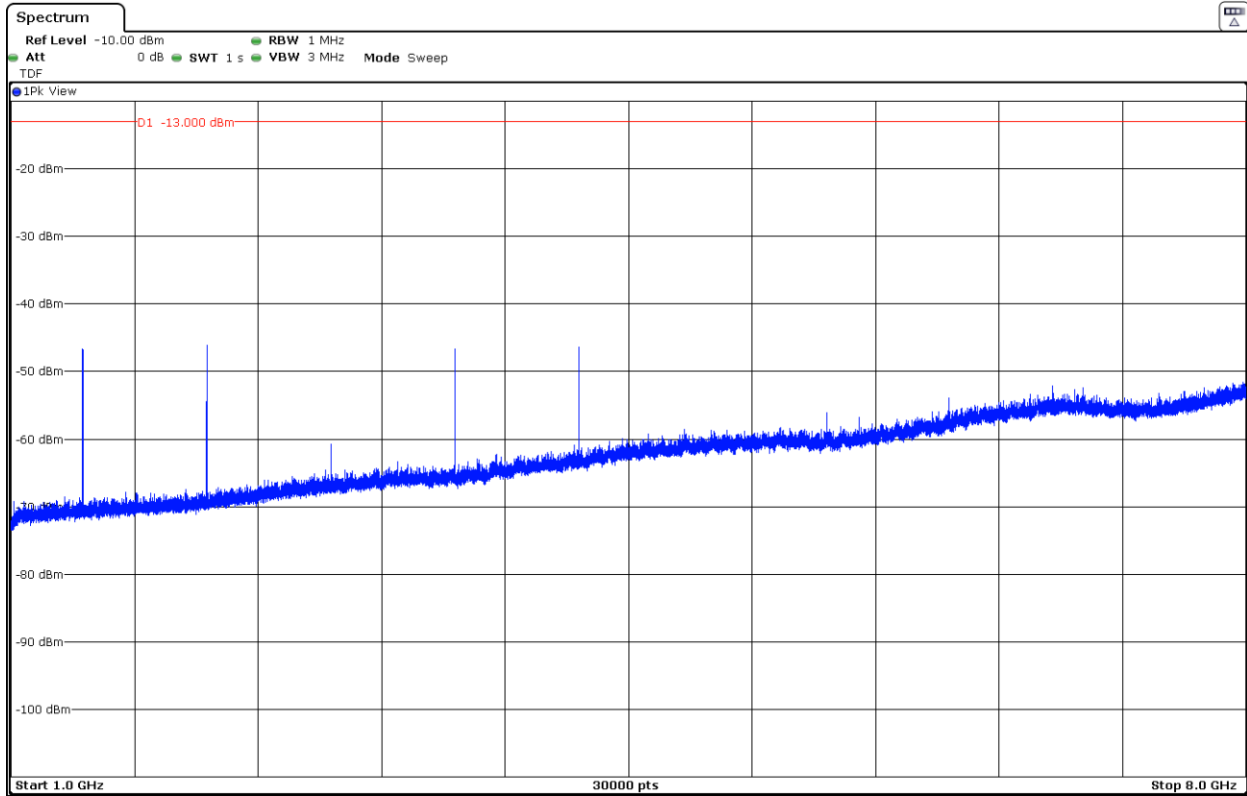

CHANNEL: HIGHEST

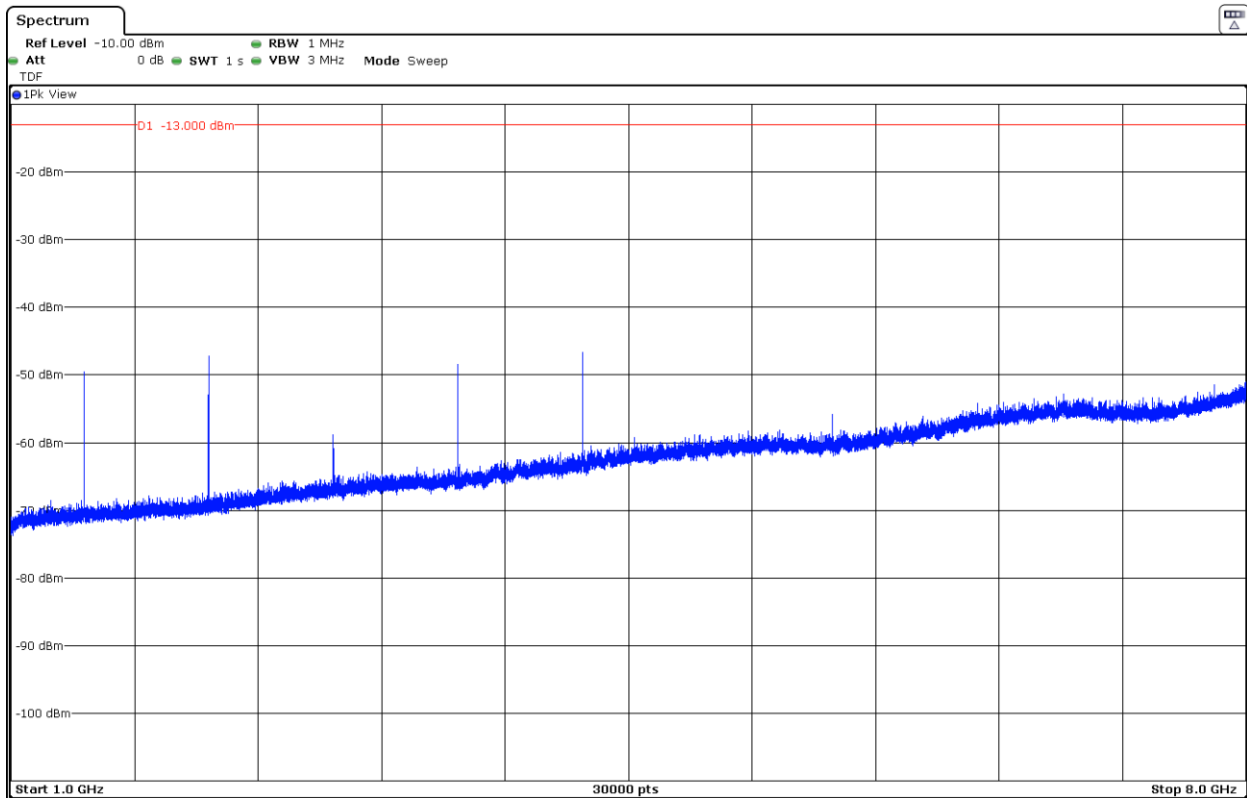

LTE Band 66. Frequency range 1 GHz to 3 GHz

CHANNEL: LOWEST

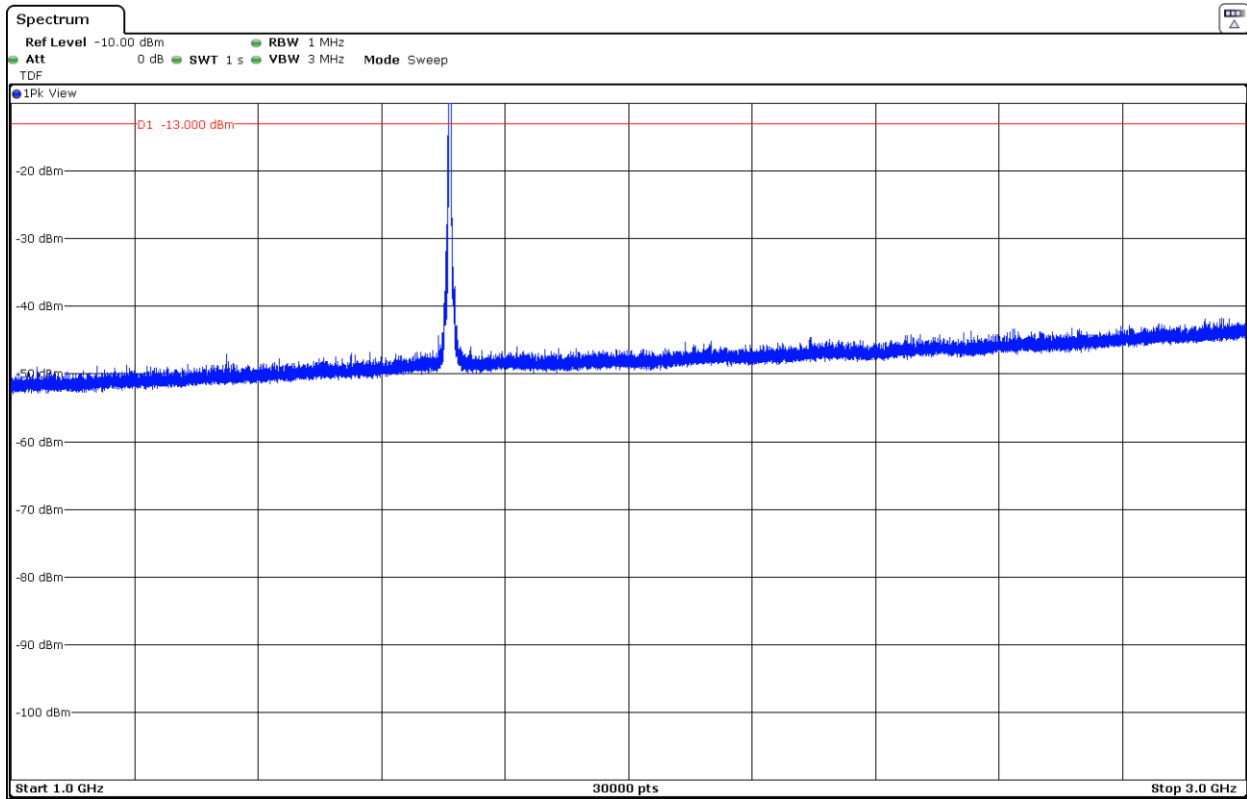

Note: The peak above the limit is the carrier frequency.

CHANNEL: MIDDLE

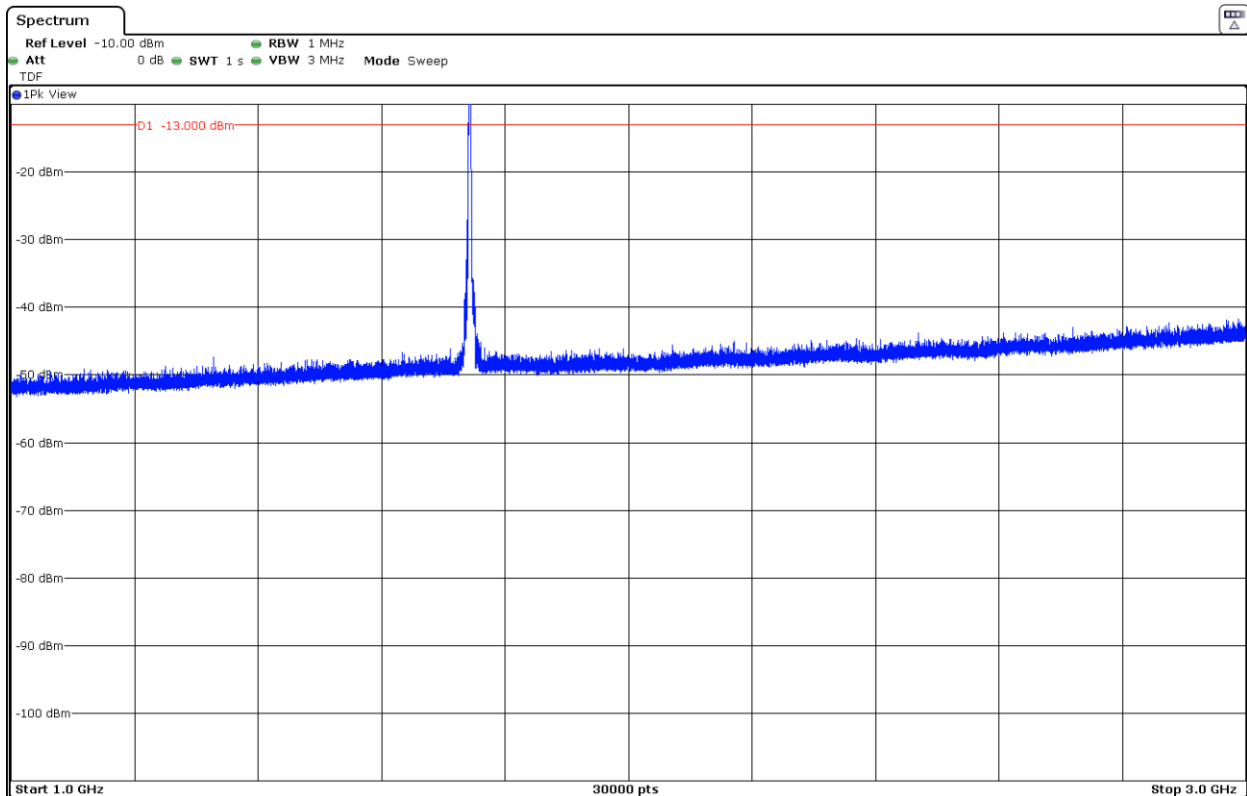

Note: The peak above the limit is the carrier frequency.

CHANNEL: HIGHEST

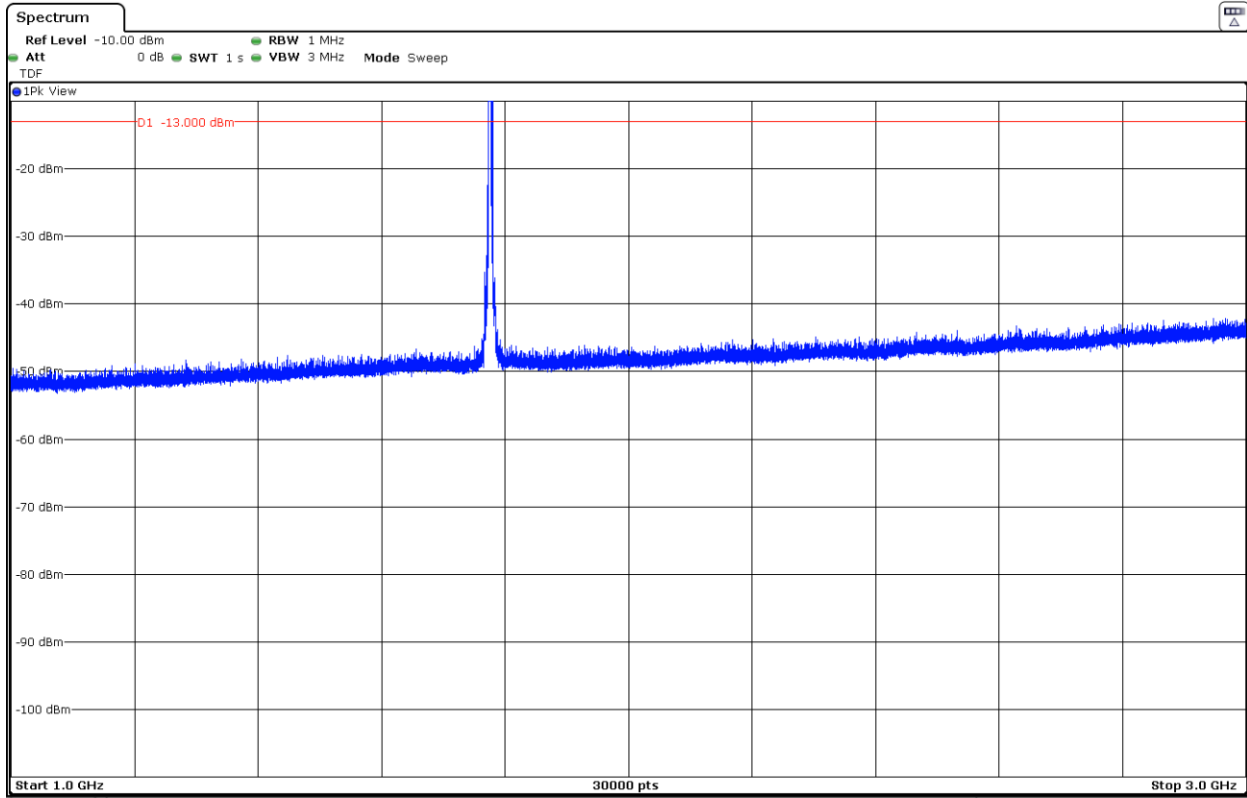

Note: The peak above the limit is the carrier frequency.

LTE Band 66. Frequency range 3 GHz to 18 GHz

CHANNEL: LOWEST

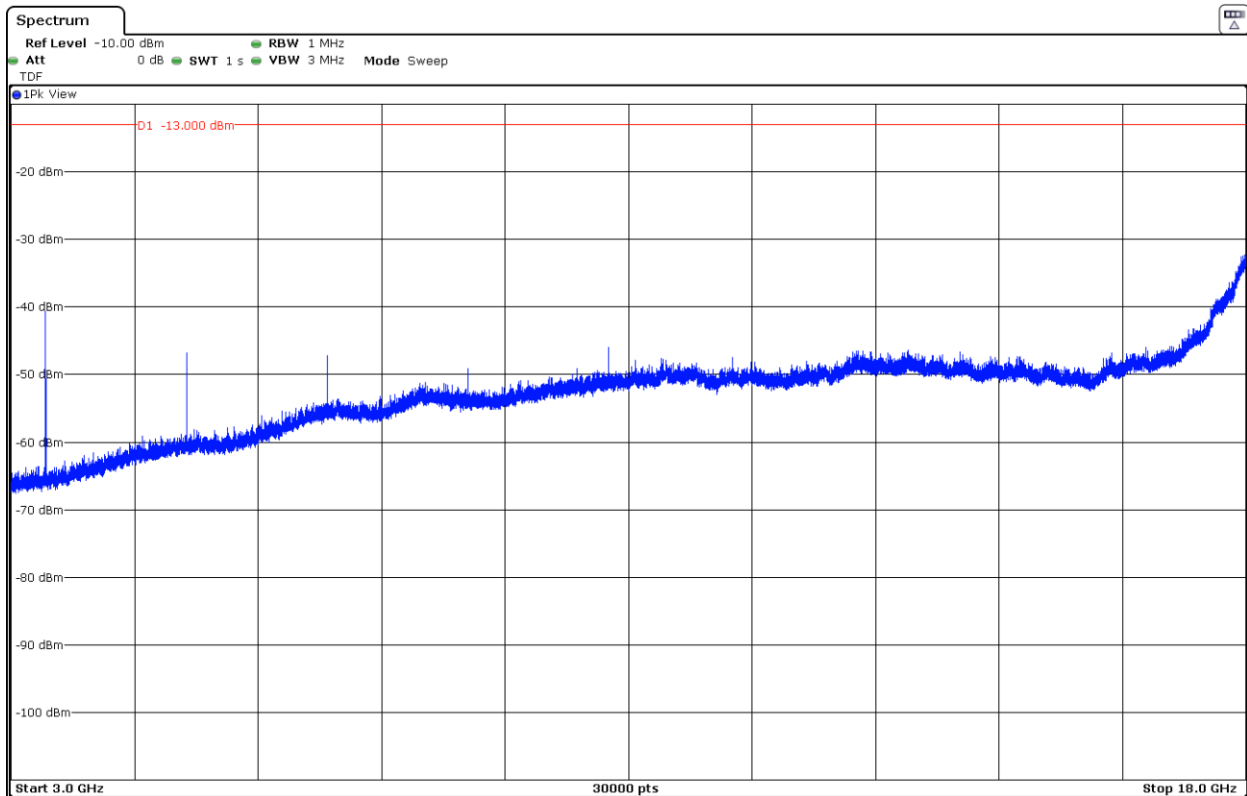

CHANNEL: MIDDLE

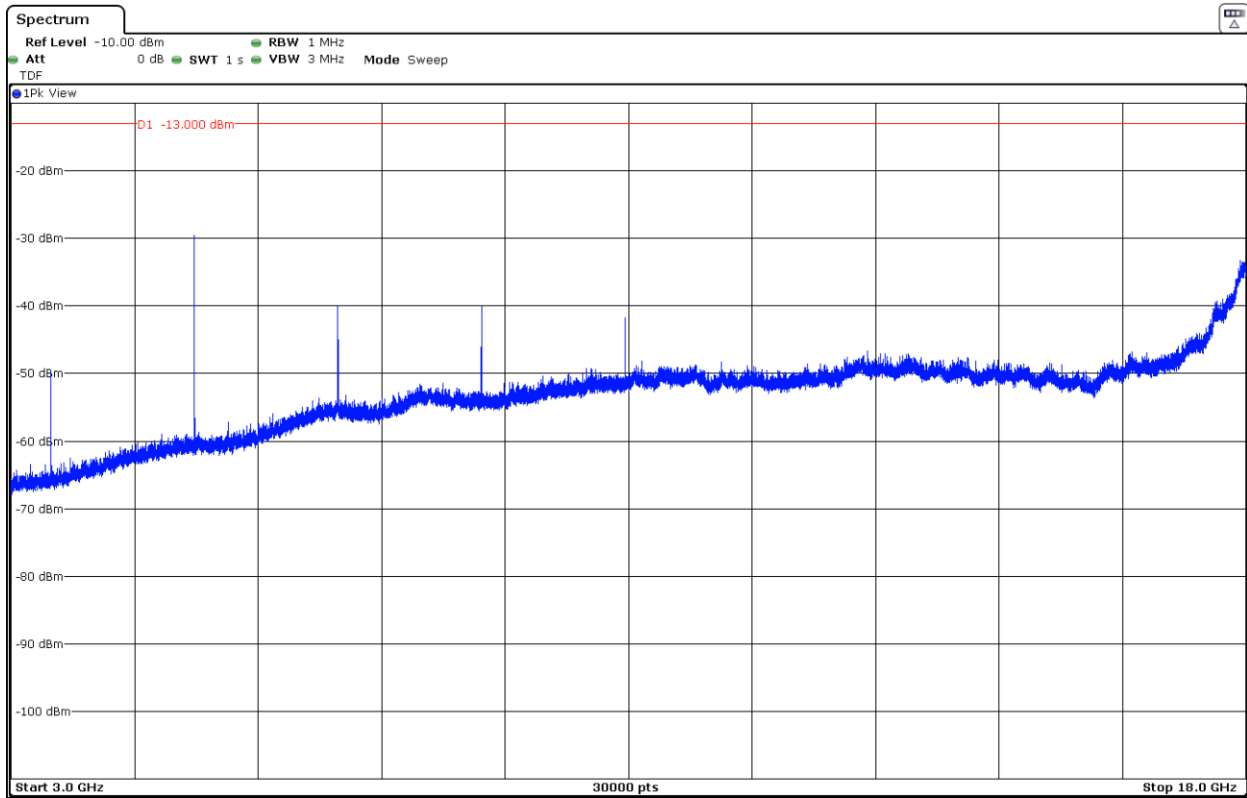

CHANNEL: HIGHEST

