

# FCC Test Report

## (Part 90)

Product Name : nRF9160 IOT Module  
Model No : nRF9160  
FCC ID : 2ANPO00NRF9160

Applicant : NORDIC SEMICONDUCTOR ASA  
Address : P.O. Box 436, 0213 Oslo, Norway

Date of Receipt : 2019/04/01  
Issued Date : 2019/04/23  
Report No. : 1940010R-HPUSP56V00  
Report Version : V1.0



The test results relate only to the samples tested.

The test results shown in the test report are traceable to the national/international standard through the calibration of the equipment and evaluated measurement uncertainty herein.

This report must not be used to claim product endorsement by TAF or any agency of the government.

The test report shall not be reproduced without the written approval of DEKRA Testing and Certification Co., Ltd.

# Test Report

Issued Date : 2019/04/23

Report No.: 1940010R-HPUSP56V00



Product Name : nRF9160 IOT Module  
Applicant : NORDIC SEMICONDUCTOR ASA  
Address : P.O. Box 436, 0213 Oslo, Norway  
Manufacturer : NORDIC SEMICONDUCTOR ASA  
Trade Name : nRF91  
Model No. : nRF9160  
EUT Rated Voltage : DC 3.1V-5.5V  
EUT Test Voltage : DC 5V (Power by NB USB Port)  
Measurement Standard : FCC CFR Title 47 Part2 90  
Measurement Reference : TIA/EIA 603-E 2016  
KDB 971168 D01V03  
ANSI C63.26 2015  
Test Result : Complied

Documented By : Anny Chou  
( Senior Adm. Specialist / Anny Chou )

Tested By : Vorana Chen  
( Senior Engineer / Vorana Chen )

Approved By :   
( Director / Vincent Lin )

## TABLE OF CONTENTS

| Description  | Page |
|--|------|
| 1. GENERAL INFORMATION .....   | 4    |
| 1.1. EUT Description .....   | 4    |
| 1.2. Antenna List .....  | 4    |
| 1.3. Operational Description .....   | 5    |
| 1.4. Configuration of tested System .....                                  | 6    |
| 1.5. EUT Setup Procedures .....  | 6    |
| 1.6. Test Facility .....   | 7    |
| 1.7. Type of Emission .....  | 8    |
| 1.8. Voltages and AC currents .....  | 8    |
| 2. Technical Test .....  | 9    |
| 2.1. Summary of test result .....  | 9    |
| 2.2. List of test Equipment .....  | 10   |
| 2.3. Measurement Uncertainty .....   | 10   |
| 3. Conducted Output Power Measurement .....                                | 11   |
| 3.1. Test Specification .....  | 11   |
| 3.2. Test Setup .....  | 11   |
| 3.3. Limits .....  | 11   |
| 3.4. Test Procedure .....  | 11   |
| 3.5. Test Result of Maximum Power Output .....                             | 12   |
| 3.6. Maximum Conducted Power and ERP/EIRP Power .....                      | 13   |
| 4. Occupied Bandwidth .....  | 14   |
| 4.1. Test Specification .....  | 14   |
| 4.2. Test Setup .....  | 14   |
| 4.3. Test Procedure .....  | 14   |
| 4.4. Test Result of Occupied Bandwidth .....                               | 15   |
| 5. Spurious Emission At Antenna Terminals (+/-1MHz) .....                  | 18   |
| 5.1. Test Specification .....  | 18   |
| 5.2. Setup .....   | 18   |
| 5.3. Limits .....  | 18   |
| 5.4. Test Procedure .....  | 18   |
| 5.5. Test Result of Spurious Emission At Antenna Terminals (+/-1MHz) ..... | 19   |
| 6. Spurious Emission .....   | 27   |
| 6.1. Test Specification .....  | 27   |
| 6.2. Test Setup .....  | 27   |
| 6.3. Limits .....  | 28   |
| 6.4. Test Procedure .....  | 28   |
| 6.5. Test Result of Spurious Emission .....                                | 29   |
| 7. Frequency Stability Under Temperature & Voltage Variations .....        | 43   |
| 7.1. Test Specification .....  | 43   |
| 7.2. Test Setup .....  | 43   |
| 7.3. Limits .....  | 43   |
| 7.4. Test Procedure .....  | 43   |
| 7.5. Test Result of Frequency Stability Under Temperature Variations ..... | 44   |
| Attachment 1: EUT Test Photographs   |      |
| Attachment 2: EUT Detailed Photographs                                     |      |

## 1. GENERAL INFORMATION

### 1.1. EUT Description

|              |                            |
|--------------|----------------------------|
| Product Name | nRF9160 IOT Module         |
| Model No.    | nRF9160                    |
| Trade Name   | nRF91                      |
| IMEI No.     | 35265610                   |
| FCC ID       | 2ANPO00NRF9160             |
| Modulation   | LTE Band 14: QPSK/16-QAM   |
| TX Frequency | LTE Band 14: 788~798MHz    |
| Rx Frequency | LTE Band 14: 758~768MHz    |
| Bandwidth    | LTE Band 14: 5MHz/10MHz    |
| HW Version   | DEV2.1.6                   |
| SW Version   | mfw_nrf9160_0.7.0-29.alpha |
| Antenna Type | IMD Antenna                |

### 1.2. Antenna List

| No. | Manufacturer | Part No. | Peak Gain               |
|-----|--------------|----------|-------------------------|
| 1   | Ethertronics | P822601  | 2.6 dBi for 698-960 MHz |

### 1.3. Operational Description

The information contained within this report is intended to show verification of compliance of the 850MHz to the requirements of FCC 47 CFR Part 2, 90.

The EUT provide all functions described as above. The EUT is tested with maximum rated TX power via the Base Station simulator.

DEKRA has verified the construction and function in typical operation. All the test modes were carried out with the EUT in normal operation, which was shown in this test report and defined

as:

|            |                              |
|------------|------------------------------|
| Test Mode: | LTE Band 14 (5M)-QPSK/16QAM  |
|            | LTE Band 14 (10M)-QPSK/16QAM |

Note :

The maximum power levels are chosen in the LTE Band 14, only these modes were used for all tests.

## 1.4. Configuration of tested System

### (a) Configuration of Radiated measurement

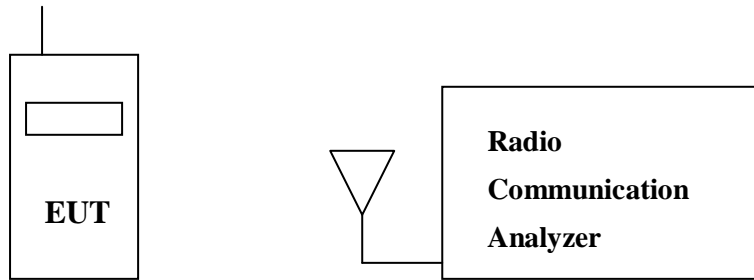

### (b) Configuration of Conducted measurement

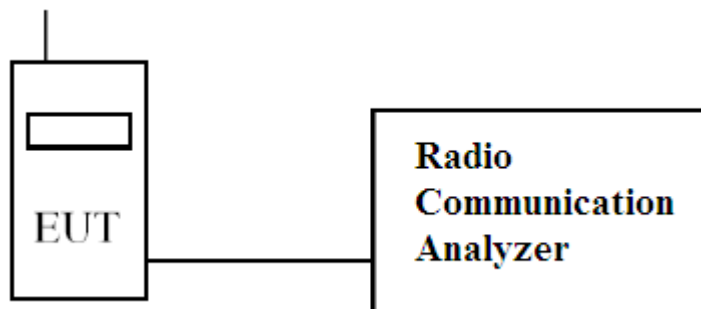

## 1.5. EUT Setup Procedures

- (1) Setup the EUT and simulators as shown on 1.3
- (2) Turn on the power of all equipments.
- (3) The EUT was set to communicate with MT8820C.
- (4) Repeat the above procedure (3).

## 1.6. Test Facility

Ambient conditions in the laboratory:

| Items                      | Required (IEC 68-1) | Actual |
|----------------------------|---------------------|--------|
| Temperature (°C)           | 15-35               | 23.1   |
| Humidity (%RH)             | 25-75               | 52     |
| Barometric pressure (mbar) | 860-1060            | 988    |

The related certificate for our laboratories about the test site and management system can be downloaded from DEKRA Testing and Certification Co., Ltd. Web Site:

<http://www.dekra.com.tw/english/about/certificates.aspx?bval=5>

The address and introduction of DEKRA Testing and Certification Co., Ltd. laboratories can be founded in our Web site: [http://www.dekra.com.tw/index\\_en.aspx](http://www.dekra.com.tw/index_en.aspx)

Site Description: File on

Federal Communications Commission  
FCC Engineering Laboratory  
7435 Oakland Mills Road  
Columbia, MD 21046  
FCC Registration Number :92195

Site Name: DEKRA Testing and Certification Co., Ltd

Lin Kou Laboratory:

No.5-22, Ruishukeng, Linkou Dist., New Taipei City 24451,  
Taiwan, R.O.C.  
TEL : 886-2-8601-3788 / FAX : 886-2-8601-3789  
E-Mail : [info.tw@dekra.com](mailto:info.tw@dekra.com)

FCC Accreditation Number: TW3023

### 1.7. Type of Emission

| Band | Bandwidth (MHz) | Modulation |         |
|------|-----------------|------------|---------|
|      |                 | QPSK       | 16QAM   |
| 14   | 5               | 1M11G7D    | 0M97W7D |
| 14   | 10              | 1M11G7D    | 0M97W7D |

### 1.8. Voltages and DC currents

|                   |                                       |  |
|-------------------|---------------------------------------|--|
| LTE Band 14 (5M)  | EUT Transmitting (in maximum power) : | DC voltage : 3.8V , DC current : 0.14A   |
|                   | EUT Standby                           | : DC voltage : 3.8V , DC current : 0.07A |
| LTE Band 14 (10M) | EUT Transmitting (in maximum power) : | DC voltage : 3.8V , DC current : 0.14A   |
|                   | EUT Standby                           | : DC voltage : 3.8V , DC current : 0.07A |



## 2. Technical Test

### 2.1. Summary of test result

| FCC Standard | Test Item                                     | Result | Note |
|--------------|---|--------|------|
| 2.1046       | Conducted Output Power                        | Pass   |      |
| 90.542       |   |        |      |
| 2.1049       | Occupied Bandwidth                            | Pass   |      |
| 90.209       |   |        |      |
| 2.1051       | Spurious Emission at Antenna Terminals        | Pass   |      |
| 90.543       |   |        |      |
| 2.1051       | Conducted Emission                            | Pass   |      |
| 90.543       |   |        |      |
| 2.1053       | Field Strength of Spurious Radiation          | Pass   |      |
| 90.543       |   |        |      |
| 2.1055       | Frequency Stability for Temperature & Voltage | Pass   |      |
| 90.213       |   |        |      |

## 2.2. List of test Equipment

Conducted /CTR

| Instrument                              | Manufacturer | Type No. | Serial No    | Cal. Date  |
|---|--------------|----------|--------------|------------|
| Spectrum Analyzer                       | Agilent      | N9010A   | MY54510357   | 2018/05/03 |
| Directional coupler                     | Agilent      | 87300C   | MY44300353   | 2018/12/04 |
| Directional coupler                     | Agilent      | 778D-012 | 50550        | 2018/12/04 |
| Standard Temperature & Humidity Chamber | WIT          | TH-1S-B  | EQ-201-00146 | 2019/02/27 |
| Communication Tester                    | Agilent      | MT8820C  | 6201465467   | 2018/07/20 |

Radiated / Site3

| Instrument           | Manufacturer    | Type No. | Serial No  | Cal. Date  |
|----------------------|-----------------|----------|------------|------------|
| Bilog Antenna        | Schaffner Chase | CBL6112B | 2707       | 2018/06/24 |
| Horn Antenna         | R&S             | 9120D    | 556        | 2018/05/03 |
| Pre-Amplifier        | Agilent         | 87405C   | MY55380068 | 2018/08/10 |
| Spectrum Analyzer    | Agilent         | N9010A   | MY54510357 | 2018/05/03 |
| Communication Tester | Agilent         | MT8820C  | 6201465467 | 2018/07/20 |

## 2.3. Measurement Uncertainty

### Conducted Emission

The measurement uncertainty of confidence of 95% is evaluated as  $\pm 1.52$  dB

### Radiated Emission (Below 1GHz)

The measurement uncertainty of confidence of 95% is evaluated as  $\pm 4.22$  dB .

### Radiated Emission (Above 1GHz)

The measurement uncertainty of confidence of 95% is evaluated as  $\pm 4.08$  dB

### 3. Conducted Output Power Measurement

#### 3.1. Test Specification

According to FCC Part 2.1046, 90.542

#### 3.2. Test Setup

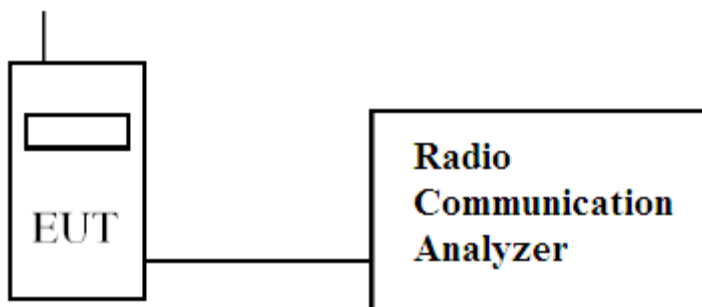

#### 3.3. Limits

| Band            | Limit |
|-----------------|-------|
| LTE Band 14/800 | <3W   |

#### 3.4. Test Procedure

The EUT is tested with maximum rated TX power via the Base Station simulator, and the output power was measured at the antenna terminals of the EUT.

### 3.5. Test Result of Maximum Power Output

| Band                  | Frequency Channel   | Modulation | Index | RB No. | RB offset | Max Power (dBm) | Max Power (W) |
|-----------------------|---------------------|------------|-------|--------|-----------|-----------------|---------------|
| Band 14 (800MHz)/5MHz | CH23305<br>790.5MHz | QPSK       | 0     | 1      | 0         | 23.25           | 0.211         |
|                       |                     |            | 0     | 1      | 5         | 23.31           | 0.214         |
|                       |                     |            | 0     | 6      | 0         | 22.38           | 0.173         |
|                       |                     | 16-QAM     | 0     | 1      | 0         | <b>22.64</b>    | <b>0.184</b>  |
|                       |                     |            | 0     | 1      | 5         | 22.60           | 0.182         |
|                       |                     |            | 0     | 5      | 0         | 21.63           | 0.146         |
|                       |                     |            | 0     | 5      | 1         | 21.56           | 0.143         |
|                       | CH23330<br>793MHz   | QPSK       | 1     | 1      | 0         | 23.52           | 0.225         |
|                       |                     |            | 1     | 1      | 5         | <b>23.54</b>    | <b>0.226</b>  |
|                       |                     |            | 1     | 6      | 0         | 22.38           | 0.173         |
|                       |                     | 16-QAM     | 1     | 1      | 0         | 22.08           | 0.161         |
|                       |                     |            | 1     | 1      | 5         | 22.02           | 0.159         |
|                       |                     |            | 1     | 5      | 0         | 21.37           | 0.137         |
|                       |                     |            | 1     | 5      | 1         | 21.40           | 0.138         |
|                       | CH23355<br>795.5MHz | QPSK       | 3     | 1      | 0         | 23.32           | 0.215         |
|                       |                     |            | 3     | 1      | 5         | 23.25           | 0.211         |
|                       |                     |            | 3     | 6      | 0         | 22.44           | 0.175         |
|                       |                     | 16-QAM     | 3     | 1      | 0         | 22.48           | 0.177         |
|                       |                     |            | 3     | 1      | 5         | 22.45           | 0.176         |
|                       |                     |            | 3     | 5      | 0         | 21.42           | 0.139         |
|                       |                     |            | 3     | 5      | 1         | 21.46           | 0.140         |

| Band                      | Frequency Channel | Modulation | Index | RB No. | RB offset | Max Power (dBm) | Max Power (W) |
|---------------------------|-------------------|------------|-------|--------|-----------|-----------------|---------------|
| Band 14<br>(800MHz)/10MHz | CH23330<br>793MHz | QPSK       | 0     | 1      | 0         | 23.43           | 0.220         |
|                           |                   |            | 0     | 6      | 0         | 22.33           | 0.171         |
|                           |                   |            | 3     | 6      | 0         | 22.31           | 0.170         |
|                           |                   |            | 7     | 1      | 5         | <b>23.46</b>    | <b>0.222</b>  |
|                           |                   |            | 7     | 6      | 0         | 22.36           | 0.172         |
|                           |                   | 16-QAM     | 0     | 1      | 0         | <b>22.54</b>    | <b>0.179</b>  |
|                           |                   |            | 0     | 5      | 0         | 22.53           | 0.179         |
|                           |                   |            | 3     | 5      | 0         | 22.54           | 0.179         |
|                           |                   |            | 7     | 1      | 5         | 22.40           | 0.174         |
|                           |                   |            | 7     | 5      | 1         | 22.48           | 0.177         |

### 3.6. Maximum Conducted Power and ERP/EIRP Power

According to KDB 412172 D01 Section 1.2 Power Approach

$EIRP = P_T + G_T - L_C = ERP + 2.15 \text{ dB}$ ,  $ERP = EIRP - 2.15 \text{ dB}$

$P_T$  = transmitter output power in dBm

$G_T$  = gain of the transmitting antenna in dBi

$L_C$  = signal attenuation in the connecting cable between the transmitter and antenna in dB

| LTE Band | BW  | Modulation | Conducted Peak Power (dBm) | Conducted Peak Power (W) | Antenna Gain (dBi) | Maximum ERP (W) | Maximum ERP Limit (W) |
|----------|-----|------------|----------------------------|--------------------------|--------------------|-----------------|-----------------------|
| 14       | 5M  | QPSK       | 23.54                      | 0.226                    | 2.6                | 0.251           | 3                     |
|          |     | 16QAM      | 22.64                      | 0.184                    | 2.6                | 0.204           | 3                     |
|          | 10M | QPSK       | 23.46                      | 0.222                    | 2.6                | 0.246           | 3                     |
|          |     | 16QAM      | 22.54                      | 0.179                    | 2.6                | 0.199           | 3                     |

## 4. Occupied Bandwidth

### 4.1. Test Secification

According to FCC Part 2.1049, 90.209

### 4.2. Test Setup

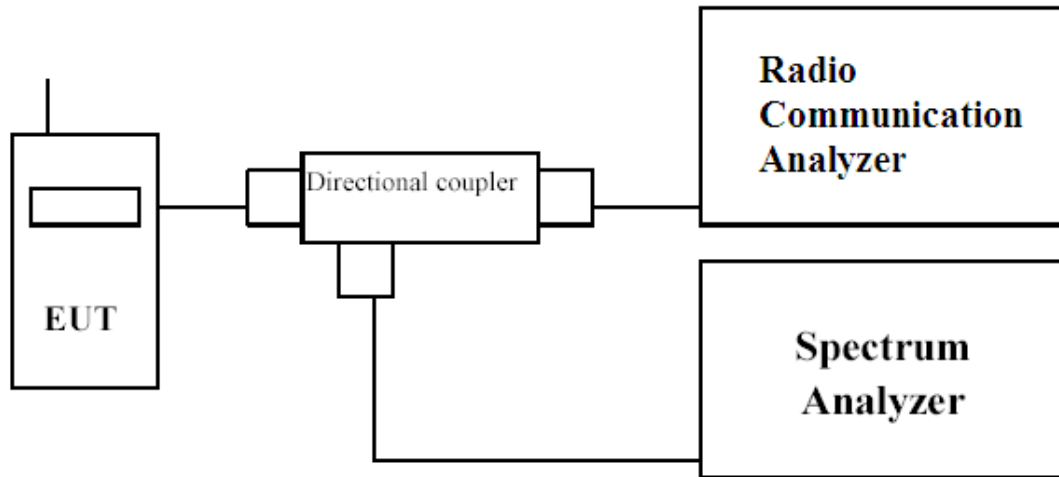

### 4.3. Test Procedure

The EUT is tested with maximum rated TX power via the Base Station simulator, and the occupied bandwidth was measured at the antenna terminals of the EUT.

The Resolution BW of the analyzer is set to 1 %~5% of the emission bandwidth. The EUT's occupied bandwidth is measured as the width of the signal between two points, one below the carrier center frequency and one above the carrier frequency, outside of which all emissions are attenuated at least 26 dB below the transmitter power.

The plots below show the resultant display from the Spectrum Analyser.

#### 4.4. Test Result of Occupied Bandwidth

|           |                    |
|-----------|--------------------|
| Product   | nRF9160 IOT Module |
| Test Mode | Occupied Bandwidth |
| Test Site | CTR                |

| Test Mode         | Channel | TX Frequency (MHz) | 99% Occupied Bandwidth (MHz) | 26 dB bandwidth (MHz) | Result |
|-------------------|---------|--------------------|------------------------------|-----------------------|--------|
| Band 14 5M QPSK   | 23330   | 793                | 1.1069                       | 1.431                 | Pass   |
| Band 14 5M 16QAM  | 23330   | 793                | 0.9652                       | 1.327                 | Pass   |
| Band 14 10M QPSK  | 23330   | 793                | 1.1078                       | 1.385                 | Pass   |
| Band 14 10M 16QAM | 23330   | 793                | 0.9684                       | 1.323                 | Pass   |

|                |                    |           |     |
|----------------|--------------------|-----------|-----|
| Product        | nRF9160 IOT Module |           |     |
| Test Mode      | Occupied Bandwidth |           |     |
| Date of Test   | 2019/04/12         | Test Site | CTR |
| Test Condition | Band 14 5M         |           |     |

Band 14 5M QPSK - LTE Mode CH 23330 (793MHz)

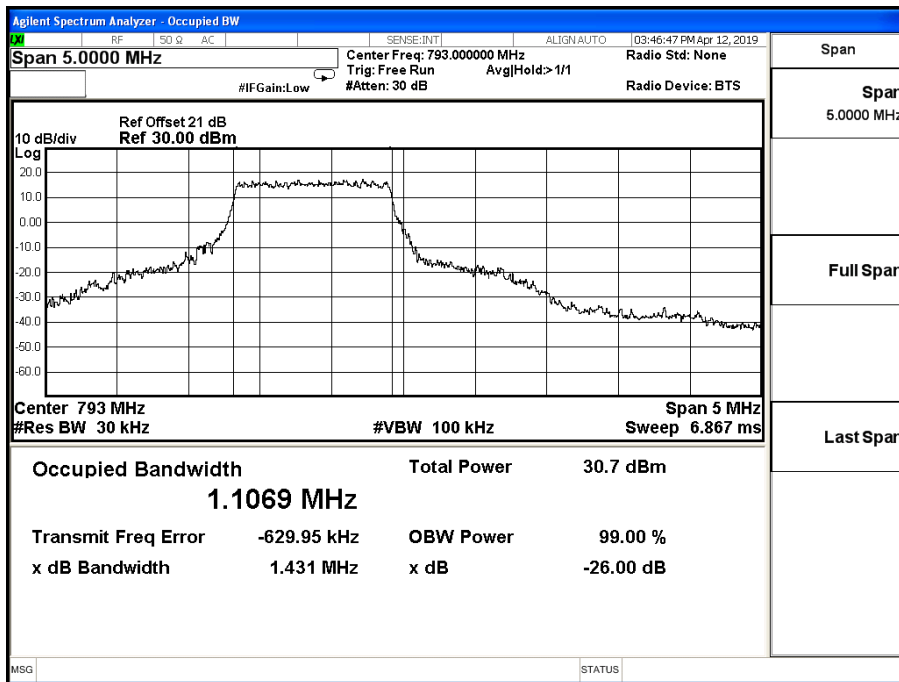

Band 14 5M 16QAM - LTE Mode CH 23330 (793MHz)

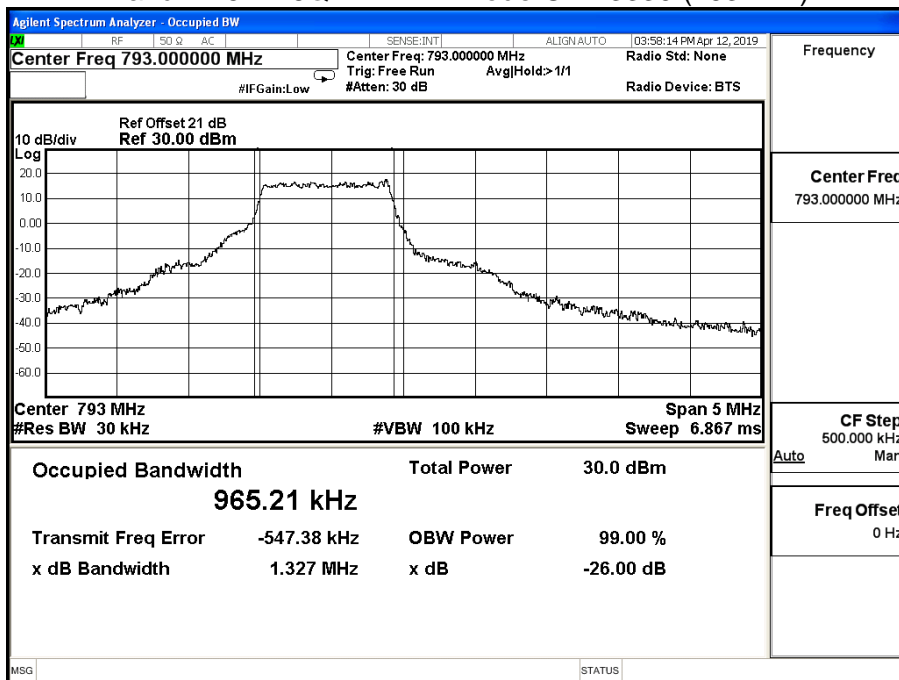



|                |                    |           |     |
|----------------|--------------------|-----------|-----|
| Product        | nRF9160 IOT Module |           |     |
| Test Mode      | Occupied Bandwidth |           |     |
| Date of Test   | 2019/04/12         | Test Site | CTR |
| Test Condition | Band 14 10M        |           |     |

Band 14 10M QPSK - LTE Mode CH 23330 (793MHz)

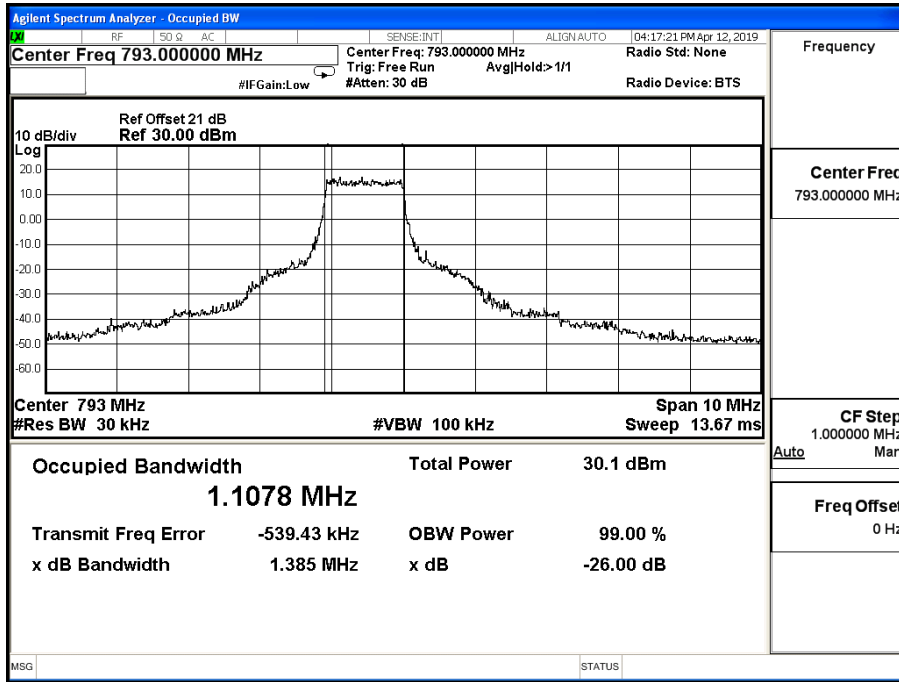

Band 14 10M 16QAM - LTE Mode CH 23330 (793MHz)

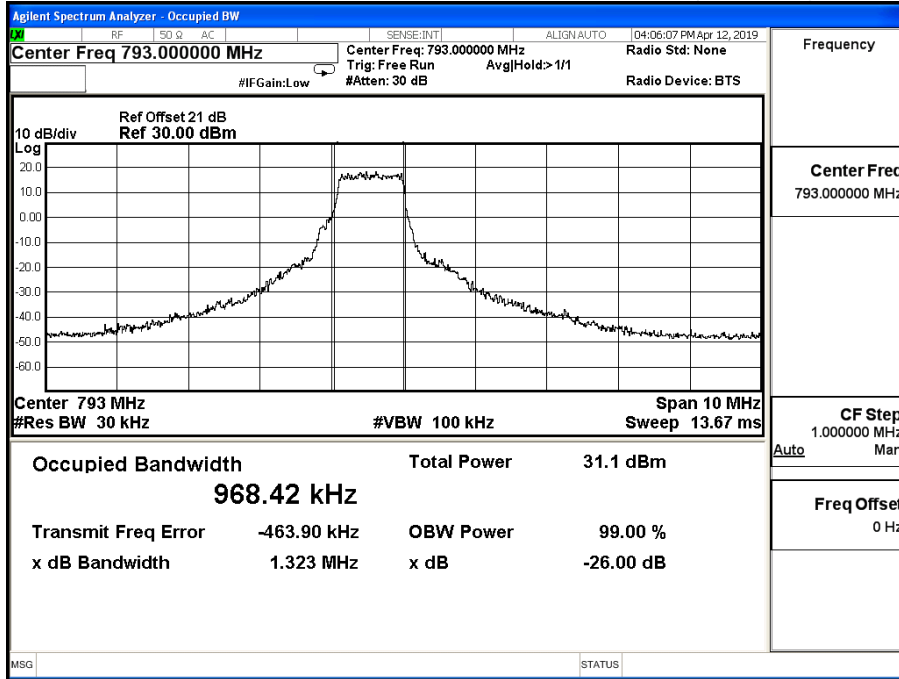

## 5. Spurious Emission At Antenna Terminals (+/-1MHz)

### 5.1. Test Specification

According to Part 2.1051, 90.543

### 5.2. Setup

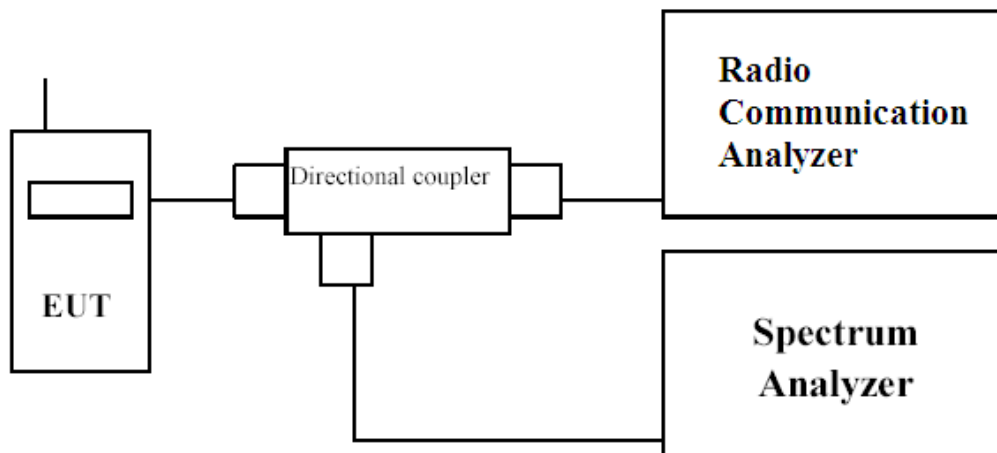

### 5.3. Limits

The spurious (unwanted) emission limits specified in the individual FCC rule parts applicable to licensed digital transmitters (typically referred to under the heading 'emission limits') normally apply to any and all emissions that are present outside of the authorized frequency band/block and apply to emissions in both the out-of-band and spurious domains. unwanted emissions are required by the licensed rule parts to be attenuated below the transmitter power by a factor of at least  $43 + 10\log(P)$  dB on any frequency between 775-788 MHz, above 805 MHz, and below 758 MHz, where P represents the transmitter power expressed in watts.

### 5.4. Test Procedure

In accordance with Part 90.543 (e)(3) of this section is based on the use of measurement instrumentation employing a resolution bandwidth of 100 kHz or greater. However, in the 100 kHz bands immediately outside and adjacent to the frequency block, a resolution bandwidth of 30 kHz may be employed.

On all frequencies between 769-775 MHz and 799-805 MHz, by a factor not less than  $65 + 10 \log(P)$  dB in a 6.25 kHz band segment, for mobile and portable stations

### 5.5. Test Result of Spurious Emission At Antenna Terminals (+/-1MHz)

|                |  |           |     |
|----------------|--|-----------|-----|
| Product        | nRF9160 IOT Module                               |           |     |
| Test Mode      | Spurious Emission At Antenna Terminals (+/-1MHz) |           |     |
| Date of Test   | 2019/04/12                                       | Test Site | CTR |
| Test Condition | Block Edge Test (Band 14 (5M))                   |           |     |

Band 14 (5M) QPSK Index0(1,0) Lower Channel 23305 (790.5MHz)

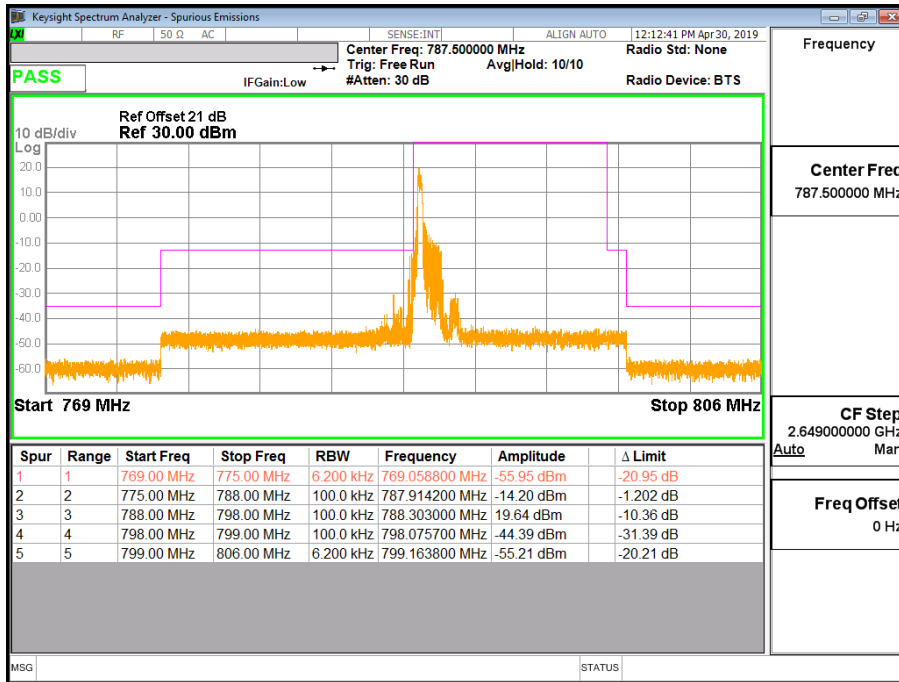

Band 14 (5M) QPSK Index3(1,5) Upper Channel 23355 (795.5MHz)

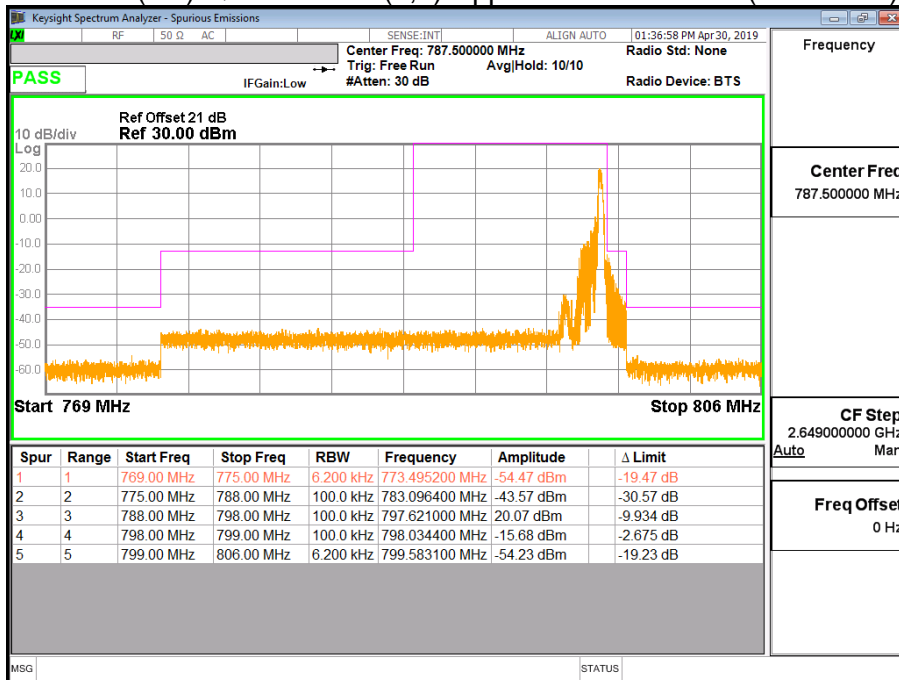

Band 14 (5M) QPSK Index0(6,0) Lower Channel 23305 (790.5MHz)

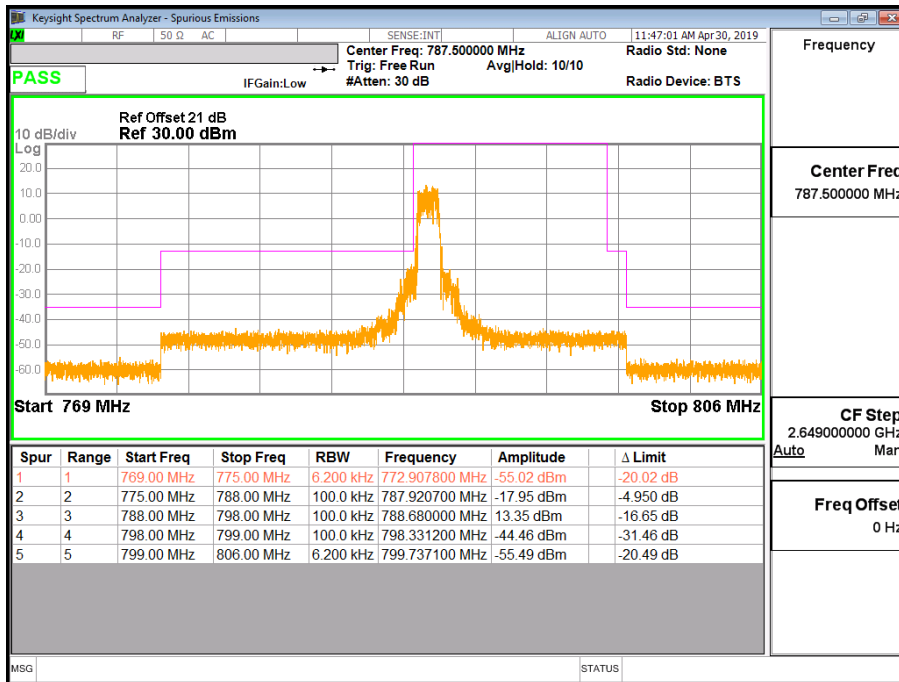

Band 14 (5M) QPSK Index3(6,0) Upper Channel 23335 (795.5MHz)

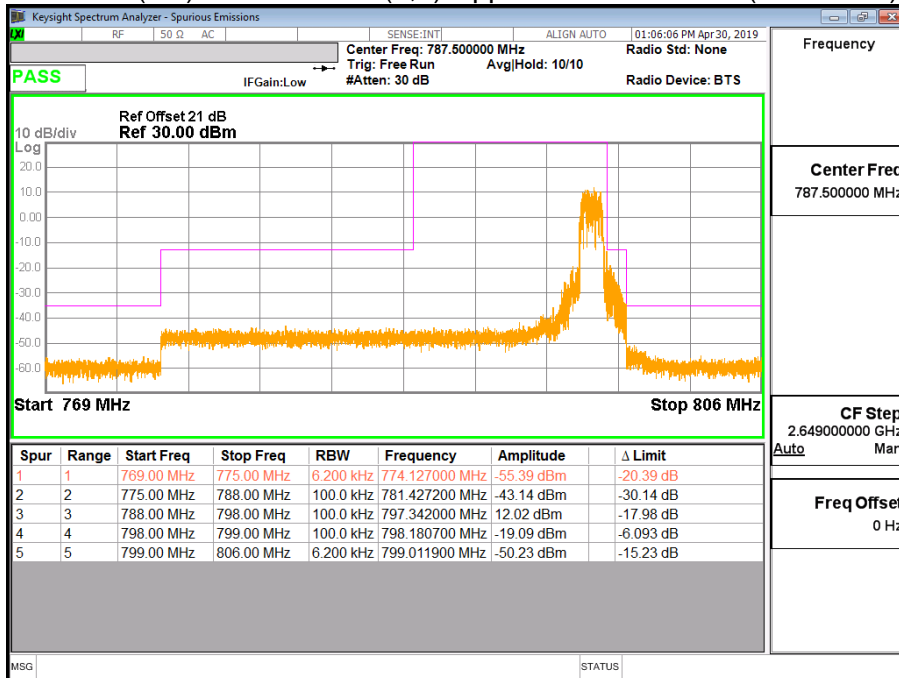

Band 14 (5M) 16QAM Index0(1,0) Lower Channel 23305 (790.5MHz)

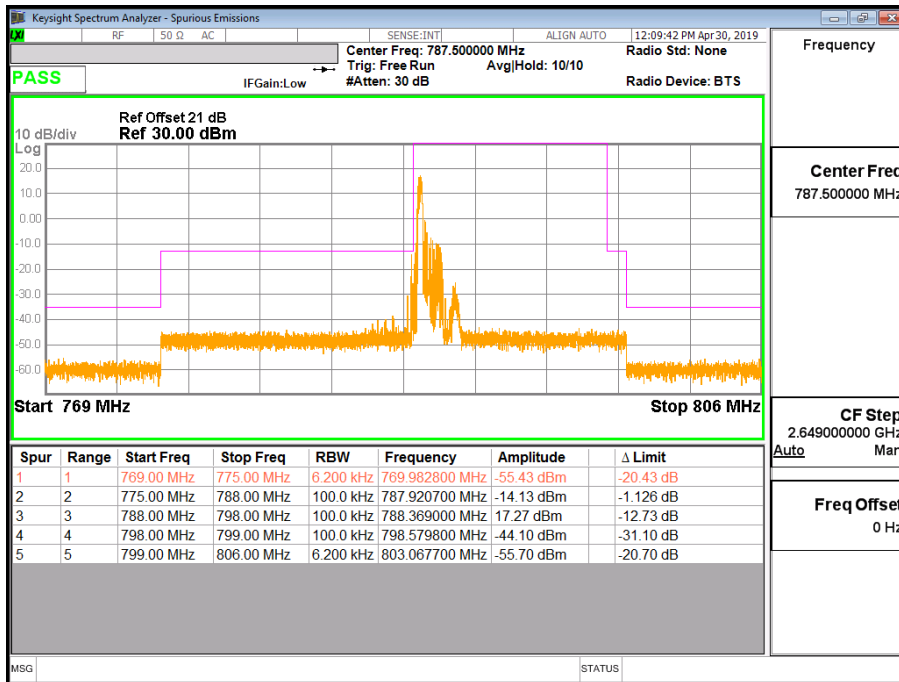

Band 14 (5M) 16QAM Index3(1,5) Upper Channel 23355 (795.5MHz)

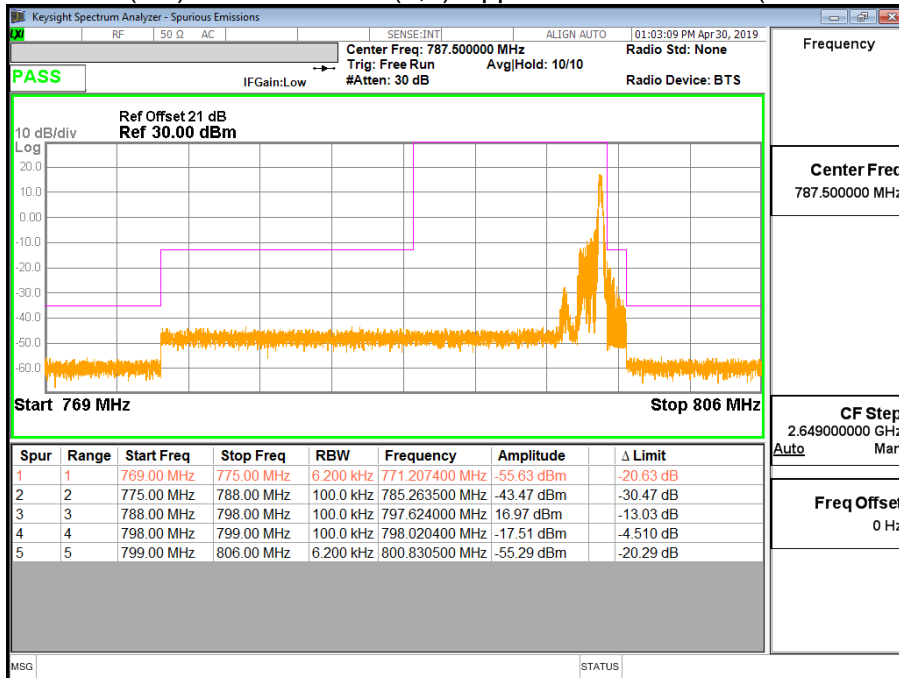

Band 14 (5M) 16QAM Index0(5,0) Lower Channel 23305 (790.5MHz)

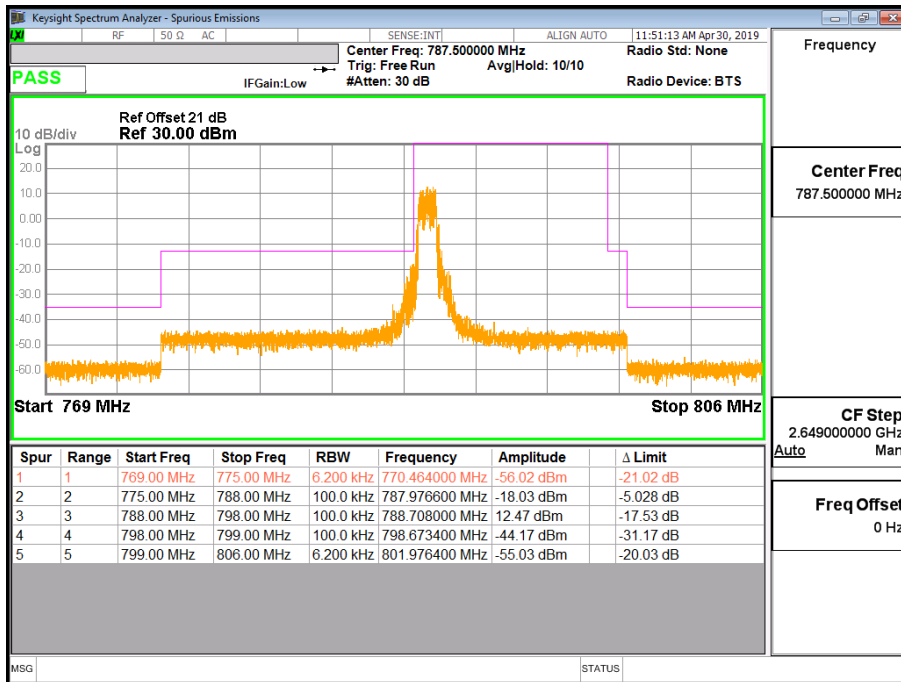

Band 14 (5M) 16QAM Index3(5,1) Upper Channel 23355 (795.5MHz)

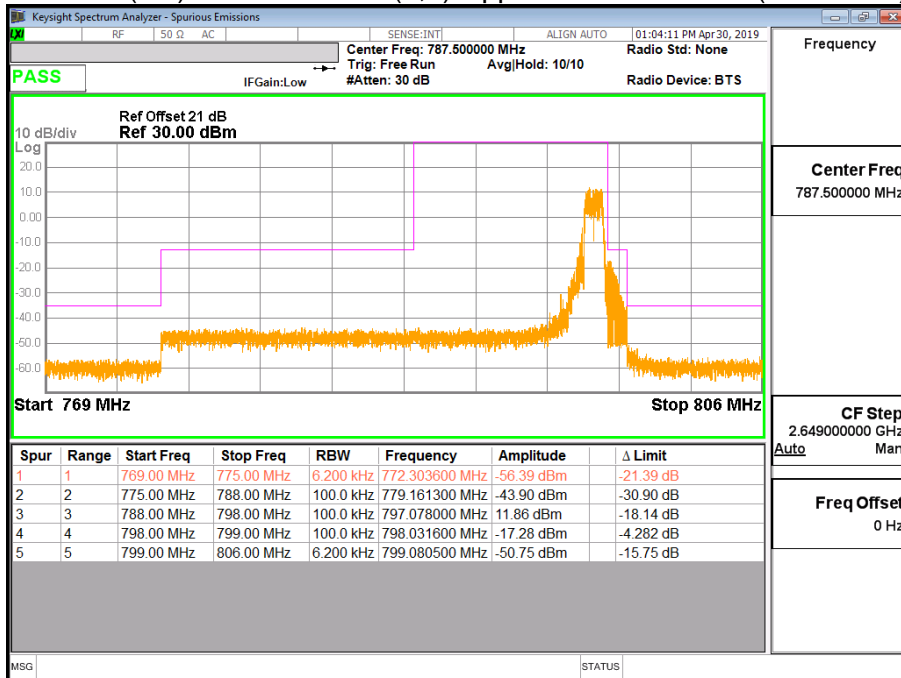

|                |  |           |     |
|----------------|--|-----------|-----|
| Product        | nRF9160 IOT Module                               |           |     |
| Test Mode      | Spurious Emission At Antenna Terminals (+/-1MHz) |           |     |
| Date of Test   | 2019/04/12                                       | Test Site | CTR |
| Test Condition | Block Edge Test (Band 14 (10M))                  |           |     |

Band 14 (10M) QPSK Index0(1,0) Lower Channel 23330 (793MHz)

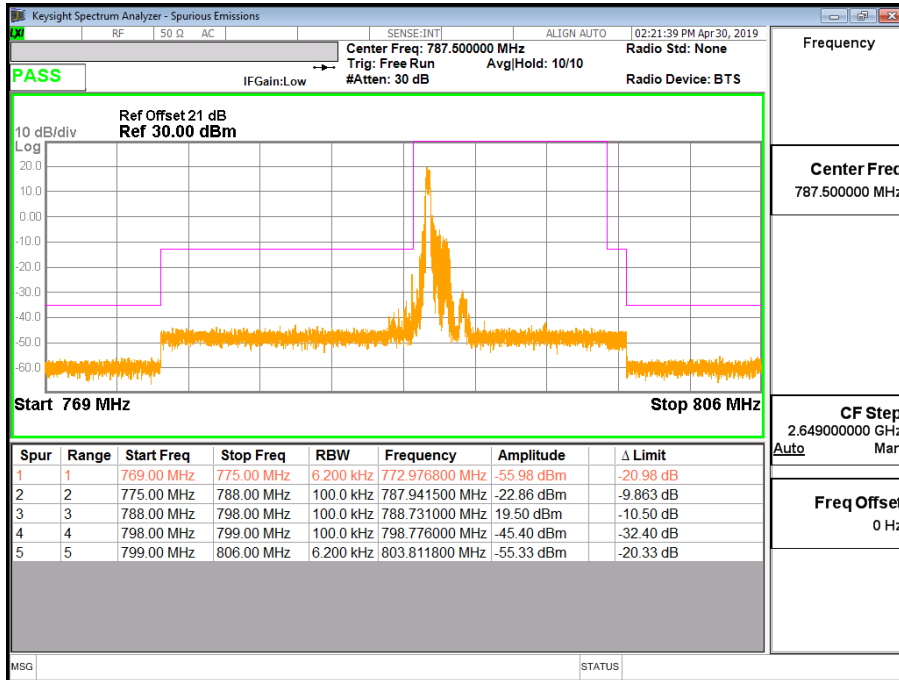

Band 14 (10M) QPSK Index7(1,5) Upper Channel 23330 (793MHz)

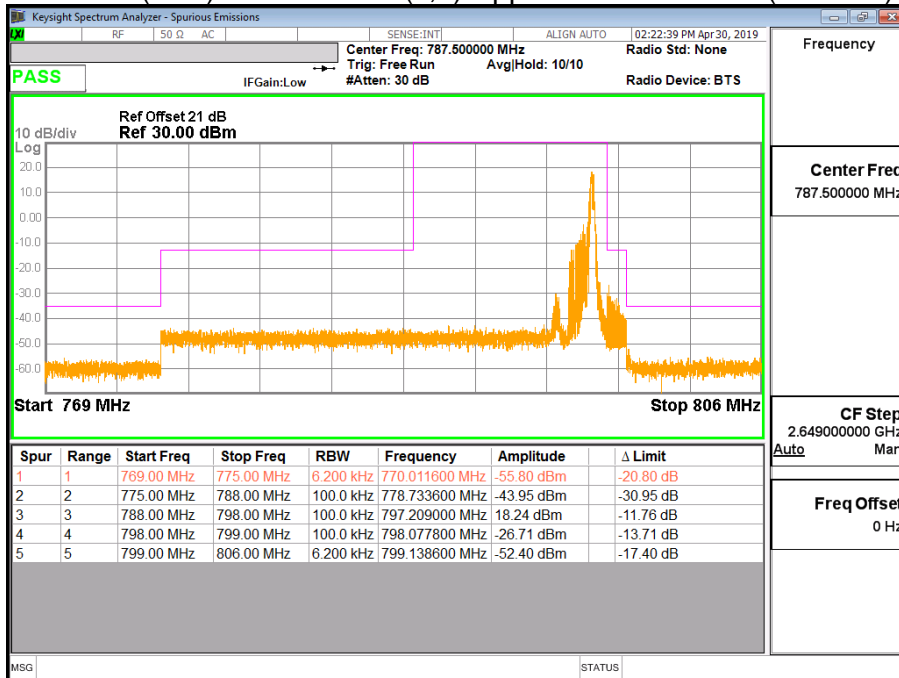

Band 14 (10M) QPSK Index0(6,0) Lower Channel 23330 (793MHz)

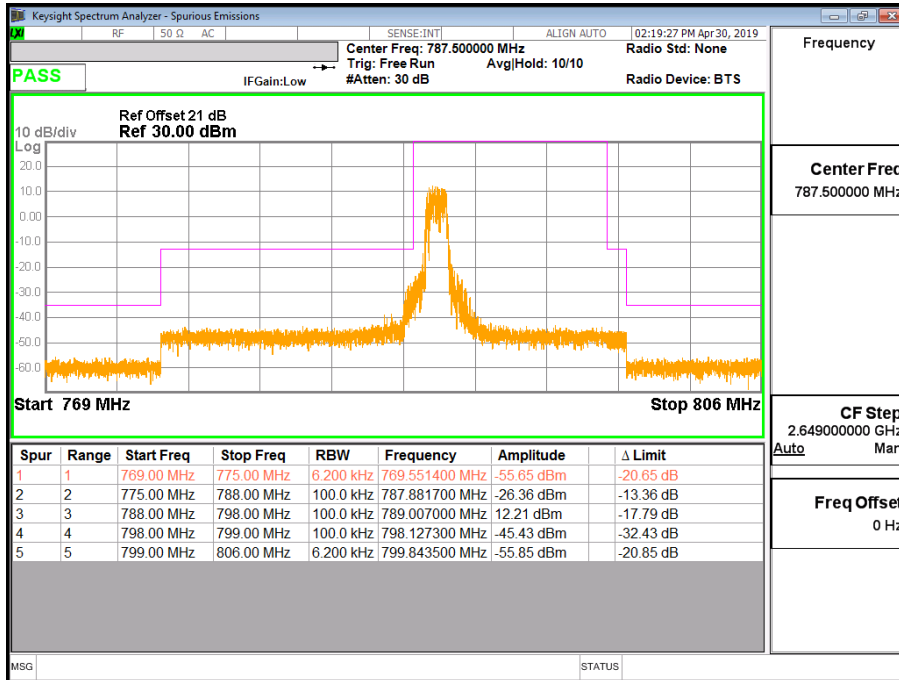

Band 14 (10M) QPSK Index7(6,0) Upper Channel 23330 (793MHz)

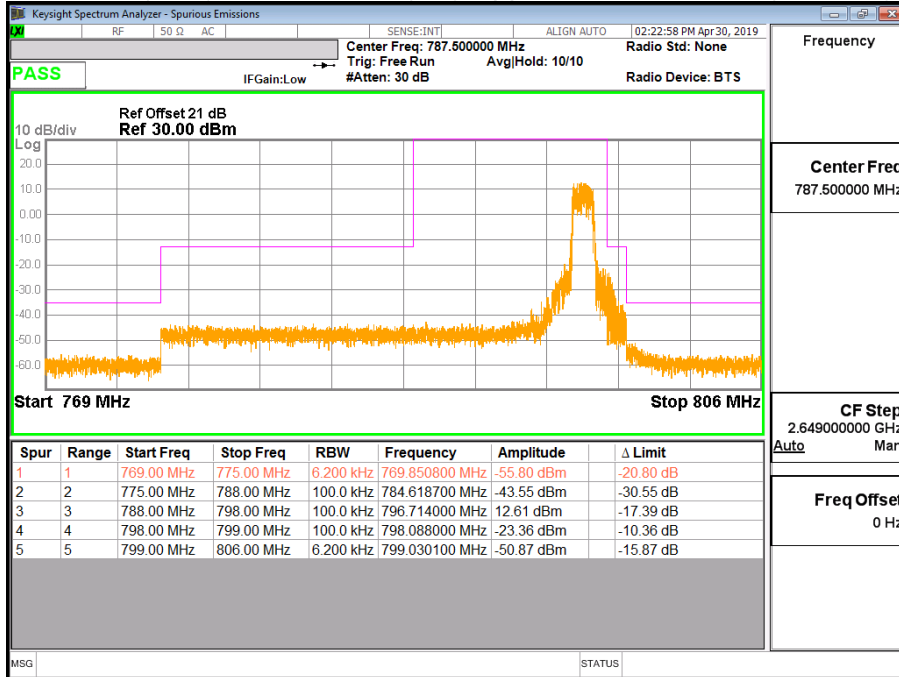



### Band 14 (10M) 16QAM Index0(1,0) Lower Channel 23330 (793MHz)

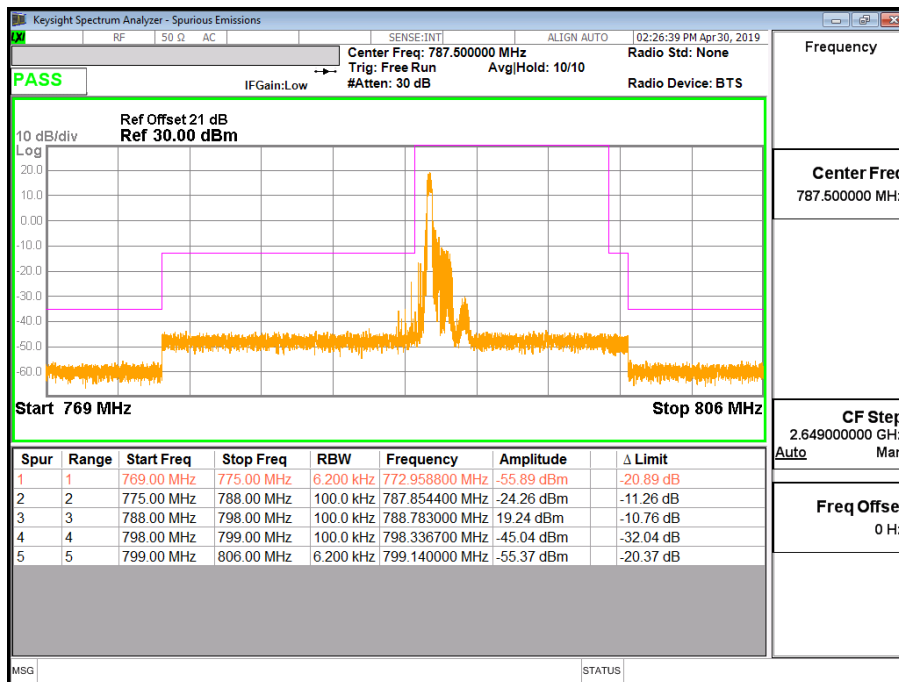

### Band 14 (10M) 16QAM Index7(1,5) Upper Channel 23330 (793MHz)

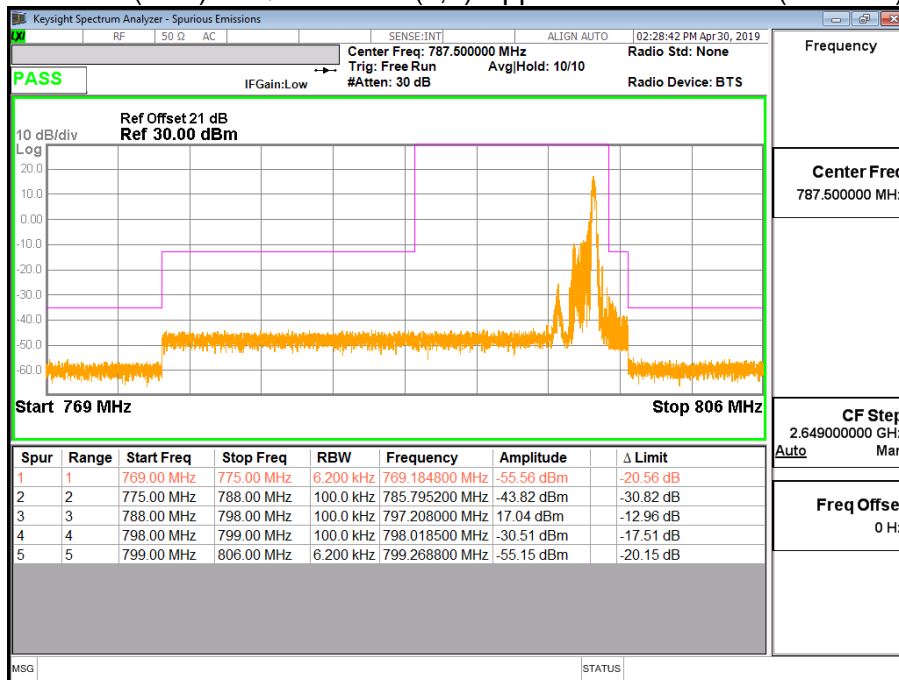

### Band 14 (10M) 16QAM Index0(5,0) Lower Channel 23330 (793MHz)

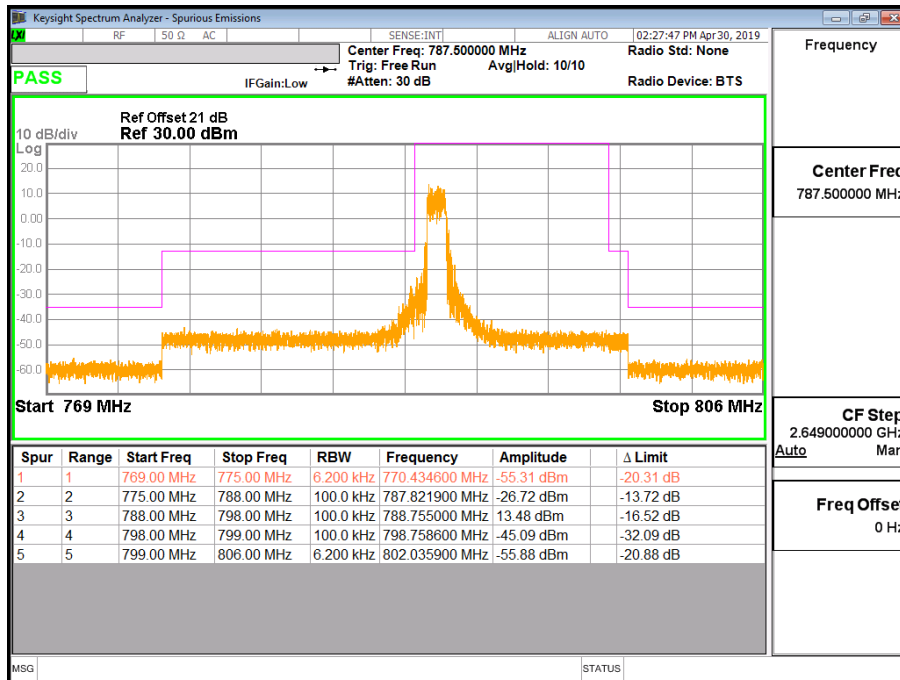

### Band 14 (10M) 16QAM Index7(5,1) Upper Channel 23330 (793MHz)

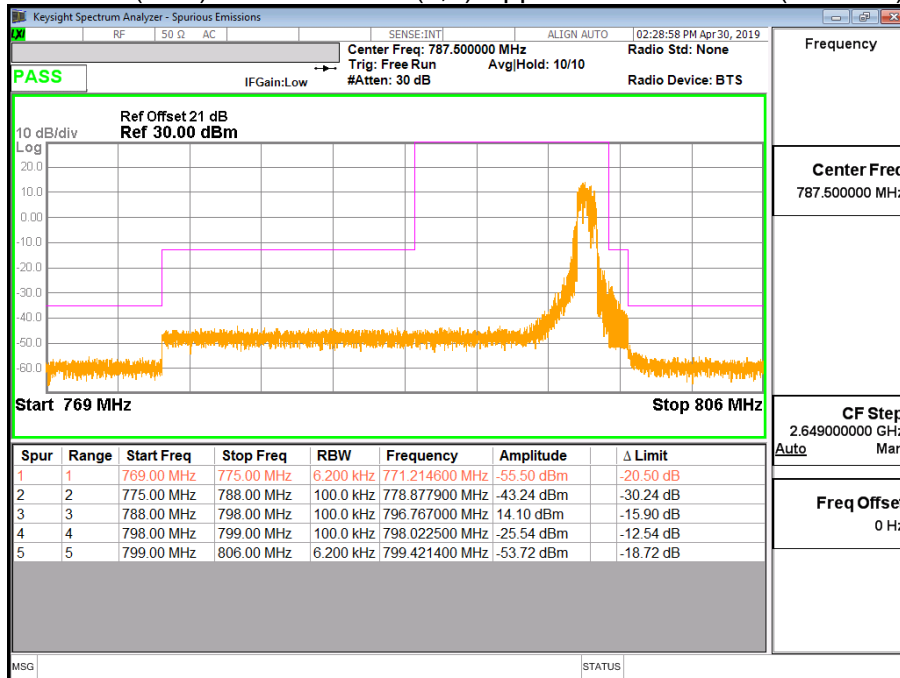

## 6. Spurious Emission

### 6.1. Test Specification

According to Part 2.1051, 90.543

### 6.2. Test Setup

#### 6.2.1 Spurious emissions at antenna terminals.

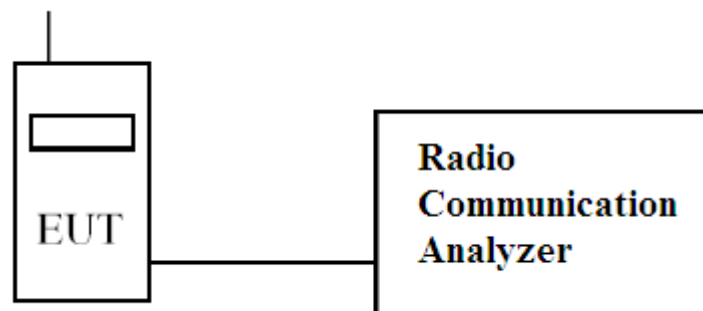

#### 6.2.2 Field strength of spurious radiation.

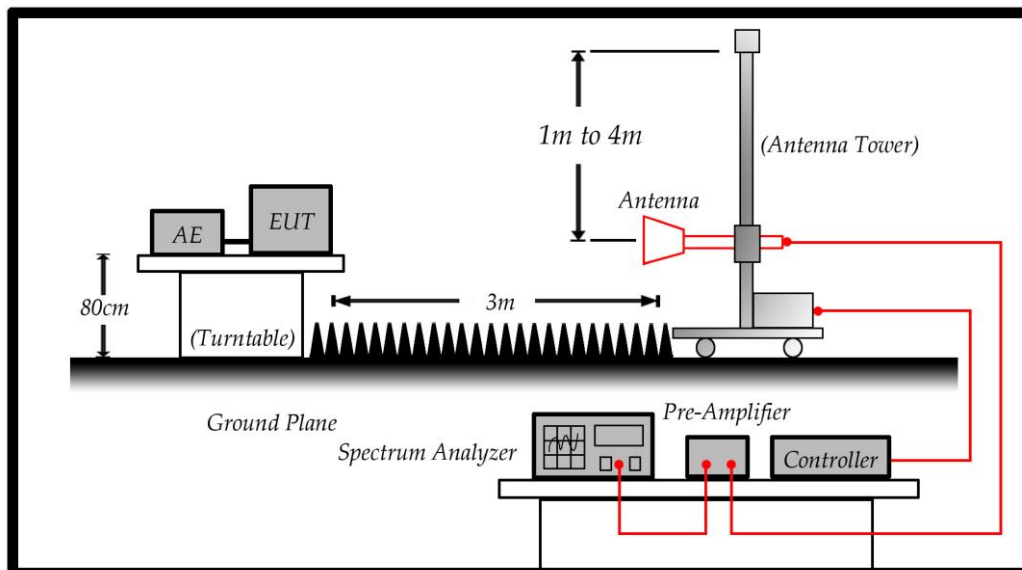

Note: The Worst case Mode is QPSK Mode for Radiated spurious emissions.

### 6.3. Limits

|              |                   |
|--------------|-------------------|
| <b>Limit</b> | <b>&lt;-13dBm</b> |
|--------------|-------------------|

43 + 10Log(P) down on the carrier where P is the power in Watts.

### 6.4. Test Procedure

In accordance with Part 2.1051, 90.543, the spurious emissions from the antenna terminal were measured. The transmitter output power was attenuated using a combination of filters and attenuators and the frequency spectrum investigated from 30MHz to 10GHz. The EUT was set to transmit on full power. The EUT was tested on Low, middle and High channels for both power levels. The resolution and video bandwidth was set to 1MHz/3MHz in accordance with Part 2.1051, 90.543. The spectrum analyzer detector was set to Max Hold. In addition, measurements were made up to the 10<sup>th</sup> harmonic of the fundamental. The device was then replaced with a substitution antenna, which input signal was adjusted until the received level matched that of the previously detected emission.

- (1) The EUT is tested with maximum rated TX power via the Base Station simulator.
- (2) The EUT is tested in three orthogonal planes, The worst case was showing in this report.

The EUT is placed on a turn table which is 1.5 meter above ground. The turn table can rotate 360 degrees to determine the position of the maximum emission level. The EUT was positioned such that the distance from antenna to the EUT was 3 meters.

The antenna can move up and down between 1 meter and 4 meters to find out the maximum emission level.

Both horizontal and vertical polarization of the antenna are set on measurement. In order to find the maximum emission, all of the interface cables must be manipulated according to TIA/EIA 603-E on radiated measurement.

90.543(f) For operations in the 758-775 MHz and 788-805 MHz bands, all emissions including harmonics in the band 1559-1610 MHz shall be limited to -70 dBW/MHz equivalent isotropically radiated power (EIRP) for wideband signals, and -80 dBW EIRP for discrete emissions of less than 700 Hz bandwidth.

### 6.5. Test Result of Spurious Emission

|                |                               |            |             |
|----------------|-------------------------------|------------|-------------|
| Product        | nRF9160 IOT Module            |            |             |
| Test Mode      | Spurious Emission (Conducted) |            |             |
| Date of Test   | 2019/04/12                    | Test Site  | CTR         |
| Test Condition | LTE-Band 14 (5M)              | Test Range | 30MHz~10GHz |

#### LTE-Band 14 (5M) QPSK Index1 (1,5) CH23330 (793MHz)

| Frequency (MHz) | Reading Level (dBm) | Path Loss (dB) | Emission Level (dBm) | Limit (dBm) |
|-----------------|---------------------|----------------|----------------------|-------------|
| 1585            | -57.615             | 0.58           | -57.035              | -40         |
| 2380            | -48.948             | 0.70           | -48.248              | -13         |
| 3172            | -39.878             | 1.01           | -38.868              | -13         |
| 3964            | -59.080             | 1.18           | -57.900              | -13         |
| 4756            | -52.500             | 1.23           | -51.270              | -13         |
| 5551            | -61.762             | 1.45           | -60.312              | -13         |
| 6343            | -57.485             | 1.56           | -55.925              | -13         |
| 7135            | -65.964             | 1.59           | -64.374              | -13         |
| 7927            | -66.280             | 1.82           | -64.460              | -13         |

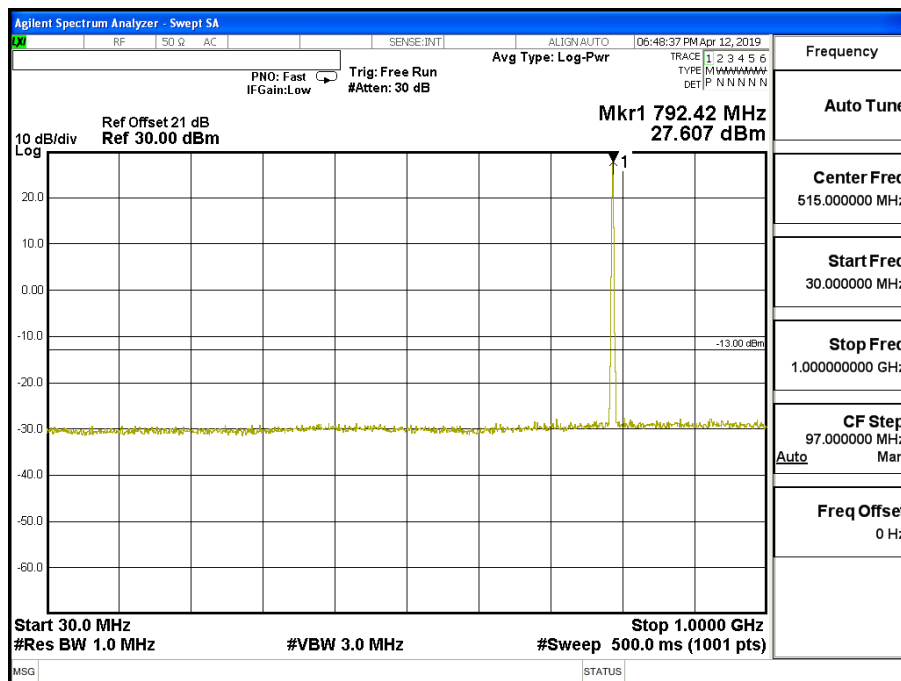

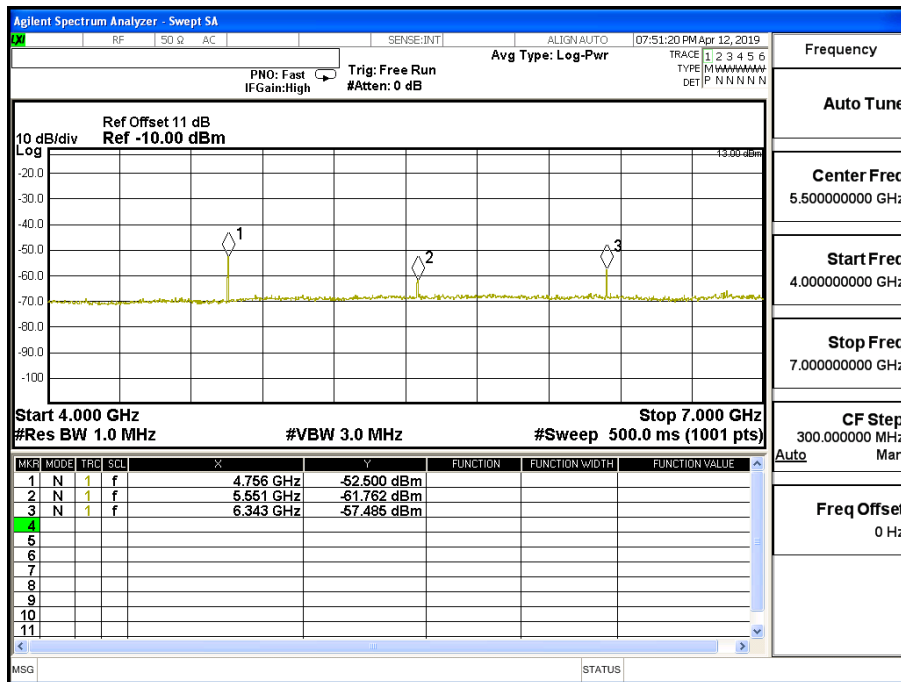
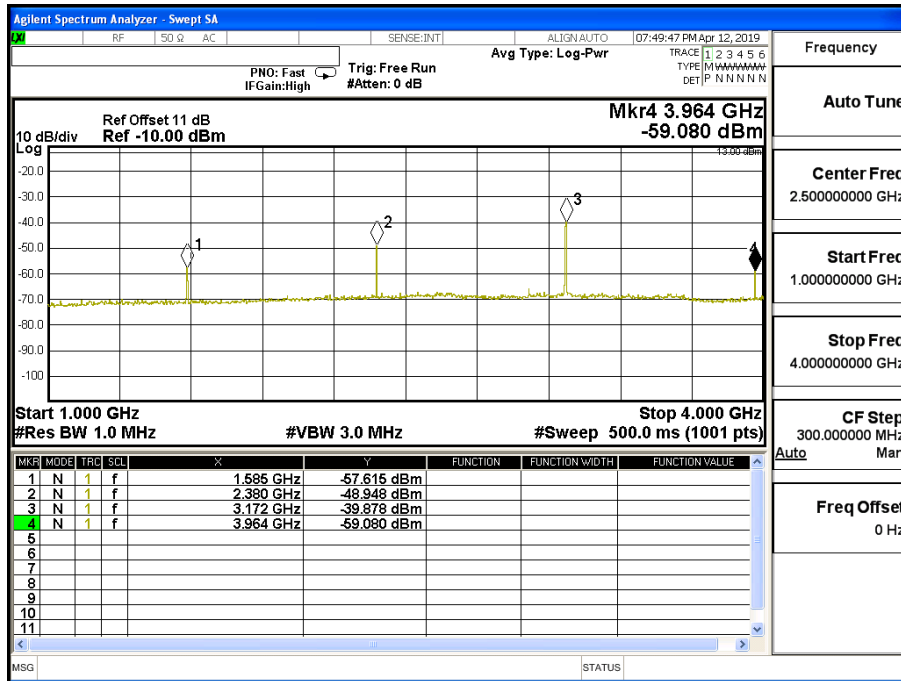

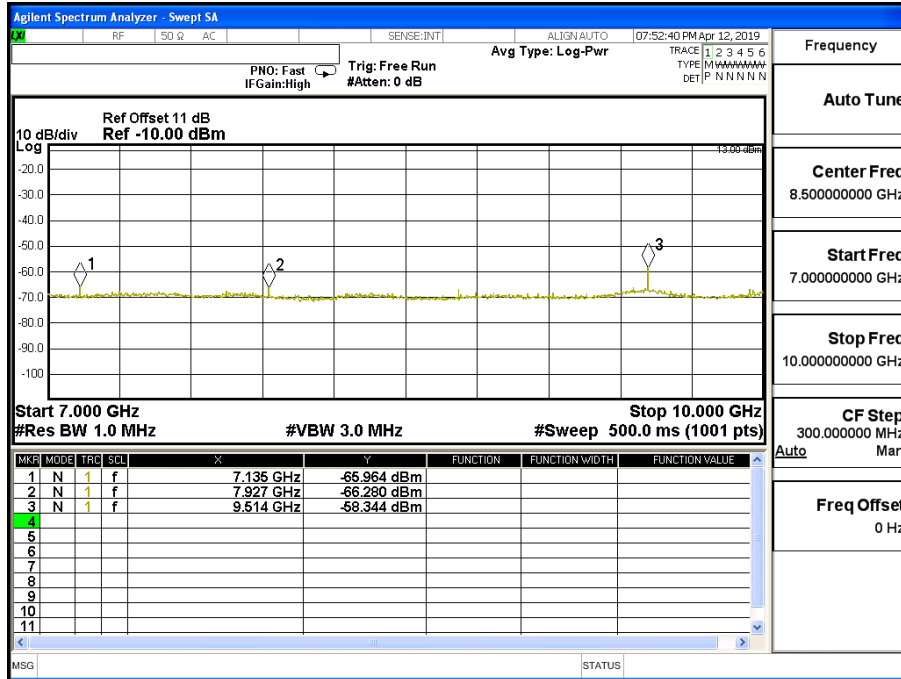

|                |                               |            |             |
|----------------|-------------------------------|------------|-------------|
| Product        | nRF9160 IOT Module            |            |             |
| Test Mode      | Spurious Emission (Conducted) |            |             |
| Date of Test   | 2019/04/12                    | Test Site  | CTR         |
| Test Condition | LTE-Band 14 (5M)              | Test Range | 30MHz~10GHz |

**LTE- Band 14 (5M) 16QAM Index0 (1,0) CH23305 (790.5MHz)**

| Frequency (MHz) | Reading Level (dBm) | Path Loss (dB) | Emission Level (dBm) | Limit (dBm) |
|-----------------|---------------------|----------------|----------------------|-------------|
| 1576            | -56.172             | 0.58           | -55.592              | -40         |
| 2365            | -48.143             | 0.70           | -47.443              | -13         |
| 3154            | -39.458             | 1.01           | -38.448              | -13         |
| 3943            | -57.386             | 1.18           | -56.206              | -13         |
| 4729            | -51.013             | 1.23           | -49.783              | -13         |
| 5518            | -61.845             | 1.45           | -60.395              | -13         |
| 6307            | -56.728             | 1.56           | -55.168              | -13         |
| 7096            | -63.524             | 1.59           | -61.934              | -13         |
| 7885            | -67.705             | 1.82           | -65.885              | -13         |

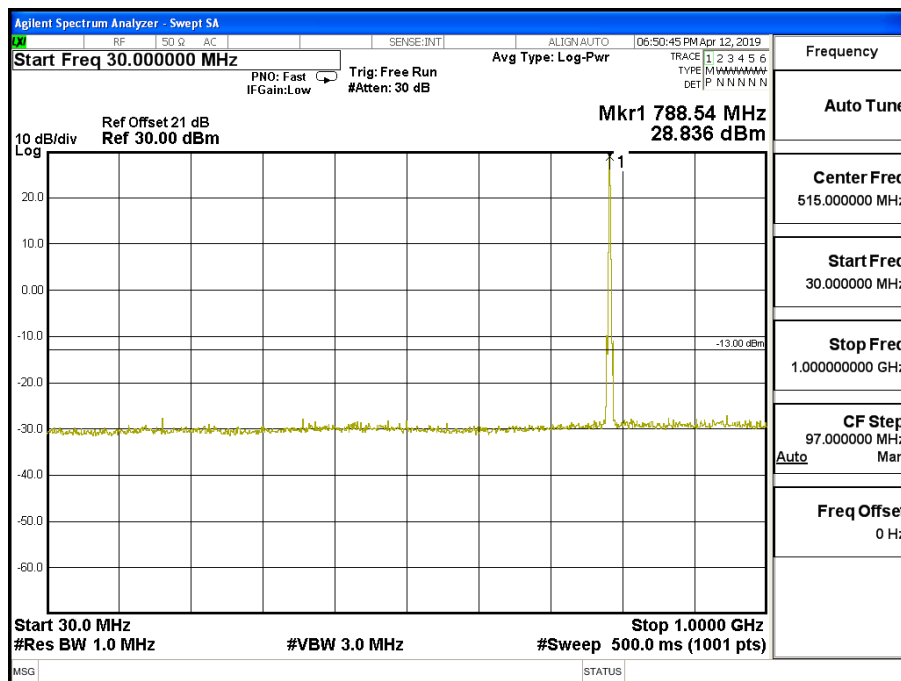





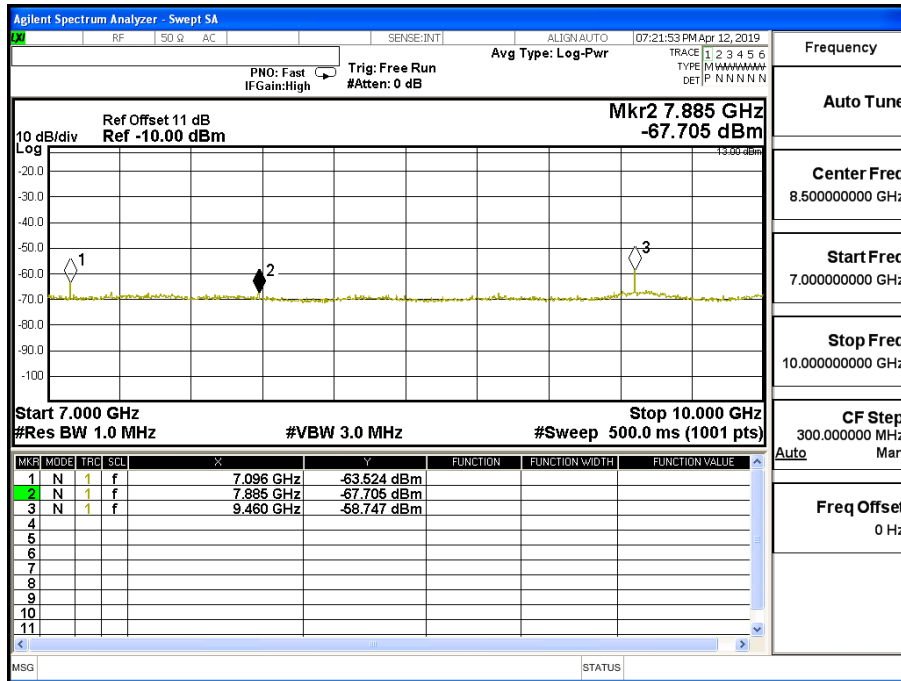

|                |                               |            |             |
|----------------|-------------------------------|------------|-------------|
| Product        | nRF9160 IOT Module            |            |             |
| Test Mode      | Spurious Emission (Conducted) |            |             |
| Date of Test   | 2019/04/12                    | Test Site  | CTR         |
| Test Condition | LTE-Band 14 (10M)             | Test Range | 30MHz~10GHz |

**LTE- Band 14 (10M) QPSK Index7 (1,5) CH23330 (793MHz)**

| Frequency (MHz) | Reading Level (dBm) | Path Loss (dB) | Emission Level (dBm) | Limit (dBm) |
|-----------------|---------------------|----------------|----------------------|-------------|
| 1594            | -57.981             | 0.58           | -57.401              | -40         |
| 2392            | -48.896             | 0.70           | -48.196              | -13         |
| 3190            | -39.802             | 1.01           | -38.792              | -13         |
| 3985            | -60.156             | 1.18           | -58.976              | -13         |
| 4783            | -52.393             | 1.23           | -51.163              | -13         |
| 5581            | -60.492             | 1.45           | -59.042              | -13         |
| 6379            | -58.049             | 1.56           | -56.489              | -13         |
| 7175            | -64.612             | 1.59           | -63.022              | -13         |
| 7972            | -66.929             | 1.82           | -65.109              | -13         |

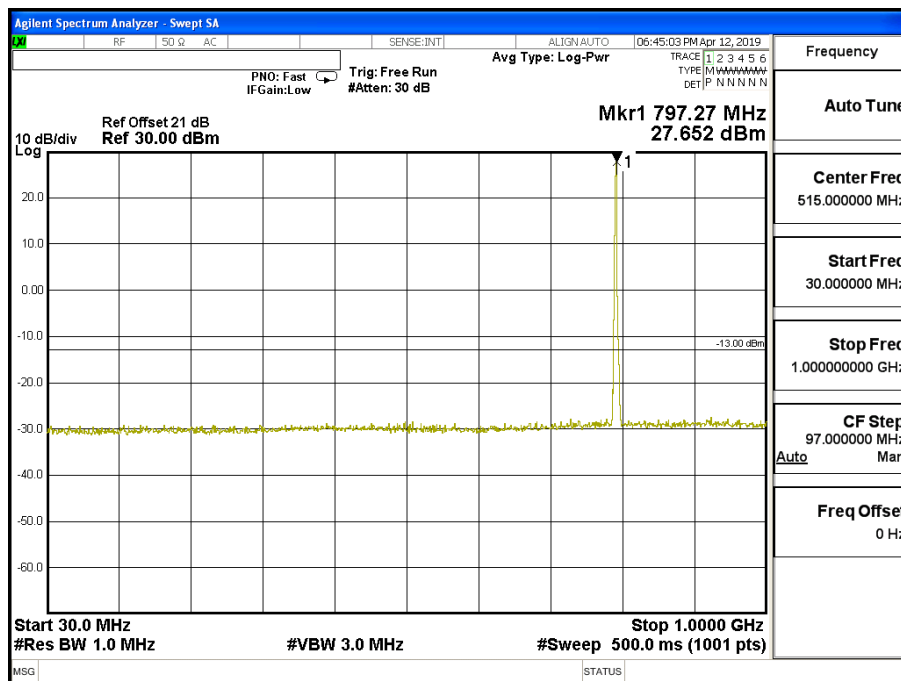



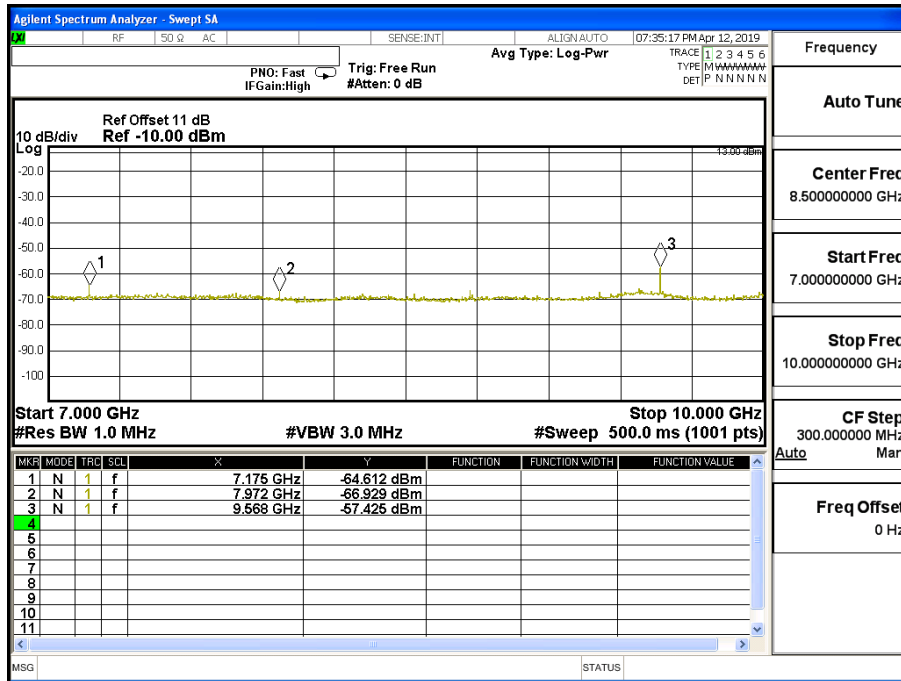

|                |                               |            |             |
|----------------|-------------------------------|------------|-------------|
| Product        | nRF9160 IOT Module            |            |             |
| Test Mode      | Spurious Emission (Conducted) |            |             |
| Date of Test   | 2019/04/12                    | Test Site  | CTR         |
| Test Condition | LTE-Band 14 (10M)             | Test Range | 30MHz~10GHz |

**LTE- Band 14 10M 16QAM Index0 (1,0) CH23330 (793MHz)**

| Frequency (MHz) | Reading Level (dBm) | Path Loss (dB) | Emission Level (dBm) | Limit (dBm) |
|-----------------|---------------------|----------------|----------------------|-------------|
| 1576            | -55.821             | 0.58           | -55.241              | -40         |
| 2365            | -48.150             | 0.70           | -47.450              | -13         |
| 3154            | -39.342             | 1.01           | -38.332              | -13         |
| 3943            | -56.938             | 1.18           | -55.758              | -13         |
| 4732            | -51.110             | 1.23           | -49.880              | -13         |
| 5521            | -60.488             | 1.45           | -59.038              | -13         |
| 6310            | -56.297             | 1.56           | -54.737              | -13         |
| 7099            | -64.175             | 1.59           | -62.585              | -13         |
| 7888            | -67.681             | 1.82           | -65.861              | -13         |

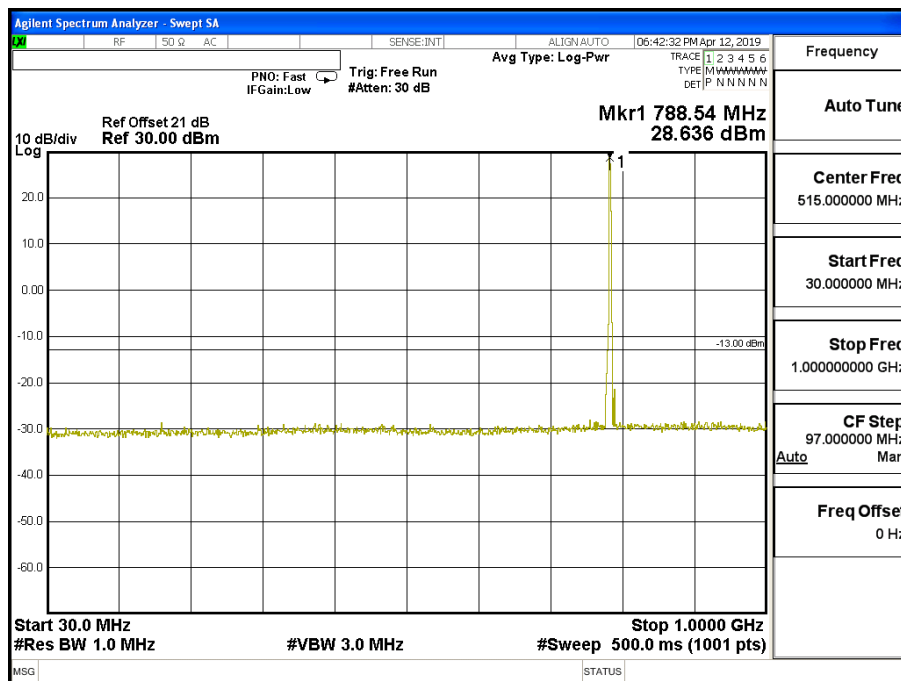



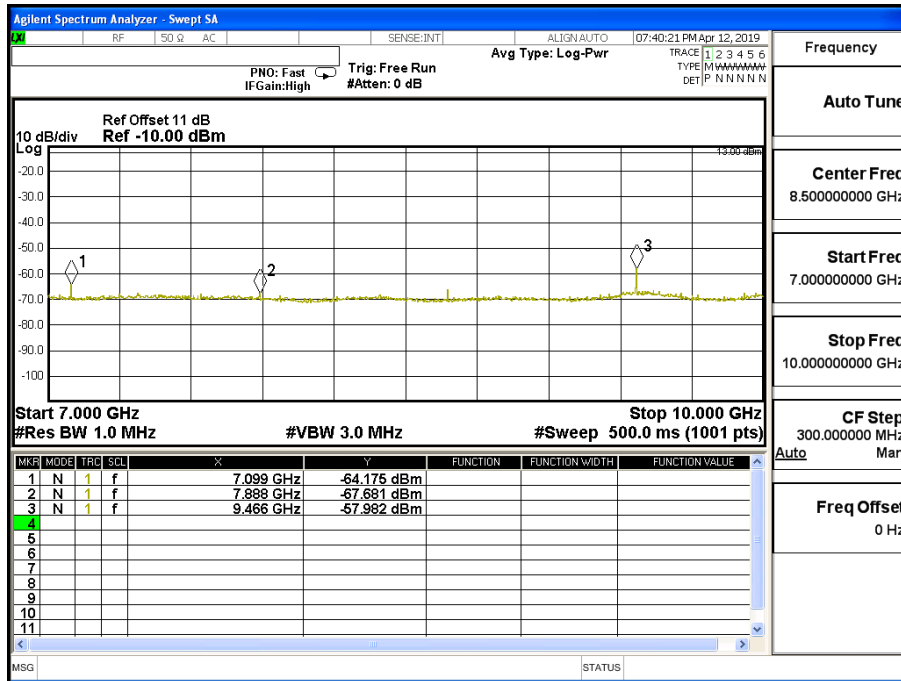



|                |   |            |             |
|----------------|---|------------|-------------|
| Product        | nRF9160 IOT Module  |            |             |
| Test Mode      | Spurious Emission (Radiated) - Multi Band Dipole Antenna (STAF) |            |             |
| Date of Test   | 2019/04/12  | Test Site  | Site3       |
| Test Condition | Band 14 (5M) QPSK(1,5)  | Test Range | 9KHz ~10GHz |

| Frequency | Reading Level | Signal Generator Level | Cable Loss | Antenna Gain | EIRP Value | Limit |
|-----------|---------------|------------------------|------------|--------------|------------|-------|
| (GHz)     | (dBm)         | (dBm)                  | (dB)       | (dBi)        | (dBm)      | (dBm) |

#### Horizontal Emissions Band 14 (5M) QPSK Index1 (1,5) CH23330 (793MHz)

|      |         |         |       |        |         |     |
|------|---------|---------|-------|--------|---------|-----|
| 1582 | -47.954 | -52.277 | 1.630 | 9.800  | -44.107 | -40 |
| 2373 | -64.821 | -65.241 | 2.100 | 10.600 | -56.741 | -13 |
| 3164 | -51.829 | -52.771 | 2.350 | 12.300 | -42.821 | -13 |
| 3955 | -58.034 | -57.362 | 2.700 | 12.600 | -47.462 | -13 |
| 4746 | -62.459 | -58.905 | 2.830 | 12.700 | -49.035 | -13 |
| 5537 | -63.823 | -60.077 | 3.200 | 13.000 | -50.277 | -13 |

#### Vertical Emissions Band 14 (5M) QPSK Index1 (1,5) CH23330 (793MHz)

|      |         |         |       |        |         |     |
|------|---------|---------|-------|--------|---------|-----|
| 1582 | -47.704 | -51.497 | 1.630 | 9.800  | -43.327 | -40 |
| 2373 | -64.483 | -64.427 | 2.100 | 10.600 | -55.927 | -13 |
| 3164 | -41.541 | -41.583 | 2.350 | 12.300 | -31.633 | -13 |
| 3955 | -61.556 | -59.482 | 2.700 | 12.600 | -49.582 | -13 |
| 4746 | -63.231 | -58.906 | 2.830 | 12.700 | -49.036 | -13 |
| 5537 | -63.798 | -59.516 | 3.200 | 13.000 | -49.716 | -13 |

#### Note:

1. Receiver setting (Peak Detector) : RBW:1MHz; VBW:3MHz
2. EIRP Value = Signal Generator Level + Antenna Gain - Cable Loss
3. Spurious emissions past 6 GHz are not shown, due to the magnitude of spurious emissions attenuated more than 20 dB below the limit.

|                |   |            |             |
|----------------|---|------------|-------------|
| Product        | nRF9160 IOT Module  |            |             |
| Test Mode      | Spurious Emission (Radiated) - Multi Band Dipole Antenna (STAF) |            |             |
| Date of Test   | 2019/04/12  | Test Site  | Site3       |
| Test Condition | Band 14 (10M) QPSK(1,5)   | Test Range | 9KHz ~10GHz |

| Frequency | Reading Level | Signal Generator Level | Cable Loss | Antenna Gain | EIRP Value | Limit |
|-----------|---------------|------------------------|------------|--------------|------------|-------|
| (GHz)     | (dBm)         | (dBm)                  | (dB)       | (dBi)        | (dBm)      | (dBm) |

#### Horizontal Emissions Band 14 (10M) QPSK Index7 (1,5) CH23330 (793MHz)

|      |         |         |       |        |         |     |
|------|---------|---------|-------|--------|---------|-----|
| 1594 | -48.243 | -52.428 | 1.630 | 9.800  | -44.258 | -40 |
| 2391 | -63.997 | -64.625 | 2.100 | 10.600 | -56.125 | -13 |
| 3188 | -50.579 | -51.557 | 2.350 | 12.300 | -41.607 | -13 |
| 3985 | -57.167 | -56.322 | 2.700 | 12.600 | -46.422 | -13 |
| 4782 | -59.959 | -56.330 | 2.830 | 12.700 | -46.460 | -13 |
| 5579 | -64.317 | -60.859 | 3.200 | 13.000 | -51.059 | -13 |

#### Vertical Emissions Band 14 (10M) QPSK Index7 (1,5) CH23330 (793MHz)

|      |         |         |       |        |         |     |
|------|---------|---------|-------|--------|---------|-----|
| 1594 | -48.728 | -52.552 | 1.630 | 9.800  | -44.382 | -40 |
| 2391 | -63.428 | -63.483 | 2.100 | 10.600 | -54.983 | -13 |
| 3188 | -40.567 | -40.595 | 2.350 | 12.300 | -30.645 | -13 |
| 3985 | -60.710 | -58.552 | 2.700 | 12.600 | -48.652 | -13 |
| 4782 | -64.005 | -59.581 | 2.830 | 12.700 | -49.711 | -13 |
| 5579 | -63.392 | -59.393 | 3.200 | 13.000 | -49.593 | -13 |

#### Note:

1. Receiver setting (Peak Detector) : RBW:1MHz; VBW:3MHz
2. EIRP Value = Signal Generator Level + Antenna Gain - Cable Loss
3. Spurious emissions past 6 GHz are not shown, due to the magnitude of spurious emissions attenuated more than 20 dB below the limit.

## 7. Frequency Stability Under Temperature & Voltage Variations

### 7.1. Test Specification

According to Part 2.1055, 90.213

### 7.2. Test Setup

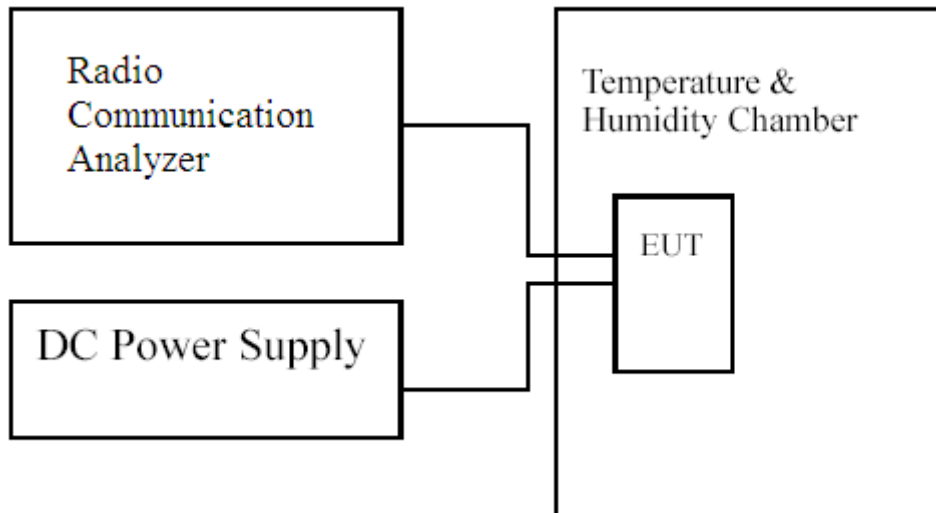

### 7.3. Limits

|              |                    |
|--------------|--------------------|
| <b>Limit</b> | <b>&lt;±2.5ppm</b> |
|--------------|--------------------|

### 7.4. Test Procedure

The frequency stability of transmitter is measured by:

- (a) Temperature: The temperature is varied from -30 °C to 50 °C in 10 °C increment using a standard temperature & Humidity chamber.
- (b) Primary Supply Voltage: The primary supply voltage is varied 85% to 115% of the nominal value for non hand-carried equipment. For hand-carried, battery-powered equipment, primary supply voltage is reduced to the battery operating endpoint which shall be specified by the manufacturer.

The EUT was connected via the base station simulator. Universal Radio Communication Tester, (MT8820C), was used to measure The Frequency Error. The maximum result of measurements was recorded.

## 7.5. Test Result of Frequency Stability Under Temperature Variations

|                |   |            |              |
|----------------|---|------------|--------------|
| Product        | nRF9160 IOT Module  |            |              |
| Test Mode      | Frequency Stability Under Temperature Variations & Voltage Variations |            |              |
| Date of Test   | 2019/04/12  | Test Site  | CTR          |
| Test Condition | Band 14 (5M) CH23330(793MHz) –QPSK                                    | Test Range | -30°C ~+50°C |

### Frequency Stability Under Temperature Variations

| Temperature Interval(°C) | Test Frequency (GHz) | Deviation (kHz) | Limit (kHz) |
|--------------------------|----------------------|-----------------|-------------|
| -30                      | 0.793                | -0.0103         | ±1.98       |
| -20                      | 0.793                | 0.0138          | ±1.98       |
| -10                      | 0.793                | 0.0149          | ±1.98       |
| 0                        | 0.793                | -0.0085         | ±1.98       |
| 10                       | 0.793                | 0.0113          | ±1.98       |
| 20                       | 0.793                | 0.0108          | ±1.98       |
| 30                       | 0.793                | -0.0132         | ±1.98       |
| 40                       | 0.793                | 0.0118          | ±1.98       |
| 50                       | 0.793                | 0.0147          | ±1.98       |

### Voltage Variations

| DC Voltage (V) | Test Frequency (GHz) | Deviation (kHz) | Limit (kHz) |
|----------------|----------------------|-----------------|-------------|
| 5.5            | 0.793                | -0.0089         | ±1.98       |
| 3.8            | 0.793                | 0.0108          | ±1.98       |
| 3.1            | 0.793                | -0.0076         | ±1.98       |

|                |   |            |              |
|----------------|---|------------|--------------|
| Product        | nRF9160 IOT Module  |            |              |
| Test Mode      | Frequency Stability Under Temperature Variations & Voltage Variations |            |              |
| Date of Test   | 2019/04/12  | Test Site  | CTR          |
| Test Condition | Band 14 (5M) CH23330(793MHz) –16QAM                                   | Test Range | -30°C ~+50°C |

#### Frequency Stability Under Temperature Variations

| Temperature Interval(°C) | Test Frequency (GHz) | Deviation (kHz) | Limit (kHz) |
|--------------------------|----------------------|-----------------|-------------|
| -30                      | 0.793                | 0.0162          | ±1.98       |
| -20                      | 0.793                | -0.0108         | ±1.98       |
| -10                      | 0.793                | -0.0142         | ±1.98       |
| 0                        | 0.793                | 0.0076          | ±1.98       |
| 10                       | 0.793                | 0.0115          | ±1.98       |
| 20                       | 0.793                | 0.0117          | ±1.98       |
| 30                       | 0.793                | -0.0111         | ±1.98       |
| 40                       | 0.793                | 0.0120          | ±1.98       |
| 50                       | 0.793                | -0.0094         | ±1.98       |

#### Voltage Variations

| DC Voltage (V) | Test Frequency (GHz) | Deviation (kHz) | Limit (kHz) |
|----------------|----------------------|-----------------|-------------|
| 5.5            | 0.793                | -0.0080         | ±1.98       |
| 3.8            | 0.793                | 0.0117          | ±1.98       |
| 3.1            | 0.793                | -0.0045         | ±1.98       |

|                |   |            |              |
|----------------|---|------------|--------------|
| Product        | nRF9160 IOT Module  |            |              |
| Test Mode      | Frequency Stability Under Temperature Variations & Voltage Variations |            |              |
| Date of Test   | 2019/04/12  | Test Site  | CTR          |
| Test Condition | Band 14 (10M) CH23330(793MHz)-QPSK                                    | Test Range | -30°C ~+50°C |

#### Frequency Stability Under Temperature Variations

| Temperature Interval(°C) | Test Frequency (GHz) | Deviation (kHz) | Limit (kHz) |
|--------------------------|----------------------|-----------------|-------------|
| -30                      | 0.793                | 0.0128          | ±1.98       |
| -20                      | 0.793                | -0.0087         | ±1.98       |
| -10                      | 0.793                | -0.0099         | ±1.98       |
| 0                        | 0.793                | 0.0107          | ±1.98       |
| 10                       | 0.793                | 0.0154          | ±1.98       |
| 20                       | 0.793                | 0.0066          | ±1.98       |
| 30                       | 0.793                | -0.0100         | ±1.98       |
| 40                       | 0.793                | 0.0113          | ±1.98       |
| 50                       | 0.793                | 0.0159          | ±1.98       |

#### Voltage Variations

| DC Voltage (V) | Test Frequency (GHz) | Deviation (kHz) | Limit (kHz) |
|----------------|----------------------|-----------------|-------------|
| 5.5            | 0.793                | -0.0124         | ±1.98       |
| 3.8            | 0.793                | 0.0066          | ±1.98       |
| 3.1            | 0.793                | -0.0086         | ±1.98       |

|                |   |            |             |
|----------------|---|------------|-------------|
| Product        | nRF9160 IOT Module  |            |             |
| Test Mode      | Frequency Stability Under Temperature Variations & Voltage Variations |            |             |
| Date of Test   | 2019/04/12  | Test Site  | CTR         |
| Test Condition | Band 14 (10M) CH23330(793MHz)-16QAM                                   | Test Range | -30°C~+50°C |

#### Frequency Stability Under Temperature Variations

| Temperature Interval(°C) | Test Frequency (GHz) | Deviation (kHz) | Limit (kHz) |
|--------------------------|----------------------|-----------------|-------------|
| -30                      | 0.793                | 0.0109          | ±1.98       |
| -20                      | 0.793                | -0.0098         | ±1.98       |
| -10                      | 0.793                | -0.0149         | ±1.98       |
| 0                        | 0.793                | 0.0115          | ±1.98       |
| 10                       | 0.793                | -0.0102         | ±1.98       |
| 20                       | 0.793                | 0.0056          | ±1.98       |
| 30                       | 0.793                | -0.0107         | ±1.98       |
| 40                       | 0.793                | -0.0129         | ±1.98       |
| 50                       | 0.793                | -0.0063         | ±1.98       |

#### Voltage Variations

| DC Voltage (V) | Test Frequency (GHz) | Deviation (kHz) | Limit (kHz) |
|----------------|----------------------|-----------------|-------------|
| 5.5            | 0.793                | -0.0106         | ±1.98       |
| 3.8            | 0.793                | 0.0056          | ±1.98       |
| 3.1            | 0.793                | 0.0069          | ±1.98       |