



BUREAU
VERITAS

Test Report No.: PSU-QSU2404090210RF01



Certificate #6613.01

VARIANT FCC TEST REPORT (PART 22)



Applicant:	NORDIC SEMICONDUCTOR ASA
Address:	Otto Nielsens Vel 12, 7052 Trondheim, Norway

Manufacturer or Supplier:	NORDIC SEMICONDUCTOR ASA
Address:	Otto Nielsens Vel 12, 7052 Trondheim, Norway
Product:	Cellular IoT module
Brand Name:	nRF91
Model Name:	nRF9151
FCC ID	2ANPO00NRF9151
Date of tests	Apr. 12, 2024 ~ Jun. 14, 2024

The tests have been carried out according to the requirements of the following standard:

- FCC PART 22, Subpart H
- ANSI/TIA/EIA-603-D
- ANSI/TIA/EIA-603-E
- FCC Part 2
- ANSI C63.26-2015

CONCLUSION: The submitted sample was found to COMPLY with the test requirement

Prepared by Hanwen Xu Engineer / Mobile Department	Approved by Peibo Sun Manager / Mobile Department
	
Date: Jul. 02, 2024	Date: Jul. 02, 2024

This report is governed by, and incorporates by reference, the Conditions of Testing as posted at the date of issuance of this report at <http://www.bureauveritas.com/home/about-us/our-business/cps/about-us/terms-conditions/> and is intended for your exclusive use. Any copying or replication of this report to or for any other person or entity, or use of our name or trademark, is permitted only with our prior written permission. This report sets forth our findings solely with respect to the test samples identified herein. The results set forth in this report are not indicative or representative of the quality or characteristics of the lot from which a test sample was taken or any similar or identical product unless specifically and expressly noted. Our report includes all of the tests requested by you and the results thereof based upon the information that you provided to us. Measurement uncertainty is only provided upon request for accredited tests. Statements of conformity are based on simple acceptance criteria without taking measurement uncertainty into account, unless otherwise requested in writing. You have 60 days from date of issuance of this report to notify us of any material error or omission caused by our negligence or if you require measurement uncertainty; provided, however, that such notice shall be in writing and shall specifically address the issue you wish to raise. A failure to raise such issue within the prescribed time shall constitute your unqualified acceptance of the completeness of this report, the tests conducted and the correctness of the report contents.



TABLE OF CONTENTS

RELEASE CONTROL RECORD4

1 SUMMARY OF TEST RESULTS.....5

1.1 MEASUREMENT UNCERTAINTY7

1.2 TEST SITE AND INSTRUMENTS8

2 GENERAL INFORMATION10

2.1 GENERAL DESCRIPTION OF EUT 10

2.2 CONFIGURATION OF SYSTEM UNDER TEST 12

2.3 DESCRIPTION OF SUPPORT UNITS 13

2.4 TEST ITEM AND TEST CONFIGURATION..... 13

2.5 EUT OPERATING CONDITIONS 16

2.6 GENERAL DESCRIPTION OF APPLIED STANDARDS 17

3 TEST TYPES AND RESULTS.....18

3.1 OUTPUT POWER MEASUREMENT 18

3.1.1 LIMITS OF OUTPUT POWER MEASUREMENT 18

3.1.2 TEST PROCEDURES 18

3.1.3 TEST SETUP 19

3.1.4 TEST RESULTS 19

3.2 FREQUENCY STABILITY MEASUREMENT 32

3.2.1 LIMITS OF FREQUENCY STABILITY MEASUREMENT 32

3.2.2 TEST PROCEDURE 32

3.2.3 TEST SETUP 32

3.2.4 TEST RESULTS 33

3.3 OCCUPIED BANDWIDTH MEASUREMENT 34

3.3.1 LIMITS OF OCCUPIED BANDWIDTH MEASUREMENT 34

3.3.2 TEST SETUP 34

3.3.3 TEST PROCEDURES 34

3.3.4 TEST RESULTS 35

3.4 BAND EDGE MEASUREMENT 36

3.4.1 LIMITS OF BAND EDGE MEASUREMENT 36

3.4.2 TEST SETUP 36

3.4.3 TEST PROCEDURES 37

3.4.4 TEST RESULTS 38

3.5 CONDUCTED SPURIOUS EMISSIONS..... 39

3.5.1 LIMITS OF CONDUCTED SPURIOUS EMISSIONS MEASUREMENT 39

3.5.2 TEST PROCEDURE 39

3.5.3 TEST SETUP 39

3.5.4 TEST RESULTS 40

3.6 RADIATED EMISSION MEASUREMENT 41

3.6.1 LIMITS OF RADIATED EMISSION MEASUREMENT 41

3.6.2 TEST PROCEDURES 41

3.6.3 DEVIATION FROM TEST STANDARD 41

3.6.4 TEST SETUP 42

3.6.5 TEST RESULTS 44



**BUREAU
VERITAS**

Test Report No.: PSU-QSU2404090210RF01

3.7	PEAK TO AVERAGE RATIO	66
3.7.1	LIMITS OF PEAK TO AVERAGE RATIO MEASUREMENT	66
3.7.2	TEST SETUP	66
3.7.3	TEST PROCEDURES	66
3.7.4	TEST RESULTS	67
4	PHOTOGRAPHS OF THE TEST CONFIGURATION	68
5	INFORMATION ON THE TESTING LABORATORIES	69
6	MODIFICATIONS RECORDERS FOR ENGINEERING CHANGES TO THE EUT BY THE LAB	70



RELEASE CONTROL RECORD

ISSUE NO.	REASON FOR CHANGE	DATE ISSUED
77535RRF.001	Original release	Mar. 21, 24
PSU-QSU2404090210RF01	Based on the original report (Report No.: 77535RRF.001, Model Name: nRF9151, FCC ID: 2ANPO00nRF9151). The firm wares are all the same, just different SW name and change Power class from PC3 to PC5. The new sample verify RSE worse case and conducted power. So this report only replaces the conducted power and RSE data. other test data refer to the original report.	Jun. 14, 2024
PSU-QSU2404090210RF01	Updated antenna gains and EIRP. Verify RSE the data is better than the original, so the data is not replaced.	Jul. 02, 2024



1 SUMMARY OF TEST RESULTS

The EUT has been tested according to the following specifications:

APPLIED STANDARD: FCC Part 22 & Part 2			
STANDARD SECTION	TEST TYPE	RESULT	Test lab*
§2.1046	Coducted Output Power	Compliance	A
§22.913 (a)(5)	Equivalent Isotropic Radiated Power	Compliance	A
§2.1055 §22.355	Frequency Stability	Compliance	See Note
§2.1049	Occupied Bandwidth	Compliance	See Note
§22.913 (d)	Peak to average ratio*	Compliance	See Note
§2.1051 §22.917(a)	Band Edge Measurements	Compliance	See Note
§2.1051 §22.917(a)	Conducted Spurious Emissions	Compliance	See Note
§2.1053 §22.917(a)	Radiated Spurious Emissions	Compliance	A

* Refer to KDB 971168 D01 Power Meas License Digital Systems v03r01.

Note: Refer to the original source report (Report No.: 77535RRF.001, Model Name: nRF9151, FCC ID: 2ANPO00nRF9151).



**BUREAU
VERITAS**

Test Report No.: PSU-QSU2404090210RF01

***Test Lab Information Reference**

Lab A:

Huarui 7Layers High Technology (Suzhou) Co., Ltd.

Lab Address:

Tower N, Innovation Center, 88 Zhuyi Road, High-tech District, Suzhou City, Anhui Province

Accredited Test Lab Cert 6613.01

The FCC Site Registration No. is 434559; The Designation No. is CN1325.



1.1 MEASUREMENT UNCERTAINTY

Where relevant, the following measurement uncertainty levels have been estimated for tests performed on the EUT as specified in CISPR 16-4-2:

MEASUREMENT	UNCERTAINTY
Maximum Peak Output Power	±2.06dB
Frequency Stability	±76.97Hz
Radiated emissions (9KHz~30MHz)	±2.68dB
Radiated emissions (30MHz~1GHz)	±4.98dB
Radiated emissions (1GHz ~6GHz)	±4.70dB
Radiated emissions (6GHz ~18GHz)	±4.60dB
Radiated emissions (18GHz ~40GHz)	±4.12dB
Conducted emissions	±4.01dB
Occupied Channel Bandwidth	±43.58KHz
Band Edge Measurements	±4.70dB
Peak to average ratio	±0.76dB

This uncertainty represents an expanded uncertainty expressed at approximately the 95% confidence level using a coverage factor of k=2.

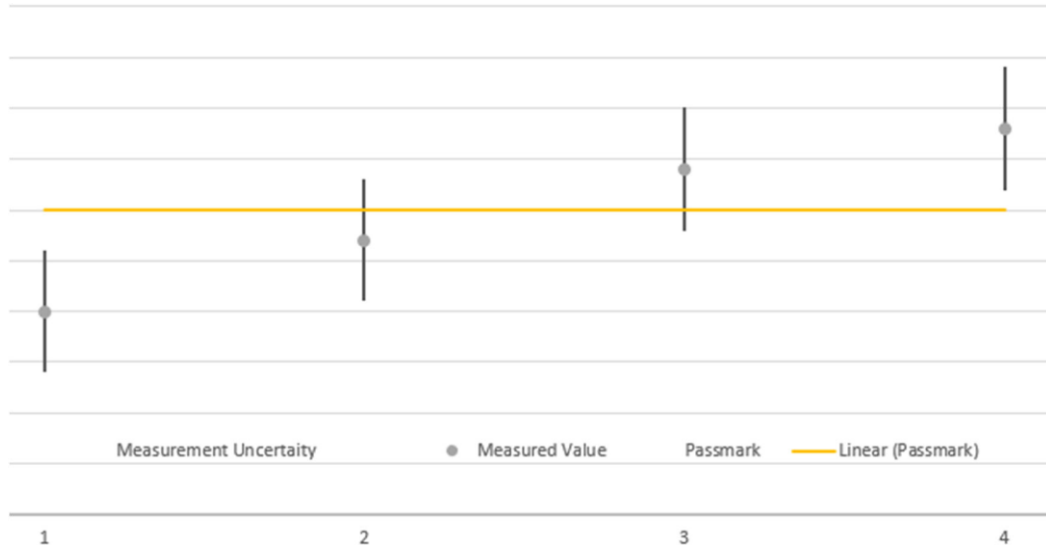

The verdicts in this test report are given according the above diagram:

Case	Measured Value	Uncertainty Range	Verdict
1	below pass mark	below pass mark	Passed
2	below pass mark	within pass mark	Passed
3	above pass mark	within pass mark	Failed
4	above pass mark	above pass mark	Failed

That means, the laboratory applies, as decision rule (see ISO/IEC 17025:2017), the so-called shared risk principle.



1.2 TEST SITE AND INSTRUMENTS

Equipment	Manufacturer	Model No.	Serial No.	Last Cal.	Next Cal.
Pre-Amplifier	R&S	SCU18F1	100815	Aug.30,22	Aug.29,24
Pre-Amplifier	R&S	SCU08F1	101028	Sep.16,22	Sep.15,24
Vector Signal Generator	R&S	SMBV100B	102176	Mar.29,24	Mar.28,26
Signal Generator	R&S	SMB100A	182185	Mar.29,24	Mar.28,26
3m Fully-anechoic Chamber	TDK	9m*6m*6m	HRSW-SZ-EM C-01Chamber	Nov.25,22	Nov.24,25
3m Semi-anechoic Chamber	TDK	9m*6m*6m	HRSW-SZ-EM C-02Chamber	Nov.25,22	Nov.24,25
EMI TEST Receiver	R&S	ESR26	101734	Mar.28,24	Mar.27,26
EMI TEST Receiver	R&S	ESW44	101973	Mar.28,24	Mar.27,26
Bilog Antenna	SCHWARZBECK	VULB 9163	1264	Dec.26,23	Dec.25,25
Horn Antenna	ETS-LINDGREN	3117	227836	Aug.22,22	Aug.21,24
Horn Antenna (18GHz-40GHz)	Steatite Q-par Antennas	QMS 00880	23486	Feb.22,24	Feb.21,26
Horn Antenna	Steatite Q-par Antennas	QMS 00208	23485	Aug.22,22	Aug.21,24
Loop Antenna	SCHWARZ	HFH2-Z2/Z2E	100976	Feb.22,24	Feb.21,26
WIDEBANDRADIO COMMUNICATION TESTER	R&S	CMW500	169399	Jun.27,22	Jun.26,24
Test Software	EMC32	EMC32	N/A	N/A	N/A
6DB attenuator	Tonscend Technology Co., Ltd	N/A	23062787	N/A	N/A
Test Software	ELEKTRA	ELEKTRA4.32	N/A	N/A	N/A
Open Switch and Control Unit	R&S	OSP220	101964	Oct.01,22	Sep.30,24
DC Source	HYELEC	HY3010B	551016	Aug.31,22	Aug.30,24
Hygrothermograph	DELI	20210528	SZ014	Sep.06,22	Sep.05,24
PC	LENOVO	E14	HRSW0024	N/A	N/A
TMC-AMI18843A(CABLE)	R&S	HF290-NMNM-7.00M	N/A	N/A	N/A
TMC-AMI18843A(CABLE)	R&S	HF290-NMNM-4.00M	N/A	N/A	N/A
CABLE	R&S	W13.02	N/A	Apr.27,24	Apr.26,25
CABLE	R&S	W12.14	N/A	Apr.27,24	Apr.26,25
CABLE	R&S	J12J103539-00-1	SEP-03-20-069	Apr.27,24	Apr.26,25
CABLE	R&S	J12J103539-00-1	SEP-03-20-070	Apr.27,24	Apr.26,25
Temperature Chamber	votsch	VT4002	58566078100050	May.31,22	May.30,24
Temperature Chamber	votsch	VT4002	58566078100050	May.30,24	May.29,26

- NOTE:** 1. The calibration interval of the above test instruments is 12/24/36 months and the calibrations are traceable to CEPREI/CHINA, GRGT/CHINA and NIM/CHINA.
2. The test was performed in 3m Semi-anechoic Chamber and RF Oven Room.



**BUREAU
VERITAS**

Test Report No.: PSU-QSU2404090210RF01

3. The horn antenna is used only for the measurement of emission frequency above 1GHz if tested.
4. The FCC Site Registration No. is 434559; The Designation No. is CN1325.



2 GENERAL INFORMATION

2.1 GENERAL DESCRIPTION OF EUT

PRODUCT*	Cellular IoT module	
BRAND NAME*	nRF91	
MODEL NAME*	nRF9151	
NOMINAL VOLTAGE*	EUT 3.7Vdc	
MODULATION TYPE	CAT-M1 / NB-IOT: LTE	BPSK, QPSK, 16QAM
FREQUENCY RANGE CAT-M1	LTE Band 5 (Channel Bandwidth: 1.4MHz)	824.7MHz ~ 848.3MHz
	LTE Band 5 (Channel Bandwidth: 3MHz)	825.5MHz ~ 847.5MHz
	LTE Band 5 (Channel Bandwidth: 5MHz)	826.5MHz ~ 846.5MHz
	LTE Band 5 (Channel Bandwidth: 10MHz)	829MHz ~ 844MHz
	LTE Band 26 (Channel Bandwidth: 1.4MHz)	824.7MHz ~ 848.3MHz
	LTE Band 26 (Channel Bandwidth: 3MHz)	825.5MHz ~ 847.5MHz
	LTE Band 26 (Channel Bandwidth: 5MHz)	826.5MHz ~ 846.5MHz
	LTE Band 26 (Channel Bandwidth: 10MHz)	829MHz ~ 844MHz
	LTE Band 26 (Channel Bandwidth: 15MHz)	831.5MHz ~ 841.5MHz
FREQUENCY RANGE NB-IOT	LTE Band 5 (Sub-carrier Spacing: 3.75/15KHz)	824.1MHz ~ 848.9MHz
	LTE Band 26 (Sub-carrier Spacing: 3.75/15KHz)	824.2MHz ~ 848.8MHz
MAX. ERP POWER CAT-M1	LTE Band 5 (Channel Bandwidth: 1.4MHz)	468.81mW
	LTE Band 5 (Channel Bandwidth: 3MHz)	474.24mW
	LTE Band 5 (Channel Bandwidth: 5MHz)	476.43mW
	LTE Band 5 (Channel Bandwidth: 10MHz)	478.63mW
	LTE Band 26 (Channel Bandwidth: 1.4MHz)	492.04mW
	LTE Band 26 (Channel Bandwidth: 3MHz)	488.65mW
	LTE Band 26 (Channel Bandwidth: 5MHz)	488.65mW



	LTE Band 26 (Channel Bandwidth: 10MHz)	481.95mW
	LTE Band 26 (Channel Bandwidth: 15MHz)	493.17mW
MAX. ERP POWER NB-IOT	LTE Band 5 (Sub-carrier Spacing: 3.75KHz)	494.31mW
	LTE Band 5 (Sub-carrier Spacing: 15KHz)	489.78mW
	LTE Band 26 (Sub-carrier Spacing: 3.75KHz)	481.95mW
	LTE Band 26 (Sub-carrier Spacing: 15KHz)	490.91mW
EMISSION DESIGNATOR GOGN CAT-M1	LTE Band 26 (Channel Bandwidth: 1.4MHz)	QPSK: 1M10G7D
		16QAM:950KD7D
EMISSION DESIGNATOR GOGN NB-IOT	LTE Band 26 (Sub-carrier Spacing: 15KHz)	BPSK: 126KG7D
		QPSK: 188KG7D
ANTENNA TYPE*	FR4 Embedded LTE Antenna with 7.1dBi gain for LTE B5/ LTE B26	
HW VERSION*	nRF9151 LACA AA	
SW VERSION*	mfw_nRF91x1_2.0.1	
I/O PORTS*	Refer to user's manual	
CABLE SUPPLIED*	N/A	
EXTREME TEMPERATURE*	-40-85 °C	
EXTREME VOLTAGE*	3.0V - 5.5V	

NOTE:

- *Since the above data and/or information is provided by the client relevant results or conclusions of this report are only made for these data and/or information, Test Lab is not responsible for the authenticity, integrity and results of the data and information and/or the validity of the conclusion.
- For a more detailed features description, please refer to the manufacturer's specifications or the user's manual.
- The EUT incorporates a SISO function. Physically, the EUT provides one completed transmitter and one receiver.

MODULATION MODE	TX FUNCTION
LTE	1TX/1RX

- For the test results, the EUT had been tested with all conditions. But only the worst case was shown in the test report.



2.2 CONFIGURATION OF SYSTEM UNDER TEST FOR RADIATION EMISSION

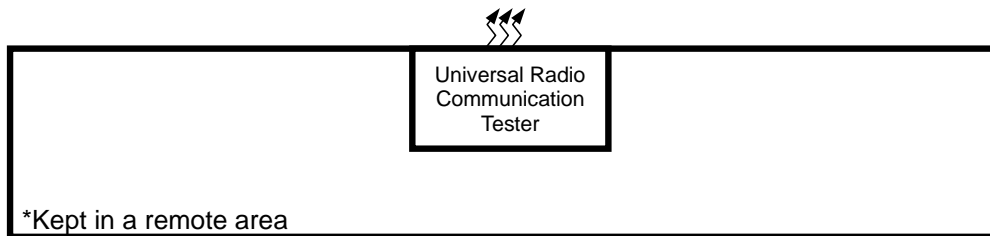
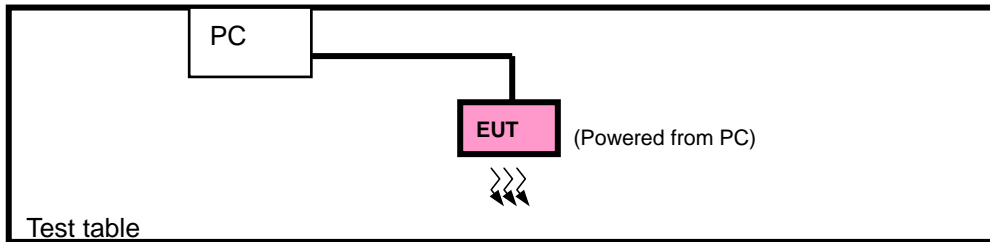



2.3 DESCRIPTION OF SUPPORT UNITS

The EUT has been tested as an independent unit together with other necessary accessories or support units. The following support units or accessories were used to form a representative test configuration during the tests.

NO.	PRODUCT	BRAND	MODEL NO.	SERIAL NO.	FCC ID
1	Laptop	Lenovo	ThinkPad E14	HRSW00024	N/A
2	USB Cable	RF Murata cable for Cellular IoT	MXHS83QE3000	N/A	N/A

NO.	SIGNAL CABLE DESCRIPTION OF THE ABOVE SUPPORT UNITS
1	N/A

2.4 TEST ITEM AND TEST CONFIGURATION

Pre-Scan has been conducted to determine the worst-case mode from all possible combinations between available modulations, data rates, XYZ axis and antenna ports. The worst case in ERP and radiated emission was found when positioned on X-plane for GSM /EDGE /LTE. Following channel(s) was (were) selected for the final test as listed below:

EUT CONFIGURE MODE	DESCRIPTION
A	EUT +USB cable with LTE link



LTE BAND 5 MODE

EUT CONFIGURE MODE	TEST ITEM	Available Channel	Tested Channel	Channel bandwidth/ Sub-carrier Spacing	modulation	mode
CAT-M1	ERP	20407 to 20643	20407, 20525, 20643	1.4MHz	QPSK,16QAM	1 RB / 0 RB Offset
		20415 to 20635	20415, 20525, 20635	3MHz	QPSK,16QAM	1 RB / 0 RB Offset
		20425 to 20625	20425, 20525, 20625	5MHz	QPSK,16QAM	1 RB / 0 RB Offset
		20450 to 20600	20450, 20525, 20600	10MHz	QPSK,16QAM	1 RB / 0 RB Offset
NB-IOT	ERP	20401 to 20649	20401, 20525, 20649	3.75KHz	BPSK,QPSK	1 RB / 0 RB Offset
		20401 to 20649	20401, 20525, 20649	15KHz	BPSK,QPSK	1 RB / 0 RB Offset

Note: 1. This device was tested under all bandwidths, RB configurations and modulations. The worst case was found in QPSK modulation.

2. LTE Band 5 are covered by LTE Band 26, Because it is a subset of LTE Band 26 with the same output power and supported bandwidths, So the test data please refer to LTE Band 26

CAT-M1 LTE BAND 26 MODE

EUT CONFIGURE MODE	TEST ITEM	Available Channel	Tested Channel	Channel bandwidth	modulation	mode
A	ERP	26797 to 27033	26797, 26915, 27033	1.4MHz	QPSK,16QAM	1 RB / 0 RB Offset
		26805 to 27025	26805, 26915, 27025	3MHz	QPSK,16QAM	1 RB / 0 RB Offset
		26815 to 27015	26815, 26915, 27015	5MHz	QPSK,16QAM	1 RB / 0 RB Offset
		26840 to 26990	26840, 26915, 26990	10MHz	QPSK,16QAM	1 RB / 0 RB Offset
		26865 to 26965	26865, 26915, 26965	15MHz	QPSK,16QAM	1 RB / 0 RB Offset
A	RADIATED EMISSION	26797 to 27033	26797, 26915, 27033	1.4MHz	QPSK	1 RB / 0 RB Offset
		26805 to 27025	26915	3MHz	QPSK	1 RB / 0 RB Offset
		26815 to 27015	26915	5MHz	QPSK	1 RB / 0 RB Offset
		26840 to 26990	26915	10MHz	QPSK	1 RB / 0 RB Offset
		26865 to 26965	26915	15MHz	QPSK	1 RB / 0 RB Offset

Note: This device was tested under all bandwidths, RB configurations and modulations. The worst case was found in QPSK modulation.



NB-IOT LTE BAND 26 MODE

EUT CONFIGURE MODE	TEST ITEM	AVAILABLE CHANNEL	TESTED CHANNEL	MODULATION	MODE
A	ERP	26792 to 27038	26792,26915,27038	BPSK,QPSK	1 RB / 0 RB Offset
A	RADIATED EMISSION	26792 to 27038	26792,26915,27038	QPSK	1 RB / 0 RB Offset

Note: This device was tested under all bandwidths, RB configurations and modulations. The worst case was found in QPSK modulation.



TEST CONDITION:

TEST ITEM	ENVIRONMENTAL CONDITIONS	INPUT POWER	TESTED BY
ERP	23deg. C, 70%RH	DC 3.7V By PC	Hanwen Xu
RADIATED EMISSION	23deg. C, 70%RH	DC 3.7V By PC	Hanwen Xu

2.5 EUT OPERATING CONDITIONS

The EUT makes a call to the communication simulator. The communication simulator station system controlled a EUT to export maximum output power under transmission mode and specific channel frequency.



2.6 GENERAL DESCRIPTION OF APPLIED STANDARDS

The EUT is a RF product. According to the specifications of the manufacturer, it must comply with the requirements of the following standards:

FCC 47 CFR Part 2

FCC 47 CFR Part 22

KDB 971168 D01 Power Meas License Digital Systems v03r01

ANSI/TIA/EIA-603-D

ANSI/TIA/EIA-603-E

ANSI C63.26-2015

NOTE: All test items have been performed and recorded as per the above standards.

3 TEST TYPES AND RESULTS

3.1 OUTPUT POWER MEASUREMENT

3.1.1 LIMITS OF OUTPUT POWER MEASUREMENT

Mobile / Portable station are limited to 7 watts e.r.p.

3.1.2 TEST PROCEDURES

EIRP / ERP MEASUREMENT:

Per KDB 971168 D01 Power Meas License Digital Systems v03r01 or subclause 5.2.5.5 of ANSI C63.26-2015, the relevant equation for determining the ERP or EIRP from the conducted RF output power measured using the guidance provided above is:

$$\text{ERP or EIRP} = P_{\text{Meas}} + G_{\text{T}} - L_{\text{C}}$$

Where:

ERP or EIRP = effective radiated power or equivalent isotropically radiated power, respectively

(expressed in the same units as P_{Meas} , typically dBW or dBm);

P_{Meas} = measured transmitter output power or PSD, in dBm or dBW;

G_{T} = gain of the transmitting antenna, in dBd (ERP) or dBi (EIRP);

L_{C} = signal attenuation in the connecting cable between the transmitter and antenna, in dB.

CONDUCTED POWER MEASUREMENT:

The EUT was set up for the maximum power with WCDMA link data modulation and link up with simulator. Set the EUT to transmit under low, middle and high channel and record the power level shown on simulator.



3.1.3 TEST SETUP

EIRP / ERP Measurement:

CONDUCTED POWER MEASUREMENT:

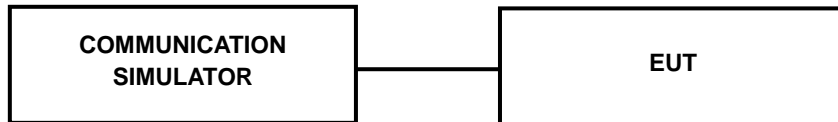

3.1.4 TEST RESULTS

CONDUCTED OUTPUT POWER (dBm):

CAT-M1

LTE Band 5

Band/BW	Modulation	RB Size	RB Offset	Low CH 20407	Mid CH 20525	High CH 20643
				Frequency 824.7 MHz	Frequency 836.5 MHz	Frequency 848.3 MHz
5/ 1.4	QPSK	1	0	19.35	19.29	19.25
		1	5	19.39	19.32	19.15
		3	0	19.43	19.51	19.37
		3	3	19.39	19.34	19.33
		6	0	19.06	19.02	19.05
	16QAM	1	0	19.61	19.55	19.58
		1	5	19.61	19.50	19.55
		3	0	19.54	19.32	19.40
		3	3	19.58	19.42	19.37
		6	0	19.45	19.41	19.35



Band/BW	Modulation	RB Size	RB Offset	Low CH 20415	Mid CH 20525	High CH 20635
				Frequency 825.5 MHz	Frequency 836.5 MHz	Frequency 847.5 MHz
5/3	QPSK	1	0	19.39	19.28	19.28
		1	5	19.36	19.39	19.12
		3	0	19.37	19.49	19.47
		3	3	19.51	19.37	19.37
		6	0	19.00	19.12	19.13
	16QAM	1	0	19.65	19.66	19.59
		1	5	19.64	19.60	19.59
		3	0	19.48	19.36	19.43
		3	3	19.62	19.37	19.40
		6	0	19.50	19.39	19.26

Band/BW	Modulation	RB Size	RB Offset	Low CH 20425	Mid CH 20525	High CH 20625
				Frequency 826.5 MHz	Frequency 836.5 MHz	Frequency 846.5 MHz
5/5	QPSK	1	0	19.29	19.29	19.20
		1	5	19.28	19.30	19.19
		3	0	19.44	19.42	19.49
		3	3	19.45	19.30	19.33
		6	0	19.09	19.13	19.03
	16QAM	1	0	19.51	19.58	19.50
		1	5	19.68	19.53	19.58
		3	0	19.54	19.35	19.48
		3	3	19.54	19.46	19.45
		6	0	19.48	19.34	19.37



Band/BW	Modulation	RB Size	RB Offset	Low CH 20450	Mid CH 20525	High CH 20600
				Frequency 829 MHz	Frequency 836.5 MHz	Frequency 844 MHz
5/ 10	QPSK	1	0	19.44	19.35	19.34
		1	5	19.42	19.41	19.26
		3	0	19.51	19.52	19.50
		3	3	19.53	19.40	19.41
		6	0	19.13	19.15	19.14
	16QAM	1	0	19.66	19.67	19.64
		1	5	19.70	19.65	19.63
		3	0	19.63	19.47	19.51
		3	3	19.67	19.49	19.49
		6	0	19.57	19.46	19.40

LTE BAND 26

Band/BW	Modulation	RB Size	RB Offset	Low CH 26797	Mid CH 26915	High CH 27033
				Frequency 824.7 MHz	Frequency 836.5 MHz	Frequency 848.3 MHz
26/ 1.4	QPSK	1	0	19.49	19.54	19.42
		1	5	19.40	19.40	19.54
		3	0	19.40	19.53	19.58
		3	3	19.51	19.47	19.43
		6	0	19.54	19.52	19.44
	16QAM	1	0	19.65	19.74	19.60
		1	5	19.76	19.82	19.63
		3	0	19.46	19.47	19.46
		3	3	19.67	19.69	19.46
		6	0	19.60	19.64	19.65



Band/BW	Modulation	RB Size	RB Offset	Low CH 26805	Mid CH 26915	High CH 27025
				Frequency 825.5 MHz	Frequency 836.5 MHz	Frequency 847.5 MHz
26/ 3	QPSK	1	0	19.55	19.57	19.38
		1	5	19.47	19.42	19.54
		3	0	19.54	19.45	19.54
		3	3	19.50	19.46	19.52
		6	0	19.51	19.47	19.46
	16QAM	1	0	19.75	19.73	19.70
		1	5	19.79	19.71	19.65
		3	0	19.58	19.50	19.48
		3	3	19.60	19.64	19.56
		6	0	19.66	19.73	19.56

Band/BW	Modulation	RB Size	RB Offset	Low CH 26815	Mid CH 26915	High CH 27015
				Frequency 826.5 MHz	Frequency 836.5 MHz	Frequency 846.5 MHz
26/ 5	QPSK	1	0	19.47	19.46	19.46
		1	5	19.39	19.48	19.44
		3	0	19.54	19.47	19.48
		3	3	19.55	19.46	19.42
		6	0	19.48	19.43	19.51
	16QAM	1	0	19.68	19.69	19.63
		1	5	19.79	19.70	19.66
		3	0	19.54	19.46	19.49
		3	3	19.63	19.58	19.46
		6	0	19.60	19.62	19.66



Band/BW	Modulation	RB Size	RB Offset	Low CH 26840	Mid CH 26915	High CH 26990
				Frequency 829 MHz	Frequency 836.5 MHz	Frequency 844 MHz
26/10	QPSK	1	0	19.52	19.55	19.38
		1	5	19.39	19.46	19.42
		3	0	19.46	19.40	19.53
		3	3	19.46	19.59	19.49
		6	0	19.43	19.52	19.48
	16QAM	1	0	19.69	19.73	19.57
		1	5	19.71	19.72	19.72
		3	0	19.47	19.58	19.50
		3	3	19.67	19.71	19.50
		6	0	19.70	19.72	19.57

Band/BW	Modulation	RB Size	RB Offset	Low CH 26865	Mid CH 26915	High CH 26965
				Frequency 831.5 MHz	Frequency 836.5 MHz	Frequency 841.5 MHz
26/ 15	QPSK	1	0	19.61	19.46	19.50
		1	5	19.51	19.43	19.55
		3	0	19.55	19.44	19.60
		3	3	19.60	19.58	19.56
		6	0	19.56	19.43	19.59
	16QAM	1	0	19.76	19.74	19.72
		1	5	19.83	19.79	19.76
		3	0	19.61	19.47	19.58
		3	3	19.72	19.69	19.57
		6	0	19.74	19.73	19.70



NB-IOT

LTE Band 5						
Sub-carrier Spacing (KHz)	Modulation	RB Size	RB Offset	Low	Mid	High
		Channel		20401	20525	20649
		Frequency (MHz)		824.1	836.5	848.9
3.75	BPSK	1	0	19.82	19.76	19.68
		1	47	19.79	19.67	19.58
	QPSK	1	0	19.84	19.76	19.55
		1	47	19.78	19.70	19.60
12	BPSK	1	0	19.80	19.70	19.51
		1	11	19.78	19.69	19.49
	QPSK	1	0	19.79	19.71	19.48
		1	11	19.77	19.69	19.50
		12	0	17.66	17.57	17.43

LTE Band 26						
Sub-carrier Spacing (KHz)	Modulation	RB Size	RB Offset	Low	Mid	High
		Channel		26792	26915	27038
		Frequency (MHz)		824.2	836.5	848.8
3.75	BPSK	1	0	19.73	19.69	19.70
		1	47	19.69	19.73	19.60
	QPSK	1	0	19.72	19.73	19.71
		1	47	19.66	19.63	19.63
12	BPSK	1	0	19.65	19.75	19.81
		1	11	19.60	19.57	19.61
	QPSK	1	0	19.59	19.55	19.62
		1	11	19.62	19.56	19.60
		12	0	17.50	17.53	17.48



ERP POWER (dBm)

CAT-M1

LTE BAND 5

CHANNEL BANDWIDTH: 1.4MHz QPSK

Channel	Frequency (MHz)	Conducted Power (dBm)	G _T -L _C (dB)	ERP (dBm)	ERP (mW)	Limit (W)
20407	824.7	19.43	7.1	26.53	449.78	7
20525	836.5	19.51	7.1	26.61	458.14	7
20643	848.3	19.37	7.1	26.47	443.61	7

CHANNEL BANDWIDTH: 1.4MHz 16QAM

Channel	Frequency (MHz)	Conducted Power (dBm)	G _T -L _C (dB)	ERP (dBm)	ERP (mW)	Limit (W)
20407	824.7	19.61	7.1	26.71	468.81	7
20525	836.5	19.55	7.1	26.65	462.38	7
20643	848.3	19.58	7.1	26.68	465.59	7

CHANNEL BANDWIDTH: 3MHz QPSK

Channel	Frequency (MHz)	Conducted Power (dBm)	G _T -L _C (dB)	ERP (dBm)	ERP (mW)	Limit (W)
20415	825.5	19.51	7.1	26.61	458.14	7
20525	836.5	19.49	7.1	26.59	456.04	7
20635	847.5	19.47	7.1	26.57	453.94	7

CHANNEL BANDWIDTH: 3MHz 16QAM

Channel	Frequency (MHz)	Conducted Power (dBm)	G _T -L _C (dB)	ERP (dBm)	ERP (mW)	Limit (W)
20415	825.5	19.65	7.1	26.75	473.15	7
20525	836.5	19.66	7.1	26.76	474.24	7
20635	847.5	19.59	7.1	26.69	466.66	7



CHANNEL BANDWIDTH: 5MHz QPSK

Channel	Frequency (MHz)	Conducted Power (dBm)	G _T -L _C (dB)	ERP (dBm)	ERP (mW)	Limit (W)
20425	826.5	19.45	7.1	26.55	451.86	7
20525	836.5	19.42	7.1	26.52	448.75	7
20625	846.5	19.49	7.1	26.59	456.04	7

CHANNEL BANDWIDTH: 5MHz 16QAM

Channel	Frequency (MHz)	Conducted Power (dBm)	G _T -L _C (dB)	ERP (dBm)	ERP (mW)	Limit (W)
20425	826.5	19.68	7.1	26.78	476.43	7
20525	836.5	19.58	7.1	26.68	465.59	7
20625	846.5	19.58	7.1	26.68	465.59	7

CHANNEL BANDWIDTH: 10MHz QPSK

Channel	Frequency (MHz)	Conducted Power (dBm)	G _T -L _C (dB)	ERP (dBm)	ERP (mW)	Limit (W)
20450	829	19.53	7.1	26.63	460.26	7
20525	836.5	19.52	7.1	26.62	459.2	7
20600	844	19.5	7.1	26.6	457.09	7

CHANNEL BANDWIDTH: 10MHz 16QAM

Channel	Frequency (MHz)	Conducted Power (dBm)	G _T -L _C (dB)	ERP (dBm)	ERP (mW)	Limit (W)
20450	829	19.7	7.1	26.8	478.63	7
20525	836.5	19.67	7.1	26.77	475.34	7
20600	844	19.64	7.1	26.74	472.06	7

REMARKS: ERP Output Power (dBm) = EIRP (dBm) -2.15(dB).



LTE BAND 26

CHANNEL BANDWIDTH: 1.4MHz QPSK

Channel	Frequency (MHz)	Conducted Power (dBm)	G _T -L _C (dB)	ERP (dBm)	ERP (mW)	Limit (W)
26797	824.7	19.54	7.1	26.64	461.32	7
26915	836.5	19.54	7.1	26.64	461.32	7
27033	848.3	19.58	7.1	26.68	465.59	7

CHANNEL BANDWIDTH: 1.4MHz 16QAM

Channel	Frequency (MHz)	Conducted Power (dBm)	G _T -L _C (dB)	ERP (dBm)	ERP (mW)	Limit (W)
26797	824.7	19.76	7.1	26.86	485.29	7
26915	836.5	19.82	7.1	26.92	492.04	7
27033	848.3	19.65	7.1	26.75	473.15	7

CHANNEL BANDWIDTH: 3MHz QPSK

Channel	Frequency (MHz)	Conducted Power (dBm)	G _T -L _C (dB)	ERP (dBm)	ERP (mW)	Limit (W)
26805	825.5	19.55	7.1	26.65	462.38	7
26915	836.5	19.57	7.1	26.67	464.52	7
27025	847.5	19.54	7.1	26.64	461.32	7

CHANNEL BANDWIDTH: 3MHz 16QAM

Channel	Frequency (MHz)	Conducted Power (dBm)	G _T -L _C (dB)	ERP (dBm)	ERP (mW)	Limit (W)
26805	825.5	19.79	7.1	26.89	488.65	7
26915	836.5	19.73	7.1	26.83	481.95	7
27025	847.5	19.7	7.1	26.8	478.63	7



CHANNEL BANDWIDTH: 5MHz QPSK

Channel	Frequency (MHz)	Conducted Power (dBm)	G _T -L _C (dB)	ERP (dBm)	ERP (mW)	Limit (W)
26815	826.5	19.55	7.1	26.65	462.38	7
26915	836.5	19.48	7.1	26.58	454.99	7
27015	846.5	19.51	7.1	26.61	458.14	7

CHANNEL BANDWIDTH: 5MHz 16QAM

Channel	Frequency (MHz)	Conducted Power (dBm)	G _T -L _C (dB)	ERP (dBm)	ERP (mW)	Limit (W)
26815	826.5	19.79	7.1	26.89	488.65	7
26915	836.5	19.7	7.1	26.8	478.63	7
27015	846.5	19.66	7.1	26.76	474.24	7

CHANNEL BANDWIDTH: 10MHz QPSK

Channel	Frequency (MHz)	Conducted Power (dBm)	G _T -L _C (dB)	ERP (dBm)	ERP (mW)	Limit (W)
26840	829	19.52	7.1	26.62	459.2	7
26915	836.5	19.59	7.1	26.69	466.66	7
26990	844	19.53	7.1	26.63	460.26	7

CHANNEL BANDWIDTH: 10MHz 16QAM

Channel	Frequency (MHz)	Conducted Power (dBm)	G _T -L _C (dB)	ERP (dBm)	ERP (mW)	Limit (W)
26840	829	19.71	7.1	26.81	479.73	7
26915	836.5	19.73	7.1	26.83	481.95	7
26990	844	19.72	7.1	26.82	480.84	7



CHANNEL BANDWIDTH: 15MHz QPSK

Channel	Frequency (MHz)	Conducted Power (dBm)	G _{T-LC} (dB)	ERP (dBm)	ERP (mW)	Limit (W)
26865	831.5	19.61	7.1	26.71	468.81	7
26915	836.5	19.58	7.1	26.68	465.59	7
26965	841.5	19.6	7.1	26.7	467.74	7

CHANNEL BANDWIDTH: 15MHz 16QAM

Channel	Frequency (MHz)	Conducted Power (dBm)	G _{T-LC} (dB)	ERP (dBm)	ERP (mW)	Limit (W)
26865	831.5	19.83	7.1	26.93	493.17	7
26915	836.5	19.79	7.1	26.89	488.65	7
26965	841.5	19.76	7.1	26.86	485.29	7

REMARKS: ERP Output Power (dBm) = EIRP (dBm) -2.15(dB).



NB-IOT

LTE B5 3.75KHz

CHANNEL BANDWIDTH: BPSK

Channel	Frequency (MHz)	Conducted Power (dBm)	G _T -L _C (dB)	ERP (dBm)	ERP (mW)	Limit (W)
20401	824.1	19.82	7.1	26.92	492.04	7
20525	836.5	19.76	7.1	26.86	485.29	7
20649	848.9	19.68	7.1	26.78	476.43	7

CHANNEL BANDWIDTH: QPSK

Channel	Frequency (MHz)	Conducted Power (dBm)	G _T -L _C (dB)	ERP (dBm)	ERP (mW)	Limit (W)
20401	824.1	19.84	7.1	26.94	494.31	7
20525	836.5	19.76	7.1	26.86	485.29	7
20649	848.9	19.6	7.1	26.7	467.74	7

LTE B5 15KHz

CHANNEL BANDWIDTH: BPSK

Channel	Frequency (MHz)	Conducted Power (dBm)	G _T -L _C (dB)	ERP (dBm)	ERP (mW)	Limit (W)
20401	824.1	19.8	7.1	26.9	489.78	7
20525	836.5	19.7	7.1	26.8	478.63	7
20649	848.9	19.51	7.1	26.61	458.14	7

CHANNEL BANDWIDTH: QPSK

Channel	Frequency (MHz)	Conducted Power (dBm)	G _T -L _C (dB)	ERP (dBm)	ERP (mW)	Limit (W)
20401	824.1	19.79	7.1	26.89	488.65	7
20525	836.5	19.71	7.1	26.81	479.73	7
20649	848.9	19.5	7.1	26.6	457.09	7

REMARKS: ERP Output Power (dBm) = EIRP (dBm) -2.15(dB).



NB-IOT

LTE B26 3.75KHz

CHANNEL BANDWIDTH: BPSK

Channel	Frequency (MHz)	Conducted Power (dBm)	G _{T-Lc} (dB)	ERP (dBm)	ERP (mW)	Limit (W)
26792	824.2	19.73	7.1	26.83	481.95	7
26915	836.5	19.73	7.1	26.83	481.95	7
27038	848.8	19.7	7.1	26.8	478.63	7

CHANNEL BANDWIDTH: QPSK

Channel	Frequency (MHz)	Conducted Power (dBm)	G _{T-Lc} (dB)	ERP (dBm)	ERP (mW)	Limit (W)
26792	824.2	19.72	7.1	26.82	480.84	7
26915	836.5	19.73	7.1	26.83	481.95	7
27038	848.8	19.71	7.1	26.81	479.73	7

LTE B26 15KHz

CHANNEL BANDWIDTH: BPSK

Channel	Frequency (MHz)	Conducted Power (dBm)	G _{T-Lc} (dB)	ERP (dBm)	ERP (mW)	Limit (W)
26792	824.2	19.65	7.1	26.75	473.15	7
26915	836.5	19.75	7.1	26.85	484.17	7
27038	848.8	19.81	7.1	26.91	490.91	7

CHANNEL BANDWIDTH: QPSK

Channel	Frequency (MHz)	Conducted Power (dBm)	G _{T-Lc} (dB)	ERP (dBm)	ERP (mW)	Limit (W)
26792	824.2	19.62	7.1	26.72	469.89	7
26915	836.5	19.56	7.1	26.66	463.45	7
27038	848.8	19.62	7.1	26.72	469.89	7

REMARKS: ERP Output Power (dBm) = EIRP (dBm) -2.15(dB).



3.2 FREQUENCY STABILITY MEASUREMENT

3.2.1 LIMITS OF FREQUENCY STABILITY MEASUREMENT

1.5 ppm is for base and fixed station. 2.5 ppm is for mobile station.

3.2.2 TEST PROCEDURE

- a. Device is placed at the oven room. The oven room could control the temperatures and humidity. Power warm up is at least 15 min and power applied should perform before recording frequency error.
- b. EUT is connected the external power supply to control the DC input power. The test voltage range is from minimum to maximum working voltage. Each step shall be record the frequency error rate.
- c. The temperature range step is 10 degrees in this test items. All temperature levels shall be hold the $\pm 0.5^{\circ}\text{C}$ during the measurement testing. The each temperature step shall be at least 0.5 hours, consider the EUT could be test under the stability condition.

NOTE: The frequency error was recorded frequency error from the communication simulator.

3.2.3 TEST SETUP

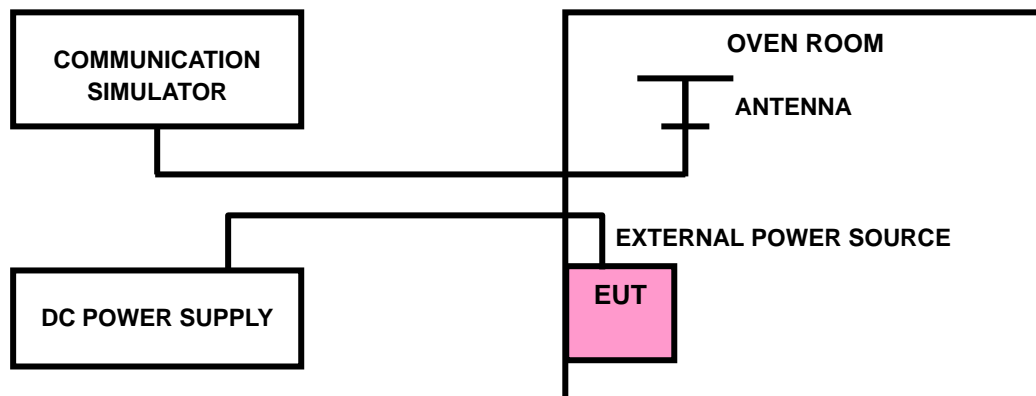



Test Report No.: PSU-QSU2404090210RF01

3.2.4 TEST RESULTS

Refer to the original source report (Report No.: 77535RRF.001, Model Name: nRF9151, FCC ID: 2ANPO0nRF9151).



3.3 OCCUPIED BANDWIDTH MEASUREMENT

3.3.1 LIMITS OF OCCUPIED BANDWIDTH MEASUREMENT

The width of a frequency band such that, below the lower and above the upper frequency limits, the mean powers emitted are each equal to a specified percentage 0.5 % of the total mean power of a given emission.

3.3.2 TEST SETUP

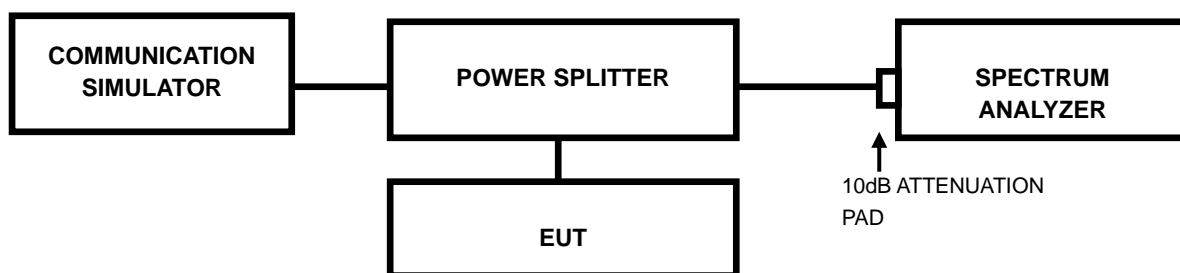

3.3.3 TEST PROCEDURES

- The conducted occupied bandwidth used the power splitter via EUT RF power connector between simulation base station and spectrum analyzer.
- Use OBW measurement function of Spectrum analyzer to measure 99 % occupied bandwidth.



Test Report No.: PSU-QSU2404090210RF01

3.3.4 TEST RESULTS

Refer to the original source report (Report No.: 77535RRF.001, Model Name: nRF9151, FCC ID: 2ANPO00nRF9151).

3.4 BAND EDGE MEASUREMENT

3.4.1 LIMITS OF BAND EDGE MEASUREMENT

Power of any emission outside of the authorized operating frequency ranges must be attenuated below the transmitting power (P) by a factor of at least $43 + 10 \log(P)$ dB. In the 1 MHz bands immediately outside and adjacent to the frequency block a resolution bandwidth of at least one percent of the emission bandwidth of the fundamental emission of the transmitter may be employed.

3.4.2 TEST SETUP

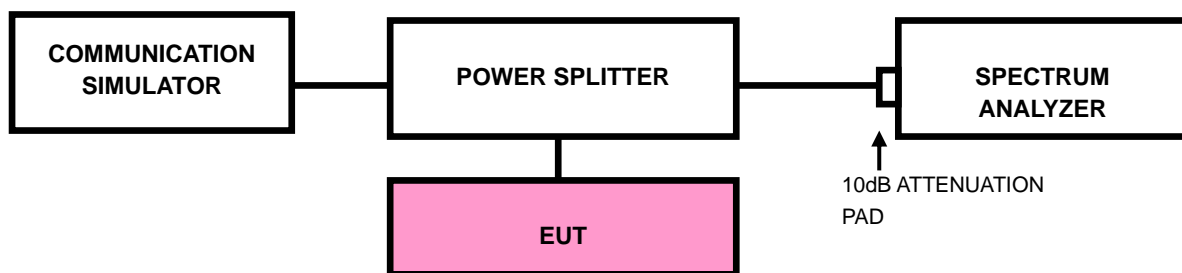



3.4.3 TEST PROCEDURES

- a) All measurements were done at low and high operational frequency range
- b) Connect the transmitter to the spectrum analyzer via coaxial cable while ensuring proper impedance matching.
- c) Tune the analyzer to the nominal center frequency of the emission bandwidth (EBW)
- d) .Set the resolution bandwidth (RBW) $\geq 1\%$ EBW in the 1MHz band immediately outside and adjacent to the band edge.
- e) Beyond the 1MHz band from the band edge, RBW=1MHz was used.
- f) Set the video bandwidth (VBW) to $\geq 3 \times$ RBW.
- g) Select the average power (RMS) display detector.
- h) Set the number of measurement points to ≥ 1001 .
- i) Use auto-coupled sweep time.
- j) Perform the measurement over an interval of time when the transmission is continuous and at its maximum power level.
- k) The RF fundamental frequency should be excluded against the limit line in the operating frequency band and use RBW is 10KHz or 100KHz.
- l) Record the max trace plot into the test report.



BUREAU
VERITAS

Test Report No.: PSU-QSU2404090210RF01

3.4.4 TEST RESULTS

Refer to the original source report (Report No.: 77535RRF.001, Model Name: nRF9151, FCC ID: 2ANPO00nRF9151).



3.5 CONDUCTED SPURIOUS EMISSIONS

3.5.1 LIMITS OF CONDUCTED SPURIOUS EMISSIONS MEASUREMENT

The power of any emission outside of the authorized operating frequency ranges must be attenuated below the transmitting power (P) by a factor of at least $43 + 10 \log(P)$ dB. The emission limit equal to -13dBm .

3.5.2 TEST PROCEDURE

- a. The EUT makes a phone call to the communication simulator. All measurements were done at low, middle and high operational frequency range.
- b. Measuring frequency range is from 9kHz up to a frequency including its 10th harmonic. 10dB attenuation pad is connected with spectrum. RBW=1MHz and VBW=3MHz is used for conducted emission measurement.

3.5.3 TEST SETUP

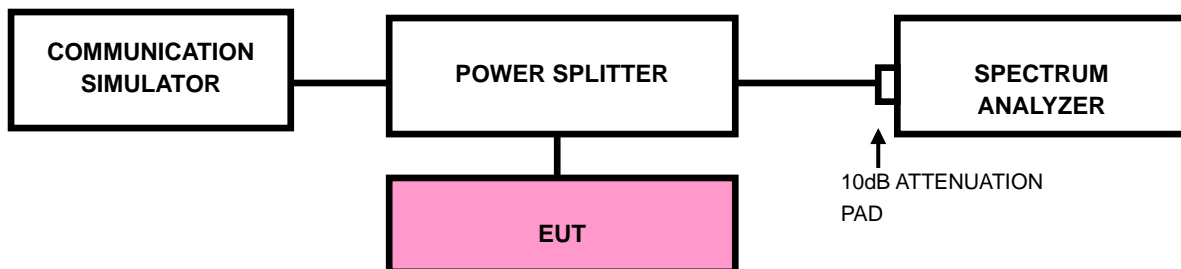



**BUREAU
VERITAS**

Test Report No.: PSU-QSU2404090210RF01

3.5.4 TEST RESULTS

NOTE : The 9K~30MHz amplitude of spurious emissions attenuated more than 20 dB below the permissible value is not required in the report.

Refer to the original source report (Report No.: 77535RRF.001, Model Name: nRF9151, FCC ID: 2ANPO00nRF9151).



3.6 RADIATED EMISSION MEASUREMENT

3.6.1 LIMITS OF RADIATED EMISSION MEASUREMENT

The power of any emission outside of the authorized operating frequency ranges must be attenuated below the transmitting power (P) by a factor of at least $43 + 10 \log(P)$ dB. The emission limit equal to -13dBm .

3.6.2 TEST PROCEDURES

- a. Substitution method is used for E.I.R.P measurement. In the semi-anechoic chamber, EUT placed on the 0.8m height of Turn Table, rotated the table around 360 degrees to search the maximum radiation power and receiver antenna shall be rotated vertical and horizontal polarization and moved height from 1m to 4m to find the maximum polar radiated power. The "Read Value" is the spectrum reading the maximum power value.
- b. The substitution horn antenna is substituted for EUT at the same position and signals generator export the CW signal to the substitution antenna via a TX cable. Rotated the Turn Table and moved receiving antenna to find the maximum radiation power. Adjust output power level of S.G to get a Value of spectrum reading equal to "Read Value " of step a. Record the power level of S.G
- c. $\text{EIRP} = \text{Output power level of S.G} - \text{TX cable loss} + \text{Antenna gain of substitution horn.}$
- d. E.R.P power can be calculated form E.I.R.P power by subtracting the gain of dipole,
 $\text{E.R.P power} = \text{E.I.P.R power} - 2.15\text{dBi.}$

NOTE: The resolution bandwidth and video bandwidth of test receiver/spectrum analyzer is 1MHz/3MHz.

3.6.3 DEVIATION FROM TEST STANDARD

No deviation



3.6.4 TEST SETUP

< Frequency Range below 30MHz >

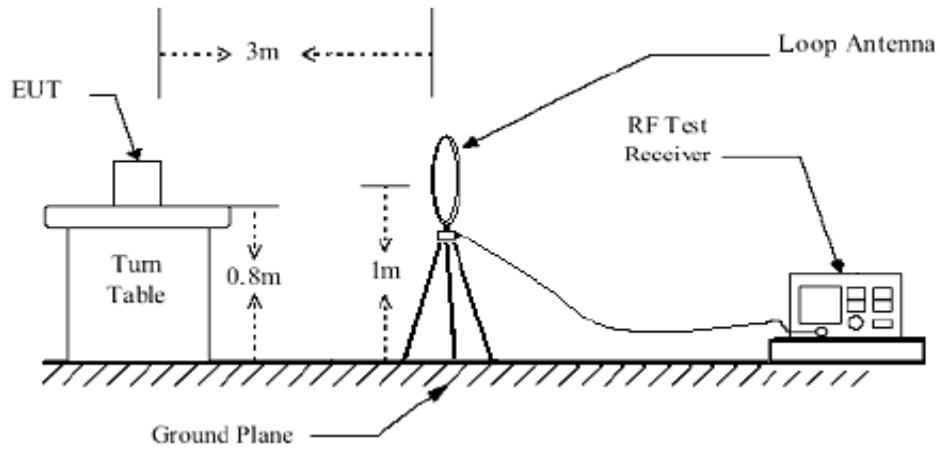

< Frequency Range 30MHz~1GHz >

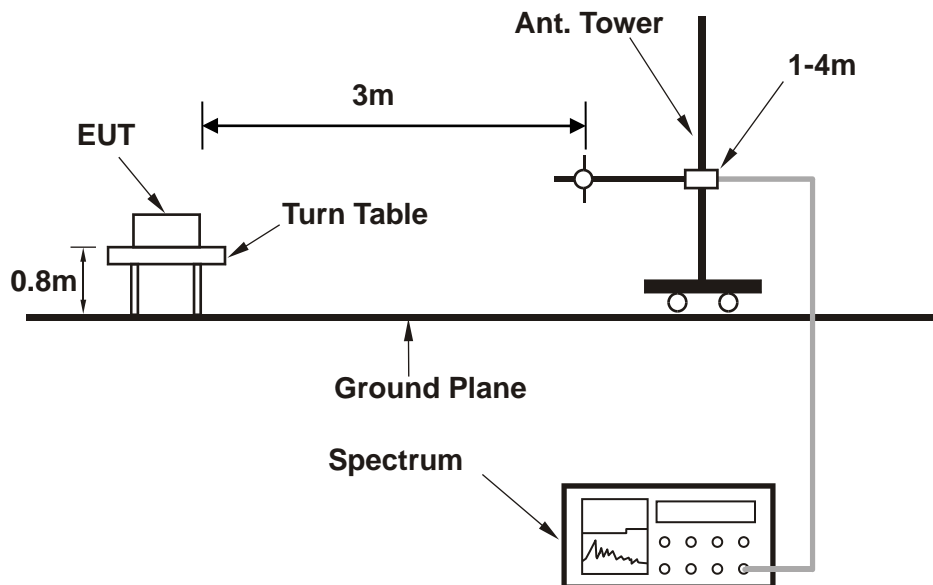



<Frequency Range above 1GHz>

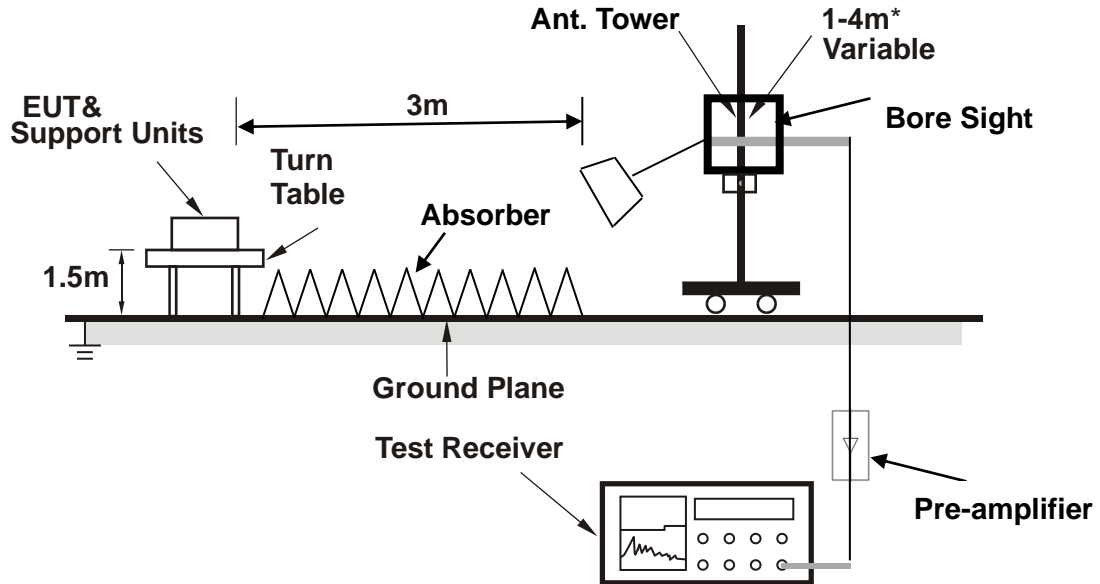

Note: Above 1G is a directional antenna

Depends on the EUT height and the antenna 3dB beamwidth both, refer to section 7.3 of CISPR 16-2-3.

For the actual test configuration, please refer to the attached file (Test Setup Photo).



3.6.5 TEST RESULTS

NOTE : The 9K~30MHz amplitude of spurious emissions attenuated more than 20 dB below the permissible value is not required in the report.

BELOW 1GHz WORST-CASE DATA

30 MHz – 1GHz data:

CAT-M1 LTE Band 26 :

CHANNEL BANDWIDTH: QPSK

MODE	TX channel 27033	FREQUENCY RANGE	Below 1000MHz
ENVIRONMENTAL CONDITIONS	23deg. C, 70%RH	INPUT POWER	120Vac 60HZ
TESTED BY	Hanwen Xu		
ANTENNA POLARITY & TEST DISTANCE: HORIZONTAL AT 3 M			

Rg	Frequency [MHz]	PK+ Level [dBm]	PK+ Limit [dBm]	PK+ Margin [dB]	Correction [dB]	Polarization	Azimuth [deg]	Antenna Height [m]
1	43.450	-66.46	-13.00	53.46	3.66	H	0.9	2.00
1	63.250	-50.48	-13.00	37.48	1.87	H	0.9	2.00
1	99.400	-69.53	-13.00	56.53	0.65	H	0.9	2.00
1	157.200	-54.52	-13.00	41.52	-4.91	H	0.9	2.00
1	290.250	-55.45	-13.00	42.45	5.83	H	5.1	1.00
1	430.350	-65.18	-13.00	52.18	6.23	H	5.1	1.00

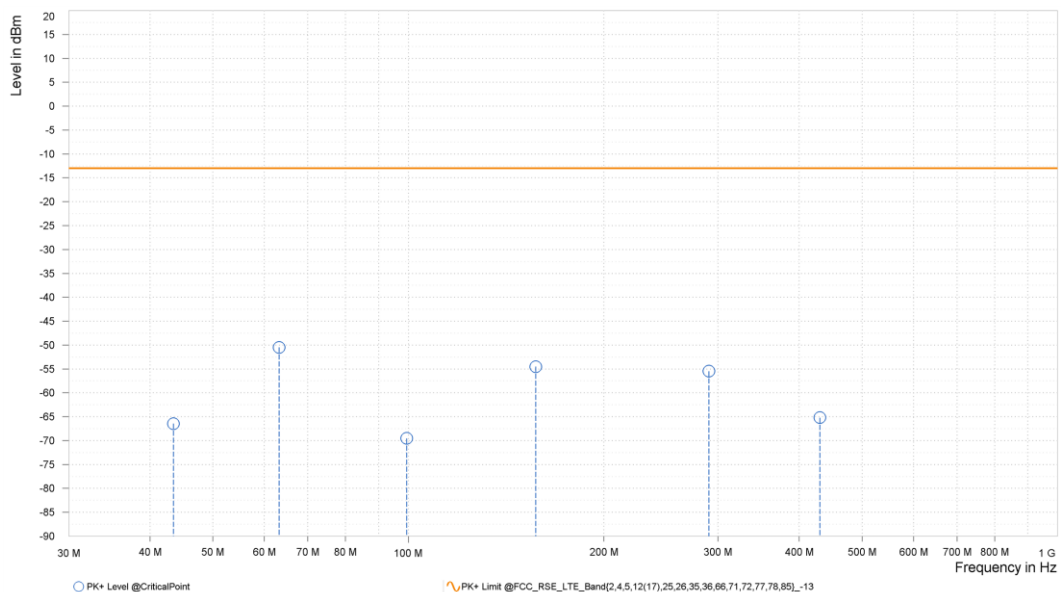



**BUREAU
VERITAS**

Test Report No.: PSU-QSU2404090210RF01

MODE	TX channel 27033	FREQUENCY RANGE	Below 1000MHz
ENVIRONMENTAL CONDITIONS	23deg. C, 70%RH	INPUT POWER	120Vac 60HZ
TESTED BY	Hanwen Xu		
ANTENNA POLARITY & TEST DISTANCE: VERTICAL AT 3 M			

Rg	Frequency [MHz]	PK+ Level [dBm]	PK+ Limit [dBm]	PK+ Margin [dB]	Correction [dB]	Polarization	Azimuth [deg]	Antenna Height [m]
1	38.750	-66.51	-13.00	53.51	2.79	V	5.1	1.00
1	63.150	-58.11	-13.00	45.11	0.13	V	197.9	2.00
1	102.450	-69.37	-13.00	56.37	2.68	V	147.8	1.00
1	157.200	-71.15	-13.00	58.15	-2.33	V	359	1.00
1	246.650	-70.59	-13.00	57.59	3.37	V	1	1.00
1	423.150	-67.08	-13.00	54.08	7.62	V	354.9	2.00

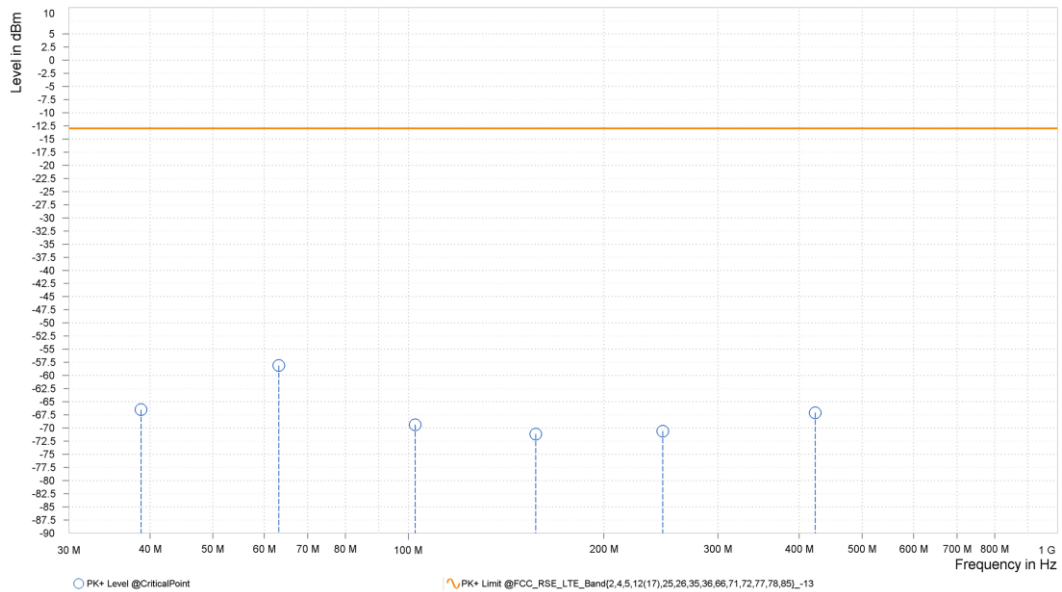



ABOVE 1GHz DATA

Note: For higher frequency, the emission is too low to be detected.

CAT-M1 LTE Band 26

CHANNEL BANDWIDTH: 1.4MHz / QPSK

CH26797

MODE	TX channel 26797	FREQUENCY RANGE	Above 1000MHz
ENVIRONMENTAL CONDITIONS	23deg. C, 70%RH	INPUT POWER	120Vac 60HZ
TESTED BY	Jace Hu		
ANTENNA POLARITY & TEST DISTANCE: HORIZONTAL AT 3 M			

Rg	Frequency [MHz]	PK+ Level [dBm]	PK+ Limit [dBm]	PK+ Margin [dB]	Correction [dB]	Polarization	Azimuth [deg]	Antenna Height [m]
1	1,648.000	-52.72	-13.00	39.72	6.93	H	2.9	2.00
1	2,472.210	-50.00	-13.00	37.00	12.42	H	2.9	2.00

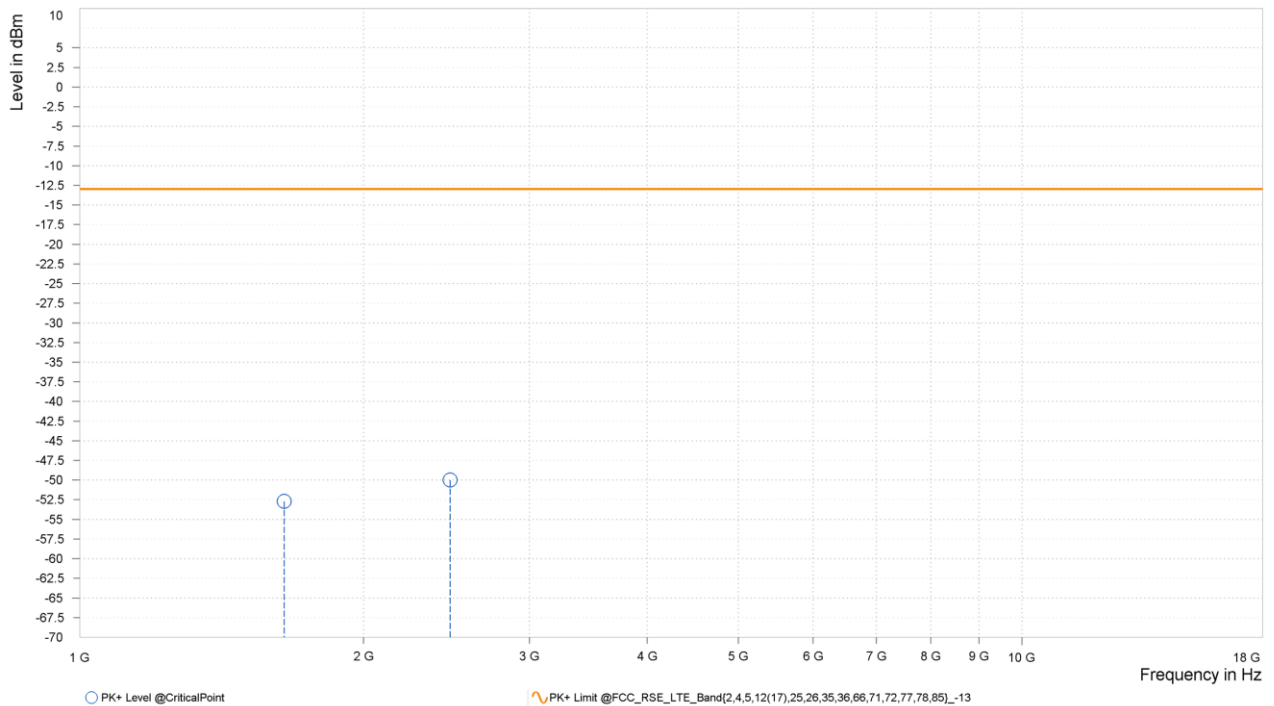



**BUREAU
VERITAS**

Test Report No.: PSU-QSU2404090210RF01

MODE	TX channel 267797	FREQUENCY RANGE	Above 1000MHz
ENVIRONMENTAL CONDITIONS	23deg. C, 70%RH	INPUT POWER	120Vac 60HZ
TESTED BY	Jace Hu		
ANTENNA POLARITY & TEST DISTANCE: VERTICAL AT 3 M			

Rg	Frequency [MHz]	PK+ Level [dBm]	PK+ Limit [dBm]	PK+ Margin [dB]	Correction [dB]	Polarization	Azimuth [deg]	Antenna Height [m]
1	1,648.140	-53.39	-13.00	40.39	6.41	V	138.2	2.00
1	2,473.000	-46.80	-13.00	33.80	12.11	V	5.8	1.00

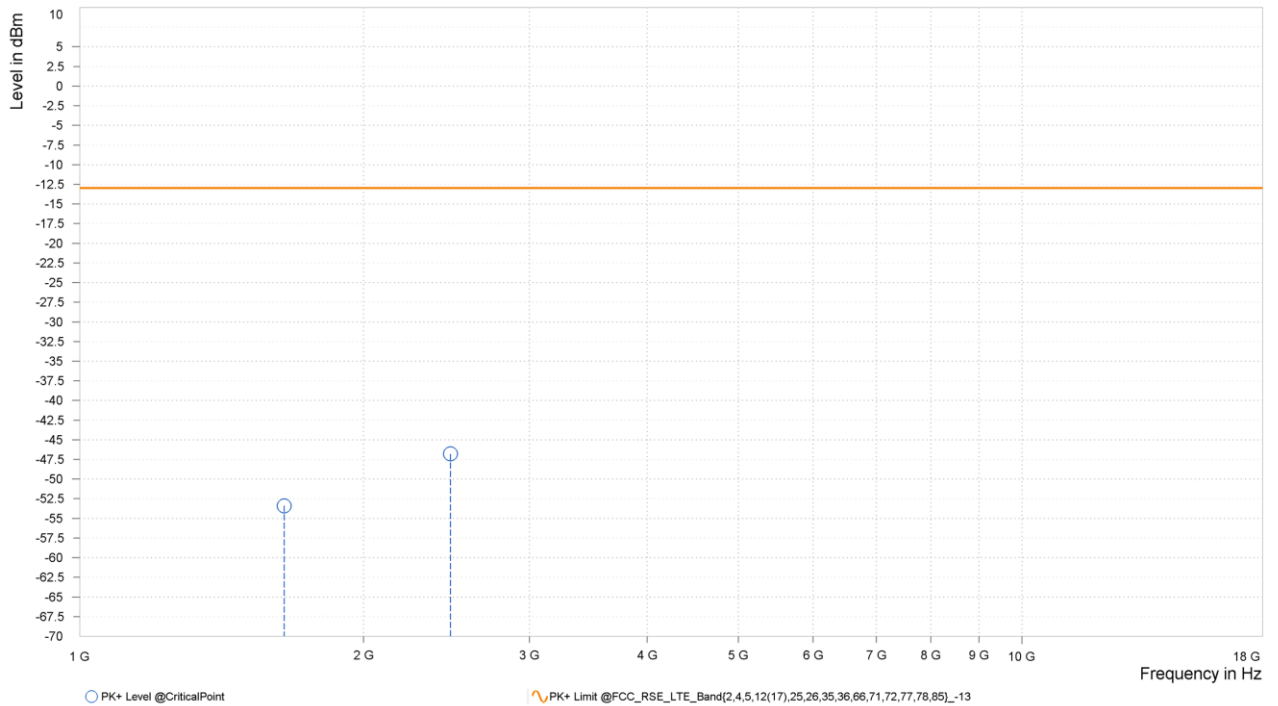



**BUREAU
VERITAS**

Test Report No.: PSU-QSU2404090210RF01

CH26915

MODE	TX channel 26915	FREQUENCY RANGE	Above 1000MHz
ENVIRONMENTAL CONDITIONS	23deg. C, 70%RH	INPUT POWER	120Vac 60HZ
TESTED BY	Jace Hu		
ANTENNA POLARITY & TEST DISTANCE: HORIZONTAL AT 3 M			

Rg	Frequency [MHz]	PK+ Level [dBm]	PK+ Limit [dBm]	PK+ Margin [dB]	Correction [dB]	Polarization	Azimuth [deg]	Antenna Height [m]
1	1,674.500	-43.85	-13.00	30.85	7.87	H	354.9	2.00
1	2,507.610	-49.30	-13.00	36.30	12.28	H	4.5	1.00

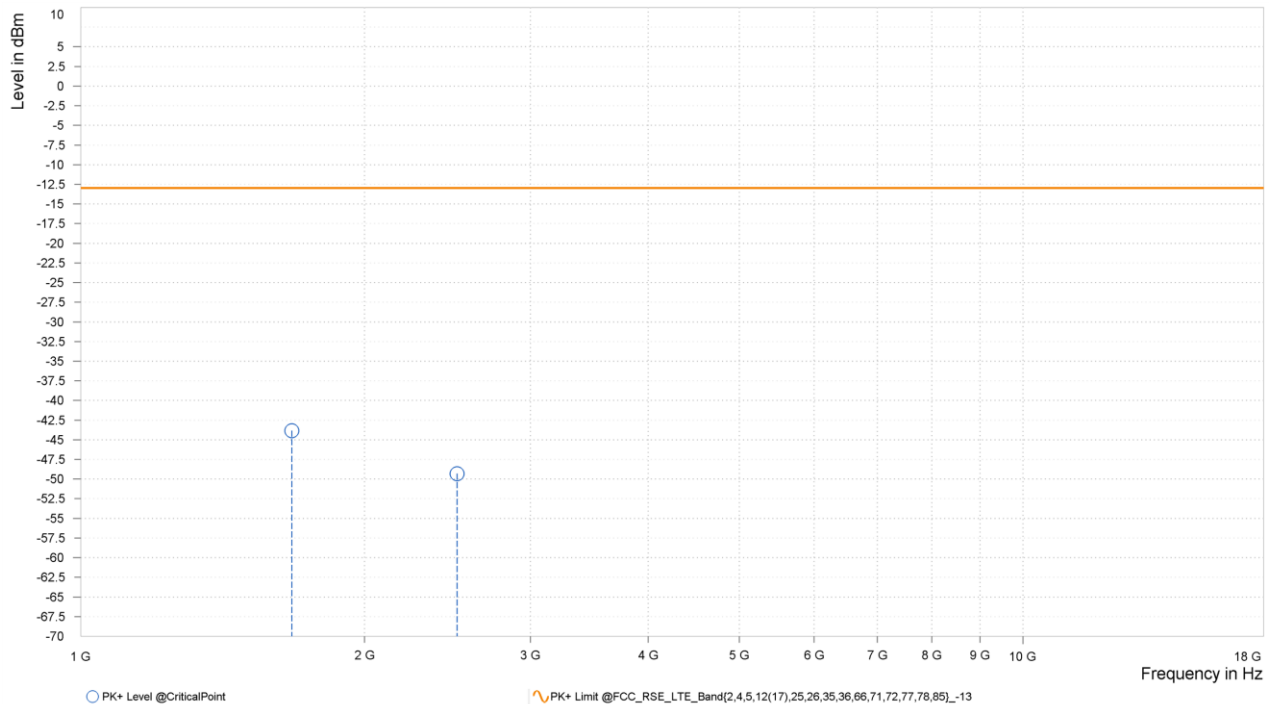



**BUREAU
VERITAS**

Test Report No.: PSU-QSU2404090210RF01

MODE	TX channel 26915	FREQUENCY RANGE	Above 1000MHz
ENVIRONMENTAL CONDITIONS	23deg. C, 70%RH	INPUT POWER	120Vac 60HZ
TESTED BY	Jace Hu		
ANTENNA POLARITY & TEST DISTANCE: VERTICAL AT 3 M			

Rg	Frequency [MHz]	PK+ Level [dBm]	PK+ Limit [dBm]	PK+ Margin [dB]	Correction [dB]	Polarization	Azimuth [deg]	Antenna Height [m]
1	1,671.740	-53.86	-13.00	40.86	7.56	V	355.5	2.00
1	2,507.610	-50.14	-13.00	37.14	11.94	V	356.8	1.00

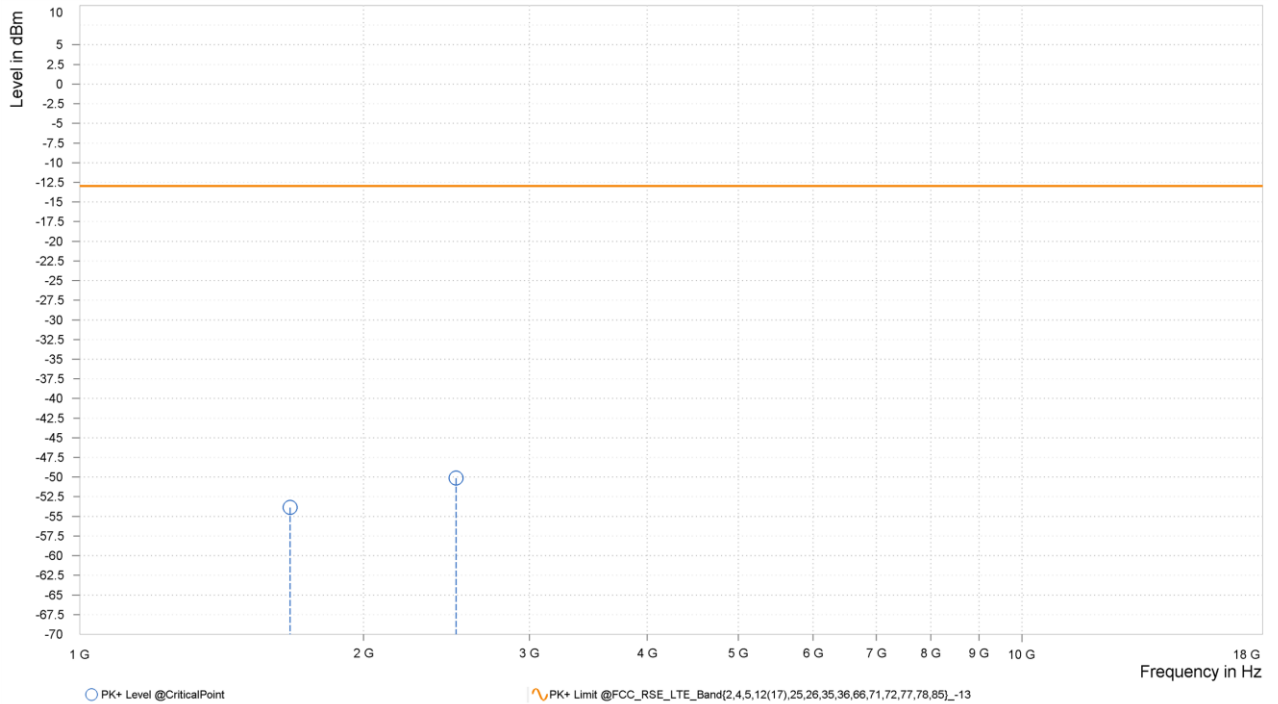



BUREAU VERITAS

Test Report No.: PSU-QSU2404090210RF01

CH27033

MODE	TX channel 27033	FREQUENCY RANGE	Above 1000MHz
ENVIRONMENTAL CONDITIONS	23deg. C, 70%RH	INPUT POWER	120Vac 60HZ
TESTED BY	Jace Hu		
ANTENNA POLARITY & TEST DISTANCE: HORIZONTAL AT 3 M			

Rg	Frequency [MHz]	PK+ Level [dBm]	PK+ Limit [dBm]	PK+ Margin [dB]	Correction [dB]	Polarization	Azimuth [deg]	Antenna Height [m]
1	1,695.500	-43.50	-13.00	30.50	8.48	H	359	2.00
1	2,543.010	-51.73	-13.00	38.73	12.11	H	355	2.00

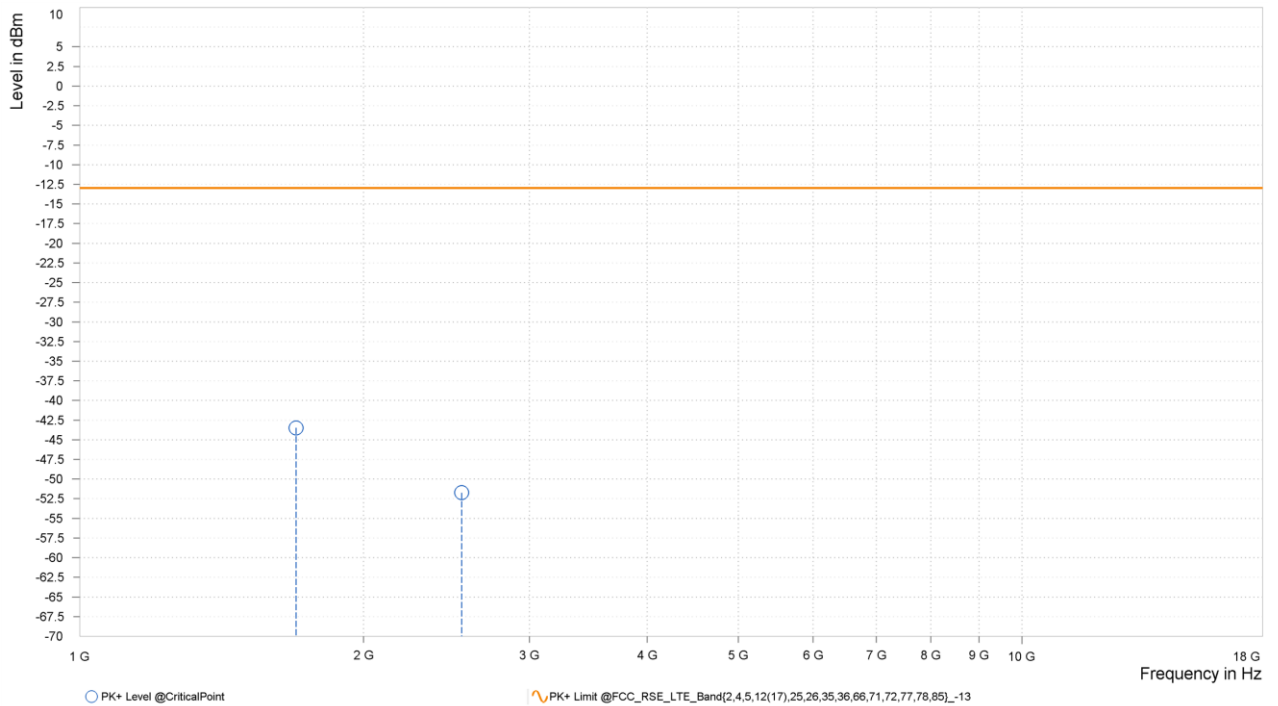



**BUREAU
VERITAS**

Test Report No.: PSU-QSU2404090210RF01

MODE	TX channel 27033	FREQUENCY RANGE	Above 1000MHz
ENVIRONMENTAL CONDITIONS	23deg. C, 70%RH	INPUT POWER	120Vac 60HZ
TESTED BY	Jace Hu		
ANTENNA POLARITY & TEST DISTANCE: VERTICAL AT 3 M			

Rg	Frequency [MHz]	PK+ Level [dBm]	PK+ Limit [dBm]	PK+ Margin [dB]	Correction [dB]	Polarization	Azimuth [deg]	Antenna Height [m]
1	1,695.340	-51.60	-13.00	38.60	8.65	V	226.7	1.00
1	2,543.010	-51.40	-13.00	38.40	11.89	V	354.9	2.00

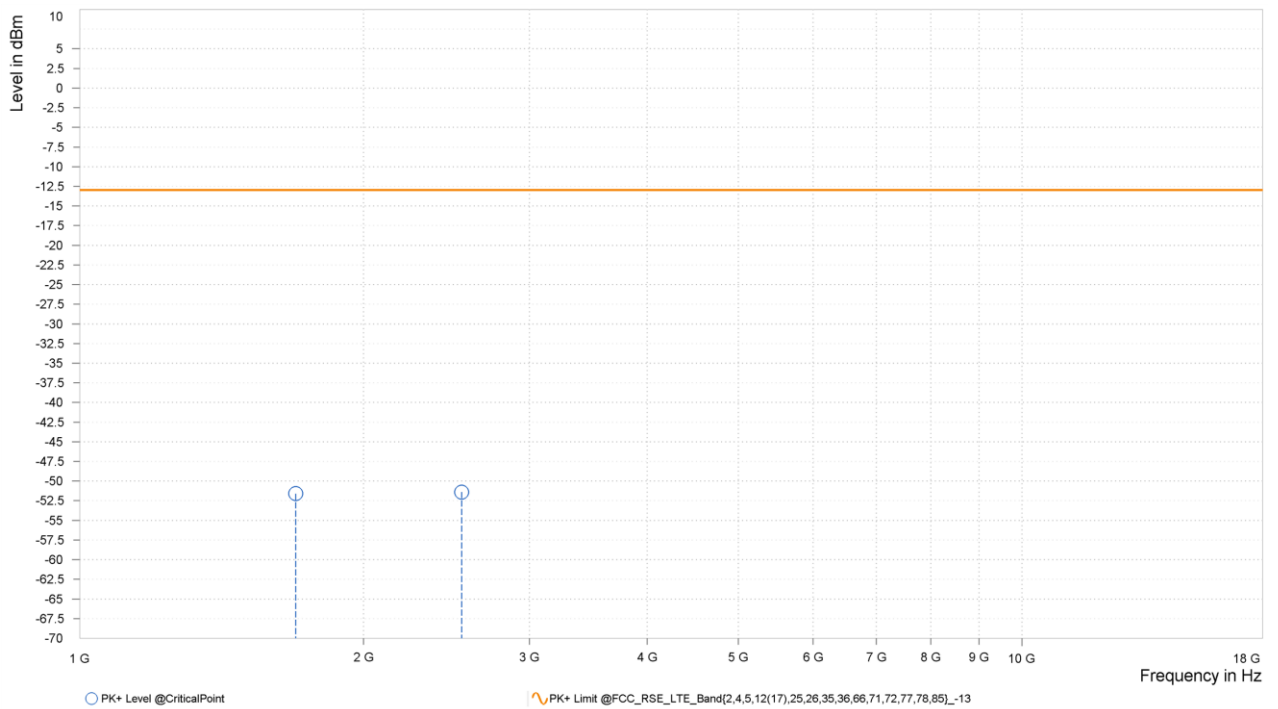



CHANNEL BANDWIDTH: 3MHz / QPSK

MODE	TX channel 26915	FREQUENCY RANGE	Above 1000MHz
ENVIRONMENTAL CONDITIONS	23deg. C, 70%RH	INPUT POWER	120Vac 60HZ
TESTED BY	Jace Hu		
ANTENNA POLARITY & TEST DISTANCE: HORIZONTAL AT 3 M			

Rg	Frequency [MHz]	PK+ Level [dBm]	PK+ Limit [dBm]	PK+ Margin [dB]	Correction [dB]	Polarization	Azimuth [deg]	Antenna Height [m]
1	1,671.000	-50.88	-13.00	37.88	7.77	H	4.5	1.00
1	2,505.450	-50.06	-13.00	37.06	12.29	H	359	2.00

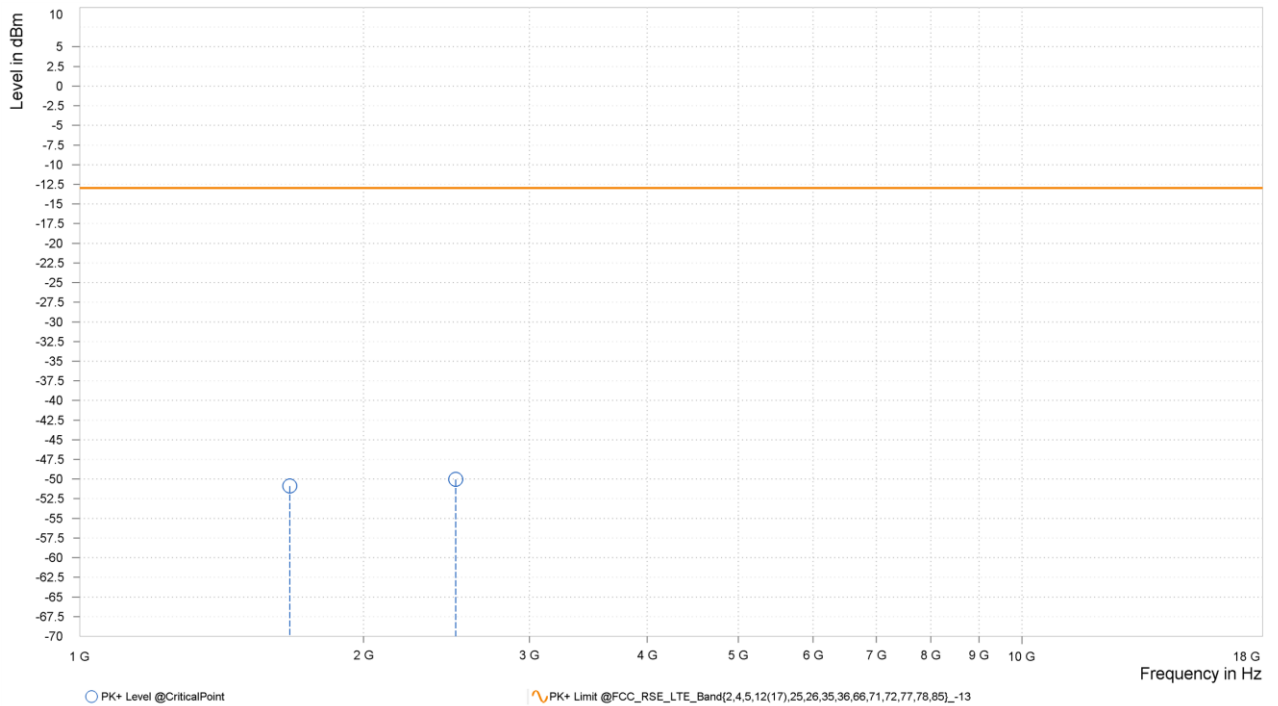



**BUREAU
VERITAS**

Test Report No.: PSU-QSU2404090210RF01

MODE	TX channel 26915	FREQUENCY RANGE	Above 1000MHz
ENVIRONMENTAL CONDITIONS	23deg. C, 70%RH	INPUT POWER	120Vac 60HZ
TESTED BY	Jace Hu		
ANTENNA POLARITY & TEST DISTANCE: VERTICAL AT 3 M			

Rg	Frequency [MHz]	PK+ Level [dBm]	PK+ Limit [dBm]	PK+ Margin [dB]	Correction [dB]	Polarization	Azimuth [deg]	Antenna Height [m]
1	1,670.500	-51.32	-13.00	38.32	7.52	V	354.9	2.00
1	2,505.450	-49.72	-13.00	36.72	11.93	V	5.1	1.00

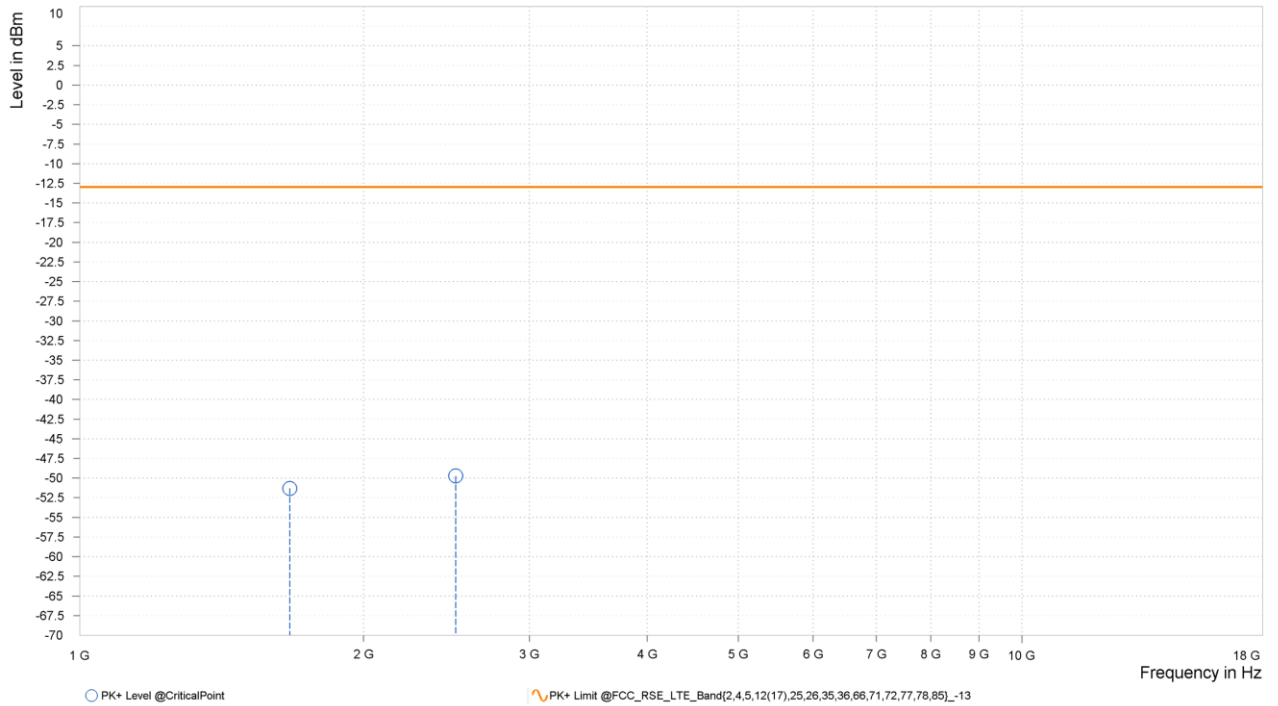



CHANNEL BANDWIDTH: 5MHz / QPSK

MODE	TX channel 26915	FREQUENCY RANGE	Above 1000MHz
ENVIRONMENTAL CONDITIONS	23deg. C, 70%RH	INPUT POWER	120Vac 60HZ
TESTED BY	Jace Hu		
ANTENNA POLARITY & TEST DISTANCE: HORIZONTAL AT 3 M			

Rg	Frequency [MHz]	PK+ Level [dBm]	PK+ Limit [dBm]	PK+ Margin [dB]	Correction [dB]	Polarization	Azimuth [deg]	Antenna Height [m]
1	1,669.000	-44.25	-13.00	31.25	7.71	H	359	2.00
1	2,502.750	-50.36	-13.00	37.36	12.29	H	359	2.00

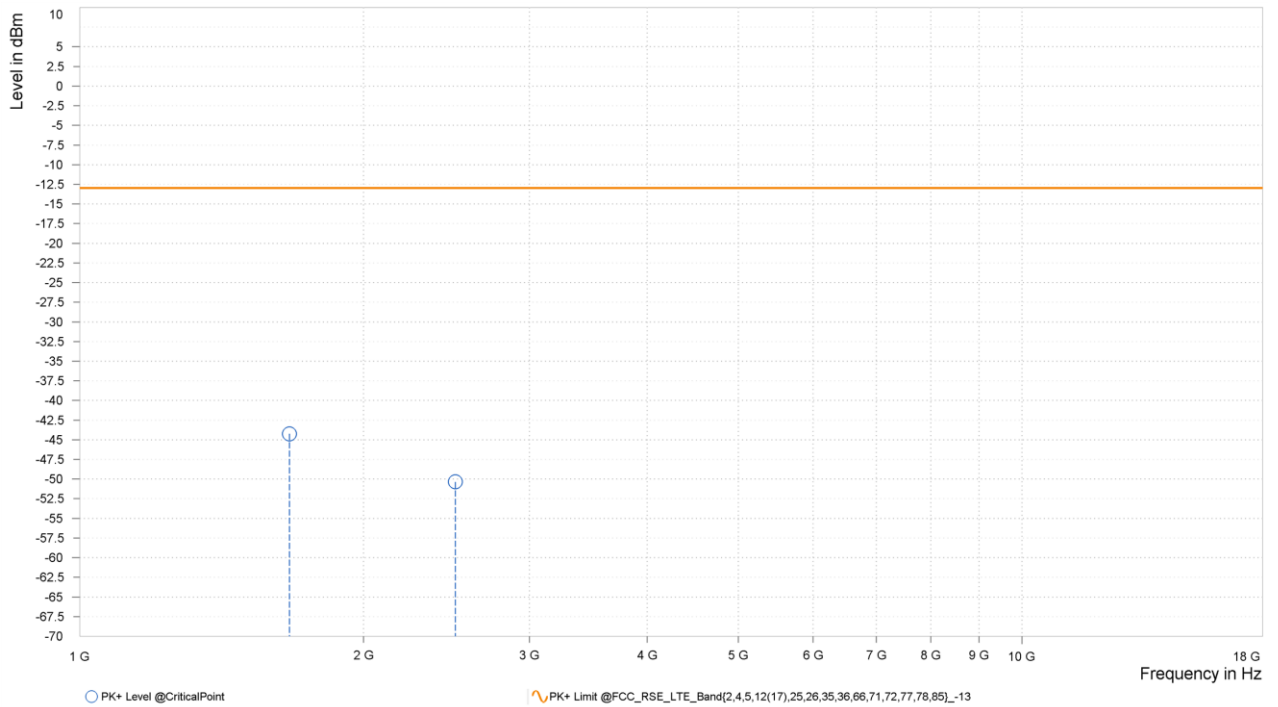



**BUREAU
VERITAS**

Test Report No.: PSU-QSU2404090210RF01

MODE	TX channel 26915	FREQUENCY RANGE	Above 1000MHz
ENVIRONMENTAL CONDITIONS	23deg. C, 70%RH	INPUT POWER	120Vac 60HZ
TESTED BY	Jace Hu		
ANTENNA POLARITY & TEST DISTANCE: VERTICAL AT 3 M			

Rg	Frequency [MHz]	PK+ Level [dBm]	PK+ Limit [dBm]	PK+ Margin [dB]	Correction [dB]	Polarization	Azimuth [deg]	Antenna Height [m]
1	1,668.500	-53.45	-13.00	40.45	7.43	V	356.5	1.00
1	2,502.750	-51.08	-13.00	38.08	11.93	V	5.2	1.00

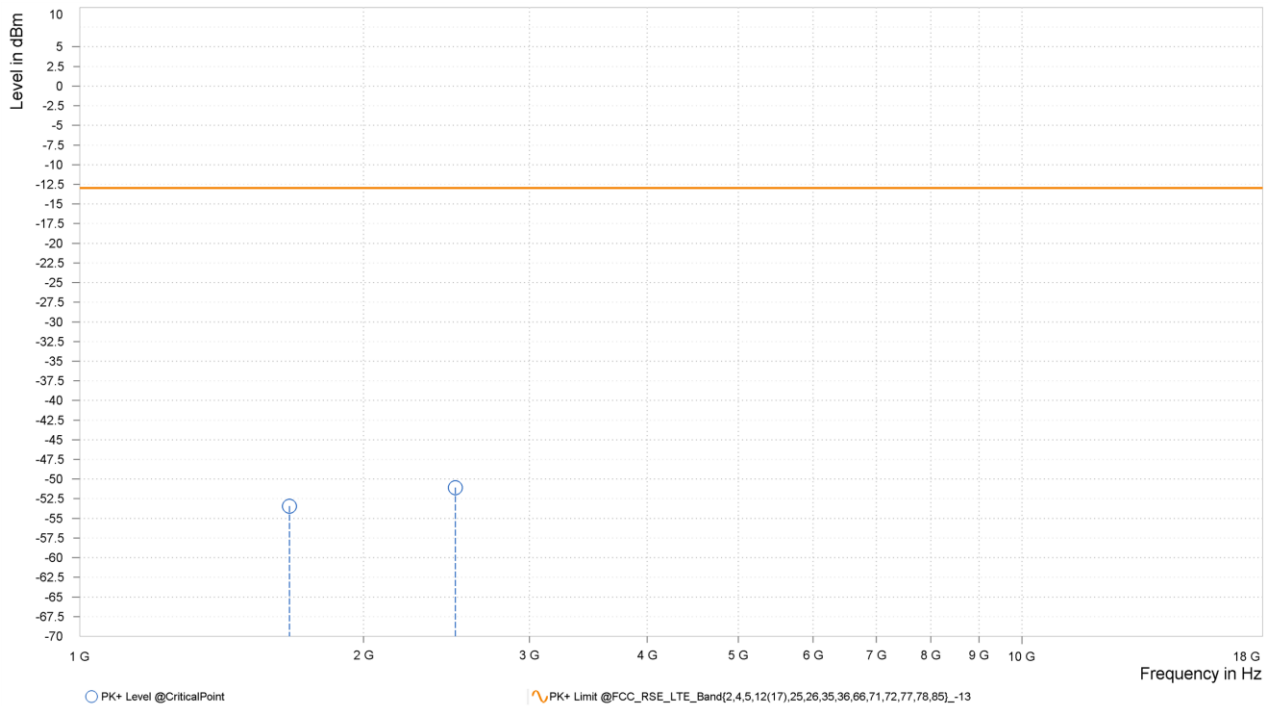



CHANNEL BANDWIDTH: 10MHz / QPSK

MODE	TX channel 26915	FREQUENCY RANGE	Above 1000MHz
ENVIRONMENTAL CONDITIONS	23deg. C, 70%RH	INPUT POWER	120Vac 60HZ
TESTED BY	Jace Hu		
ANTENNA POLARITY & TEST DISTANCE: HORIZONTAL AT 3 M			

Rg	Frequency [MHz]	PK+ Level [dBm]	PK+ Limit [dBm]	PK+ Margin [dB]	Correction [dB]	Polarization	Azimuth [deg]	Antenna Height [m]
1	1,664.000	-53.12	-13.00	40.12	7.55	H	0.9	2.00
1	2,496.000	-50.59	-13.00	37.59	12.30	H	0.9	2.00

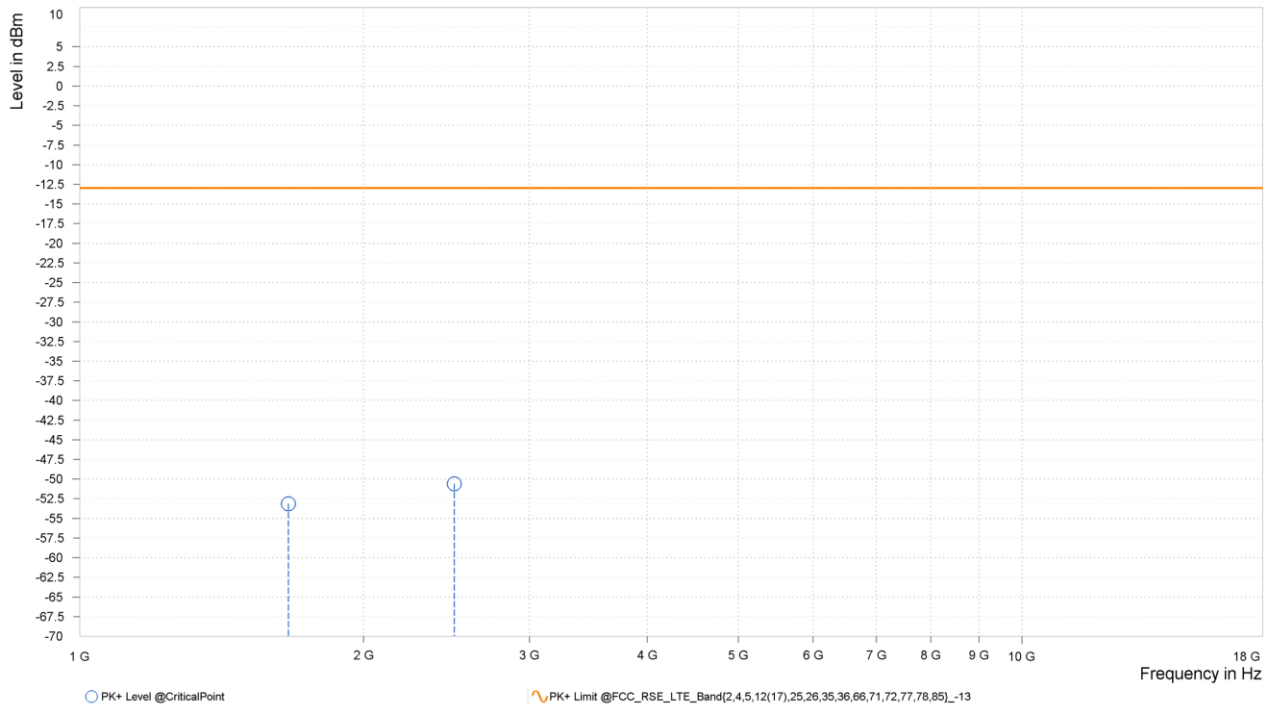



BUREAU VERITAS

Test Report No.: PSU-QSU2404090210RF01

MODE	TX channel 26915	FREQUENCY RANGE	Above 1000MHz
ENVIRONMENTAL CONDITIONS	23deg. C, 70%RH	INPUT POWER	120Vac 60HZ
TESTED BY	Jace Hu		
ANTENNA POLARITY & TEST DISTANCE: VERTICAL AT 3 M			

Rg	Frequency [MHz]	PK+ Level [dBm]	PK+ Limit [dBm]	PK+ Margin [dB]	Correction [dB]	Polarization	Azimuth [deg]	Antenna Height [m]
1	1,664.000	-53.98	-13.00	40.98	7.21	V	359	2.00
1	2,496.000	-49.44	-13.00	36.44	11.92	V	256.5	1.00

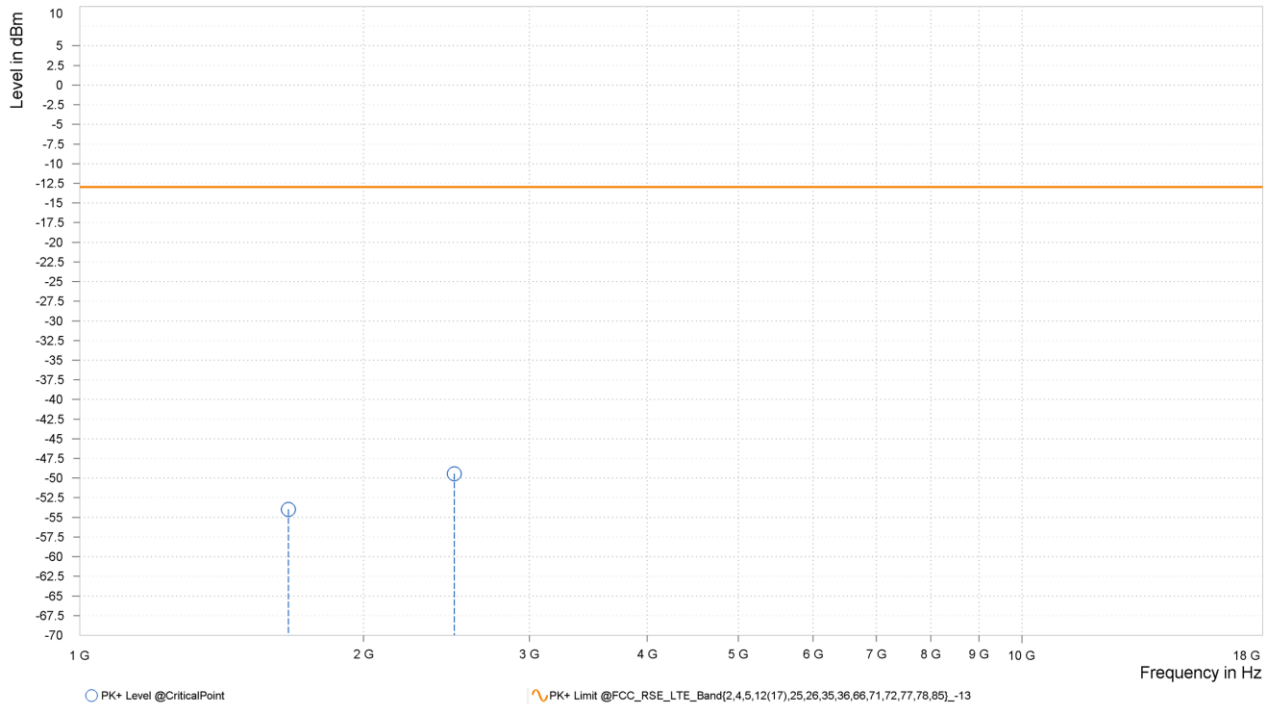



BUREAU VERITAS

Test Report No.: PSU-QSU2404090210RF01

CHANNEL BANDWIDTH: 15MHz / QPSK

MODE	TX channel 26915	FREQUENCY RANGE	Above 1000MHz
ENVIRONMENTAL CONDITIONS	23deg. C, 70%RH	INPUT POWER	120Vac 60HZ
TESTED BY	Jace Hu		
ANTENNA POLARITY & TEST DISTANCE: HORIZONTAL AT 3 M			

Rg	Frequency [MHz]	PK+ Level [dBm]	PK+ Limit [dBm]	PK+ Margin [dB]	Correction [dB]	Polarization	Azimuth [deg]	Antenna Height [m]
1	1,661.000	-47.19	-13.00	34.19	7.44	H	2.9	2.00
1	2,489.250	-50.97	-13.00	37.97	12.33	H	1	1.00

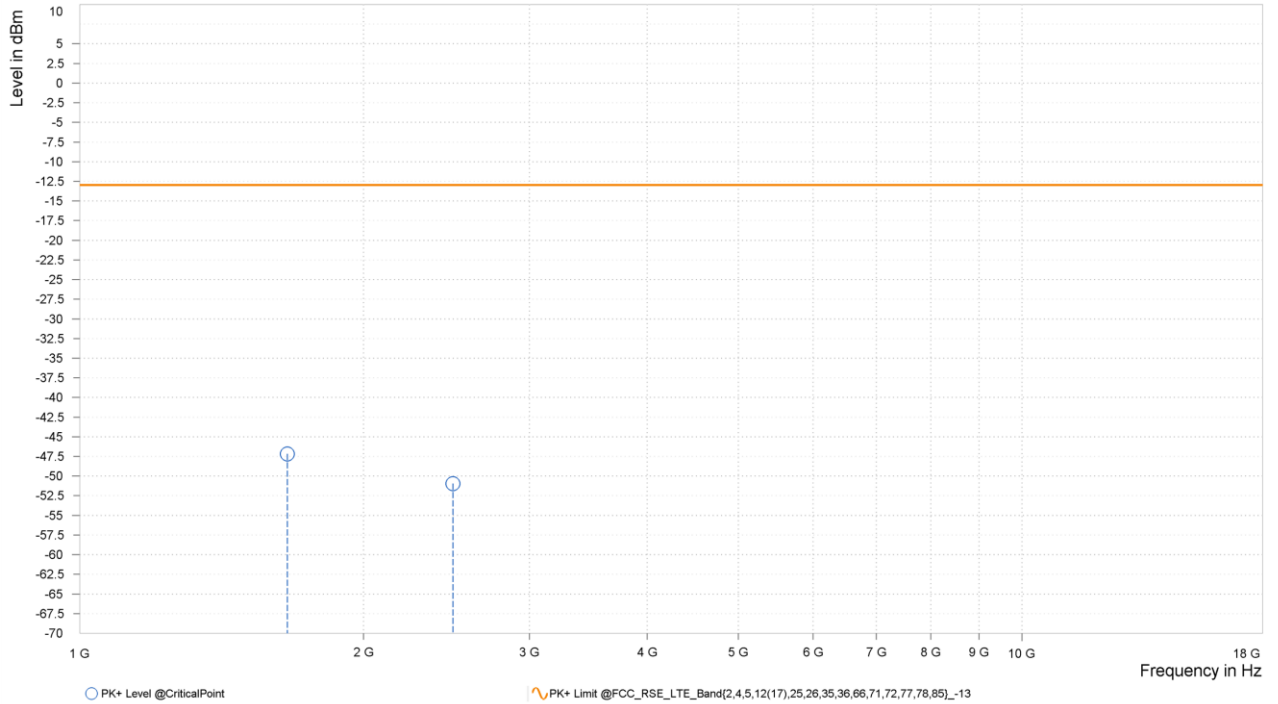



**BUREAU
VERITAS**

Test Report No.: PSU-QSU2404090210RF01

MODE	TX channel 26915	FREQUENCY RANGE	Above 1000MHz
ENVIRONMENTAL CONDITIONS	23deg. C, 70%RH	INPUT POWER	120Vac 60HZ
TESTED BY	Jace Hu		
ANTENNA POLARITY & TEST DISTANCE: VERTICAL AT 3 M			

Rg	Frequency [MHz]	PK+ Level [dBm]	PK+ Limit [dBm]	PK+ Margin [dB]	Correction [dB]	Polarization	Azimuth [deg]	Antenna Height [m]
1	1,659.500	-51.13	-13.00	38.13	6.97	V	83.2	1.00
1	2,489.250	-49.26	-13.00	36.26	11.97	V	353.8	1.00

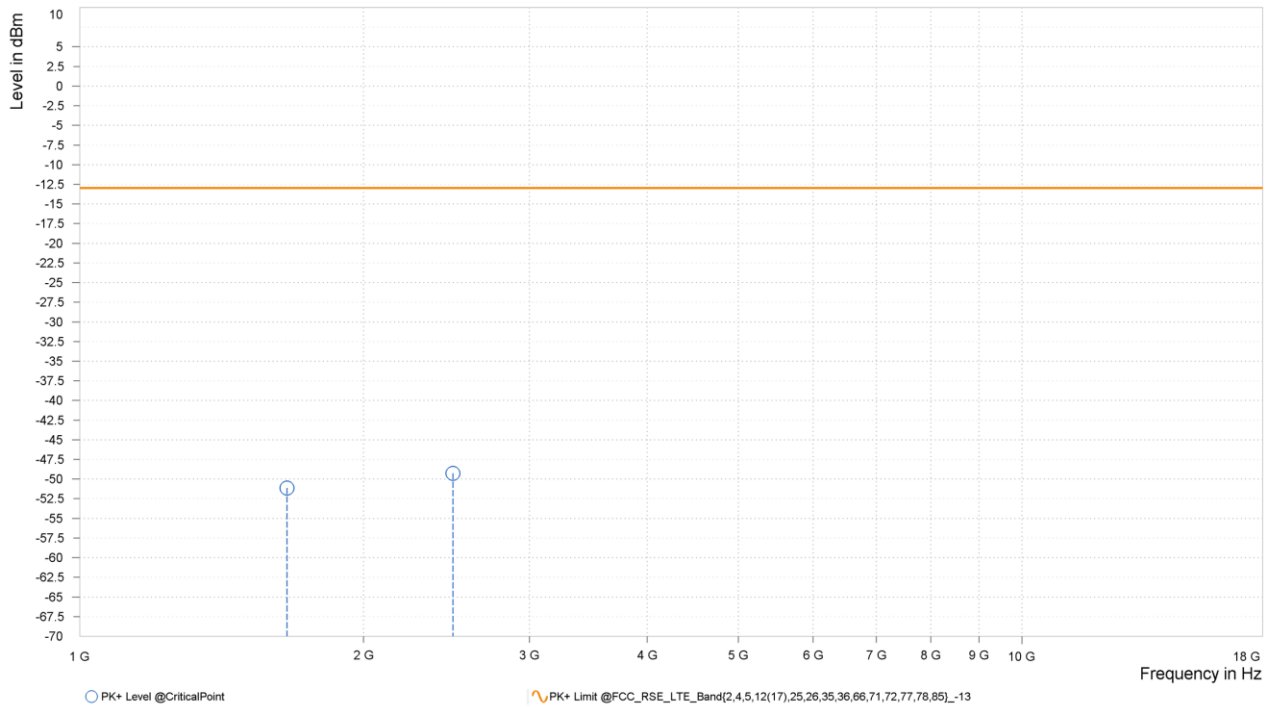



**BUREAU
VERITAS**

Test Report No.: PSU-QSU2404090210RF01

NB-IOT LTE Band 26

CH26792

MODE	TX channel 26792	FREQUENCY RANGE	Above 1000MHz
ENVIRONMENTAL CONDITIONS	23deg. C, 70%RH	INPUT POWER	120Vac 60HZ
TESTED BY	Jace Hu		
ANTENNA POLARITY & TEST DISTANCE: HORIZONTAL AT 3 M			

Rg	Frequency [MHz]	PK+ Level [dBm]	PK+ Limit [dBm]	PK+ Margin [dB]	Correction [dB]	Polarization	Azimuth [deg]	Antenna Height [m]
2	1,649.000	-52.54	-13.00	39.54	14.09	H	1.4	2.00
3	2,472.600	-50.35	-13.00	37.35	19.28	H	229.1	1.00

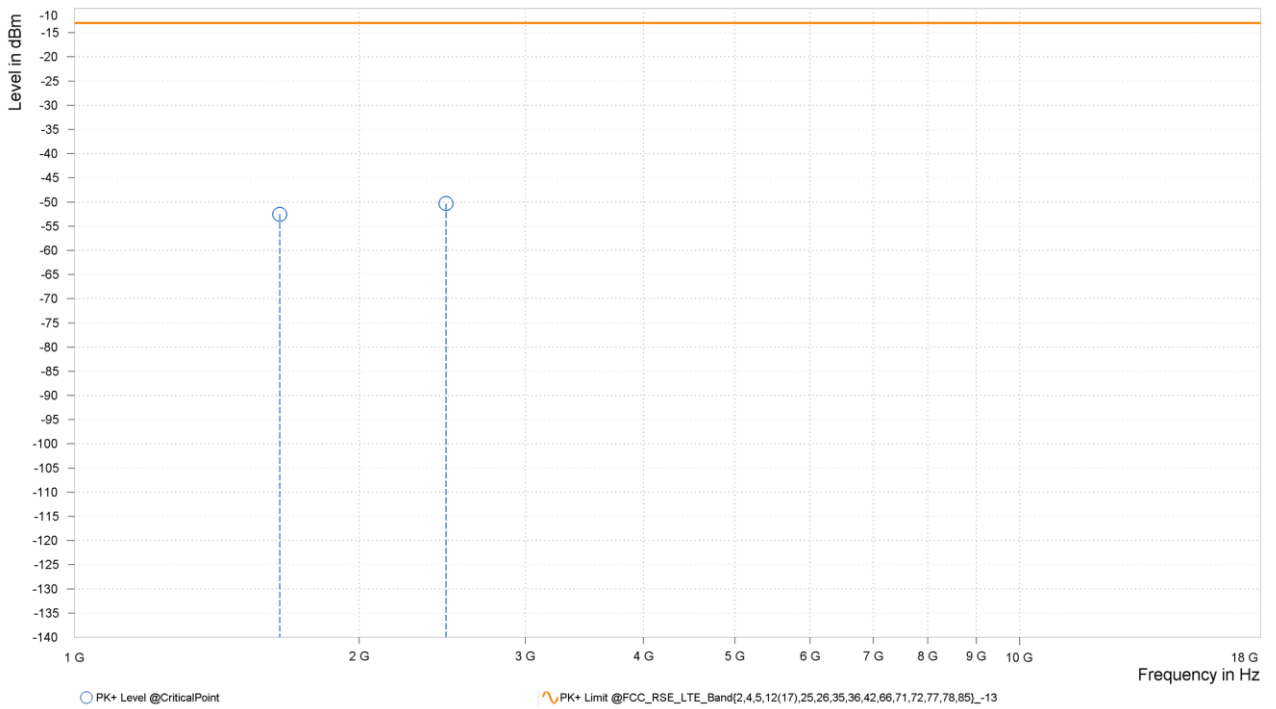



**BUREAU
VERITAS**

Test Report No.: PSU-QSU2404090210RF01

MODE	TX channel 26792	FREQUENCY RANGE	Above 1000MHz
ENVIRONMENTAL CONDITIONS	23deg. C, 70%RH	INPUT POWER	120Vac 60HZ
TESTED BY	Jace Hu		
ANTENNA POLARITY & TEST DISTANCE: VERTICAL AT 3 M			

Rg	Frequency [MHz]	PK+ Level [dBm]	PK+ Limit [dBm]	PK+ Margin [dB]	Correction [dB]	Polarization	Azimuth [deg]	Antenna Height [m]
2	1,648.400	-55.74	-13.00	42.74	13.65	V	359	1.00
3	2,472.600	-50.80	-13.00	37.80	19.53	V	294.3	1.00

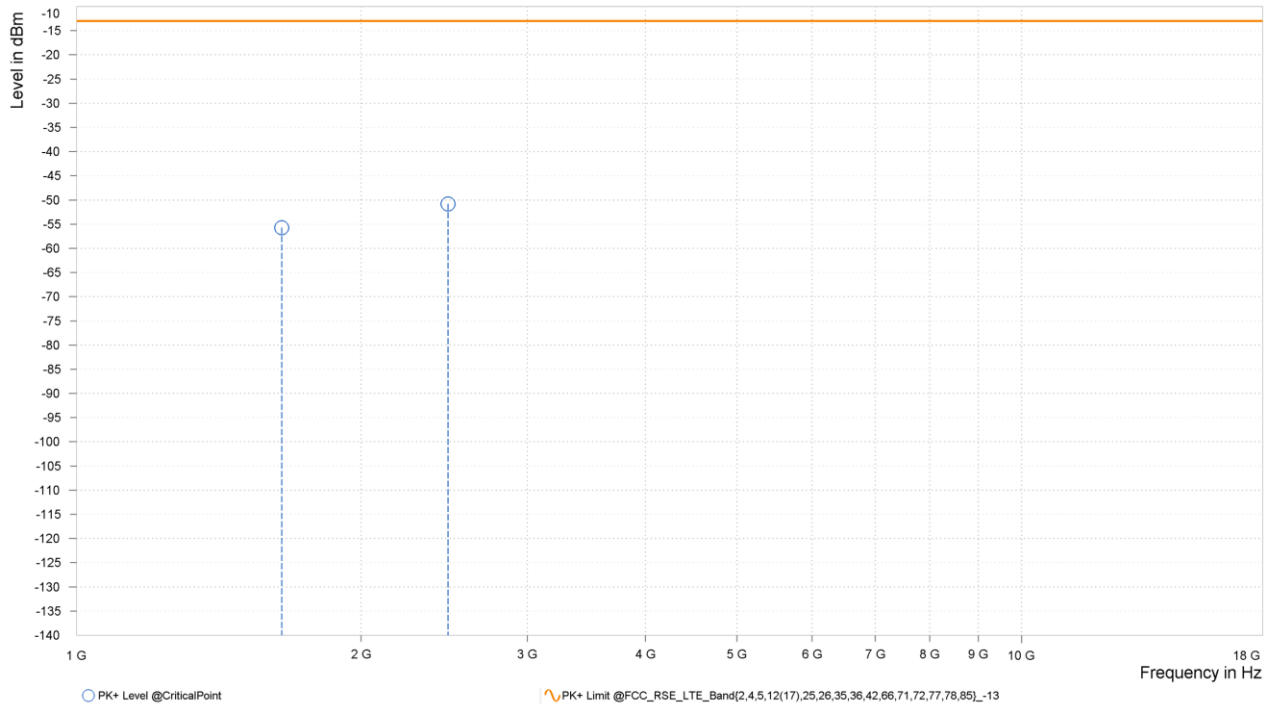



CH 26915

MODE	TX channel 26915	FREQUENCY RANGE	Above 1000MHz
ENVIRONMENTAL CONDITIONS	23deg. C, 70%RH	INPUT POWER	120Vac 60HZ
TESTED BY	Jace Hu		
ANTENNA POLARITY & TEST DISTANCE: HORIZONTAL AT 3 M			

Rg	Frequency [MHz]	PK+ Level [dBm]	PK+ Limit [dBm]	PK+ Margin [dB]	Correction [dB]	Polarization	Azimuth [deg]	Antenna Height [m]
2	1,673.000	-46.02	-13.00	33.02	14.80	H	319	1.00
3	2,509.500	-51.65	-13.00	38.65	19.71	H	119.5	2.00

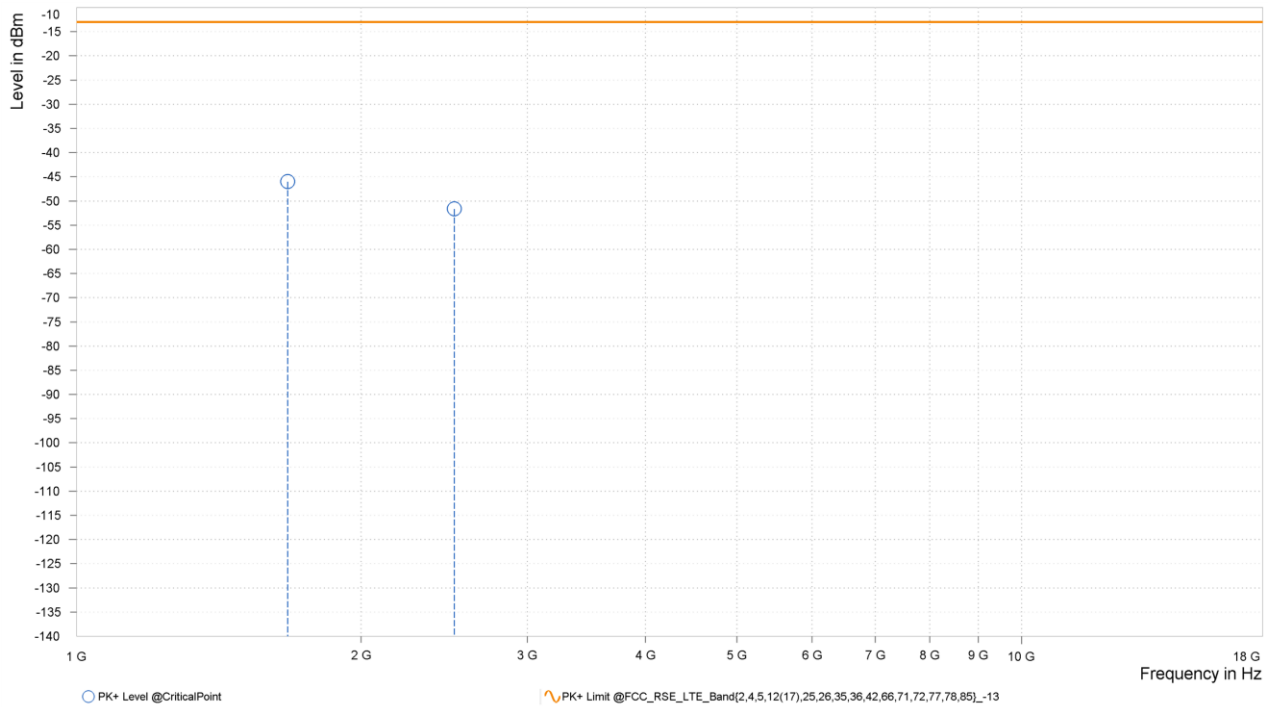



**BUREAU
VERITAS**

Test Report No.: PSU-QSU2404090210RF01

MODE	TX channel 26915	FREQUENCY RANGE	Above 1000MHz
ENVIRONMENTAL CONDITIONS	23deg. C, 70%RH	INPUT POWER	120Vac 60HZ
TESTED BY	Jace Hu		
ANTENNA POLARITY & TEST DISTANCE: VERTICAL AT 3 M			

Rg	Frequency [MHz]	PK+ Level [dBm]	PK+ Limit [dBm]	PK+ Margin [dB]	Correction [dB]	Polarization	Azimuth [deg]	Antenna Height [m]
2	1,673.500	-50.51	-13.00	37.51	13.70	V	324.6	2.00
3	2,509.500	-50.49	-13.00	37.49	20.33	V	358.8	1.00

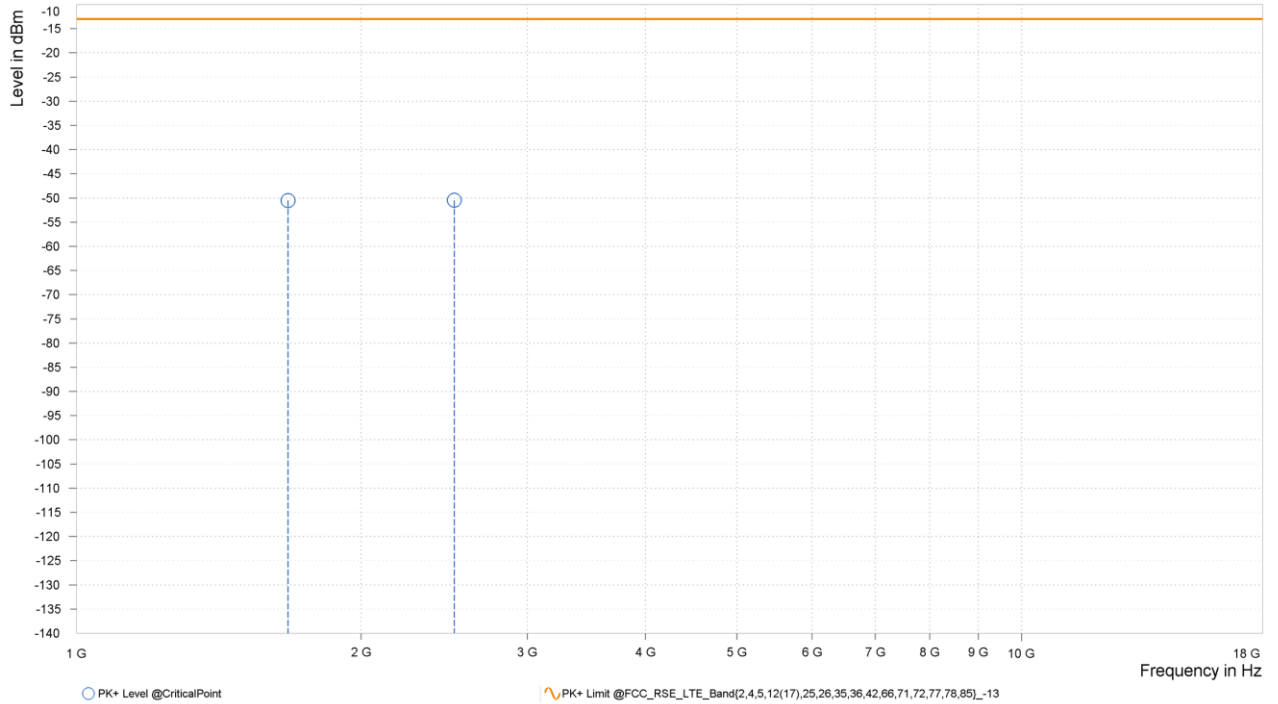



BUREAU VERITAS

Test Report No.: PSU-QSU2404090210RF01

CH 27038

MODE	TX channel 27038	FREQUENCY RANGE	Above 1000MHz
ENVIRONMENTAL CONDITIONS	23deg. C, 70%RH	INPUT POWER	120Vac 60HZ
TESTED BY	Jace Hu		
ANTENNA POLARITY & TEST DISTANCE: HORIZONTAL AT 3 M			

Rg	Frequency [MHz]	PK+ Level [dBm]	PK+ Limit [dBm]	PK+ Margin [dB]	Correction [dB]	Polarization	Azimuth [deg]	Antenna Height [m]
1	1,697.800	-51.92	-13.00	38.92	8.55	H	354.9	2.00
1	2,546.700	-50.10	-13.00	37.10	12.09	H	354.9	2.00

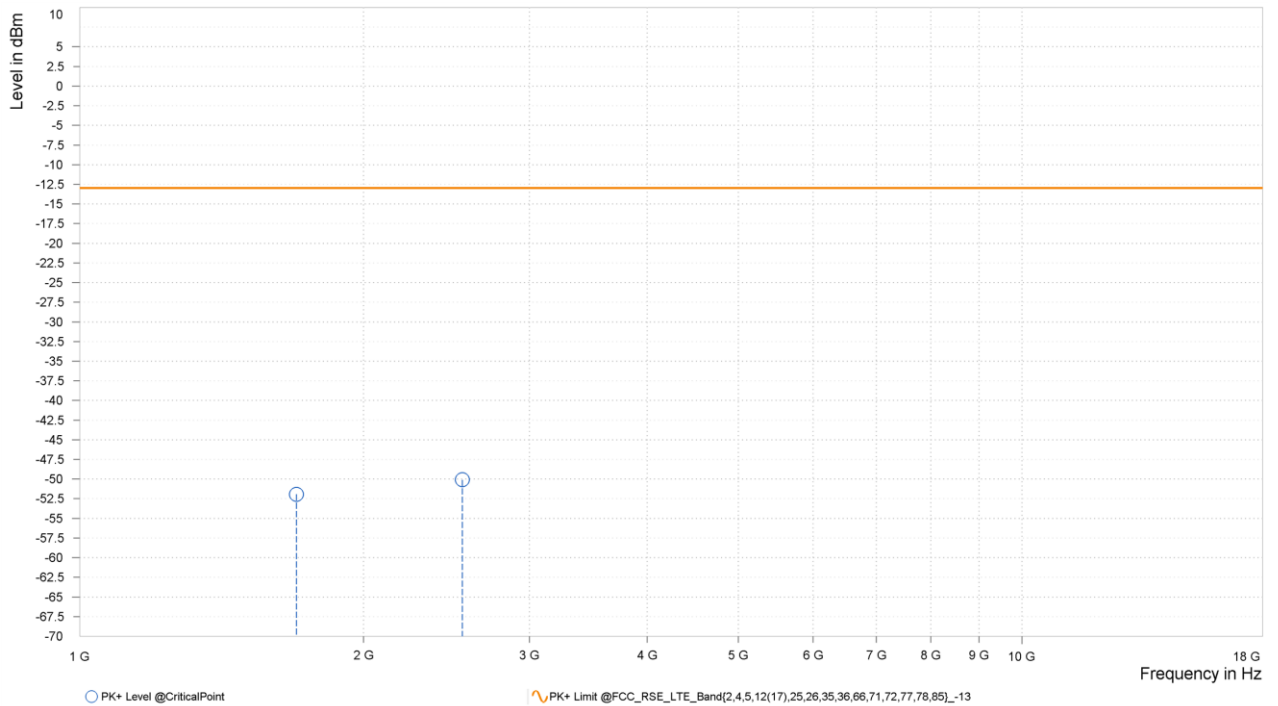



**BUREAU
VERITAS**

Test Report No.: PSU-QSU2404090210RF01

MODE	TX channel 27038	FREQUENCY RANGE	Above 1000MHz
ENVIRONMENTAL CONDITIONS	23deg. C, 70%RH	INPUT POWER	120Vac 60HZ
TESTED BY	Jace Hu		
ANTENNA POLARITY & TEST DISTANCE: VERTICAL AT 3 M			

Rg	Frequency [MHz]	PK+ Level [dBm]	PK+ Limit [dBm]	PK+ Margin [dB]	Correction [dB]	Polarization	Azimuth [deg]	Antenna Height [m]
1	1,697.800	-51.92	-13.00	38.92	8.77	V	226.7	1.00
1	2,546.700	-50.72	-13.00	37.72	11.88	V	226.7	1.00

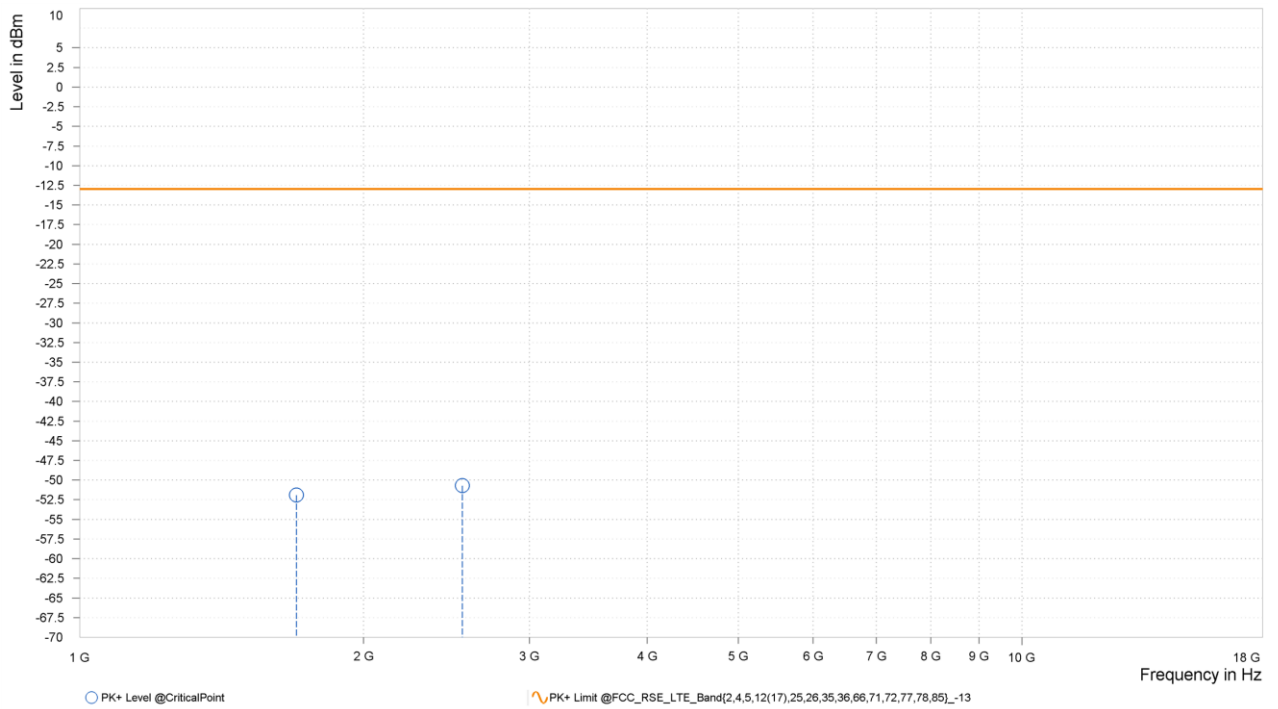

3.7 PEAK TO AVERAGE RATIO

3.7.1 LIMITS OF PEAK TO AVERAGE RATIO MEASUREMENT

In measuring transmissions in this band using an average power technique, the peak to-average ratio (PAR) of the transmission may not exceed 13 dB

3.7.2 TEST SETUP

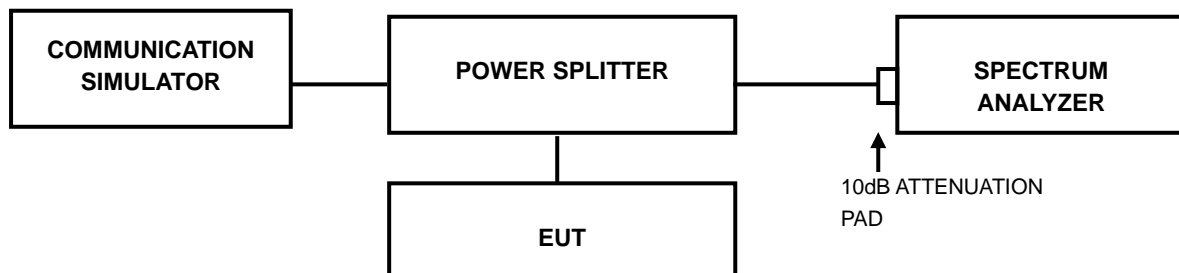

3.7.3 TEST PROCEDURES

1. Set resolution/measurement bandwidth \geq signal's occupied bandwidth;
2. Set the number of counts to a value that stabilizes the measured CCDF curve;
3. Record the maximum PAPR level associated with a probability of 0.1%.



Test Report No.: PSU-QSU2404090210RF01

3.7.4 TEST RESULTS

Refer to the original source report (Report No.: 77535RRF.001, Model Name: nRF9151, FCC ID: 2ANPO00nRF9151).



Test Report No.: PSU-QSU2404090210RF01

4 PHOTOGRAPHS OF THE TEST CONFIGURATION

Please refer to the attached file (Test Setup Photo).



Test Report No.: PSU-QSU2404090210RF01

5 INFORMATION ON THE TESTING LABORATORIES

We, Huarui 7layers High Technology (Suzhou) Co., Ltd. ,were founded in 2020 to provide our best service in EMC, Radio, Telecom and Safety consultation. Our laboratories are accredited and approved according to ISO/IEC 17025.

Huarui 7Layers High Technology (Suzhou) Co., Ltd.

Lab Address:

Tower N, Innovation Center, 88 Zhuyi Road, High-tech District, Suzhou City, Anhui Province

Accredited Test Lab Cert 6613.01

The FCC Site Registration No. is 434559; The Designation No. is CN1325.

If you have any comments, please feel free to contact us at the following:

Suzhou EMC/RF Lab:

Tel: +86 (0557) 368 1008



**BUREAU
VERITAS**

Test Report No.: PSU-QSU2404090210RF01

6 MODIFICATIONS RECORDERS FOR ENGINEERING CHANGES TO THE EUT BY THE LAB

No any modifications are made to the EUT by the lab during the test.

--END--