

Renogy

MPPT Solar Charge Controller

12V/24V/36V/48V | 30A

RCC30REGO

VERSION A0
April 30, 2024

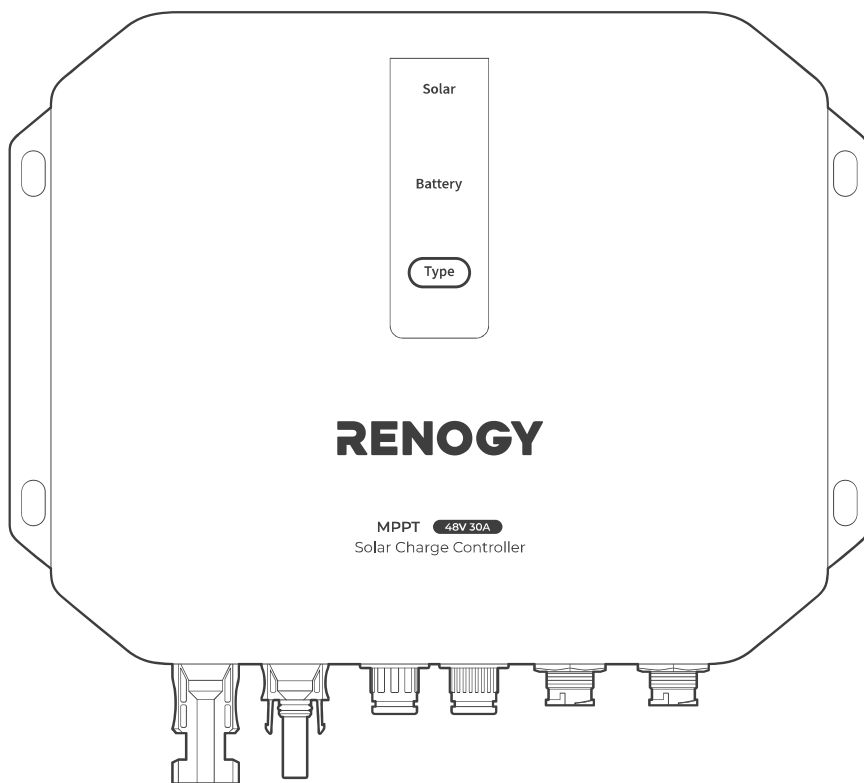

QUICK GUIDE

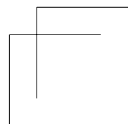
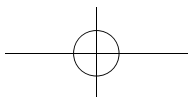
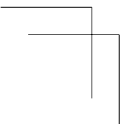
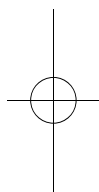
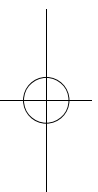
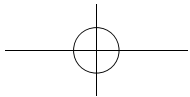
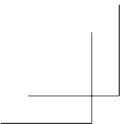

Before Getting Started

The quick guide provides important operation and maintenance instructions for Renogy 12V/24V/36V/48V 30A MPPT Solar Charge Controller (hereinafter referred to as charge controller).

Read the quick guide carefully before operation and save it for future reference. Failure to observe the instructions or precautions in the quick guide can result in electrical shock, serious injury, or death, or can damage the charge controller, potentially rendering it inoperable.

- Renogy ensures the accuracy, sufficiency, and the applicability of information in the quick guide at the time of printing due to continual product improvements that may occur.
- Renogy assumes no responsibility or liability for personal and property losses, whether directly and indirectly, caused by the user's failure to install and use the product in compliance with the quick guide.
- Renogy is not responsible or liable for any failure, damage, or injury resulting from repair attempts by unqualified personnel, improper installation, or inappropriate operation.
- The illustrations in the quick guide are for demonstration purposes only. Details may appear slightly different depending on product revision and market region.
- Renogy reserves the right to change the information in the quick guide without notice. For the latest quick guide, visit [renogy.com](https://www.renogy.com).

Disclaimer

Renogy 12V/24V/36V/48V 30A MPPT Solar Charge Controller Quick Guide © 2024 Renogy. All rights reserved.

RENOGY and **RENOGY** are registered trademarks of Renogy.

- All information in the quick guide is subject to copyright and other intellectual property rights of Renogy and its licensors. The quick guide may not be modified, reproduced, or copied, in whole or in part, without the prior written permissions of Renogy and its licensors.
- The registered trademarks in the quick guide are the property of Renogy. The unauthorized use of the trademarks is strictly prohibited.

Online Manual

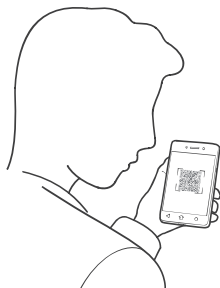

Quick Guide



User Manual

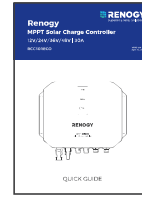
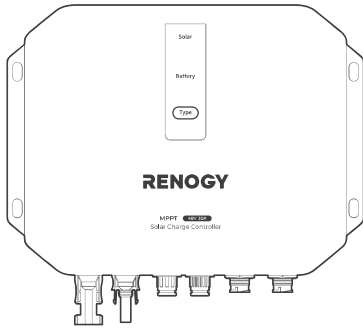

Table of Contents

What's In the Box?	1
Dimensions	1
Get to Know Renogy Charge Controller	2
System Setup	2
Required Tools & Accessories	3
How to Install the Amphenol Connectors?	3
Step 1. Wear Insulating Gloves	4
Step 2. Plan a Mounting Site	4
Step 3. Connect the Charge Controller to a Battery	5
Step 4. Connect the Charge Controller to a Solar Panel	6
Step 5. Install a Battery Temperature Sensor	7
LED Indicators	7
Set a Battery Type	8
USER Mode	9
Monitor the Battery Charger	10
Short-Range Monitoring via DC Home App.....	10
Wireless Long-Range Monitoring	11
Troubleshooting	11
Important Safety Instructions	12
Renogy Support	13
FCC Statement	14
FCC Radiation Exposure Statement	14

What's In the Box?

Renogy 12V/24V/36V/48V 30A
MPPT Solar Charge Controller × 1



Quick Guide × 1

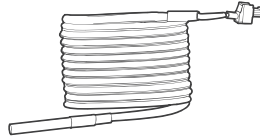

Battery Temperature
Sensor (3 m) × 1



Mounting Screws × 4
(torque: 3.5 N·m)



Make sure that all accessories are complete and free of any signs of damage.



The accessories and product manual listed are crucial for the installation, excluding warranty information and any additional items. Please note that the package contents may vary depending on the specific product model.

Dimensions

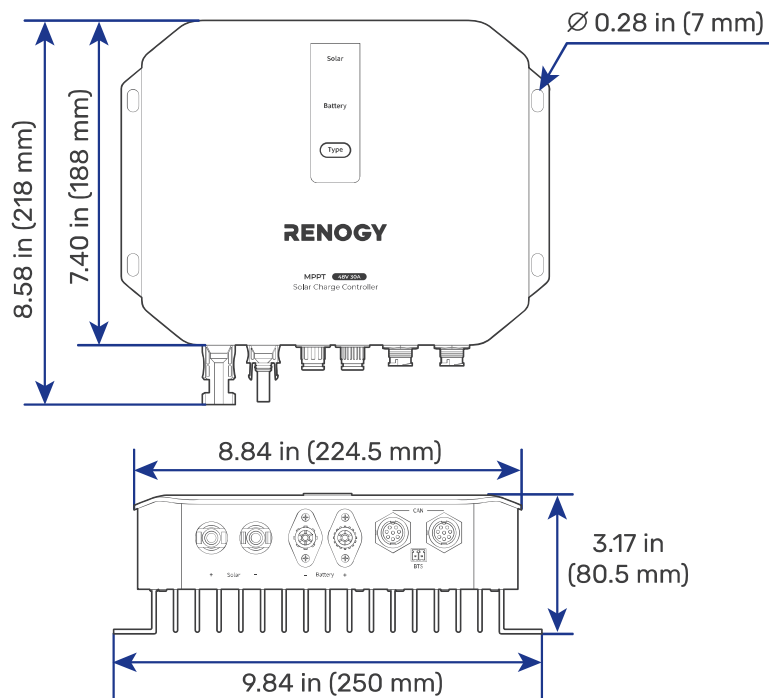

Dimension tolerance: ±0.2 in (0.5 mm)

Get to Know Renogy Charge Controller

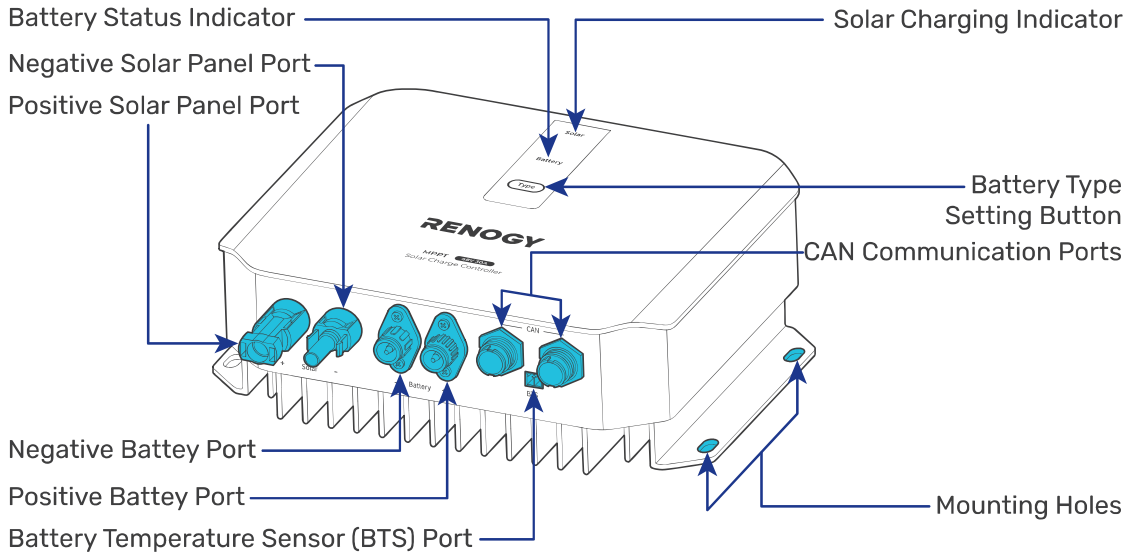

The Battery Temperature Sensor (BTS) Port cannot be used on lithium iron phosphate batteries which come with battery management systems (BMS).



For wiring details of the CAN Communication Ports, refer to the [Renogy Charge Controller User Manual](https://www.renogy.com/support/downloads) at <https://www.renogy.com/support/downloads>.

System Setup

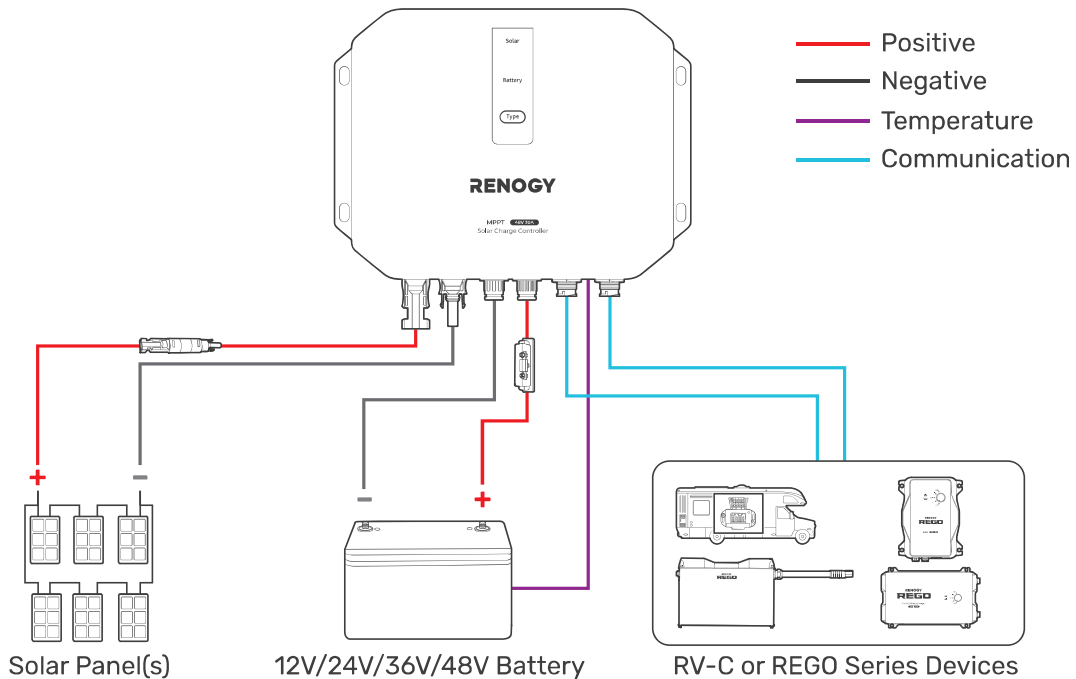

Required Tools & Accessories



Phillips Screwdriver (#2)

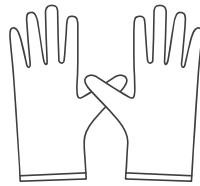

Insulating Gloves



Wire stripper

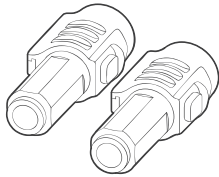

Amphenol Connectors

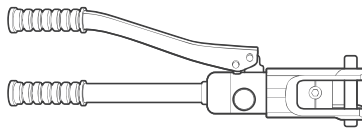

Manual Hydraulic Pliers

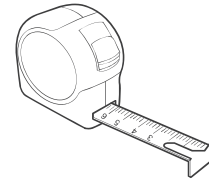

Measuring Tape

 Prior to installing and configuring the charge controller, prepare the recommended tools, components, and accessories.

 You can purchase Amphenol connectors from either renogy.com or arrow.com (with guaranteed quality). Applicable models: C10-791435-1101 (for positive) and C10-791435-1102 (for negative). For details, contact the tech support team at renogy.com/contact-us or the customer service of the respective dealer.

How to Install the Amphenol Connectors?

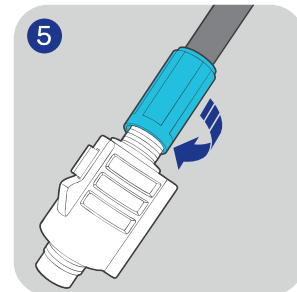
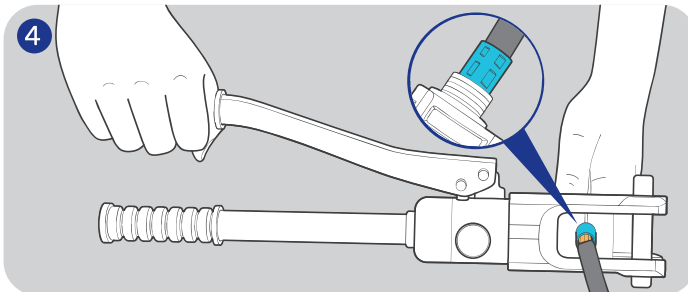
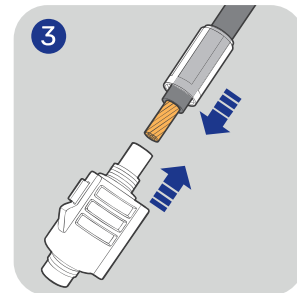
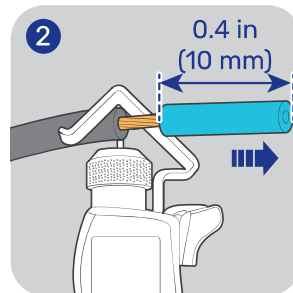

Step 1. Wear Insulating Gloves

To ensure safe and efficient operation of the charge controller and to avoid potential damage or hazards, always follow the installation instructions in the sequence described in this quick guide.

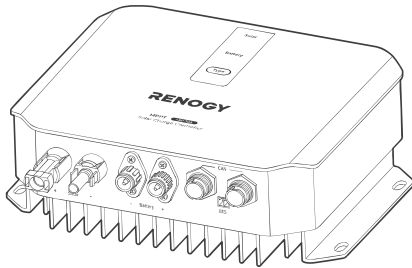

Insulating
Gloves

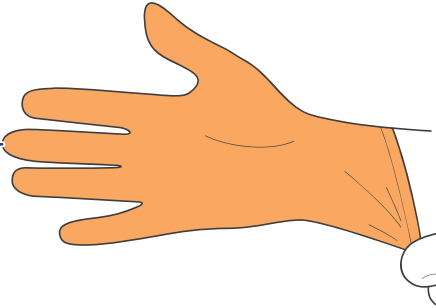

Step 2. Plan a Mounting Site

The charge controller requires adequate clearance for installation, wiring and ventilation. The minimum clearance is provided below. Ventilation is highly recommended if it is mounted in an enclosure. Select a proper mounting site to ensure the charge controller can be safely connected to the battery, and solar panels with the relevant cables.

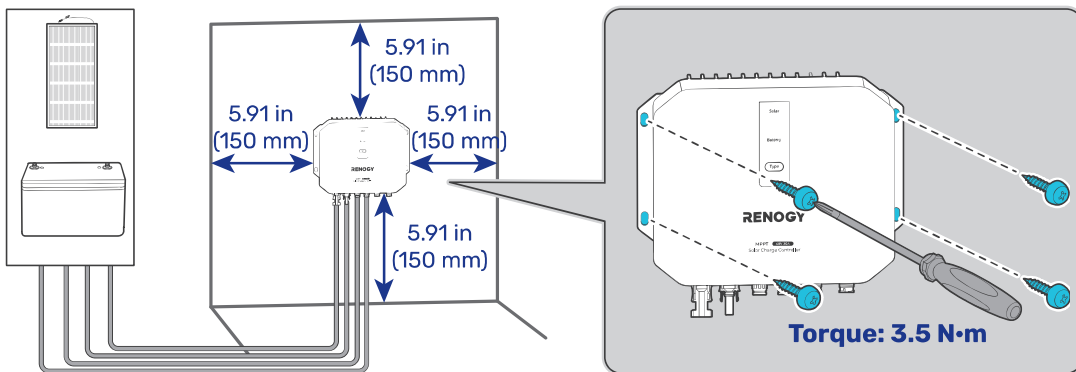

 -31°F to 113°F
-35°C to 45°C  % 0% to 95%



 The charge controller should be installed on a vertical surface protected from direct sunlight.

 The charge controller can be mounted either on a floor or on a wall.

Step 3. Connect the Charge Controller to a Battery

The charge controller can be connected to deep-cycle gel-sealed lead-acid batteries (GEL), flooded lead-acid batteries (FLD), sealed lead-acid batteries (SLD/AGM) or lithium iron phosphate batteries (LI).

Always connect the battery to the charge controller first, and then connect the solar panels to the charge controller. This helps ensure safe and efficient setup.

Recommended Components & Accessories

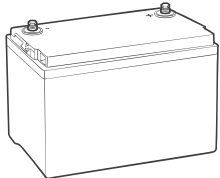

*12V/24V/36V/48V Battery

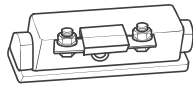

*ANL Fuse (40A) × 1

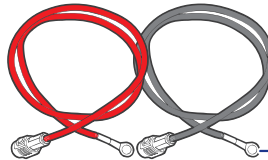

*Battery Adapter Cables (10 AWG) × 2



*Fuse Cable (10 AWG) × 1



Accessories marked with "*" are available on renogy.com.



For installation details, see the user manual of the battery in use.



To ensure optimal system performance, a 10 AWG cable should be no longer than 3 meters. Choose higher gauge cables for longer distances. For details, see the user manual of the charge controller at www.renogy.com/support/downloads.

STEP-1 Install cables on the charge controller

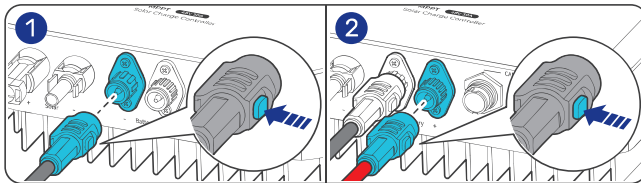

⚠ Negative First!

STEP-2 Install an ANL fuse

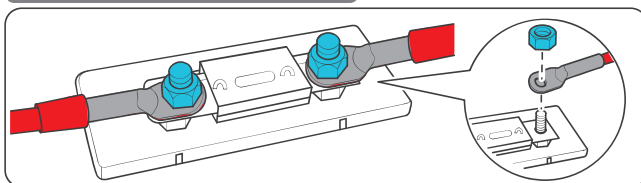

STEP-3 Install the cables on the battery

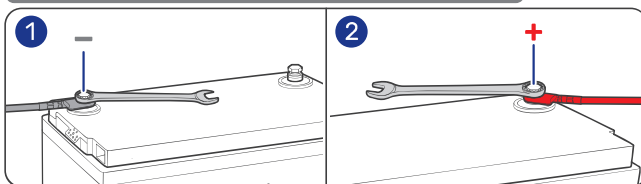

12V/24V/36V/48V Battery

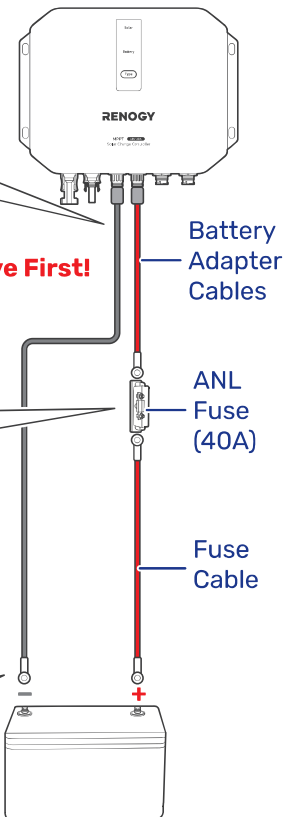

Step 4. Connect the Charge Controller to a Solar Panel

Battery Nominal Voltage	12V	24V	36V	48V
Solar Panel Power	≤440W	≤880W	≤1320W	≤1700W

Recommended Components & Accessories

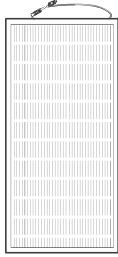

*Solar Panel(s)

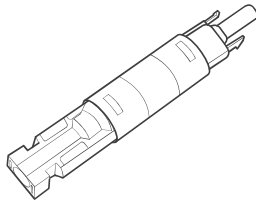

*Solar Panel Fuse

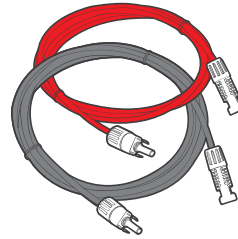

*Solar Panel Extension Cables (10 AWG, Max power) × 2

- ⚠ Accessories marked with "*" are available on renogy.com.
- ⚠ Connecting the charge controller to a solar panel exceeding 150V results in damage to the charge controller.
- ⚠ The appropriate current rating for the solar panel fuse should be determined by multiplying the total amperage of the solar panel array by 1.56.

STEP-1 Install cables on the charge controller

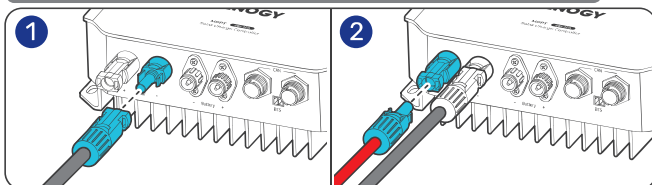

⚠ Negative First!

Solar Panel Extension Cables

STEP-2 Install a solar panel fuse

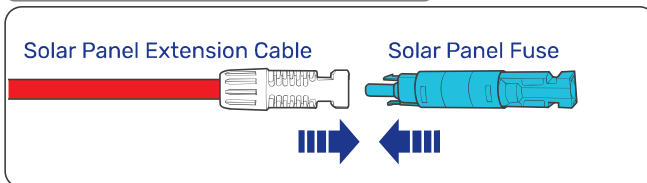

Solar Panel Fuse

STEP-3 Install the cables on the solar panel

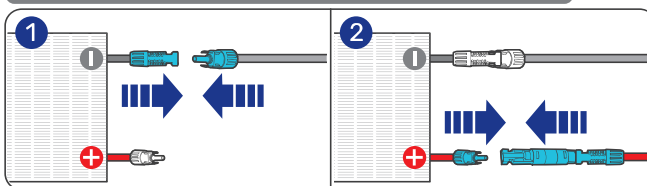

Solar Panel(s)

Step 5. Install a Battery Temperature Sensor

The temperature sensor measures the surrounding temperature of the battery and compensates the floating charge voltage when the battery temperature is low.

 Do not use the temperature sensor on a LiFePO4 (LFP) battery which comes with a battery management system (BMS).

Mount the sensor securely at a suitable location in close proximity to the battery.

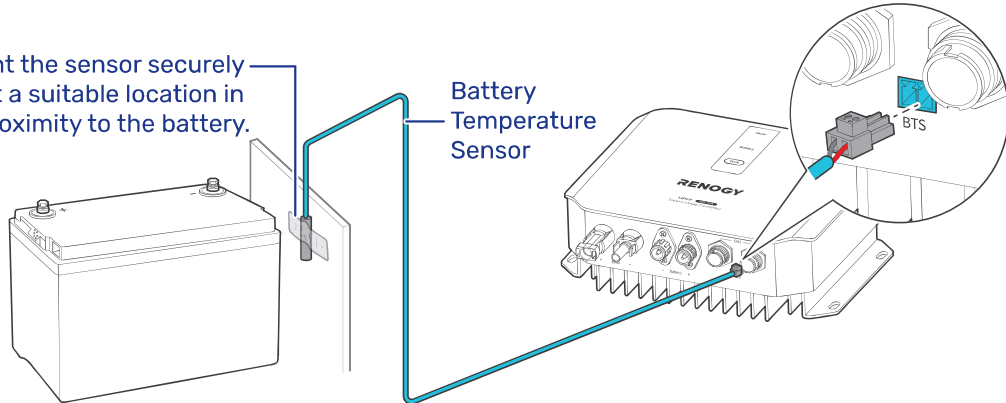

LED Indicators

The charge controller turns on automatically after power on with the LED indicators working in accordance with the relative operational status.

Solar Indicator

Solar **Off**: No solar panel detected

Solar **Solid**: Charging

Solar

Battery

Type

Battery Indicator

Battery **Off**: No battery detected

Battery **Solid**: Fully charged

 Battery **Flash**: Charging

 Battery **Solid**: Overpower protection

 Battery **Solid**: Overvoltage protection

 Battery **Flash**: Overdischarge protection

Set a Battery Type

Upon installing the charge controller, set a correct battery type by using the Battery Type Setting Button.

- For non-lithium batteries, the charge controller can automatically detect their voltage (12V, 24V, 36V or 48V).
- For lithium batteries, the charge controller defaults to a voltage of 12V. If using 24V, 36V, or 48V lithium batteries, you can customize the parameters through Renogy ONE or DC Home. For 48V lithium batteries, you need to select the cell series between 15 Series and 16 Series on the DC Home app. A blue Type indicator denotes a 15 series lithium battery.



It is essential to ensure that the battery type setting is configured correctly to avoid any potential damage to the charge controller because any damage to the charge controller resulting from an incorrect battery type setting voids the warranty.

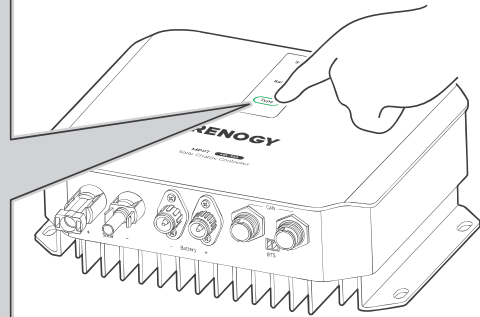
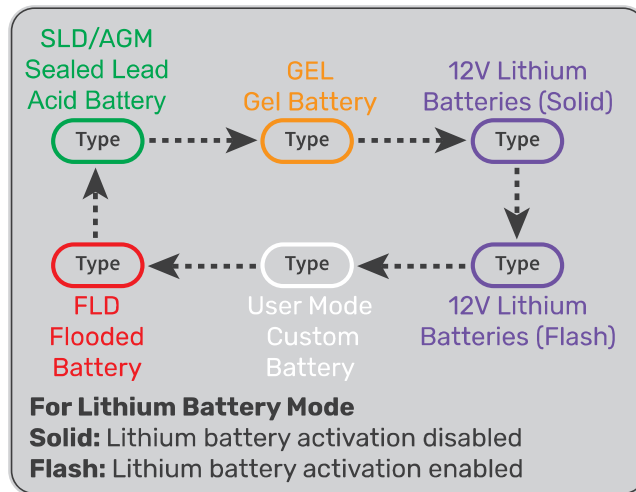

USER Mode

Setting the battery type to User Mode allows you to customize your battery parameters. You can modify the parameters in the DC Home app.

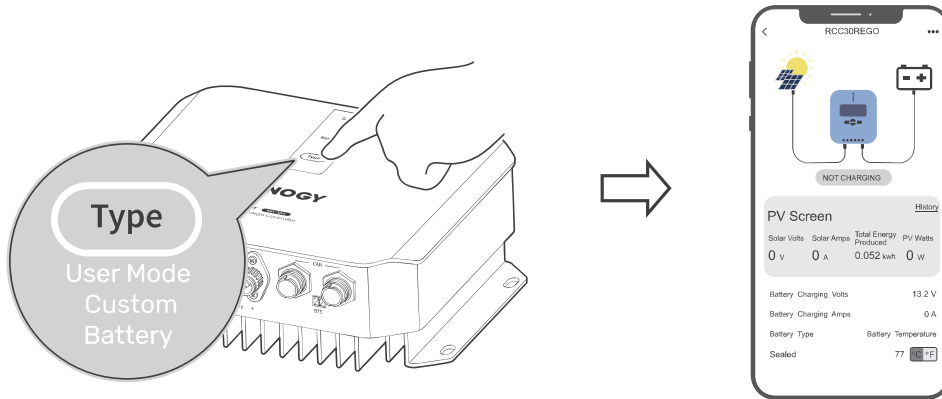

When customizing settings, consult the user manual of the specific battery. If necessary, contact the manufacturer for further assistance.



For detailed parameter settings, see the user manual of the charge controller at renogy.com/support/downloads.

The User Mode is applicable to 24V, 36V, and 48V batteries. For 48V lithium batteries, you need to select the cell series between 15 Series and 16 Series on the DC Home app. A blue Type indicator denotes a 15 series lithium battery.

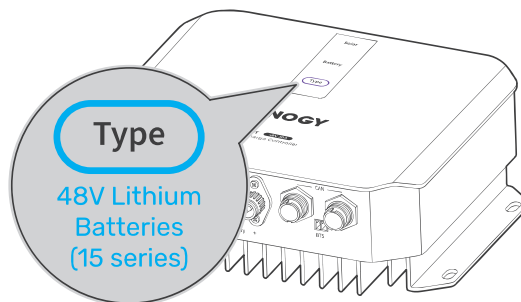

For Lithium Battery Mode

- Solid: Lithium battery activation disabled
- Flash: Lithium battery activation enabled

Monitor the Battery Charger

Download the DC Home app. Login to the app with your account.

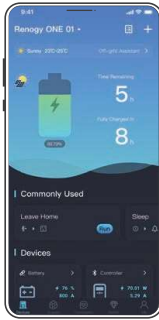

DC Home App



- ⚠ For CAN communication details, see the user manual of the charge controller at renogy.com/support/downloads.
- ⚠ The version of the DC Home app might have been updated. Illustrations in the user manual are for reference only. Follow the instructions based on the current app version.
- ⚠ To ensure optimal system performance, keep the phone or RENOGY ONE within 10 feet (3 m) of the charge controller.
- ⚠ You can receive fault alarms on DC Home and Renogy ONE when the charge controller is faulty. Please login to the DC Home app or Renogy ONE for troubleshooting details.

Short-Range Monitoring via DC Home App

Pair the charge controller with the DC Home app. Monitor and modify the parameters of the charge controller via the app.

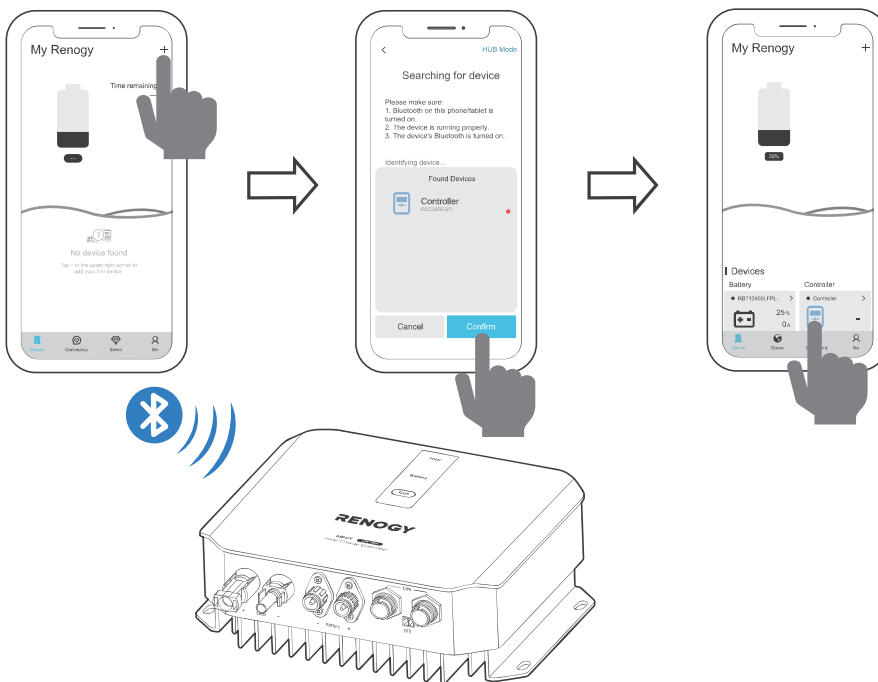

Wireless Long-Range Monitoring

Recommended Components

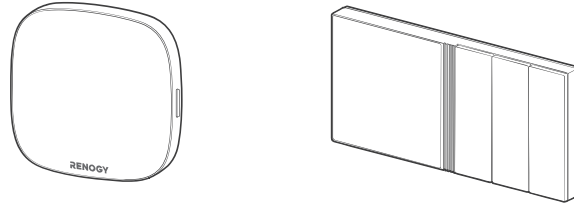

*RENOGY ONE Core or Renogy ONE M1

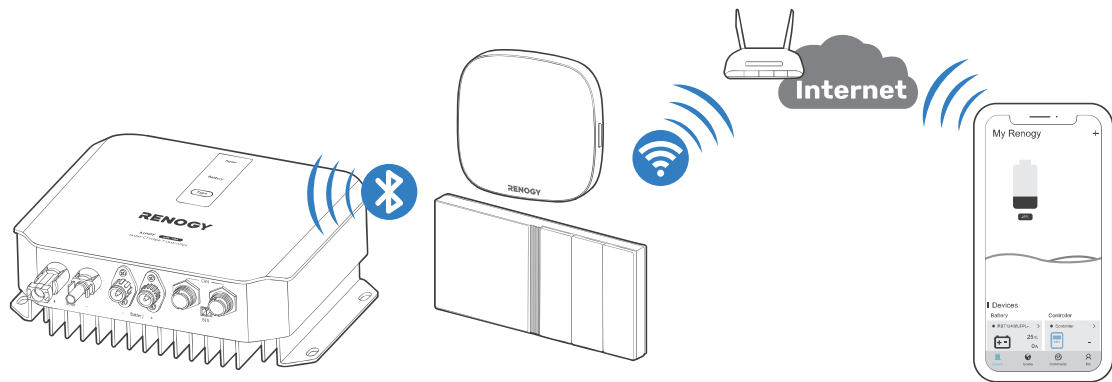

Troubleshooting

You can receive fault alarms on DC Home and Renogy ONE when the charge controller is faulty. Please login to the DC Home app or Renogy ONE for troubleshooting details.

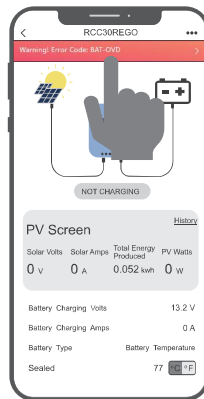

For technical support, contact our technical service through [renogy.com/contact-us](https://www.renogy.com/contact-us).

Important Safety Instructions

General

- Wear proper protective equipment and use insulated tools during installation and operation. Do not wear jewelry or other metal objects when working on or around the charge controller.
- Keep the charge controller out of the reach of children.
- Do not dispose of the charge controller as household waste. Comply with local, state, and federal laws and regulations and use recycling channels as required.
- In case of fire, put out the fire with a FM-200 or CO₂ fire extinguisher.
- Installing the charge controller improperly on a boat may cause damage to components of the boat. Have the devices installed by a qualified electrician.
- Do not expose the charge controller to flammable or harsh chemicals or vapors.
- Clean the charge controller regularly.
- Do not puncture, drop, crush, penetrate, shake, strike, or step on the charge controller.
- Do not open, disassemble, repair, tamper with, or modify the charge controller.
- Connect the negative prior to the positive terminal when connecting any device.
- It is recommended that all cables should not exceed 10 meters because excessively long cables result in a voltage drop.
- The cable specifications listed in the quick guide account for critical, less than 3% voltage drop and may not account for all configurations.

Charge Controller Safety

- Install the charge controller on a vertical surface - protected from direct sunlight, high temperatures, and water. Make sure there is good ventilation.
- Keep the charge controller away from heating equipment.
- Do not insert foreign objects into the charge controller.
- Confirm the polarities of the devices before connection. A reverse polarity contact can result in damage to the charge controller, thus voiding the warranty.
- Do not touch the connector contacts while the charge controller are in operation.
- Disconnect all connectors from the charge controller before maintenance or cleaning.

Battery Safety

- Do not use batteries if there is any damage.
- Do not touch the exposed electrolyte or powder if the battery is damaged.
- Risk of explosion! Never install the charge controller in a sealed enclosure with flooded batteries! Do not install the charge controller in a confined area where battery gases can accumulate.
- Prior to installing the charge controller, ensure all battery groups are installed properly.

Solar Panel Safety

- Do not use the solar panel(s) if there is any damage.
- Prior to connecting the charge controller to the solar panel(s), shade the solar panel(s).
- Always connect the charge controller to the battery first before connecting it to the solar panel. This prevents damage caused by open-circuit voltage from the solar panel.

Renogy Support

To discuss inaccuracies or omissions in this quick guide or user manual, visit or contact us at:

[G | renogy.com/support/downloads](https://renogy.com/support/downloads)

 contentservice@renogy.com

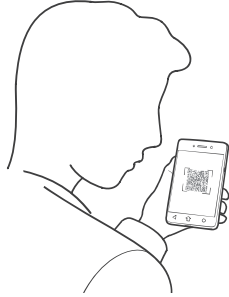

Questionnaire Investigation



To explore more possibilities of solar systems, visit Renogy Learning Center at:

[G | renogy.com/learning-center](https://renogy.com/learning-center)

For technical questions about your product in the U.S., contact the Renogy technical support team through:

[G | renogy.com/contact-us](https://renogy.com/contact-us)

 1(909)2877111

For technical support outside the U.S., visit the local website below:

Canada |  | ca.renogy.com

China |  | www.renogy.cn

Australia |  | au.renogy.com

Japan |  | renogy.jp

South Korea |  | kr.renogy.com

Germany |  | de.renogy.com

United Kingdom |  | uk.renogy.com

Other Europe |  | eu.renogy.com

FCC Statement

This device complies with Part 15 of the FCC Rules. Operation is subject to the following two conditions:

- (1) This device may not cause harmful interference.
- (2) This device must accept any interference received, including interference that may cause undesired operation.

Any Changes or modifications not expressly approved by the party responsible for compliance could void the user's authority to operate the equipment.

This equipment has been tested and found to comply with the limits for a Class B digital device, pursuant to Part 15 of the FCC Rules. These limits are designed to provide reasonable protection against harmful interference in a residential installation. This equipment generates, uses and can radiate radio frequency energy and, if not installed and used in accordance with the instructions, may cause harmful interference to radio communications. However, there is no guarantee that interference will not occur in a particular installation. If this equipment does cause harmful interference to radio or television reception, which can be determined by turning the equipment off and on, the user is encouraged to try to correct the interference by one or more of the following measures:

- (1) Reorient or relocate the receiving antenna.
- (2) Increase the separation between the equipment and receiver.
- (3) Connect the equipment into an outlet on a circuit different from that to which the receiver is connected.
- (4) Consult the dealer or an experienced radio / TV technician for help.

FCC Radiation Exposure Statement

This equipment complies with FCC radiation exposure limits set forth for an uncontrolled environment. This equipment should be installed and operated with minimum distance 20cm between the radiator & your body.

ISED Warning

This device complies with Innovation, Science and Economic Development Canada License exempt RSS standard(s). Operation is subject to the following two conditions: (1) this device may not cause harmful interference, and (2) this device must accept any interference received, including interference that may cause undesired operation of the device.

Le présent appareil est conforme aux CNR d'Innovation, Sciences et Développement économique Canada applicables aux appareils radio exempts de licence. L'exploitation est autorisée aux deux conditions suivantes :

- (1) l'appareil ne doit pas produire de brouillage, et
- (2) l'utilisateur de l'appareil doit accepter tout brouillage radioélectrique subi, même si le brouillage est susceptible d'en compromettre le fonctionnement.

The device is compliance with RF exposure guidelines, users can obtain Canadian information on RF exposure and compliance. The minimum distance from body to use the device is 20cm.

Le présent appareil est conforme Après examen de ce matériel aux conformité ou aux limites d'intensité de champ RF, les utilisateurs peuvent sur l'exposition aux radiofréquences et conformité d'acquérir les informations correspondantes. La distance minimale du corps à utiliser le dispositif est de 20cm.

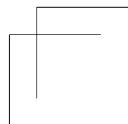
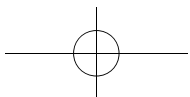
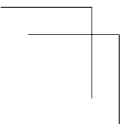
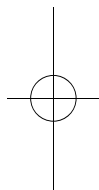
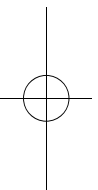
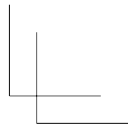
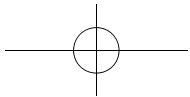
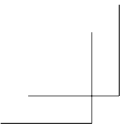



Renogy Empowered

Renogy aims to empower people around the world through education and distribution of DIY-friendly renewable energy solutions.

We intend to be a driving force for sustainable living and energy independence.

In support of this effort, our range of solar products makes it possible for you to minimize your carbon footprint by reducing the need for grid power.



Live Sustainably with Renogy

Did you know? In a given month, a 1 kW solar energy system will...



Save 170 pounds of coal from being burned



Save 300 pounds of CO₂ from being released into the atmosphere



Save 105 gallons of water from being consumed



Renogy Power PLUS

Renogy Power Plus allows you to stay in the loop with upcoming solar energy innovations, share your experiences with your solar energy journey, and connect with like-minded people who are changing the world in the Renogy Power Plus community.



@Renogy Solar



@renogyofficial



@Renogy

Renogy reserves the right to change the contents of this manual without notice.

Manufacturer: RENOGY New Energy Co.,Ltd
Address: No.66, East Ningbo Road Room 624-625
Taicang German Overseas Students Pioneer Park
JiangSu 215000 CN



eVatmaster Consulting GmbH
Battinastr. 30
60325 Frankfurt am Main, Germany
contact@evatmaster.com

Manufacturer: RENOGY New Energy Co.,Ltd
Address: No.66, East Ningbo Road Room 624-625
Taicang German Overseas Students Pioneer Park
JiangSu 215000 CN



EVATOST CONSULTING LTD
Suite 11, First Floor, Moy Road Business
Centre, Taffs Well, Cardiff, Wales, CF15 7QR
contact@evatmaster.com



RENOGY.COM

 **RENOGY**