

# Renogy

## DC-DC Battery Charger

12V | 20A/40A

RBC20D1U/RBC40D1U



Find Your Energy Freedom™

VERSION A0

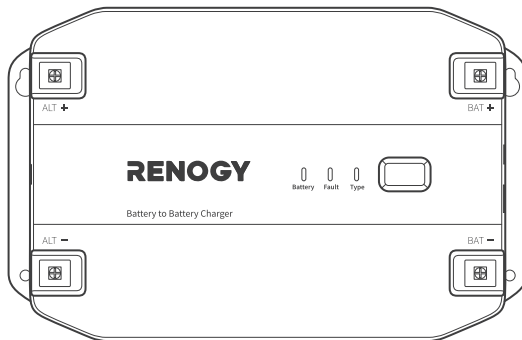

### QUICK GUIDE



## Before Getting Started

The quick guide provides important operation and maintenance instructions for Renogy 12V 20A/40A DC-DC Battery Charger (hereinafter referred to as battery charger).

Read the quick guide carefully before operation and save it for future reference. Failure to observe the instructions or precautions in the quick guide can result in electrical shock, serious injury, or death, or can damage the battery charger, potentially rendering it inoperable.

## Online Manual

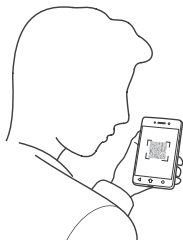

Quick Guide



User Manual



## Table of Contents

<b>What's In the Box?</b> .....	<b>1</b>
<b>Dimensions</b> .....	<b>2</b>
<b>Get to Know Renogy Battery Charger</b> .....	<b>3</b>
<b>System Setup</b> .....	<b>5</b>
<b>Required Tools</b> .....	<b>6</b>
<b>Step 1. Wear Insulating Gloves</b> .....	<b>6</b>
<b>Step 2. Plan a Mounting Site</b> .....	<b>7</b>
<b>Step 3. Connect the Battery Charger to an Auxiliary Battery</b> .....	<b>8</b>
<b>Step 4. Connect the Battery Charger to a Starter Battery</b> .....	<b>10</b>
<b>Step 5. Install a IGN Signal Wire (for Smart DC Alternator)</b> .....	<b>12</b>
<b>Step 6. Install a Battery Temperature Sensor</b> .....	<b>13</b>
<b>LED Indicators</b> .....	<b>14</b>
<b>Set a Battery Type</b> .....	<b>16</b>
<b>USER Mode</b> .....	<b>17</b>

<b>Monitor the Battery Charger</b> .....	<b>18</b>
Short-Range Monitoring via DC Home App .....	20
Wireless Long-Range Monitoring.....	21
<b>Important Safety Instructions</b> .....	<b>22</b>
<b>Renogy Support</b> .....	<b>24</b>
<b>FCC Statement</b> .....	<b>26</b>
<b>FCC Radiation Exposure Statement</b> .....	<b>27</b>
<b>Disclaimer</b> .....	<b>27</b>

## What's In the Box?

Renogy 12V 20A/40A  
DC-DC Battery Charger x 1

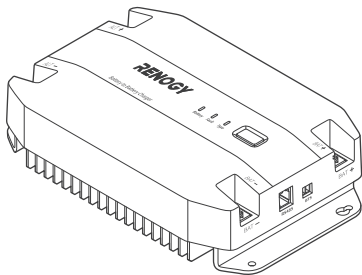

Quick Guide x 1

ST4\*16 mm



Mounting Screws x 4

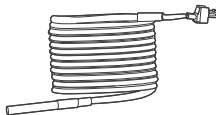

Battery Temperature  
Sensor (2 m) x 1

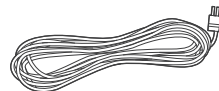

IGN Signal Wire  
(3 m) x 1



Make sure that all accessories are complete and free of any signs of damage.



The accessories and product manual listed are crucial for the installation, excluding warranty information and any additional items. Please note that the package contents may vary depending on the specific product model.

## Dimensions

### 20A DC-DC Battery Charger (RBC20D1U)

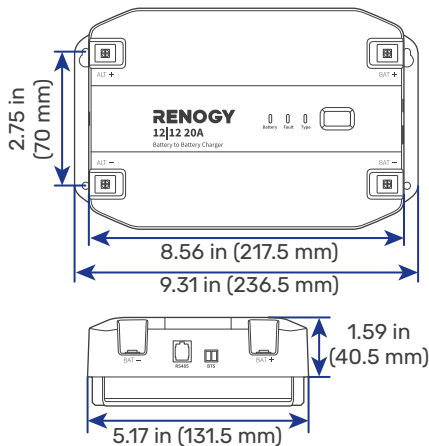

### 40A DC-DC Battery Charger (RBC40D1U)

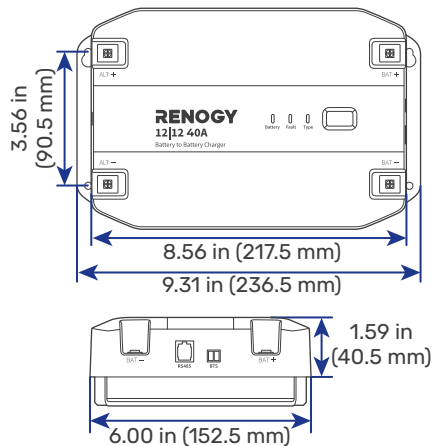

Dimension tolerance:  $\pm 0.2$  in (0.5 mm)

## Get to Know Renogy Battery Charger

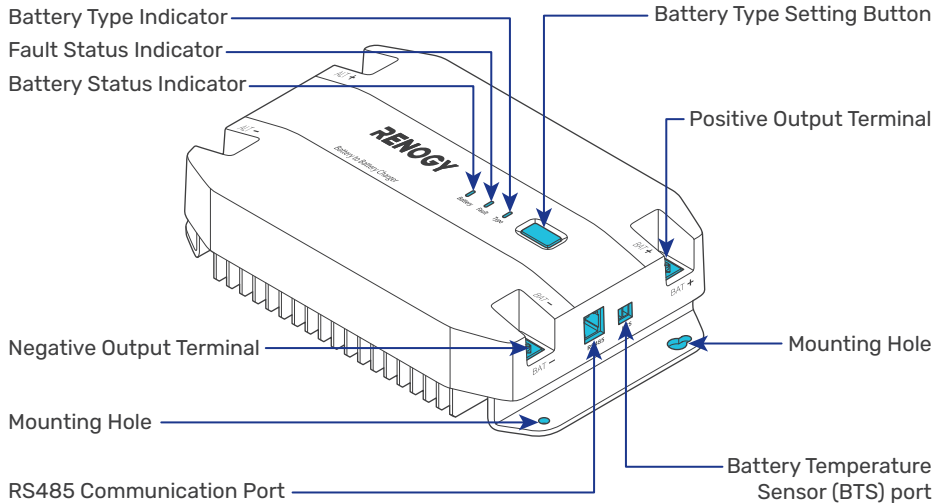



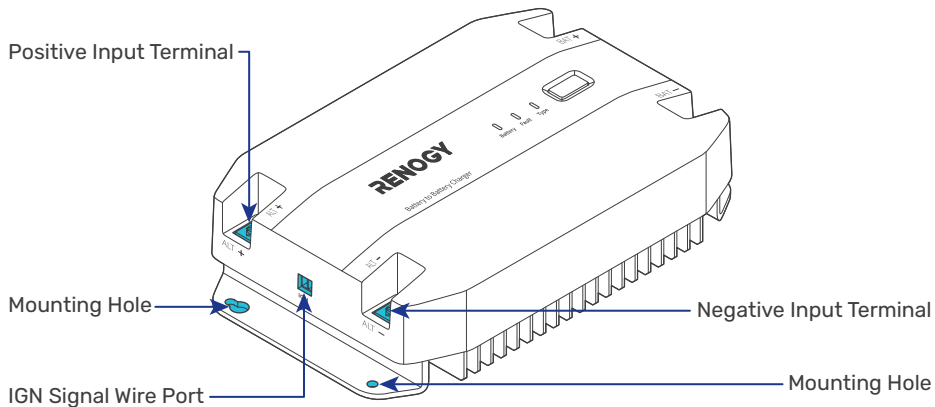

The Battery Temperature Sensor (BTS) port can only be used with lead-acid batteries.

## System Setup

— Positive — Negative — Temperature — Communication — IGN Signal

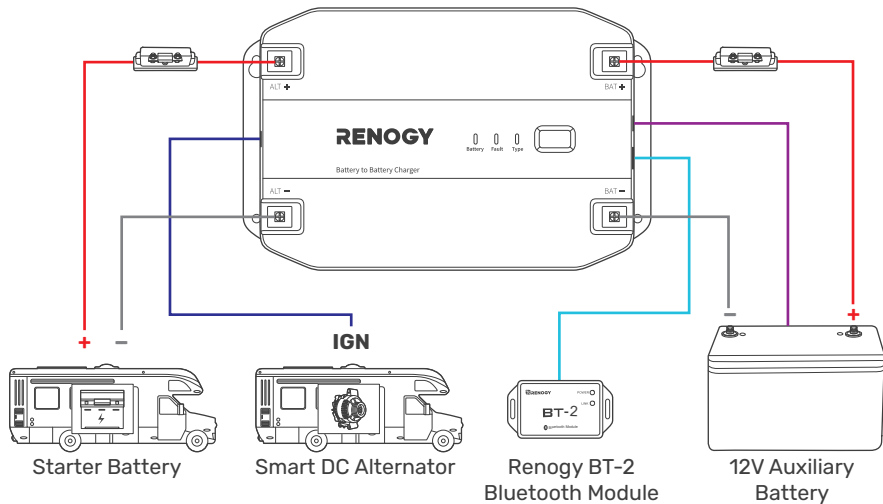

## Required Tools



Phillips  
Screwdriver (#1)

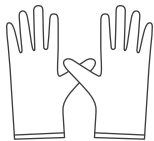

Insulating Gloves

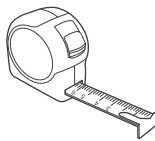

Measuring Tape



Insulation Tape



Prior to installing and configuring the battery charger, prepare the recommended tools, components, and accessories.

## Step 1. Wear Insulating Gloves

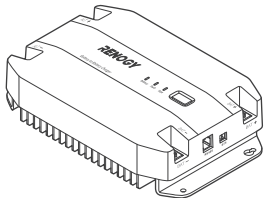

Insulating Gloves

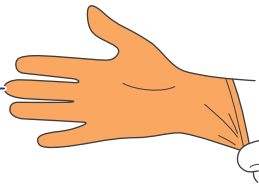

## Step 2. Plan a Mounting Site

The battery charger requires adequate clearance for installation, wiring, and ventilation. The minimum clearance is provided below.

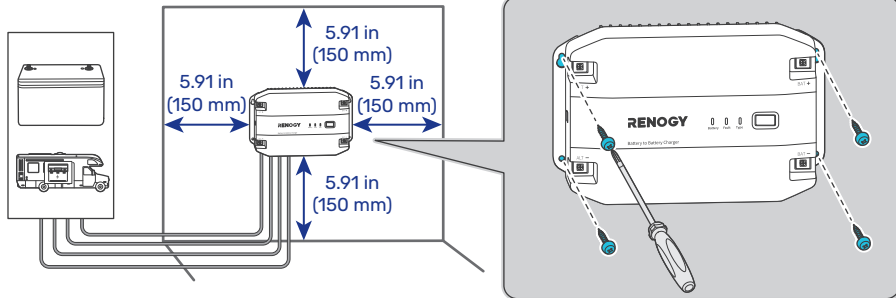

-40°F to 185°F  
-40°C to 85°C



0% to 95%



KEEP DRY



FRAGILE



VENTILATION



INDOOR



The battery charger should be installed on a flat surface protected from direct sunlight.

### Step 3. Connect the Battery Charger to an Auxiliary Battery

The battery charger can only be connected to deep-cycle gel-sealed lead-acid batteries (GEL), flooded lead-acid batteries (FLD), sealed lead-acid batteries (SLD/AGM), or lithium iron phosphate batteries (LI).

#### Recommended Components & Accessories

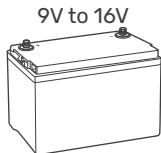

\*12V Battery

RBC20D1U: 30A  
RBC40D1U: 40A

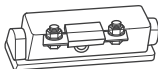

\*ANL Fuse x 1

RBC20D1U: 10 AWG  
RBC40D1U: 8 AWG



Battery Adapter Cables x 2

RBC20D1U: 10 AWG  
RBC40D1U: 8 AWG



Fuse Cable x 1



Accessories marked with "\*" are available on [renogy.com](http://renogy.com).



For installation details, see the user manual of the battery in use.



To ensure optimal system performance, a 10 AWG/8 AWG cable should be no longer than 3 meters. Choose higher gauge cables for longer distances. For details, see the user manual of the battery charger at [www.renogy.com/support/downloads](http://www.renogy.com/support/downloads).

### STEP-1 Install cables on the battery charger

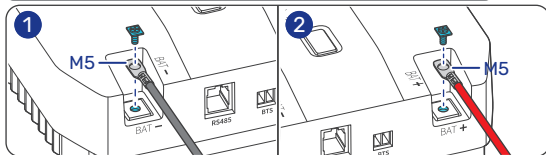

### STEP-2 Install an ANL fuse

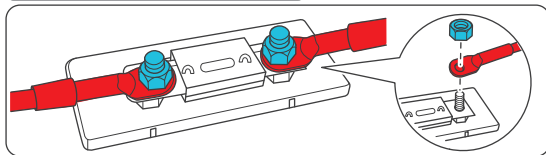

### STEP-3 Install the cables on the battery

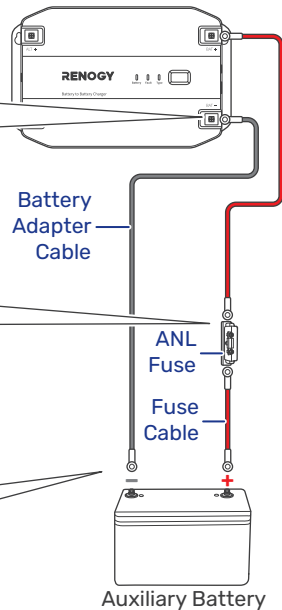
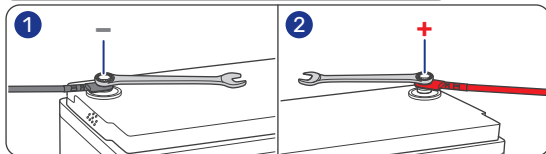

## Step 4. Connect the Battery Charger to a Starter Battery

Before installing the charger, consult your vehicle's user manual or contact the vehicle manufacturer to ensure that the alternator power does not exceed 720W with the output current within the range of 75A to 100A.

### Recommended Components & Accessories

RBC20D1U: 40A  
RBC40D1U: 80A

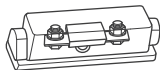

\*ANL Fuse x 1

RBC20D1U: 8 AWG  
RBC40D1U: 6 AWG



Battery Adapter Cables x 2

RBC20D1U: 8 AWG  
RBC40D1U: 6 AWG



Fuse Cable x 1



Accessories marked with "\*" are available on [renogy.com](https://www.renogy.com).



The starter battery stops charging the auxiliary battery when the starter battery voltage drops below 12.7V.

### STEP-1 Install cables on the battery charger

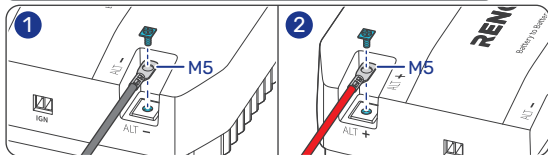

### STEP-2 Install an ANL fuse

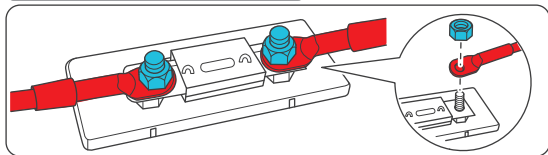

### STEP-3 Install the cables on the RV starter battery

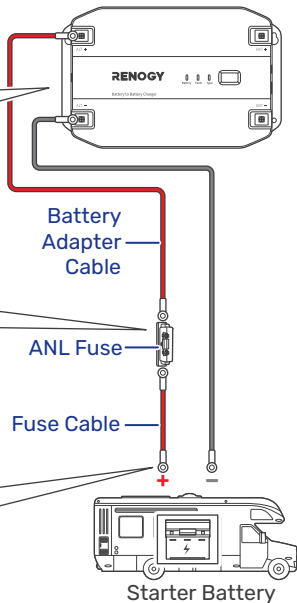
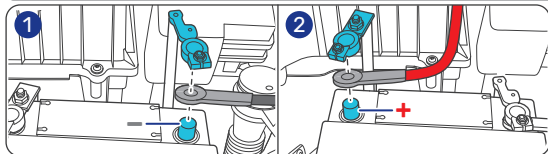



## Step 5. Install a IGN Signal Wire (for Smart DC Alternator)

IGN signal wiring is required for smart alternators only. For how to distinguish a smart alternator from a traditional one, see the user manual of the battery charger. If the DC alternator of the vehicle is a smart alternator, insert the IGN Signal Wire connector into IGN signal wire port, and then connect the other end to the smart alternator's ignition signal port.



Consult the RV supplier for wiring details.

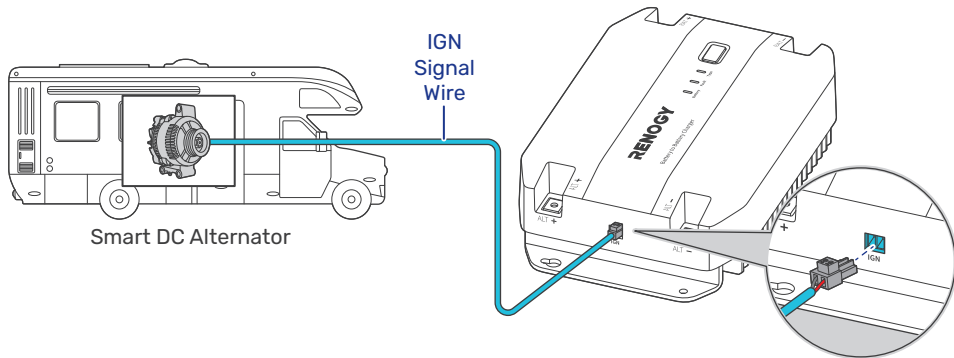

## Step 6. Install a Battery Temperature Sensor

The temperature sensor measures the surrounding temperature of the battery and compensates the floating charge voltage when the battery temperature is low.



Do not use the temperature sensor on a LiFePO4 (LFP) battery which comes with a battery management system (BMS).

Mount the sensor securely  
at a suitable location in  
close proximity to the battery.

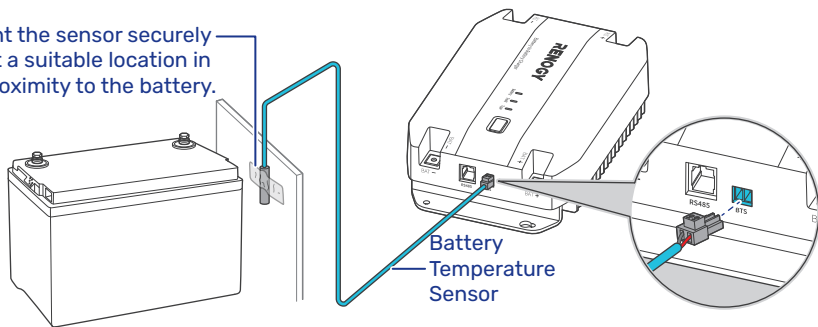

## LED Indicators

The battery charger turns on automatically after power on with the LED indicators working in accordance with the relative operating status.

### Battery Status Indicator

**Solid:** The battery charger is in standby mode\*, or the auxiliary battery is fully charged.

**Flash:** Charging the auxiliary battery

Battery

Fault

Type

### Battery Type Indicator

**Solid:** SLD/AGM

**Solid:** GEL

**Solid:** LI (lithium battery activation disabled)

**Solid:** LI (lithium battery activation enabled)

**Solid:** User Mode

**Solid:** FLD

### Fault Status Indicator

**Off:** No fault

**Solid:** Short-circuit protection on auxiliary battery or starter battery

**Slow flash:** Reverse contact protection on starter battery

**Solid:** Overtemperature protection on auxiliary battery

**Slow flash:** Overtemperature protection on battery charger

**Fast flash:** Overvoltage protection on auxiliary battery



**Jumping flash:** Overdischarge shutdown protection on auxiliary battery

**Standby Mode\*:** The battery charger is only connected to the auxiliary battery, and the auxiliary battery voltage is greater than 12V.

## Graphic indications of ON and OFF

<b>LED ON</b>		<b>LED OFF</b>	
---------------	---	----------------	---

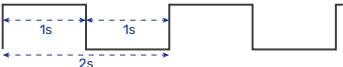
## Graphic expression of Solid, Slow Flash, Fast Flash, and Jumping Flash

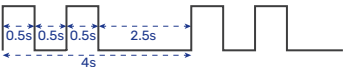
LED Pattern	Description	Graphic Expression
Solid	The LED remains continuously illuminated without any variation.	
Slow Flash	In this mode, the LED alternates between being on and off at a relatively slow and regular interval of 1s.	
Fast Flash	In this mode, the LED alternates between being on and off at a relatively fast and regular interval of 0.1s.	
Jumping Flash	In this mode, the LED alternates between brief 0.5s on-off cycles followed by a longer 2.5s off period.	

## Set a Battery Type

Upon installing the battery charger, set a correct battery type by using the Battery Type Setting Button.



It is essential to ensure that the battery type setting is configured correctly to avoid any potential damage to the battery charger because any damage to the battery charger resulting from an incorrect battery type setting voids the warranty.

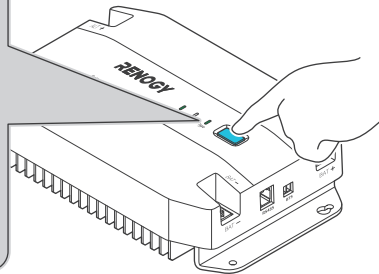
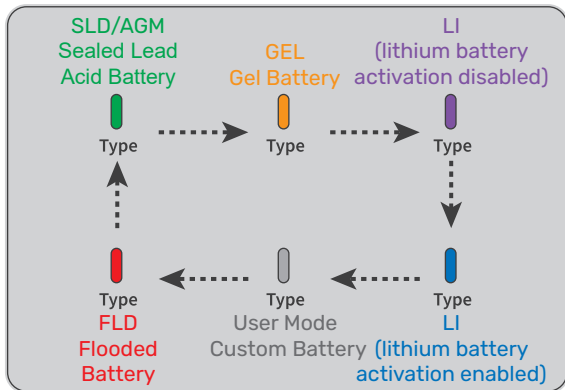

## USER Mode

Setting the battery type to User Mode allows you to customize your battery parameters. You can modify the parameters in the DC Home app.

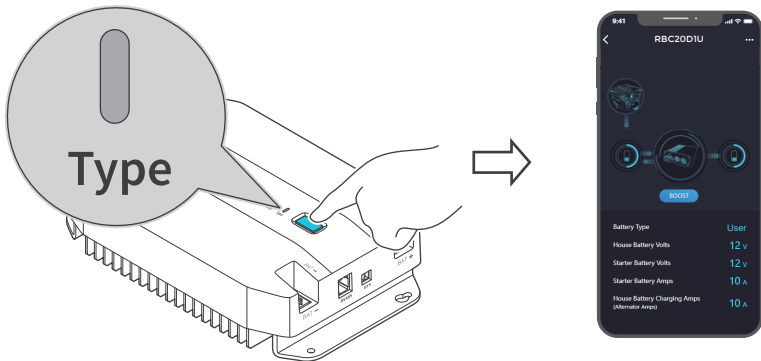

When customizing settings, consult the user manual provided by the battery manufacturer. If necessary, contact the manufacturer for further assistance.



For detailed parameter settings, see the user manual of the battery charger at [renogy.com/support/downloads](https://renogy.com/support/downloads).

## Monitor the Battery Charger

### Recommended Components

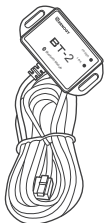

\*Renogy BT-2 Bluetooth Module

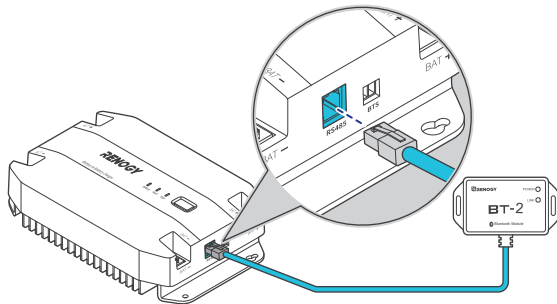

Accessories marked with "\*" are available on [renogy.com](https://www.renogy.com).



Before adding this product to the DC Home app or Renogy ONE, please ensure that both the app version and the firmware version of Renogy ONE have been updated to the latest version.



You can customize the charging current through the DC Home app.

Download the DC Home app. Login to the app with your account.

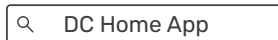
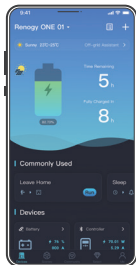

The version of the DC Home app might have been updated. Illustrations in the user manual are for reference only. Follow the instructions based on the current app version.



To ensure optimal system performance, keep the phone or RENOGY ONE within 10 feet (3 m) of the battery charger.



You can receive fault alarms on DC Home and Renogy ONE when the battery charger is faulty. Please login to the DC Home app or Renogy ONE for troubleshooting details.



## Short-Range Monitoring via DC Home App

Pair the battery charger with the DC Home app. Monitor and modify the parameters of the battery charger via the app.

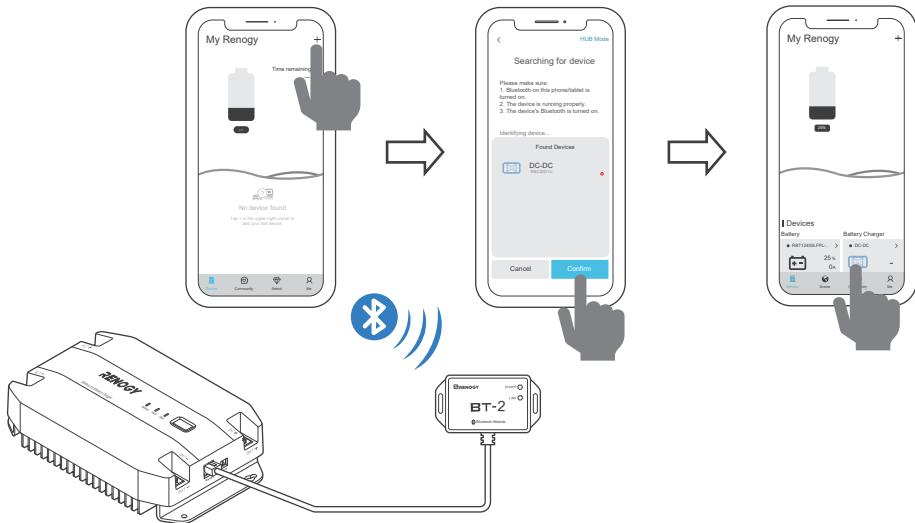

## Wireless Long-Range Monitoring

### Recommended Components



\*RENogy ONE Core

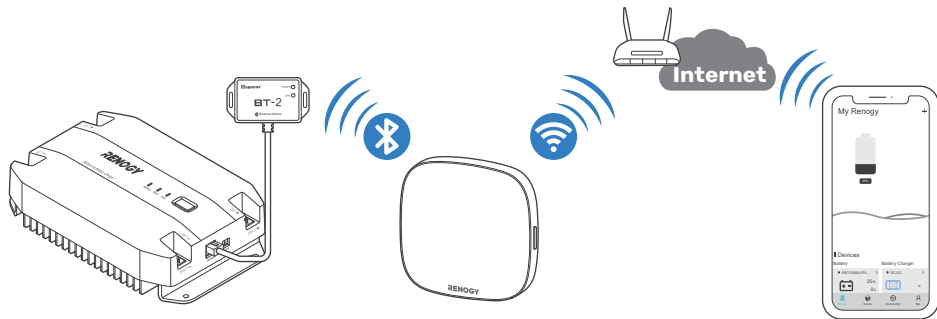

## Important Safety Instructions

### ■ General

- Wear proper protective equipment and use insulated tools during installation and operation. Do not wear jewelry or other metal objects when working on or around the battery charger.
- Keep the battery charger out of the reach of children.
- Do not dispose of the battery charger as household waste. Comply with local, state, and federal laws and regulations and use recycling channels as required.
- In case of fire, put out the fire with a FM-200 or CO<sub>2</sub> fire extinguisher.
- Installing the battery charger improperly on a boat may cause damage to components of the boat. Have the devices installed by a qualified electrician.
- Do not expose the battery charger to flammable or harsh chemicals or vapors.
- Clean the battery charger regularly.
- Do not puncture, drop, crush, penetrate, shake, strike, or step on the battery charger.
- Do not open, disassemble, repair, tamper with, or modify the battery charger.
- Connect the negative prior to the positive terminal when connecting any device.
- It is recommended that all cables should not exceed 10 meters because excessively long cables result in a voltage drop.
- The cable specifications listed in the quick guide account for critical, less than 3% voltage drop and may not account for all configurations.

## ■ Battery Charger Safety

- Install the battery charger on a vertical surface - protected from direct sunlight, high temperatures, and water. Make sure there is good ventilation.
- Keep the battery charger away from heating equipment.
- Do not insert foreign objects into the battery charger.
- Confirm the polarities of the devices before connection. A reverse polarity contact can result in damage to the battery charger, thus voiding the warranty.
- Do not touch the connector contacts while the battery charger is in operation.
- Disconnect all connectors from the battery charger before maintenance or cleaning.

## ■ Battery Safety

- Do not use batteries if there is any damage.
- Do not touch the exposed electrolyte or powder if the battery is damaged.
- Risk of explosion! Never install the battery charger in a sealed enclosure with flooded batteries! Do not install the battery charger in a confined area where battery gases can accumulate.
- Prior to installing the battery charger, ensure all battery groups are installed properly.

## Renogy Support

To discuss inaccuracies or omissions in this quick guide or user manual, visit or contact us at:

 | [renogy.com/support/downloads](https://renogy.com/support/downloads)



→ [contentservice@renogy.com](mailto:contentservice@renogy.com)

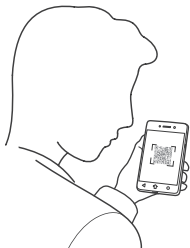

Questionnaire Investigation



To explore more possibilities of solar systems, visit Renogy Learning Center at:

 | [renogy.com/learning-center](https://renogy.com/learning-center)



**For technical questions about your product in the U.S.,** contact the Renogy technical support team through:

 | [renogy.com/contact-us](https://renogy.com/contact-us)



1(909)2877111

**For technical support outside the U.S.,** visit the local website below:

**Canada** |  | [ca.renogy.com](https://ca.renogy.com)

**Australia** |  | [au.renogy.com](https://au.renogy.com)

**South Korea** |  | [kr.renogy.com](https://kr.renogy.com)

**United Kingdom** |  | [uk.renogy.com](https://uk.renogy.com)

**China** |  | [www.renogy.cn](https://www.renogy.cn)

**Japan** |  | [renogy.jp](https://renogy.jp)

**Germany** |  | [de.renogy.com](https://de.renogy.com)

**Other Europe** |  | [eu.renogy.com](https://eu.renogy.com)

## FCC Statement

This device complies with Part 15 of the FCC Rules. Operation is subject to the following two conditions:

- (1) This device may not cause harmful interference.
- (2) This device must accept any interference received, including interference that may cause undesired operation.

Any Changes or modifications not expressly approved by the party responsible for compliance could void the user's authority to operate the equipment.

This equipment has been tested and found to comply with the limits for a Class B digital device, pursuant to Part 15 of the FCC Rules. These limits are designed to provide reasonable protection against harmful interference in a residential installation. This equipment generates, uses and can radiate radio frequency energy and, if not installed and used in accordance with the instructions, may cause harmful interference to radio communications. However, there is no guarantee that interference will not occur in a particular installation. If this equipment does cause harmful interference to radio or television reception, which can be determined by turning the equipment off and on, the user is encouraged to try to correct the interference by one or more of the following measures:

- (1) Reorient or relocate the receiving antenna.
- (2) Increase the separation between the equipment and receiver.
- (3) Connect the equipment into an outlet on a circuit different from that to which the receiver is connected.
- (4) Consult the dealer or an experienced radio/TV technician for help.

## FCC Radiation Exposure Statement

This equipment complies with FCC radiation exposure limits set forth for an uncontrolled environment. This equipment should be installed and operated with minimum distance 20cm between the radiator & your body.

## Disclaimer

Renogy 12V 20A/40A DC-DC Battery Charger Quick Guide © 2023 Renogy. All rights reserved.

**RENOGY** and **RENOGY** are registered trademarks of Renogy.

- All information in the quick guide is subject to copyright and other intellectual property rights of Renogy and its licensors. The quick guide may not be modified, reproduced, or copied, in whole or in part, without the prior written permissions of Renogy and its licensors.
- The registered trademarks in the quick guide are the property of Renogy. The unauthorized use of the trademarks is strictly prohibited.
- Renogy ensures the accuracy, sufficiency, and the applicability of information in the quick guide at the time of printing due to continual product improvements that may occur.



- Renogy assumes no responsibility or liability for personal and property losses, whether directly and indirectly, caused by the user's failure to install and use the product in compliance with the quick guide.
- Renogy is not responsible or liable for any failure, damage, or injury resulting from repair attempts by unqualified personnel, improper installation, and unsuitable operation.
- The illustrations in the quick guide are for demonstration purposes only. Details may appear slightly different depending on product revision and market region.
- Renogy reserves the right to change the information in the quick guide without notice. For the latest quick guide, visit [renogy.com](https://www.renogy.com).







## Renogy Power PLUS

Renogy Power Plus allows you to stay in the loop with upcoming solar energy innovations, share your experiences with your solar energy journey, and connect with like-minded people who are changing the world in the Renogy Power Plus community.



@Renogy Solar



@renogyofficial



@Renogy

Renogy reserves the right to change the contents of this quick guide without notice.

Manufacturer: RENOGY New Energy Co.,Ltd

Address: No.66, East Ningbo Road Room 624-625

Taicang German Overseas Students Pioneer Park  
JiangSu 215000 CN



eVatmaster Consulting GmbH  
Battinastr. 30  
60325 Frankfurt am Main, Germany  
contact@evatmaster.com

Manufacturer: RENOGY New Energy Co.,Ltd

Address: No.66, East Ningbo Road Room 624-625

Taicang German Overseas Students Pioneer Park  
JiangSu 215000 CN



EVATOST CONSULTING LTD  
Suite 11, First Floor, Moy Road Business  
Centre, Taffs Well, Cardiff, Wales, CF15 7QR  
contact@evatmaster.com

RENOGY.COM

 **RENOGY**