

WiiM



WiiM Hi-Res Audio Streamer

Model: WiiM Mini

CONTENTS

1. INTRODUCTION.....	3
2. WHAT'S IN THE BOX.....	3
3. SPEC.....	3
4. CONTROLS AND LIGHTS.....	5
5. HOW TO SET UP.....	6
5.1 CONNECT THE AUDIO CABLE.....	6
5.2 SETUP SYSTEM.....	7
5.3 FILL YOUR HOME WITH SOUND.....	8
6. VOICE CONTROL.....	8
6.1 WORKS WITH ALEXA.....	8
6.2 WORKS WITH Siri.....	8
7 CONTROL VIA YOUR FAVORITE APP.....	9
7.1 Spotify Connect.....	9
7.3 Tidal Connect.....	10
8 ALL MUSIC IN ONE APP.....	11
9.1 Linkplay MULTI-ROOM/STEREO PAIRING.....	11
9.2 AVS MULTI-ROOM.....	11
10 CONNECTING VIA AUX IN.....	12
11 CONNECTING VIA AUX /SPDIF/BT OUT.....	12
11.1 CONNECTING VIA SPDIF/AUX OUT.....	12
11.2 CONNECTING VIA BT OUT.....	12
12 STREAM AUDIO WITH BLUETOOTH.....	13
13 ADVANCED FEATURES.....	13
13.1 UPDATE THE SPEAKER.....	13
13.2 DISABLE/ENABLE WI-Fi.....	13
14 FAQ.....	13
IMPORTANT SAFETY INSTRUCTIONS.....	14
CE/FCC Statements.....	15

1. INTRODUCTION

Our goal at WiiM is to provide you with simplest, affordable, Hi-Fi, lossless audio systems. With our patented audio streaming solution built into all our high-quality products and App, you will have the ease of playing music throughout your home. All our products are developed with the finest product design and intuitive user interface.

2. WHAT'S IN THE BOX

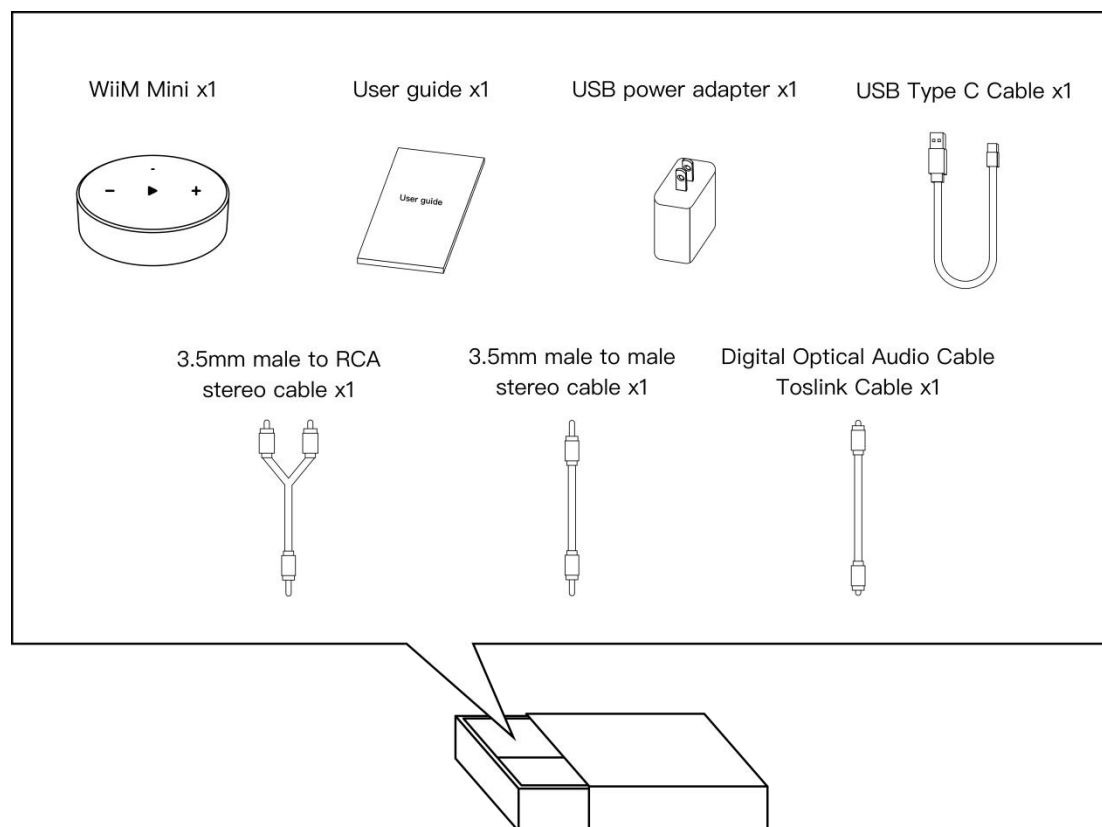

3. SPEC

Feature	Description
Audio Sound Quality	
Wireless Network	EEE 802.11 a/b/g/n/ac 2.4G EEE 802.11a/n/ac 1x1 5G
Bluetooth	Bluetooth 5.2
Line in	1Vrms

Line out**Line in to Line out:**

Power Output=2Vrms
THD+N Ratio=0.009%
SNR=102dB
Crosstalk=-106dB
Dynamic Range=96dB

BT in to Line out:

Power Output=2Vrms
THD+N Ratio=0.05%
SNR=103dB
Crosstalk=-107dB
Dynamic Range=121dB

SPDIF**Line in to SPDIF out:**

Power Output=-3dBFS
THD+N Ratio=0.005%
SNR=105dB
Crosstalk=-103dB
Dynamic Range=97dB

BT in to SPDIF out:

Power Output=0dBFS
THD+N Ratio=0.005%
SNR=297dB
Crosstalk=-364dB
Dynamic Range=213dB

Power Supply

5V_1A

Audio Codec

MP3, AAC, ALAC, APE, FLAC, WAV, WMA, OGG

LED

Three color status LED - Red, Green and White

4. CONTROLS AND LIGHTS

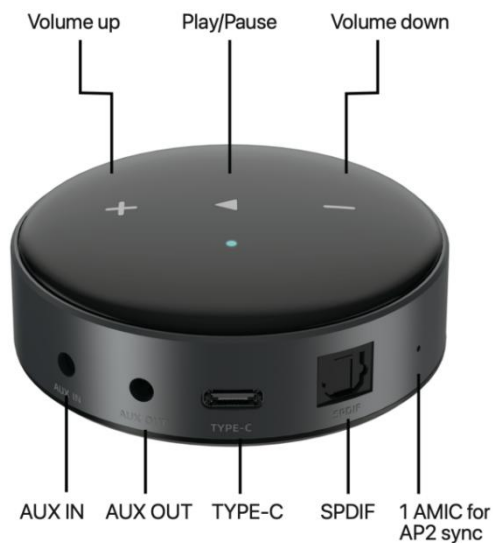

BUTTONS AND CONTROLS PANEL

Function	
Play/Pause	Press Play/Pause button
Volume Up	Press Volume + button
Volume Down	Press Volume - button
Analog audio in	-
Analog audio out	-
USB Type-C	USB Power (mains) Input
Digital Optical audio out	-
1 Amic	Used for Airplay2 sync

LIGHTS

State	Color	Flashing/Solid
Boot-up	White	Flashing (fast)
OOBE/Ready to Setup	White	Flashing (slow)
BT ready to pairing	Green	Flashing (slow)
Connecting to Wi-Fi	White, Green	Flashing (fast)

Connected to Wi-Fi	White	Solid
BT mode, paired	Green	Solid
Aux-in mode	Green	Solid
OTA	White, Green	Flashing (slow)
Restore to factory setting	White, Red	Flashing (slow)
Faulty Error	Red	Solid

NOTES:

WGR: Three color LED, no color mix

W: Wi-Fi (product default mode)

G: Other working mode

R: Error

Three modes: Solid, flashing slow, flashing fast

5. HOW TO SET UP

Attach the power cord and plug in your Mini.

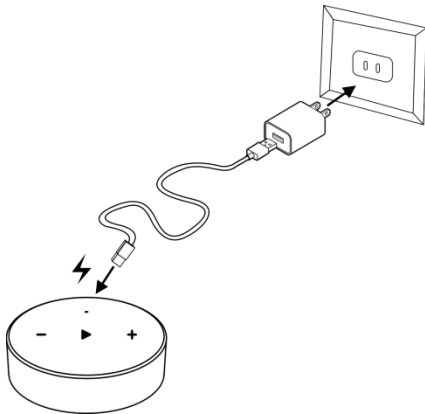

5.1 CONNECT THE AUDIO CABLE.

- ① If you're connecting to powered speakers
or
- ② If you're connecting to an audio/video receiver (AVR) or amplifier
or
- ③ If you're connecting to a computer

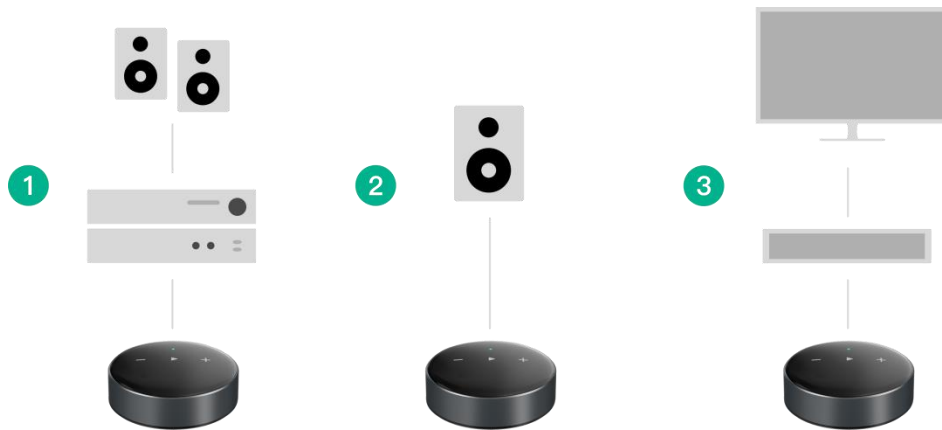

5.2 SETUP SYSTEM

- **Wi-Fi SETUP**

Download the WiiM Home App



- Power on speaker, audio/video receiver (AVR) or amplifier, or computer.
- Open the WiiM Home App.
- Click on the device you want to configure.
- Enter the correct password.

If you are using an **iOS system**, you can use AirPlay Setup as well.

- **AIRPLAY SETUP**

- Plug in the DUT and power it on.-
- Tap the Home app located on the home screen of the iOS device.
- Tap the "+" button located at the top-right corner of the screen.
- Tap "Add Accessory."
- Tap "Don't Have a Code or Can't Scan?"
- Tap your selected device which **MUST** be listed under "Nearby Accessories."

5.3 FILL YOUR HOME WITH SOUND

Plug in an audio device (like a turntable, CD player, or computer) and control the audio using the WiiM Home app.

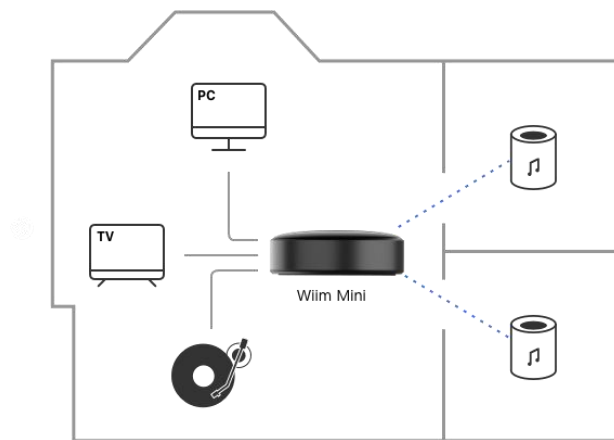

6. VOICE CONTROL

With Voice Control, you can navigate and interact with your device using your voice to search, play, stop or skip music and more.

When Voice Control is configured, you can speak commands just like you would perform an action by touch.

6.1 WORKS WITH ALEXA

Download Amazon Alexa App and turn on Amazon devices or 3rd party Alexa Built-in devices.

- Configure one to more devices.
If your device is not logged into your Amazon account in the WiiM Home App.
 - Open WiiM Home App, Click "Browse -> Amazon Alexa -> Get Started"
 - Log in to your Amazon account.
 - Open the Amazon Alexa app and log in.If your device is logged into your Amazon account in the WiiM Home App.
 - Open the Amazon Alexa app and log in the same Amazon account as the WiiM Home app.
- Click "Devices" at the bottom of the page.
- Click "+" in the top right corner.
- Click "Combine speakers ->Multi-room music"
- Select the configured Echo or other Amazon devices and the configured WiiM mini device.
- Click "Next" and choose the group name (Bedroom or other).
- Amazon Alexa app prompt that the group has been created.
- "Alexa, play some music in the Bedroom, then the Multi-room group playback can be controlled.

6.2 WORKS WITH Siri



- Configure one to more devices.
- Open a music app (like Apple Music) and select a track to play.
- Tap .
- Select your speaker/speakers or Home Pod.
- Say "Hey Siri, stop music/Play music" or touch the top of Home Pod to wake up Siri, say "Stop music/Play music".

7 CONTROL VIA YOUR FAVORITE APP

7.1 Spotify Connect

Spotify Connect is a way of playing Spotify through your wireless compatible device over wi-fi. That means you can play your favorite tunes anywhere in the house, all without the need for any convoluted Bluetooth pairing between devices every time you want to listen to music.



Use your phone, tablet, or computer as a remote control for Spotify. Go to [spotify.com/connect](https://www.spotify.com/connect) to learn how.

The Spotify Software is subject to third party licenses found here:
<https://www.spotify.com/connect/third-party-licenses>

7.2 Airplay2

The biggest feature of AirPlay 2 Multi-room.

It's Apple's first real move into multi-room technology, with AirPlay 2 finally letting you stream music from your iOS device to more than one product.

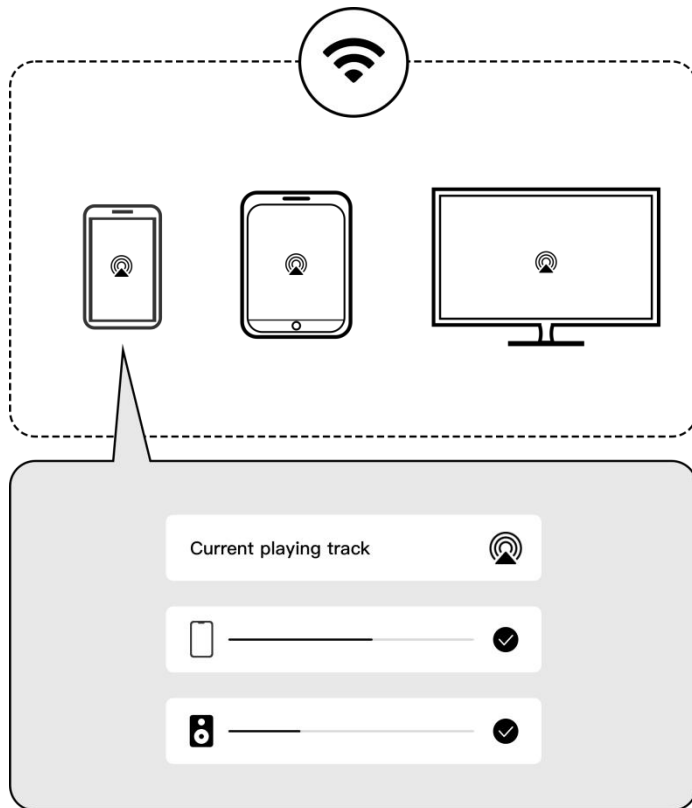

The WiiM Mini can play AirPlay 2 audio, which allows you to quickly stream audio from your Apple device to the external speaker or multiple speakers.

NOTES:

- To use AirPlay 2, you need an Apple device running iOS 11.4 or later.
- Your Apple device and WiiM mini must be connected to the same Wi-Fi network.
- For more information about AirPlay 2, visit: <https://www.apple.com/airplay>

STREAM AUDIO FROM THE CONTROL CENTER

1. On your Apple device, open the Control Center.
2. Tap and hold the audio card in the top-right corner of the screen, then tap the AirPlay icon .
3. Select your Wim Mini device.

STREAM AUDIO FROM AN APP

1. Open a music app (like Apple Music) and select a track to play.
2. Tap .
3. Select your WiiM Mini device.

7.3 Tidal Connect

TIDAL is a global music streaming platform bringing fans closer to artists through unique experiences and the highest sound quality

Stream your favorite music seamlessly from the cloud straight to your devices.

8 ALL MUSIC IN ONE APP

WiiM Mini learns your habits and provides you with customized service.

We support many top music streaming services in our companion app and through AVS like Spotify, iHeartRadio, Tidal, Amazon Prime Music, Napster, Sirius XM, Deezer, & more to come.

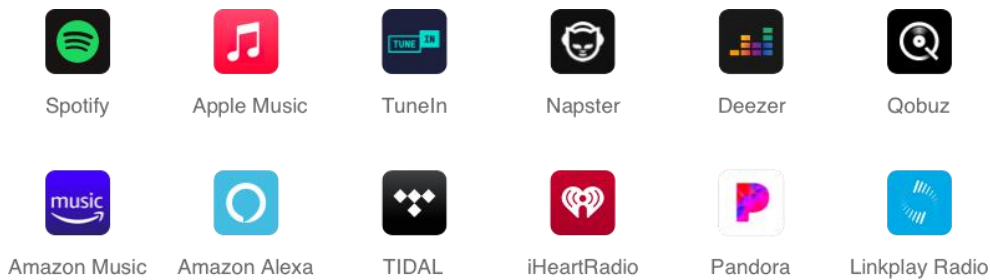

9 MULTI-ROOM

WiiM Mini Multi-room/Stereo Pairing turns your supported devices into a synchronized audio experience.

9.1 Linkplay MULTI-ROOM/STEREO PAIRING

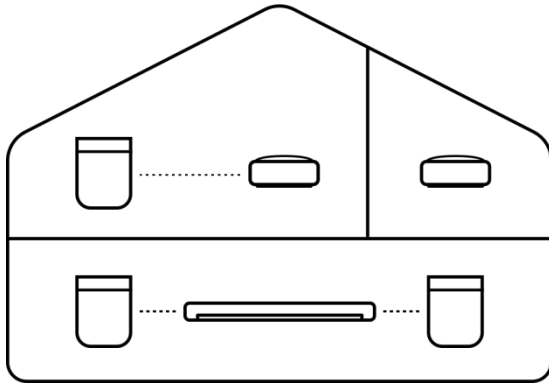

- Configure two or more devices.
- Open WiiM Home App.
- Select the device and click the plus sign in the upper right corner “+”
- Select the other WiiM Mini, click “Done”
- Click the LR icon “L” and set the device to “L/R/LR”
- In the Browse Tap, play “My music” or others.

9.2 AVS MULTI-ROOM

TIP: Download Amazon Alexa App and get ready with Echo or other Amazon devices. For detailed steps please refer to 6.1.

10 CONNECTING VIA AUX IN

- Insert the RCA end of the audio line into the corresponding input port marked by WiiM Mini as Aux-In.
- Depending on the output of the source device, plug the RCA or 3.5 mm (1/8 ") end of the cable into the corresponding output port on the source device or preamplifier
- Open the WiiM Home App on your iOS or Android device.
- In the Browse Tab, switch the Aux-In mode.
- Start playing on the source device.

11 CONNECTING VIA AUX /SPDIF/BT OUT

Control volume from your AVR or amplifier (Fixed line-out level)
Control the volume from WiiM Home (Variable line-out level)

11.1 CONNECTING VIA SPDIF/AUX OUT

- Depending on the output of the source device, plug the SPDIF line /RCA or 3.5 mm (1/8 ") end of the cable into the corresponding output port on the source device or preamplifier.
- Open the WiiM Home App on your iOS or Android device.
- In the Browse Tab, switch the Aux-Out mode.
- Start playing on the source device.

11.2 CONNECTING VIA BT OUT

- Open the WiiM Home App on your iOS or Android device.
- In the **Browse**  Tab, switch the Bluetooth mode.
- Connect Bluetooth to an external power amplifier (Support Bluetooth).
- Start playing on the source device.

12 STREAM AUDIO WITH BLUETOOTH

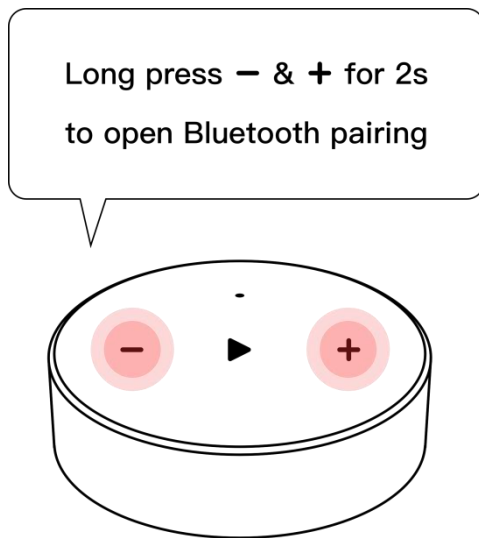

Bluetooth wireless technology lets you stream music from mobile devices such as smartphones, tablets, and laptop computers. Before you can stream music from a device, you must connect your device to the speaker.

13 ADVANCED FEATURES

13.1 UPDATE THE SPEAKER

- The speaker updates automatically when connected to the WiiM Home app and to your Wi-Fi network.
- Upgrade from 2:00-5:00 a.m. During the silent upgrade, there should be no sound and no indication.

13.2 DISABLE/ENABLE WI-FI

Press and hold Play/Pause for 3s to enable WIFI setup mode. Then please refer to the **HOW TO USE**.

14 FAQ

If you experience problems with the audio streamer, try these solutions first:

- What can I do if I cannot find device?
Ensure that the network is available and the device is powered on properly.

Restart the device.
Reconfigure the device to the network.
... ..

- What can i do if my device has no sound?
Ensure that the power amplifier is powered on normally.
Ensure that the 3.5mm (1/8 ") end of the cable and optical fiber line is working properly and the interface is not loose.
Make sure the amplifier and equipment are at a normal audible volume.
- What can i do if my device cannot power on normally?
Check the device status and chek whether the power cable works properly.
-

OTHER SOLUTIONS

If you could not resolve your issue, see the table below to identify symptoms and solutions to common problems. If you are unable to resolve your issue, please check your issues as below:

WiiM Mini App: Settings/FAQ
Website: Wiimhome.com/FAQ
Email: support@Wiimhome.com
Product User Guides: Wiimhome.com/guide

RESET THE SPEAKER

Press and hold play/pause for 10s, afterwards you will hear the voice tone and see the light flashing with red.

Factory reset clears all source, volume, and network settings from the speaker and returns it back to the original factory settings.

IMPORTANT SAFETY INSTRUCTIONS

IMPORTANT, RETAIN FOR FUTURE REFERENCE: READ CAREFULLY

1. Read these instructions.
2. Keep these instructions.
3. Heed all warnings.
4. Follow all instructions.
5. Do not use this apparatus near water.
6. Clean only with a dry cloth.
7. Do not block any ventilation openings. Install in accordance with the manufacturer's instructions.
8. Do not install near any heat sources such as radiators, heat registers, stoves, or other

apparatus (including amplifiers) that produce heat.

9. Protect the power cord from being walked on or pinched particularly at plugs, convenience receptacles, and the point where they exit from the apparatus.

10. Only use attachments/accessories specified by the manufacturer.

11. Unplug this apparatus during lightning storms or when unused for long periods of time.

12. Refer all servicing to qualified personnel. Servicing is required when the apparatus has been damaged in any way, such as external power supply, power-supply cord or plug is damaged, liquid has been spilled or objects have fallen into the apparatus, the apparatus has been exposed to rain or moisture, does not operate normally, or has been dropped

13. To reduce the risk of fire or electrical shock, do NOT expose this product to rain, liquids or moisture.

14. Do NOT expose this product to dripping or splashing, and do not place objects filled with liquids, such as vases, on or near the product.

15. Keep the product away from fire and heat sources. Do NOT place naked flame sources, such as lighted candles, on or near the product.

16. Do NOT make unauthorized alterations to this product.

17. Do NOT use in vehicles or boats.

18. Use this product only with the power supply provided.

19. Where the mains plug or an appliance coupler is used as the disconnect device, the disconnect device shall remain readily operable.

20. Due to ventilation requirements, does not recommend placing the product in a confined space such as in a wall cavity or in an enclosed cabinet.

21. Contains small parts which may be a choking hazard. Not suitable for children under age 3.

22. This product contains magnetic material. Consult your physician on whether this might affect your implantable medical device.

23. Do not place or install the bracket or product near any heat sources, such as fireplaces, radiators, heat registers or other apparatus (including amplifiers) that produce heat.

CE/FCC Statements

Federal Communication Commission (FCC) Radiation Exposure Statement

When using the product, maintain a distance of 20cm from the body to ensure compliance with RF exposure requirements.

FCC Statement:

This device complies with part 15 of the FCC rules. Operation is subject to the following two conditions:

(1) this device may not cause harmful interference, and

(2) this device must accept any interference received, including interference that may cause undesired operation.

NOTE: The manufacturer is not responsible for any radio or TV interference caused by unauthorized modifications or changes to this equipment. Such modifications or changes could void the user's authority to operate the equipment.

NOTE: This equipment has been tested and found to comply with the limits for a Class B

digital device, pursuant to part 15 of the FCC Rules. These limits are designed to provide reasonable protection against harmful interference in a residential installation. This equipment generates uses and can radiate radio frequency energy and, if not installed and used in accordance with the instructions, may cause harmful interference to radio communications. However, there is no guarantee that interference will not occur in a particular installation. If this equipment does cause harmful interference to radio or television reception, which can be determined by turning the equipment off and on, the user is encouraged to try to correct the interference by one or more of the following measures:

- Reorient or relocate the receiving antenna.
- Increase the separation between the equipment and receiver.
- Connect the equipment into an outlet on a circuit different from that to which the receiver is connected.
- Consult the dealer or an experienced radio/TV technician for help.

CE Statement:

RF exposure information: The Maximum Permissible Exposure (MPE) level has been calculated based on a distance of d=20 cm between the device and the human body. To maintain compliance with RF exposure requirement, use product that maintain a 20cm distance between the device and human body.

Do not use the device in the environment at too high or too low temperature, never expose the device under strong sunshine or too wet environment. The suitable temperature for the product and accessories is 0°C-40°C.

Operating Frequency Range, Max Output Power

Bluetooth: 2402MHz ~ 2480MHz, 9.28dBm
WLAN 2.4GHz: 2412MHz ~ 2472MHz, 17.18dBm
WLAN 5GHz: 5150MHz ~ 5825MHz, 15.96dBm

The device for operation in the band 5150~5350 MHz is only for indoor use to reduce the potential for harmful interference to co-channel mobile satellite systems.

	AT	BE	BG	HR	CY	CZ	DK
	EE	FI	FR	DE	EL	HU	IE
	IT	LV	LT	LU	MT	NL	PL
	PT	RO	SK	SI	ES	SE	UK
	CH	IS	LI	NO	TR		

This product can be used across EU member states.

EU Regulatory Conformance

Hereby, Linkplay Technology Inc. Corporation declares that this device is in compliance with the essential requirements and other relevant provisions of Directive 2014/53/EU. For the declaration of conformity, visit the Web site <https://wiimhome.com/guides>

