

FCC TEST REPORT

**Test report
On Behalf of
ShenZhen TianYuanHengTai Communications Equipment
CO., LTD
For
Smart Watch
Model No.: W101hero, W201hero, W801, W201, W101, W600,
W700, W300, W301, W302, W307, W900, W800, W500
FCC ID: 2ANNATYHT**

Prepared for : ShenZhen TianYuanHengTai Communications Equipment CO., LTD
3 F, 41A Building, 5th District, Huaidecuigang Industrial Park, Fuyong, Baoan,
Shenzhen, China

Prepared By : Laboratory of Shenzhen United Testing Technology Co., Ltd
Room 316-319, Block B, Honghualing Industrial Park of the Fifth Zone, Taoyuan
Street, Nanshan District, Shenzhen, Guangdong, China

Date of Test: Jun. 19, 2017 ~ Jun. 23, 2017

Date of Report: Jun. 23, 2017

Report Number: UNI170619044-E

TEST RESULT CERTIFICATION**Applicant's name** : ShenZhen TianYuanHengTai Communications Equipment CO., LTDAddress..... : 3 F, 41A Building, 5th District, Huaidecuiqiang Industrial Park,
Fuyong, Baoan, Shenzhen, China**Manufacture's Name** : ShenZhen TianYuanHengTai Communications Equipment CO., LTDAddress..... : 3 F, 41A Building, 5th District, Huaidecuiqiang Industrial Park,
Fuyong, Baoan, Shenzhen, China**Product description**

Trade Mark: MYMOBILE

Product name : Smart Watch

Model and/or type reference : W101hero, W201hero, W801, W201, W101, W600, W700, W300,
W301, W302, W307, W900, W800, W500**Standards** : FCC Rules and Regulations Part 15 Subpart C Section 15.249
ANSI C63.10: 2013

This publication may be reproduced in whole or in part for non-commercial purposes as long as the **Laboratory of Shenzhen United Testing Technology Co., Ltd** is acknowledged as copyright owner and source of the material. **Laboratory of Shenzhen United Testing Technology Co., Ltd** takes no responsibility for and will not assume liability for damages resulting from the reader's interpretation of the reproduced material due to its placement and context.

Date of Test..... :Date (s) of performance of tests..... : **Jun. 19, 2017 ~ Jun. 23, 2017**Date of Issue : **Jun. 23, 2017**Test Result : **Pass**

Testing Engineer :



(Eric Xie)

Technical Manager :



(Dora Qin)

Authorized Signatory :



(Kait Chen)

Table of Contents	Page
1 . TEST SUMMARY	4
2 . GENERAL INFORMATION	5
2.1 GENERAL DESCRIPTION OF EUT	5
2.2 Operation of EUT during testing	6
2.3 DESCRIPTION OF TEST SETUP	6
2.4 MEASUREMENT INSTRUMENTS LIST	7
3 . CONDUCTED EMISSIONS TEST	8
3.1 Conducted Power Line Emission Limit	8
3.2 Test Setup	8
3.3 Test Procedure	8
3.4 Test Result	8
4 RADIATED EMISSION TEST	11
4.1 Radiation Limit	11
4.2 Test Setup	11
4.3 Test Procedure	12
4.4 Test Result	12
5 BAND EDGE	18
5.1 Limits	18
5.2 Test Procedure	18
5.3 Test Result	18
6 OCCUPIED BANDWIDTH MEASUREMENT	20
6.1 Test Setup	20
6.2 Test Procedure	20
6.3 Measurement Equipment Used	20
6.4 Test Result	20
7 ANTENNA REQUIREMENT	22
8 PHOTOGRAPH OF TEST	23
8.1 Radiated Emission	23
8.2 Conducted Emission	24

1. TEST SUMMARY

1.1 TEST PROCEDURES AND RESULTS

DESCRIPTION OF TEST	RESULT
CONDUCTED EMISSIONS TEST	COMPLIANT
RADIATED EMISSION TEST	COMPLIANT
BAND EDGE	COMPLIANT
OCCUPIED BANDWIDTH MEASUREMENT	COMPLIANT
ANTENNA REQUIREMENT	COMPLIANT

1.2 TEST FACILITY

Test Firm : QTC Certification & Testing Co., Ltd.
Certificated by FCC, Registration No.: 588523

Address : 2nd Floor,B1 Building,Fengyeyuan Industrial Plant, Liuxian 2st. Road,
Xin'an Street, Bao'an District, Shenzhen, China

1.3 MEASUREMENT UNCERTAINTY

Measurement Uncertainty	
Conducted Emission Expanded Uncertainty	= 2.23dB, k=2
Radiated emission expanded uncertainty(9kHz-30MHz)	= 3.08dB, k=2
Radiated emission expanded uncertainty(30MHz-1000MHz)	= 4.42dB, k=2
Radiated emission expanded uncertainty(Above 1GHz)	= 4.06dB, k=2

2. GENERAL INFORMATION

2.1 GENERAL DESCRIPTION OF EUT

Equipment	Smart Watch
Model Name	W101hero
Serial Model	W201hero, W801, W201, W101, W600, W700, W300, W301, W302, W307, W900, W800, W500
Model Difference	All model's the function, software and electric circuit are the same, only with a product appearance and model named different. Test sample model: W101hero.
FCC ID	2ANNATYHT
Antenna Type	PCB Antenna
Antenna Gain	0 dBi
BT Operation frequency	2402-2480MHz
Number of Channels	79CH
Modulation Type	GFSK
Power Source	DC3.7V from battery or DC5V from adapter AC120V/60Hz
Power Rating	DC3.7V from battery or DC5V from adapter AC120V/60Hz

2.1.1 Carrier Frequency of Channels

Channel List					
Channel	Frequency (MHz)	Channel	Frequency (MHz)	Channel	Frequency (MHz)
00	2402	27	2429	54	2456
01	2403	28	2430	55	2457
02	2404	29	2431	56	2458
03	2405	30	2432	57	2459
04	2406	31	2433	58	2460
05	2407	32	2434	59	2461
06	2408	33	2435	60	2462
07	2409	34	2436	61	2463
08	2410	35	2437	62	2464
09	2411	36	2438	63	2465
10	2412	37	2439	64	2466
11	2413	38	2440	65	2467
12	2414	39	2441	66	2468
13	2415	40	2442	67	2469
14	2416	41	2443	68	2470
15	2417	42	2444	69	2471
16	2418	43	2445	70	2472
17	2419	44	2446	71	2473
18	2420	45	2447	72	2474
19	2421	46	2448	73	2475
20	2422	47	2449	74	2476
21	2423	48	2450	75	2477
22	2424	49	2451	76	2478
23	2425	50	2452	77	2479
24	2426	51	2453	78	2480
25	2427	52	2454		
26	2428	53	2455		

2.2 Operation of EUT during testing

Operating Mode

The mode is used: **Transmitting mode**

Low Channel: 2402MHz

Middle Channel: 2441MHz

High Channel: 2480MHz

2.3 DESCRIPTION OF TEST SETUP

Operation of EUT during conducted testing:

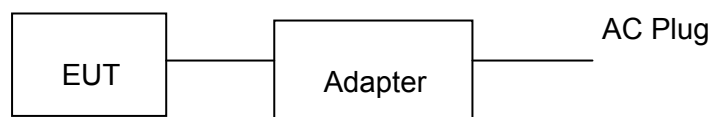

Operation of EUT during Radiation testing:



2.4 MEASUREMENT INSTRUMENTS LIST

Item	Equipment	Manufacturer	Model No.	Serial No.	Cal Date	Due Date
1.	EMI Receiver	Rohde & Schwarz	ESCI	100627	Feb. 18, 2017	Feb. 17, 2018
2.	LISN	SchwarzBeck	NSLK 8126	8126377	Feb. 18, 2017	Feb. 17, 2018
3.	RF Switching Unit	Compliance Direction	RSU-M2	38303	Feb. 18, 2017	1 Year
4.	EMI Test Software ES-K1	Rohde & Schwarz	N/A	N/A	N/A	N/A
5.	EMI Test Receiver	Rohde & Schwarz	ESCI	100627	Feb. 18, 2017	Feb. 17, 2018
6.	Trilog Broadband Antenna	Schwarzbeck	VULB9163	VULB 9163-289	Feb. 18, 2017	Feb. 17, 2018
7.	Pre-amplifier	Compliance Direction	PAP-0203	22008	Feb. 18, 2017	Feb. 17, 2018
8.	EMI Test Software EZ-EMC	SHURPLE	N/A	N/A	N/A	N/A
9.	EMI Receiver	Rohde & Schwarz	ESCI	100627	Feb. 18, 2017	Feb. 17, 2018
10.	LISN	SchwarzBeck	NSLK 8126	8126377	Feb. 18, 2017	Feb. 17, 2018
11.	RF Switching Unit	Compliance Direction	RSU-M2	38303	Feb. 18, 2017	Feb. 17, 2018
12.	EMI Test Software ES-K1	Rohde & Schwarz	N/A	N/A	N/A	N/A
13.	EMI Receiver	Rohde & Schwarz	ESCI	100627	Feb. 18, 2017	Feb. 17, 2018
14.	EMI Receiver	Rohde & Schwarz	ESCI	100627	Feb. 18, 2017	Feb. 17, 2018
15.	LISN	SchwarzBeck	NSLK 8126	8126377	Feb. 18, 2017	Feb. 17, 2018
16.	RF Switching Unit	Compliance Direction	RSU-M2	38303	Feb. 18, 2017	Feb. 17, 2018
17.	EMI Test Software ES-K1	Rohde & Schwarz	N/A	N/A	N/A	N/A
18.	Power Meter	R&S	NRVD	SEL0069	Feb. 18, 2017	Feb. 17, 2018
19.	Power Sensor	R&S	URV5-Z2	SEL0071	Feb. 18, 2017	Feb. 17, 2018
20.	Power Sensor	R&S	URV5-Z2	SEL0072	Feb. 18, 2017	Feb. 17, 2018
21.	Software EMC32	R&S	EMC32-S	SEL0082	N/A	N/A
22.	Log-periodic Antenna	Amplifier Reasearch	APT1.580	SEL0073	Feb. 18, 2017	Feb. 17, 2018
23.	Loop Antenna	Schwarz beck	FMZB 1516	9773	Feb. 18, 2017	Feb. 17, 2018
24.	Broadband Antenna	Schwarz beck	VULB9163	9163-333	Feb. 18, 2017	Feb. 17, 2018
25.	Horn Antenna	ETS	3117	00086197	Feb. 18, 2017	Feb. 17, 2018
26.	Horn Antenna	Schwarzbeck	BBHA9170	BBHA91705 82	Feb. 18, 2017	Feb. 17, 2018
27.	Antenna Tripod	Amplifier Reasearch	TP1000A	SEL0074	Feb. 18, 2017	Feb. 17, 2018
28.	High Gain Horn Antenna	Amplifier Reasearch	AT4002A	SEL0075	Feb. 18, 2017	Feb. 17, 2018
29.	Spectrum analyzer	Agilent	N9020A	MY49911004 8	Feb. 18, 2017	Feb. 17, 2018
30.	Spectrum analyzer	Agilent	E4407B	MY46184326	Feb. 18, 2017	Feb. 17, 2018
31.	Spectrum analyzer	R&S	FSP30	836079/035	Feb. 18, 2017	Feb. 17, 2018

3. CONDUCTED EMISSIONS TEST

3.1 Conducted Power Line Emission Limit

For unintentional device, according to § 15.107(a) Line Conducted Emission Limits is as following

Frequency (MHz)	Maximum RF Line Voltage (dB μ V)			
	CLASS A		CLASS B	
	Q.P.	Ave.	Q.P.	Ave.
0.15 - 0.50	79	66	66-56*	56-46*
0.50 - 5.00	73	60	56	46
5.00 - 30.0	73	60	60	50

* Decreasing linearly with the logarithm of the frequency

For intentional device, according to §15.207(a) Line Conducted Emission Limit is same as above table.

3.2 Test Setup

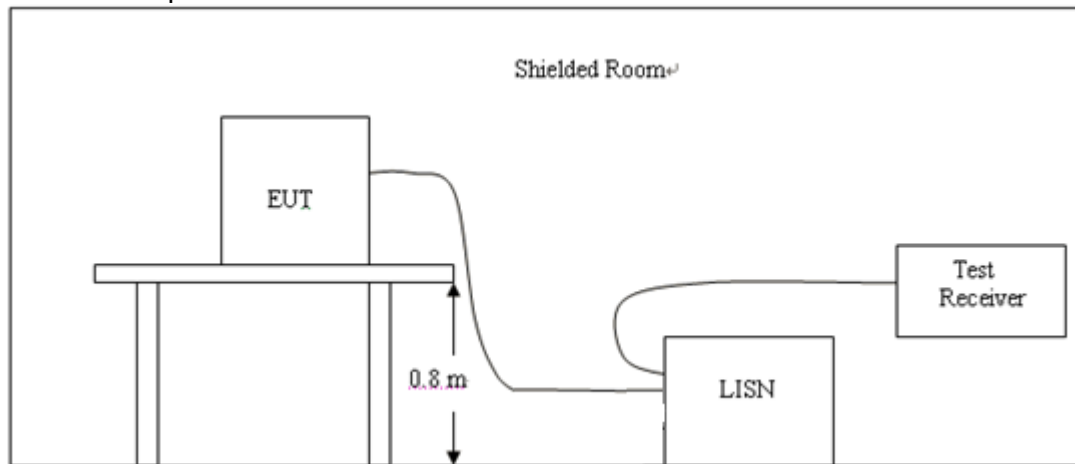

3.3 Test Procedure

- 1, The equipment was set up as per the test configuration to simulate typical actual usage per the user's manual. The EUT is a tabletop system, a wooden table with a height of 0.1 meters is used and is placed on the ground plane as per ANSI C63.10.
- 2, Support equipment, if needed, was placed as per ANSI C63.10.
- 3, All I/O cables were positioned to simulate typical actual usage as per ANSI C63.10.
- 4, If a EUT received DC power from the USB Port of Notebook PC, the PC's adapter received AC120V/60Hz power through a Line Impedance Stabilization Network (LISN) which supplied power source and was grounded to the ground plane.
- 5, All support equipments received AC power from a second LISN, if any.
- 6, The EUT test program was started. Emissions were measured on each current carrying line of the EUT using a spectrum Analyzer / Receiver connected to the LISN powering the EUT. The LISN has two monitoring points: Line 1 (Hot Side) and Line 2 (Neutral Side). Two scans were taken: one with Line 1 connected to Analyzer / Receiver and Line 2 connected to a 50 ohm load; the second scan had Line 1 connected to a 50 ohm load and Line 2 connected to the Analyzer / Receiver.
- 7, Analyzer / Receiver scanned from 150 KHz to 30MHz for emissions in each of the test modes.

3.4 Test Result

PASS

All the test modes completed for test. The worst case of Conducted Emission is CH 2441; the test data of this mode was reported.

N

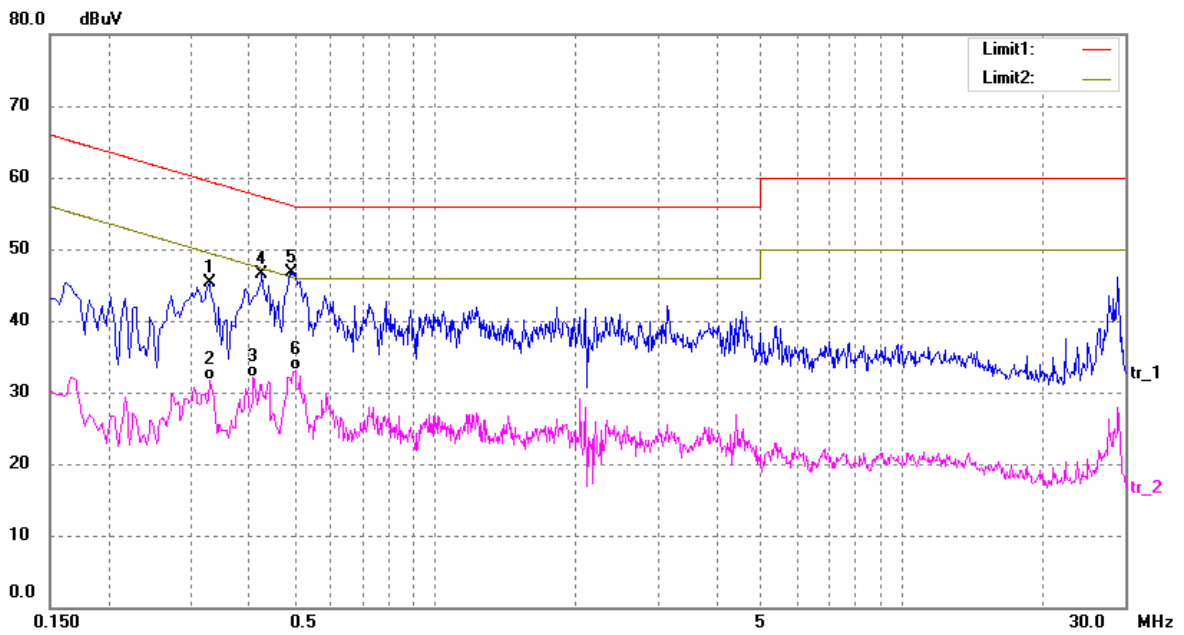

No.	Frequency (MHz)	Reading (dBuV)	Correct (dB/m)	Result (dBuV)	Limit (dBuV)	Margin (dB)	Detector
1	0.3300	35.52	9.80	45.32	59.45	-14.13	QP
2	0.3300	21.97	9.80	31.77	49.45	-17.68	AVG
3	0.4100	22.38	9.80	32.18	47.65	-15.47	AVG
4	0.4260	36.80	9.80	46.60	57.33	-10.73	QP
5*	0.4940	36.95	9.80	46.75	56.10	-9.35	QP
6	0.5020	23.22	9.80	33.02	46.00	-12.98	AVG

L



No.	Frequency (MHz)	Reading (dBuV)	Correct (dB/m)	Result (dBuV)	Limit (dBuV)	Margin (dB)	Detector
1	0.2860	35.55	9.80	45.35	60.64	-15.29	QP
2	0.2980	21.20	9.80	31.00	50.30	-19.30	AVG
3	0.4180	24.34	9.80	34.14	47.49	-13.35	AVG
4	0.4420	38.28	9.80	48.08	57.02	-8.94	QP
5	0.4780	26.99	9.80	36.79	46.37	-9.58	AVG
6*	0.4900	41.35	9.80	51.15	56.17	-5.02	QP

4 RADIATED EMISSION TEST

4.1 Radiation Limit

For unintentional device, according to § 15.109(a), except for Class A digital devices, the field strength of radiated emissions from unintentional radiators at a distance of 3 meters shall not exceed the following values:

Frequency (MHz)	Distance (Meters)	Radiated (dB μ V/m)	Radiated (μ V/m)
30-88	3	40	100
88-216	3	43.5	150
216-960	3	46	200
Above 960	3	54	500

For intentional device, according to § 15.209(a), the general requirement of field strength of radiated emissions from intentional radiators at a distance of 3 meters shall not exceed the above table.

4.2 Test Setup

(1) Radiated Emission Test-Up Frequency Below 30MHz

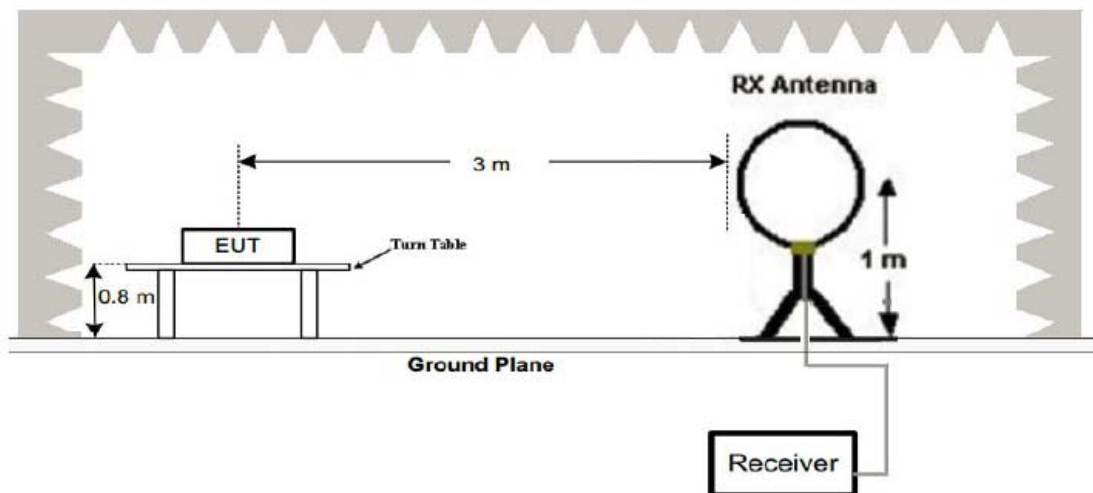

(2) Radiated Emission Test-Up Frequency 30MHz~1GHz

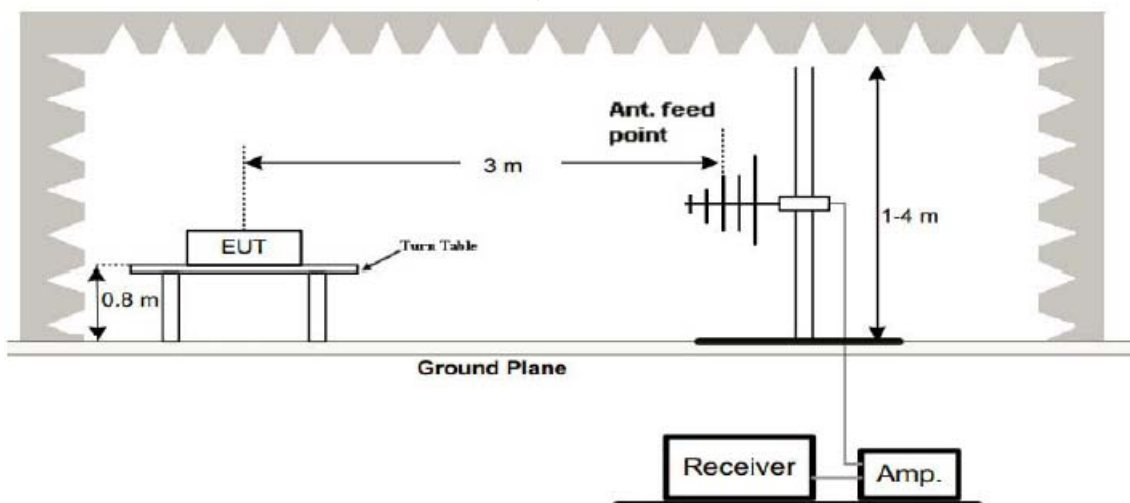

(3) Radiated Emission Test-Up Frequency Above 1GHz

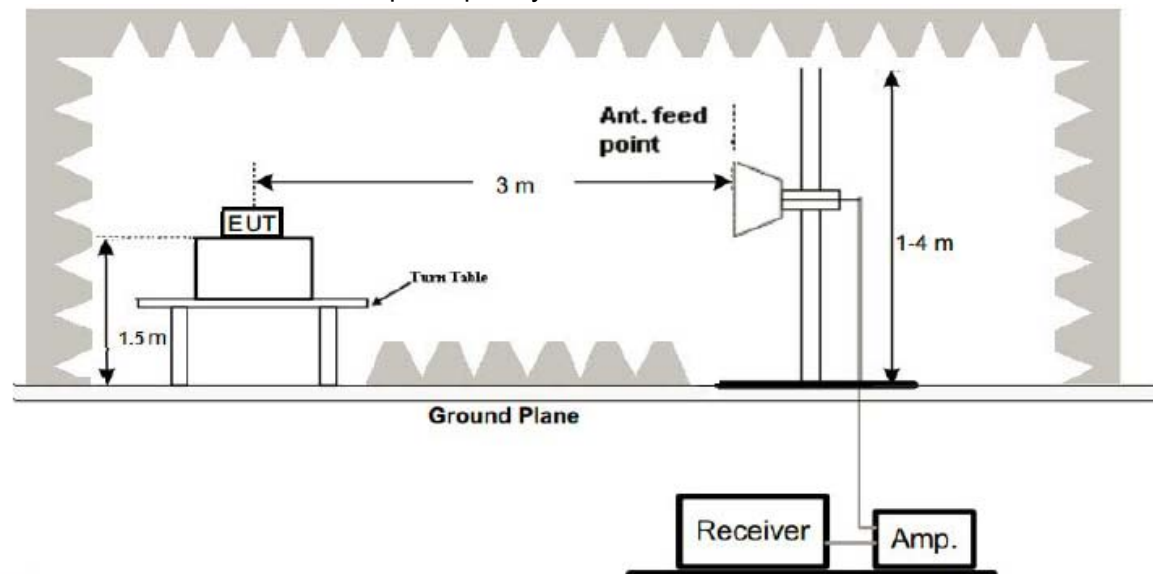

4.3 Test Procedure

1. Below 1GHz measurement the EUT is placed on turntable which is 0.1m above ground plane. And above 1GHz measurement EUT was placed on low permittivity and low tangent turn table which is 1.5m above ground plane.
2. The turntable shall be rotated for 360 degrees to determine the position of maximum emission level.
3. EUT is set 3m away from the receiving antenna, which is varied from 1m to 4m to find out the highest emissions.
4. Maximum procedure was performed on the six highest emissions to ensure EUT compliance.
5. And also, each emission was to be maximized by changing the polarization of receiving antenna both horizontal and vertical.
6. Repeat above procedures until the measurements for all frequencies are complete.
7. The test frequency range from 9KHz to 25GHz per FCC PART 15.33(a).

Note:

For battery operated equipment, the equipment tests shall be performed using a new battery.

4.4 Test Result

PASS

All the test modes completed for test. The worst case of Radiated Emission is CH 2402; the test data of this mode was reported.

Below 1GHz Test Results:
Antenna polarity: H

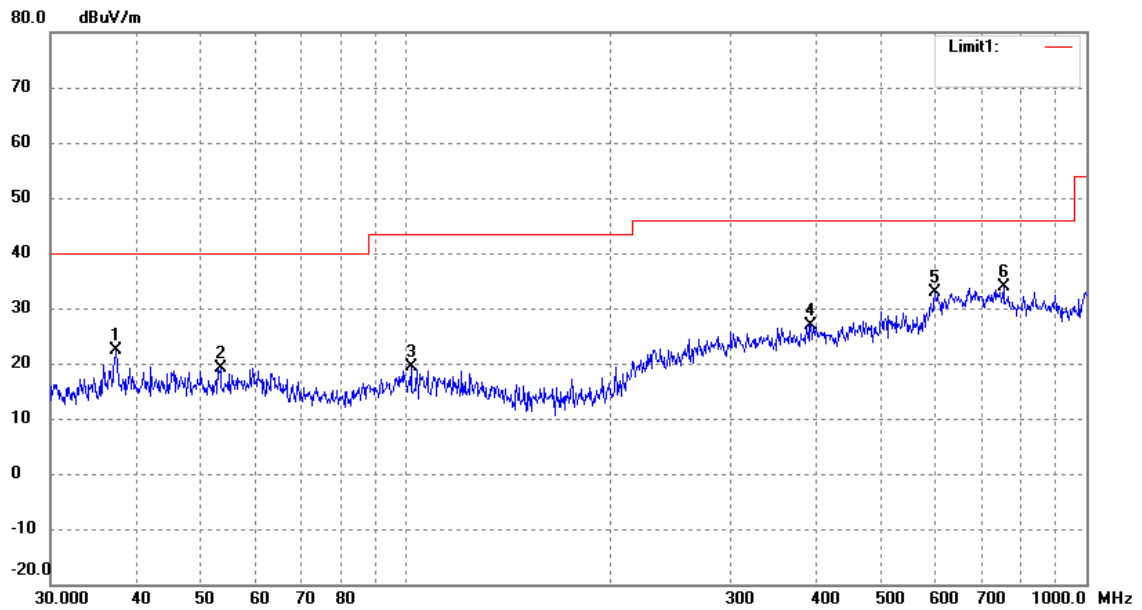

No.	Frequency (MHz)	Reading (dBuV/m)	Correct dB/m	Result (dBuV/m)	Limit (dBuV/m)	Margin (dB)	Degree ()	Height (cm)	Remark
1	37.4165	17.52	4.81	22.33	40.00	-17.67	124	100	peak
2	53.3179	13.93	5.30	19.23	40.00	-20.77	168	100	peak
3	101.6443	14.38	5.11	19.49	43.50	-24.01	139	100	peak
4	393.4724	14.17	12.83	27.00	46.00	-19.00	214	100	peak
5	599.3213	13.66	19.19	32.85	46.00	-13.15	154	100	peak
6	755.3873	15.00	18.86	33.86	46.00	-12.14	136	100	peak

Antenna polarity: V

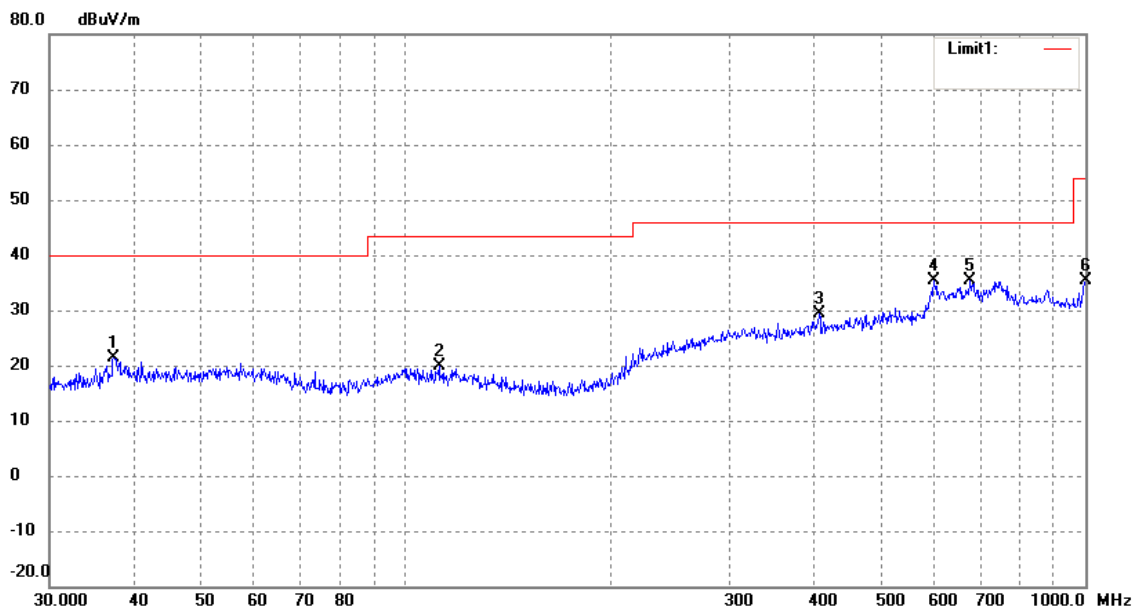

No.	Frequency (MHz)	Reading (dBuV/m)	Correct dB/m	Result (dBuV/m)	Limit (dBuV/m)	Margin (dB)	Degree ()	Height (cm)	Remark
1	37.2855	16.58	4.79	21.37	40.00	-18.63	158	100	peak
2	112.1305	14.73	5.06	19.79	43.50	-23.71	137	100	peak
3	406.0880	16.54	12.91	29.45	46.00	-16.55	245	100	peak
4	599.3213	16.08	19.19	35.27	46.00	-10.73	269	100	peak
5	677.5798	16.20	19.13	35.33	46.00	-10.67	124	100	peak
6	1000.0000	16.54	18.91	35.45	54.00	-18.55	136	100	peak

Remark:

- (1) Measuring frequencies from 9 KHz to the 1 GHz, Radiated emission test from 9KHz to 30MHz was verified, and no any emission was found except system noise floor.
- (2) * denotes emission frequency which appearing within the Restricted Bands specified in provision of 15.205, then the general radiated emission limits in 15.209 apply.
- (3) The IF bandwidth of EMI Test Receiver between 30MHz to 1GHz was 120KHz, 1 MHz for measuring above 1 GHz, below 30MHz was 10KHz.

Above 1 GHz Test Results:

CH Low (2402MHz)

Horizontal:

Frequency	Meter Reading	Factor	Emission Level	Limits	Margin	Detector Type
(MHz)	(dB μ V)	(dB)	(dB μ V/m)	(dB μ V/m)	(dB)	
2402	113.75	-5.84	107.91	114	-6.09	peak
2402	83.33	-5.84	77.49	94	-16.51	AVG
4804	57.32	-3.64	53.68	74	-20.32	peak
4804	46.15	-3.64	42.51	54	-11.49	AVG
7206	53.17	-0.95	52.22	74	-21.78	peak
7206	41.22	-0.95	40.27	54	-13.73	AVG
---	---	---	---	---	---	---
---	---	---	---	---	---	---

Remark: Factor = Antenna Factor + Cable Loss – Pre-amplifier.

Vertical:

Frequency	Meter Reading	Factor	Emission Level	Limits	Margin	Detector Type
(MHz)	(dB μ V)	(dB)	(dB μ V/m)	(dB μ V/m)	(dB)	
2402	112.34	-5.84	106.5	114	-7.5	peak
2402	83.28	-5.84	77.44	94	-16.56	AVG
4804	55.33	-3.64	51.69	74	-22.31	peak
4804	42.16	-3.64	38.52	54	-15.48	AVG
7206	55.22	-0.95	54.27	74	-19.73	peak
7206	39.86	-0.95	38.91	54	-15.09	AVG
---	---	---	---	---	---	---
---	---	---	---	---	---	---

Remark: Factor = Antenna Factor + Cable Loss – Pre-amplifier.

CH Middle (2441MHz)

Horizontal:

Frequency	Meter Reading	Factor	Emission Level	Limits	Margin	Detector Type
(MHz)	(dB μ V)	(dB)	(dB μ V/m)	(dB μ V/m)	(dB)	
2441	110.29	-5.71	104.58	114	-9.42	peak
2441	85.28	-5.71	79.57	94	-14.43	AVG
4882	57.45	-3.51	53.94	74	-20.06	peak
4882	43.22	-3.51	39.71	54	-14.29	AVG
7323	53.62	-0.82	52.8	74	-21.2	peak
7323	38.45	-0.82	37.63	54	-16.37	AVG
---	---	---	---	---	---	---
---	---	---	---	---	---	---

Remark: Factor = Antenna Factor + Cable Loss – Pre-amplifier.

Vertical:

Frequency	Meter Reading	Factor	Emission Level	Limits	Margin	Detector Type
(MHz)	(dB μ V)	(dB)	(dB μ V/m)	(dB μ V/m)	(dB)	
2441	109.61	-5.71	103.9	114	-10.1	peak
2441	84.11	-5.71	78.4	94	-15.6	AVG
4882	56.19	-3.51	52.68	74	-21.32	peak
4882	44.12	-3.51	40.61	54	-13.39	AVG
7323	53.28	-0.82	52.46	74	-21.54	peak
7323	37.83	-0.82	37.01	54	-16.99	AVG
---	---	---	---	---	---	---
---	---	---	---	---	---	---

Remark: Factor = Antenna Factor + Cable Loss – Pre-amplifier.

CH High (2480MHz)

Horizontal:

Frequency	Meter Reading	Factor	Emission Level	Limits	Margin	Detector Type
(MHz)	(dB μ V)	(dB)	(dB μ V/m)	(dB μ V/m)	(dB)	
2480	108.23	-5.65	102.58	114	-11.42	peak
2480	84.21	-5.65	78.56	94	-15.44	AVG
4960	55.97	-3.43	52.54	74	-21.46	peak
4960	43.17	-3.43	39.74	54	-14.26	AVG
7440	54.67	-0.75	53.92	74	-20.08	peak
7440	38.86	-0.75	38.11	54	-15.89	AVG
---	---	---	---	---	---	---
---	---	---	---	---	---	---

Remark: Factor = Antenna Factor + Cable Loss – Pre-amplifier.

Vertical:

Frequency	Meter Reading	Factor	Emission Level	Limits	Margin	Detector Type
(MHz)	(dB μ V)	(dB)	(dB μ V/m)	(dB μ V/m)	(dB)	
2480	108.13	-5.65	102.48	114	-11.52	peak
2480	82.44	-5.65	76.79	94	-17.21	AVG
4960	54.23	-3.43	50.8	74	-23.2	peak
4960	42.15	-3.43	38.72	54	-15.28	AVG
7440	54.26	-0.75	53.51	74	-20.49	peak
7440	38.67	-0.75	37.92	54	-16.08	AVG
---	---	---	---	---	---	---
---	---	---	---	---	---	---

Remark: Factor = Antenna Factor + Cable Loss – Pre-amplifier.

Remark:

- (1) Measuring frequencies from 1 GHz to the 25 GHz.
- (2) "F" denotes fundamental frequency; "H" denotes spurious frequency. "E" denotes band edge frequency.
- (3) * denotes emission frequency which appearing within the Restricted Bands specified in provision of 15.205, then the general radiated emission limits in 15.209 apply.
- (4) Data of measurement within this frequency range shown "---" in the table above means the reading of emissions are attenuated more than 20dB below the permissible limits or the field strength is too small to be measured.
- (5) The IF bandwidth of EMI Test Receiver between 30MHz to 1GHz was 120KHz, 1 MHz for measuring above 1 GHz, below 30MHz was 10KHz.
- (6) When the test results of Peak Detected below the limits of Average Detected, the Average Detected is not need completed. For example: Top Channel at Fundamental 73.16dBuV/m(PK Value) <93.98(AV Limit), at harmonic 53.20 dBuV/m(PK Value) <54 dBuV/m(AV Limit), the Average Detected not need to completed.

5 BAND EDGE

5.1 Limits

FCC PART 15.249(d) Emissions radiated outside of the specified frequency bands, except for harmonics, shall be attenuated by at least 50 dB below the level of the fundamental or to the general radiated emission limits in §15.209, whichever is the lesser attenuation.

5.2 Test Procedure

The band edge compliance of RF radiated emission should be measured by following the guidance in ANSI C63.10 with respect to maximizing the emission by rotating the EUT, measuring the emission while the EUT is situated in three orthogonal planes (if appropriate), adjusting the measurement antenna height and polarization etc. Set RBW to 100KHz and VBM to 300KHz to measure the peak field strength and set RBW to 1MHz and VBW to 10Hz to measure the average radiated field strength. The conducted RF band edge was measured by using a spectrum analyzer. Set span wide enough to capture the highest in-band emission and the emission at the band edge. Set RBW to 100 KHz and VBW to 300 KHz, to measure the conducted peak band edge.

5.3 Test Result

PASS

Radiated Band Edge Test:
 Operation Mode: TX CH Low (2402MHz)
 Horizontal (Worst case)

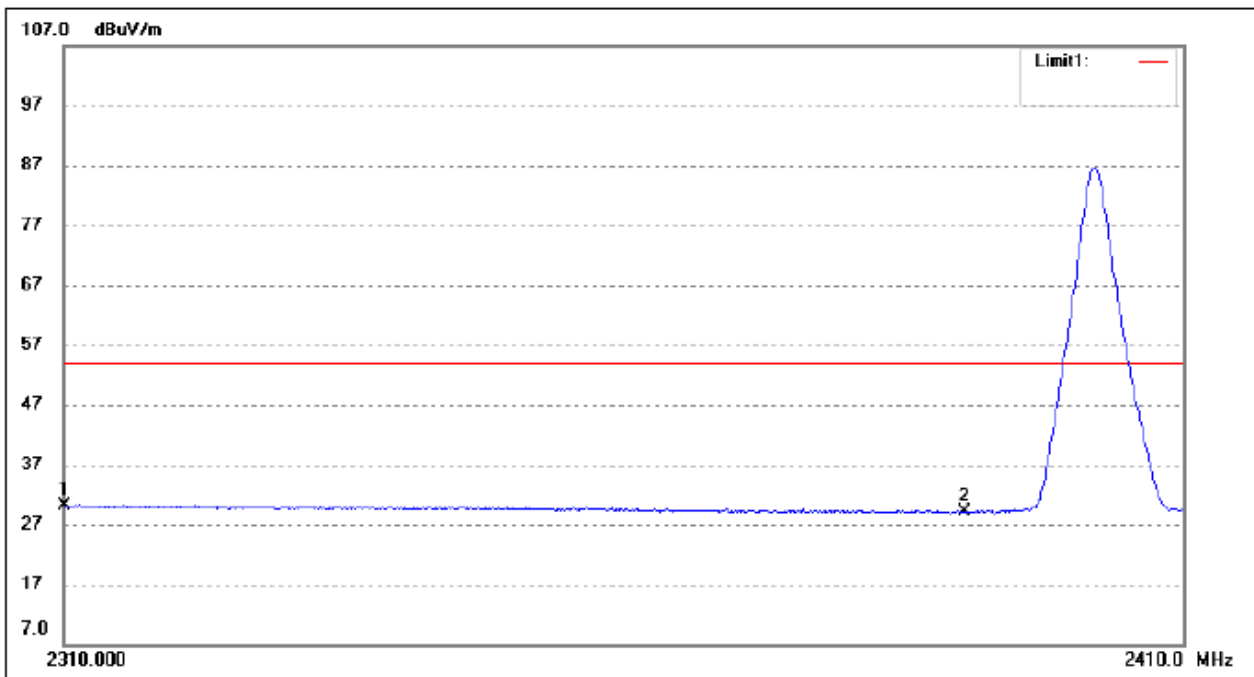

No.	Frequency (MHz)	Reading (dBuV/m)	Correct Factor(dB)	Result (dBuV/m)	Limit (dBuV/m)	Margin (dB)	Remark
1	2310.00	33.50	-3.35	30.15	54.00	-23.85	Average Detector
	2310.00	46.62	-3.35	43.27	74.00	-30.73	Peak Detector
2	2390.00	33.38	-4.29	29.09	54.00	-24.91	Average Detector
	2390.00	46.18	-4.29	41.89	74.00	-32.11	Peak Detector

Operation Mode: TX CH High (2480MHz)

Horizontal (Worst case)

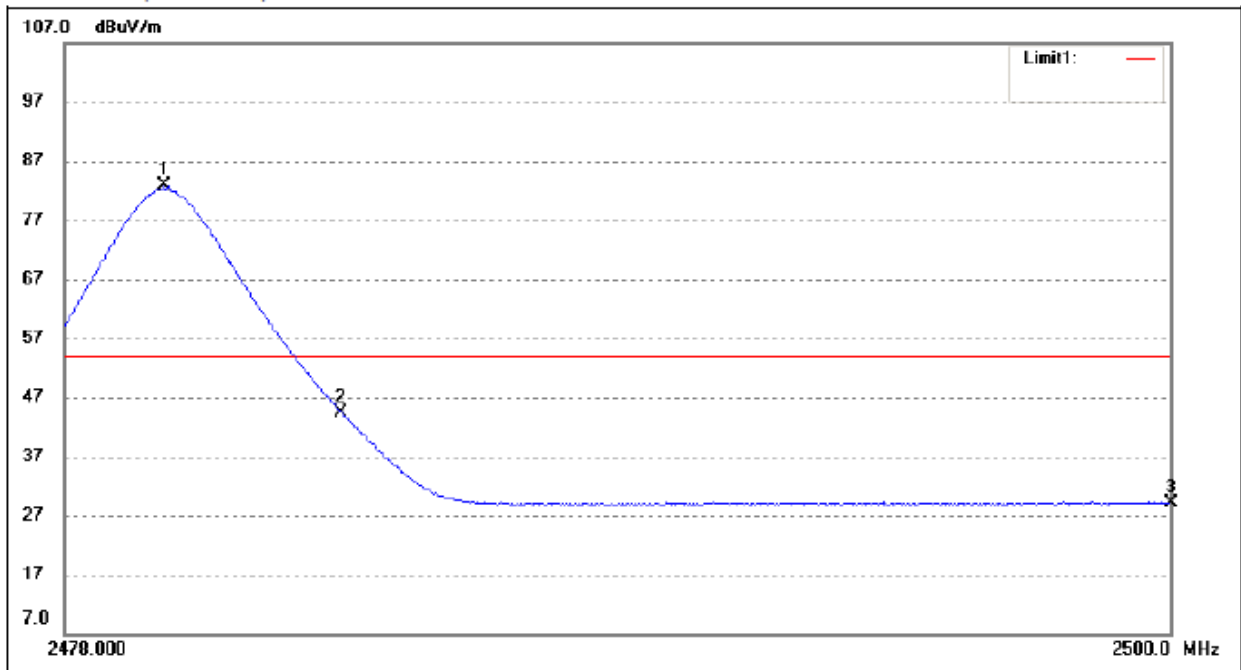

No.	Frequency (MHz)	Reading (dBuV/m)	Correct Factor(dB)	Result (dBuV/m)	Limit (dBuV/m)	Margin (dB)	Remark
1	2479.97	87.26	-4.36	82.90	/	/	Average Detector
	2479.82	93.57	-4.36	89.21	/	/	Peak Detector
2	2483.50	48.73	-4.36	44.37	54.00	-9.63	Average Detector
	2483.50	54.73	-4.36	50.37	74.00	-23.63	Peak Detector
3	2500.00	33.47	-4.34	29.13	54.00	-24.87	Average Detector
	2500.00	46.14	-4.34	41.80	74.00	-32.20	Peak Detector

6 OCCUPIED BANDWIDTH MEASUREMENT

6.1 Test Setup

Same as Radiated Emission Measurement

6.2 Test Procedure

1. The EUT was placed on a turn table which is 0.8m above ground plane.
2. Set EUT as normal operation.
3. Based on FCC Part15 C Section 15.249(a): RBW= 100KHz. VBW= 300 KHz, Span=3MHz.
4. The useful radiated emission from the EUT was detected by the spectrum analyser with peak detector.

6.3 Measurement Equipment Used

Same as Radiated Emission Measurement

6.4 Test Result

PASS

Frequency	20dB Bandwidth (MHz)	Result
2402 MHz	1.384	PASS
2441 MHz	1.378	PASS
2480 MHz	1.383	PASS

CH: 2402MHz

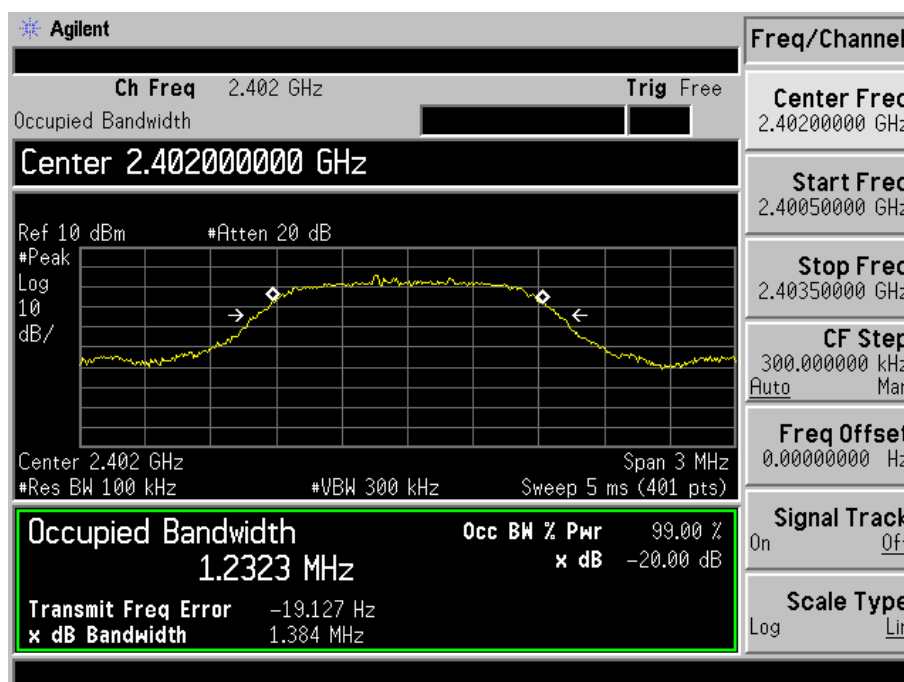

CH: 2441MHz

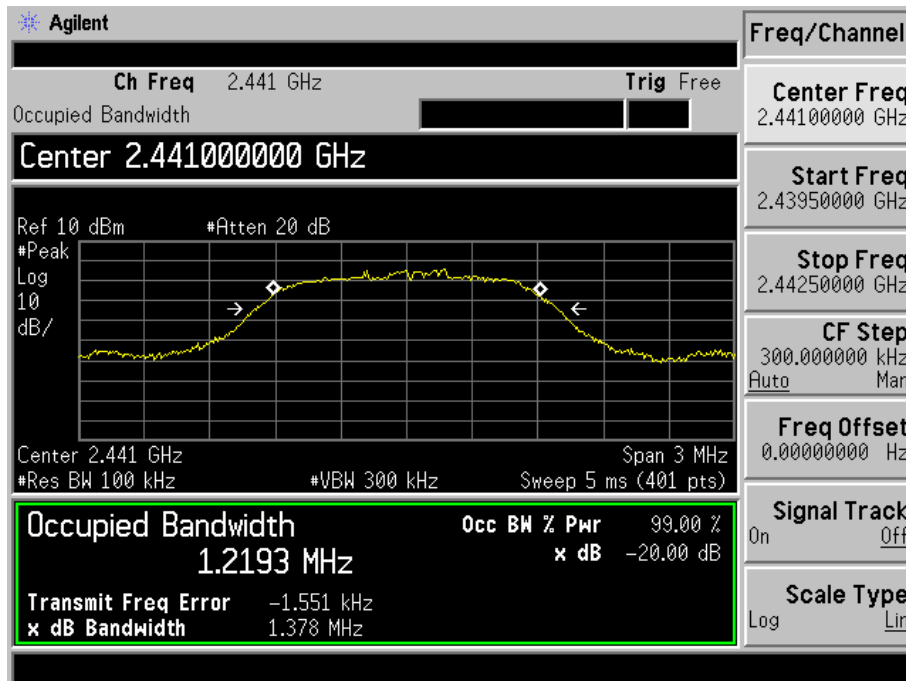

CH: 2480MHz

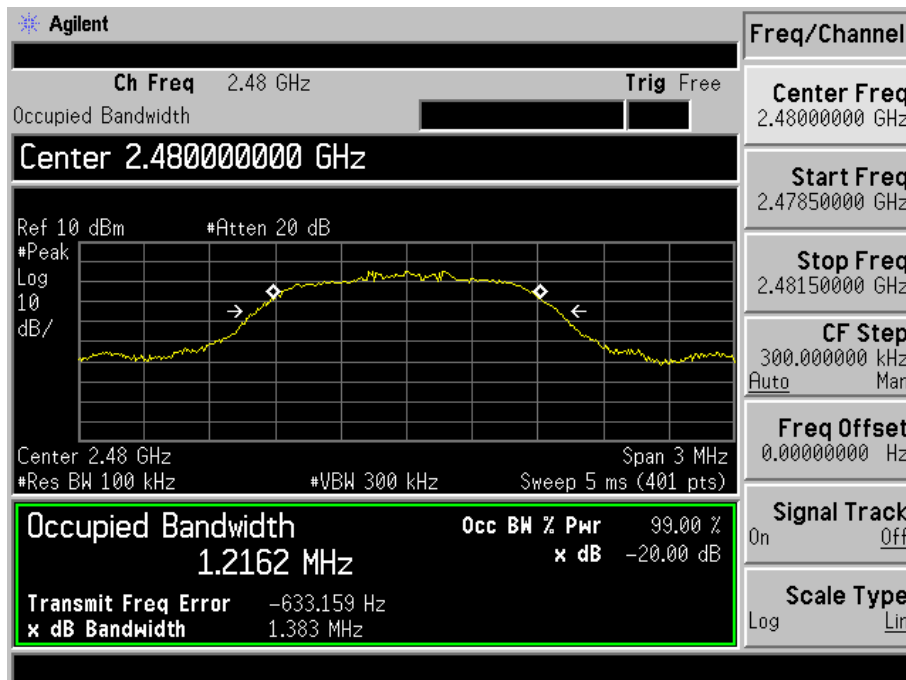

7 ANTENNA REQUIREMENT

Standard Applicable

For intentional device, according to FCC 47 CFR Section 15.203, an intentional radiator shall be designed to ensure that no antenna other than that furnished by the responsible party shall be used with the device. And according to FCC 47 CFR Section 15.249, if transmitting antennas of directional gain greater than 6dBi are used, the power shall be reduced by the amount in dB that the directional gain of the antenna exceeds 6dBi.

Refer to statement below for compliance.

The manufacturer may design the unit so that the user can replace a broken antenna, but the use of a standard antenna jack or electrical connector is prohibited. Further, this requirement does not apply to intentional radiators that must be professionally installed.

Antenna Connected Construction

The antenna used in this product is a PCB Antenna, The directional gains of antenna used for transmitting is 0dBi.

ANTENNA

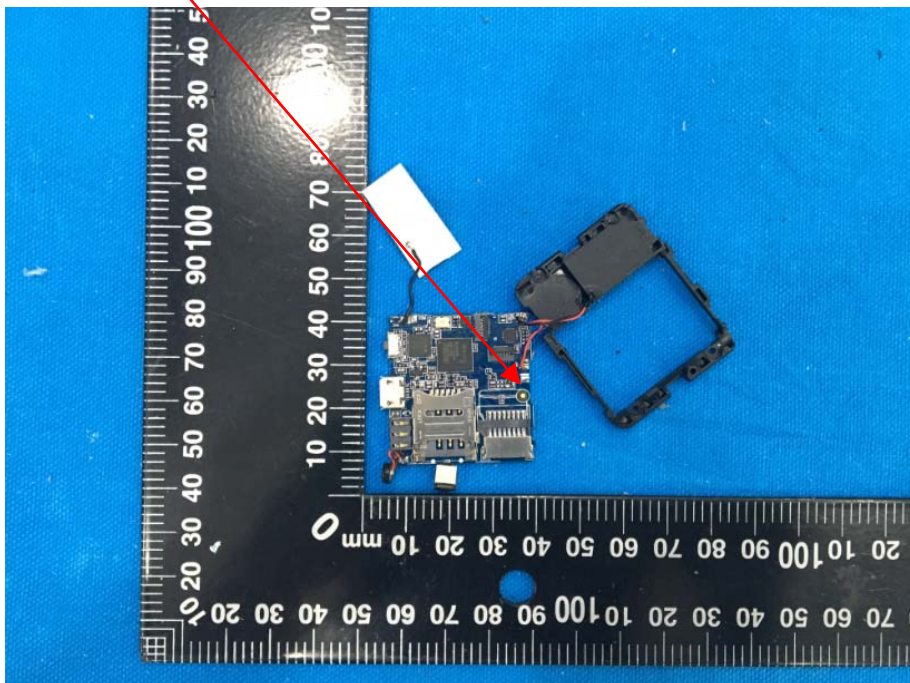

8 PHOTOGRAPH OF TEST

8.1 Radiated Emission

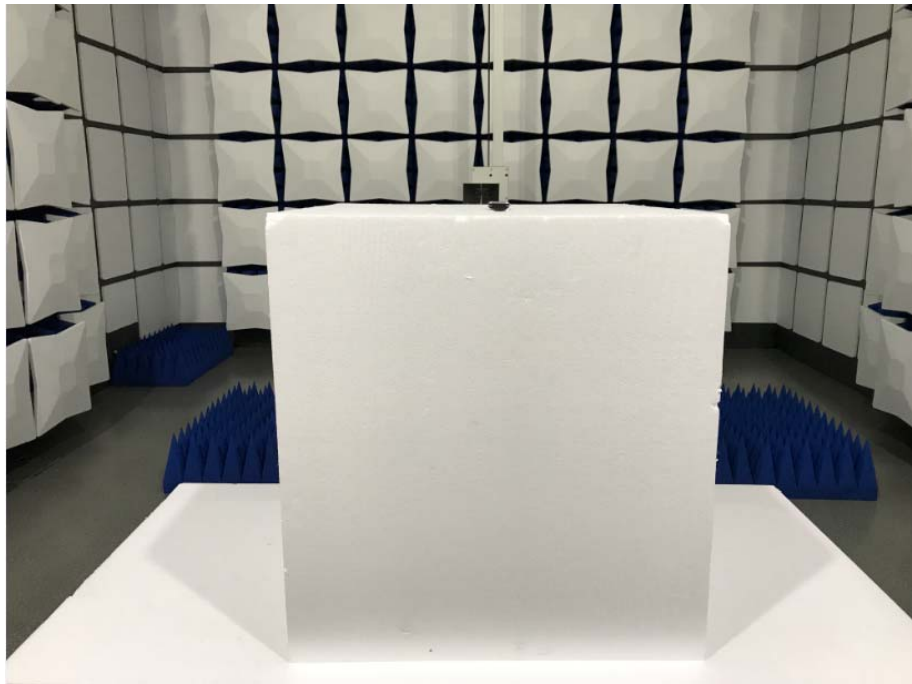
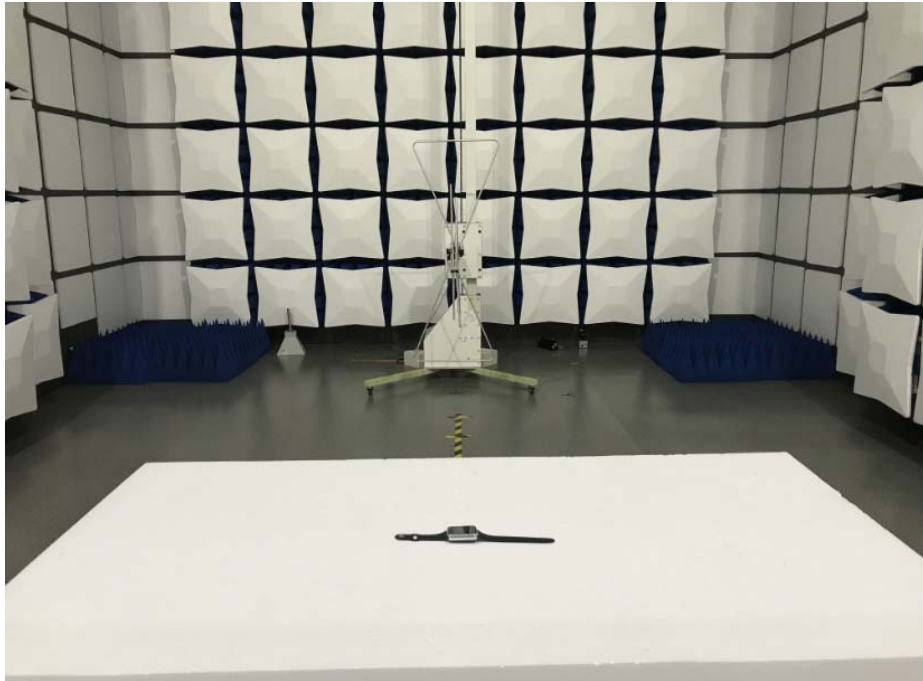

8.2 Conducted Emission

