

FCC RADIO TEST REPORT

FCC ID: 2ANMU-WP8PRO

Product: Smart Phone

Trade Mark: OUKITEL

Model No.: WP8 Pro

Family Model: N/A

Report No.: S20072301103004

Issue Date: 13 Oct.2020

Prepared for

SHENZHEN YUNJI INTELLIGENT TECHNOLOGY CO.,LTD
A2 2F BUILDING ENET NEW INDUSTRIAL PARK, DAFU INDUSTRIAL
ZONE, GUANLAN, LONGHUA SHENZHEN, 518XXX China

Prepared by

Shenzhen NTEK Testing Technology Co., Ltd.
1/F, Building E, Fenda Science Park Sanwei, Xixiang, Bao'an District
Shenzhen, Guangdong, China
Tel.: +86-755-6115 6588
Fax.: +86-755-6115 6599
Website:<http://www.ntek.org.cn>

TABLE OF CONTENTS

1	TEST RESULT CERTIFICATION	3
2	SUMMARY OF TEST RESULTS	4
3	FACILITIES AND ACCREDITATIONS	5
3.1	FACILITIES	5
3.2	LABORATORY ACCREDITATIONS AND LISTINGS	5
3.3	MEASUREMENT UNCERTAINTY	5
4	GENERAL DESCRIPTION OF EUT	6
5	DESCRIPTION OF TEST MODES	8
6	SETUP OF EQUIPMENT UNDER TEST	9
6.1	BLOCK DIAGRAM CONFIGURATION OF TEST SYSTEM	9
6.2	SUPPORT EQUIPMENT	10
6.3	EQUIPMENTS LIST FOR ALL TEST ITEMS	11
7	TEST REQUIREMENTS	12
7.1	FIELD STRENGTH OF SPURIOUS RADIATION	12
7.2	EFFECTIVE RADIATED POWER AND EFFECTIVE ISOTROPIC RADIATED POWER	23
7.3	CONDUCTED OUTPUT POWER	29
7.4	FREQUENCY STABILITY	31
7.5	PEAK-TO-AVERAGE RATIO	38
7.6	26DB BANDWIDTH AND 99% OCCUPIED BANDWIDTH	39
7.7	CONDUCTED BAND EDGE	41
7.8	CONDUCTED SPURIOUS EMISSION AT ANTENNA TERMINAL	42
8	TEST RESULTS	43
8.1	CONDUCTED OUTPUT POWER	43
8.2	PEAK-TO-AVERAGE RATIO	46
8.3	OCCUPIED BANDWIDTH	61
8.4	BAND EDGE	76
8.5	OUT-OF-BAND EMISSIONS	86

1 TEST RESULT CERTIFICATION

Applicant's name	SHENZHEN YUNJI INTELLIGENT TECHNOLOGY CO.,LTD
Address	A2 2F BUILDING ENET NEW INDUSTRIAL PARK, DAFU INDUSTRIAL ZONE, GUANLAN, LONGHUA SHENZHEN, 518XXX China
Manufacturer's Name	SHENZHEN YUNJI INTELLIGENT TECHNOLOGY CO.,LTD
Address	A2 2F BUILDING ENET NEW INDUSTRIAL PARK, DAFU INDUSTRIAL ZONE, GUANLAN, LONGHUA SHENZHEN, 518XXX China
Product description	
Product name	Smart Phone
Model and/or type reference	WP8 Pro
Family Model	N/A

Measurement Procedure Used:

APPLICABLE STANDARDS	
APPLICABLE STANDARD/ TEST PROCEDURE	TEST RESULT
47 CFR Part 2, Part 22H, Part 24E ANSI/TIA-603-E-2016 FCC KDB 971168 D01 Power Meas License Digital Systems v03r01 ANSI C63.26:2015	Complied

This device described above has been tested by Shenzhen NTEK Testing Technology Co., Ltd., and the test results show that the equipment under test (EUT) is in compliance with the FCC requirements. And it is applicable only to the tested sample identified in the report.

This report shall not be reproduced except in full, without the written approval of Shenzhen NTEK Testing Technology Co., Ltd., this document may be altered or revised by Shenzhen NTEK Testing Technology Co., Ltd., personnel only, and shall be noted in the revision of the document.

The test results of this report relate only to the tested sample identified in this report.

Date of Test : 23 Sep. 2020 ~ 13 Oct 2020

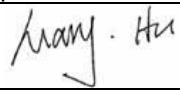
Testing Engineer : 
(Mary Hu)

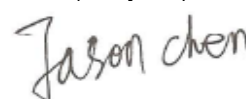
Technical Manager : 
(Jason Chen)

Authorized Signatory : 
(Alex Li)

2 SUMMARY OF TEST RESULTS

FCC Part22, Subpart H/ FCC Part24, Subpart E, FCC Part27, Subpart L, KDB 971168 D01 Power Meas License Digital Systems v03			
FCC Rule	Test Item	Verdict	Remark
2.1046	Conducted Output Power	PASS	2.1046
24.232(d) 27.50(d)(5) KDB 971168 D01 Clause 5.7	Peak-to-Average Ratio	PASS	
2.1049 22.917(b) 24.238(b) KDB 971168 D01 Clause 4.2	Occupied Bandwidth	PASS	
2.1051 22.917(a) 24.238(a) 27.53(h) KDB 971168 D01 Clause 6	Band Edge	PASS	
22.913(a)(5) KDB 971168 D01 Clause 5.6	Effective Radiated Power	PASS	
24.232(c) 27.50(d)(4) KDB 971168 D01 Clause 5.6	Equivalent Isotropic Radiated Power	PASS	
2.1053 22.917(a) 24.238(a) 27.53(h) KDB 971168 D01 Clause 7	Field Strength of Spurious Radiation	PASS	
2.1055 22.355 24.235 27.54 KDB 971168 D01 Clause 9	Frequency Stability for Temperature & Voltage	PASS	
2.1051 22.917(a) 24.238(a) 27.53(h) KDB 971168 D01 Clause 6	Conducted Emission	PASS	

Remark:

1. "N/A" denotes test is not applicable in this Test Report.
2. All test items were verified and recorded according to the standards and without any deviation during the test.
3. No modifications are made to the EUT during all test items.
4. This EUT has also been tested and complied with the requirements of FCC Part 15, Subpart B, recorded in a separate test report.

3 FACILITIES AND ACCREDITATIONS

3.1 FACILITIES

All measurement facilities used to collect the measurement data are located at 1/F, Building E, Fenda Science Park Sanwei, Xixiang, Bao'an District Shenzhen, Guangdong, China

The sites are constructed in conformance with the requirements of ANSI C63.7, ANSI C63.10 and CISPR Publication 22.

3.2 LABORATORY ACCREDITATIONS AND LISTINGS

Site Description

CNAS-Lab. : The Laboratory has been assessed and proved to be in compliance with CNAS-CL01:2006 (identical to ISO/IEC 17025:2005)
The Certificate Registration Number is L5516.

IC-Registration : The Certificate Registration Number is 9270A.
CAB identifier:CN0074

FCC- Accredited : Test Firm Registration Number: 463705.
Designation Number: CN1184

A2LA-Lab. : The Certificate Registration Number is 4298.01
This laboratory is accredited in accordance with the recognized International Standard ISO/IEC 17025:2005 General requirements for the competence of testing and calibration laboratories.
This accreditation demonstrates technical competence for a defined scope and the operation of a laboratory quality management system (refer to joint ISO-ILAC-IAF Communiqué dated 8 January 2009).

Name of Firm : Shenzhen NTEK Testing Technology Co., Ltd.

Site Location : 1/F, Building E, Fenda Science Park Sanwei, Xixiang, Bao'an District Shenzhen, Guangdong, China

3.3 MEASUREMENT UNCERTAINTY

The reported uncertainty of measurement, where expended uncertainty U is based on a standard uncertainty multiplied by a coverage factor of k=2, providing a level of confidence of approximately 95 %.

No.	Item	Uncertainty
1	Measuring Uncertainty for a Level of Confidence of 95% (U = 2Uc(y))	2.5dB

4 GENERAL DESCRIPTION OF EUT

Product Feature and Specification	
Equipment	Smart Phone
Trade Mark	OUKITEL
FCC ID	2ANMU-WP8PRO
Model No.	WP8 Pro
Family Model	N/A
Model Difference	N/A
Operating Frequency	<input checked="" type="checkbox"/> GSM850: TX824.2MHz~848.8MHz /RX869.2MHz~893.8MHz; <input checked="" type="checkbox"/> UMTS FDD Band V: TX826.4MHz~846.6MHz /RX871.4MHz~891.6MHz; <input checked="" type="checkbox"/> PCS1900: TX1850.2MHz~1909.8MHz /RX1930.2MHz~1989.8MHz; <input checked="" type="checkbox"/> UMTS FDD Band II: TX1852.4MHz~1907.6MHz /RX1932.4MHz~1987.6MHz; <input checked="" type="checkbox"/> UMTS-FDD Band IV: TX1710MHz~1755MHz /RX2110MHz~2155MHz
Modulation	<input checked="" type="checkbox"/> GMSK for GSM/GPRS; <input checked="" type="checkbox"/> 8PSK for EGPRS; <input checked="" type="checkbox"/> QPSK for UMTS bands;
GPRS Class	<input checked="" type="checkbox"/> Multi-Class12 <input checked="" type="checkbox"/> Only 4 timeslots are used for GPRS
SIM CARD	SIM 1 and SIM 2 is a chipset unit and tested as a single chipset. The SIM 1 is chosen for test.
Antenna Type	PIFA Antenna
Antenna Gain	GSM850:-0.63 dBi ,PCS1900: -0.52 dBi; WCDMA B II: 0.48 dBi, WCDMA BV: -0.65dBi, WCDMA Band IV: 0.42dBi
Power supply	<input checked="" type="checkbox"/> DC supply: DC 3.85V/5000mAh from Battery or DC 5V from Adapter.
	<input checked="" type="checkbox"/> Adapter supply: Model: HJ-0502000N2-US Input: AC 100~240V 50/60Hz 0.3A Output: 5.0V---2.0A
HW Version	TE598_MAIN_PCB_V1.1
SW Version	OUKITEL_WP8Pro_NOEEA_V01

Note: Based on the application, features, or specification exhibited in User's Manual, the EUT is considered as an ITE/Computing Device. More details of EUT technical specification, please refer to the User's Manual. The High Voltage 4.4V and Low Voltage 3.3V was declared by manufacturer, The EUT couldn't be operate normally with higher or lower voltage.

5 DESCRIPTION OF TEST MODES

During the testing, the EUT was controlled via Rhode & Schwarz Digital Radio Communication Tester(CMU 200) to ensure max power transmission and proper modulation. Three channels (The low channel, the middle channel and the high channel) were chosen for testing on all frequency band.

Note: GSM/GPRS/EGPRS 850, GSM/GPRS/EGPRS 1900, HSDPA band II, HSUPA band II, RMC 12.2k band II, HSDPA band IV, HSUPA band IV, RMC 12.2k band IV, HSDPA band V, HSUPA band V, RMC 12.2k band V modes have been tested during the test. the worst condition (GSM850, GSM1900, RMC 12.2k) be recorded in the test report if no other modes test data.

Antenna port conducted and radiated test items were performed according to KDB 971168 D01 Power Meas. License Digital Systems v03r01 with maximum output power.

Radiated measurements were performed with rotating EUT in different three orthogonal test planes to find the maximum emission.

Radiated emissions were investigated as following frequency range:

1. 30 MHz to 10th harmonic for GSM850/UMTS FDD Band V
2. 30 MHz to 10th harmonic for GSM1900/UMTS FDD Band II and Band IV.

All modes and data rates and positions were investigated.

Test modes are chosen to be reported as the worst case configuration below:

Test Modes		
Band	For Conducted Test Cases	For Radiated Test Cases
GSM 850	GSM Link	GSM Link
GSM 1900	GSM Link	GSM Link
UMTS Band II	RMC 12.2Kbps Link	RMC 12.2Kbps Link
UMTS Band V	RMC 12.2Kbps Link	RMC 12.2Kbps Link
UMTS Band IV	RMC 12.2Kbps Link	RMC 12.2Kbps Link

Test Frequency and Channels:

Frequency Band	<input checked="" type="checkbox"/> GSM 850		<input checked="" type="checkbox"/> GSM 1900		<input checked="" type="checkbox"/> UMTS Band II		<input checked="" type="checkbox"/> UMTS Band V	
	Channel	Frequency (MHz)	Channel	Frequency (MHz)	Channel	Frequency (MHz)	Channel	Frequency (MHz)
CH_H	251	848.8	810	1909.8	9538	1907.6	4233	846.6
CH_M	189	836.4	661	1880.0	9400	1880.0	4182	836.4
CH_L	128	824.2	512	1850.2	9262	1852.4	4132	826.4

Frequency Band	<input checked="" type="checkbox"/> UMTS Ban IV	
	Channel	Frequency (MHz)
CH_H	1513	1752.6
CH_M	1412	1732.4
CH_L	1312	1712.4

6 SETUP OF EQUIPMENT UNDER TEST

6.1 BLOCK DIAGRAM CONFIGURATION OF TEST SYSTEM

For Radiated Test Cases

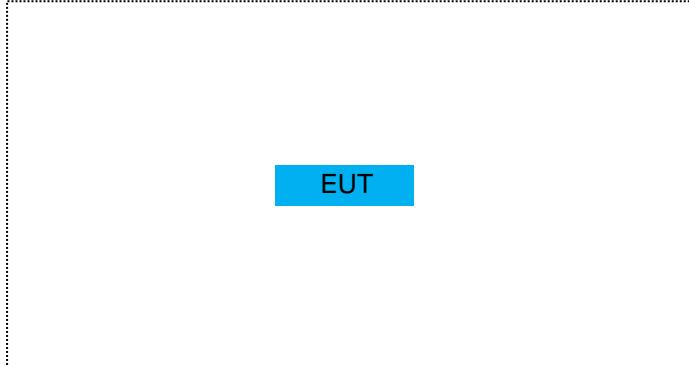

For Conducted Output Power

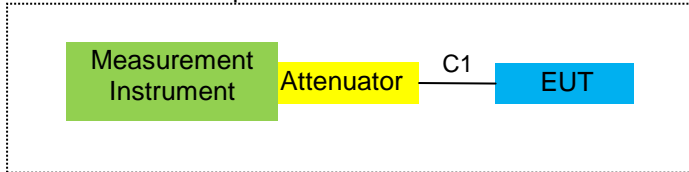

For Peak-to Average Ratio, Occupied Bandwidth, Conducted Band edge and Conducted Spurious Emission

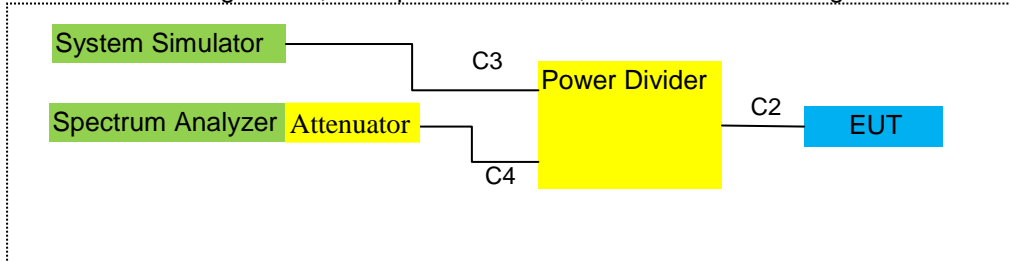

For Frequency Stability

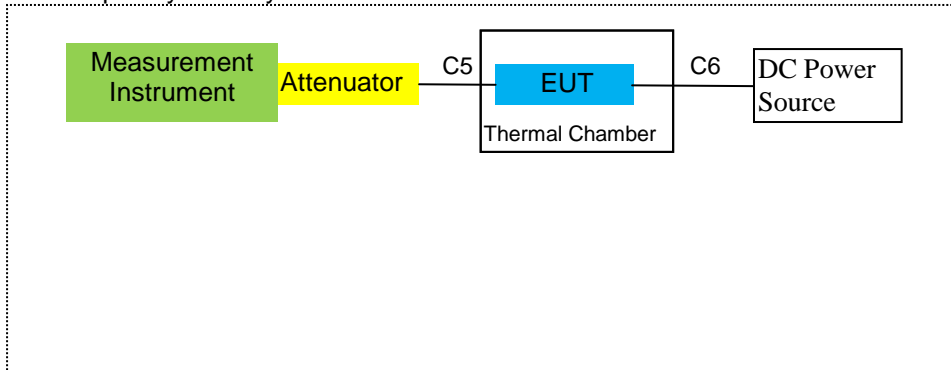

6.2 SUPPORT EQUIPMENT

The EUT has been tested as an independent unit together with other necessary accessories or support units. The following support units or accessories were used to form a representative test configuration during the tests.

Item	Equipment	Mfr/Brand	Model/Type No.	Series No.	Note

Item	Cable Type	Shielded Type	Ferrite Core	Length
C-1	RF Cable	YES	NO	0.1m
C-2	RF Cable	YES	NO	0.1m
C-3	RF Cable	YES	NO	0.1m
C-4	RF Cable	YES	NO	0.2m
C-5	RF Cable	YES	NO	0.2m
C-6	DC Cable	NO	NO	1.0m

Notes:

- (1) The support equipment was authorized by Declaration of Confirmation.
- (2) For detachable type I/O cable should be specified the length in cm in 『Length』 column.
- (3) “YES” is means “shielded” “with core”; “NO” is means “unshielded” “without core”.

6.3 EQUIPMENTS LIST FOR ALL TEST ITEMS

Item	Kind of Equipment	Manufacturer	Type No.	Serial No.	Last calibration	Calibrated until	Calibration period
1	MXA Signal Analyzer	Agilent	N9020A	MY49100060	2020.05.11	2021.05.10	1 year
2	Test Receiver	R&S	ESPI	101318	2020.05.11	2021.05.10	1 year
3	Bilog Antenna	TESEQ	CBL6111D	31216	2020.04.15	2021.04.14	1 year
4	50Ω Coaxial Switch	Anritsu	MP59B	6200983705	2020.05.11	2021.05.10	1 year
5	Horn Antenna	EM	EM-AH-10180	2011071402	2020.05.11	2021.05.10	1 year
6	Horn Ant	Schwarzbeck	BBHA 9170	9170-181	2020.04.15	2021.04.14	1 year
7	Amplifier	EM	EM-30180	060538	2020.7.13	2021.7.12	1 year
8	Loop Antenna	ARA	PLA-1030/B	1029	2020.05.11	2021.05.10	1 year
9	Power Meter	R&S	NRVS	100696	2020.7.13	2021.7.12	1 year
10	Power Sensor	R&S	URV5-Z4	0395.1619.05	2020.05.11	2021.05.10	1 year
11	Test Cable	N/A	R-01	N/A	2019.08.06	2022.08.05	3 year
12	Test Cable	N/A	R-02	N/A	2019.08.06	2022.08.05	3 year
13	Test Cable	N/A	R-03	N/A	2019.08.06	2022.08.05	3 year
14	Test Receiver	R&S	ESCI	101160	2020.05.11	2021.05.10	1 year
15	LISN	R&S	ENV216	101313	2020.04.15	2021.04.14	1 year
16	LISN	EMCO	3816/2	00042990	2020.05.11	2021.05.10	1 year
17	50Ω Coaxial Switch	Anritsu	MP59B	6200264417	2020.05.11	2021.05.10	1 year
18	Passive Voltage Probe	R&S	ESH2-Z3	100196	2020.04.11	2021.04.10	3 year
19	Test Cable	N/A	C01	N/A	2020.05.11	2023.05.10	3 year
20	Test Cable	N/A	C02	N/A	2020.05.11	2023.05.10	3 year
21	Test Cable	N/A	C03	N/A	2020.05.11	2021.05.10	1 year
22	Attenuator	MCE	24-10-34	BN9258	2020.04.15	2021.04.14	1 year
23	Spectrum Analyzer	agilent	e4440a	us44300399	2020.05.11	2021.05.10	1 year
24	test receiver	R&S	ESCI	a0304218	2020.05.11	2021.05.10	1 year
25	Communication Tester	R&S	CMU200	A0304247	2020.08.06	2021.08.05	1 year
26	Thermal Chamber	Ten Billion	TTC-B3C	TBN-960502	2020.05.11	2021.05.10	1 year
27	DC Power Source	N/A	PS-6005D	20170402923	2020.06.06	2023.06.05	3 year

Note: Each piece of equipment is scheduled for calibration once a year except the Test Cable& DC Power Source which is scheduled for calibration every 3 years.

7 TEST REQUIREMENTS

7.1 FIELD STRENGTH OF SPURIOUS RADIATION

7.1.1 Applicable Standard

According to FCC KDB 971168 D01 v03r01 Section 5.8 and ANSI/TIA-603-E-2016 Section 2.2.12

7.1.2 Conformance Limit

The power of any emission outside of the authorized operating frequency ranges must be attenuated below the transmitter power (P) by a factor of at least $43 + 10 \log (P)$ dB. The spectrum is scanned from 30 MHz up to a frequency including its 10th harmonic.

7.1.3 Measuring Instruments

The Measuring equipment is listed in the section 6.3 of this test report.

7.1.4 Test Configuration

According to the ANSI/TIA-603-E-2016 test method, The Receiver or Spectrum was scanned from 9 KHz to the 10th harmonic of the highest frequency generated within the equipment, which is the transmitted carrier that can be as high as 1910 MHz The resolution bandwidth is set as outlined in Part 24.238, Part 22.917. The spectrum is scanned with the mobile station transmitting at carrier frequencies that pertain to low, mid and high channels of WCDMA Band II / WCDMA Band V / WCDMA Band IV / GSM 850 / GSM 1900.

TEST CONFIGURATION

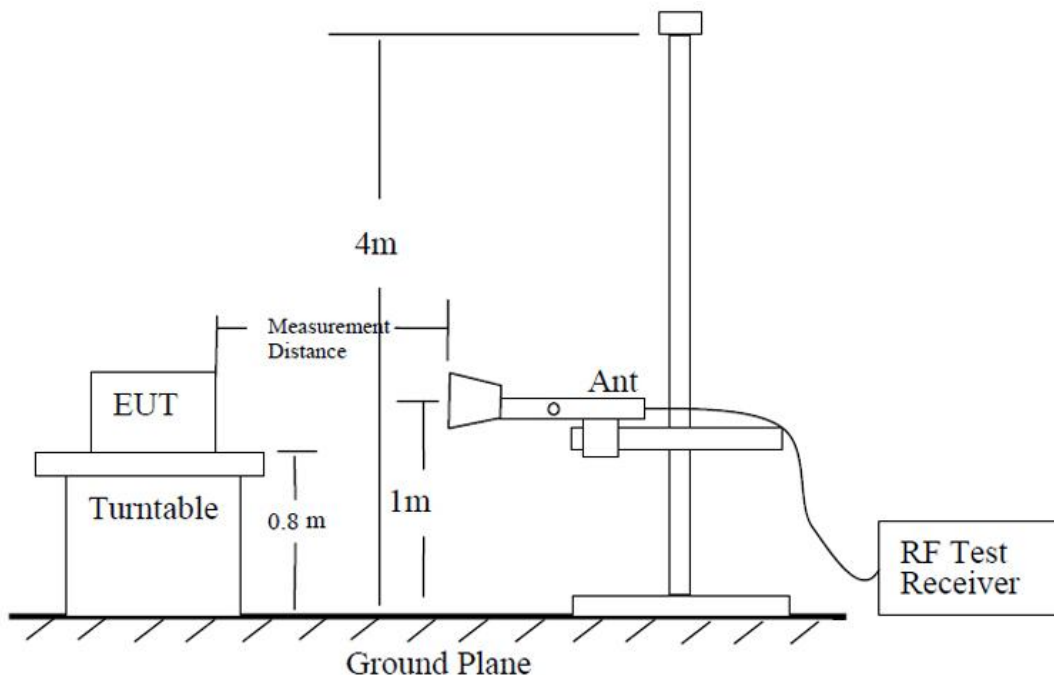



7.1.5 Test Procedure

1. EUT was placed on a 0.8 meter (For frequency above 1G, EUT should be placed on 1.5m) high non-conductive stand at a 3 meter test distance from the receive antenna. A receiving antenna was placed on the antenna mast 3 meters from the EUT for emission measurements. The height of receiving antenna is 1.50 meter. Detected emissions were maximized at each frequency by rotating the EUT through 360° and adjusting the receiving antenna polarization. The radiated emission measurements of all transmit frequencies in three channels (High, Middle, Low) were measured with peak detector.
2. A log-periodic antenna or double-ridged waveguide horn antenna shall be substituted in place of the EUT. The log-periodic antenna will be driven by a signal generator and the level will be adjusted till the same power value on the spectrum analyzer or receiver. The level of the spurious emissions can be calculated through the level of the signal generator, cable loss, the gain of the substitution antenna and the reading of the spectrum analyzer or receiver.
3. The EUT is then put into continuously transmitting mode at its maximum power level during the test. Set Test Receiver or Spectrum RBW=1MHz, VBW=3MHz, And the maximum value of the receiver should be recorded as (P_r).
4. The EUT shall be replaced by a substitution antenna. In the chamber, an substitution antenna for the frequency band of interest is placed at the reference point of the chamber. An RF Signal source for the frequency band of interest is connected to the substitution antenna with a cable that has been constructed to not interfere with the radiation pattern of the antenna. A power (SG Level) is applied to the input of the substitution antenna, and adjust the level of the signal generator output until the value of the receiver reach the previously recorded (P_r). The power of signal source (SG Level) is recorded. The test should be performed by rotating the test item and adjusting the receiving antenna polarization.
5. A amplifier should be connected to the Signal Source output port. And the cable should be connect between the Amplifier and the Substitution Antenna. The cable loss (Cable Loss) ,the Substitution Antenna Gain should be recorded after test.
The measurement results are obtained as described below:
Power(EIRP)= SG Level- Cable Loss+ Antenna Gain
6. This value is EIRP since the measurement is calibrated using an antenna of known gain (2.15 dBi) and known input power.
7. ERP can be calculated from EIRP by subtracting the gain of the dipole, ERP = EIRP -2.15dBi.

7.1.6 Test Results

EUT:	Smart Phone	Model No.:	WP8 Pro
Temperature:	20 °C	Relative Humidity:	48%
Test Mode:	GSM/GPRS/EGPRS 850/ GSM/GPRS/EGPRS 1900 UMTS band II/ UMTS band V UMTS band IV	Test By:	Mary Hu

■ Radiated Spurious Emission

GSM 850							
Frequency	SG Level	Cable Loss	Antenna Gain	Absolute Level	Limit	Over Limit	Polarity
(MHz)	(dBm)	(dB)	(dB)	(dBm)	(dBm)	(dBm)	
Test Results for Channel 128/824.2 MHz							
1648.4	-51.28	2.80	27.50	-26.58	-13	-13.58	Vertical
1648.4	-54.46	2.80	27.50	-29.76	-13	-16.76	Horizontal
2472.6	-49.71	2.91	27.80	-24.82	-13	-11.82	Vertical
2472.6	-53.77	2.91	27.80	-28.88	-13	-15.88	Horizontal
3296.8	-53.37	4.02	29.87	-27.52	-13	-14.52	Vertical
3296.8	-51.87	4.02	29.87	-26.02	-13	-13.02	Horizontal
Test Results for Channel 189/836.4 MHz							
1672.8	-51.52	2.80	27.48	-26.84	-13	-13.84	Vertical
1672.8	-52.01	2.80	27.48	-27.33	-13	-14.33	Horizontal
2509.2	-52.53	2.91	27.70	-27.74	-13	-14.74	Vertical
2509.2	-51.73	2.91	27.70	-26.94	-13	-13.94	Horizontal
3345.6	-54.11	4.02	29.82	-28.31	-13	-15.31	Vertical
3345.6	-53.34	4.02	29.82	-27.54	-13	-14.54	Horizontal
Test Results for Channel 251/848.8 MHz							
1697.6	-52.56	2.80	27.42	-27.94	-13	-14.94	Vertical
1697.6	-52.89	2.80	27.42	-28.27	-13	-15.27	Horizontal
2546.4	-51.62	2.91	27.68	-26.85	-13	-13.85	Vertical
2546.4	-54.66	2.91	27.68	-29.89	-13	-16.89	Horizontal
3395.2	-52.17	4.02	29.80	-26.39	-13	-13.39	Vertical
3395.2	-52.52	4.02	29.80	-26.74	-13	-13.74	Horizontal

Note:

1. Pre-test tests all modes, only the worst mode data is recorded in the report
2. All other emissions more than 20dB below the limit.

GPRS 850							
Frequency	SG Level	Cable Loss	Antenna Gain	Absolute Level	Limit	Over Limit	Polarity
(MHz)	(dBm)	(dB)	(dB)	(dBm)	(dBm)	(dBm)	
Test Results for Channel 128/824.2 MHz							
1648.4	-51.84	2.80	27.50	-27.14	-13	-14.14	Vertical
1648.4	-52.06	2.80	27.50	-27.36	-13	-14.36	Horizontal
2472.6	-51.69	2.91	27.80	-26.80	-13	-13.80	Vertical
2472.6	-53.57	2.91	27.80	-28.68	-13	-15.68	Horizontal
3296.8	-52.92	4.02	29.87	-27.07	-13	-14.07	Vertical
3296.8	-53.00	4.02	29.87	-27.15	-13	-14.15	Horizontal
Test Results for Channel 189/836.4 MHz							
1672.8	-52.25	2.80	27.48	-27.57	-13	-14.57	Vertical
1672.8	-53.15	2.80	27.48	-28.47	-13	-15.47	Horizontal
2509.2	-52.25	2.91	27.70	-27.46	-13	-14.46	Vertical
2509.2	-53.38	2.91	27.70	-28.59	-13	-15.59	Horizontal
3345.6	-51.66	4.02	29.82	-25.86	-13	-12.86	Vertical
3345.6	-53.34	4.02	29.82	-27.54	-13	-14.54	Horizontal
Test Results for Channel 251/848.8 MHz							
1697.6	-48.97	2.80	27.42	-24.35	-13	-11.35	Vertical
1697.6	-50.86	2.80	27.42	-26.24	-13	-13.24	Horizontal
2546.4	-52.77	2.91	27.68	-28.00	-13	-15.00	Vertical
2546.4	-51.53	2.91	27.68	-26.76	-13	-13.76	Horizontal
3395.2	-51.75	4.02	29.80	-25.97	-13	-12.97	Vertical
3395.2	-52.72	4.02	29.80	-26.94	-13	-13.94	Horizontal

Remark:

1. We were tested all Configuration refer 3GPP TS134 121.
2. Absolute Level = SG Level- Cable Loss+ Antenna Gain
3. Over Limit= Absolute Level (dBm)-Limit(dBm)

EGPRS 850							
Frequency	SG Level	Cable Loss	Antenna Gain	Absolute Level	Limit	Over Limit	Polarity
(MHz)	(dBm)	(dB)	(dB)	(dBm)	(dBm)	(dBm)	
Test Results for Channel 128/824.2 MHz							
1648.4	-50.95	2.80	27.50	-26.25	-13	-13.25	Vertical
1648.4	-51.34	2.80	27.50	-26.64	-13	-13.64	Horizontal
2472.6	-51.56	2.91	27.80	-26.67	-13	-13.67	Vertical
2472.6	-52.59	2.91	27.80	-27.70	-13	-14.70	Horizontal
3296.8	-54.33	4.02	29.87	-28.48	-13	-15.48	Vertical
3296.8	-50.96	4.02	29.87	-25.11	-13	-12.11	Horizontal
Test Results for Channel 189/836.4 MHz							
1672.8	-52.24	2.80	27.48	-27.56	-13	-14.56	Vertical
1672.8	-52.97	2.80	27.48	-28.29	-13	-15.29	Horizontal
2509.2	-50.65	2.91	27.70	-25.86	-13	-12.86	Vertical
2509.2	-53.04	2.91	27.70	-28.25	-13	-15.25	Horizontal
3345.6	-51.23	4.02	29.82	-25.43	-13	-12.43	Vertical
3345.6	-52.78	4.02	29.82	-26.98	-13	-13.98	Horizontal
Test Results for Channel 251/848.8 MHz							
1697.6	-48.24	2.80	27.42	-23.62	-13	-10.62	Vertical
1697.6	-50.22	2.80	27.42	-25.60	-13	-12.60	Horizontal
2546.4	-52.84	2.91	27.68	-28.07	-13	-15.07	Vertical
2546.4	-51.29	2.91	27.68	-26.52	-13	-13.52	Horizontal
3395.2	-50.77	4.02	29.80	-24.99	-13	-11.99	Vertical
3395.2	-52.12	4.02	29.80	-26.34	-13	-13.34	Horizontal

Remark:

1. We were tested all Configuration refer 3GPP TS134 121.
2. Absolute Level = SG Level- Cable Loss+ Antenna Gain
3. Over Limit= Absolute Level (dBm)-Limit(dBm)

GSM 1900							
Frequency	SG Level	Cable Loss	Antenna Factor	Absolute Level	Limit	Over Limit	Polarity
(MHz)	(dBm)	(dB)	(dB)	(dBm)	(dBm)	(dBm)	
Test Results for Channel 512/1850.2MHz							
3700.4	-52.47	4.04	33.51	-23.00	-13	-10.00	Vertical
3700.4	-49.65	4.04	33.51	-20.18	-13	-7.18	Horizontal
5550.6	-51.61	5.24	35.84	-21.01	-13	-8.01	Vertical
5550.6	-51.75	5.24	35.84	-21.15	-13	-8.15	Horizontal
Test Results for Channel 661/1880.0MHz							
3760	-50.89	4.04	33.56	-21.37	-13	-8.37	Vertical
3760	-53.75	4.04	33.56	-24.23	-13	-11.23	Horizontal
5640	-53.69	5.24	35.91	-23.02	-13	-10.02	Vertical
5640	-51.66	5.24	35.91	-20.99	-13	-7.99	Horizontal
Test Results for Channel 810/1909.8MHz							
3819.6	-52.70	4.04	34.00	-22.74	-13	-9.74	Vertical
3819.6	-51.31	4.04	34.00	-21.35	-13	-8.35	Horizontal
5729.4	-51.42	5.24	36.04	-20.62	-13	-7.62	Vertical
5729.4	-53.97	5.24	36.04	-23.17	-13	-10.17	Horizontal

Remark:

1. We were tested all Configuration refer 3GPP TS134 121.
2. Absolute Level = SG Level- Cable Loss+ Antenna Gain
3. Over Limit= Absolute Level (dBm)-Limit(dBm)

GPRS 1900							
Frequency	SG Level	Cable Loss	Antenna Factor	Absolute Level	Limit	Over Limit	Polarity
(MHz)	(dBm)	(dB)	(dB)	(dBm)	(dBm)	(dBm)	
Test Results for Channel 512/1850.2MHz							
3700.4	-53.45	4.04	33.51	-23.98	-13	-10.98	Vertical
3700.4	-52.29	4.04	33.51	-22.82	-13	-9.82	Horizontal
5550.6	-52.12	5.24	35.84	-21.52	-13	-8.52	Vertical
5550.6	-51.41	5.24	35.84	-20.81	-13	-7.81	Horizontal
Test Results for Channel 661/1880.0MHz							
3760	-55.89	4.04	33.56	-26.37	-13	-13.37	Vertical
3760	-55.00	4.04	33.56	-25.48	-13	-12.48	Horizontal
5640	-51.74	5.24	35.91	-21.07	-13	-8.07	Vertical
5640	-51.96	5.24	35.91	-21.29	-13	-8.29	Horizontal
Test Results for Channel 810/1909.8MHz							
3819.6	-50.91	4.04	34.00	-20.95	-13	-7.95	Vertical
3819.6	-51.71	4.04	34.00	-21.75	-13	-8.75	Horizontal
5729.4	-54.04	5.24	36.04	-23.24	-13	-10.24	Vertical
5729.4	-52.40	5.24	36.04	-21.60	-13	-8.60	Horizontal

Remark:

1. We were tested all Configuration refer 3GPP TS134 121.
2. Absolute Level = SG Level- Cable Loss+ Antenna Gain
3. Over Limit= Absolute Level (dBm)-Limit(dBm)

EGPRS 1900							
Frequency	SG Level	Cable Loss	Antenna Factor	Absolute Level	Limit	Over Limit	Polarity
(MHz)	(dBm)	(dB)	(dB)	(dBm)	(dBm)	(dBm)	
Test Results for Channel 512/1850.2MHz							
3700.4	-52.99	4.04	33.51	-23.52	-13	-10.52	Vertical
3700.4	-52.17	4.04	33.51	-22.70	-13	-9.70	Horizontal
5550.6	-54.03	5.24	35.84	-23.43	-13	-10.43	Vertical
5550.6	-51.80	5.24	35.84	-21.20	-13	-8.20	Horizontal
Test Results for Channel 661/1880.0MHz							
3760	-54.52	4.04	33.56	-25.00	-13	-12.00	Vertical
3760	-53.81	4.04	33.56	-24.29	-13	-11.29	Horizontal
5640	-53.07	5.24	35.91	-22.40	-13	-9.40	Vertical
5640	-51.28	5.24	35.91	-20.61	-13	-7.61	Horizontal
Test Results for Channel 810/1909.8MHz							
3819.6	-50.49	4.04	34.00	-20.53	-13	-7.53	Vertical
3819.6	-53.09	4.04	34.00	-23.13	-13	-10.13	Horizontal
5729.4	-53.36	5.24	36.04	-22.56	-13	-9.56	Vertical
5729.4	-53.13	5.24	36.04	-22.33	-13	-9.33	Horizontal

Remark:

1. We were tested all Configuration refer 3GPP TS134 121.
2. Absolute Level = SG Level- Cable Loss+ Antenna Gain
3. Over Limit= Absolute Level (dBm)-Limit(dBm)

WCDMA Band II							
Frequency	SG Level	Cable Loss	Antenna Factor	Absolute Level	Limit	Over Limit	Polarity
(MHz)	(dBm)	(dB)	(dB)	(dBm)	(dBm)	(dBm)	
Test Results for Channel 9262/1852.4MHz							
3700.8	-54.16	4.04	33.51	-24.69	-13	-11.69	Vertical
3700.8	-54.66	4.04	33.51	-25.19	-13	-12.19	Horizontal
5551.2	-52.80	5.24	35.84	-22.20	-13	-9.20	Vertical
5551.2	-51.66	5.24	35.84	-21.06	-13	-8.06	Horizontal
Test Results for Channel 9400/1880MHz							
3760	-54.57	4.04	33.56	-25.05	-13	-12.05	Vertical
3760	-52.74	4.04	33.56	-23.22	-13	-10.22	Horizontal
5640	-50.76	5.24	35.91	-20.09	-13	-7.09	Vertical
5640	-53.07	5.24	35.91	-22.40	-13	-9.40	Horizontal
Test Results for Channel 9538/1907.6MHz							
3819.2	-53.64	4.04	34.00	-23.68	-13	-10.68	Vertical
3819.2	-49.77	4.04	34.00	-19.81	-13	-6.81	Horizontal
5728.8	-53.42	5.24	36.04	-22.62	-13	-9.62	Vertical
5728.8	-52.17	5.24	36.04	-21.37	-13	-8.37	Horizontal

Remark:

1. We were tested all Configuration refer 3GPP TS134 121.
2. Absolute Level = SG Level- Cable Loss+ Antenna Gain
3. Over Limit= Absolute Level (dBm)-Limit(dBm)

WCDMA Band IV							
Frequency	SG Level	Cable Loss	Antenna Factor	Absolute Level	Limit	Over Limit	Polarity
(MHz)	(dBm)	(dB)	(dB)	(dBm)	(dBm)	(dBm)	
Test Results for Channel 9262/1852.4MHz							
3424.8	-55.16	4.01	33.51	-25.66	-13	-12.66	Vertical
3424.8	-54.84	4.01	33.51	-25.34	-13	-12.34	Horizontal
5137.2	-53.40	5.13	35.84	-22.69	-13	-9.69	Vertical
5137.2	-53.55	5.13	35.84	-22.84	-13	-9.84	Horizontal
Test Results for Channel 9400/1880MHz							
3465.2	-53.84	4.02	33.56	-24.30	-13	-11.30	Vertical
3465.2	-53.97	4.02	33.56	-24.43	-13	-11.43	Horizontal
5197.8	-52.32	5.19	35.91	-21.60	-13	-8.60	Vertical
5197.8	-52.47	5.19	35.91	-21.75	-13	-8.75	Horizontal
Test Results for Channel 9538/1907.6MHz							
3505.2	-53.12	4.03	34.00	-23.15	-13	-10.15	Vertical
3505.2	-53.20	4.03	34.00	-23.23	-13	-10.23	Horizontal
5257.8	-53.93	5.18	36.04	-23.07	-13	-10.07	Vertical
5257.8	-53.57	5.18	36.04	-22.71	-13	-9.71	Horizontal

Remark:

1. We were tested all Configuration refer 3GPP TS134 121.
2. Absolute Level = SG Level- Cable Loss+ Antenna Gain
3. Over Limit= Absolute Level (dBm)-Limit(dBm)

WCDMA Band V							
Frequency	SG Level	Cable Loss	Antenna Gain	Absolute Level	Limit	Over Limit	Polarity
(MHz)	(dBm)	(dB)	(dB)	(dBm)	(dBm)	(dBm)	
Test Results for Channel 4233/846.6MHz							
1673.2	-51.94	2.80	27.50	-27.24	-13	-14.24	Vertical
1673.2	-51.28	2.80	27.50	-26.58	-13	-13.58	Horizontal
2509.8	-50.36	2.91	27.80	-25.47	-13	-12.47	Vertical
2509.8	-54.56	2.91	27.80	-29.67	-13	-16.67	Horizontal
3346.4	-50.48	4.02	29.87	-24.63	-13	-11.63	Vertical
3346.4	-50.86	4.02	29.87	-25.01	-13	-12.01	Horizontal
Test Results for Channel 4182/836.4MHz							
1672.8	-49.15	2.80	27.48	-24.47	-13	-11.47	Vertical
1672.8	-52.47	2.80	27.48	-27.79	-13	-14.79	Horizontal
2509.2	-52.07	2.91	27.70	-27.28	-13	-14.28	Vertical
2509.2	-51.87	2.91	27.70	-27.08	-13	-14.08	Horizontal
3345.6	-49.53	4.02	29.82	-23.73	-13	-10.73	Vertical
3345.6	-52.65	4.02	29.82	-26.85	-13	-13.85	Horizontal
Test Results for Channel 4132/826.4MHz							
1652.8	-56.36	2.80	27.42	-31.74	-13	-18.74	Vertical
1652.8	-49.22	2.80	27.42	-24.60	-13	-11.60	Horizontal
2479.2	-53.05	2.91	27.68	-28.28	-13	-15.28	Vertical
2479.2	-53.52	2.91	27.68	-28.75	-13	-15.75	Horizontal
3305.6	-53.32	4.02	29.80	-27.54	-13	-14.54	Vertical
3305.6	-52.96	4.02	29.80	-27.18	-13	-14.18	Horizontal

Remark:

1. We were tested all Configuration refer 3GPP TS134 121.
2. Absolute Level = SG Level- Cable Loss+ Antenna Gain
3. Over Limit= Absolute Level (dBm)-Limit(dBm)

7.2 EFFECTIVE RADIATED POWER AND EFFECTIVE ISOTROPIC RADIATED POWER

7.2.1 Applicable Standard

According to FCC KDB 971168 D01 v03r01 Section 5.2.1/ Section 5.2.2.2 and ANSI/TIA-603-E-2016 Section 2.2.17

7.2.2 Conformance Limit

The substitution method, in ANSI/TIA-603-E-2016, was used for ERP/EIRP measurement, and the spectrum analyzer configuration follows KDB 971168 D01 Power Meas. License Digital Systems v03r01. The ERP of mobile transmitters must not exceed 7 Watts (Cellular Band) and the EIRP of mobile transmitters are limited to 2 Watts (PCS Band).

7.2.3 Measuring Instruments

The Measuring equipment is listed in the section 6.3 of this test report.

7.2.4 Test Configuration

Please refer to Section 7.1.4 of this test report.

7.2.5 Test Procedure

The measurements procedures specified in ANSI/TIA-603-E-2016 were applied. In an anechoic antenna test chamber, a half-wave dipole antenna for the frequency band of interest is placed at the reference centre of the chamber. An RF Signal source for the frequency band of interest is connected to the dipole with a cable that has been constructed to not interfere with the radiation pattern of the antenna. A known (measured) power (P_{in}) is applied to the input of the dipole, and the power received (P_r) at the chamber's probe antenna is recorded.

The relevant equation for determining the ERP or EIRP from the conducted RF output power measured using the guidance provided above is:

$$ERP/EIRP = SGLevel - P_{cl} + G_a$$

where:

ERP/EIRP = effective or equivalent radiated power, respectively (expressed in the same units as SGLevel, typically dBW or dBm);

SGLevel = Signal generator output power or PSD, in dBm or dBW;

G_a = gain of the transmitting antenna, in dBd (ERP) or dBi (EIRP);

P_{cl} = signal attenuation in the connecting cable between the transmitter and antenna, in dB.²

The EUT is substituted for the dipole at the reference centre of the chamber and a scan is performed to obtain the radiation pattern.

From the radiation pattern, the co-ordinates where the maximum antenna gain occurs are identified.

The EUT is then put into continuously transmitting mode at its maximum power level.

Power mode measurements are performed with the receiving antenna placed at the coordinates determined in Step 3 to determine the output power as defined in Rule 24.232 (b) and (c). The "reference path loss" from Step1 is added to this result.

This value is EIRP since the measurement is calibrated using a half-wave dipole antenna of known gain (2.15 dBi) and known input power (Pin).

ERP can be calculated from EIRP by subtracting the gain of the dipole, $ERP = EIRP - 2.15dBi$.

Both horizontal and vertical antenna polarities were tested and performed pretest to three orthogonal axis. The worst case emissions were reported.

Substitution antenna and Receiving Antenna:

Item	Kind of Equipment	Manufacturer	Type No.	Serial No.	Character	Note
1	Bilog Antenna	TESEQ	CBL6111D	31216	30MHz~2GHz	Receiving Antenna
2	Horn Antenna	EM	EM-AH-10180	2011071402	1GHz~18GHz	Receiving Antenna
3	Bilog Antenna	TESEQ	CBL6111D	31216	30MHz~2GHz	Substitution antenna
4	Horn Antenna	EM	EM-AH-10180	2011071402	1GHz~18GHz	Substitution antenna

Use the following spectrum analyzer settings:

	GSM/GPRS/EGPRS	UMTS band
Span	500KHz	10MHz
RBW	10KHz	300KHz
VBW	30KHz	1MHz
Detector	RMS	RMS
Trace	Average	Average
Average Type	Power	Power
Sweep Count	100	100

7.2.6 Test Results

EUT:	Smart Phone	Model No.:	WP8 Pro
Temperature:	20 °C	Relative Humidity:	48%
Test Mode:	GSM/GPRS/EGPRS 850/ GSM/GPRS/EGPRS 1900 UMTS band II/ UMTS band V UMTS band IV	Test By:	Mary Hu

■ Effective Radiated Power

Radiated Power (ERP) for GSM850							
Frequency	Polarization	SG Level	Pcl	Ga Antenna Gain	Correction	ERP	ERP
(MHz)		(dBm)	(dB)	(dB)	(dB)	(dBm)	(W)
824.2	H	12.02	2.11	23.84	2.15	31.60	1.44388
836.6	H	11.57	2.13	23.15	2.15	30.44	1.10705
848.8	H	12.14	2.13	23.06	2.15	30.92	1.23461
824.2	V	12.77	2.11	23.11	2.15	31.62	1.45095
836.6	V	12.10	2.13	23.07	2.15	30.89	1.22842
848.8	V	11.68	2.13	23.25	2.15	30.65	1.16099

Radiated Power (ERP) for GPRS850							
Frequency	Polarization	SG Level	Pcl	Ga Antenna Gain	Correction	ERP	ERP
(MHz)		(dBm)	(dB)	(dB)	(dB)	(dBm)	(W)
824.2	H	11.99	2.11	23.84	2.15	31.57	1.43506
836.6	H	12.09	2.13	23.15	2.15	30.96	1.24609
848.8	H	12.38	2.13	23.06	2.15	31.16	1.30689
824.2	V	12.42	2.11	23.11	2.15	31.27	1.34059
836.6	V	12.51	2.13	23.07	2.15	31.30	1.34855
848.8	V	12.36	2.13	23.25	2.15	31.33	1.35831

Radiated Power (ERP) for EGPRS850							
Frequency	Polarization	SG Level	Pcl	Ga Antenna Gain	Correction	ERP	ERP
(MHz)		(dBm)	(dB)	(dB)	(dB)	(dBm)	(W)
824.2	H	7.11	2.11	23.84	2.15	26.69	0.46719
836.6	H	7.73	2.13	23.15	2.15	26.60	0.45660
848.8	H	7.86	2.13	23.06	2.15	26.64	0.46111
824.2	V	8.16	2.11	23.11	2.15	27.01	0.50197
836.6	V	8.11	2.13	23.07	2.15	26.90	0.48931
848.8	V	7.56	2.13	23.25	2.15	26.53	0.44938

Radiated Power (ERP) for UMTS band V							
Frequency	Polarization	SG Level	Pcl	Ga	Correction	ERP	ERP
(MHz)		(dBm)	(dB)	Antenna Gain (dB)		(dBm)	(W)
826.4	H	3.12	2.11	23.84	2.15	22.7	0.18621
835	H	3.24	2.13	23.15	2.15	22.11	0.16255
846.6	H	3.46	2.13	23.06	2.15	22.24	0.16749
826.4	V	3.72	2.11	23.11	2.15	22.57	0.18072
835	V	3.74	2.13	23.07	2.15	22.53	0.17906
846.6	V	3.69	2.13	23.25	2.15	22.66	0.18450

Note:

SG Level= Signal generator output

Pcl= cable loss

Ga= Antenna Gain

Peak EIRP(dBm)= SGLevel -Pcl +Ga

ERP(dBm)=EIRP-2.15

■ Effective Isotropic Radiated Power

Radiated Power (E.I.R.P) for GSM1900						
Frequency	Polarization	SG Level	Pcl	Ga Antenna Gain	EIRP	EIRP
(MHz)		(dBm)	(dB)	(dB)	(dBm)	(W)
1850.2	H	5.24	3.76	28.24	29.72	0.93779
1880	H	5.31	3.91	28.22	29.62	0.91703
1909.8	H	5.91	3.93	28.20	30.18	1.04208
1850.2	V	5.55	3.76	27.32	29.11	0.81408
1880	V	5.36	3.91	27.33	28.78	0.75543
1909.8	V	6.22	3.93	27.31	29.60	0.91101

Radiated Power (E.I.R.P) for GPRS1900						
Frequency	Polarization	SG Level	Pcl	Ga Antenna Gain	EIRP	EIRP
(MHz)		(dBm)	(dB)	(dB)	(dBm)	(W)
1850.2	H	5.89	3.76	28.24	30.37	1.08893
1880	H	5.60	3.91	28.22	29.91	0.98032
1909.8	H	5.95	3.93	28.20	30.22	1.05169
1850.2	V	6.17	3.76	27.32	29.73	0.93929
1880	V	5.79	3.91	27.33	29.21	0.83290
1909.8	V	5.61	3.93	27.31	28.99	0.79160

Radiated Power (E.I.R.P) for EGPRS1900						
Frequency	Polarization	SG Level	Pcl	Ga Antenna Gain	EIRP	EIRP
(MHz)		(dBm)	(dB)	(dB)	(dBm)	(W)
1850.2	H	2.18	3.76	28.24	26.66	0.46343
1880	H	1.16	3.91	28.22	25.47	0.35271
1909.8	H	1.82	3.93	28.20	26.09	0.40664
1850.2	V	1.91	3.76	27.32	25.47	0.35199
1880	V	1.85	3.91	27.33	25.27	0.33632
1909.8	V	1.48	3.93	27.31	24.86	0.30608

Radiated Power (E.I.R.P) for UMTS band II						
Frequency	Polarization	SG Level	Pcl	Ga Antenna Gain	EIRP	EIRP
(MHz)		(dBm)	(dB)	(dB)	(dBm)	(W)
1852.4	H	-0.70	3.76	28.24	23.78	0.23878
1880	H	-0.84	3.91	28.22	23.47	0.22233
1907.6	H	-0.77	3.93	28.20	23.5	0.22387
1852.4	V	-0.37	3.76	27.32	23.19	0.20845
1880	V	-0.31	3.91	27.33	23.11	0.20464
1907.6	V	-0.37	3.93	27.31	23.01	0.19999

Radiated Power (E.I.R.P) for UMTS band IV						
Frequency	Polarization	SG Level	Pcl	Ga Antenna Gain	EIRP	EIRP
(MHz)		(dBm)	(dB)	(dB)	(dBm)	(W)
1712.4	H	-0.85	3.72	28.24	23.67	0.23281
1732.6	H	-0.66	3.90	28.22	23.66	0.23227
1752.6	H	-0.69	3.91	28.20	23.6	0.22909
1712.4	V	-0.81	3.76	27.32	22.75	0.18836
1732.6	V	-0.61	3.89	27.33	22.83	0.19187
1752.6	V	-1.04	3.92	27.31	22.35	0.17179

Note:

SG Level= Signal generator output

Pcl= cable loss

Ga= Antenna Gain

Peak EIRP(dBm)= SGLevel -Pcl+Ga.

7.3 CONDUCTED OUTPUT POWER

7.3.1 Applicable Standard

According to FCC Part 2.1046 and FCC Part 22.913(a)(2) and FCC Part 24.232(c) and FCC KDB 971168 D01 v03r01 Section 5.2

7.3.2 Conformance Limit

Extend coverage on a secondary basis into cellular unserved areas, as those areas are defined in §22.949, the ERP of base transmitters and cellular repeaters of such systems must not exceed 1000 Watts. The ERP of mobile transmitters and auxiliary test transmitters must not exceed 7 Watts(38.5dBm).

Mobile and portable stations are limited to 2 watts (33dBm)EIRP and the equipment must employ a means for limiting power to the minimum necessary for successful communications..

7.3.3 Measuring Instruments

The Measuring equipment is listed in the section 6.3 of this test report.

7.3.4 Test Setup

Please refer to Section 6.1 of this test report.

7.3.5 Test Procedure

Connect the EUT to Universal Radio Communication Tester CMU200 or CMU500 via the antenna connector. A call is set up by the SS according to the generic call set up procedure on a channel with ARFCN in the ARFCN range, power control level set to Max power. The frequency band is set as selected frequency, The RF output of the transmitter was connected to base station simulator.

Set EUT at maximum average power by base station simulator.

Set RBW = 1-5% of the OBW, not to exceed 1 MHz.

Set VBW $\geq 3 \times$ RBW.

Number of points in sweep $\geq 2 \times$ span / RBW. (This gives bin-to-bin spacing \leq RBW/2, so that narrowband signals are not lost between frequency bins.)

Sweep time = auto.

Detector = RMS (power averaging).

Set sweep trigger to "free run".

Trace average at least 100 traces in power averaging (i.e., RMS) mode; however, the number of traces to be averaged shall be increased above 100 as needed such that the average accurately represents the true average over the on and off periods of the transmitter.

Compute power by integrating the spectrum across the OBW of the signal using the instrument's band power measurement function with band limits set equal to the OBW band edges. If the instrument does not have a band power function, sum the spectrum levels (in power units) at intervals equal to the RBW extending across the entire OBW of the spectrum.

Add $10 \log(1/x)$, where x is the duty cycle, to the measured power in order to compute the average power during the actual transmission times (because the measurement represents an average over both the on and off times of the transmission). For example, add $10 \log(1/0.25) = 6$ dB if the duty cycle is a constant 25%.

Measure lowest, middle, and highest channels for each bandwidth and different modulation.

Measure and record the results in the test report.

7.3.6 Test Results

EUT:	Smart Phone	Model No.:	WP8 Pro
Temperature:	20 °C	Relative Humidity:	48%
Test Mode:	GSM/GPRS/EGPRS 850/ GSM/GPRS/EGPRS 1900 UMTS band II/ UMTS band V UMTS band IV	Test By:	Mary Hu

Test data reference attachment

7.4 FREQUENCY STABILITY

7.4.1 Applicable Standard

According to FCC Part 2.1055 and FCC Part 22.355 and FCC Part 24.235 and FCC KDB 971168 D01 Section 9.0

7.4.2 Conformance Limit

The frequency stability shall be measured by variation of ambient temperature and variation of primary supply voltage to ensure that the fundamental emission stays within the authorized frequency block. The frequency stability of the transmitter shall be maintained within $\pm 0.00025\%$ ($\pm 2.5\text{ppm}$) of the center frequency.

7.4.3 Measuring Instruments

The Measuring equipment is listed in the section 6.3 of this test report.

7.4.4 Test Setup

Please refer to Section 6.1 of this test report.

7.4.5 Test Procedure

Connect the EUT to Universal Radio Communication Tester CMU200 or CMU500 via the antenna connector. A call is set up by the SS according to the generic call set up procedure on a channel with ARFCN in the ARFCN range, power control level set to Max power. MS TXPWR_MAX_CCH is set to the maximum value supported by the Power Class of the Mobile under test.

EUT was placed at temperature chamber and connected to an external power supply.

Temperature and voltage condition shall be tested to confirm frequency stability.

For Temperature Variation

1. The testing follows FCC KDB 971168 D01 v03r01 Section 9.0.
2. The EUT was set up in the thermal chamber and connected with the system simulator.
3. With power OFF, the temperature was decreased to -30°C and the EUT was stabilized before testing. Power was applied and the maximum change in frequency was recorded within one minute.
4. With power OFF, the temperature was raised in 10°C steps up to 50°C . The EUT was stabilized at each step for at least half an hour. Power was applied and the maximum frequency change was recorded within one minute.

For Voltage Variation

1. The testing follows FCC KDB 971168 D01 v03r01 Section 9.0.
2. The EUT was placed in a temperature chamber at $25\pm 5^{\circ}\text{C}$ and connected with the system simulator.
3. The power supply voltage to the EUT was varied from 85% to 115% of the nominal value measured at the input to the EUT.
4. The variation in frequency was measured for the worst case.

7.4.6 Test Results

EUT:	Smart Phone	Model No.:	WP8 Pro
Temperature:	20 °C	Relative Humidity:	48%
Test Mode:	GSM/GPRS/EGPRS 850/ GSM/GPRS/EGPRS 1900 UMTS band II/ UMTS band V UMTS band IV	Test By:	Mary Hu
Results: PASS			

Frequency Error Against Voltage for GSM 850 band		
Voltage (V)	Frequency Error (Hz)	Frequency Error (ppm)
3.3	7	0.0084
3.85	11	0.0132
4.4	10	0.0120

Frequency Error Against Temperature for GSM 850 band		
Temperature (°C)	Frequency Error (Hz)	Frequency Error (ppm)
-30	13	0.0155
-20	10	0.0120
-10	11	0.0132
0	8	0.0096
10	6.5	0.0078
20	4.5	0.0054
30	5	0.0060
40	7	0.0084
50	12	0.0143

Frequency Error Against Voltage for GPRS850 band		
Voltage (V)	Frequency Error (Hz)	Frequency Error (ppm)
3.3	3	0.0036
3.85	7	0.0084
4.4	6	0.0072

Frequency Error Against Temperature for GPRS850 band		
Temperature (°C)	Frequency Error (Hz)	Frequency Error (ppm)
-30	9	0.0108
-20	6	0.0072
-10	7	0.0084
0	4	0.0048
10	2.5	0.0030
20	0.5	0.0006
30	1	0.0012
40	3	0.0036
50	8	0.0096

Frequency Error Against Voltage for EGPRS850 band		
Voltage (V)	Frequency Error (Hz)	Frequency Error (ppm)
3.3	9	0.0108
3.85	13	0.0155
4.4	12	0.0143

Frequency Error Against Temperature for EGPRS850 band		
Temperature (°C)	Frequency Error (Hz)	Frequency Error (ppm)
-30	15	0.0179
-20	12	0.0143
-10	13	0.0155
0	10	0.0120
10	8.5	0.0102
20	6.5	0.0078
30	7	0.0084
40	9	0.0108
50	14	0.0167

Note:

1. Normal Voltage = 3.85V; Battery End Point (BEP) = 3.3V; Maximum Voltage = 4.4V
2. The frequency fundamental emissions stay within the authorized frequency block based on the frequency deviation measured is small.

Frequency Error Against Voltage for PCS 1900 band		
Voltage (V)	Frequency Error (Hz)	Frequency Error (ppm)
3.3	7	0.0037
3.85	11	0.0059
4.4	10	0.0053

Frequency Error Against Temperature for PCS 1900 band		
Temperature (°C)	Frequency Error (Hz)	Frequency Error (ppm)
-30	12	0.0143
-20	9	0.0048
-10	10	0.0053
0	7	0.0037
10	5.5	0.0066
20	3.5	0.0042
30	4	0.0048
40	6	0.0072
50	11	0.0131

Frequency Error Against Voltage for GPRS1900 band		
Voltage (V)	Frequency Error (Hz)	Frequency Error (ppm)
3.3	7	0.0037
3.85	6.6	0.0035
4.4	5	0.0027

Frequency Error Against Temperature for GPRS1900 band		
Temperature (°C)	Frequency Error (Hz)	Frequency Error (ppm)
-30	5	0.0027
-20	2	0.0011
-10	3	0.0016
0	3	0.0016
10	-2	-0.0011
20	4	0.0021
30	4	0.0021
40	3	0.0016
50	4	0.0021

Frequency Error Against Voltage for EGPRS1900 band		
Voltage (V)	Frequency Error (Hz)	Frequency Error (ppm)
3.3	11.5	0.0061
3.85	9.4	0.0050
4.4	3	0.0016

Frequency Error Against Temperature for EGPRS1900 band		
Temperature (°C)	Frequency Error (Hz)	Frequency Error (ppm)
-30	8	0.0043
-20	9	0.0048
-10	10	0.0053
0	9	0.0048
10	7	0.0037
20	5	0.0027
30	5	0.0027
40	4	0.0021
50	4	0.0021

Note:

1. Normal Voltage = 3.85V; Battery End Point (BEP) = 3.3V; Maximum Voltage = 4.4V
2. The frequency fundamental emissions stay within the authorized frequency block based on the frequency deviation measured is small.

Frequency Error Against Voltage for UMTS band II		
Voltage (V)	Frequency Error (Hz)	Frequency Error (ppm)
3.3	10	0.0053
3.85	7	0.0037
4.4	9	0.0048

Frequency Error Against Temperature for UMTS band II		
Temperature (°C)	Frequency Error (Hz)	Frequency Error (ppm)
-30	13	0.0069
-20	18	0.0096
-10	22	0.0117
0	21	0.0112
10	15	0.0080
20	14	0.0074
30	5	0.0027
40	11	0.0059
50	8	0.0043

Frequency Error Against Voltage for UMTS band V		
Voltage (V)	Frequency Error (Hz)	Frequency Error (ppm)
3.3	13	0.0155
3.85	18	0.0215
4.4	16	0.0191

Frequency Error Against Temperature for UMTS band V		
Temperature (°C)	Frequency Error (Hz)	Frequency Error (ppm)
-30	25	0.0299
-20	18	0.0215
-10	14	0.0167
0	15	0.0179
10	13	0.0155
20	15	0.0179
30	18	0.0215
40	19	0.0227
50	22	0.0263

Frequency Error Against Voltage for UMTS band IV		
Voltage (V)	Frequency Error (Hz)	Frequency Error (ppm)
3.3	10	0.0058
3.85	12	0.0069
4.4	15	0.0087

Frequency Error Against Temperature for UMTS band IV		
Temperature (°C)	Frequency Error (Hz)	Frequency Error (ppm)
-30	13	0.0075
-20	11	0.0063
-10	9	0.0052
0	10	0.0058
10	14	0.0081
20	12	0.0069
30	15	0.0087
40	6	0.0035
50	7	0.0040

Note:

1. Normal Voltage = 3.85V; Battery End Point (BEP) = 3.3V; Maximum Voltage = 4.4V
2. The frequency fundamental emissions stay within the authorized frequency block based on the frequency deviation measured is small.

7.5 PEAK-TO-AVERAGE RATIO

7.5.1 Applicable Standard

According to FCC 22.913 and FCC 24.232(d) and FCC KDB 971168 D01 Section 5.7.1

7.5.2 Conformance Limit

The peak-to-average power ratio (PAPR) of the transmitter output power must not exceed 13 dB. The PAPR measurements should be made using either an instrument with complementary cumulative distribution function (CCDF) capabilities to determine that PAPR will not exceed 13 dB for more than 0.1 percent of the time or other Commission approved procedure. The measurement must be performed using a signal corresponding to the highest PAPR expected during periods of continuous transmission.

7.5.3 Measuring Instruments

The Measuring equipment is listed in the section 6.3 of this test report.

7.5.4 Test Setup

Please refer to Section 6.1 of this test report.

7.5.5 Test Procedure

The EUT was connected to Spectrum Analyzer and Base Station via power divider.
 The RF output of EUT was connected to the spectrum analyzer by RF cable and attenuator. The path loss was compensated to the results for each measurement.
 Set the number of counts to a value that stabilizes the measured CCDF curve.
 Set the measurement interval to 1 ms.
 Record the maximum PAPR level associated with a probability of 0.1%.
 a) Refer to instrument's analyzer instruction manual for details on how to use the power statistics/CCDF function;
 b) Set resolution/measurement bandwidth \geq signal's occupied bandwidth;
 c) Set the number of counts to a value that stabilizes the measured CCDF curve;
 d) Set the measurement interval as follows:
 1) for continuous transmissions, set to 1 ms,
 2) for burst transmissions, employ an external trigger that is synchronized with the EUT burst timing sequence, or use the internal burst trigger with a trigger level that allows the burst to stabilize and set the measurement interval to a time that is less than or equal to the burst duration.
 e) Record the maximum PAPR level associated with a probability of 0.1%.

7.5.6 Test Results

EUT:	Smart Phone	Model No.:	WP8 Pro
Temperature:	20 °C	Relative Humidity:	48%
Test Mode:	GSM/GPRS/EGPRS 850/ GSM/GPRS/EGPRS 1900 UMTS band II/ UMTS band V UMTS band IV	Test By:	Mary Hu
Results: PASS			

Test data reference attachment

7.6 26DB BANDWIDTH AND 99% OCCUPIED BANDWIDTH

7.6.1 Applicable Standard

According to FCC Part 2.1049 and FCC Part 22H and FCC Part 24E and FCC KDB 971168 D01 Section 4.0

7.6.2 Conformance Limit

The occupied bandwidth is the width of a frequency band such that, below the lower and above the upper frequency limits, the mean powers emitted are each equal to a specified percentage 0.5% of the total mean transmitted power.

The 26 dB emission bandwidth is defined as the frequency range between two points, one above and one below the carrier frequency, at which the spectral density of the emission is attenuated 26 dB below the maximum in-band spectral density of the modulated signal. Spectral density (power per unit bandwidth) is to be measured with a detector of resolution bandwidth equal to approximately 1.0% of the emission bandwidth.

7.6.3 Measuring Instruments

The Measuring equipment is listed in the section 6.3 of this test report.

7.6.4 Test Setup

Please refer to Section 6.1 of this test report.

7.6.5 Test Procedure

The testing follows FCC KDB 971168 v03r01 Section 4.0.

The EUT was connected to Spectrum Analyzer and Base Station via power divider.

The RF output of EUT was connected to the spectrum analyzer by RF cable and attenuator. The path loss was compensated to the results for each measurement.

The spectrum analyzer center frequency is set to the nominal EUT channel center frequency. The span range for the spectrum analyzer shall be between two and five times the anticipated OBW.

The nominal resolution bandwidth (RBW) shall be in the range of 1 to 5 % of the anticipated OBW, and the VBW shall be at least 3 times the RBW.

Set the detection mode to peak, and the trace mode to max hold.

Determine the reference value: Set the EUT to transmit a modulated signal. Allow the trace to stabilize. Set the spectrum analyzer marker to the highest level of the displayed trace.

(this is the reference value)

Determine the “-26 dB down amplitude” as equal to (Reference Value – X).

Place two markers, one at the lowest and the other at the highest frequency of the envelope of the spectral display such that each marker is at or slightly below the “-X dB down amplitude” determined in step 6. If a marker is below this “-X dB down amplitude” value it shall be placed as close as possible to this value. The OBW is the positive frequency difference between the two markers.

Use the 99 % power bandwidth function of the spectrum analyzer and report the measured bandwidth.

7.6.6 Test Results

EUT:	Smart Phone	Model No.:	WP8 Pro
Temperature:	20 °C	Relative Humidity:	48%
Test Mode:	GSM/GPRS/EGPRS 850/ GSM/GPRS/EGPRS 1900 UMTS band II/ UMTS band V UMTS band IV	Test By:	Mary Hu
Results: PASS			

Test data reference attachment

7.7 CONDUCTED BAND EDGE

7.7.1 Applicable Standard

According to FCC Part 2.1051 and FCC Part 22.917(a) and 24.238(a) and FCC KDB 971168 D01 Section 6.0

7.7.2 Conformance Limit

The power of any emission outside of the authorized operating frequency ranges must be lower than the transmitter power (P) by a factor of at least $43 + 10 \log (P)$ dB.

7.7.3 Measuring Instruments

The Measuring equipment is listed in the section 6.3 of this test report.

7.7.4 Test Setup

Please refer to Section 6.1 of this test report.

7.7.5 Test Procedure

The testing follows FCC KDB 971168 v03r01 Section 6.0.
 The EUT was connected to Spectrum Analyzer and Base Station via power divider.
 The RF output of EUT was connected to the spectrum analyzer by RF cable and attenuator.
 The path loss was compensated to the results for each measurement.
 The band edges of low and high channels for the highest RF powers were measured.
 The RF fundamental frequency should be excluded against the limit line in the operating frequency band.
 The limit line is derived from $43 + 10\log(P)$ dB below the transmitter power P(Watts)
 $= P(W) - [43 + 10\log(P)]$ (dB)
 $= [30 + 10\log(P)]$ (dBm) - $[43 + 10\log(P)]$ (dB)
 $= -13\text{dBm}$.

7.7.6 Test Results

EUT:	Smart Phone	Model No.:	WP8 Pro
Temperature:	20 °C	Relative Humidity:	48%
Test Mode:	GSM/GPRS/EGPRS 850/ GSM/GPRS/EGPRS 1900 UMTS band II/ UMTS band V UMTS band IV	Test By:	Mary Hu
Results: PASS			

Test data reference attachment

7.8 CONDUCTED SPURIOUS EMISSION AT ANTENNA TERMINAL

7.8.1 Applicable Standard

According to FCC Part 2.1051 and FCC Part 22.917(a) and Part 24.238(a) and FCC KDB 971168 D01 Section6.0

7.8.2 Conformance Limit

The power of any emission outside of the authorized operating frequency ranges must be lower than the transmitter power (P) by a factor of at least $43 + 10 \log (P)$ dB.
It is measured by means of a calibrated spectrum analyzer and scanned from 30 MHz up to a frequency including its 10th harmonic.

7.8.3 Measuring Instruments

The Measuring equipment is listed in the section 6.3 of this test report.

7.8.4 Test Setup

Please refer to Section 6.1 of this test report.

7.8.5 Test Procedure

The testing follows FCC KDB 971168 v03r01 Section 6.0.
The EUT was connected to Spectrum Analyzer and Base Station via power divider.
The RF output of EUT was connected to the spectrum analyzer by RF cable and attenuator.
The path loss was compensated to the results for each measurement.
The middle channel for the highest RF power within the transmitting frequency was measured.
The conducted spurious emission for the whole frequency range was taken.
The RF fundamental frequency should be excluded against the limit line in the operating frequency band.
The limit line is derived from $43 + 10\log(P)$ dB below the transmitter power P(Watts)
 $= P(W) - [43 + 10\log(P)]$ (dB)
 $= [30 + 10\log(P)]$ (dBm) - $[43 + 10\log(P)]$ (dB)
 $= -13\text{dBm}$.

7.8.6 Test Results

EUT:	Smart Phone	Model No.:	WP8 Pro
Temperature:	20 °C	Relative Humidity:	48%
Test Mode:	GSM/GPRS/EGPRS 850/ GSM/GPRS/EGPRS 1900 UMTS band II/ UMTS band V UMTS band IV	Test By:	Mary Hu
Results: PASS			

Test data reference attachment

8 TEST RESULTS

8.1 CONDUCTED OUTPUT POWER

Band	Channel	Frequency (MHz)	Power (dBm)	Verdict
GSM850	128	824.2	33.12	PASS
GSM850	189	836.4	33.29	PASS
GSM850	251	848.8	33.15	PASS
GSM1900	512	1850.2	30.51	PASS
GSM1900	661	1880	30.43	PASS
GSM1900	810	1909.8	30.46	PASS
GPRS850 1 Slot	128	824.2	33.12	PASS
GPRS850 1 Slot	189	836.4	33.26	PASS
GPRS850 1 Slot	251	848.8	33.17	PASS
GPRS850 2 Slot	128	824.2	32.29	PASS
GPRS850 2 Slot	189	836.4	32.41	PASS
GPRS850 2 Slot	251	848.8	32.32	PASS
GPRS850 3 Slot	128	824.2	30.43	PASS
GPRS850 3 Slot	189	836.4	30.54	PASS
GPRS850 3 Slot	251	848.8	30.46	PASS
GPRS850 4 Slot	128	824.2	29.32	PASS
GPRS850 4 Slot	189	836.4	29.40	PASS
GPRS850 4 Slot	251	848.8	29.34	PASS
GPRS1900 1 Slot	512	1850.2	30.52	PASS
GPRS1900 1 Slot	661	1880	30.42	PASS
GPRS1900 1 Slot	810	1909.8	30.46	PASS
GPRS1900 2 Slot	512	1850.2	29.78	PASS
GPRS1900 2 Slot	661	1880	29.69	PASS
GPRS1900 2 Slot	810	1909.8	29.72	PASS
GPRS1900 3 Slot	512	1850.2	28.00	PASS
GPRS1900 3 Slot	661	1880	27.94	PASS
GPRS1900 3 Slot	810	1909.8	27.98	PASS
GPRS1900 4 Slot	512	1850.2	26.93	PASS
GPRS1900 4 Slot	661	1880	26.81	PASS
GPRS1900 4 Slot	810	1909.8	26.92	PASS
EGPRS850 1 Slot	128	824.2	25.72	PASS
EGPRS850 1 Slot	189	836.4	25.67	PASS
EGPRS850 1 Slot	251	848.8	25.97	PASS
EGPRS850 2 Slot	128	824.2	25.06	PASS
EGPRS850 2 Slot	189	836.4	24.50	PASS
EGPRS850 2 Slot	251	848.8	24.79	PASS
EGPRS850 3 Slot	128	824.2	23.00	PASS
EGPRS850 3 Slot	189	836.4	22.33	PASS
EGPRS850 3 Slot	251	848.8	22.49	PASS
EGPRS850 4 Slot	128	824.2	21.27	PASS
EGPRS850 4 Slot	189	836.4	20.90	PASS
EGPRS850 4 Slot	251	848.8	20.96	PASS
EGPRS1900 1 Slot	512	1850.2	26.39	PASS
EGPRS1900 1 Slot	661	1880	26.60	PASS
EGPRS1900 1 Slot	810	1909.8	26.27	PASS
EGPRS1900 2 Slot	512	1850.2	25.58	PASS
EGPRS1900 2 Slot	661	1880	25.66	PASS
EGPRS1900 2 Slot	810	1909.8	25.39	PASS
EGPRS1900 3 Slot	512	1850.2	23.66	PASS
EGPRS1900 3 Slot	661	1880	23.91	PASS
EGPRS1900 3 Slot	810	1909.8	23.53	PASS

EGPRS1900 4 Slot	512	1850.2	22.68	PASS
EGPRS1900 4 Slot	661	1880	22.84	PASS
EGPRS1900 4 Slot	810	1909.8	22.65	PASS
WCDMA Band2	9262	1852.4	23.56	PASS
WCDMA Band2	9400	1880	23.50	PASS
WCDMA Band2	9538	1907.6	23.37	PASS
HSDPA Band2 Subtest1	9262	1852.4	22.72	PASS
HSDPA Band2 Subtest1	9400	1880	22.61	PASS
HSDPA Band2 Subtest1	9538	1907.6	22.48	PASS
HSDPA Band2 Subtest2	9262	1852.4	22.18	PASS
HSDPA Band2 Subtest2	9400	1880	22.01	PASS
HSDPA Band2 Subtest2	9538	1907.6	22.10	PASS
HSDPA Band2 Subtest3	9262	1852.4	20.97	PASS
HSDPA Band2 Subtest3	9400	1880	21.10	PASS
HSDPA Band2 Subtest3	9538	1907.6	21.17	PASS
HSDPA Band2 Subtest4	9262	1852.4	20.84	PASS
HSDPA Band2 Subtest4	9400	1880	20.86	PASS
HSDPA Band2 Subtest4	9538	1907.6	21.06	PASS
HSUPA Band2 Subtest1	9262	1852.4	22.50	PASS
HSUPA Band2 Subtest1	9400	1880	22.42	PASS
HSUPA Band2 Subtest1	9538	1907.6	22.29	PASS
HSUPA Band2 Subtest2	9262	1852.4	22.65	PASS
HSUPA Band2 Subtest2	9400	1880	22.50	PASS
HSUPA Band2 Subtest2	9538	1907.6	22.38	PASS
HSUPA Band2 Subtest3	9262	1852.4	21.37	PASS
HSUPA Band2 Subtest3	9400	1880	21.42	PASS
HSUPA Band2 Subtest3	9538	1907.6	21.23	PASS
HSUPA Band2 Subtest4	9262	1852.4	22.69	PASS
HSUPA Band2 Subtest4	9400	1880	22.57	PASS
HSUPA Band2 Subtest4	9538	1907.6	22.46	PASS
HSUPA Band2 Subtest5	9262	1852.4	22.05	PASS
HSUPA Band2 Subtest5	9400	1880	21.99	PASS
HSUPA Band2 Subtest5	9538	1907.6	21.84	PASS
WCDMA Band4	1312	1712.4	23.40	PASS
WCDMA Band4	1412	1732.4	23.34	PASS
WCDMA Band4	1513	1752.6	23.44	PASS
HSDPA Band4 Subtest1	1312	1712.4	22.51	PASS
HSDPA Band4 Subtest1	1412	1732.4	22.41	PASS
HSDPA Band4 Subtest1	1513	1752.6	22.48	PASS
HSDPA Band4 Subtest2	1312	1712.4	22.15	PASS
HSDPA Band4 Subtest2	1412	1732.4	21.87	PASS
HSDPA Band4 Subtest2	1513	1752.6	21.89	PASS
HSDPA Band4 Subtest3	1312	1712.4	21.17	PASS
HSDPA Band4 Subtest3	1412	1732.4	20.55	PASS
HSDPA Band4 Subtest3	1513	1752.6	20.64	PASS
HSDPA Band4 Subtest4	1312	1712.4	20.92	PASS
HSDPA Band4 Subtest4	1412	1732.4	20.83	PASS
HSDPA Band4 Subtest4	1513	1752.6	21.05	PASS
HSUPA Band4 Subtest1	1312	1712.4	22.31	PASS
HSUPA Band4 Subtest1	1412	1732.4	22.20	PASS
HSUPA Band4 Subtest1	1513	1752.6	22.27	PASS
HSUPA Band4 Subtest2	1312	1712.4	22.42	PASS
HSUPA Band4 Subtest2	1412	1732.4	22.31	PASS
HSUPA Band4 Subtest2	1513	1752.6	22.27	PASS
HSUPA Band4 Subtest3	1312	1712.4	21.40	PASS
HSUPA Band4 Subtest3	1412	1732.4	21.08	PASS
HSUPA Band4 Subtest3	1513	1752.6	21.33	PASS

HSUPA Band4 Subtest4	1312	1712.4	22.45	PASS
HSUPA Band4 Subtest4	1412	1732.4	22.39	PASS
HSUPA Band4 Subtest4	1513	1752.6	22.47	PASS
HSUPA Band4 Subtest5	1312	1712.4	21.62	PASS
HSUPA Band4 Subtest5	1412	1732.4	21.60	PASS
HSUPA Band4 Subtest5	1513	1752.6	21.76	PASS
WCDMA Band5	4132	826.4	22.83	PASS
WCDMA Band5	4182	836.4	22.92	PASS
WCDMA Band5	4233	846.6	22.92	PASS
HSDPA Band5 Subtest1	4132	826.4	21.87	PASS
HSDPA Band5 Subtest1	4182	836.4	21.97	PASS
HSDPA Band5 Subtest1	4233	846.6	21.97	PASS
HSDPA Band5 Subtest2	4132	826.4	21.40	PASS
HSDPA Band5 Subtest2	4182	836.4	21.45	PASS
HSDPA Band5 Subtest2	4233	846.6	21.56	PASS
HSDPA Band5 Subtest3	4132	826.4	20.46	PASS
HSDPA Band5 Subtest3	4182	836.4	20.34	PASS
HSDPA Band5 Subtest3	4233	846.6	20.20	PASS
HSDPA Band5 Subtest4	4132	826.4	20.11	PASS
HSDPA Band5 Subtest4	4182	836.4	20.54	PASS
HSDPA Band5 Subtest4	4233	846.6	20.52	PASS
HSUPA Band5 Subtest1	4132	826.4	21.63	PASS
HSUPA Band5 Subtest1	4182	836.4	21.74	PASS
HSUPA Band5 Subtest1	4233	846.6	21.80	PASS
HSUPA Band5 Subtest2	4132	826.4	21.80	PASS
HSUPA Band5 Subtest2	4182	836.4	21.82	PASS
HSUPA Band5 Subtest2	4233	846.6	21.82	PASS
HSUPA Band5 Subtest3	4132	826.4	20.72	PASS
HSUPA Band5 Subtest3	4182	836.4	20.73	PASS
HSUPA Band5 Subtest3	4233	846.6	20.77	PASS
HSUPA Band5 Subtest4	4132	826.4	21.87	PASS
HSUPA Band5 Subtest4	4182	836.4	21.97	PASS
HSUPA Band5 Subtest4	4233	846.6	21.95	PASS
HSUPA Band5 Subtest5	4132	826.4	20.97	PASS
HSUPA Band5 Subtest5	4182	836.4	21.06	PASS
HSUPA Band5 Subtest5	4233	846.6	21.16	PASS

8.2 PEAK-TO-AVERAGE RATIO

Band	Channel	Frequency (MHz)	Result (dB)	high Limit (dB)	Verdict
GSM850	128	824.2	2.64	13	PASS
GSM850	189	836.4	2.63	13	PASS
GSM850	251	848.8	2.63	13	PASS
GSM1900	512	1850.2	2.63	13	PASS
GSM1900	661	1880	2.63	13	PASS
GSM1900	810	1909.8	2.64	13	PASS
GPRS850	128	824.2	2.64	13	PASS
GPRS850	189	836.4	2.63	13	PASS
GPRS850	251	848.8	2.64	13	PASS
GPRS1900	512	1850.2	2.64	13	PASS
GPRS1900	661	1880	2.64	13	PASS
GPRS1900	810	1909.8	2.63	13	PASS
EGPRS850	128	824.2	9.88	13	PASS
EGPRS850	189	836.4	9.57	13	PASS
EGPRS850	251	848.8	10.07	13	PASS
EGPRS1900	512	1850.2	6.32	13	PASS
EGPRS1900	661	1880	6.54	13	PASS
EGPRS1900	810	1909.8	6.42	13	PASS
WCDMA Band2	9262	1852.4	3.07	13	PASS
WCDMA Band2	9400	1880	3.09	13	PASS
WCDMA Band2	9538	1907.6	2.99	13	PASS
WCDMA Band4	1312	1712.4	3.12	13	PASS
WCDMA Band4	1412	1732.4	2.81	13	PASS
WCDMA Band4	1513	1752.6	2.89	13	PASS
WCDMA Band5	4132	826.4	2.97	13	PASS
WCDMA Band5	4182	836.4	2.99	13	PASS
WCDMA Band5	4233	846.6	3.04	13	PASS

GSM850 Channel=128

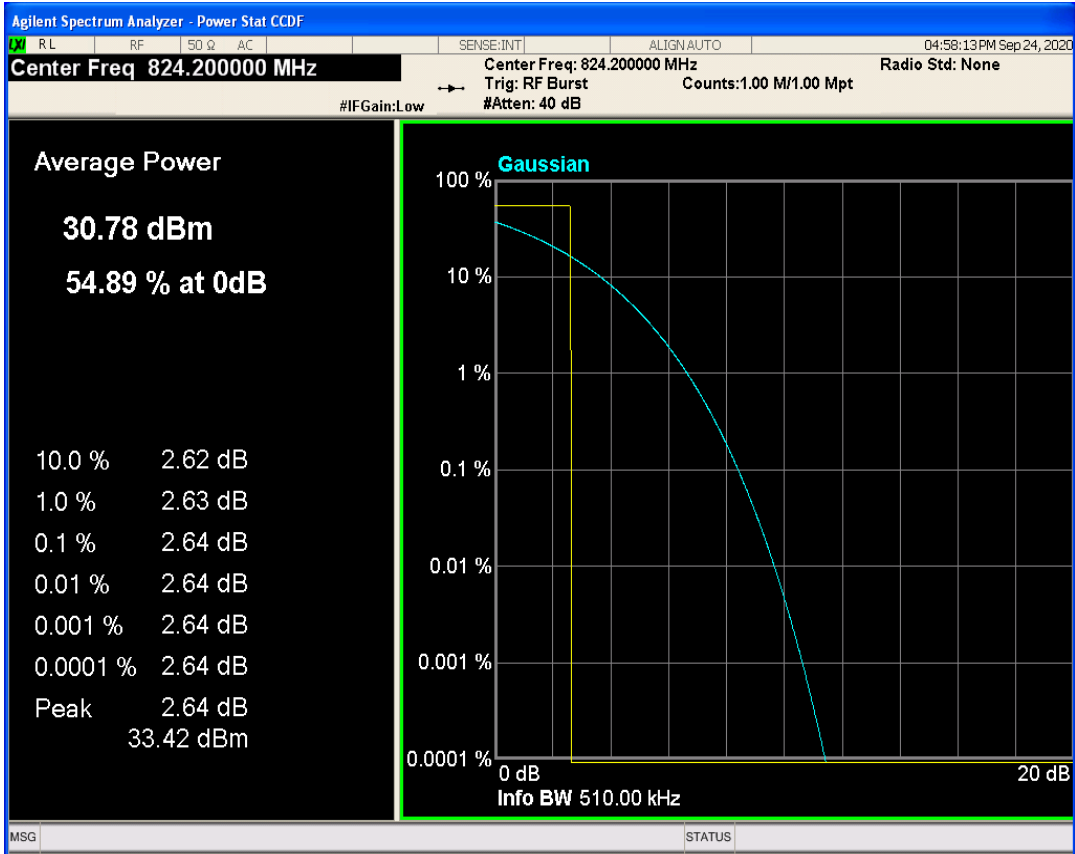

GSM850 Channel=189

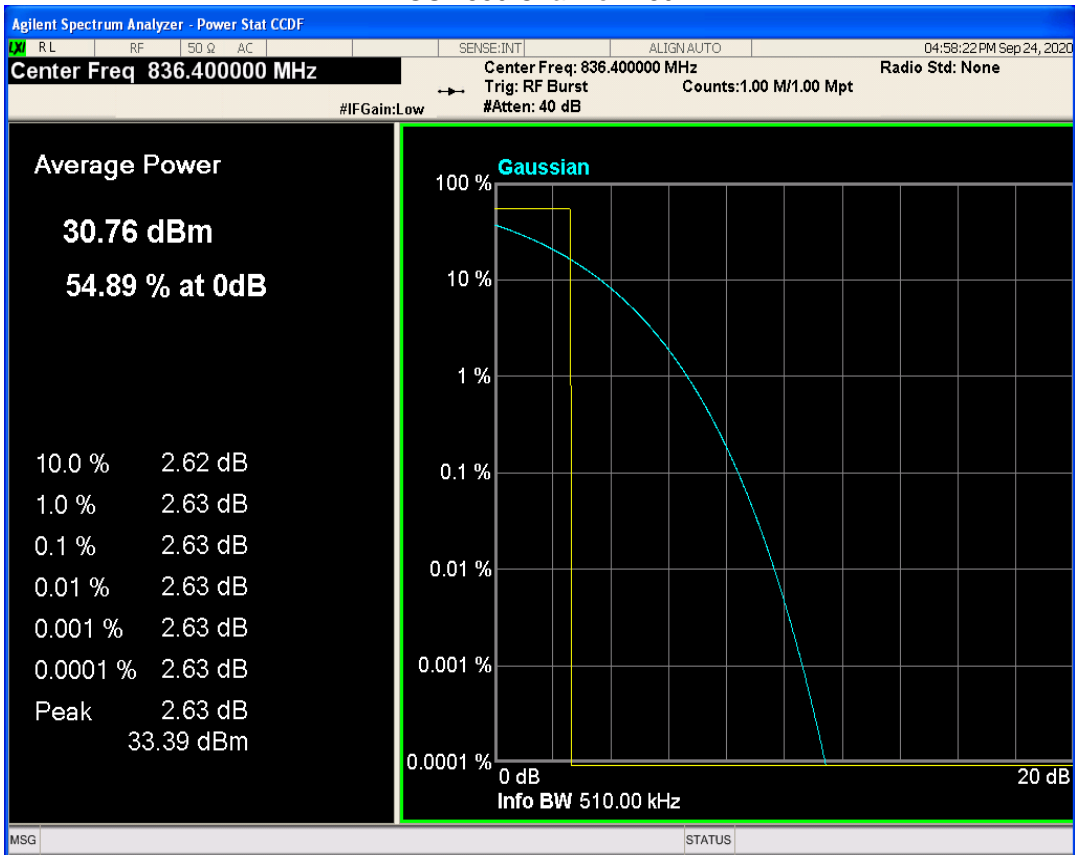

GSM850 Channel=251

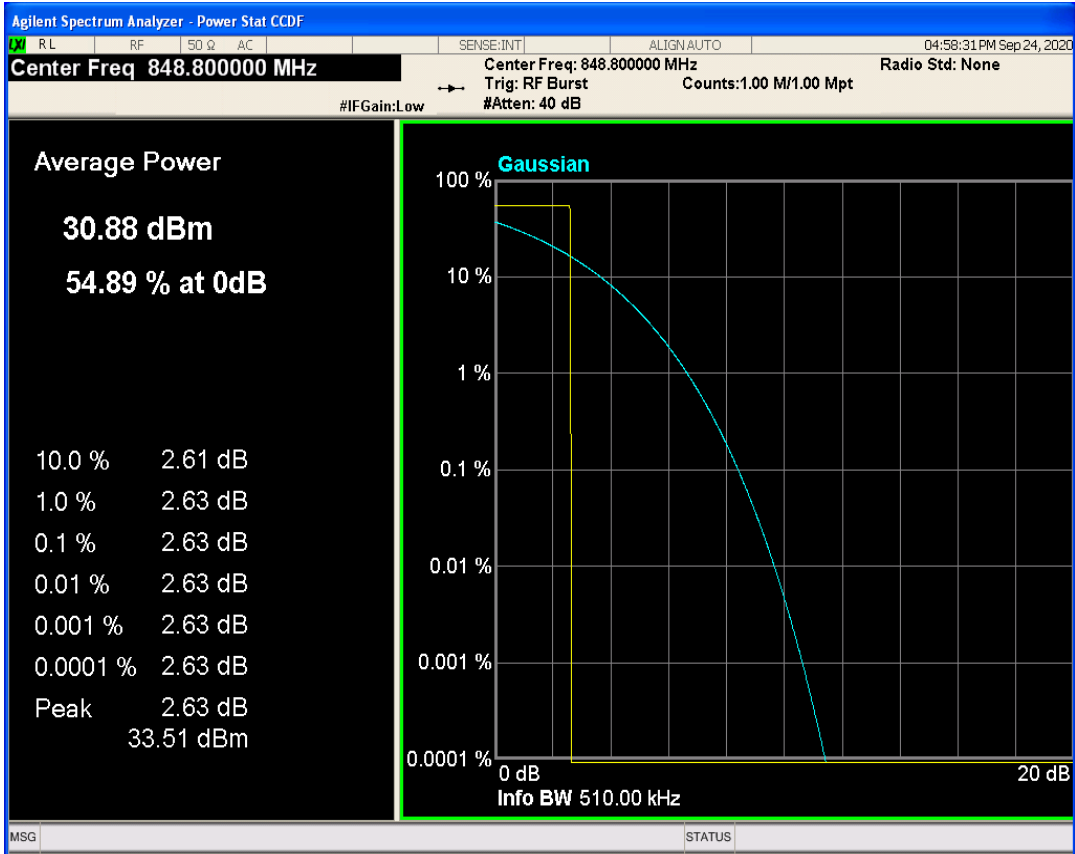

GSM1900 Channel=512

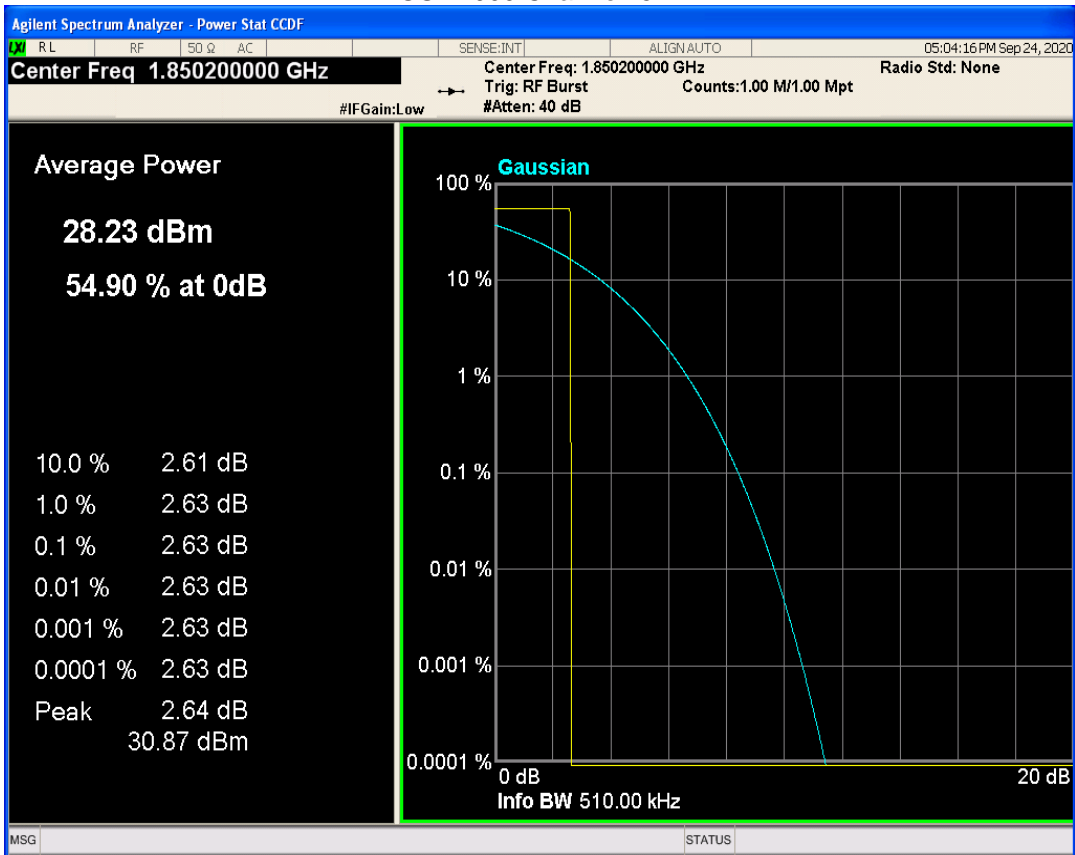

GSM1900 Channel=661

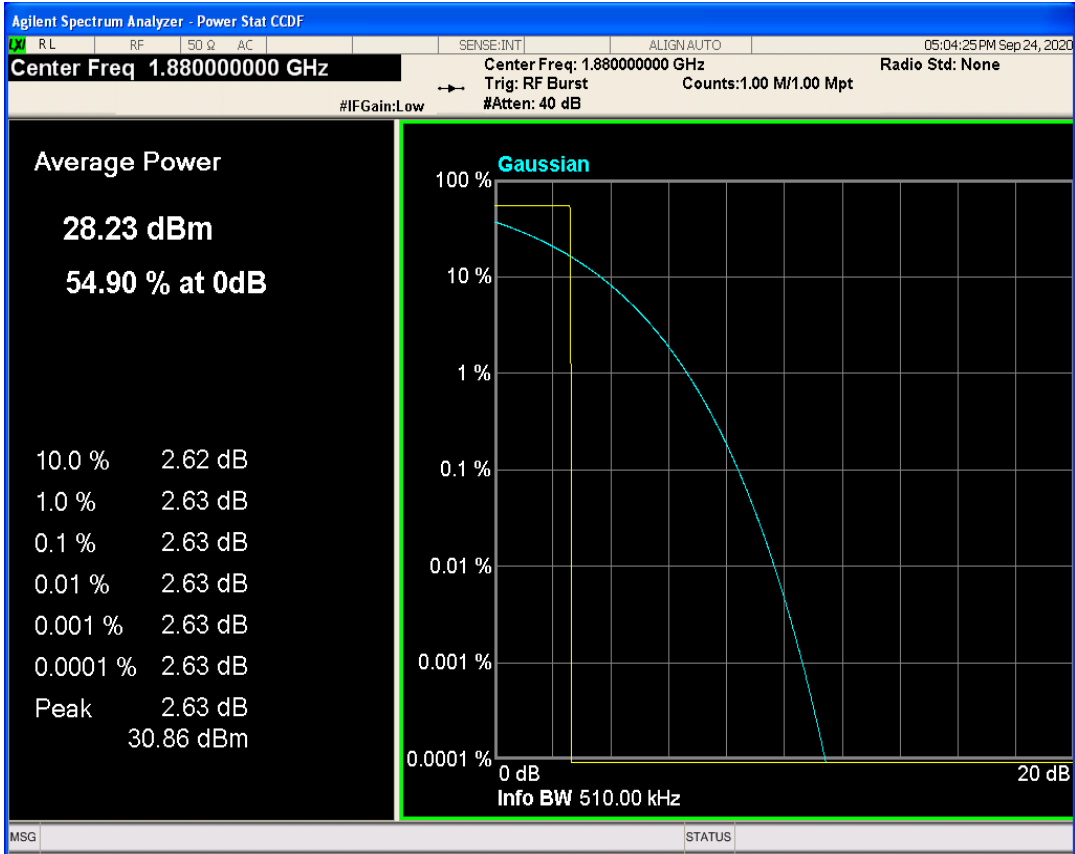

GSM1900 Channel=810

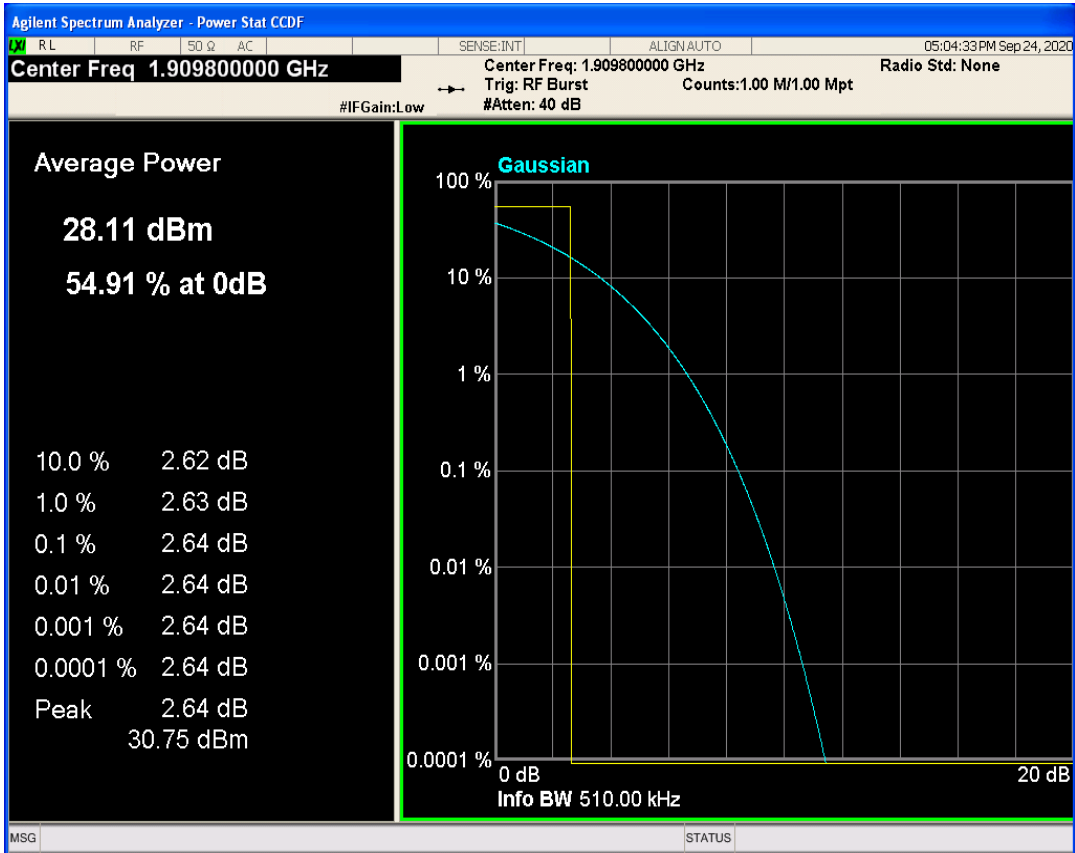

GPRS850 Channel=128

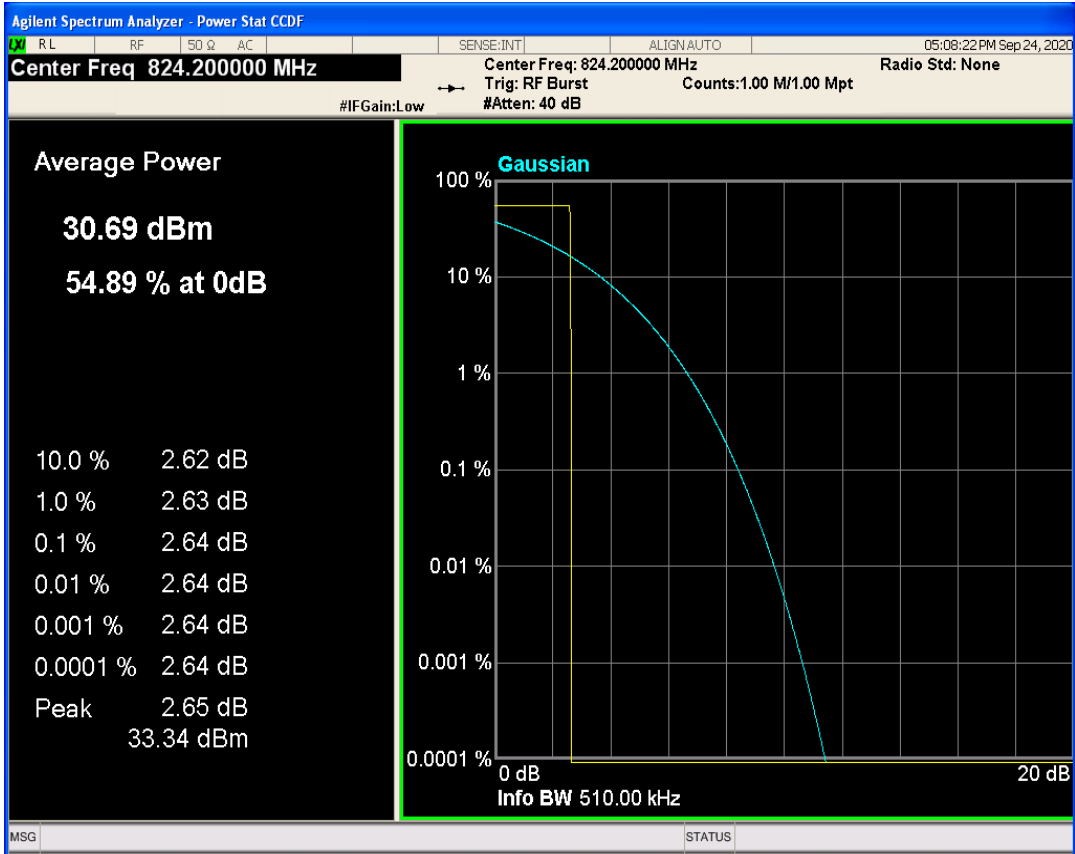

GPRS850 Channel=189

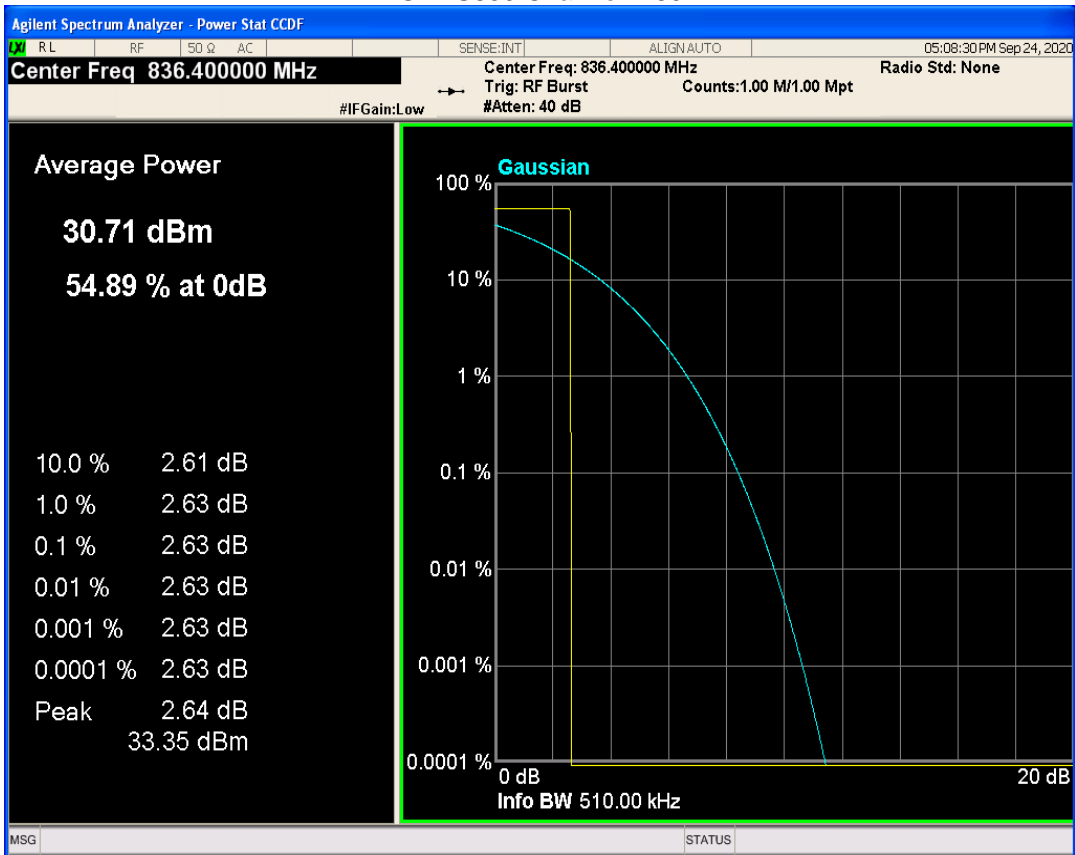

GPRS850 Channel=251

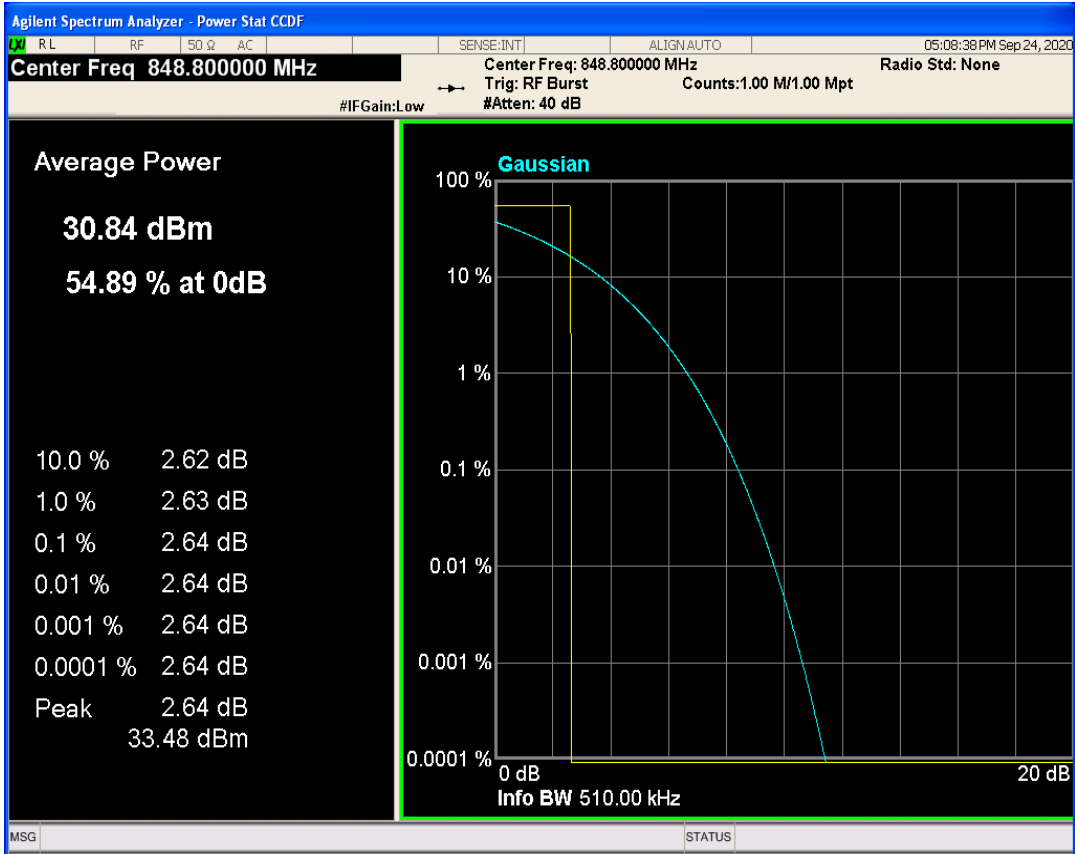

GPRS1900 Channel=512

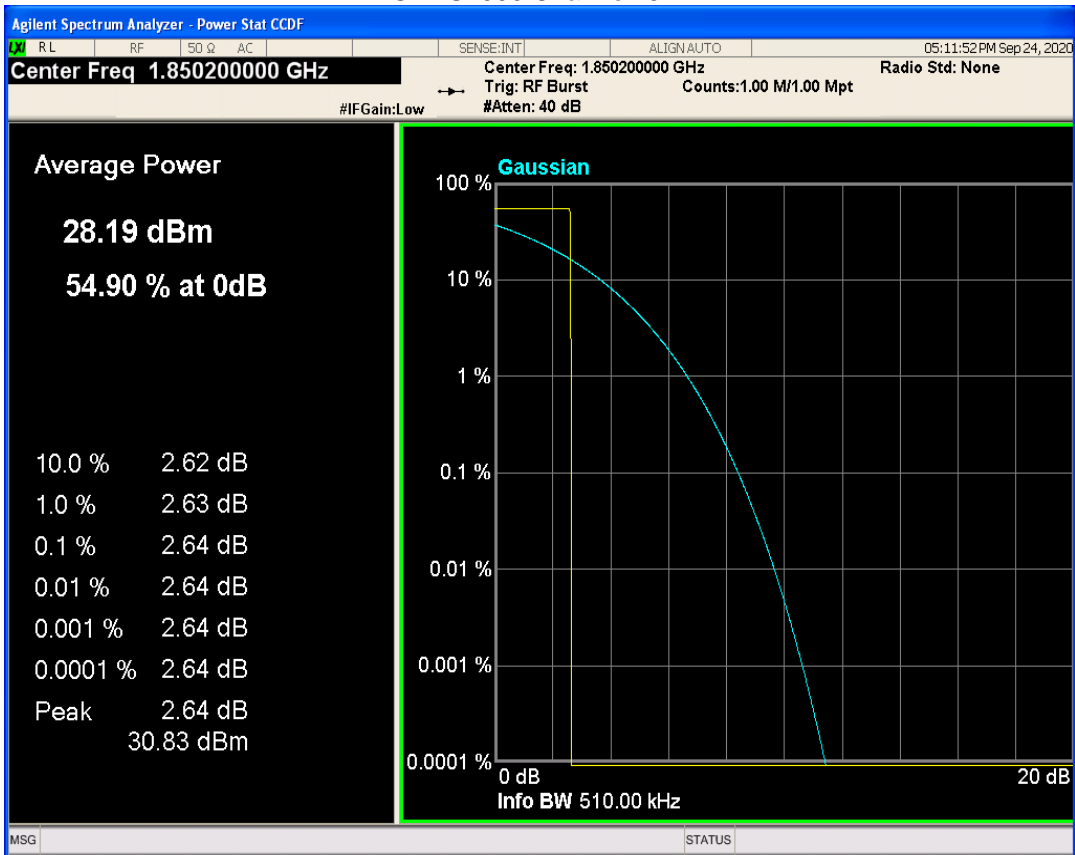

GPRS1900 Channel=661

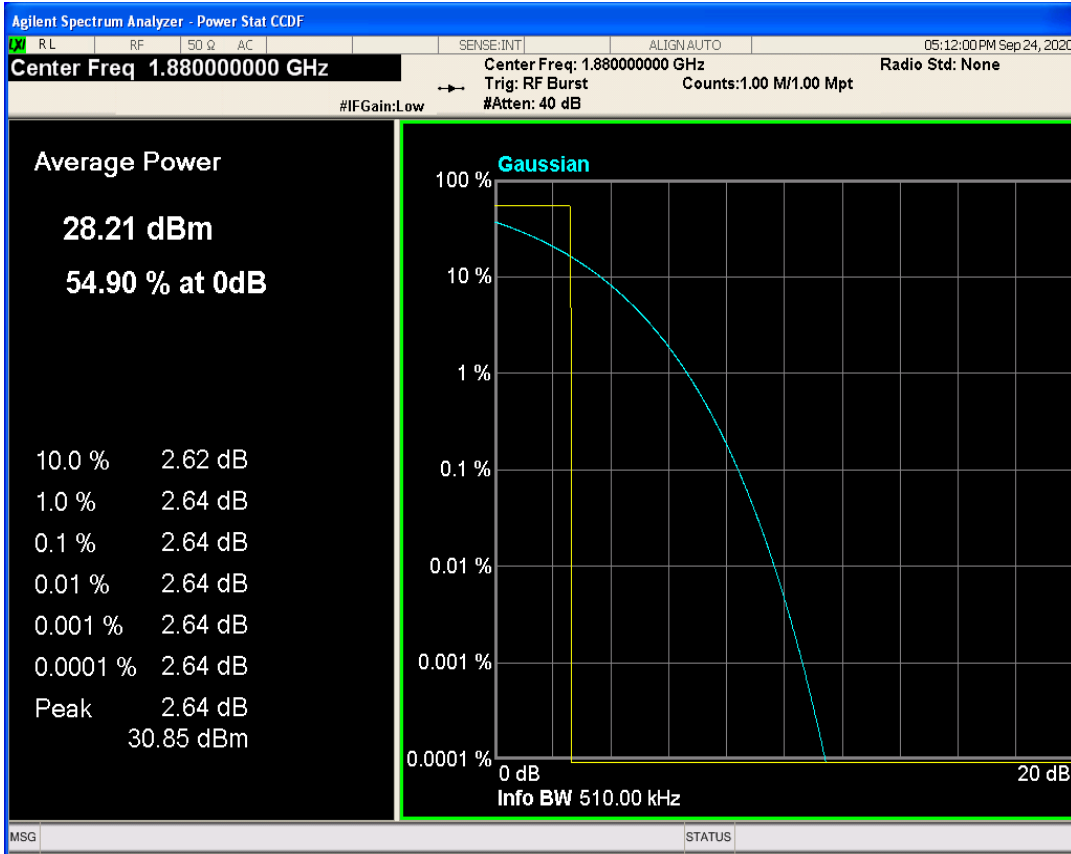

GPRS1900 Channel=810

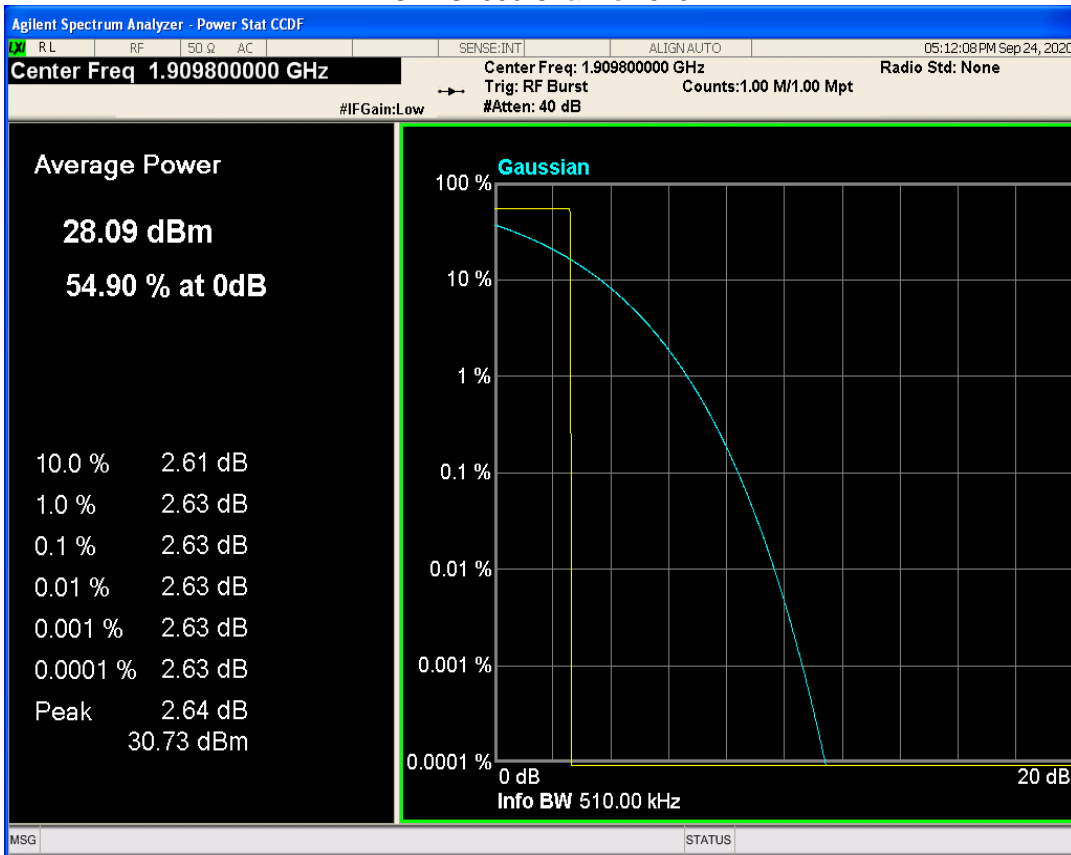

EGPRS850 Channel=189

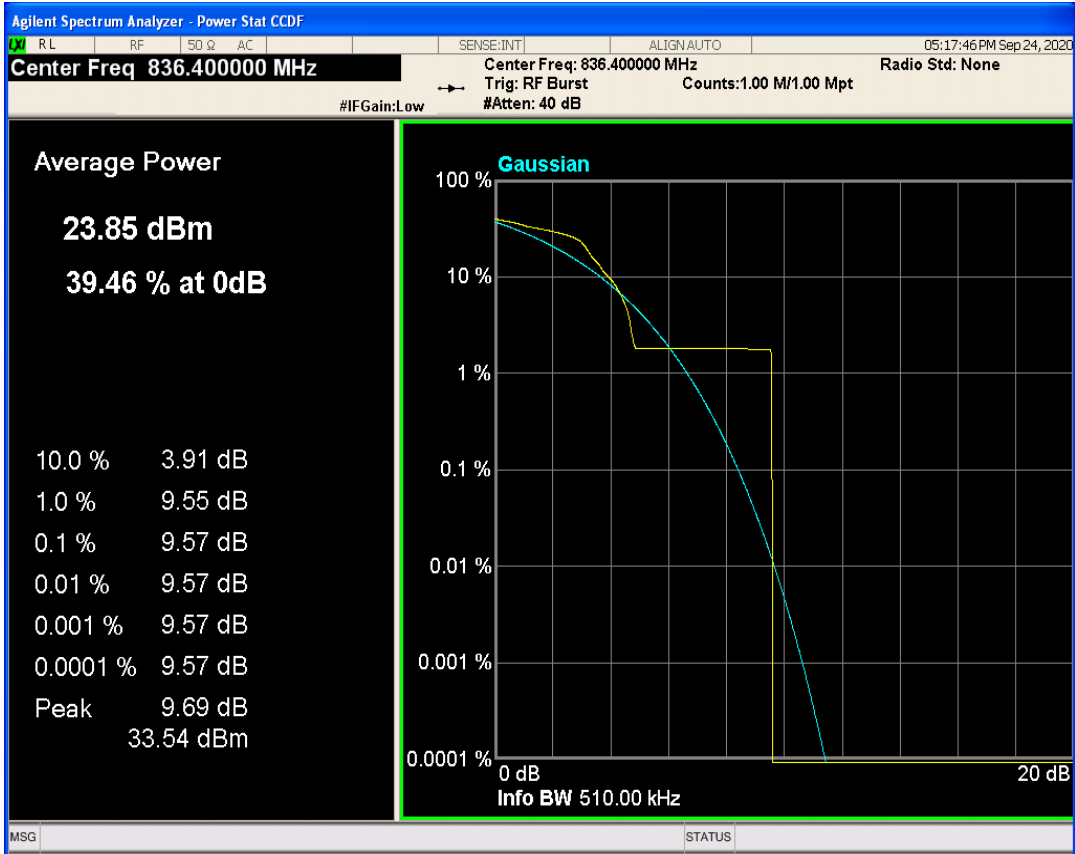

EGPRS850 Channel=128

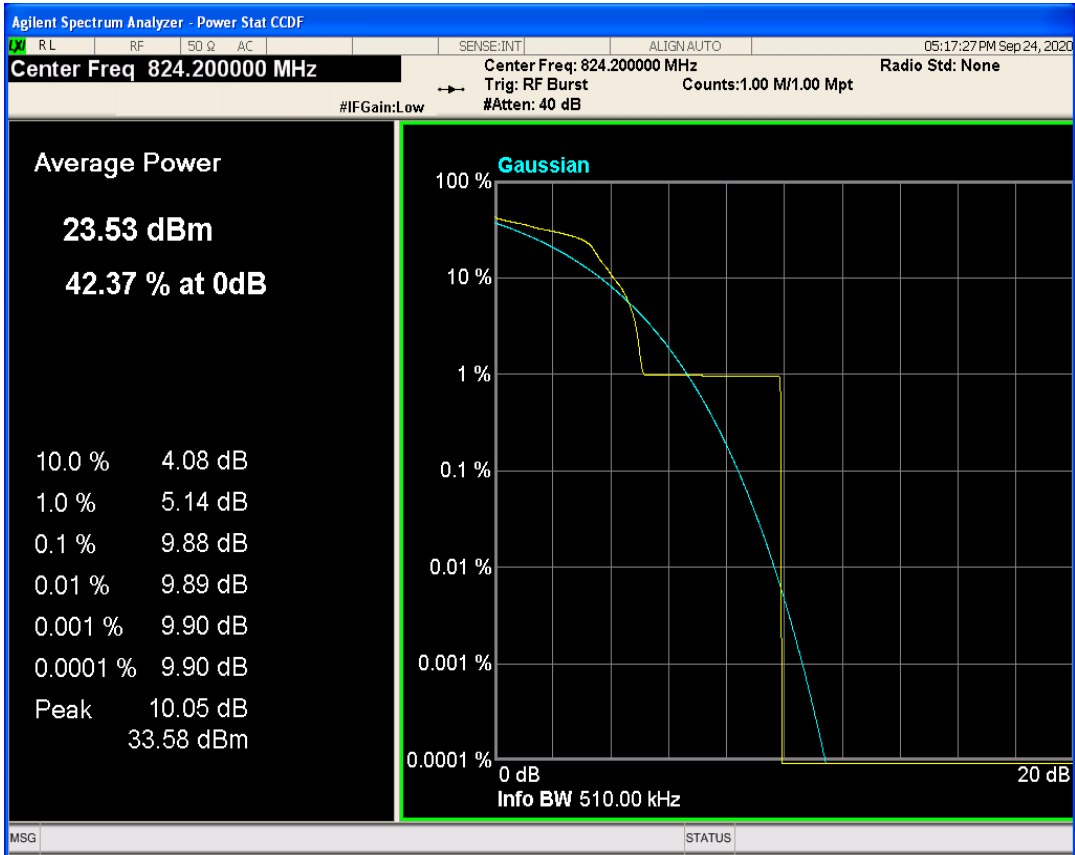

EGPRS850 Channel=251

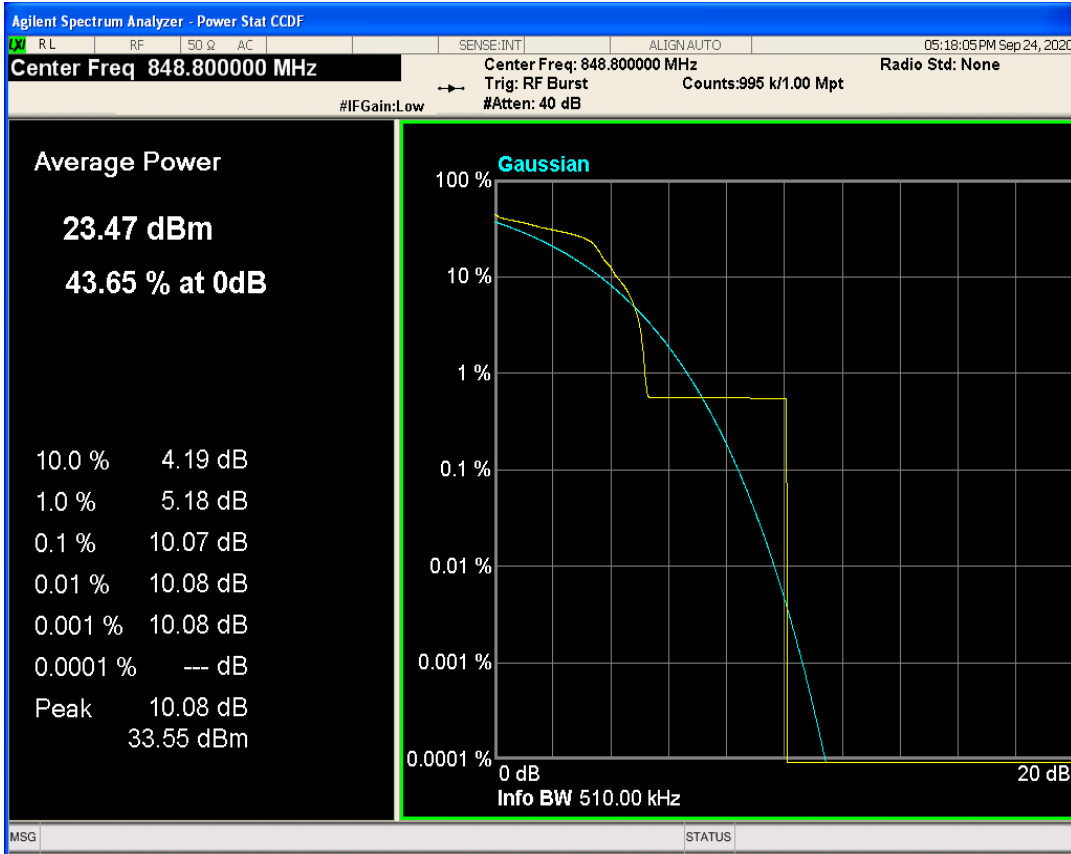

EGPRS1900 Channel=661

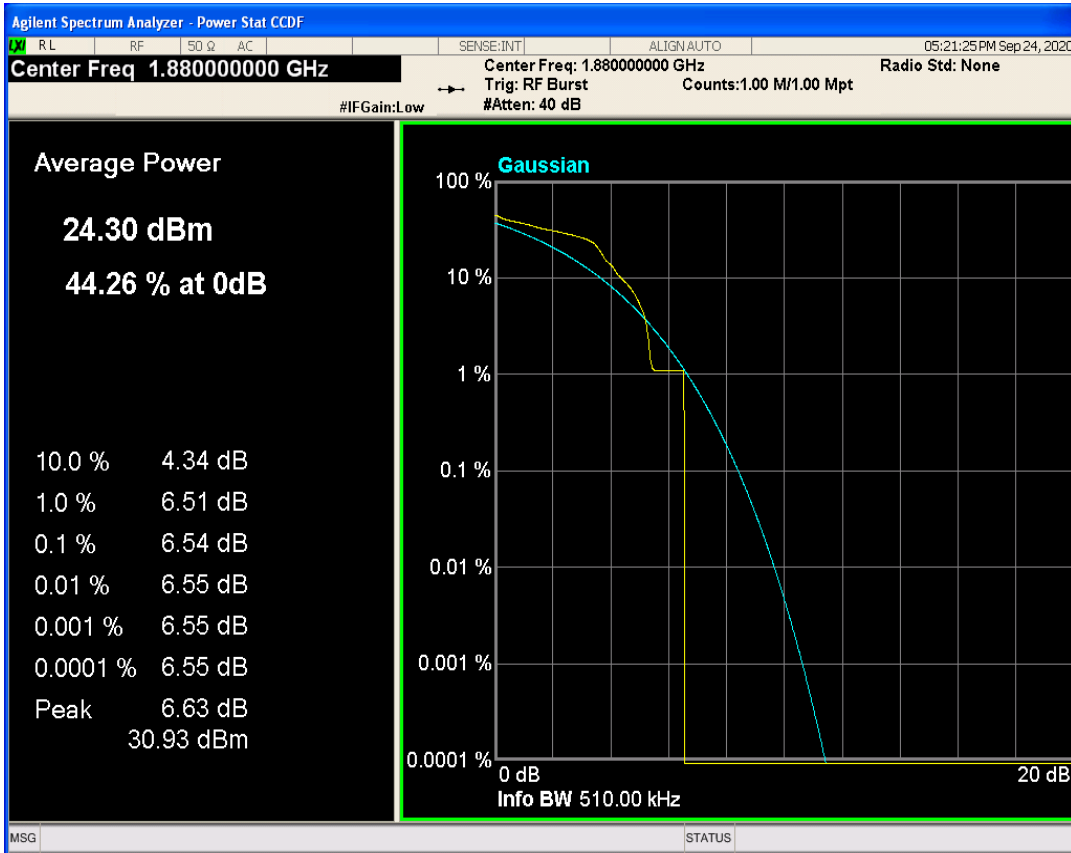

EGPRS1900 Channel=512

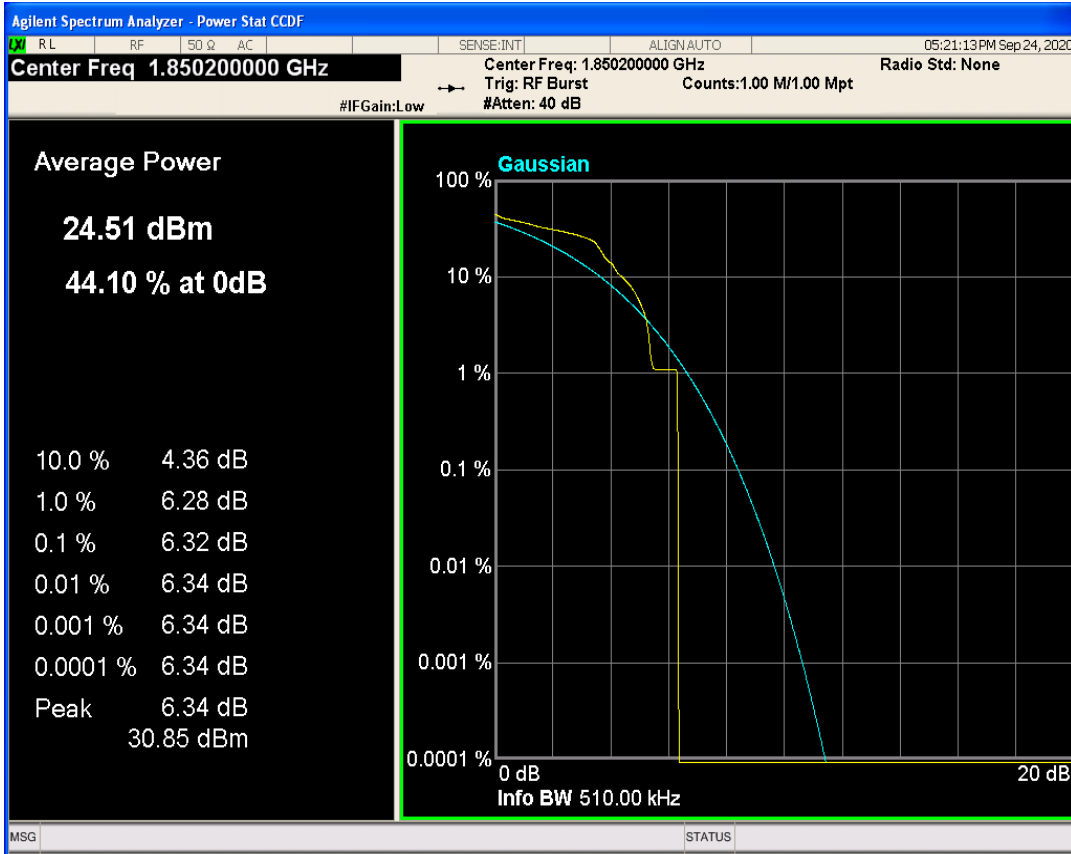

EGPRS1900 Channel=810



WCDMA Band2 Channel=9262

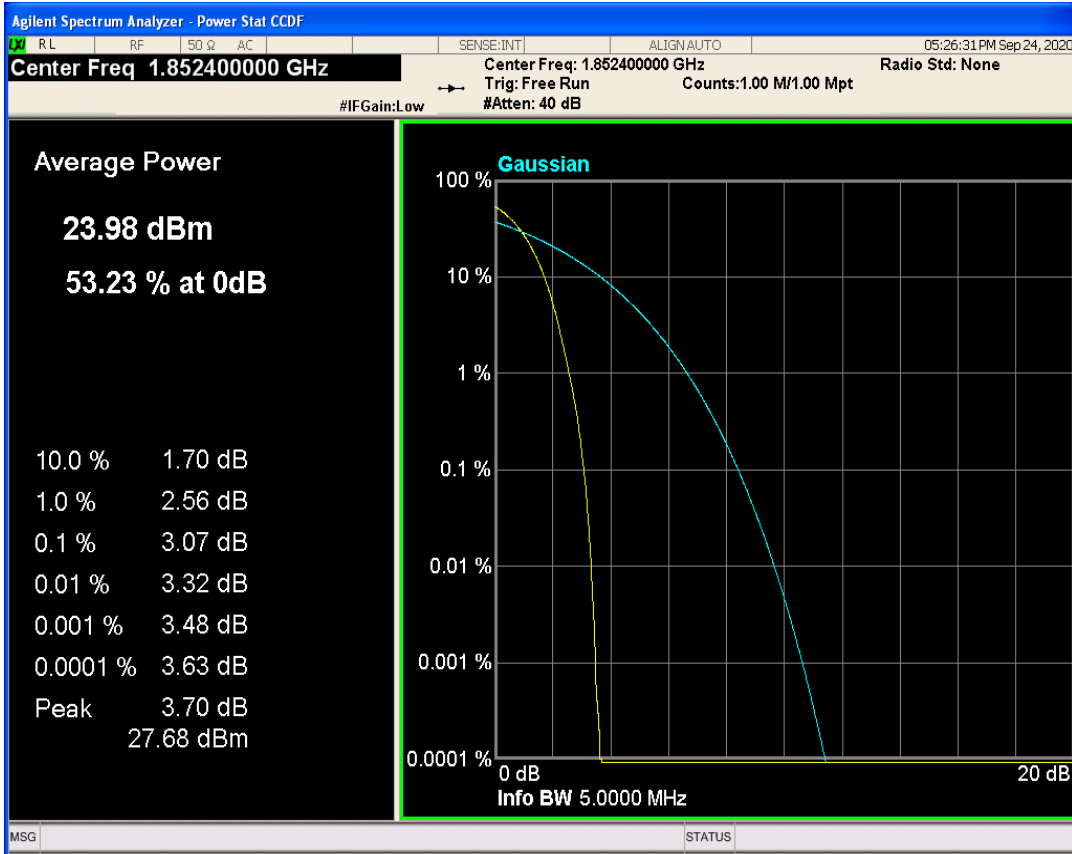

WCDMA Band2 Channel=9400

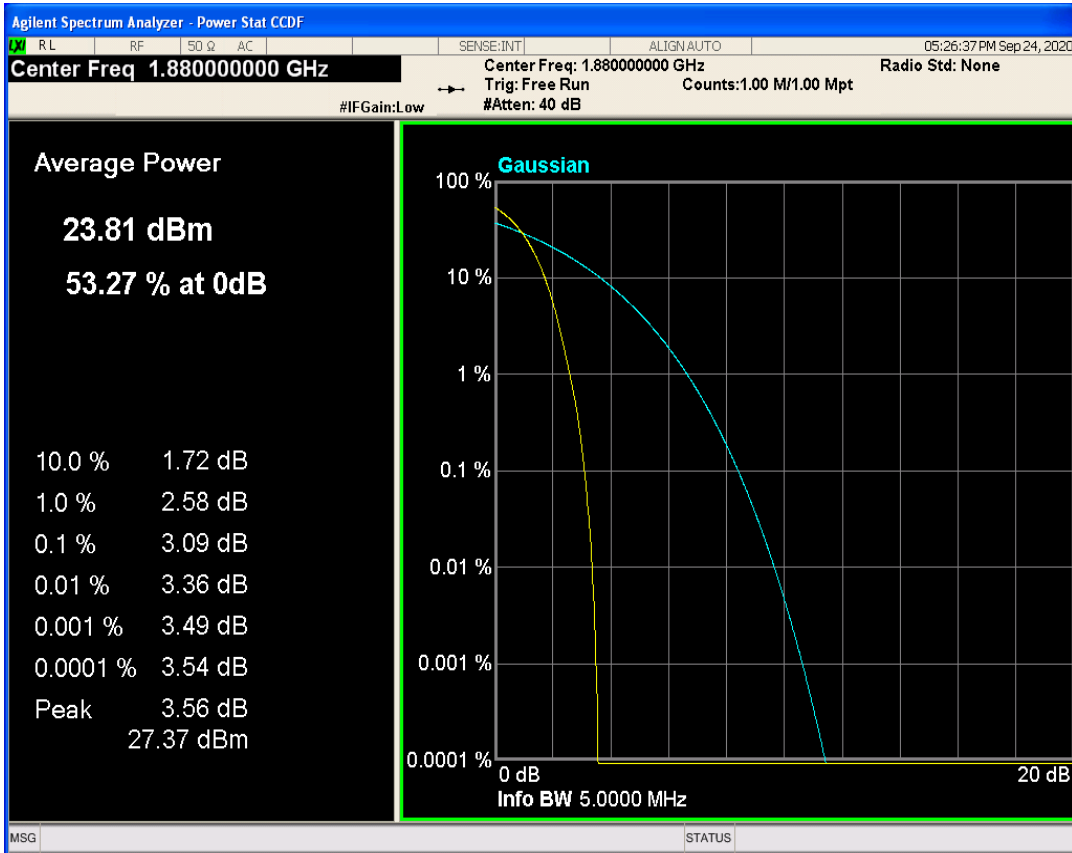

WCDMA Band2 Channel=9538

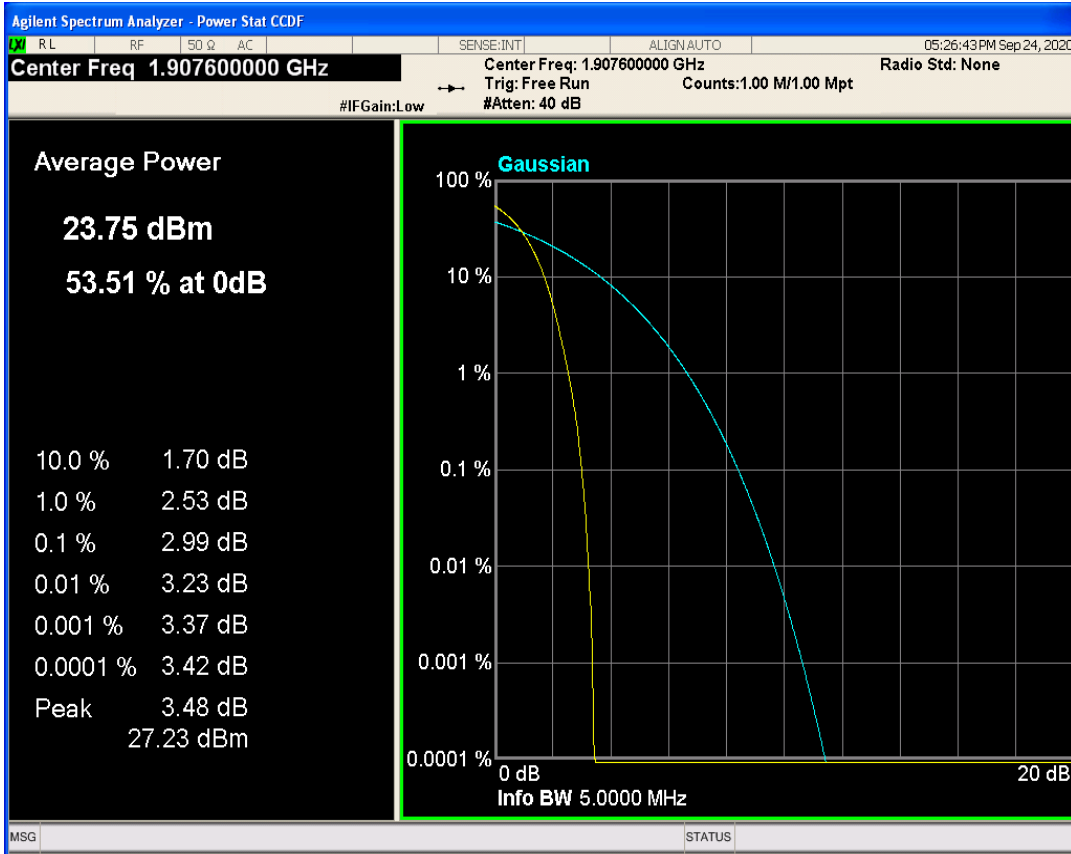

WCDMA Band4 Channel=1412

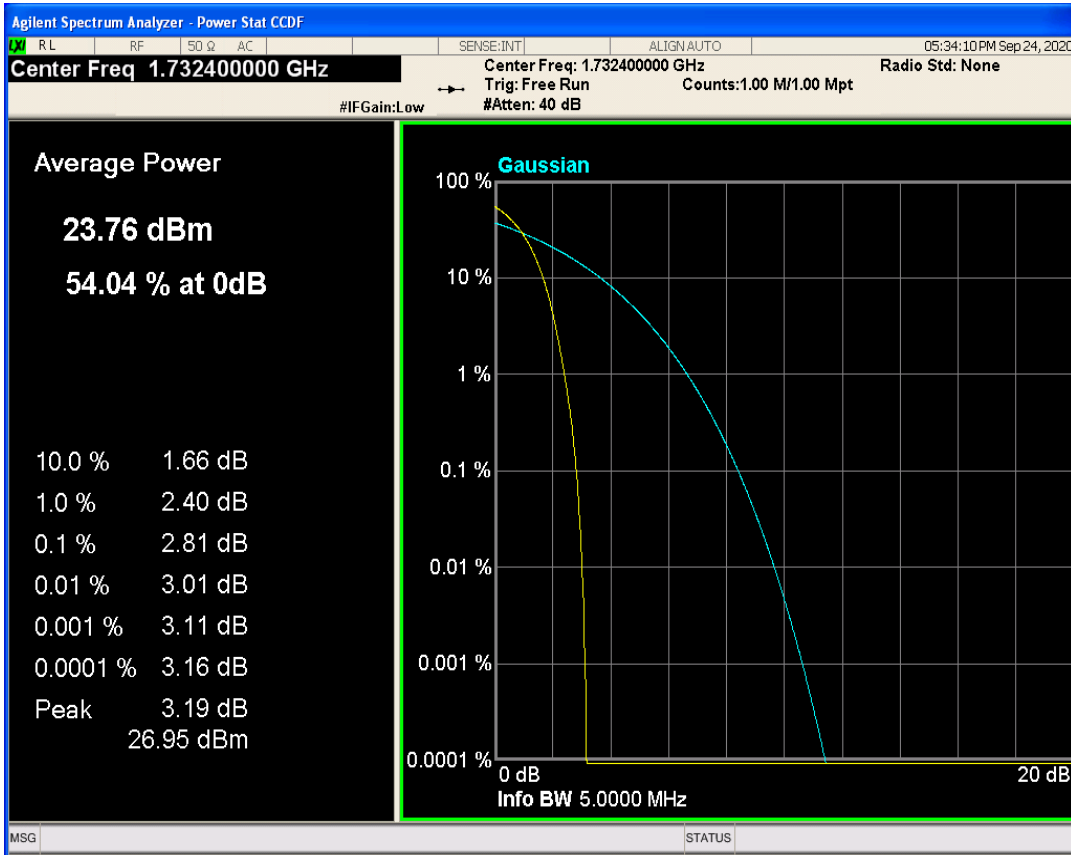

WCDMA Band4 Channel=1312

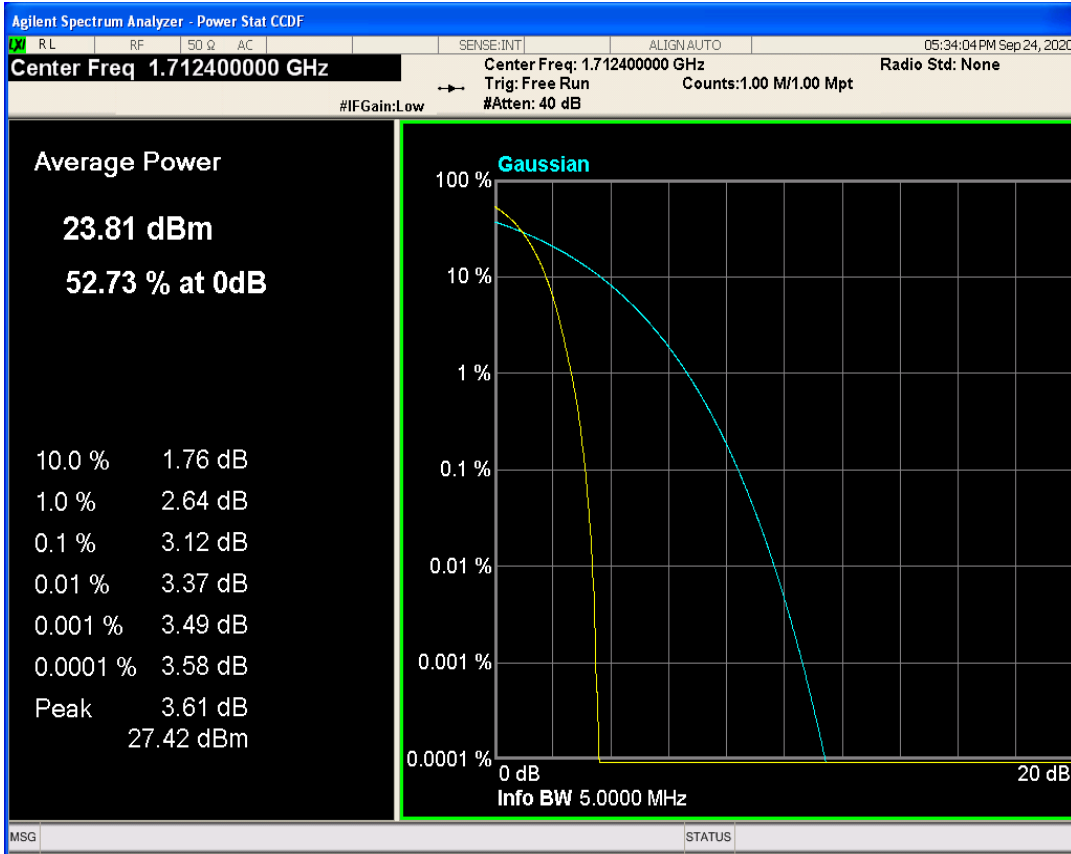

WCDMA Band4 Channel=1513

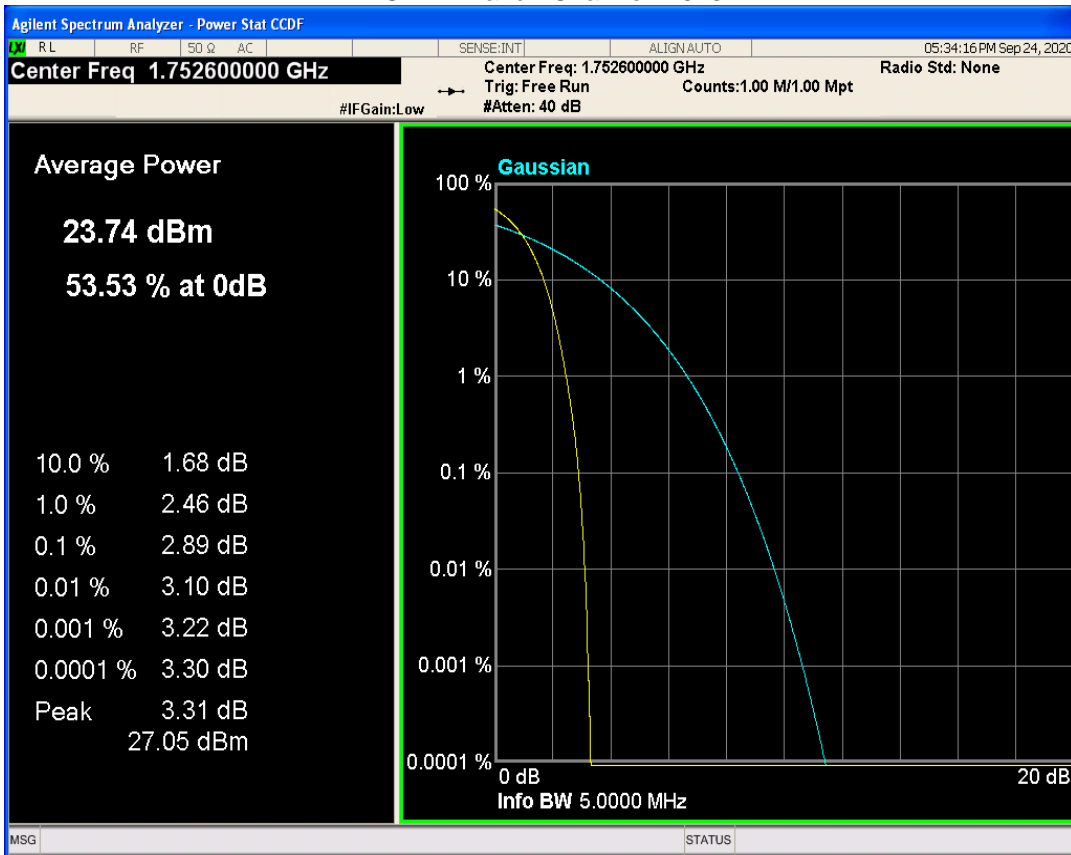

WCDMA Band5 Channel=4132

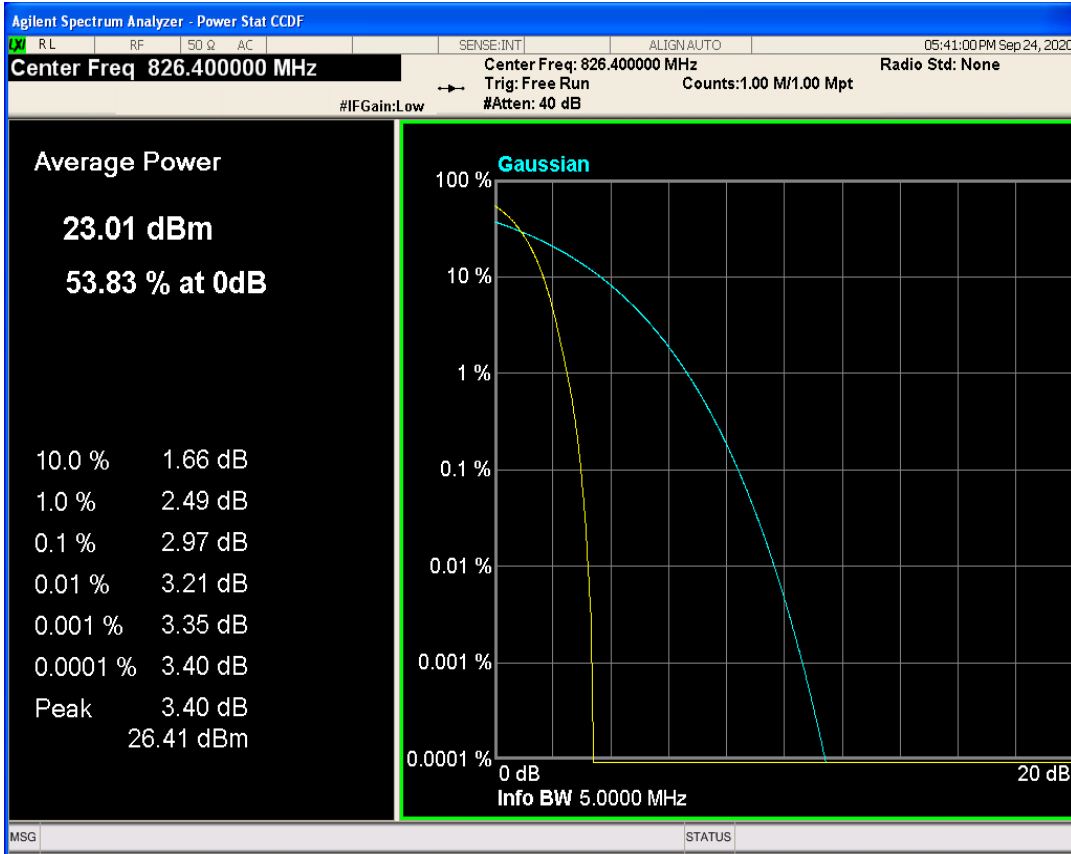

WCDMA Band5 Channel=4233

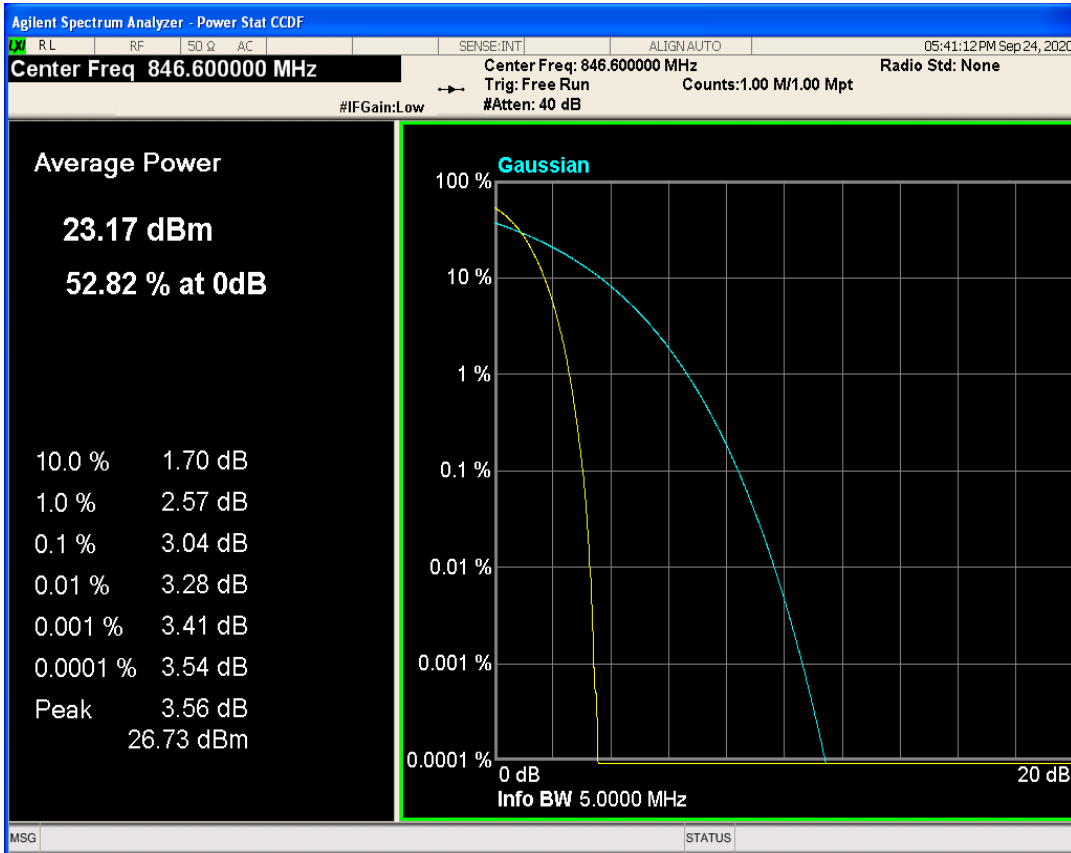

WCDMA Band5 Channel=4182

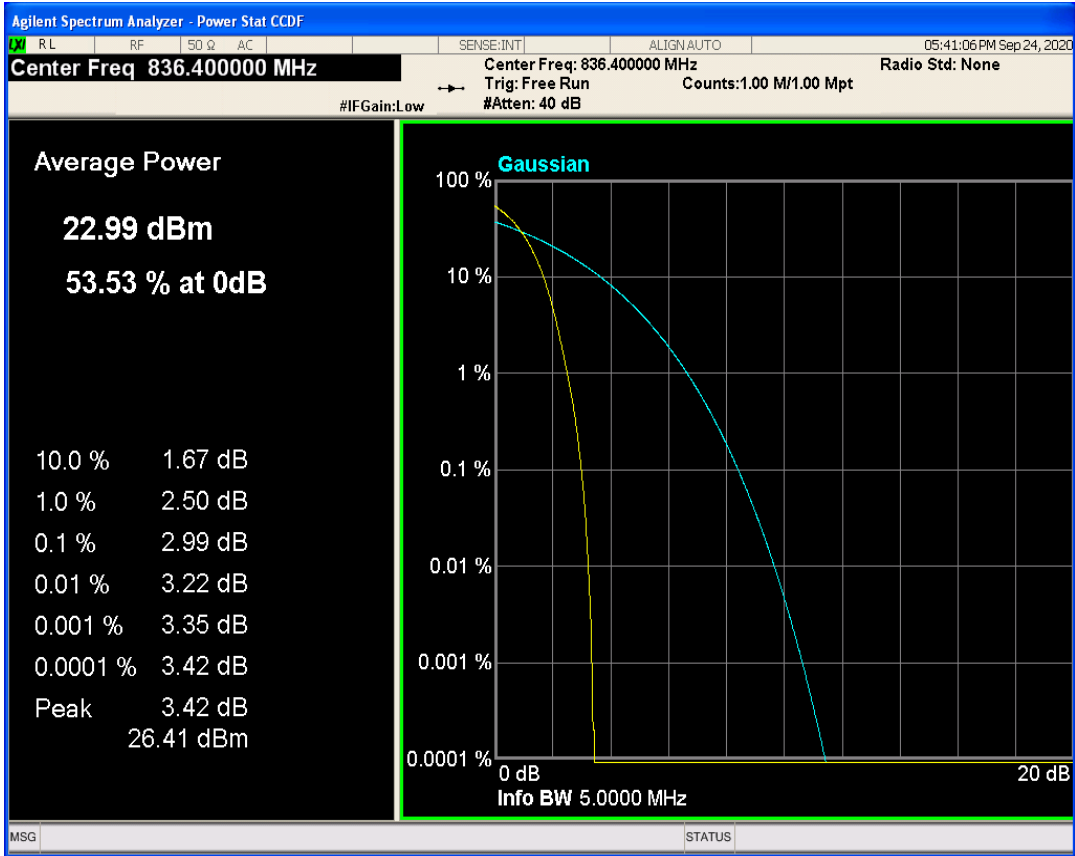

8.3 OCCUPIED BANDWIDTH

Band	Channel	Frequency (MHz)	99% OBW (kHz)	-26dB EBW (kHz)	Verdict
GSM850	128	824.2	247.124	320.320	PASS
GSM850	189	836.4	248.063	318.282	PASS
GSM850	251	848.8	246.789	312.934	PASS
GSM1900	512	1850.2	241.199	307.261	PASS
GSM1900	661	1880	245.332	315.514	PASS
GSM1900	810	1909.8	242.084	320.397	PASS
GPRS850	128	824.2	243.451	312.934	PASS
GPRS850	189	836.4	246.488	307.892	PASS
GPRS850	251	848.8	244.558	311.794	PASS
GPRS1900	512	1850.2	248.758	317.451	PASS
GPRS1900	661	1880	248.692	308.717	PASS
GPRS1900	810	1909.8	243.888	317.044	PASS
EGPRS850	128	824.2	243.395	289.685	PASS
EGPRS850	189	836.4	232.235	286.300	PASS
EGPRS850	251	848.8	244.499	307.018	PASS
EGPRS1900	512	1850.2	253.144	323.353	PASS
EGPRS1900	661	1880	250.027	318.370	PASS
EGPRS1900	810	1909.8	253.708	315.735	PASS
WCDMA Band2	9262	1852.4	4191.689	4713.509	PASS
WCDMA Band2	9400	1880	4175.393	4719.622	PASS
WCDMA Band2	9538	1907.6	4171.577	4707.210	PASS
WCDMA Band4	1312	1712.4	4180.029	4699.781	PASS
WCDMA Band4	1412	1732.4	4173.979	4737.653	PASS
WCDMA Band4	1513	1752.6	4166.921	4706.253	PASS
WCDMA Band5	4132	826.4	4173.253	4710.289	PASS
WCDMA Band5	4182	836.4	4173.844	4707.372	PASS
WCDMA Band5	4233	846.6	4167.503	4730.274	PASS

GSM850 Channel=128

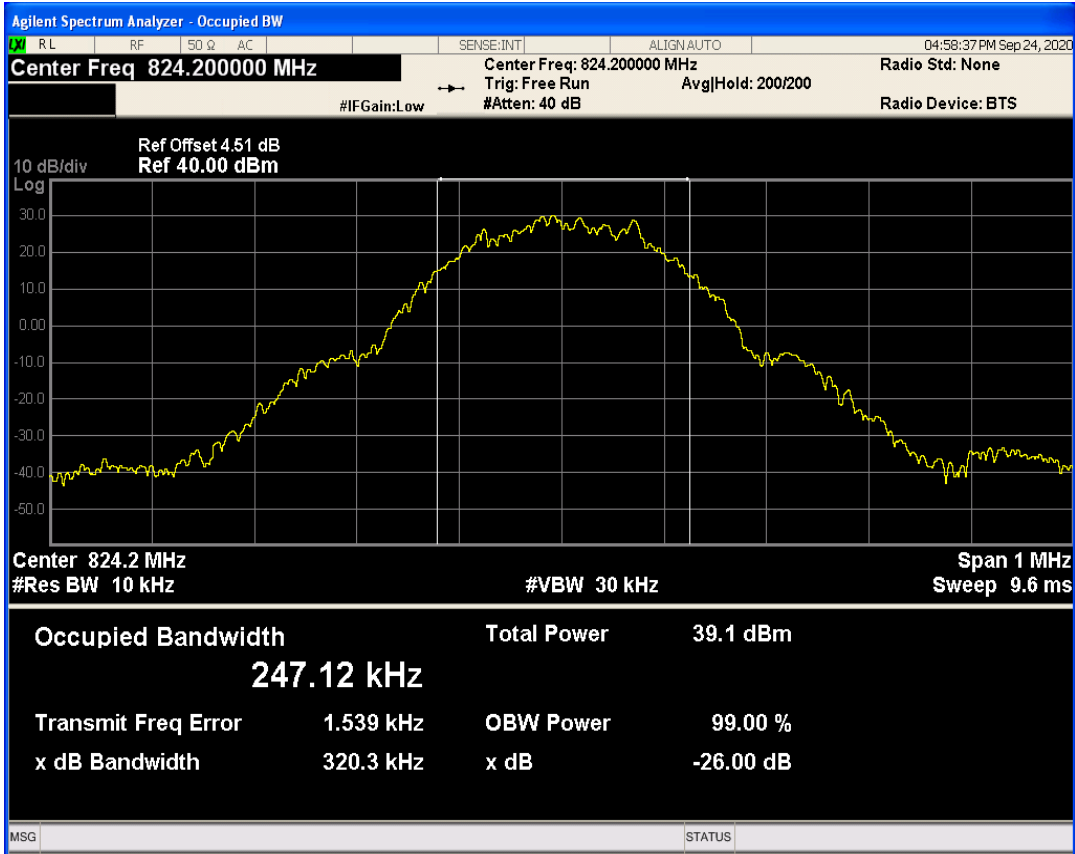

GSM850 Channel=189

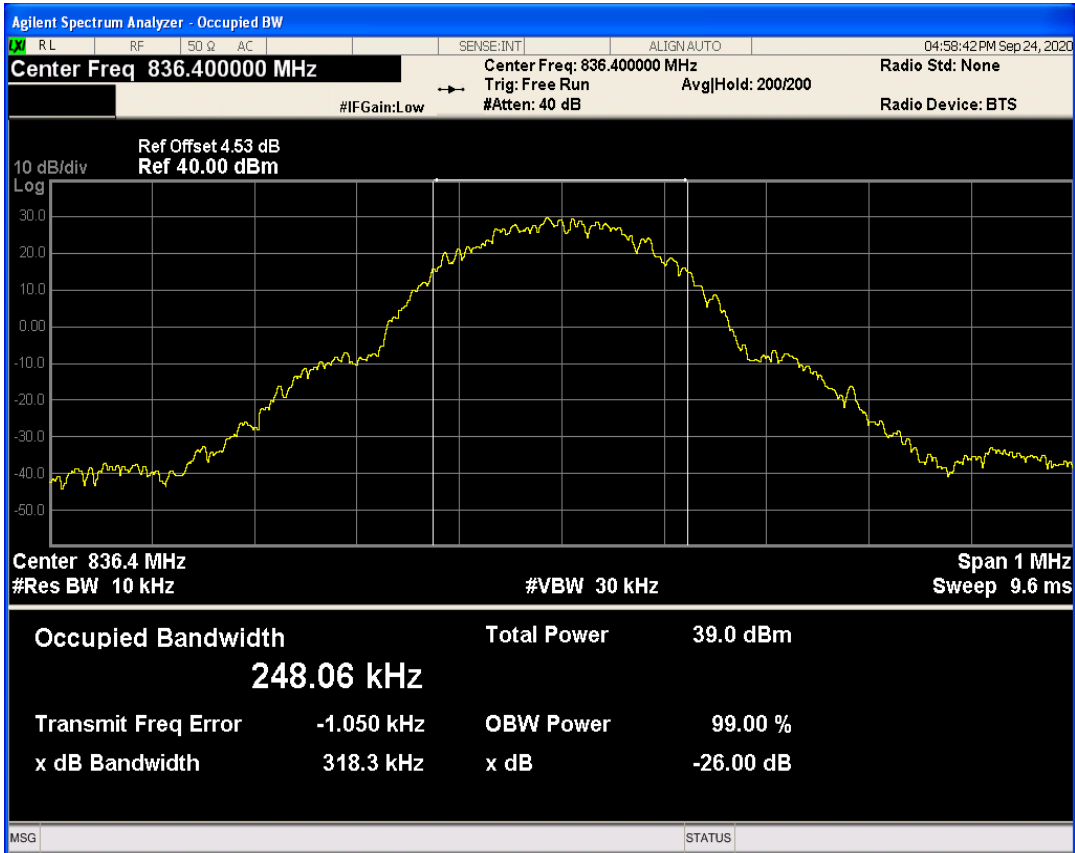

GSM850 Channel=251

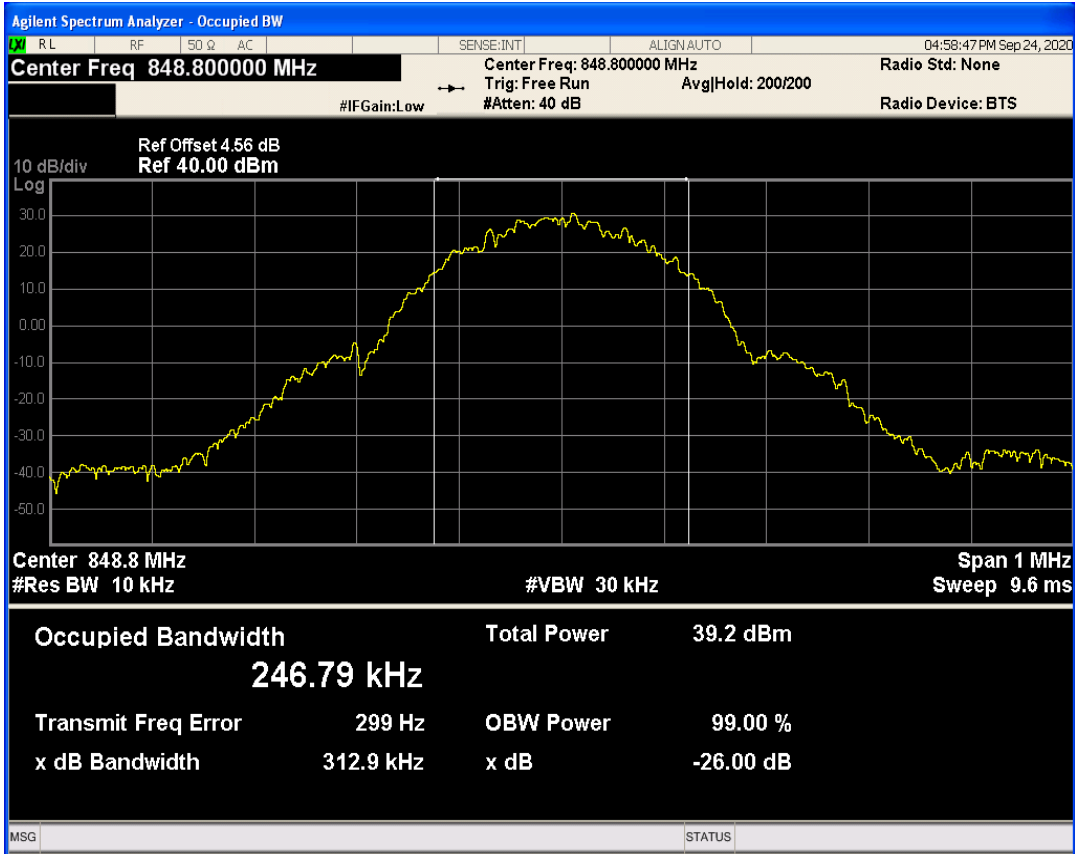

GSM1900 Channel=512

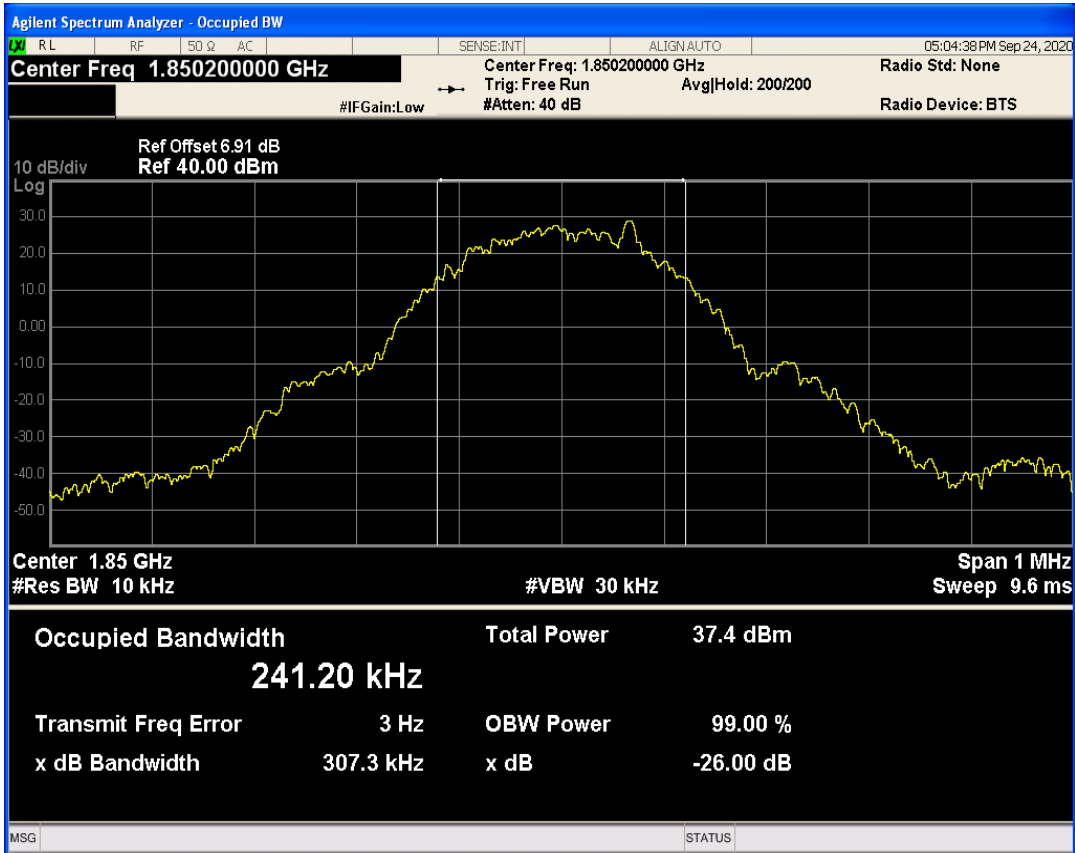

GSM1900 Channel=661

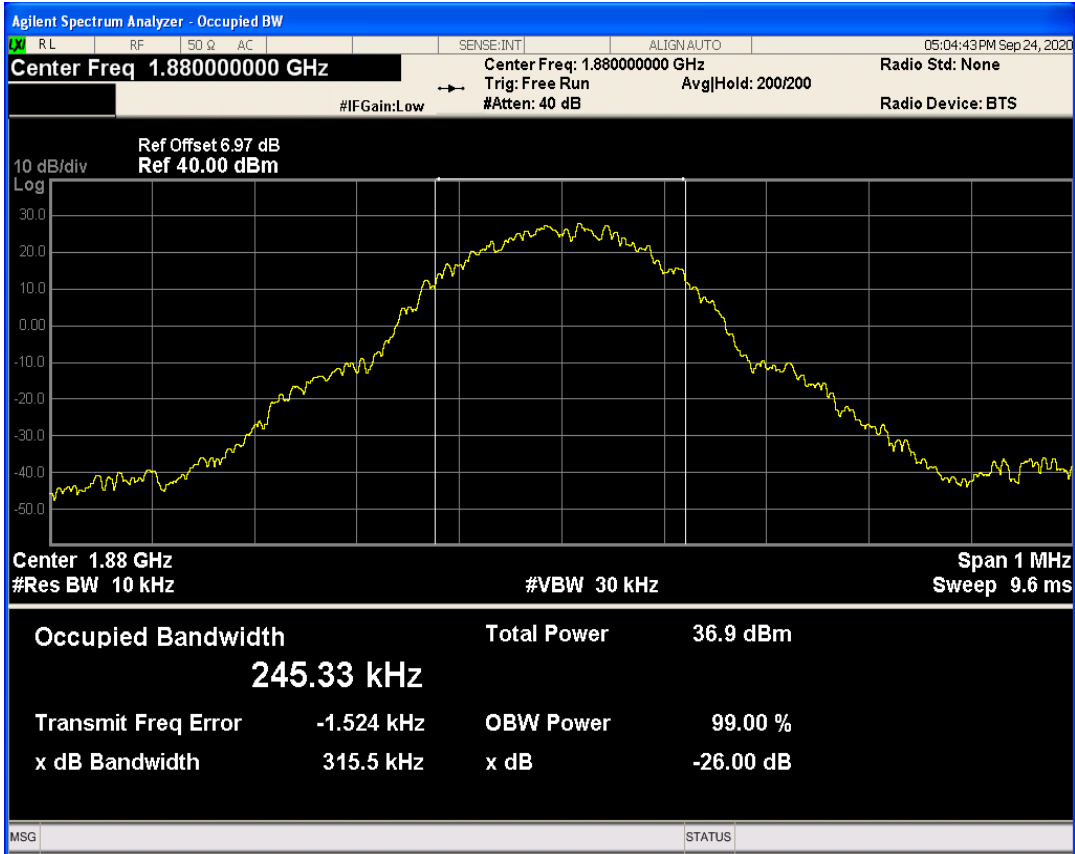

GSM1900 Channel=810

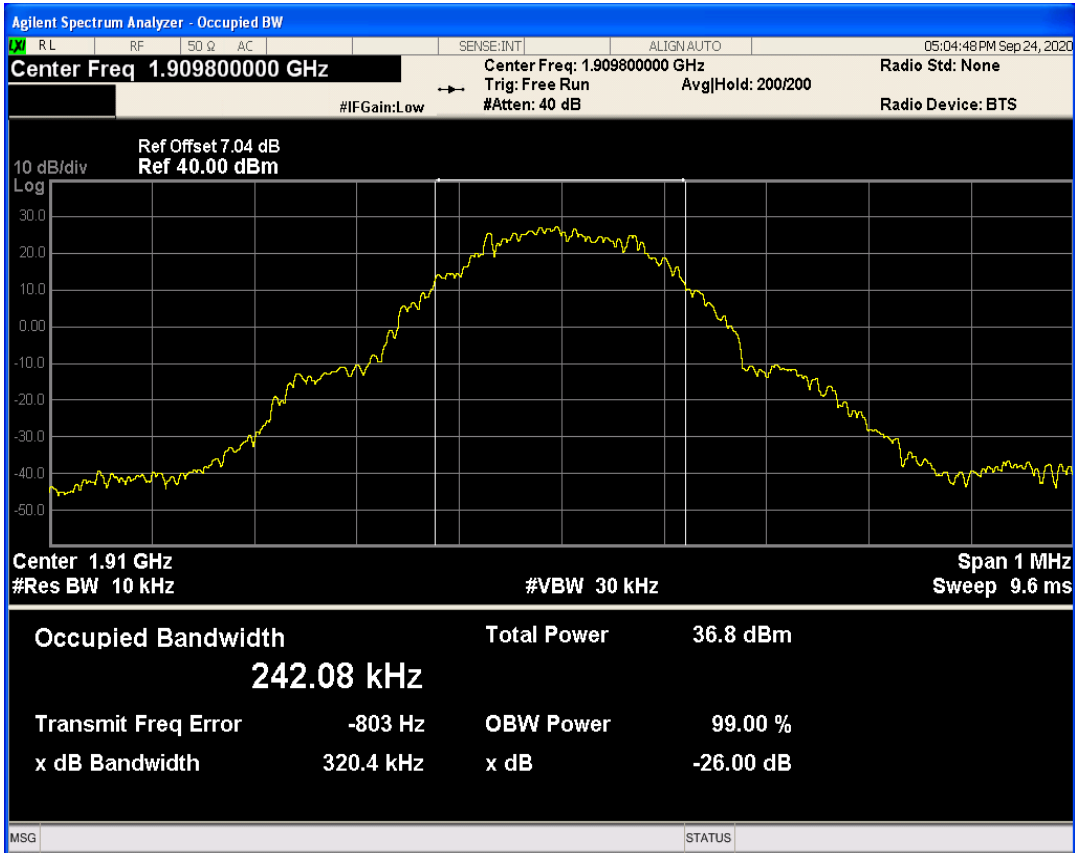

GPRS850 Channel=128

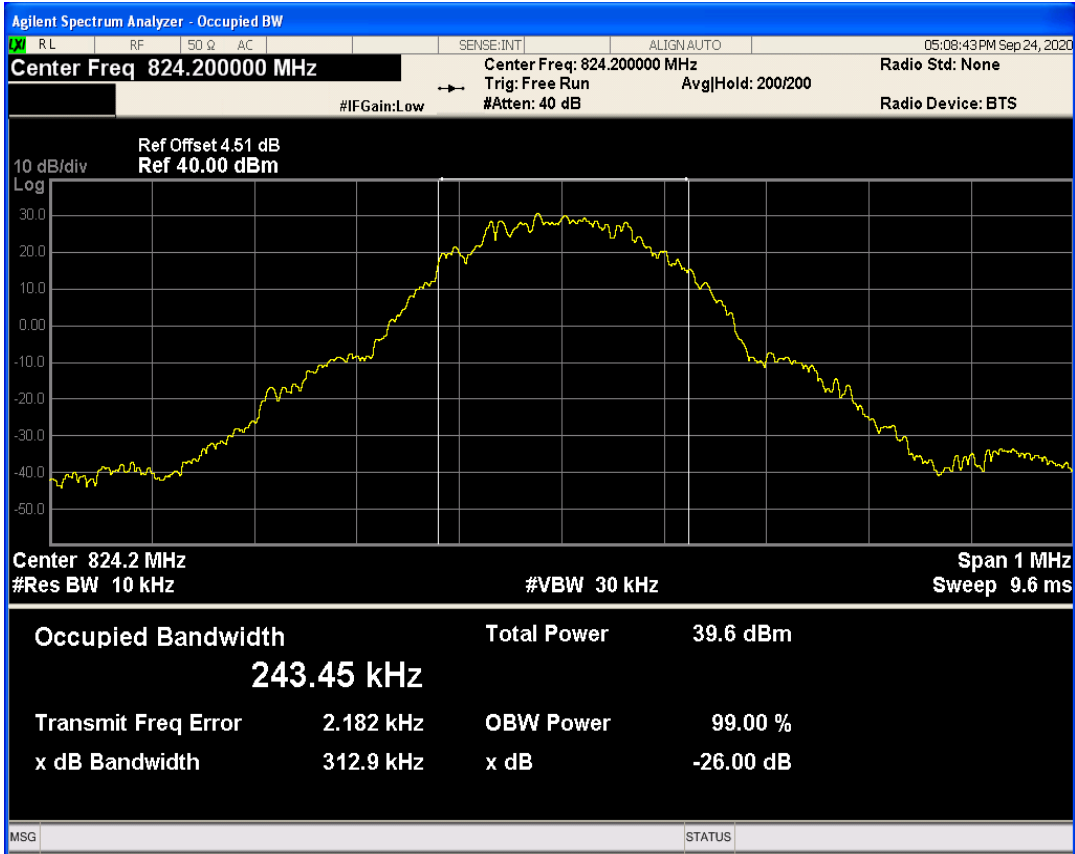

GPRS850 Channel=189

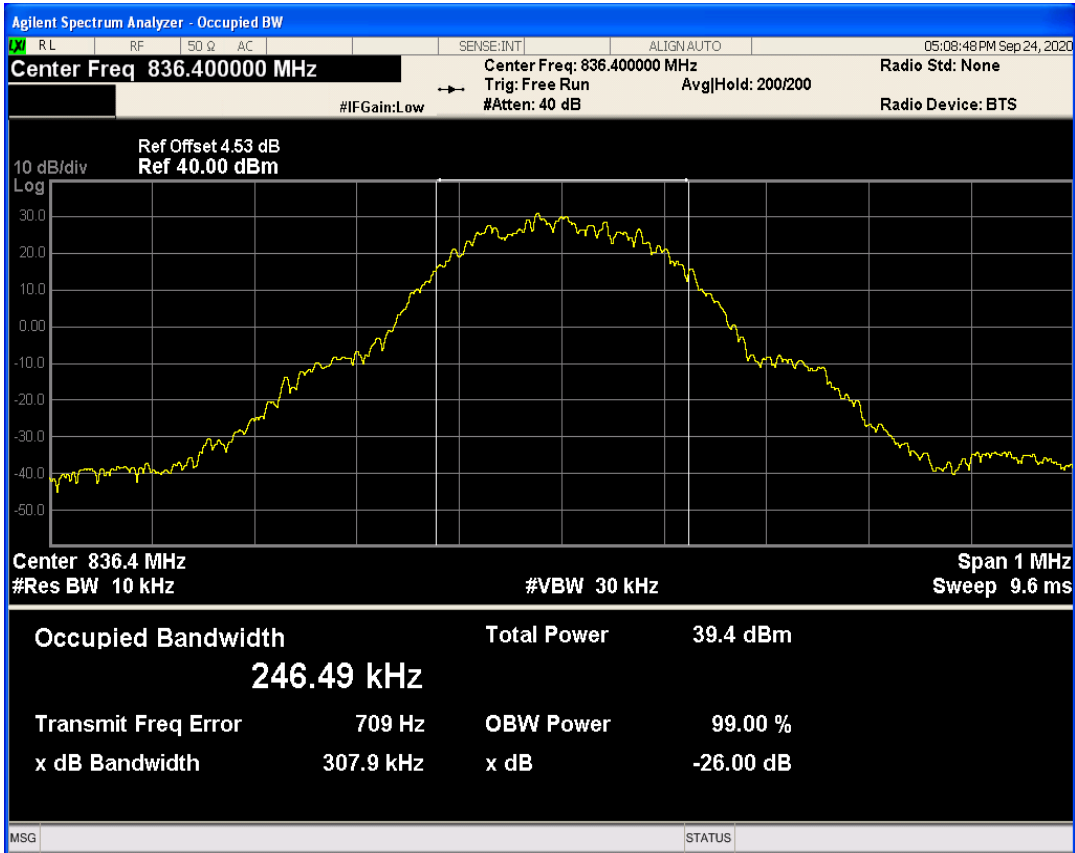

GPRS850 Channel=251

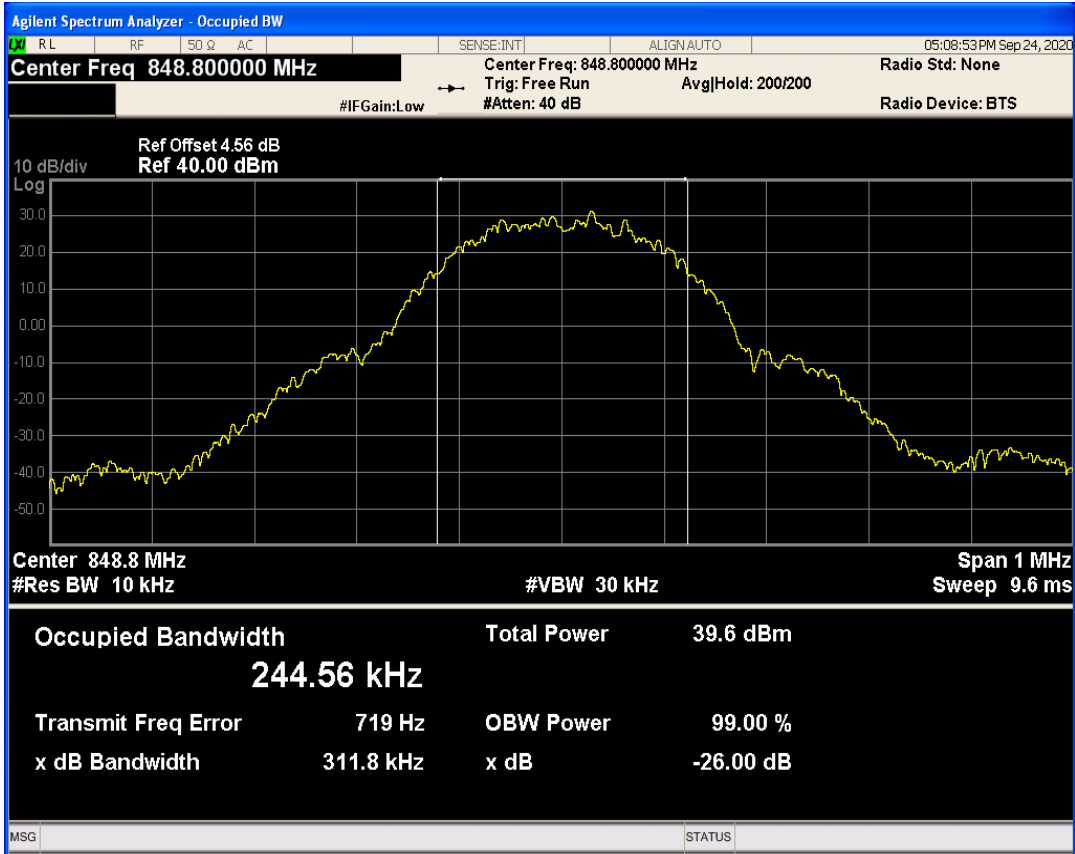

GPRS1900 Channel=512

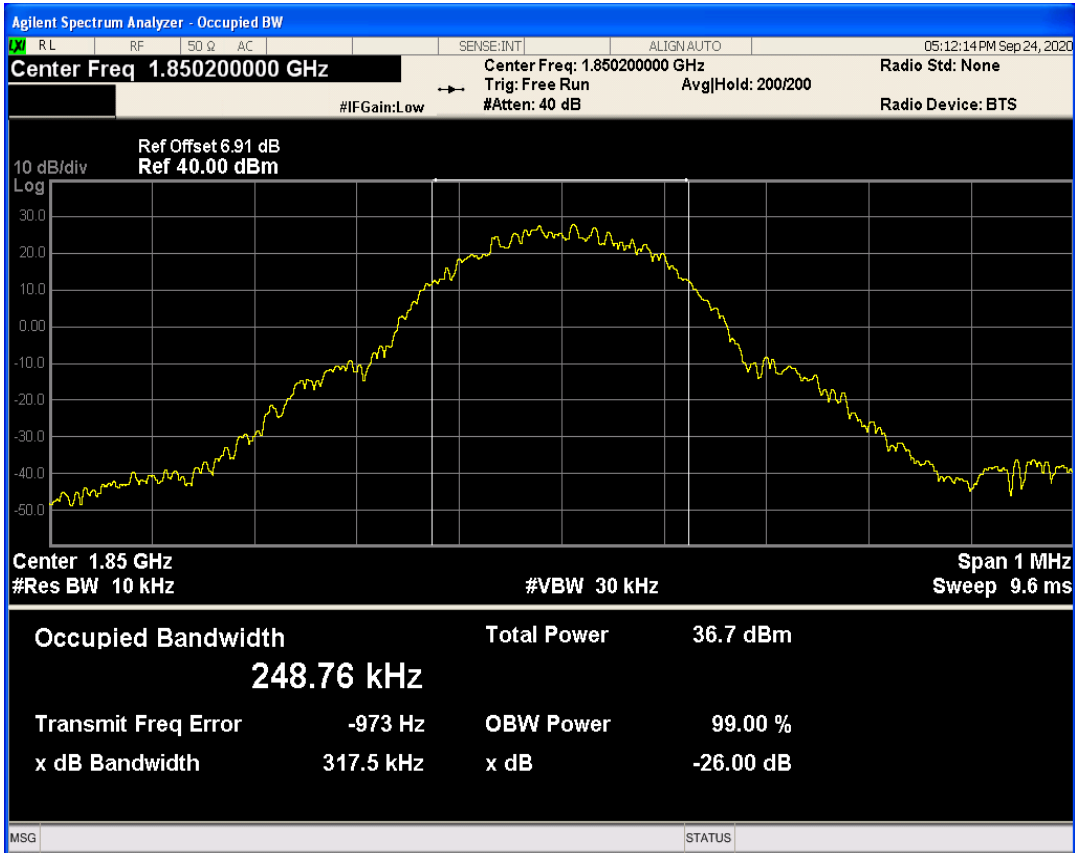

GPRS1900 Channel=661

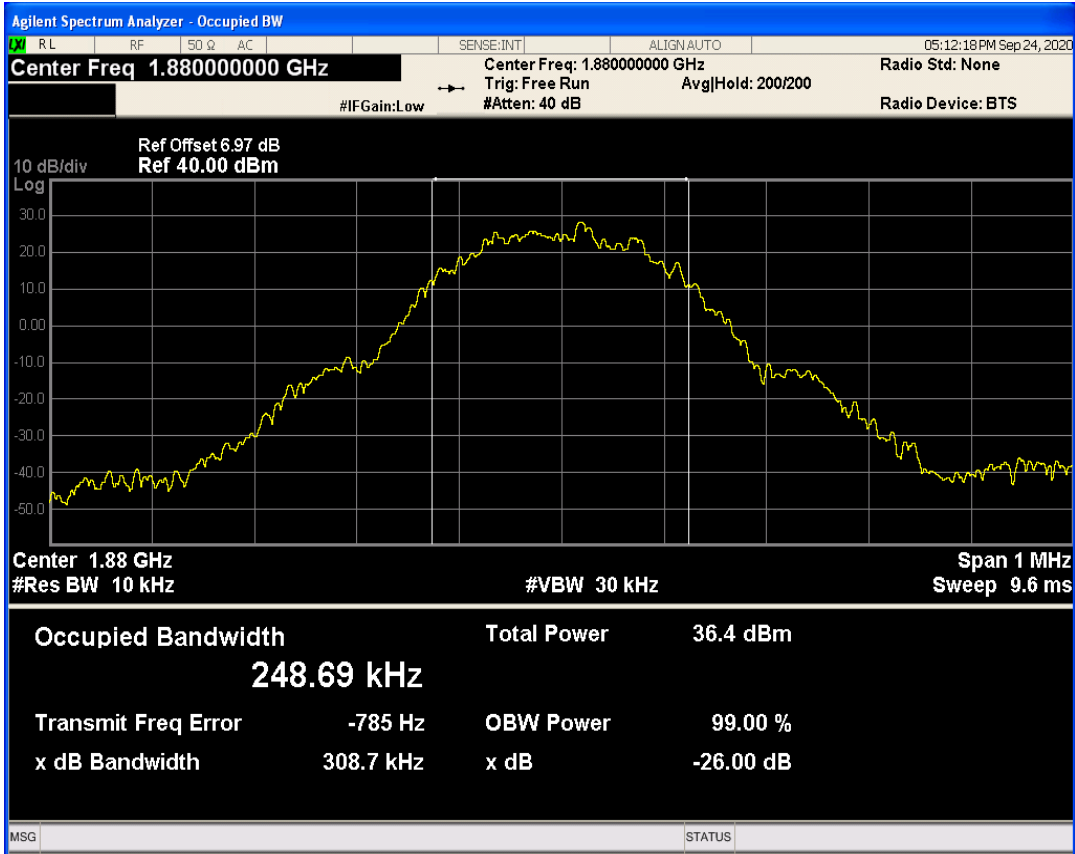

GPRS1900 Channel=810

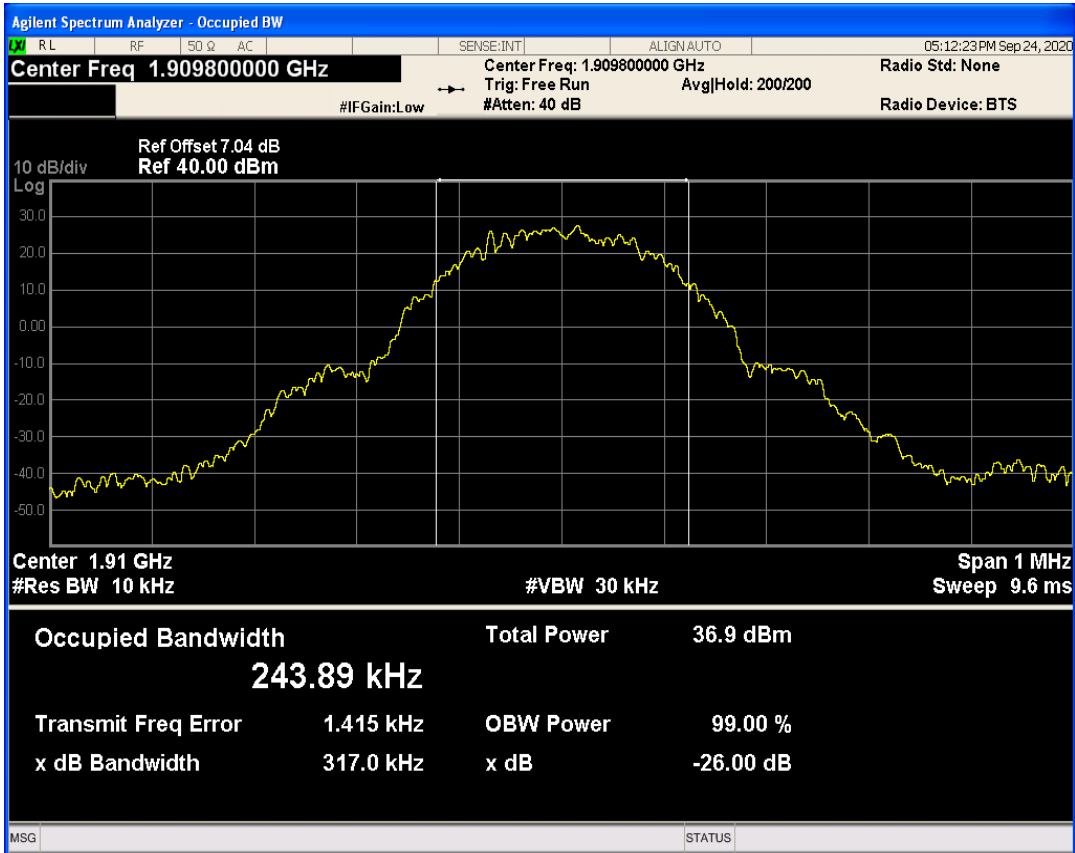

EGPRS850 Channel=189

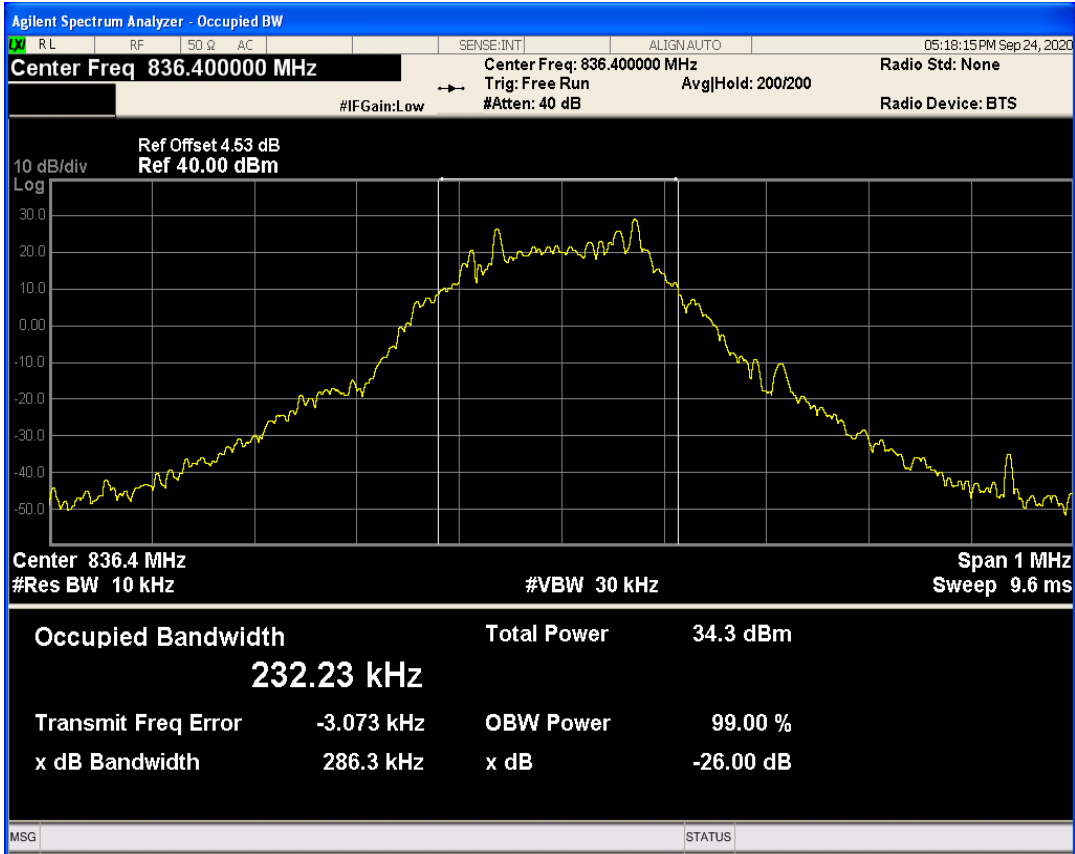

EGPRS850 Channel=128

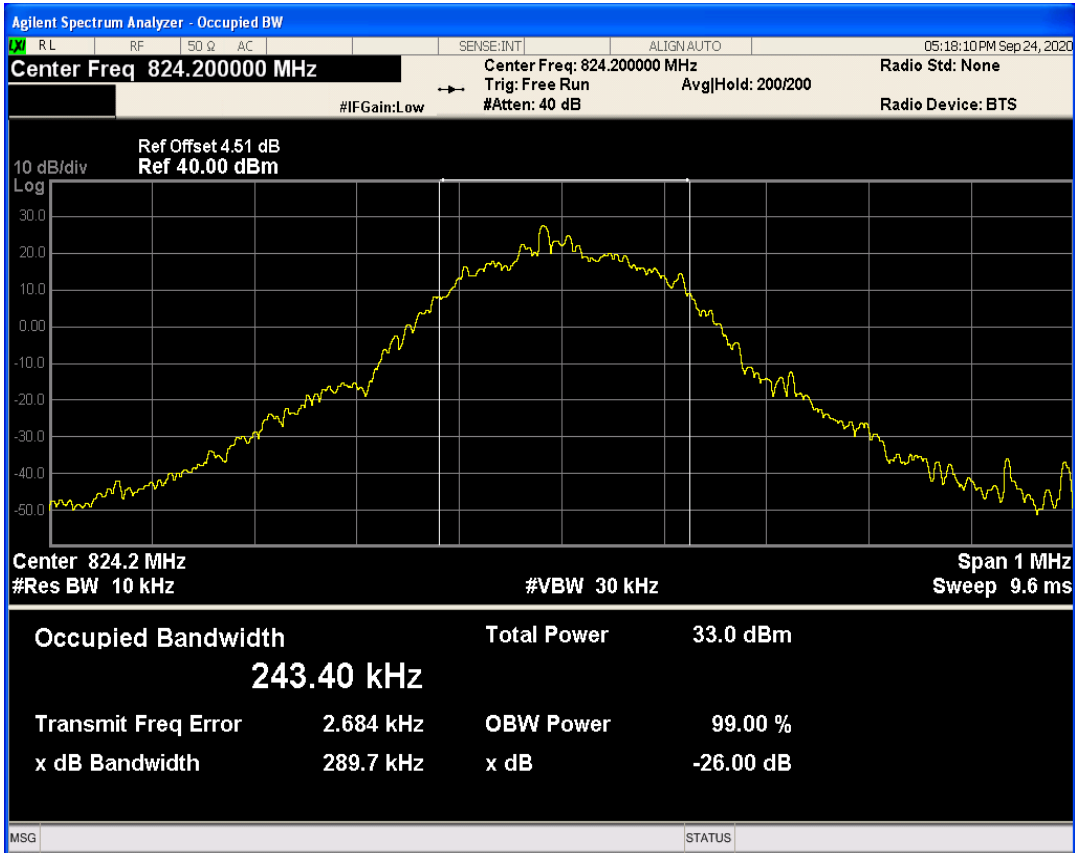

EGPRS850 Channel=251

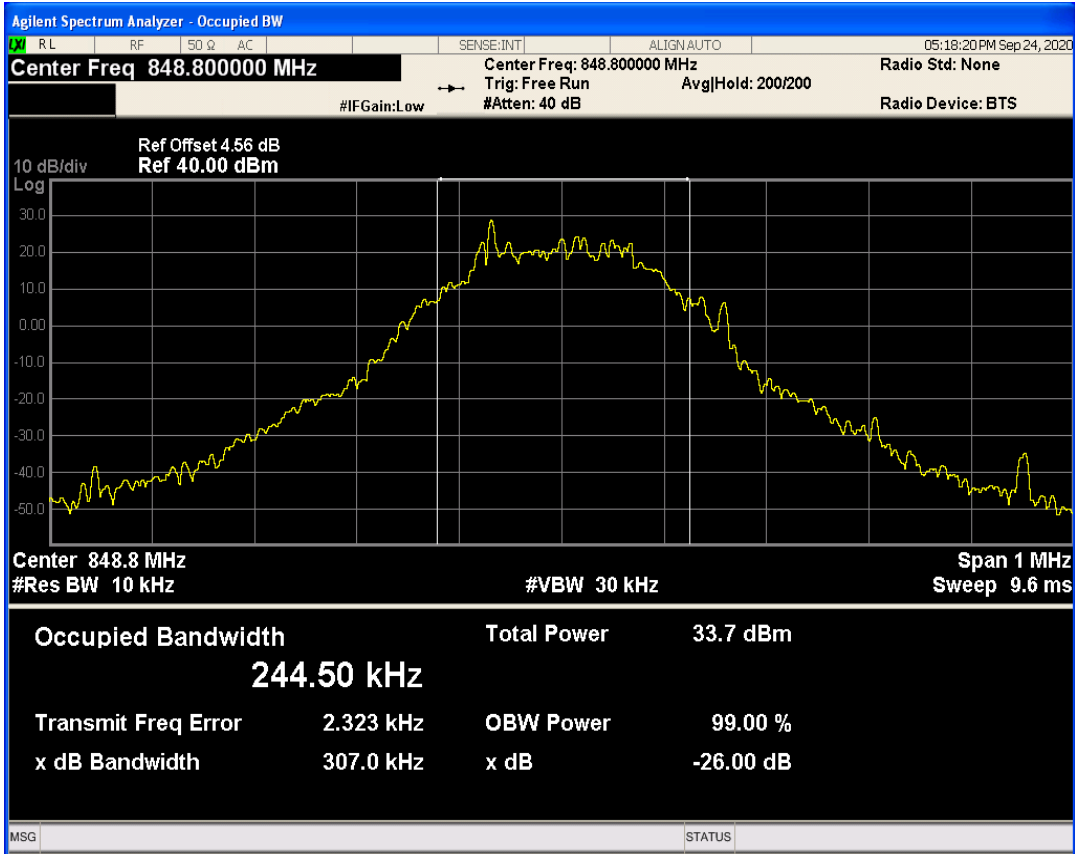

EGPRS1900 Channel=512

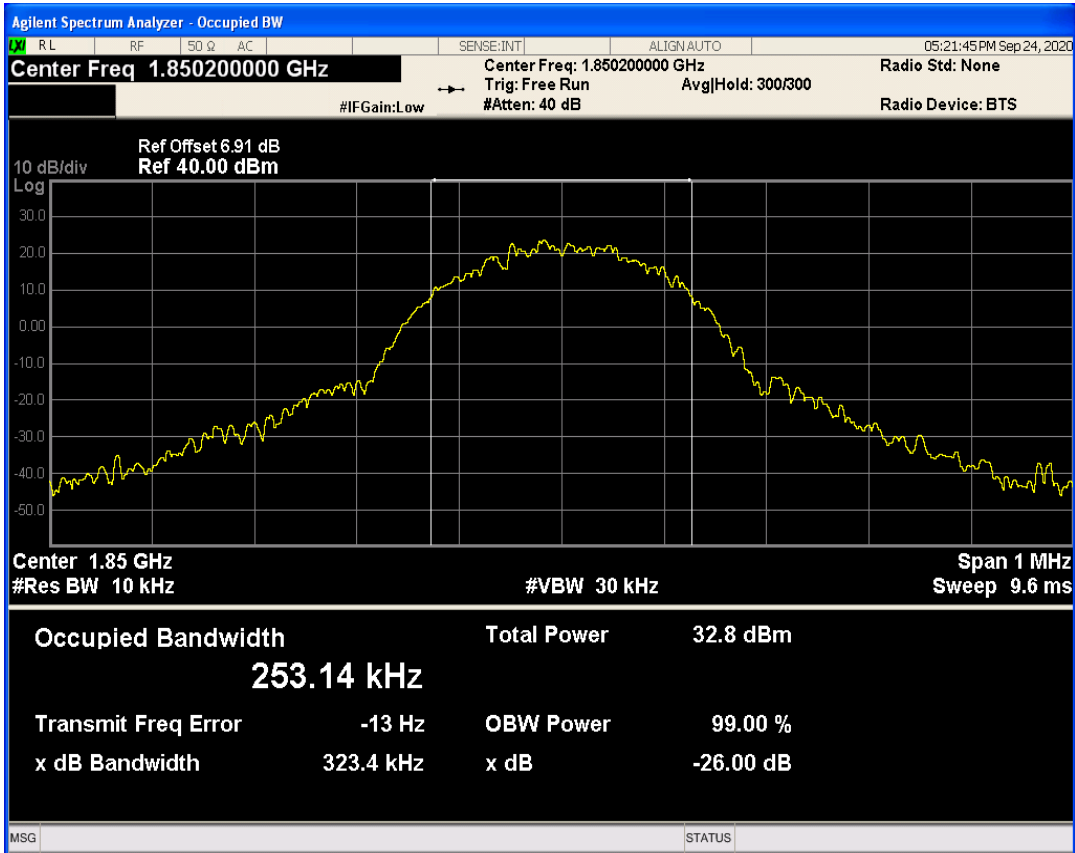

EGPRS1900 Channel=661

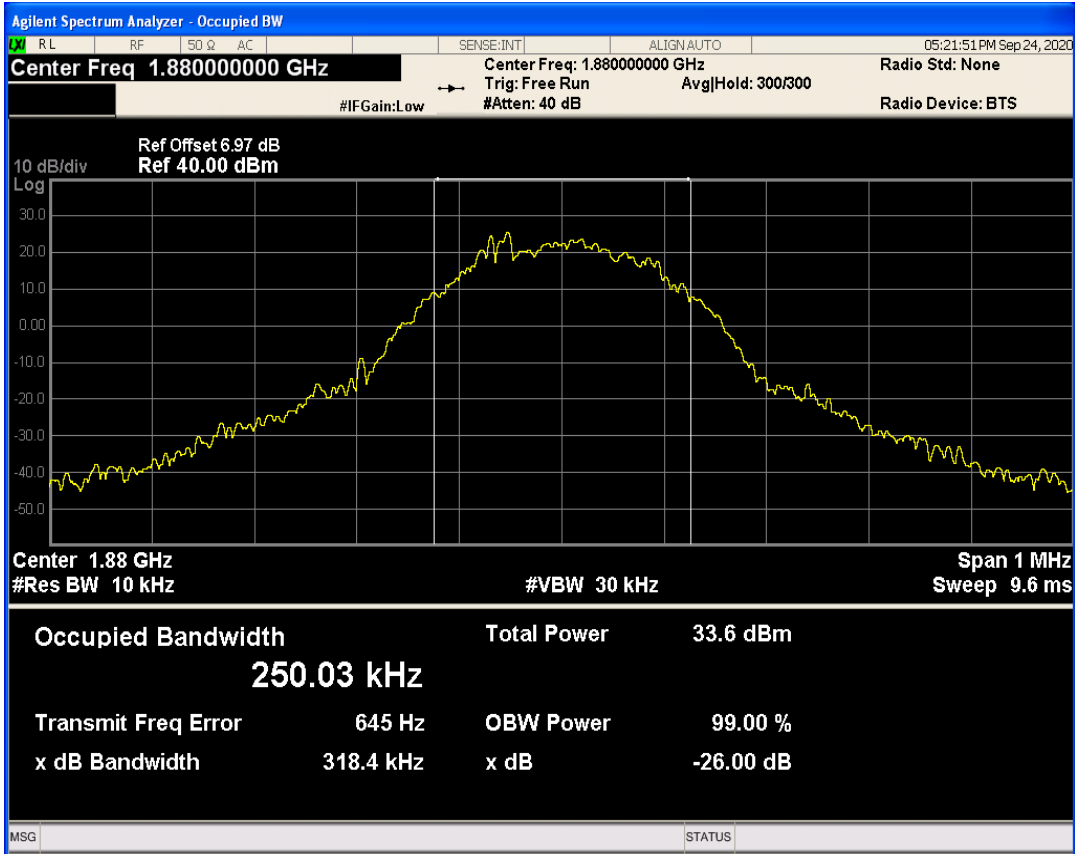

EGPRS1900 Channel=810

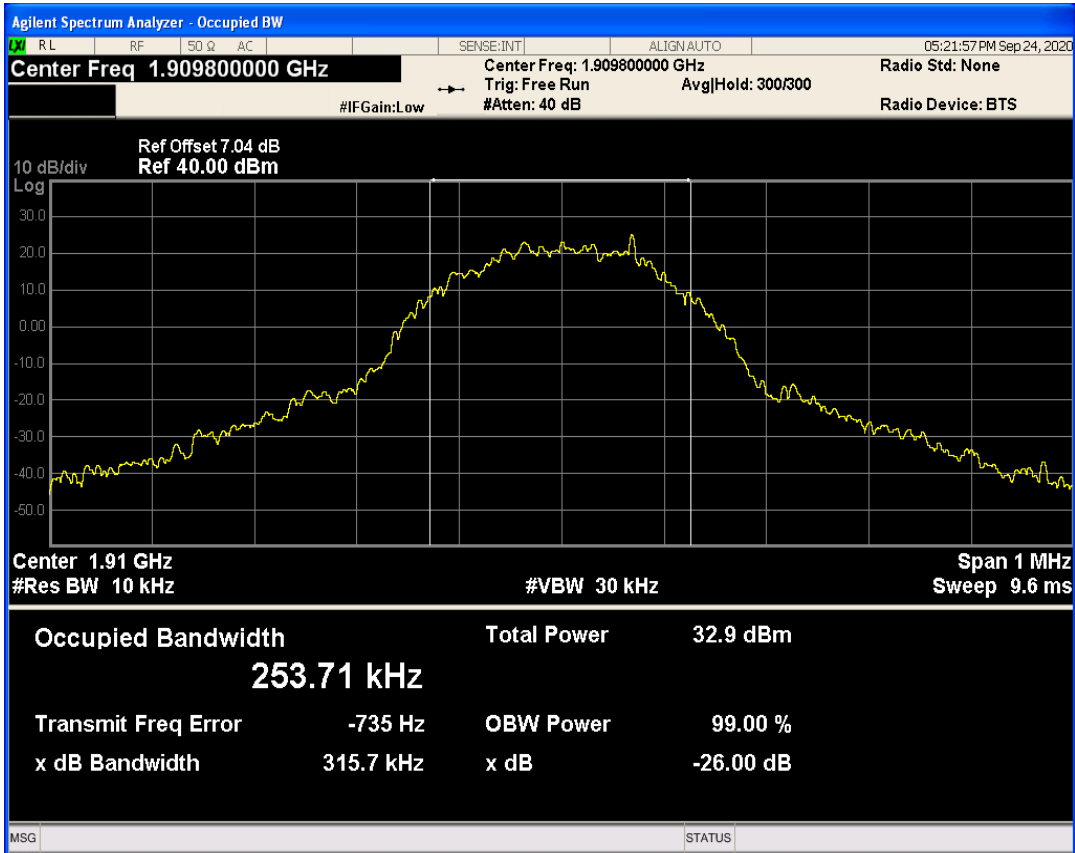

WCDMA Band2 Channel=9262

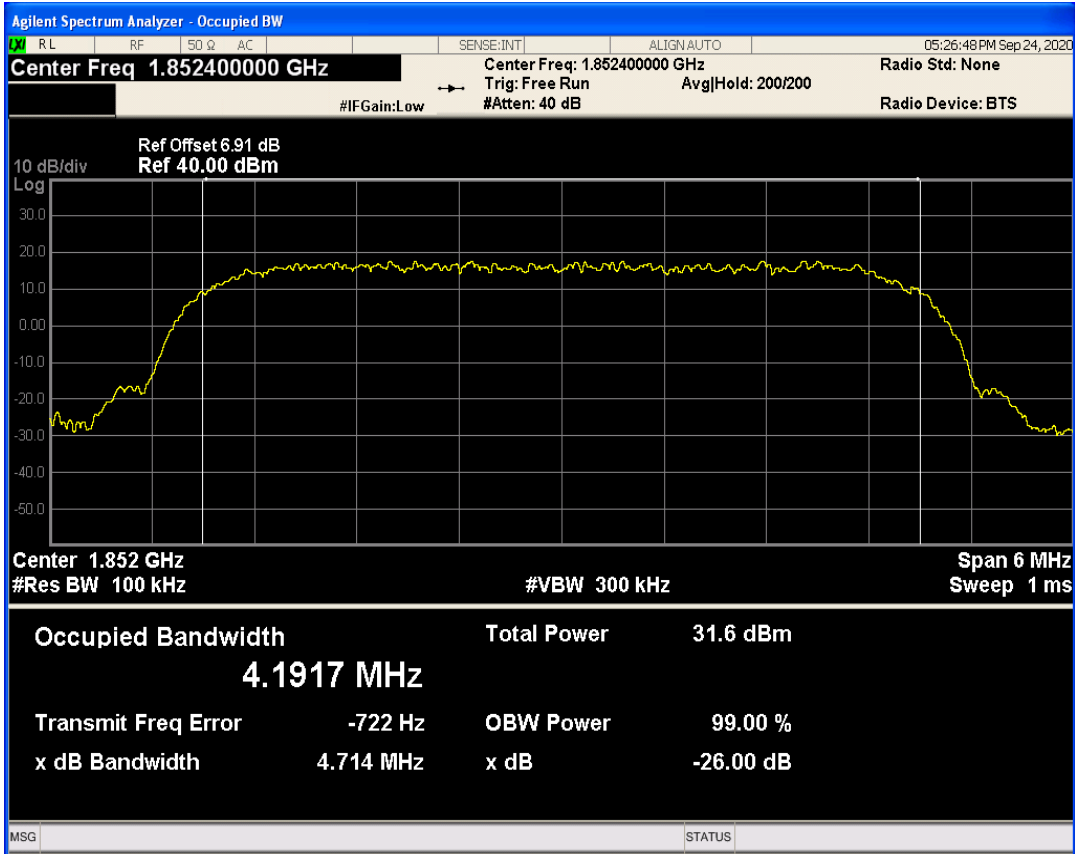

WCDMA Band2 Channel=9400

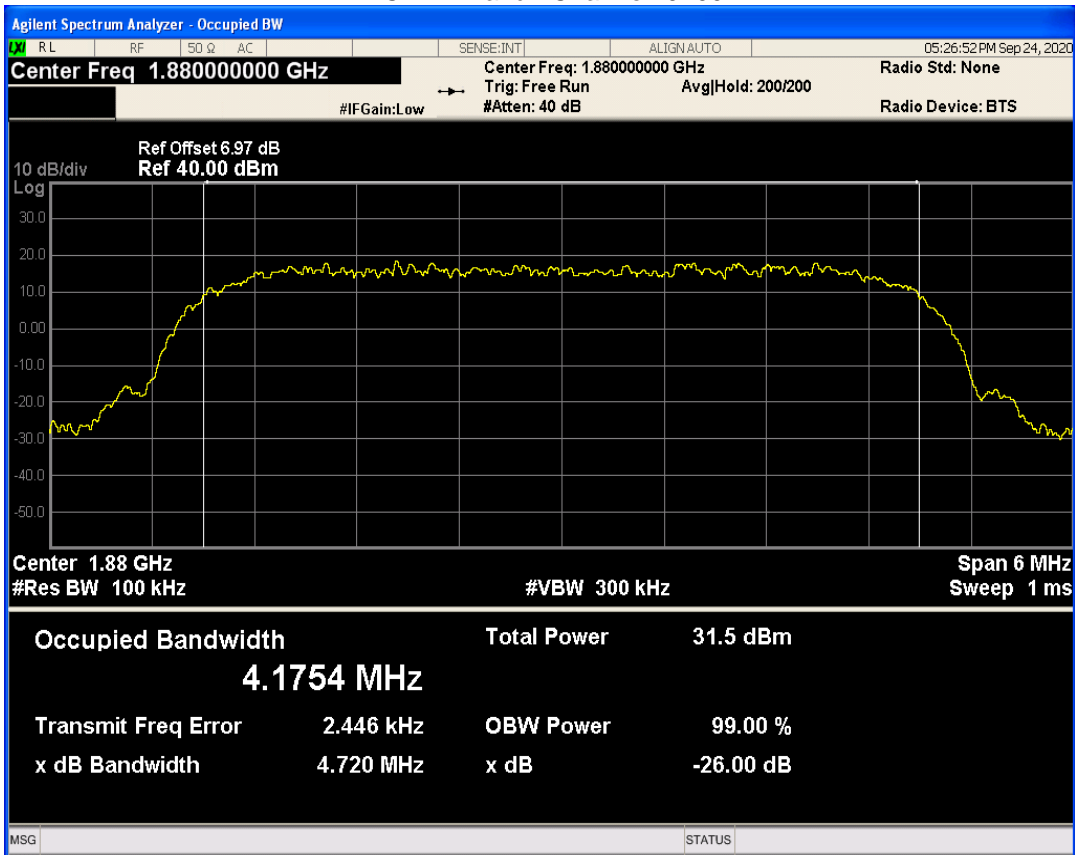

WCDMA Band2 Channel=9538

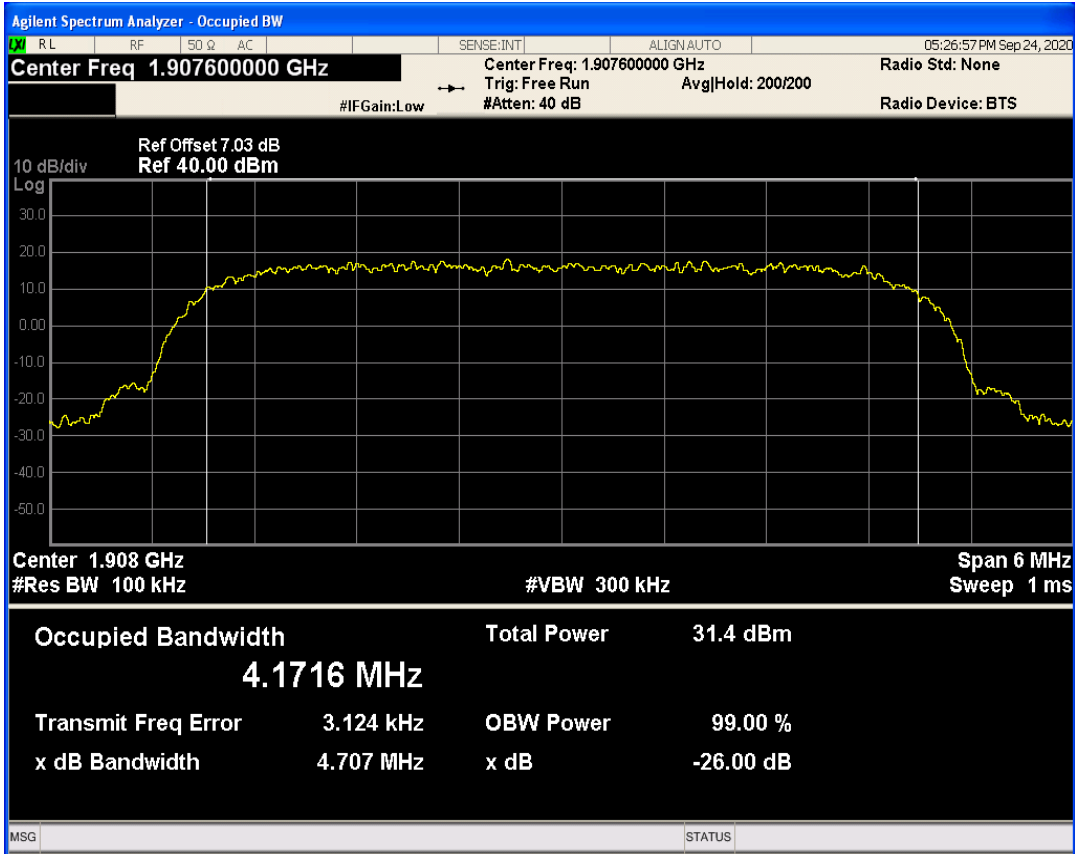

WCDMA Band4 Channel=1312

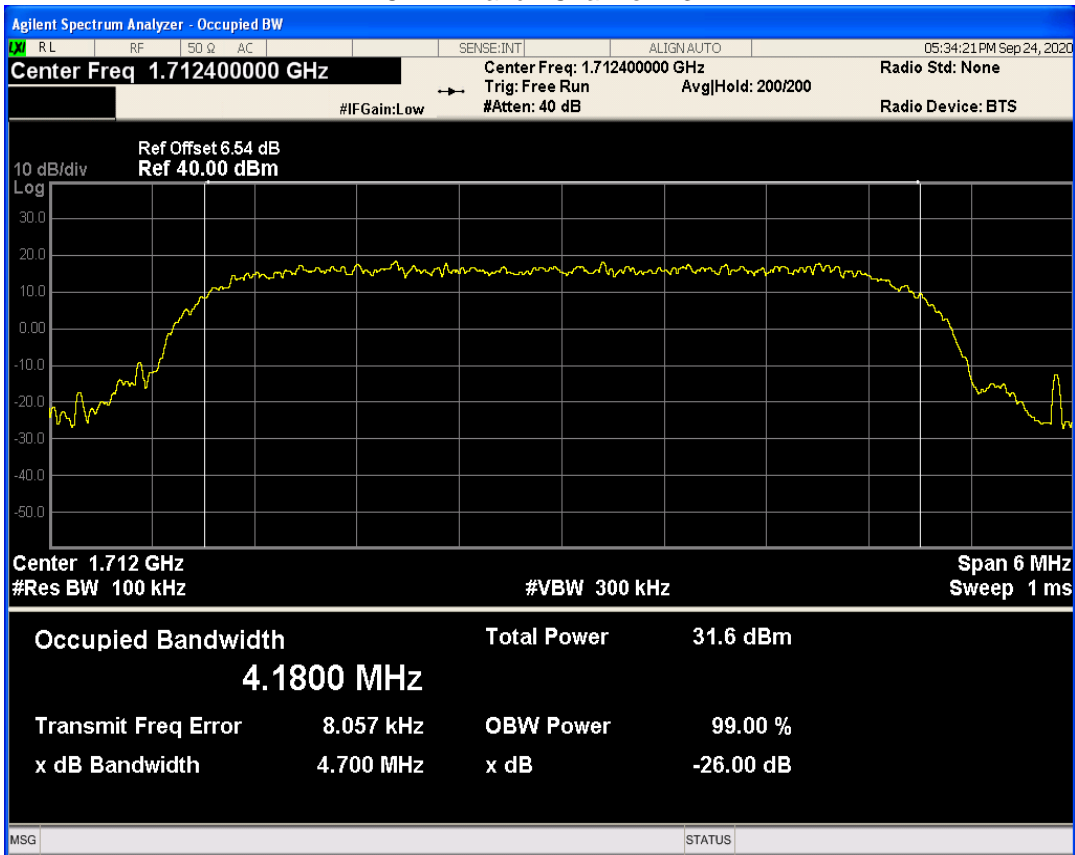

WCDMA Band4 Channel=1513

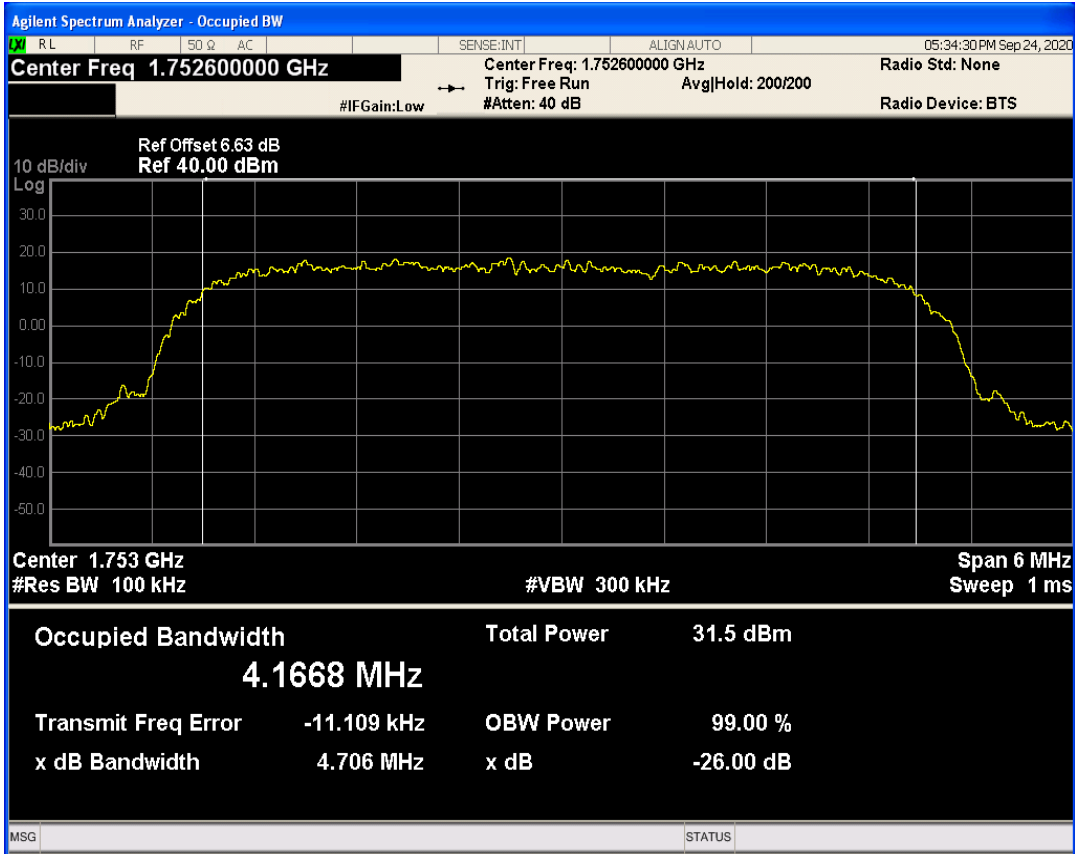

WCDMA Band4 Channel=1412

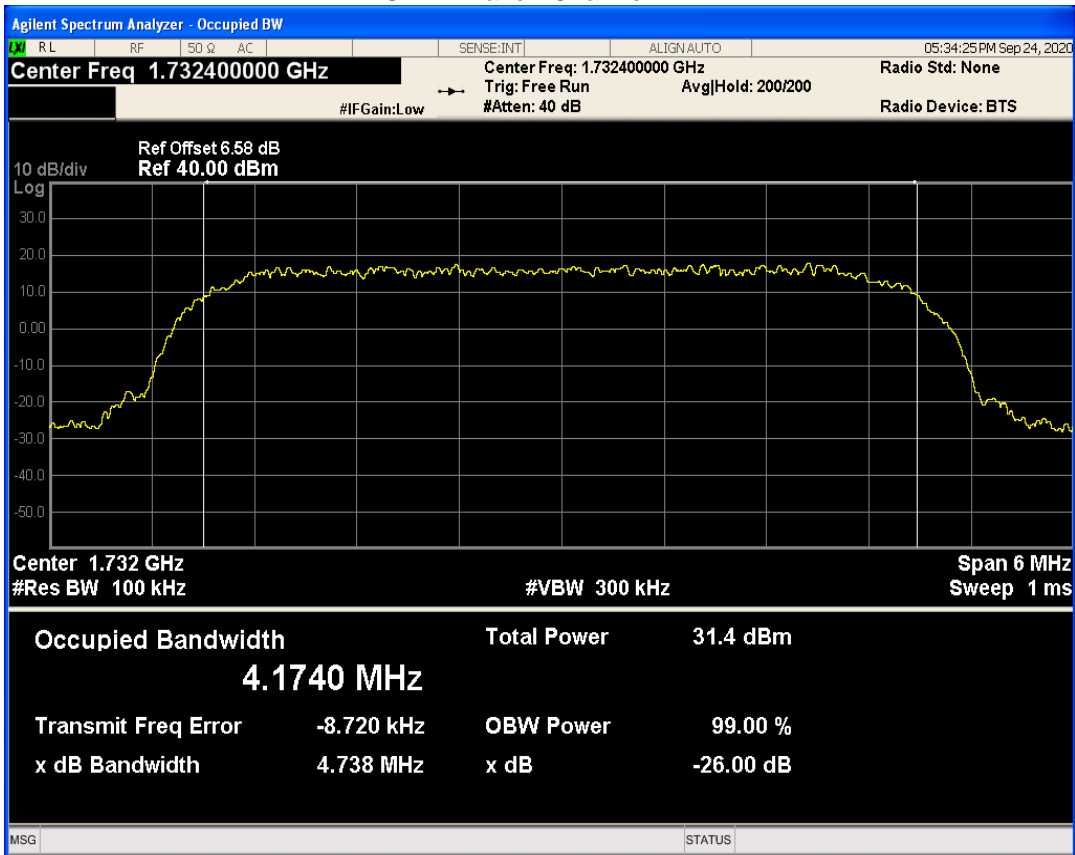

WCDMA Band5 Channel=4132

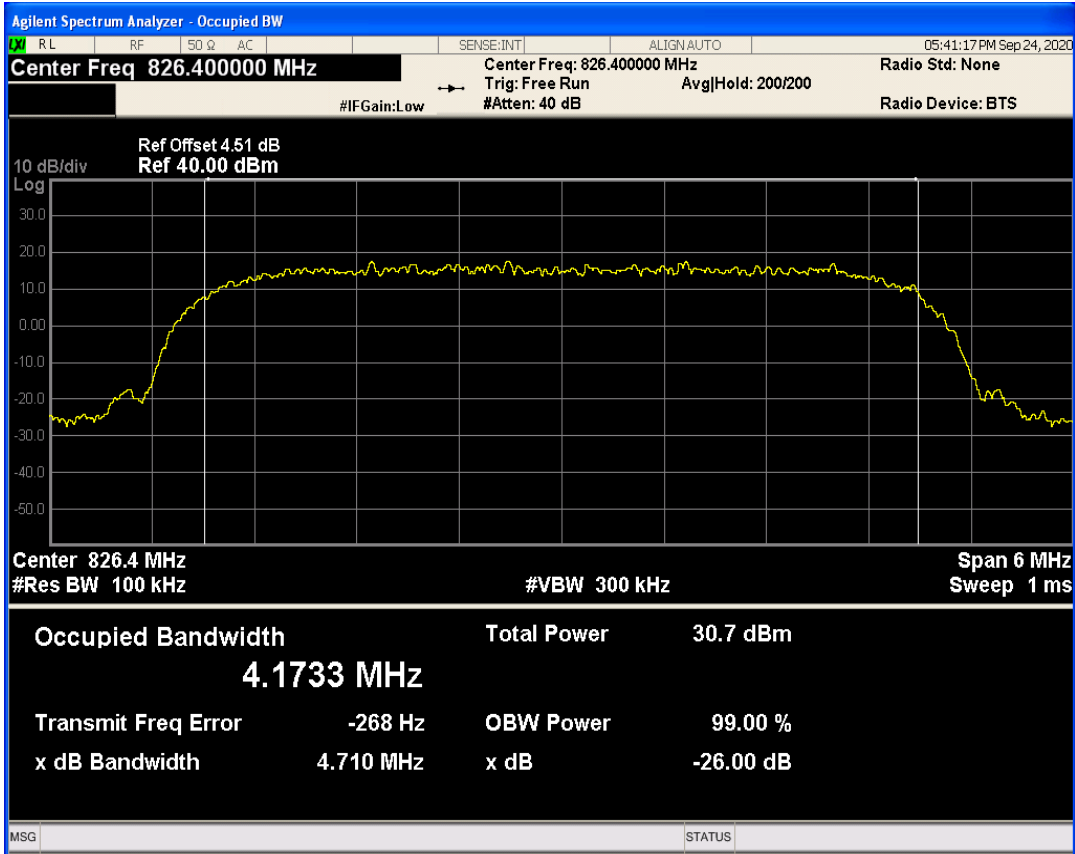

WCDMA Band5 Channel=4233

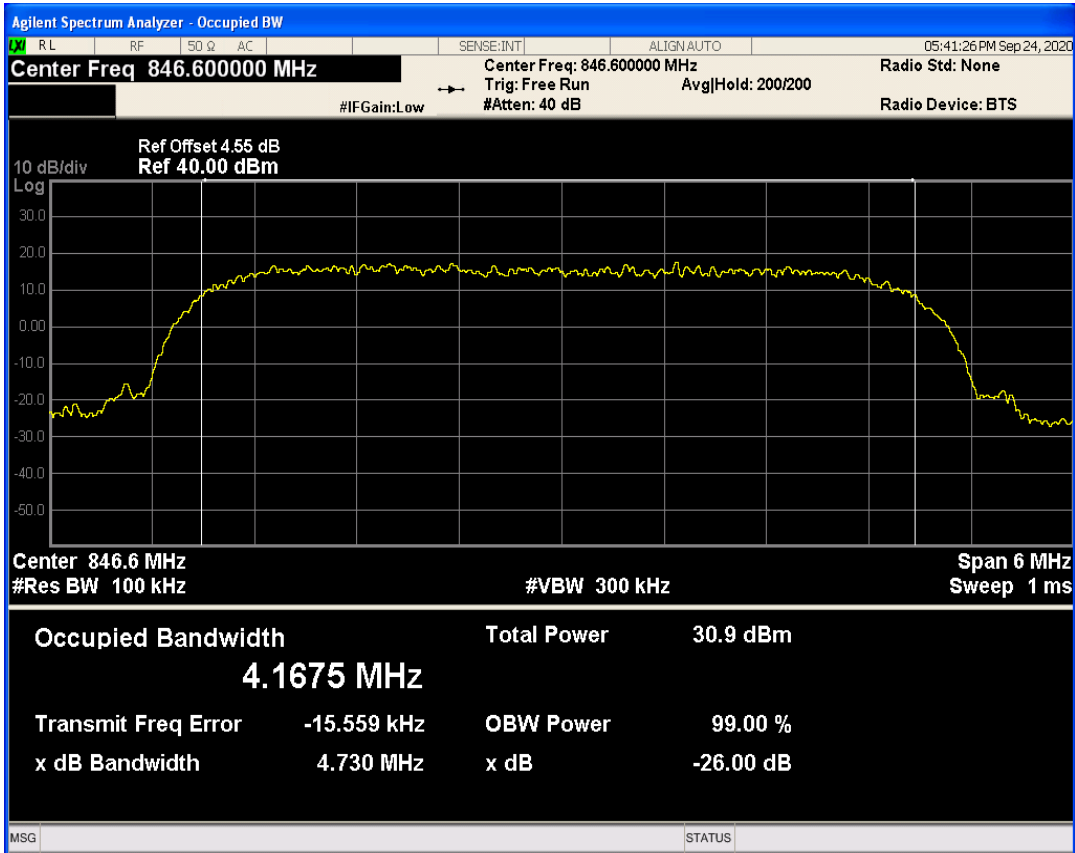

WCDMA Band5 Channel=4182

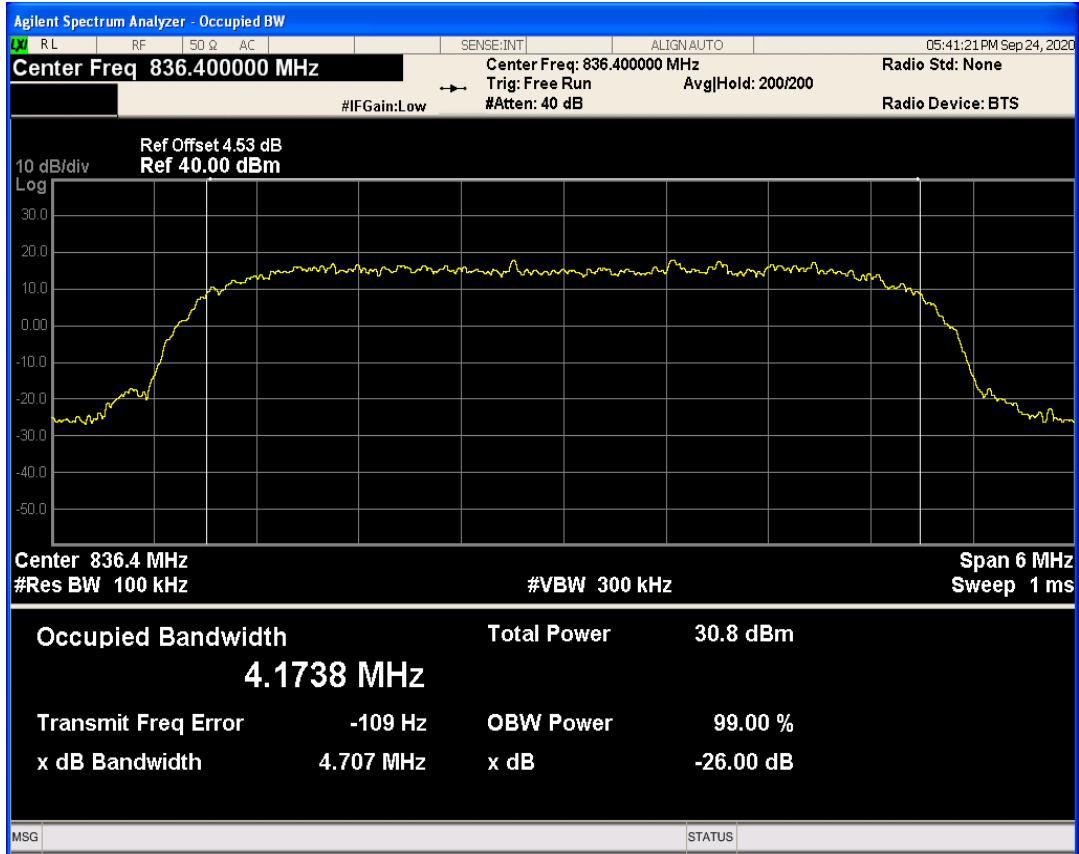

8.4 BAND EDGE

Band	Chan nel	Frequency (MHz)	Spur Freq (MHz)	Spur Level (dBm)	Limit (dBm)	Verdict
GSM850	128	824.2	823.98	-24.08	-13	PASS
GSM850	251	848.8	849.02	-23.86	-13	PASS
GSM1900	512	1850.2	1849.98	-27.12	-13	PASS
GSM1900	810	1909.8	1910.02	-26.99	-13	PASS
GPRS850	128	824.2	824.00	-23.81	-13	PASS
GPRS850	251	848.8	849.02	-24.56	-13	PASS
GPRS1900	512	1850.2	1849.99	-28.37	-13	PASS
GPRS1900	810	1909.8	1910.01	-29.58	-13	PASS
EGPRS850	128	824.2	824.00	-29.81	-13	PASS
EGPRS850	251	848.8	849.01	-30.34	-13	PASS
EGPRS1900	512	1850.2	1849.97	-34.22	-13	PASS
EGPRS1900	810	1909.8	1910.00	-35.38	-13	PASS
WCDMA Band2	9262	1852.4	1849.88	-25.96	-13	PASS
WCDMA Band2	9538	1907.6	1910.12	-27.15	-13	PASS
WCDMA Band4	1312	1712.4	1709.88	-21.17	-13	PASS
WCDMA Band4	1513	1752.6	1755.01	-23.45	-13	PASS
WCDMA Band5	4132	826.4	824.00	-22.03	-13	PASS
WCDMA Band5	4233	846.6	849.00	-22.56	-13	PASS

GSM850 Channel=128

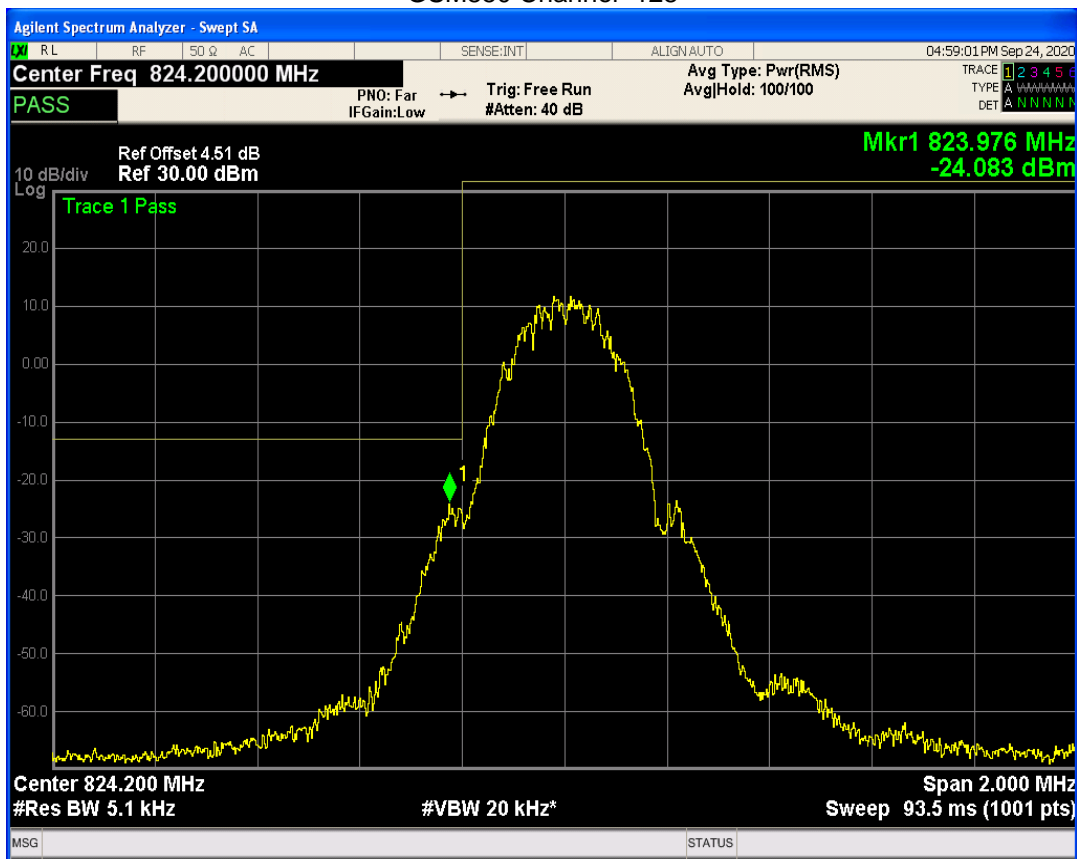

GSM850 Channel=251

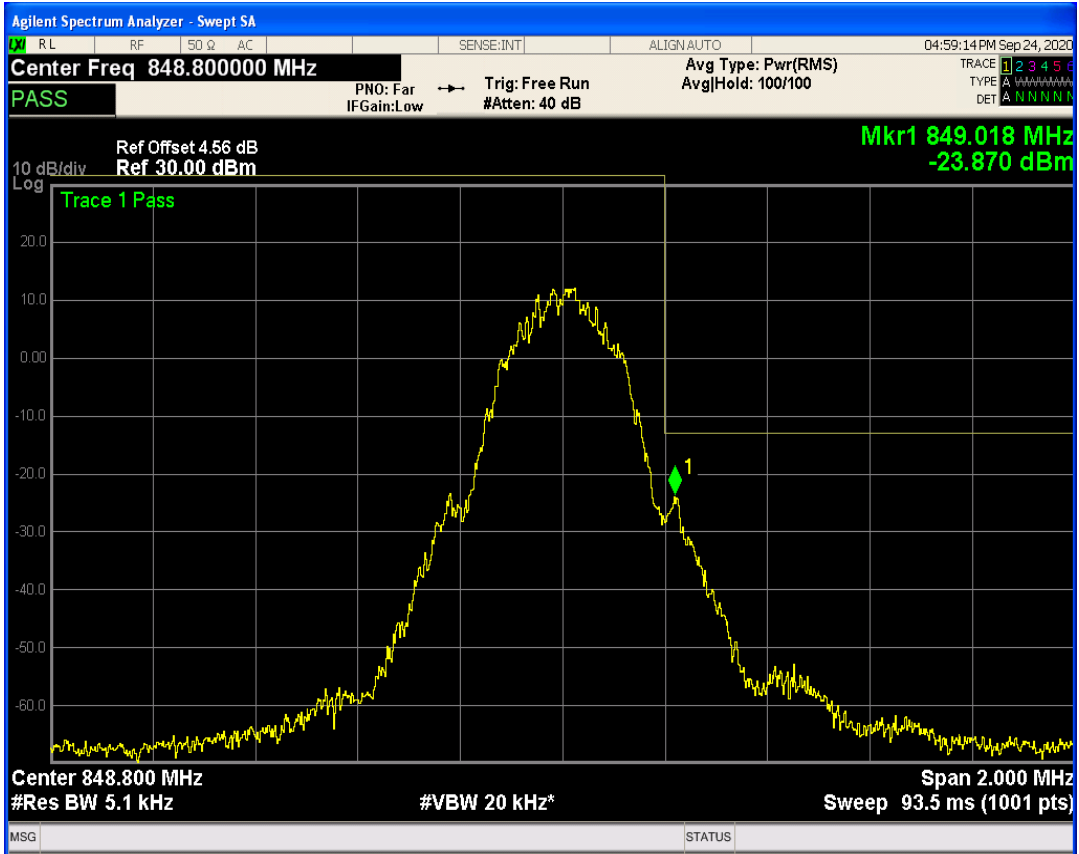

GSM1900 Channel=512

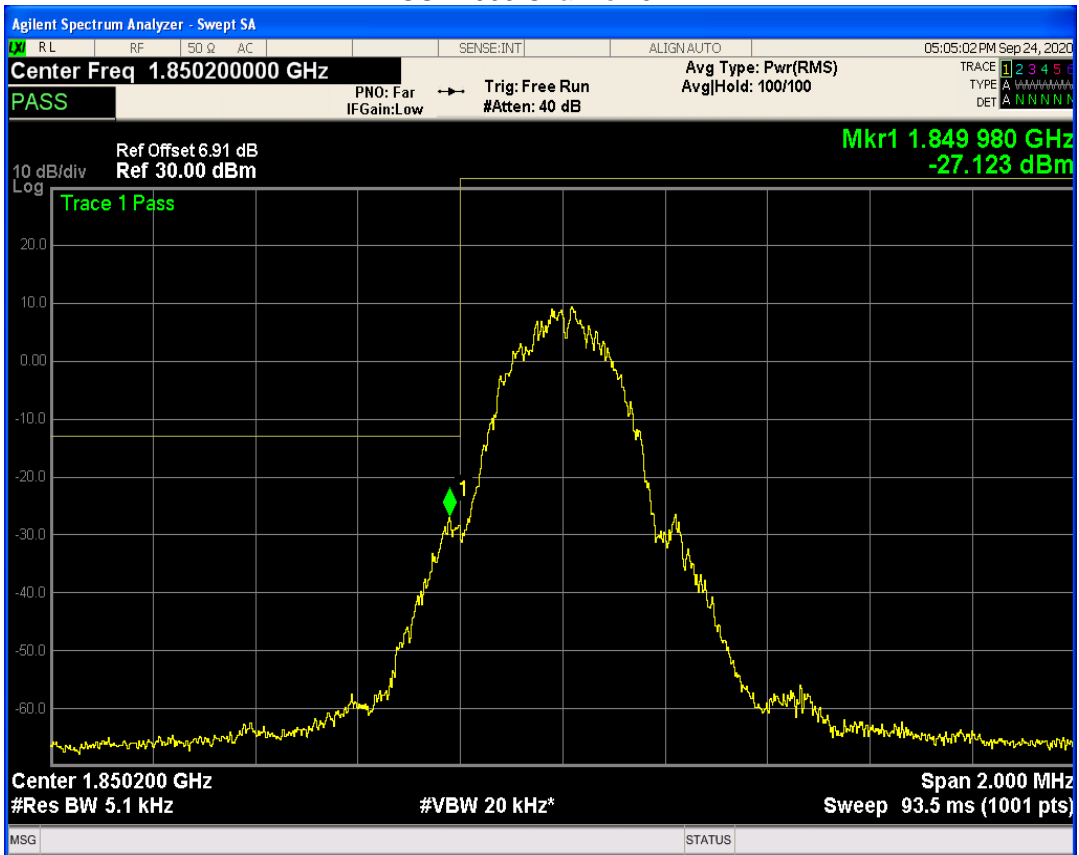

GSM1900 Channel=810

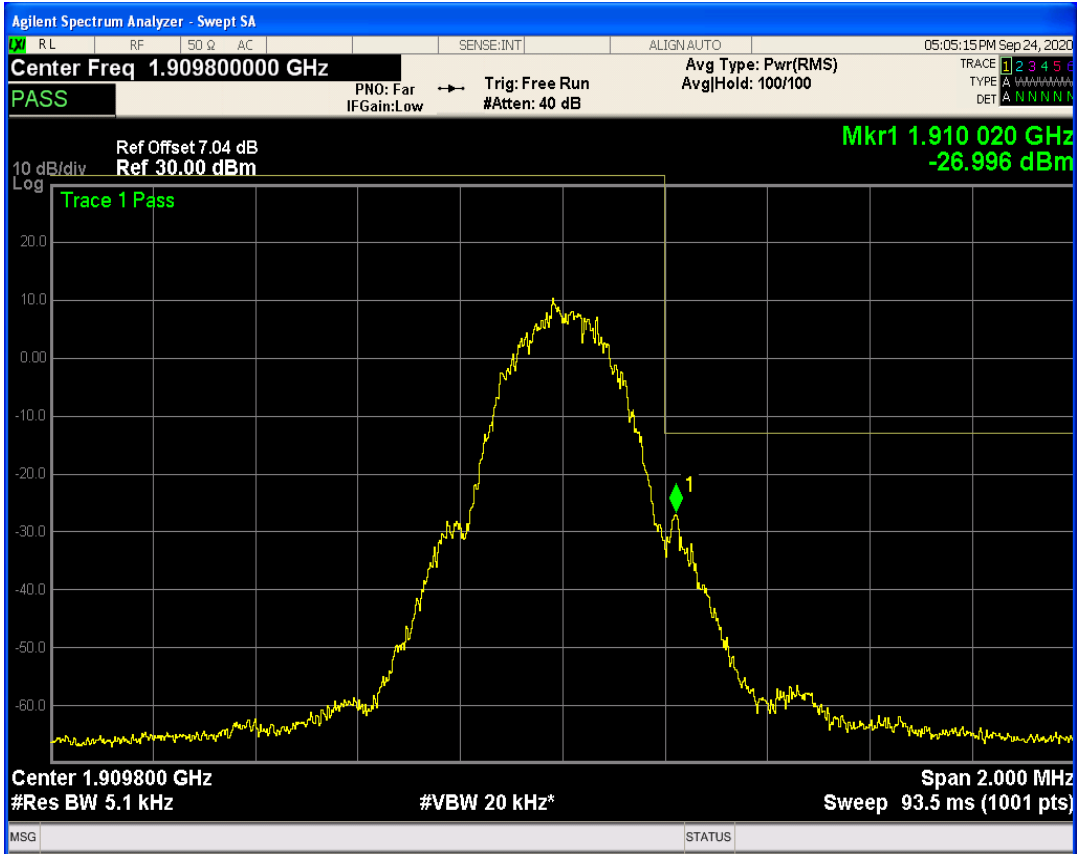

GPRS850 Channel=128

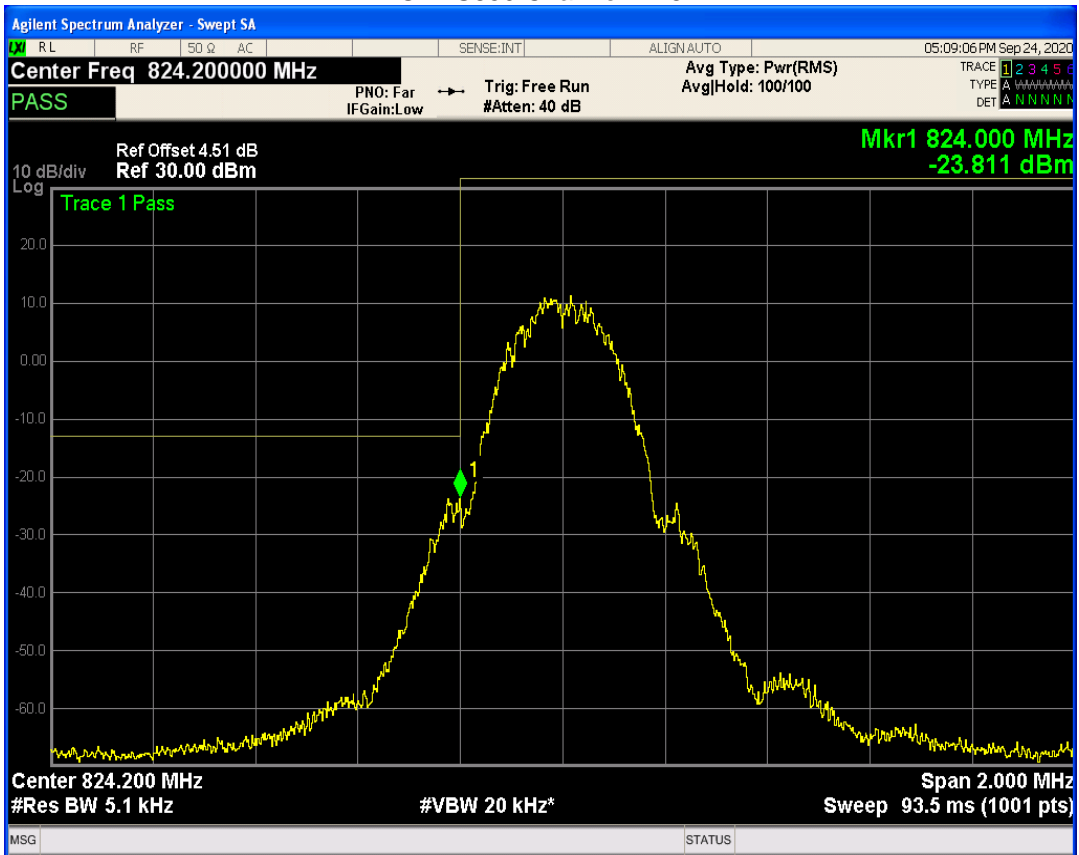

GPRS850 Channel=251

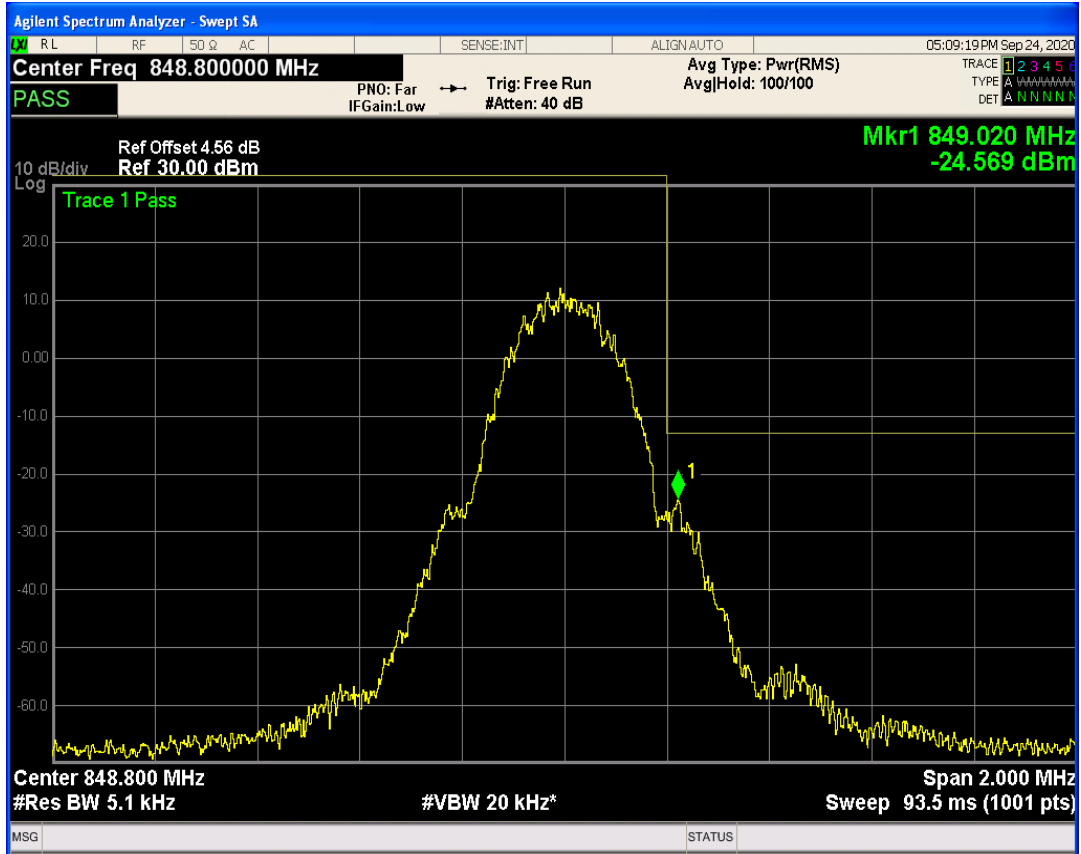

GPRS1900 Channel=512

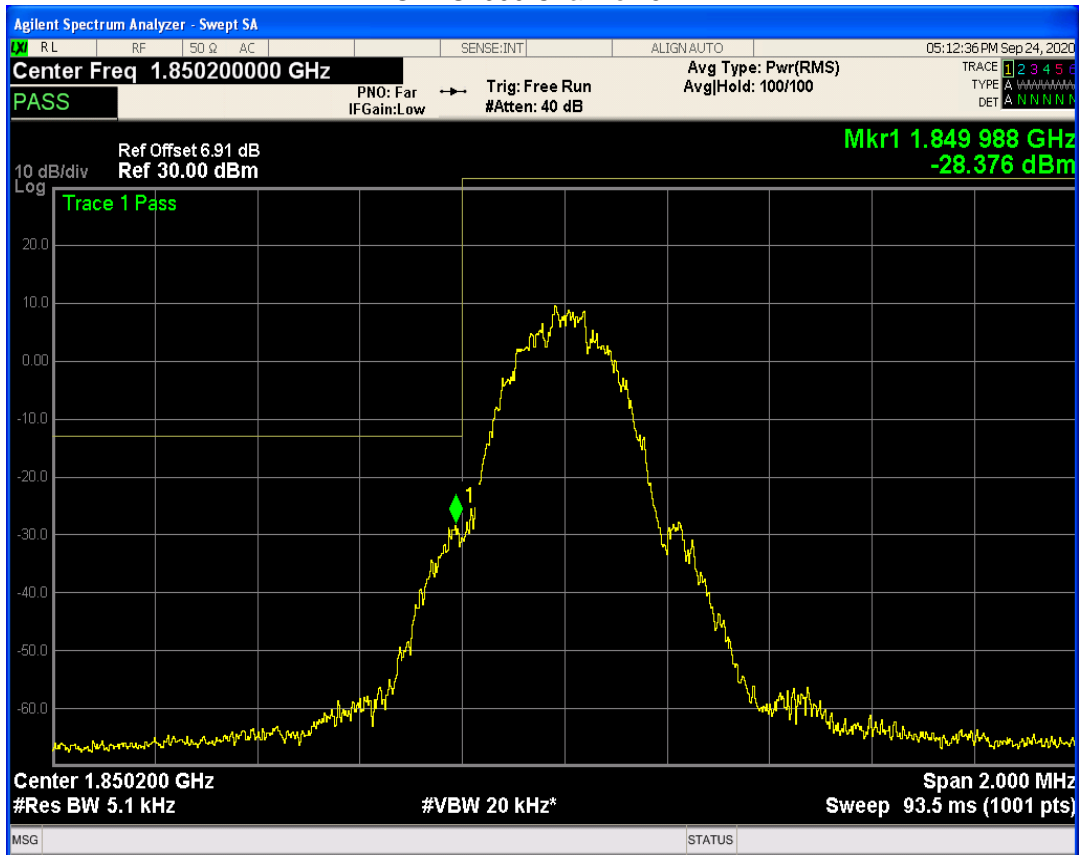

GPRS1900 Channel=810

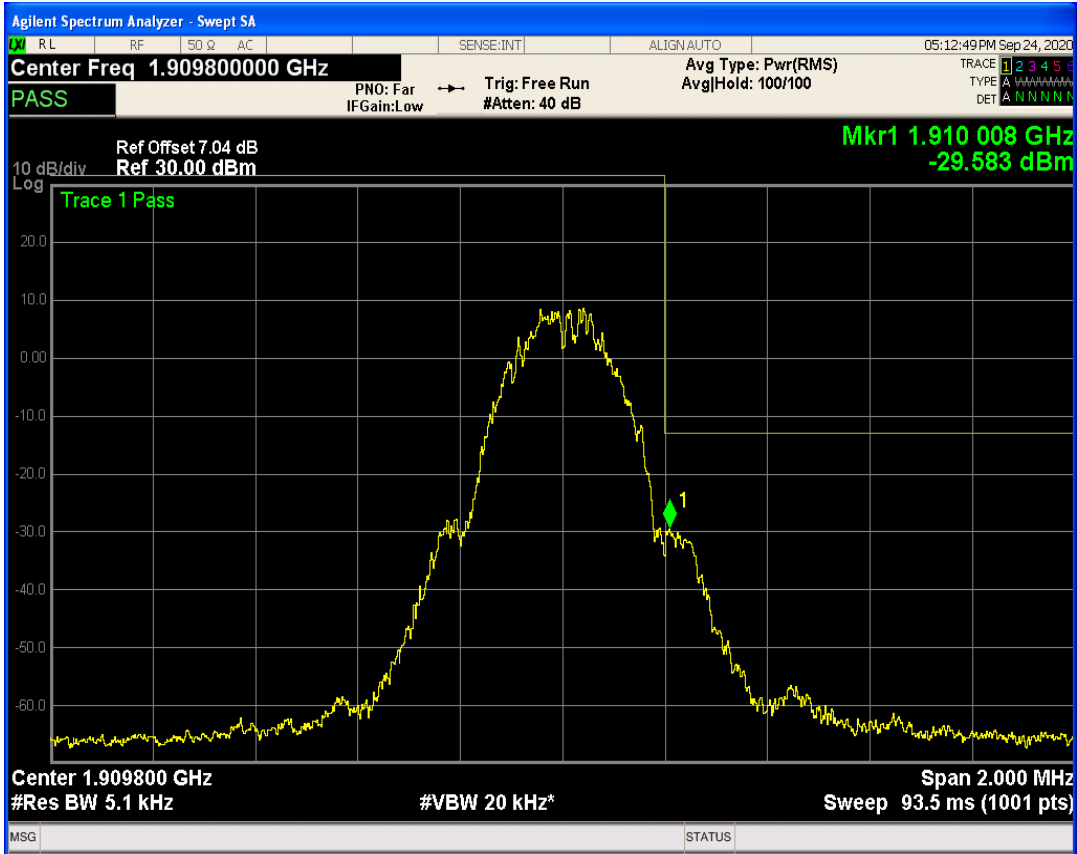

EGPRS850 Channel=251

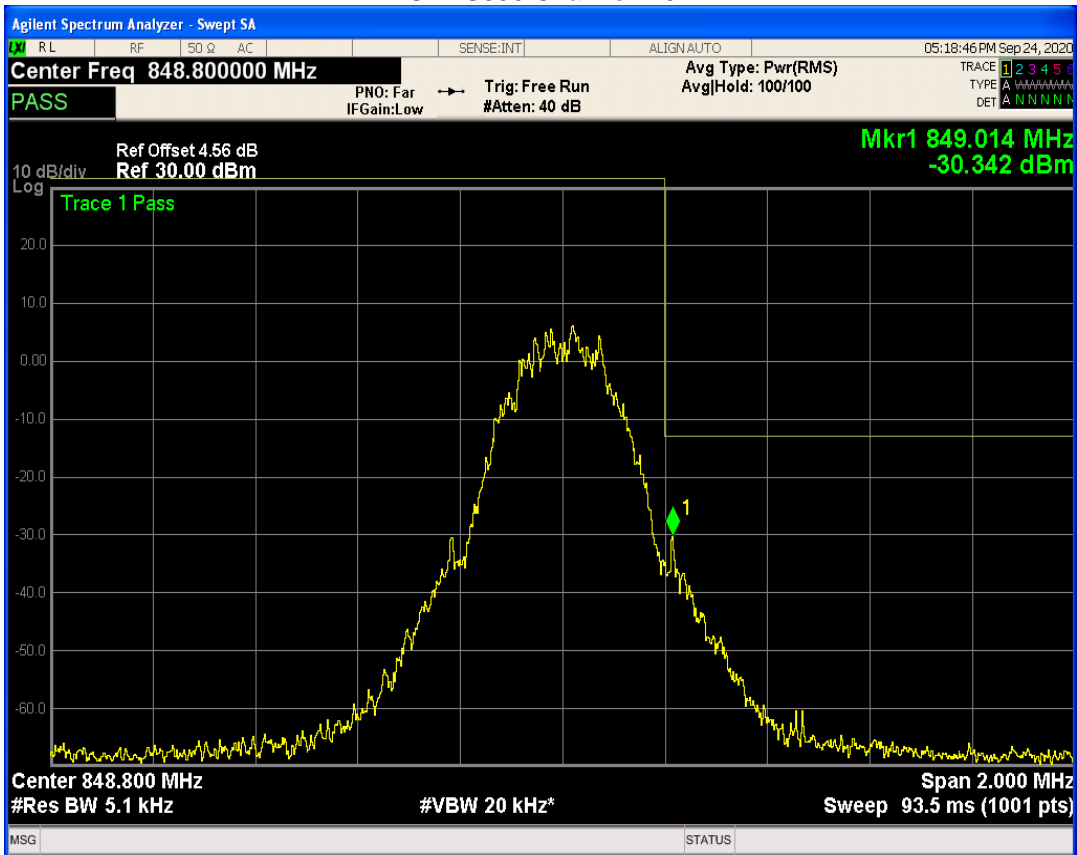

EGPRS850 Channel=128

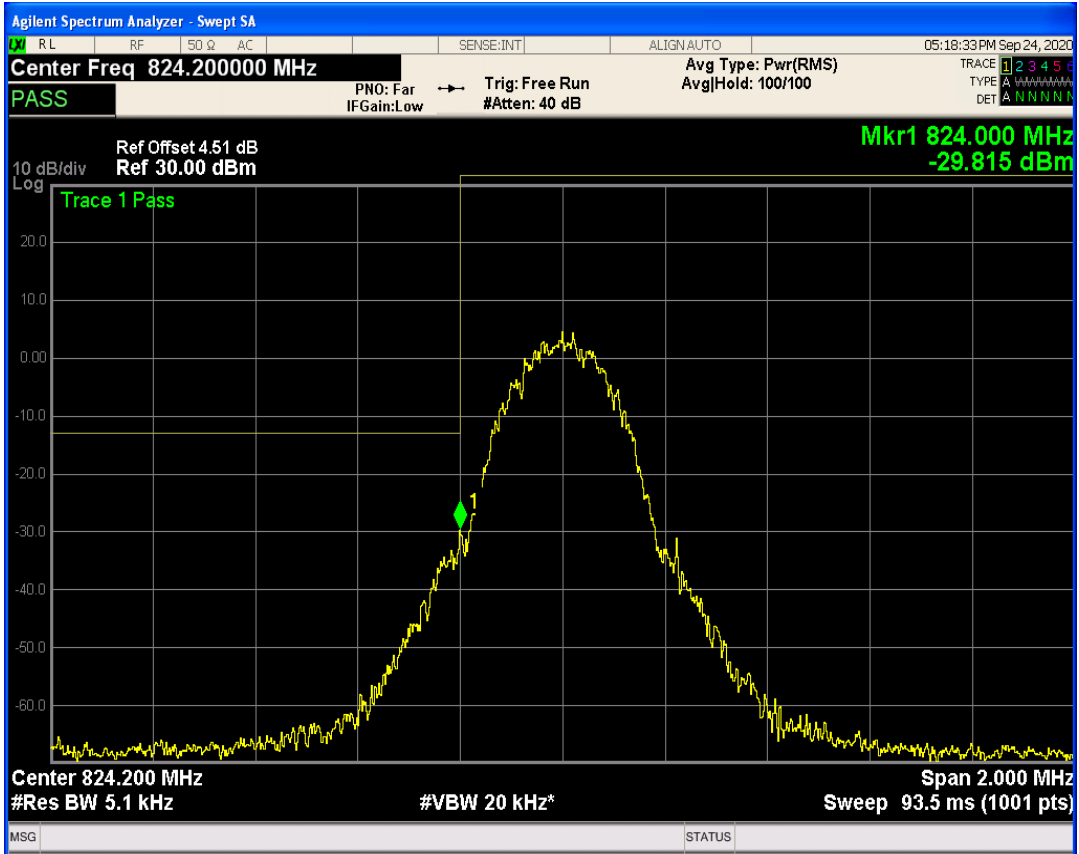

EGPRS1900 Channel=512

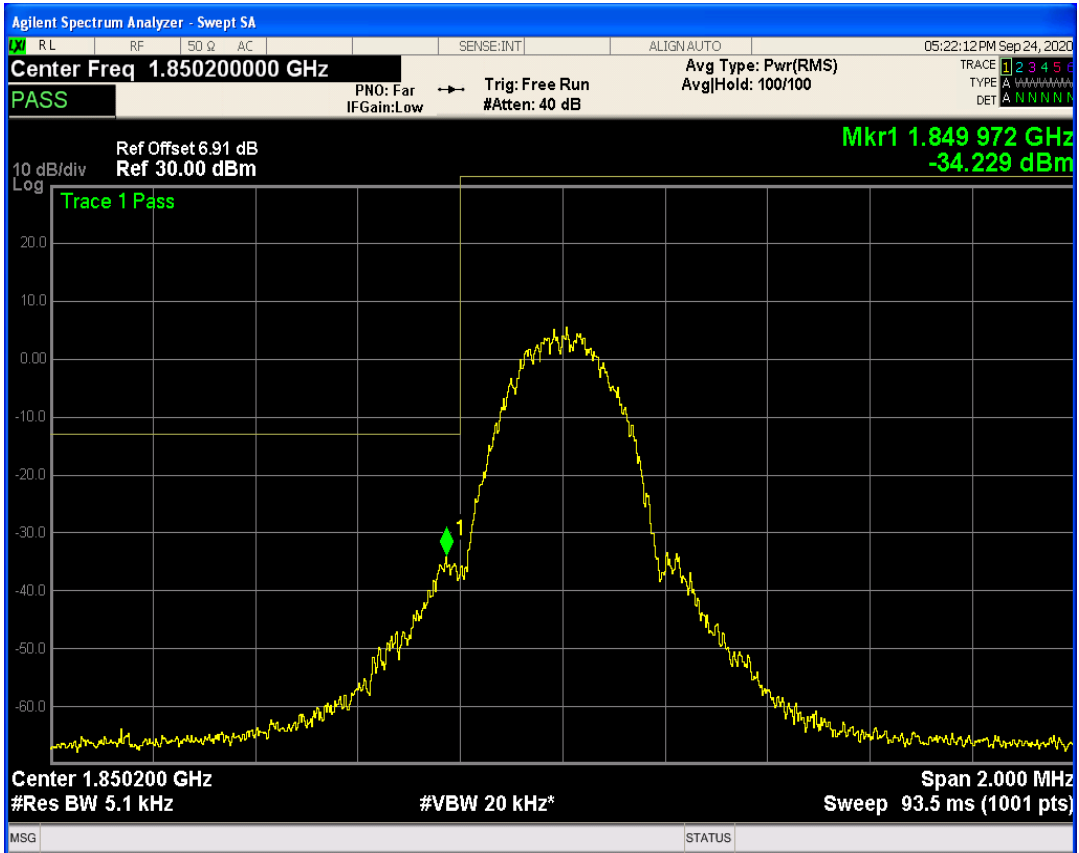

EGPRS1900 Channel=810

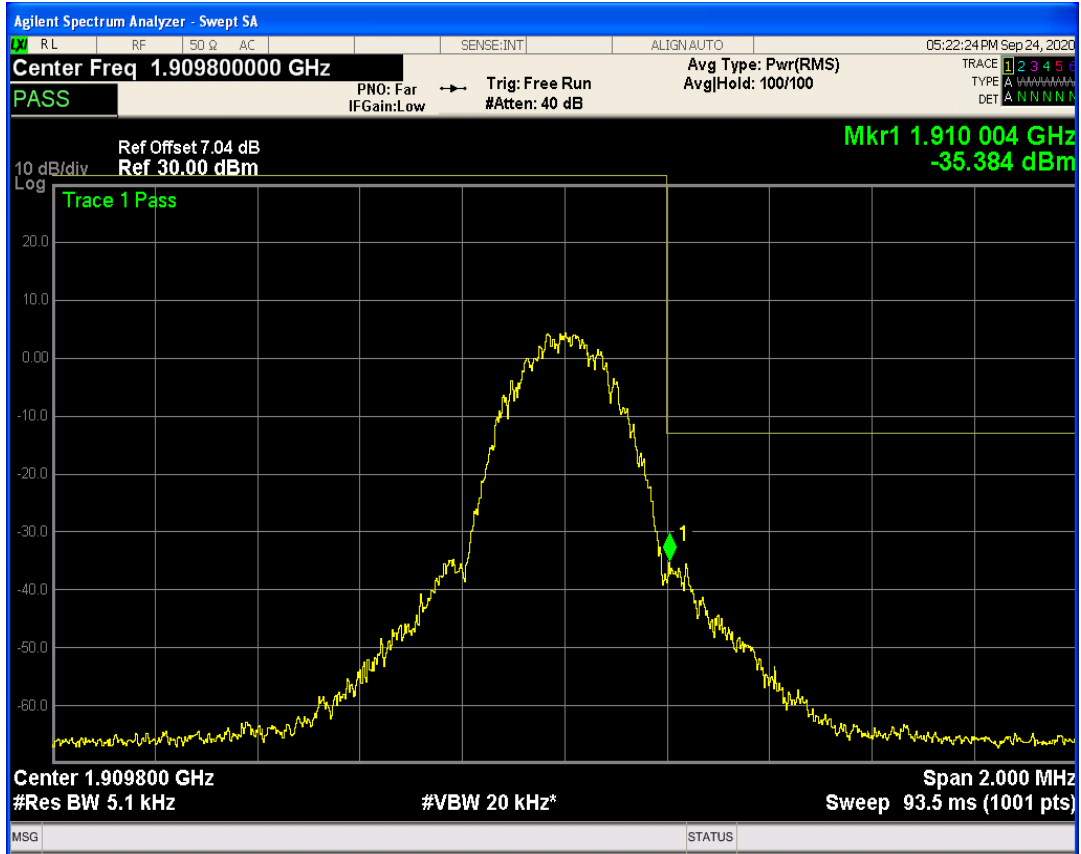

WCDMA Band2 Channel=9262

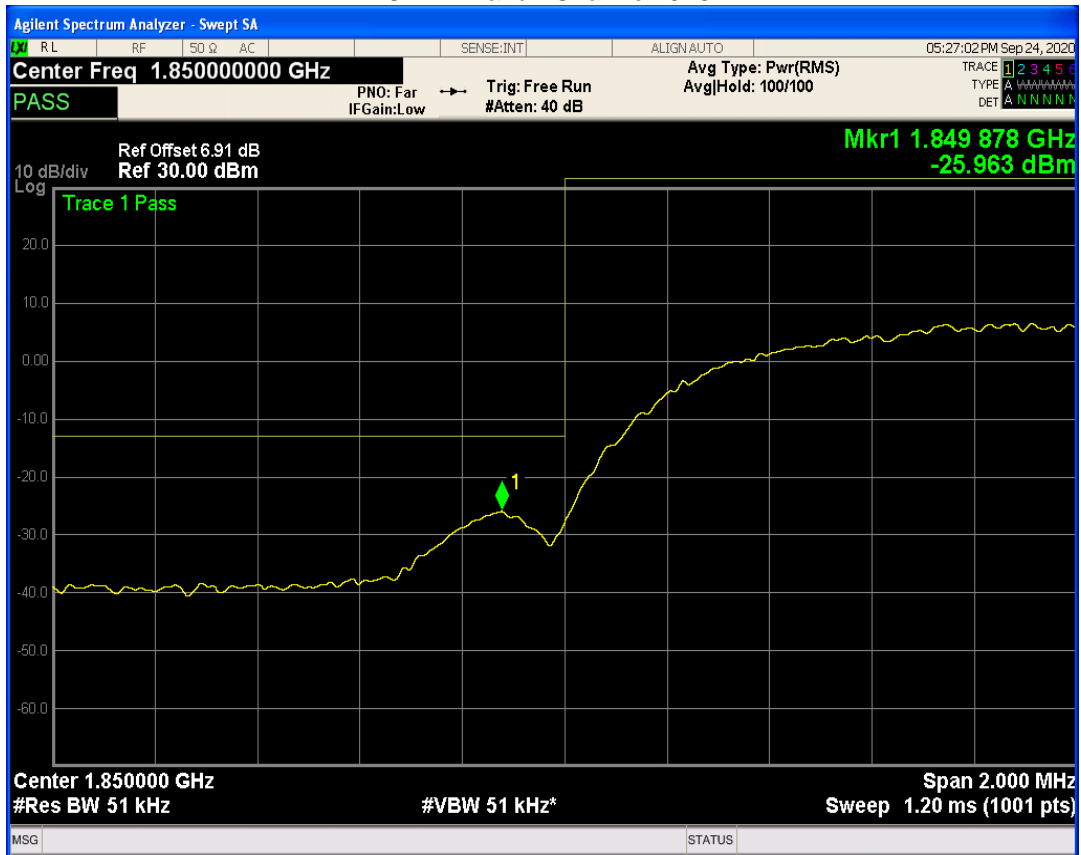

WCDMA Band2 Channel=9538



WCDMA Band4 Channel=1312

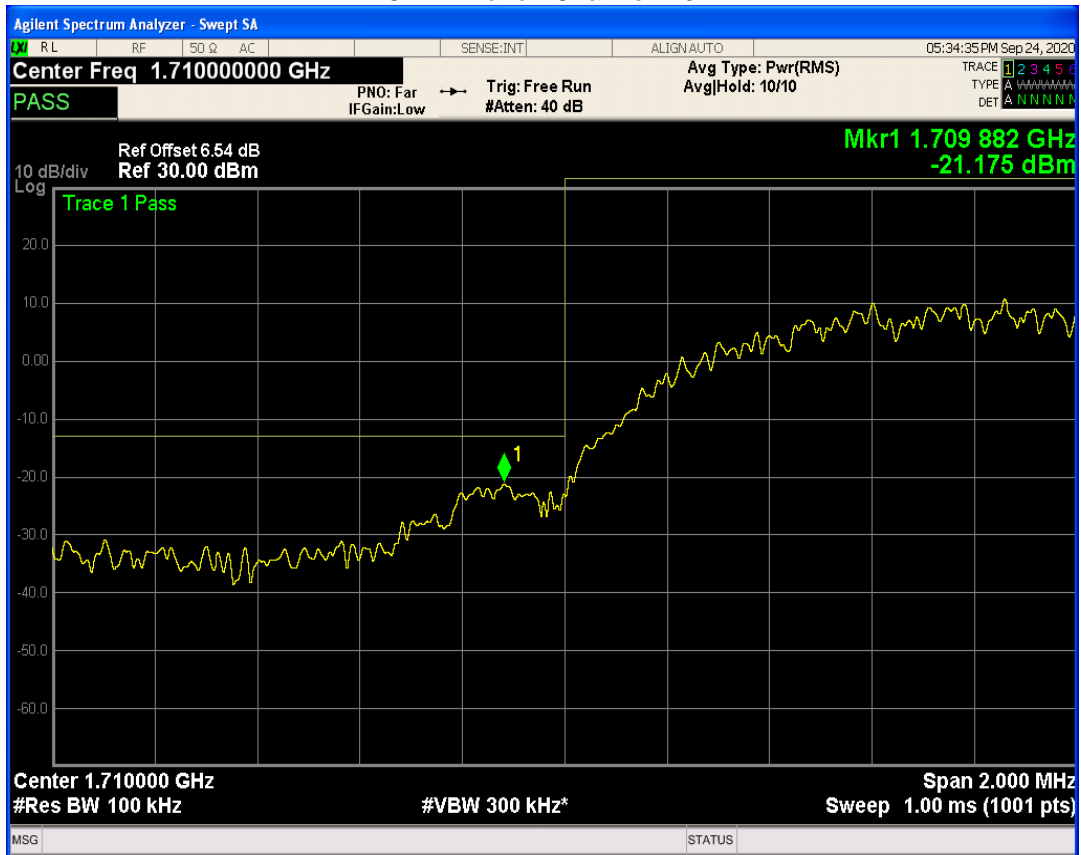

WCDMA Band4 Channel=1513

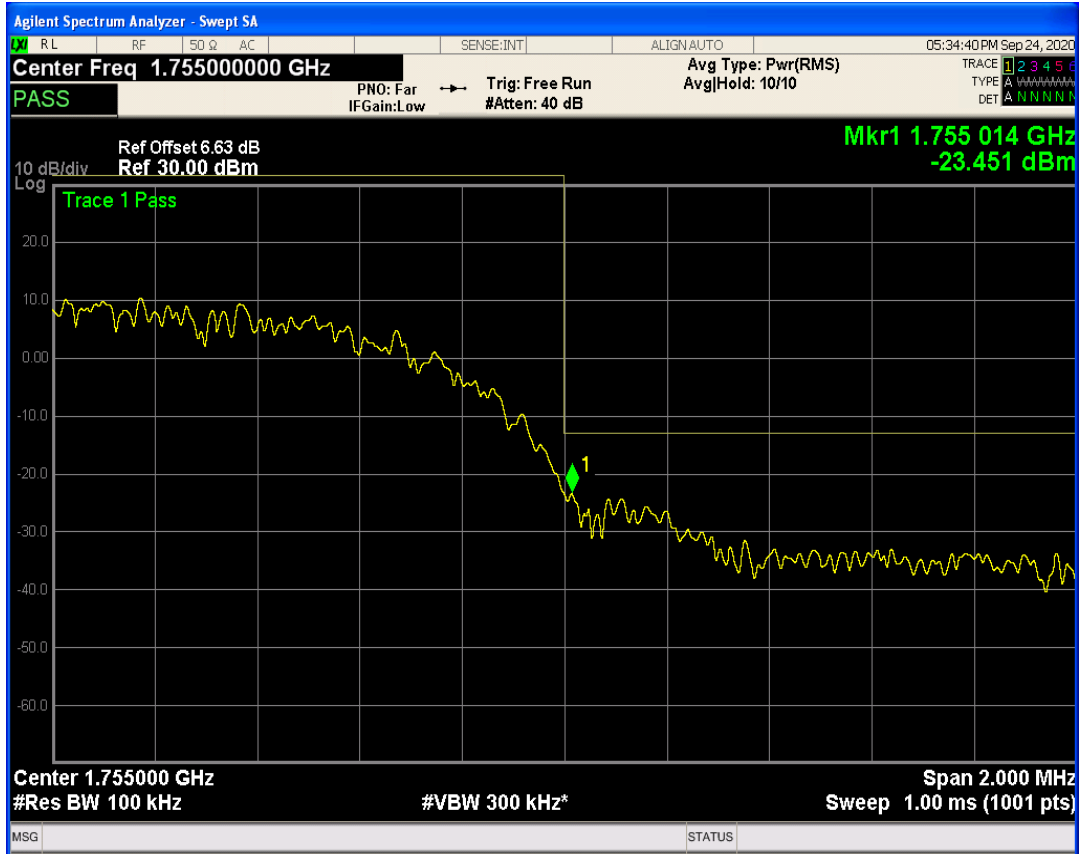

WCDMA Band5 Channel=4132

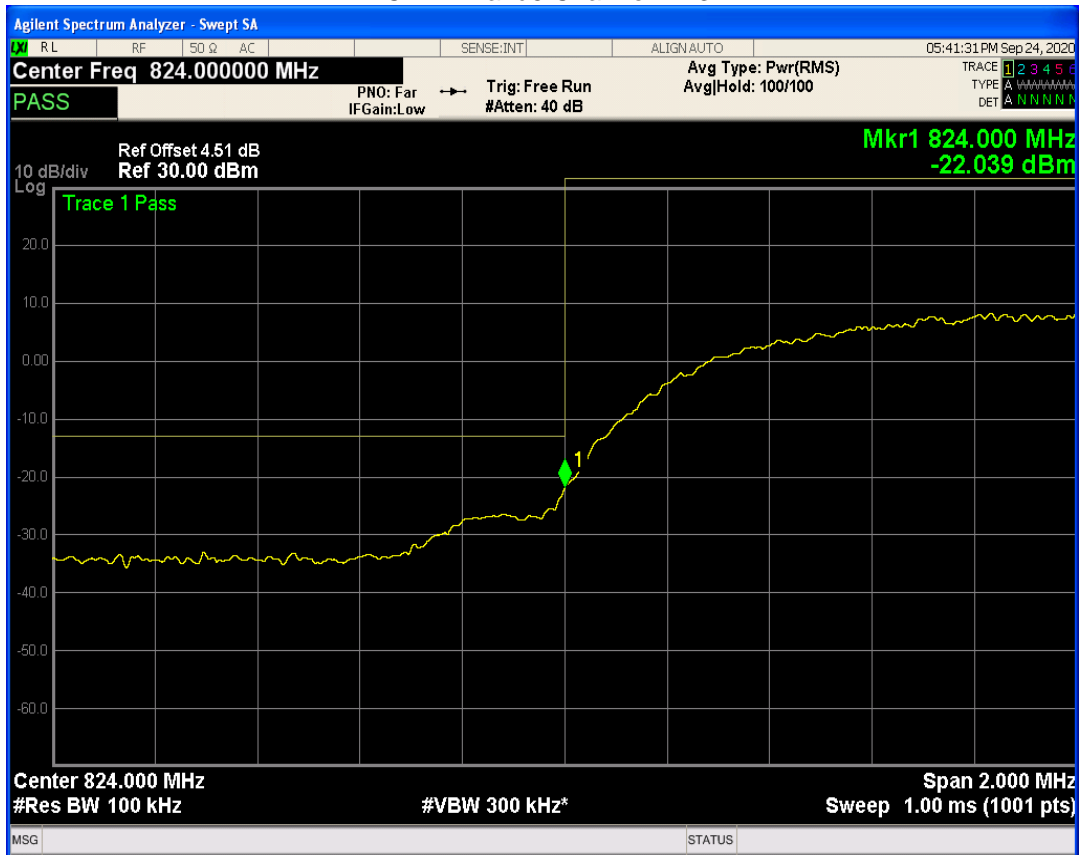

WCDMA Band5 Channel=4233

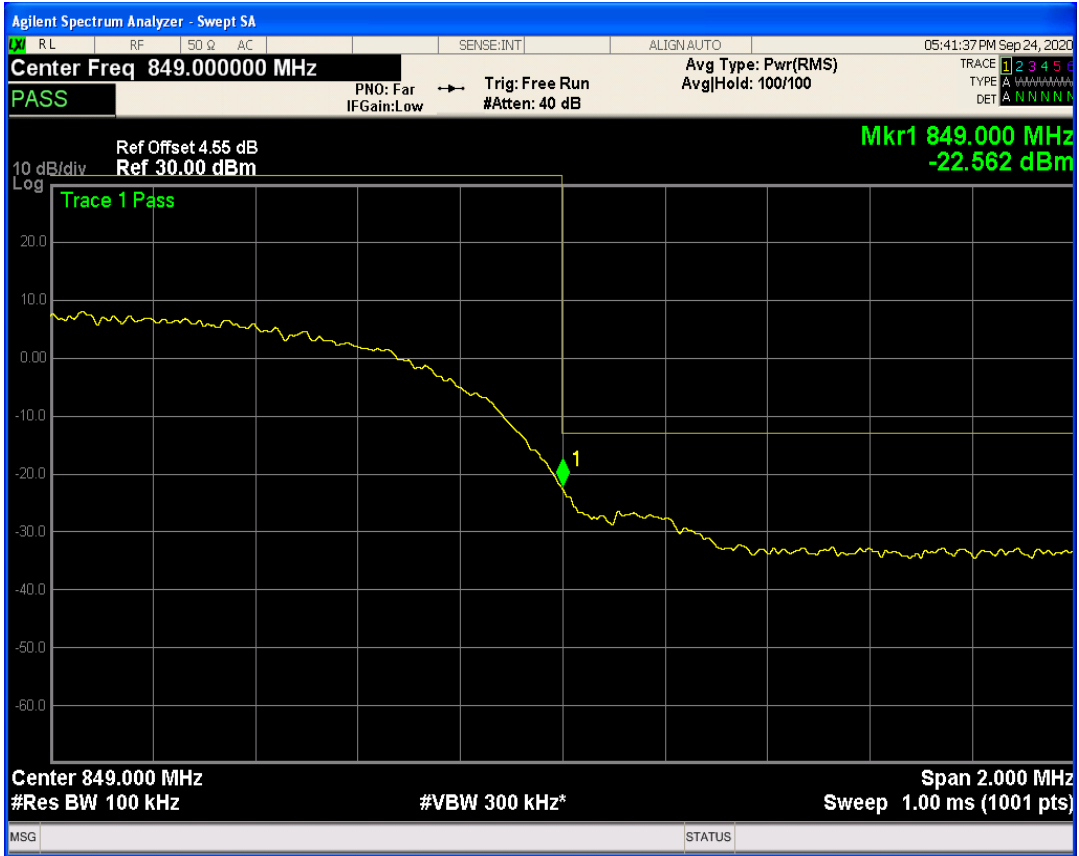

8.5 OUT-OF-BAND EMISSIONS

Band	Chan nel	Frequency (MHz)	Spur Freq (MHz)	Spur Level (dBm)	Limit (dBm)	Verdict
GSM850	128	824.2	1648.38	-30.11	-13	PASS
GSM850	189	836.4	1672.56	-29.53	-13	PASS
GSM850	251	848.8	857.76	-27.44	-13	PASS
GSM1900	512	1850.2	19963.55	-24.85	-13	PASS
GSM1900	661	1880	19841.24	-24.60	-13	PASS
GSM1900	810	1909.8	17738.40	-24.61	-13	PASS
GPRS850	128	824.2	1648.63	-29.27	-13	PASS
GPRS850	189	836.4	1672.81	-30.32	-13	PASS
GPRS850	251	848.8	3152.60	-30.60	-13	PASS
GPRS1900	512	1850.2	19690.96	-24.41	-13	PASS
GPRS1900	661	1880	17076.89	-24.66	-13	PASS
GPRS1900	810	1909.8	18419.37	-24.54	-13	PASS
EGPRS850	128	824.2	7633.12	-31.33	-13	PASS
EGPRS850	189	836.4	3175.29	-31.79	-13	PASS
EGPRS850	251	848.8	3167.06	-31.62	-13	PASS
EGPRS1900	512	1850.2	19927.11	-25.20	-13	PASS
EGPRS1900	661	1880	19923.61	-23.95	-13	PASS
EGPRS1900	810	1909.8	19878.18	-24.91	-13	PASS
WCDMA Band2	9262	1852.4	19955.57	-24.72	-13	PASS
WCDMA Band2	9400	1880	18436.85	-24.68	-13	PASS
WCDMA Band2	9538	1907.6	19957.06	-24.46	-13	PASS
WCDMA Band4	1312	1712.4	19901.15	-25.44	-13	PASS
WCDMA Band4	1412	1732.4	19877.68	-24.88	-13	PASS
WCDMA Band4	1513	1752.6	17063.41	-25.42	-13	PASS
WCDMA Band5	4132	826.4	3178.53	-31.57	-13	PASS
WCDMA Band5	4182	836.4	3158.59	-31.41	-13	PASS
WCDMA Band5	4233	846.6	5788.17	-31.00	-13	PASS

GSM850 Channel=128

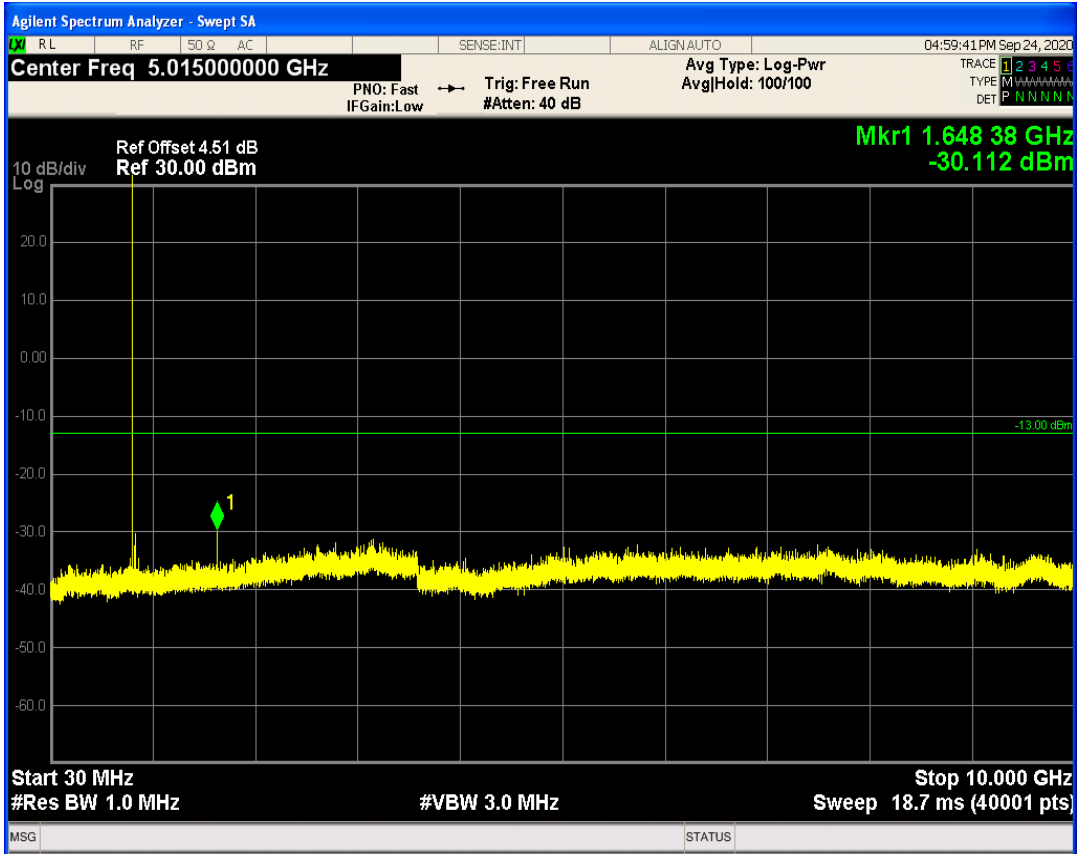

GSM850 Channel=189

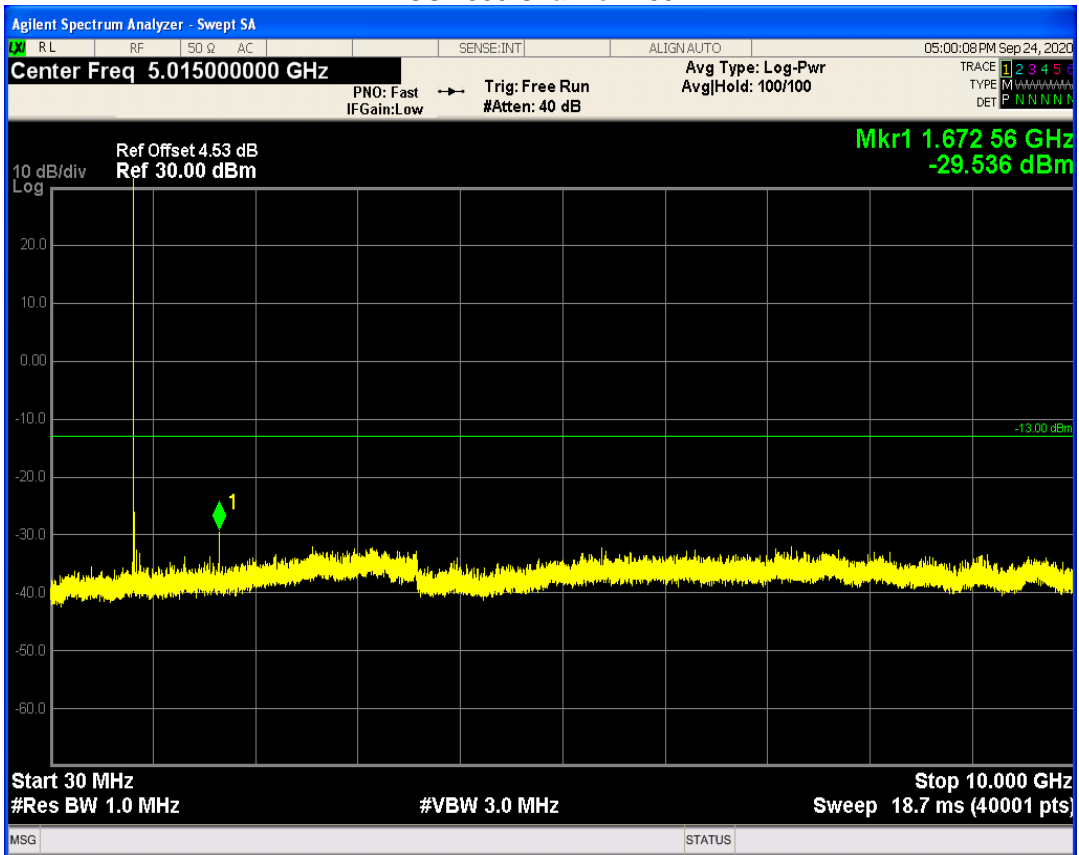

GSM850 Channel=251

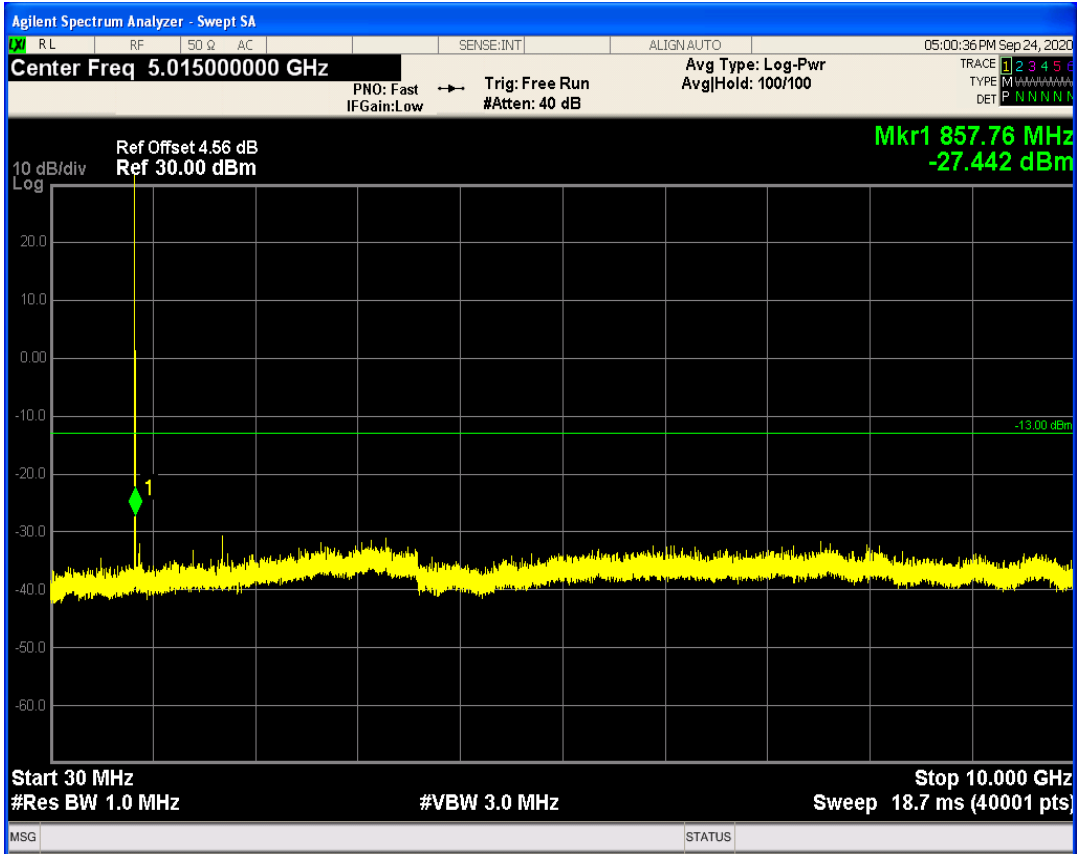

GSM1900 Channel=512

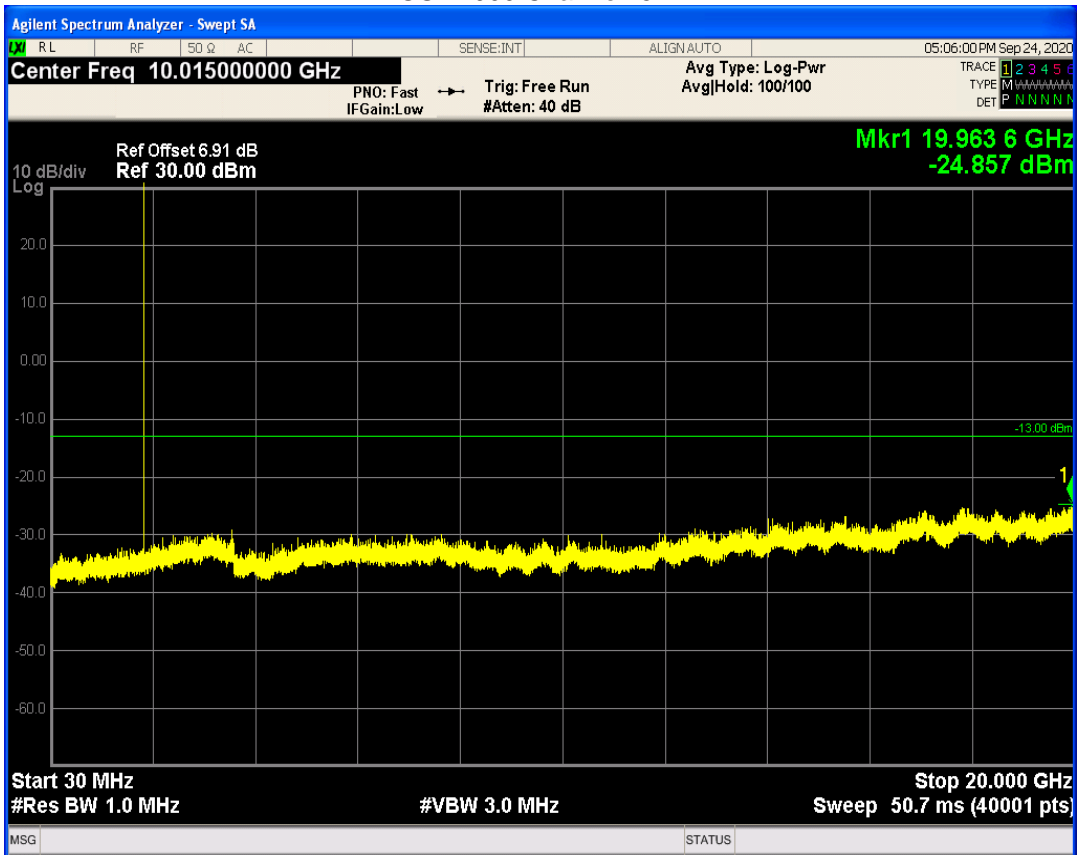

GSM1900 Channel=810

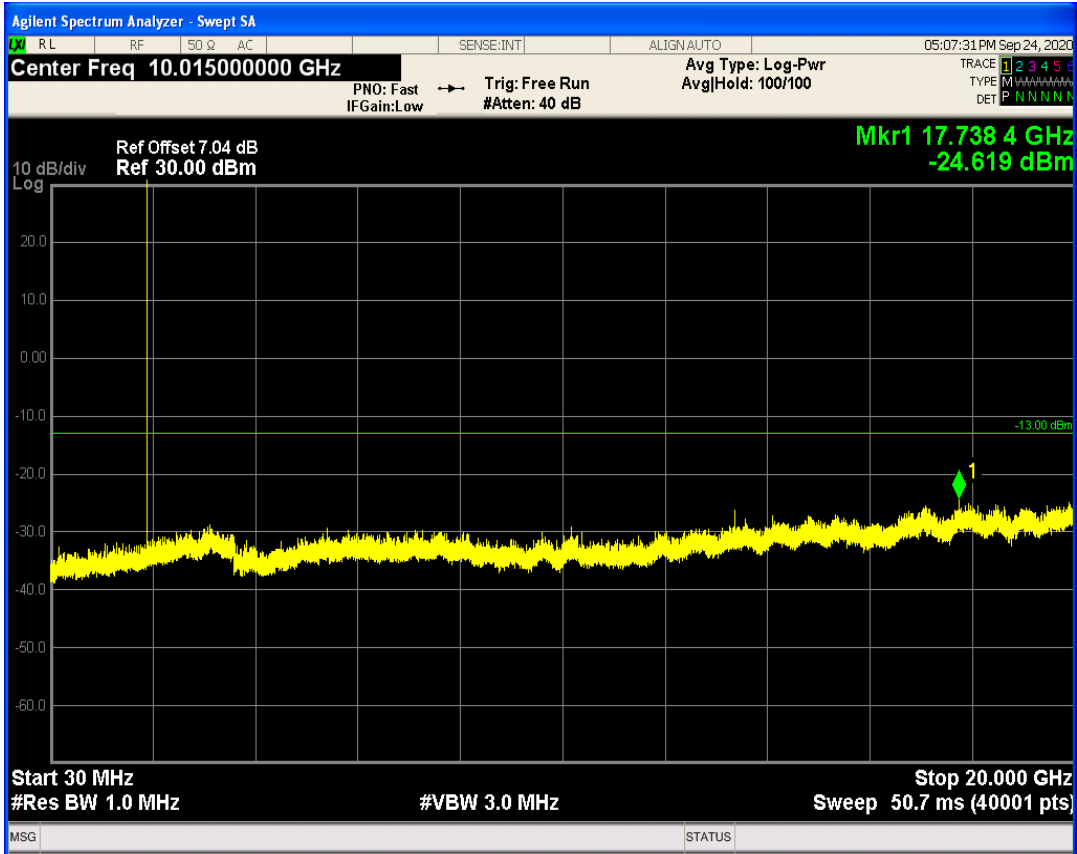

GSM1900 Channel=661

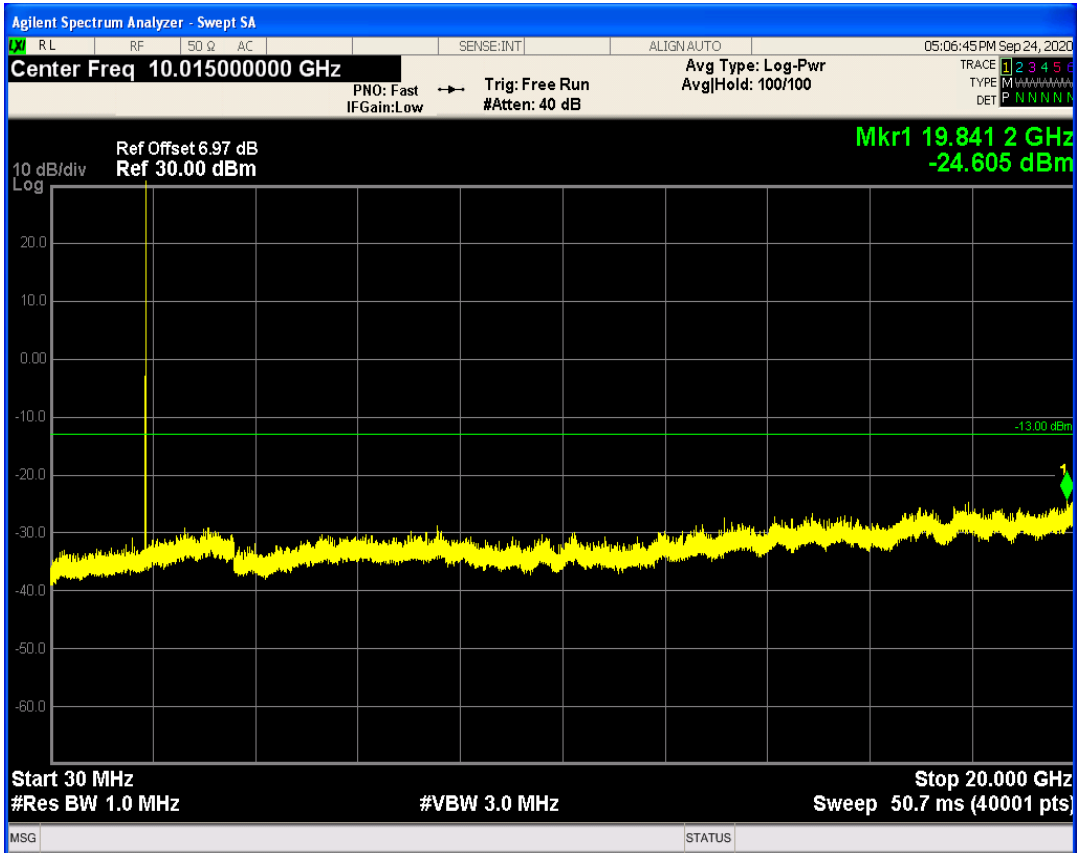

GPRS850 Channel=189

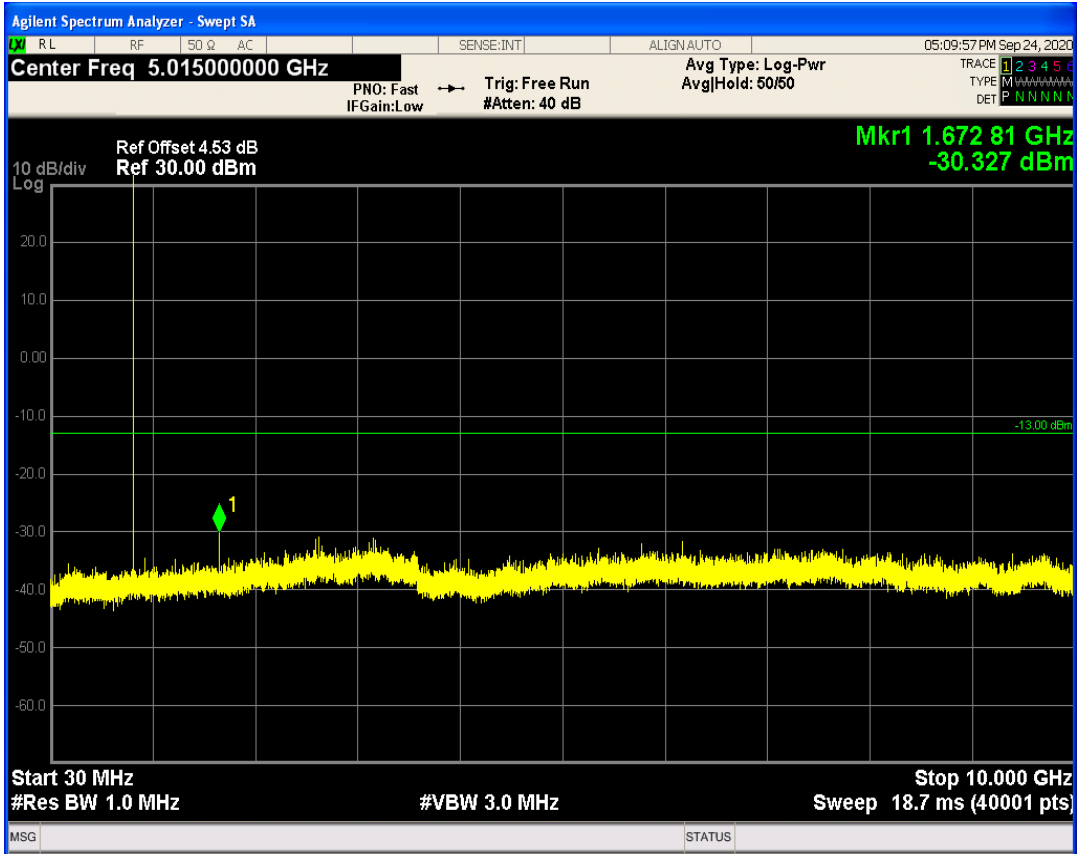

GPRS850 Channel=128

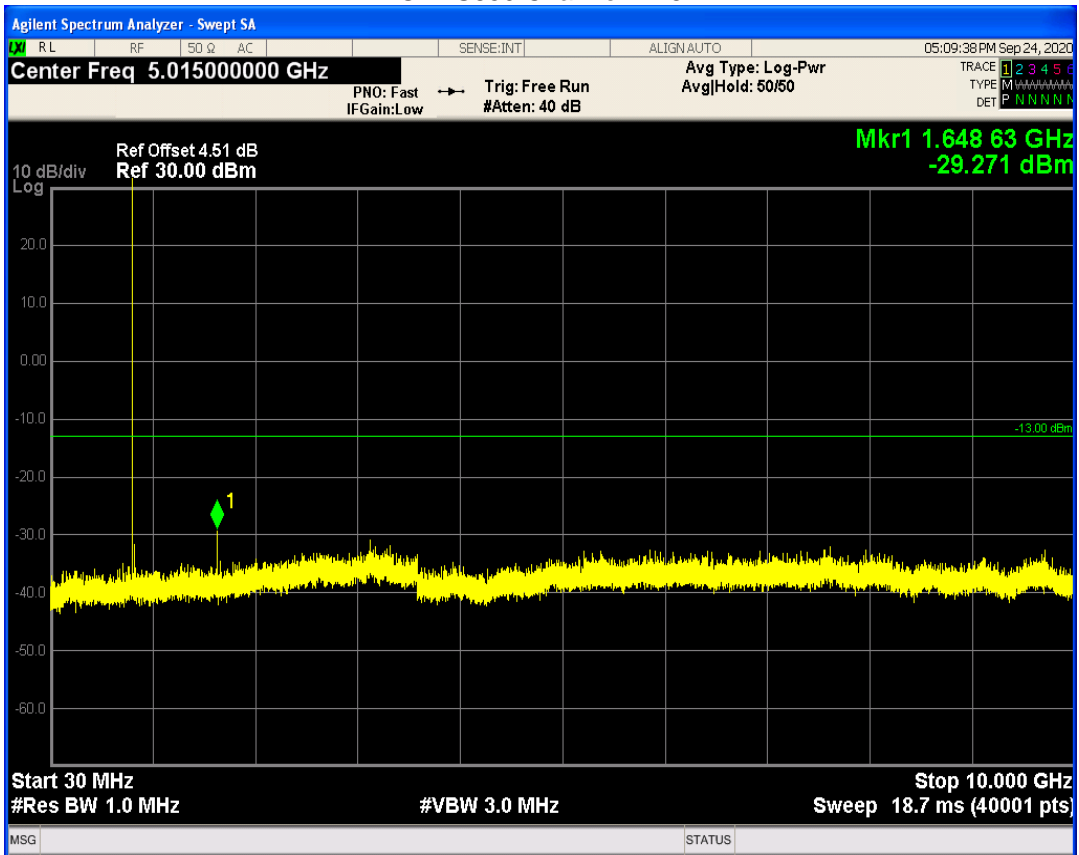

GPRS850 Channel=251

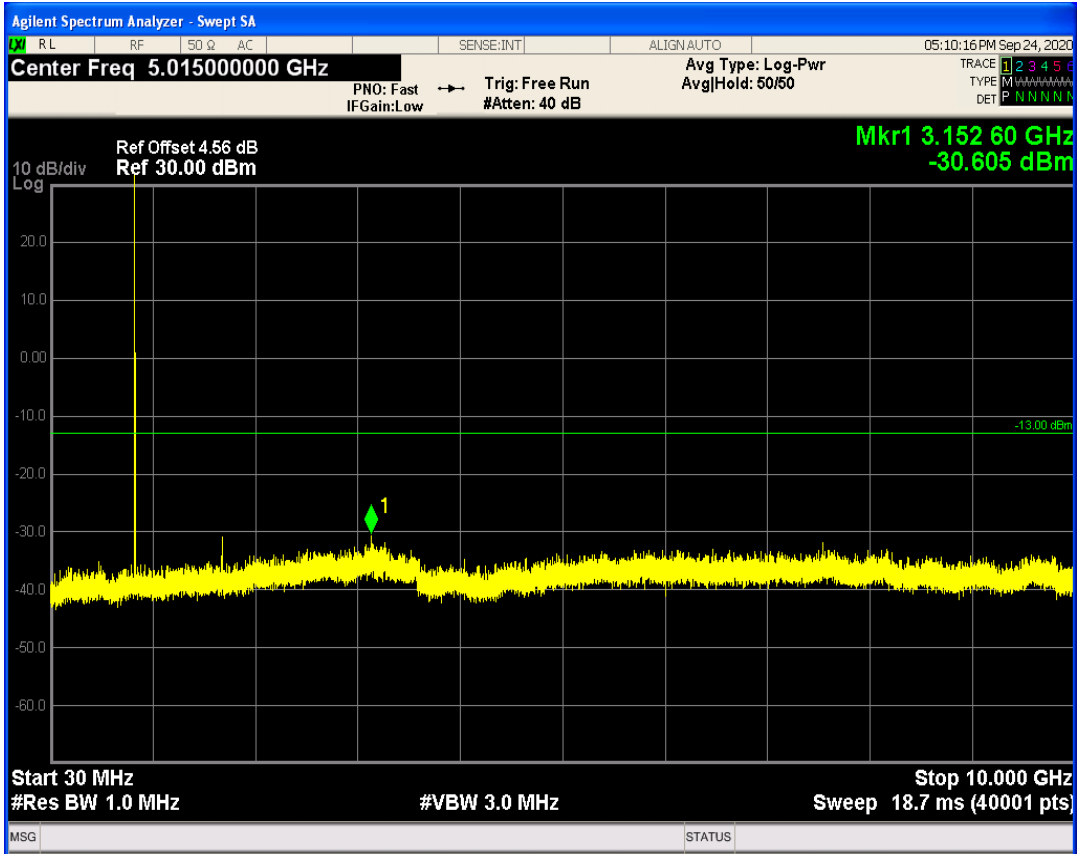

GPRS1900 Channel=512

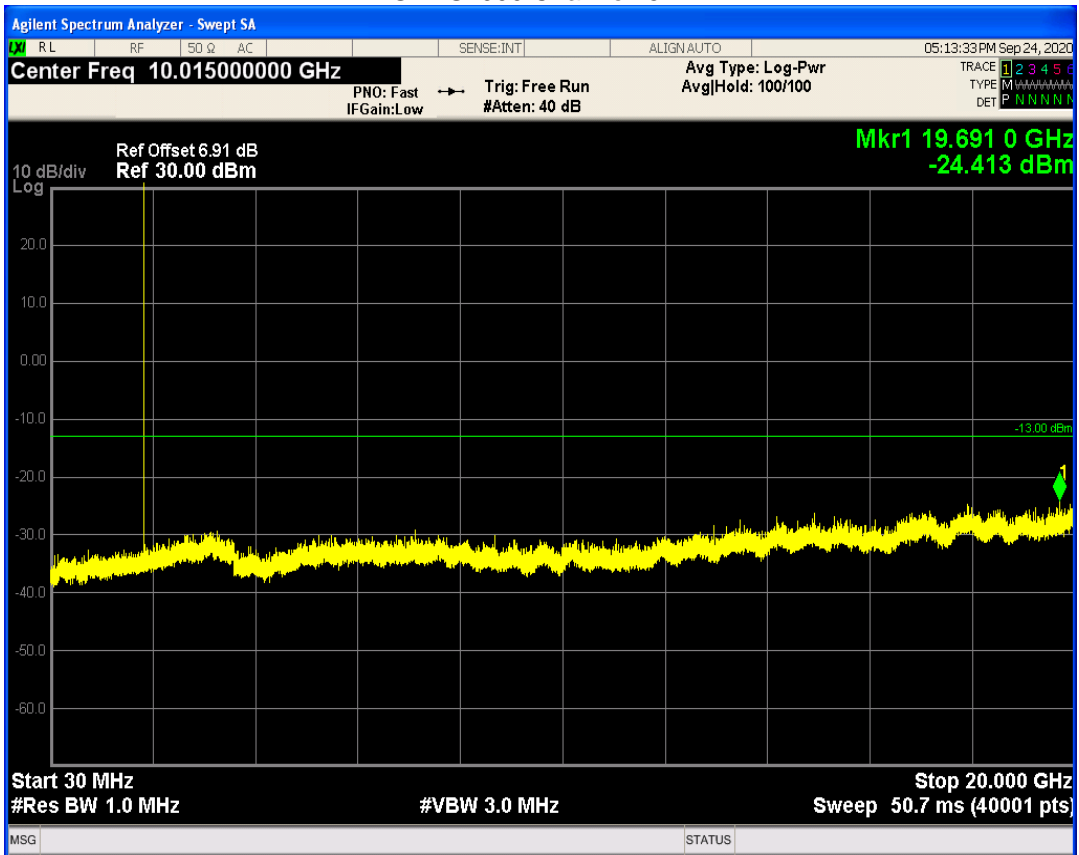

GPRS1900 Channel=661

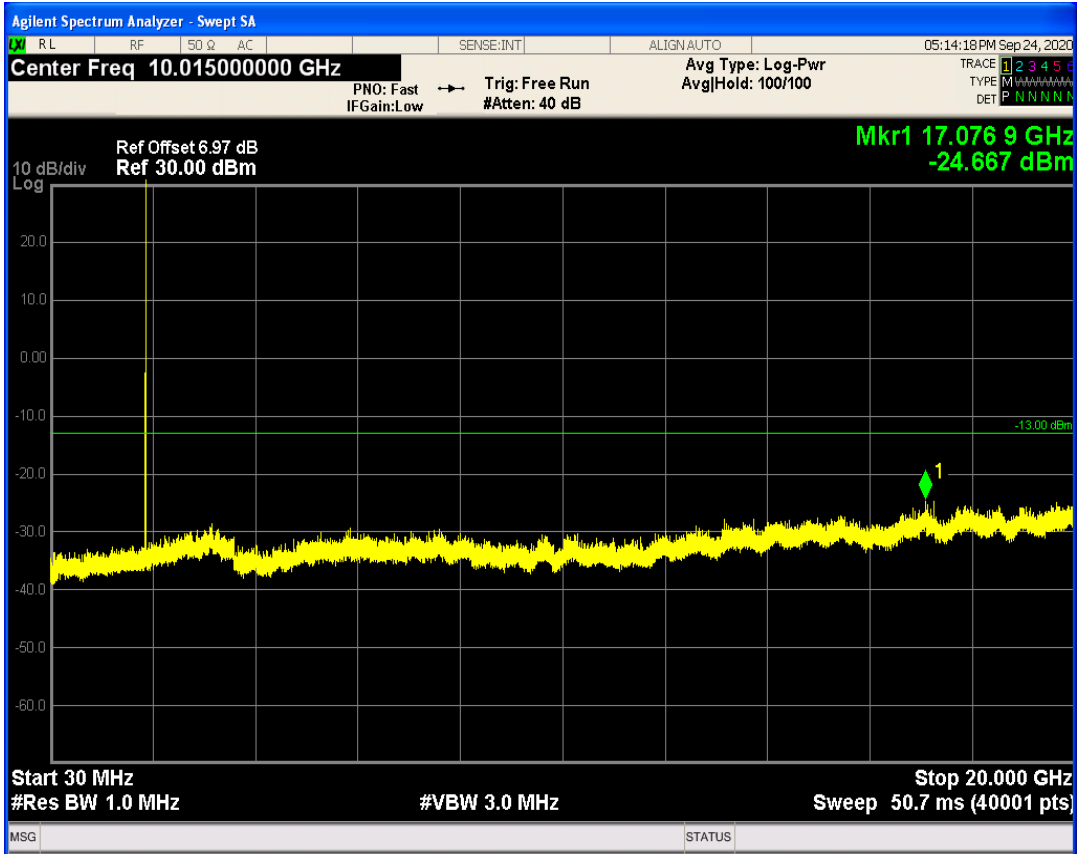

GPRS1900 Channel=810

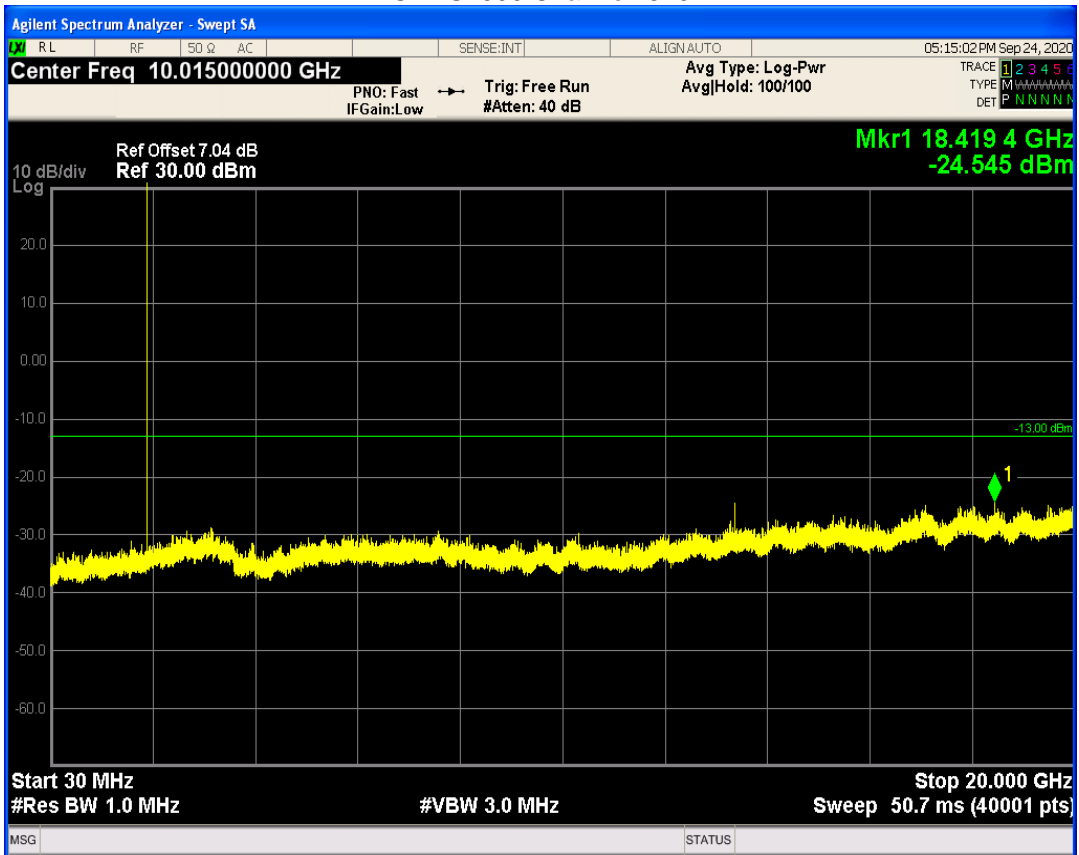

EGPRS850 Channel=128

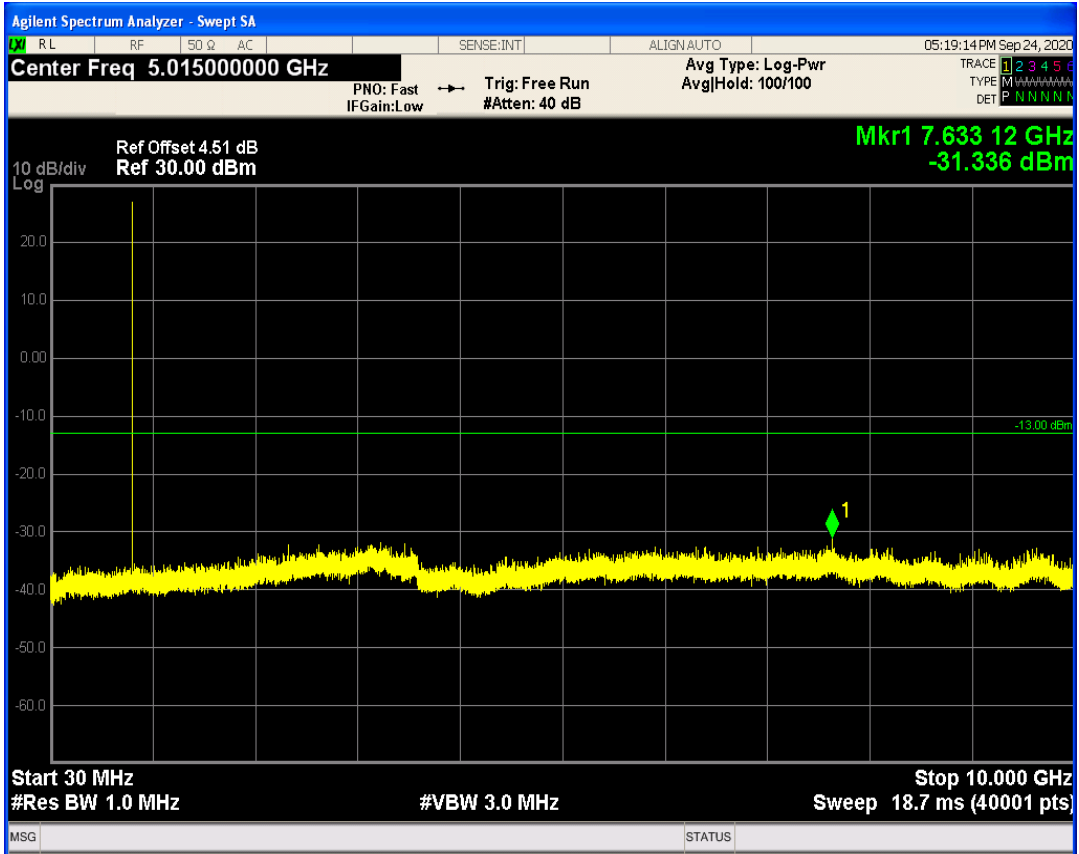

EGPRS850 Channel=251

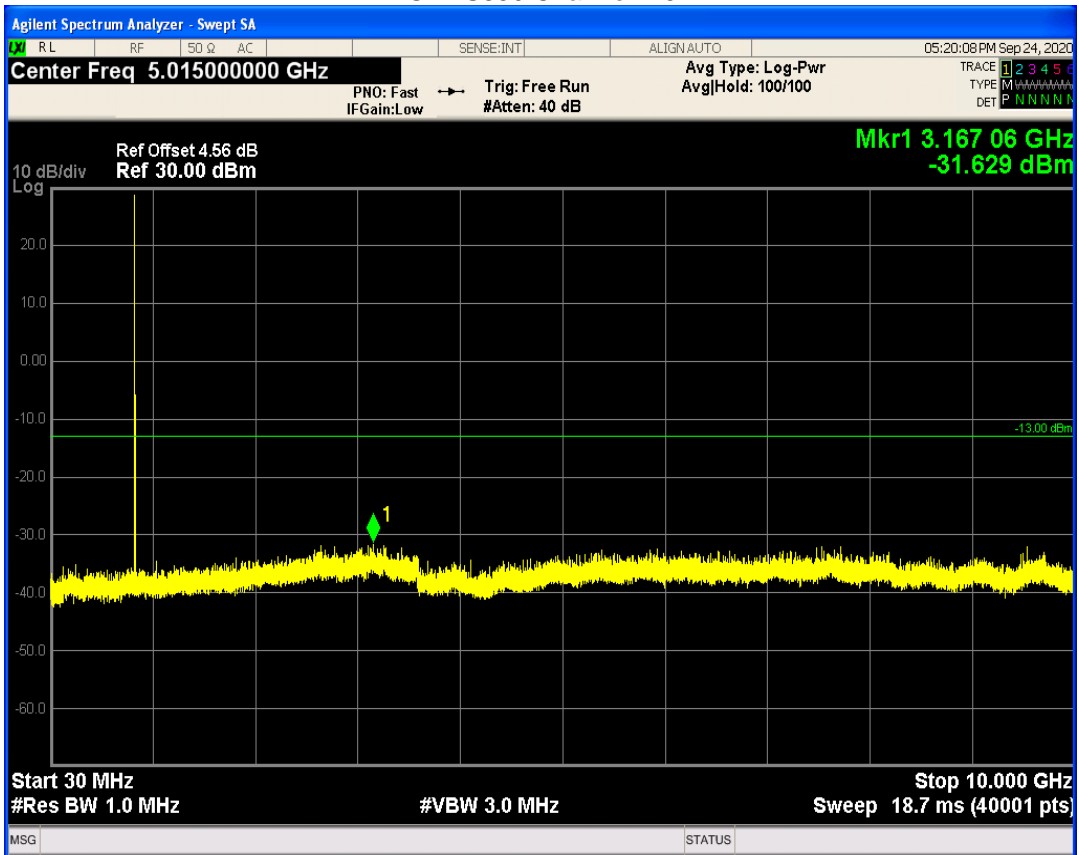

EGPRS850 Channel=189

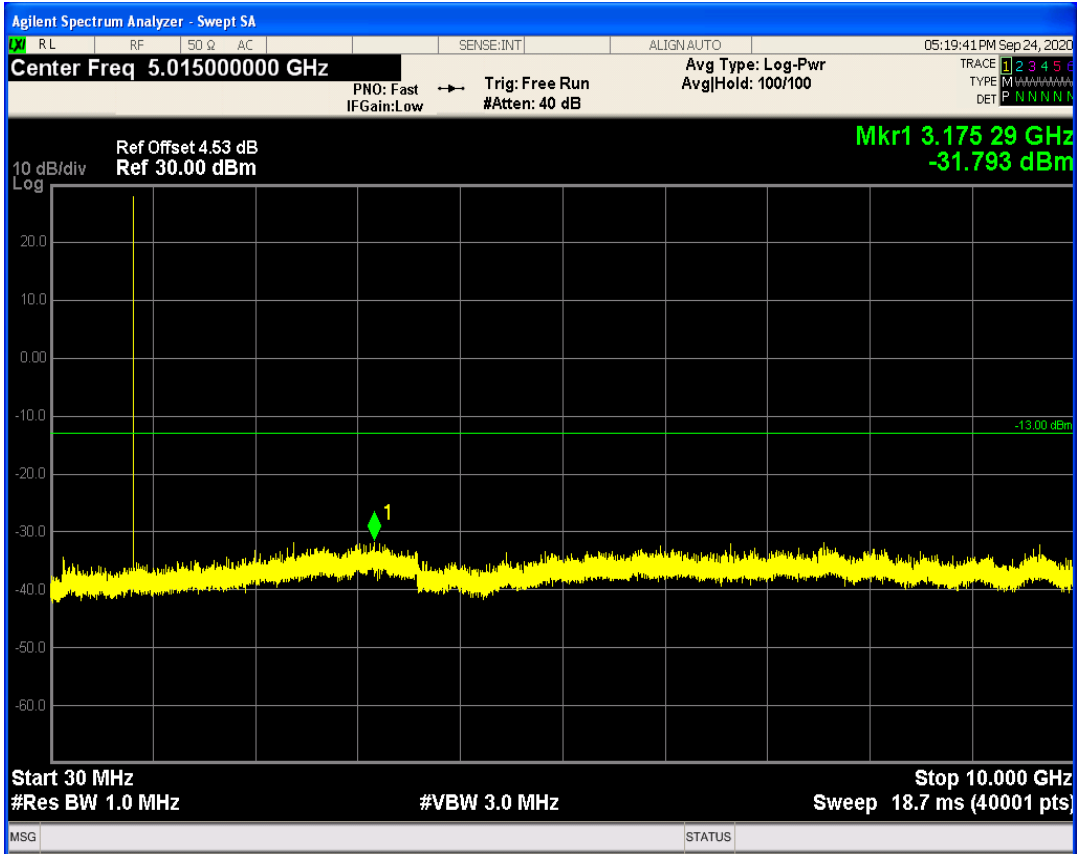

EGPRS1900 Channel=512

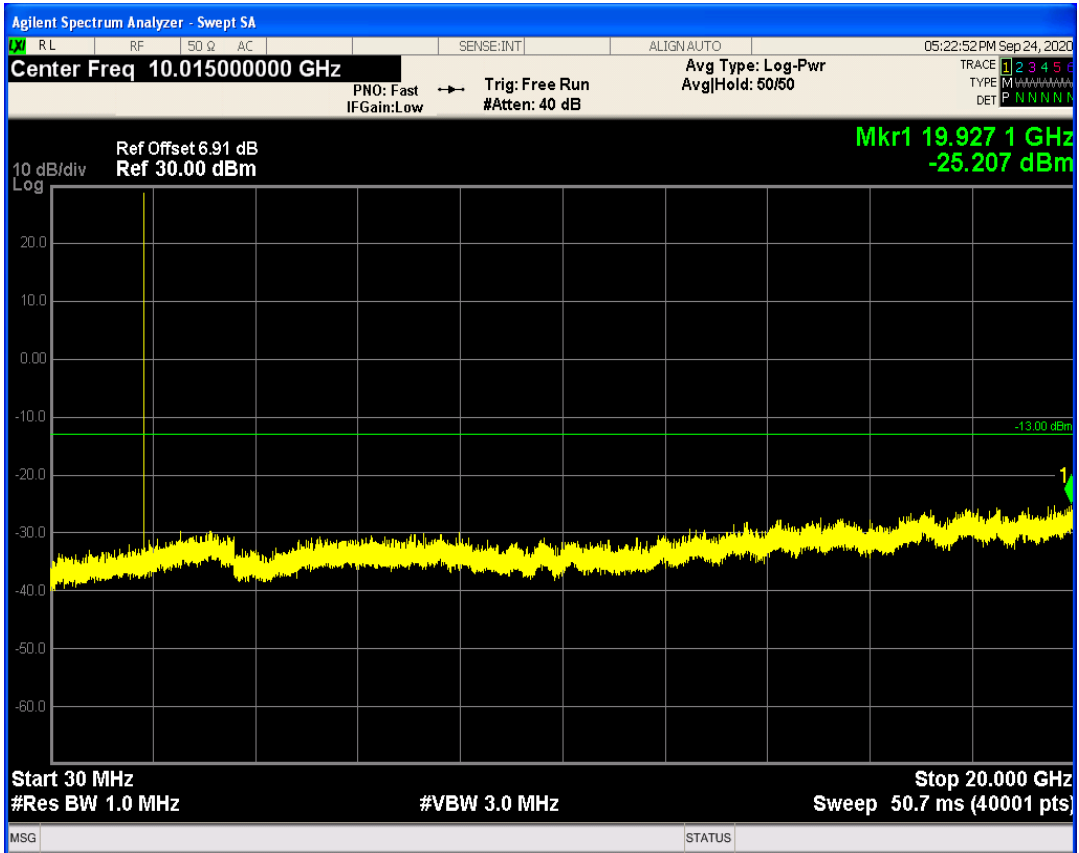

EGPRS1900 Channel=810

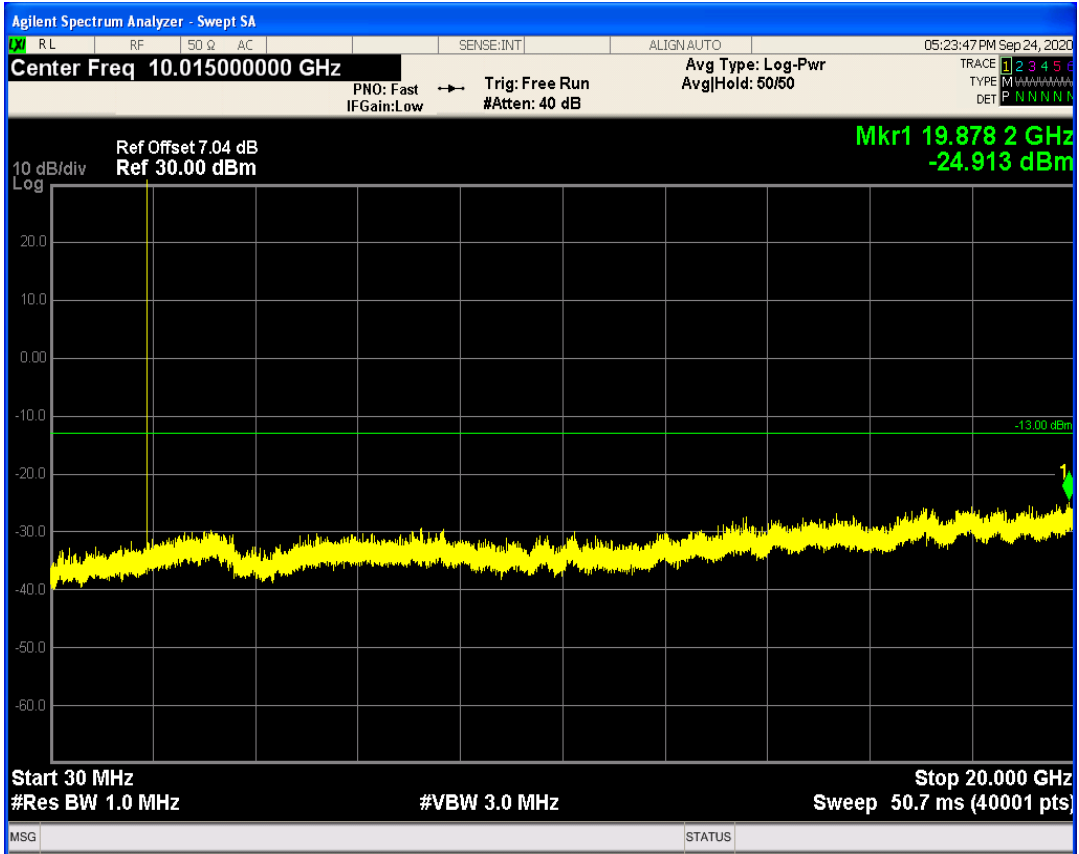

EGPRS1900 Channel=661

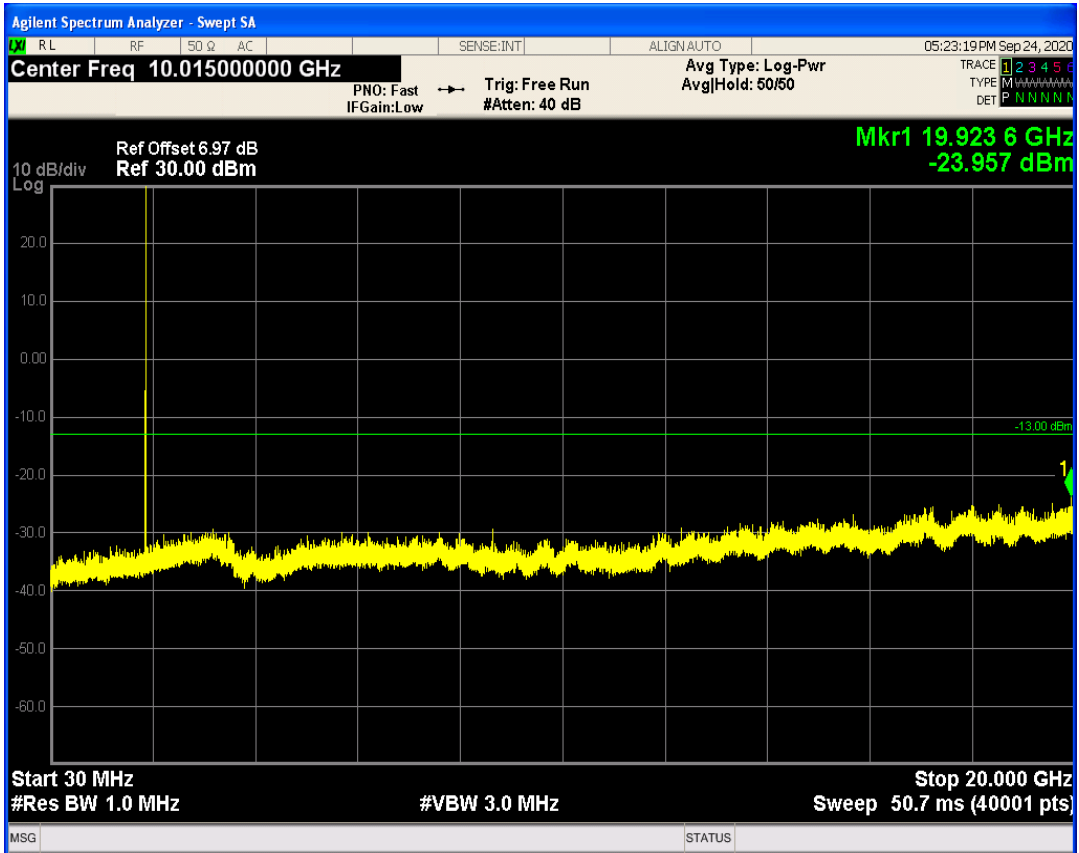

WCDMA Band2 Channel=9400

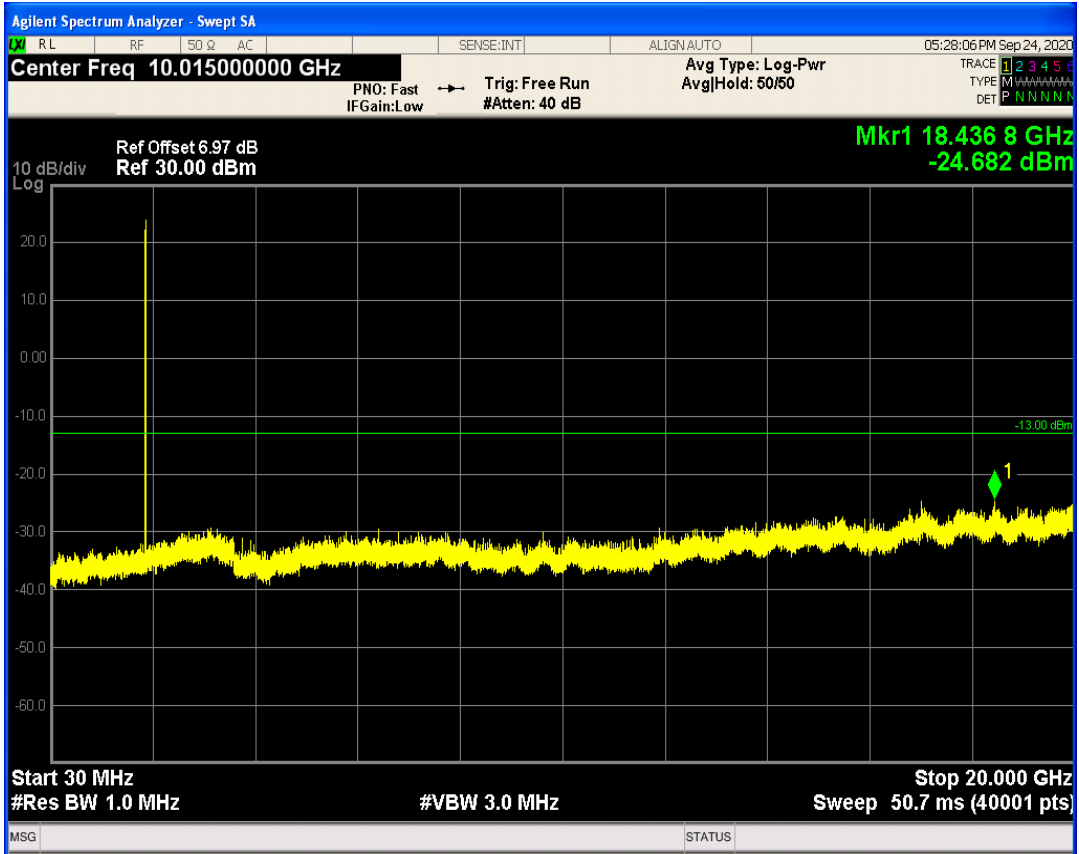

WCDMA Band2 Channel=9262

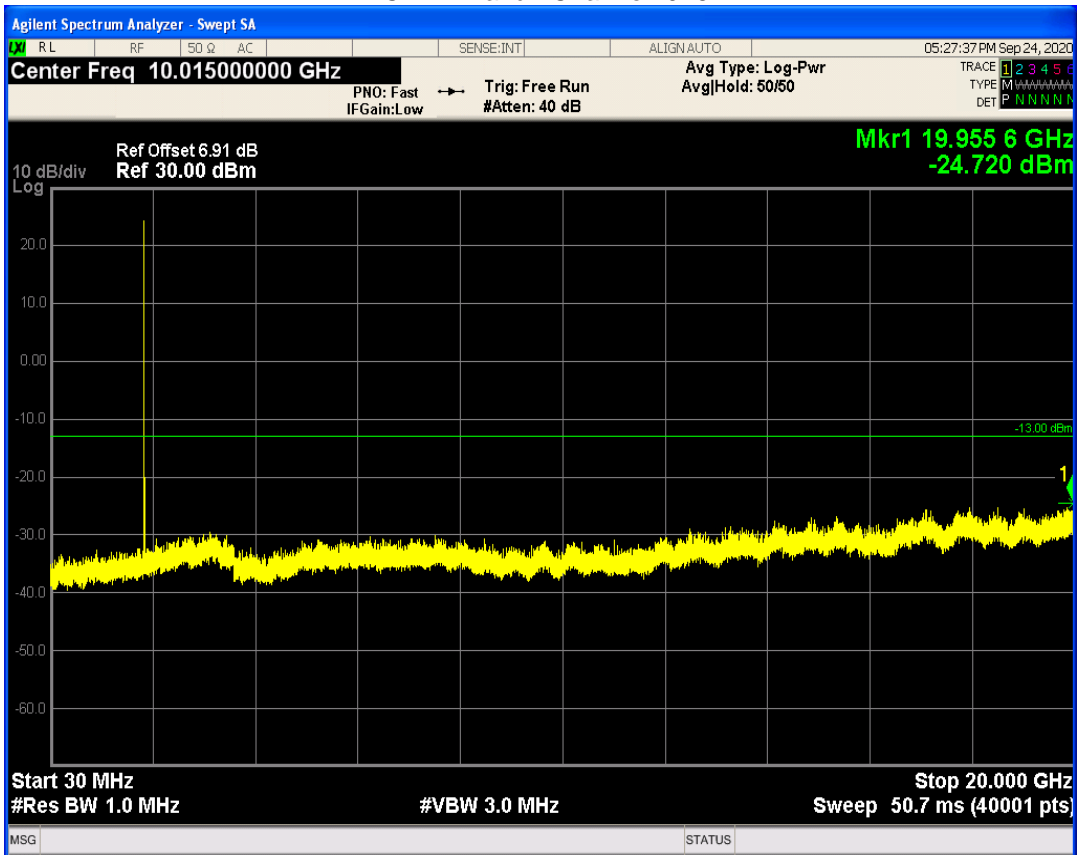

WCDMA Band2 Channel=9538

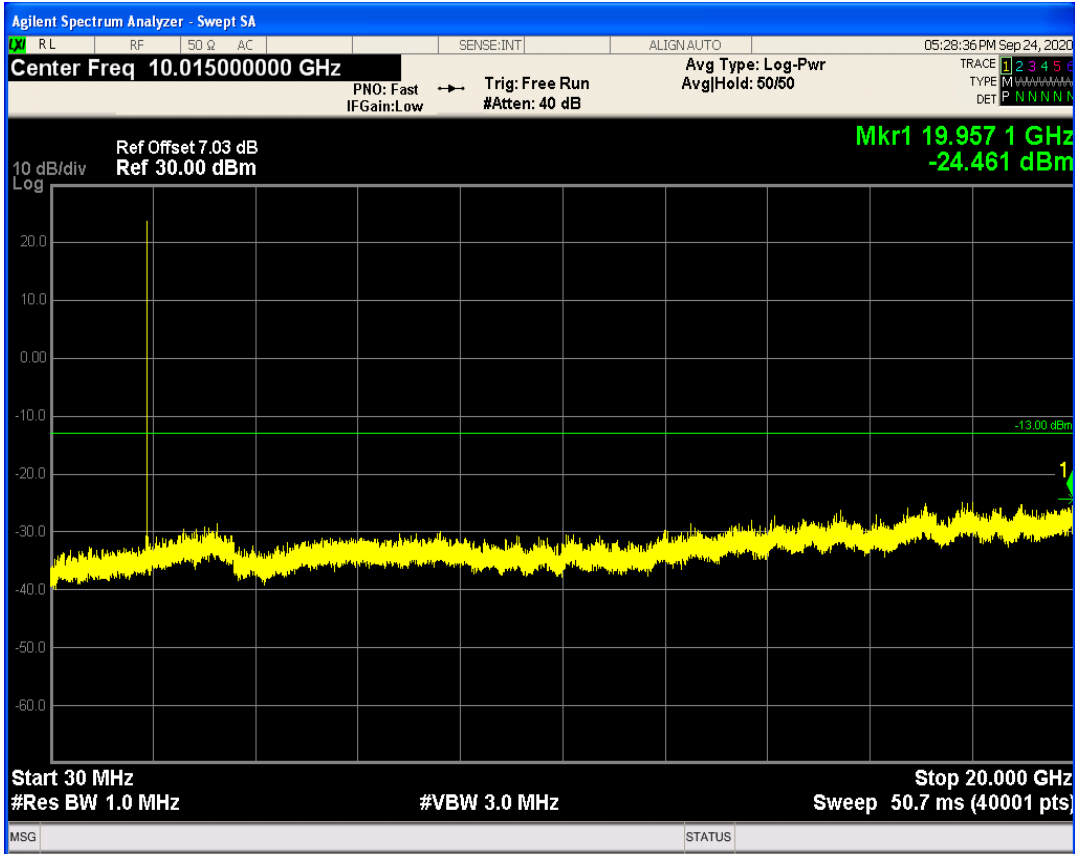

WCDMA Band4 Channel=1412

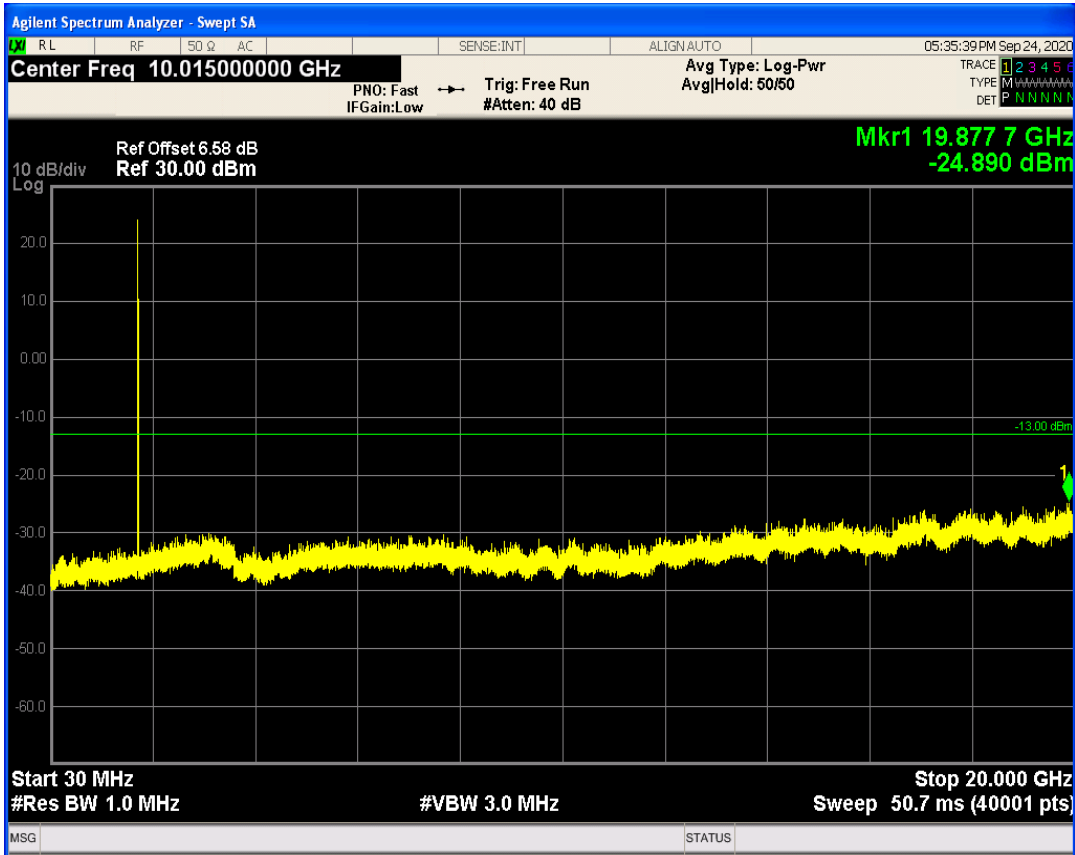

WCDMA Band4 Channel=1312

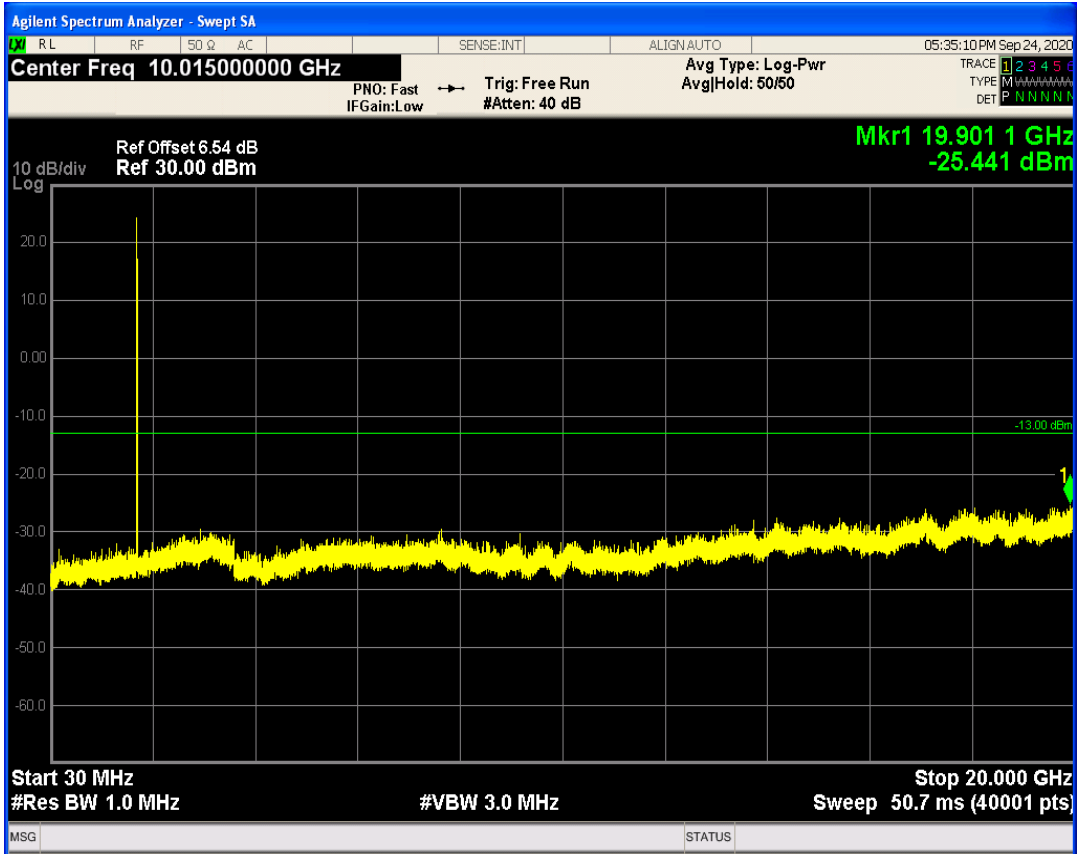

WCDMA Band4 Channel=1513

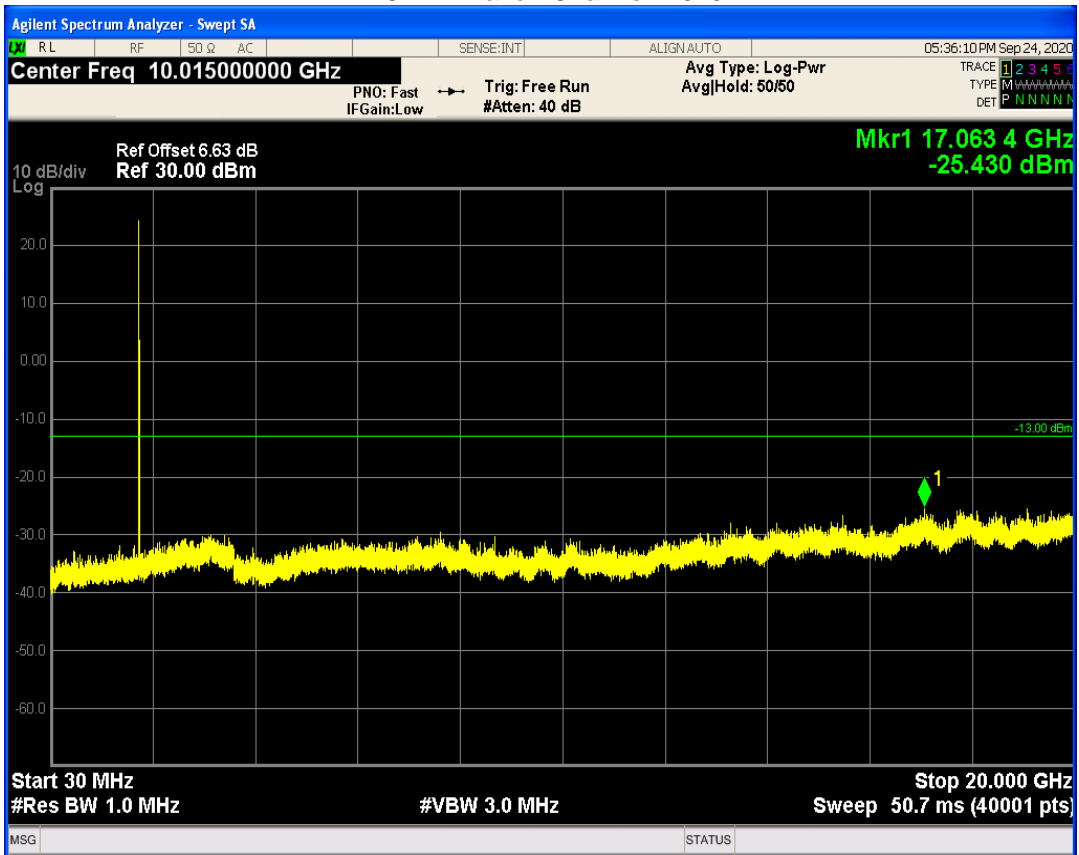

WCDMA Band5 Channel=4132

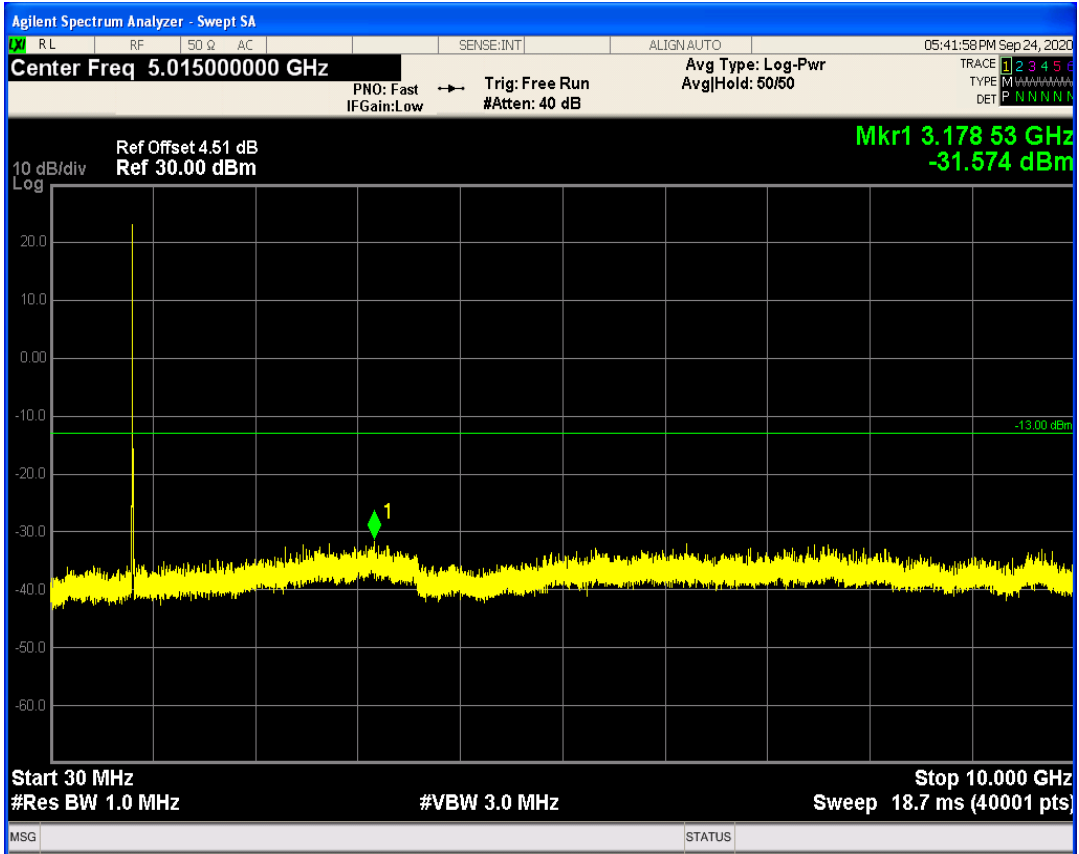

WCDMA Band5 Channel=4182

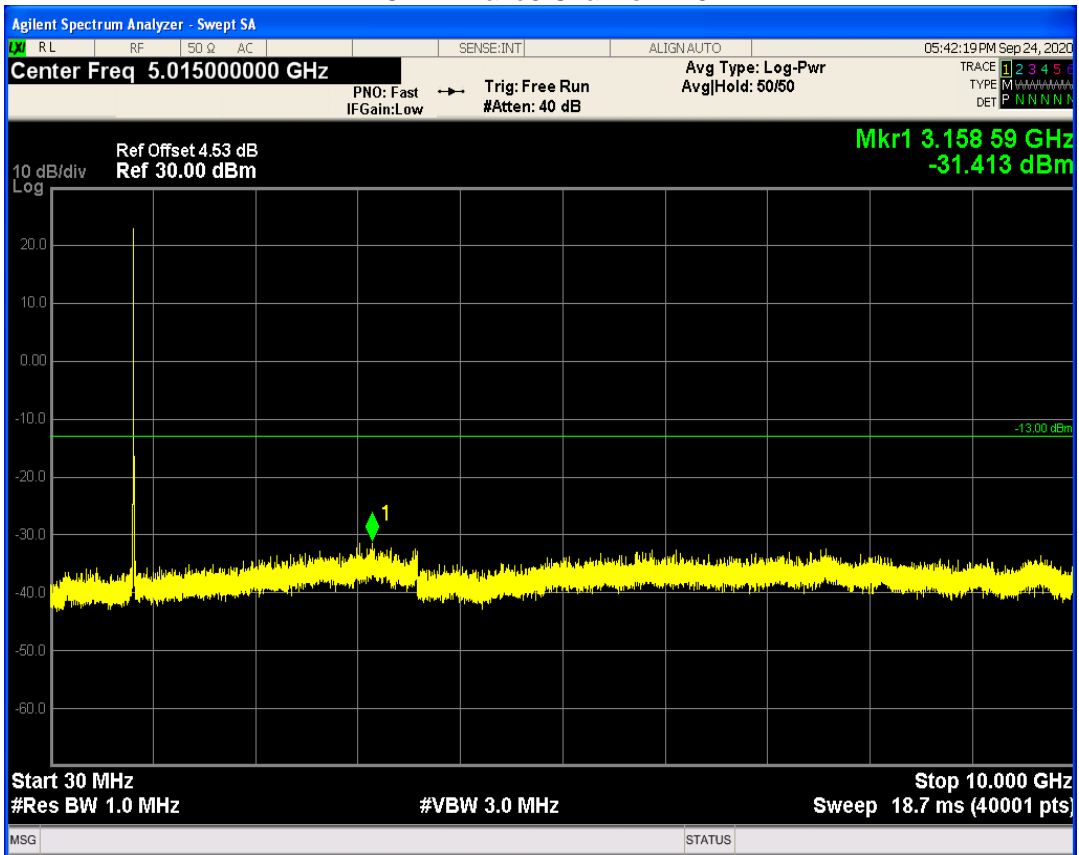

WCDMA Band5 Channel=4233

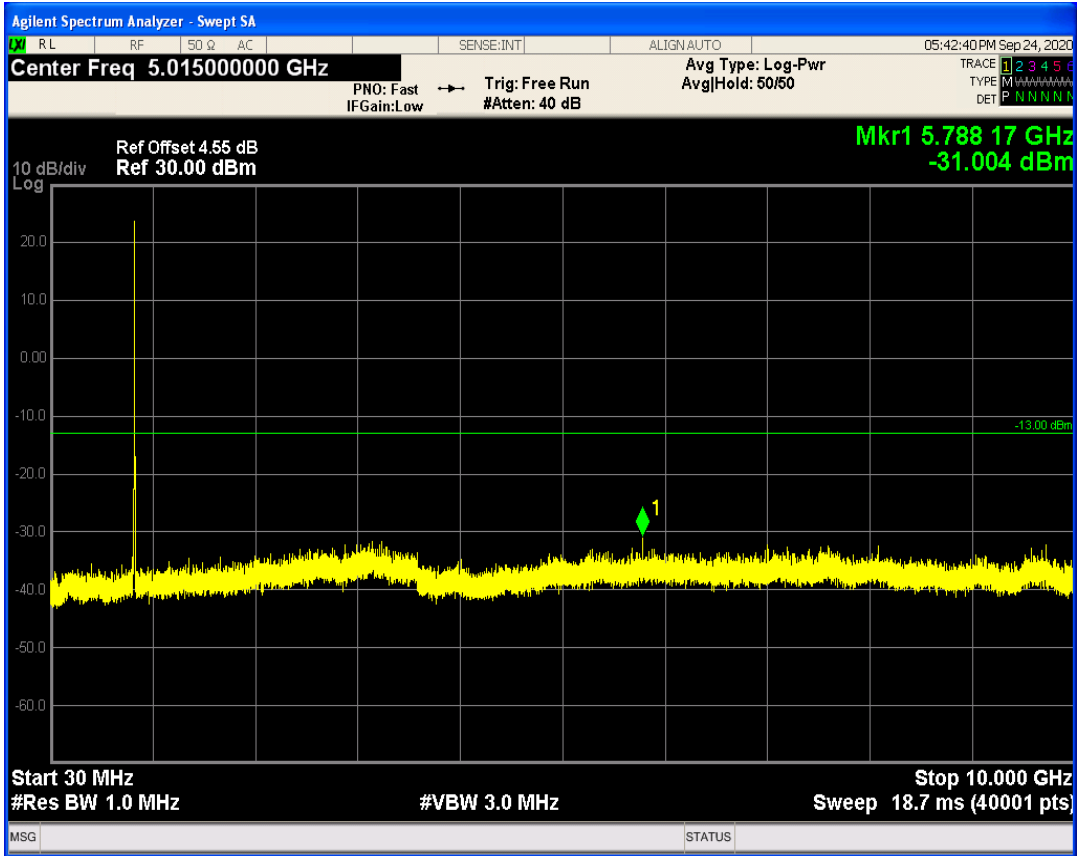

END OF REPORE