

FCC SAR EVALUATION REPORT

**In accordance with the requirements of
FCC 47 CFR Part 2(2.1093) and
IEEE Std 1528-2013**

Product Name : Smart Phone

Brand Name : OUKITEL

Model Name : WP50

Family Model : WP50 S, WP50 Pro, WP50 Ultra,
WP50 TITAN

Report No. : S24040307007001

FCC ID : 2ANMU-WP50

Prepared for

SHENZHEN YUNJI INTELLIGENT TECHNOLOGY CO.,LTD
A2 2F BUILDING ENET NEW INDUSTRIAL PARK,DAFU INDUSTRIAL
ZONE, GUANLAN, LONGHUA SHENZHEN, 518XXX China

Prepared by

Shenzhen NTEK Testing Technology Co., Ltd.
1/F, Building E, Fenda Science Park, Sanwei Community,
Xixiang Street Bao'an District, Shenzhen 518126 P.R. China
Tel. 400-800-6106, 0755-2320 0050, 0755-2320 0090
Website: <http://www.ntek.org.cn>

TEST RESULT CERTIFICATION

Applicant's name SHENZHEN YUNJI INTELLIGENT TECHNOLOGY CO.,LTD
 A2 2F BUILDING ENET NEW INDUSTRIAL PARK,DAFU INDUSTRIAL
 Address..... ZONE, GUANLAN, LONGHUA SHENZHEN,
 518XXX China

Manufacturer's Name . SHENZHEN YUNJI INTELLIGENT TECHNOLOGY CO.,LTD
 A2 2F BUILDING ENET NEW INDUSTRIAL PARK,DAFU INDUSTRIAL
 Address..... ZONE, GUANLAN, LONGHUA SHENZHEN,
 518XXX China

Product description

Product name Smart Phone
 Brand Name OUKITEL
 Model and/or type reference WP50
 Family Model WP50 S, WP50 Pro, WP50 Ultra, WP50 TITAN
 FCC 47 CFR Part 2(2.1093)

Standards IEEE Std 1528-2013
 Published RF exposure KDB procedures

This device described above has been tested by Shenzhen NTEK. In accordance with the measurement methods and procedures specified in IEEE Std 1528-2013 and KDB 865664 D01. Testing has shown that this device is capable of compliance with localized specific absorption rate (SAR) specified in FCC 47 CFR Part 2(2.1093). The test results in this report apply only to the tested sample of the stated device/equipment. Other similar device/equipment will not necessarily produce the same results due to production tolerance and measurement uncertainties.

This report shall not be reproduced except in full, without the written approval of Shenzhen NTEK, this document may be altered or revised by Shenzhen NTEK, personal only, and shall be noted in the revision of the document.

Test Sample Number S240403070008

Date of Test

Date (s) of performance of tests... Apr. 07, 2024 ~ Apr. 21, 2024

Date of Issue May 17, 2024

Test Result..... **Pass**

Prepared By : Jack Li
 Jack Li
 (Project Engineer)

Reviewed By : Aaron Cheng
 Aaron Cheng
 (Supervisor)

Approved By : Alex Li
 Alex Li
 (Manager)

※ ※ **Revision History** ※ ※

REV.	DESCRIPTION	ISSUED DATE	REMARK
Rev.1.0	Initial Test Report Release	May 17, 2024	Jack Li

TABLE OF CONTENTS

1. General Information	6
1.1. RF exposure limits	6
1.2. Statement of Compliance	7
1.3. EUT Description	7
1.4. Test specification(s)	9
1.5. Ambient Condition	9
2. SAR Measurement System	10
2.1. SATIMO SAR Measurement Set-up Diagram	10
2.2. Robot	11
2.3. E-Field Probe	12
2.3.1. E-Field Probe Calibration	12
2.4. SAM phantoms	13
2.4.1. Technical Data	14
2.5. Device Holder	15
2.6. Test Equipment List	16
3. SAR Measurement Procedures	19
3.1. Power Reference	19
3.2. Area scan & Zoom scan	19
3.3. Description of interpolation/extrapolation scheme	21
3.4. Volumetric Scan	21
3.5. Power Drift	21
4. System Verification Procedure	22
4.1. Tissue Verification	22
4.1.1. Tissue Dielectric Parameter Check Results	23
4.2. System Verification Procedure	24
4.2.1. System Verification Results	25
5. SAR Measurement variability and uncertainty	26
5.1. SAR measurement variability	26
5.2. SAR measurement uncertainty	26
6. RF Exposure Positions	27
6.1. Ear and handset reference point	27
6.2. Definition of the cheek position	27
6.3. Definition of the tilt position	29
6.4. Body Worn Accessory	29
6.5. Wireless Router Devices	30
7. RF Output Power	31
7.1. GSM Conducted Power	31
7.2. WCDMA Conducted Power	31
7.3. LTE Conducted Power	33

- 7.4. NR SA Power49
- 7.5. WLAN & Bluetooth Output Power55
- 7.6. NFC56
- 8. Antenna Location.....57
- 9. Stand-alone SAR test exclusion.....57
- 10. SAR Results58
 - 10.1. SAR measurement Result.....58
 - 10.1.1. SAR measurement Result of GSM850.....58
 - 10.1.2. SAR measurement Result of GSM1900.....59
 - 10.1.3. SAR measurement Result of WCDMA Band 2.....60
 - 10.1.4. SAR measurement Result of WCDMA Band 4.....61
 - 10.1.5. SAR measurement Result of WCDMA Band 5.....62
 - 10.1.6. SAR measurement Result of LTE Band 263
 - 10.1.7. SAR measurement Result of LTE Band 465
 - 10.1.8. SAR measurement Result of LTE Band 567
 - 10.1.9. SAR measurement Result of LTE Band 769
 - 10.1.10. SAR measurement Result of LTE Band 1270
 - 10.1.11. SAR measurement Result of LTE Band 1772
 - 10.1.12. SAR measurement Result of LTE Band 3874
 - 10.1.13. SAR measurement Result of LTE Band 4176
 - 10.1.14. SAR measurement Result of NR n78.....78
 - 10.1.15. SAR measurement Result of WLAN2.4G79
 - 10.1.16. SAR measurement Result of WLAN5.2G80
 - 10.1.17. SAR measurement Result of WLAN5.8G82
 - 10.1.18. SAR measurement Result of Bluetooth.....83
 - 10.2. Simultaneous Transmission Analysis.....84
- 11. Appendix A. Photo documentation86
- 12. Appendix B. System Check Plots87
- 13. Appendix C. Plots of High SAR Measurement.....106
- 14. Appendix D. Calibration Certificate179

1. General Information

1.1. RF exposure limits

(A).Limits for Occupational/Controlled Exposure (W/kg)

Whole-Body	Partial-Body	Hands, Wrists, Feet and Ankles
0.4	8.0	20.0

(B).Limits for General Population/Uncontrolled Exposure (W/kg)

Whole-Body	Partial-Body	Hands, Wrists, Feet and Ankles
0.08	1.6	4.0

NOTE: **Whole-Body SAR** is averaged over the entire body, **partial-body SAR** is averaged over any 1 gram of tissue defined as a tissue volume in the shape of a cube. **SAR for hands, wrists, feet and ankles** is averaged over any 10 grams of tissue defined as a tissue volume in the shape of a cube.

Occupational/Controlled Environments:

Are defined as locations where there is exposure that may be incurred by people who are aware of the potential for exposure, (i.e. as a result of employment or occupation).

General Population/Uncontrolled Environments:

Are defined as locations where there is the exposure of individuals who have no knowledge or control of their exposure.

NOTE
HEAD AND TRUNK LIMIT
1.6 W/kg
APPLIED TO THIS EUT

1.2. Statement of Compliance

The maximum results of Specific Absorption Rate (SAR) found during testing for WP50 are as follows.

RF Exposure Conditions		Max Reported SAR Value(W/kg)
1-g Head		0.487
1-g Body-Worn (Separation distance of 10mm)		0.651
1-g Hotspot (Separation distance of 10mm)		0.651
Max Simultaneous Tx	Head	0.712
	Body-Worn	0.832
	Hotspot	0.832

Note: The Max Simultaneous Tx is calculated based on the same configuration and test position.

This device is in compliance with Specific Absorption Rate (SAR) for general population/uncontrolled exposure limits (1.6 W/kg) specified in FCC 47 CFR Part 2(2.1093), and had been tested in accordance with the measurement methods and procedures specified in IEEE Std 1528-2013 & KDB 865664 D01.

1.3. EUT Description

Device Information	
Product Name	Smart Phone
Brand Name	OUKITEL
Model Name	WP50
Family Model	WP50 S, WP50 Pro, WP50 Ultra, WP50 TITAN
Model Difference	All the model are the same circuit and RF module, except the model names.
FCC ID	2ANMU-WP50
Device Phase	Identical Prototype
Exposure Category	General population / Uncontrolled environment
Antenna Type	FPC Antenna
Battery Information	DC 3.87V, 6500mAh, 25.15Wh
HW Version	HCT-V511MB-B1
SW Version	OUKITEL_WP50_EEA_V03
Device Operating Configurations	
Supporting Mode(s)	GSM850/1900,WCDMABand2/4/5,LTEBand2/4/5/7/12/17/38/41, NR SA n78, NSA n78+ LTE Band 2, WLAN 2.4G/5G, Bluetooth, NFC
Test Modulation	GSM(GMSK/8PSK), WCDMA(QPSK), LTE(QPSK/16QAM), NR(DFT-s-OFDM:PI/2 BPSK/QPSK/16-QAM/64QAM/256QAM CP-OFDM:QPSK/16-QAM/64QAM/256QAM),WLAN(DSSS/OFDM), WLAN(DSSS/OFDM), Bluetooth(GFSK, π/4-DQPSK, 8DPSK), NFC(ASK)
Device Class	B

Operating Frequency Range(s)	Band	Tx (MHz)	Rx (MHz)
	GSM 850	824-849	869-894
	GSM 1900	1850-1910	1930-1990
	WCDMA Band 2	1850-1910	1930-1990
	WCDMA Band 4	1710-1755	2110-2155
	WCDMA Band 5	824-849	869-894
	LTE Band 2	1850-1910	1930-1990
	LTE Band 4	1710-1755	2110-2155
	LTE Band 5	824-849	869-894
	LTE Band 7	2500-2570	2620-2690
	LTE Band 12	699-716	729-746
	LTE Band 17	704-716	734-746
	LTE Band 38	2570-2620	
	LTE Band 41	2496-2690	
	NR n78	3450-3550	
	WLAN 2.4G	2412-2462	
	WLAN 5.2G	5180-5240	
	WLAN 5.8G	5745-5825	
	NFC	13.56	
Bluetooth	2402-2480		
GPRS Multislot Class(12)	Max Number of Timeslots in Uplink	4	
	Max Number of Timeslots in Downlink	4	
	Max Total Timeslot	5	
EGPRS Multislot Class(12)	Max Number of Timeslots in Uplink	4	
	Max Number of Timeslots in Downlink	4	
	Max Total Timeslot	5	
Power Class	4, tested with power level 5(GSM 850)		
	1, tested with power level 0(GSM 1900)		
	3, tested with power control "all 1"(WCDMA Band 2)		
	3, tested with power control "all 1"(WCDMA Band 4)		
	3, tested with power control "all 1"(WCDMA Band 5)		
	3, tested with power control all Max.(LTE Band 2)		
	3, tested with power control all Max.(LTE Band 4)		
	3, tested with power control all Max.(LTE Band 5)		
	3, tested with power control all Max.(LTE Band 7)		
	3, tested with power control all Max.(LTE Band 12)		
	3, tested with power control all Max.(LTE Band 17)		
	3, tested with power control all Max.(LTE Band 38)		
	3, tested with power control all Max.(LTE Band 41)		
3, tested with power control all Max.(NR SA 78)			

1.4. Test specification(s)

FCC 47 CFR Part 2(2.1093)
IEEE Std 1528-2013
KDB 865664 D01 SAR measurement 100 MHz to 6 GHz
KDB 865664 D02 RF Exposure Reporting
KDB 447498 D01 General RF Exposure Guidance
KDB 248227 D01 802.11 Wi-Fi SAR
KDB 941225 D01 3G SAR Procedures
KDB 941225 D05 SAR for LTE Devices
KDB 941225 D06 Hotspot SAR
KDB 648474 D04 Handset SAR

1.5. Ambient Condition

Ambient temperature	20°C – 24°C
Relative Humidity	30% – 70%

2. SAR Measurement System

2.1. SATIMO SAR Measurement Set-up Diagram

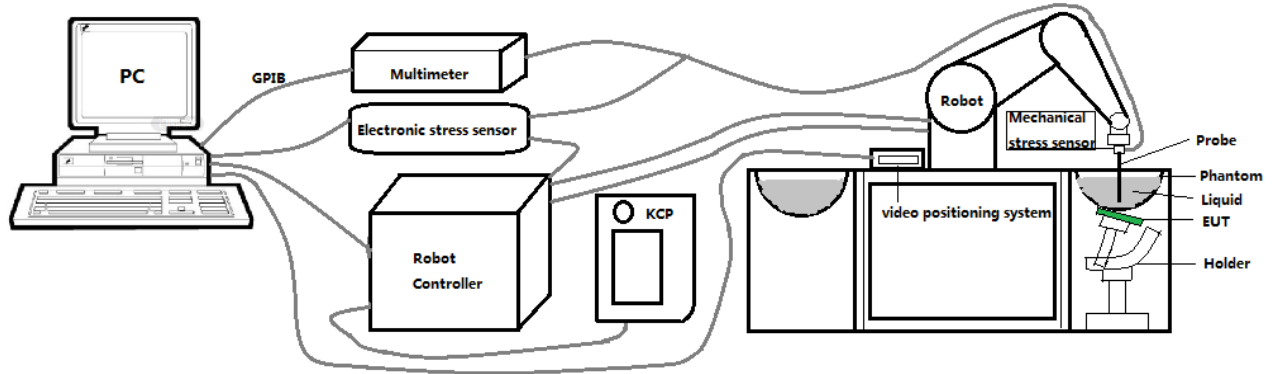

These measurements were performed with the automated near-field scanning system OPENSAR from SATIMO. The system is based on a high precision robot (working range: 901 mm), which positions the probes with a positional repeatability of better than ± 0.03 mm. The SAR measurements were conducted with dosimetric probe (manufactured by SATIMO), designed in the classical triangular configuration and optimized for dosimetric evaluation.

The first step of the field measurement is the evaluation of the voltages induced on the probe by the device under test. Probe diode detectors are nonlinear. Below the diode compression point, the output voltage is proportional to the square of the applied E-field; above the diode compression point, it is linear to the applied E-field. The compression point depends on the diode, and a calibration procedure is necessary for each sensor of the probe.

The Keithley multimeter reads the voltage of each sensor and send these three values to the PC. The corresponding E field value is calculated using the probe calibration factors, which are stored in the working directory. This evaluation includes linearization of the diode characteristics. The field calculation is done separately for each sensor. Each component of the E field is displayed on the "Dipole Area Scan Interface" and the total E field is displayed on the "3D Interface"

2.2. Robot

The SATIMO SAR system uses the high precision robots from KUKA. For the 6-axis controller system, the robot controller version (KUKA) from KUKA is used. The KUKA robot series have many features that are important for our application:



- High precision (repeatability ± 0.03 mm)
- High reliability (industrial design)
- Jerk-free straight movements
- Low ELF interference (the closed metallic construction shields against motor control fields)

2.3. E-Field Probe

This E-field detection probe is composed of three orthogonal dipoles linked to special Schottky diodes with low detection thresholds. The probe allows the measurement of electric fields in liquids such as the one defined in the IEEE and CENELEC standards.

For the measurements the Specific Dosimetric E-Field Probe 3423-EPGO-426 with following specifications is used



- Dynamic range: 0.01-100 W/kg
 - Tip Diameter : 2.5 mm
 - Distance between probe tip and sensor center: 1 mm
 - Distance between sensor center and the inner phantom surface: 2 mm (repeatability better than ± 1 mm).
 - Probe linearity: ± 0.06 dB
 - Axial isotropy: ± 0.01 dB
 - Hemispherical Isotropy: ± 0.01 dB
 - Calibration range: 650MHz to 5900MHz for head & body simulating liquid.
 - Lower detection limit: 8mW/kg
- Angle between probe axis (evaluation axis) and surface normal line: less than 30° .

2.3.1. E-Field Probe Calibration

Each probe needs to be calibrated according to a dosimetric assessment procedure with accuracy better than $\pm 10\%$. The spherical isotropy shall be evaluated and within ± 0.25 dB. The sensitivity parameters (Norm X, Norm Y, and Norm Z), the diode compression parameter (DCP) and the conversion factor (Conv F) of the probe are tested. The calibration data can be referred to appendix D of this report.

2.4. SAM phantoms

Photo of SAM phantom SN 16/15 SAM119



The SAM phantom is used to measure the SAR relative to people exposed to electro-magnetic field radiated by Smart Phones.

2.4.1. Technical Data

Serial Number	Shell thickness	Filling volume	Dimensions	Positionner Material	Permittivity	Loss Tangent
SN 16/15 SAM119	2 mm ±0.2 mm	27 liters	Length:1000 mm Width:500 mm Height:200 mm	Gelcoat with fiberglass	3.4	0.02

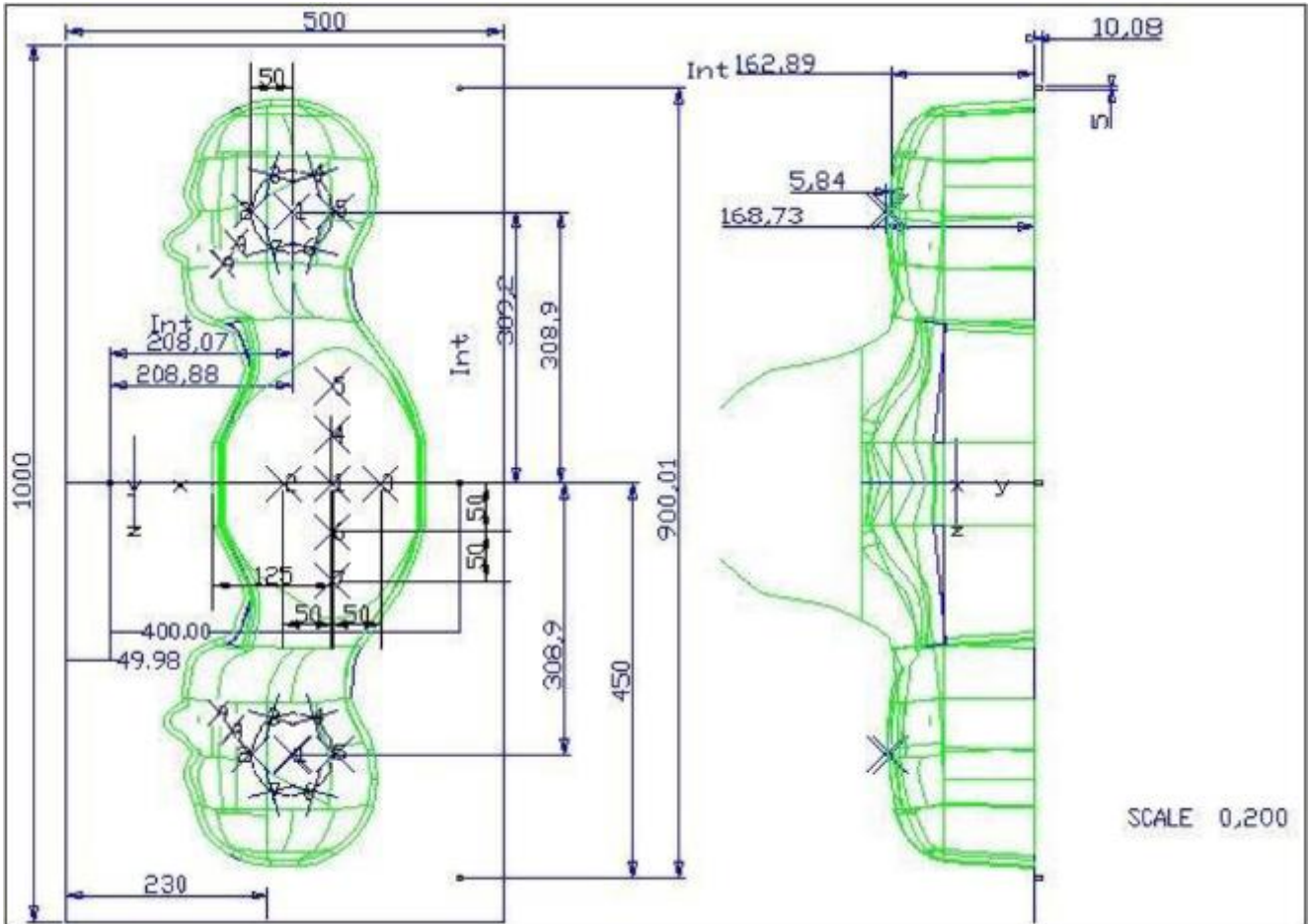

Serial Number	Left Head(mm)		Right Head(mm)		Flat Part(mm)	
	1	2	1	2	1	2
SN 16/15 SAM119	2	2.02	2	2.08	1	2.09
	3	2.05	3	2.06	2	2.06
	4	2.07	4	2.07	3	2.08
	5	2.08	5	2.08	4	2.10
	6	2.05	6	2.07	5	2.10
	7	2.05	7	2.05	6	2.07
	8	2.07	8	2.06	7	2.07
	9	2.08	9	2.06	-	-

The test, based on ultrasonic system, allows measuring the thickness with an accuracy of 10 µm.

2.5. Device Holder

The positioning system allows obtaining cheek and tilting position with a very good accuracy. In compliance with CENELEC, the tilt angle uncertainty is lower than 1 degree.

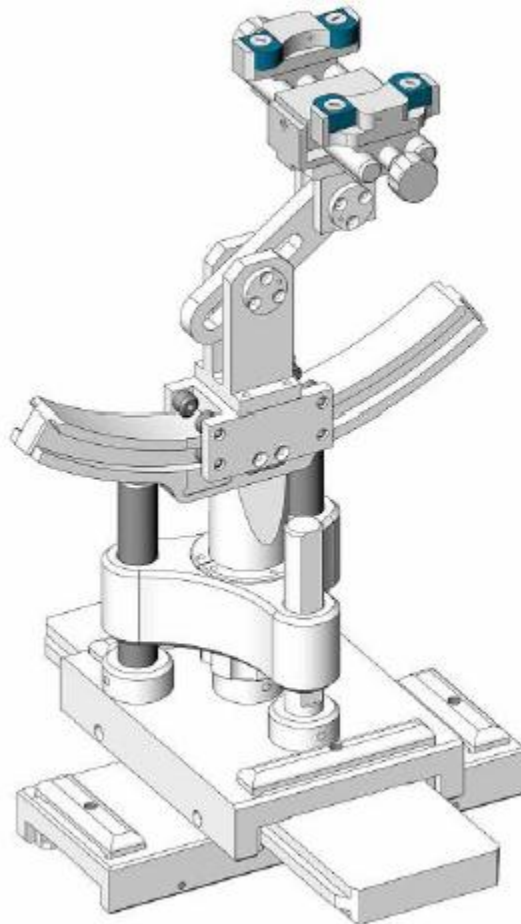

Serial Number	Holder Material	Permittivity	Loss Tangent
SN 16/15 MSH100	Delrin	3.7	0.005

2.6. Test Equipment List

This table gives a complete overview of the SAR measurement equipment.

Devices used during the test described are marked

	Manufacturer	Name of Equipment	Type/Model	Serial Number	Calibration	
					Last Cal.	Due Date
<input checked="" type="checkbox"/>	MVG	E FIELD PROBE	SSE2	3423-EPGO-426	Sep. 18, 2023	Sep. 17, 2024
<input checked="" type="checkbox"/>	MVG	750 MHz Dipole	SID750	SN 03/15 DIP 0G750-355	Feb. 21, 2024	Feb. 20, 2027
<input checked="" type="checkbox"/>	MVG	835 MHz Dipole	SID835	SN 03/15 DIP 0G835-347	Feb. 21, 2024	Feb. 20, 2027
<input type="checkbox"/>	MVG	900 MHz Dipole	SID900	SN 03/15 DIP 0G900-348	Feb. 21, 2024	Feb. 20, 2027
<input checked="" type="checkbox"/>	MVG	1800 MHz Dipole	SID1800	SN 03/15 DIP 1G800-349	Feb. 21, 2024	Feb. 20, 2027
<input checked="" type="checkbox"/>	MVG	1900 MHz Dipole	SID1900	SN 03/15 DIP 1G900-350	Feb. 21, 2024	Feb. 20, 2027
<input type="checkbox"/>	MVG	2000 MHz Dipole	SID2000	SN 03/15 DIP 2G000-351	Feb. 21, 2024	Feb. 20, 2027
<input type="checkbox"/>	MVG	2300 MHz Dipole	SID2300	SN 03/16 DIP 2G300-358	Feb. 21, 2024	Feb. 20, 2027
<input checked="" type="checkbox"/>	MVG	2450 MHz Dipole	SID2450	SN 03/15 DIP 2G450-352	Feb. 21, 2024	Feb. 20, 2027
<input checked="" type="checkbox"/>	MVG	2600 MHz Dipole	SID2600	SN 03/15 DIP 2G600-356	Feb. 21, 2024	Feb. 20, 2027
<input checked="" type="checkbox"/>	MVG	3500 MHz Dipole	SID3500	SN 09/12 DIP 3G500-360	Oct. 15, 2022	Oct. 14, 2025
<input type="checkbox"/>	MVG	3700 MHz Dipole	SID3700	SN 09/12 DIP 3G/700-361	Oct. 15, 2022	Oct. 14, 2025
<input checked="" type="checkbox"/>	MVG	5000 MHz Dipole	SWG5500	SN 13/14 WGA 33	Feb. 21, 2024	Feb. 20, 2027
<input checked="" type="checkbox"/>	MVG	Liquid measurement Kit	SCLMP	SN 21/15 OCPG 72	NCR	NCR
<input checked="" type="checkbox"/>	MVG	Power Amplifier	N.A	AMPLISAR_28/14_003	NCR	NCR
<input checked="" type="checkbox"/>	KEITHLEY	Millivoltmeter	2000	4072790	NCR	NCR
<input checked="" type="checkbox"/>	R&S	Universal radio communication tester	CMU200	117858	May 29, 2023	May 28, 2024

<input checked="" type="checkbox"/>	R&S	Wideband radio communication tester	CMW500	103917	May 29, 2023	May 28, 2024
<input checked="" type="checkbox"/>	HP	Network Analyzer	8753D	3410J01136	May 29, 2023	May 28, 2024
<input checked="" type="checkbox"/>	Agilent	MXG Vector Signal Generator	N5182A	MY47070317	May 29, 2023	May 28, 2024
<input checked="" type="checkbox"/>	Agilent	Power meter	E4419B	MY45102538	May 29, 2023	May 28, 2024
<input checked="" type="checkbox"/>	Agilent	Power sensor	E9301A	MY41495644	May 29, 2023	May 28, 2024
<input checked="" type="checkbox"/>	Agilent	Power sensor	E9301A	US39212148	May 29, 2023	May 28, 2024
<input checked="" type="checkbox"/>	MCLI/USA	Directional Coupler	CB11-20	0D2L51502	Jul. 04, 2023	Jul. 03, 2024
<input checked="" type="checkbox"/>	N/A	Thermometer	N/A	LES-085	Mar. 27, 2023	Mar. 26, 2026
<input checked="" type="checkbox"/>	MVG	SAM Phantom	SSM2	SN 16/15 SAM119	NCR	NCR
<input checked="" type="checkbox"/>	MVG	Device Holder	SMPPD	SN 16/15 MSH100	NCR	NCR
<input checked="" type="checkbox"/>	Shenzhen Tianxu Communication Technology Co., Ltd.	Human Simulating Liquid	Head 750	Head 750	NCR	NCR
<input checked="" type="checkbox"/>	Shenzhen Tianxu Communication Technology Co., Ltd.	Human Simulating Liquid	Head 835	Head 835	NCR	NCR
<input checked="" type="checkbox"/>	Shenzhen Tianxu Communication Technology Co., Ltd.	Human Simulating Liquid	Head 1800	Head 1800	NCR	NCR
<input checked="" type="checkbox"/>	Shenzhen Tianxu Communication Technology Co., Ltd.	Human Simulating Liquid	Head 1900	Head 1900	NCR	NCR
<input checked="" type="checkbox"/>	Shenzhen	Human	Head 2450	Head 2450	NCR	NCR

	Tianxu Communication Technology Co., Ltd.	Simulating Liquid				
<input checked="" type="checkbox"/>	Shenzhen Tianxu Communication Technology Co., Ltd.	Human Simulating Liquid	Head 2600	Head 2600	NCR	NCR
<input checked="" type="checkbox"/>	Shenzhen Tianxu Communication Technology Co., Ltd.	Human Simulating Liquid	Head 3500	Head 3500	NCR	NCR
<input checked="" type="checkbox"/>	Shenzhen Tianxu Communication Technology Co., Ltd.	Human Simulating Liquid	Head 5200	Head 5200	NCR	NCR
<input checked="" type="checkbox"/>	Shenzhen Tianxu Communication Technology Co., Ltd.	Human Simulating Liquid	Head 5800	Head 5800	NCR	NCR

3. SAR Measurement Procedures

The measurement procedures are as follows:

<Conducted power measurement>

- (a) For WWAN power measurement, use base station simulator to configure EUT WWAN transmission in conducted connection with RF cable, at maximum power in each supported wireless interface and frequency band.
- (b) Read the WWAN RF power level from the base station simulator.
- (c) For Wi-Fi/BT power measurement, use engineering software to configure EUT Wi-Fi/BT continuously transmission, at maximum RF power in each supported wireless interface and frequency band.
- (d) Connect EUT RF port through RF cable to the power meter, and measure Wi-Fi/BT output power.

<SAR measurement>

- (a) Use base station simulator to configure EUT WWAN transmission in radiated connection, and engineering software to configure EUT Wi-Fi/BT continuously transmission, at maximum RF power, in the highest power channel.
- (b) Place the EUT in the positions as Appendix A demonstrates.
- (c) Set scan area, grid size and other setting on the OPENSAR software.
- (d) Measure SAR results for the highest power channel on each testing position.
- (e) Find out the largest SAR result on these testing positions of each band.
- (f) Measure SAR results for other channels in worst SAR testing position if the reported SAR of highest power channel is larger than 0.8 W/kg.

According to the test standard, the recommended procedure for assessing the peak spatial-average SAR value consists of the following steps:

- (a) Power reference measurement
- (b) Area scan
- (c) Zoom scan
- (d) Power drift measurement

3.1. Power Reference

The Power Reference Measurement and Power Drift Measurements are for monitoring the power drift of the device under test in the batch process. The minimum distance of probe sensors to surface determines the closest measurement point to phantom surface. This distance cannot be smaller than the distance of sensor calibration points to probe tip as defined in the probe properties.

3.2. Area scan & Zoom scan

The area scan is a 2D scan to find the hot spot location on the DUT. The zoom scan is a 3D scan

above the hot spot to calculate the 1g and 10g SAR value.

Measurement of the SAR distribution with a grid of 8 to 16 mm * 8 to 16 mm and a constant distance to the inner surface of the phantom. Since the sensors cannot directly measure at the inner phantom surface, the values between the sensors and the inner phantom surface are extrapolated. With these values the area of the maximum SAR is calculated by an interpolation scheme. Around this point, a cube of 30 * 30 * 30 mm or 32 * 32 * 32 mm is assessed by measuring 5 or 8 * 5 or 8 * 4 or 5 mm. With these data, the peak spatial-average SAR value can be calculated.

From the scanned SAR distribution, identify the position of the maximum SAR value, in addition identify the positions of any local maxima with SAR values within 2 dB of the maximum value that will not be within the zoom scan of other peaks; additional peaks shall be measured only when the primary peak is within 2 dB of the SAR compliance limit (e.g., 1 W/kg for 1,6 W/kg 1 g limit, or 1,26 W/kg for 2 W/kg, 10 g limit).

Area scan & Zoom scan scan parameters extracted from FCC KDB 865664 D01 SAR measurement 100 MHz to 6 GHz.

		≤ 3 GHz	> 3 GHz	
Maximum distance from closest measurement point (geometric center of probe sensors) to phantom surface		5 ± 1 mm	$\frac{1}{2} \cdot \delta \cdot \ln(2) \pm 0.5$ mm	
Maximum probe angle from probe axis to phantom surface normal at the measurement location		30° ± 1°	20° ± 1°	
Maximum area scan spatial resolution: Δx_{Area} , Δy_{Area}		≤ 2 GHz: ≤ 15 mm 2 – 3 GHz: ≤ 12 mm	3 – 4 GHz: ≤ 12 mm 4 – 6 GHz: ≤ 10 mm	
		When the x or y dimension of the test device, in the measurement plane orientation, is smaller than the above, the measurement resolution must be ≤ the corresponding x or y dimension of the test device with at least one measurement point on the test device.		
Maximum zoom scan spatial resolution: Δx_{Zoom} , Δy_{Zoom}		≤ 2 GHz: ≤ 8 mm 2 – 3 GHz: ≤ 5 mm*	3 – 4 GHz: ≤ 5 mm* 4 – 6 GHz: ≤ 4 mm*	
Maximum zoom scan spatial resolution, normal to phantom surface	uniform grid: $\Delta z_{Zoom}(n)$	≤ 5 mm	3 – 4 GHz: ≤ 4 mm 4 – 5 GHz: ≤ 3 mm 5 – 6 GHz: ≤ 2 mm	
	graded grid	$\Delta z_{Zoom}(1)$: between 1 st two points closest to phantom surface	≤ 4 mm	3 – 4 GHz: ≤ 3 mm 4 – 5 GHz: ≤ 2.5 mm 5 – 6 GHz: ≤ 2 mm
		$\Delta z_{Zoom}(n>1)$: between subsequent points	≤ 1.5 · $\Delta z_{Zoom}(n-1)$	
Minimum zoom scan volume	x, y, z	≥ 30 mm	3 – 4 GHz: ≥ 28 mm 4 – 5 GHz: ≥ 25 mm 5 – 6 GHz: ≥ 22 mm	

Note: δ is the penetration depth of a plane-wave at normal incidence to the tissue medium; see draft standard IEEE P1528-2011 for details.

* When zoom scan is required and the *reported* SAR from the *area scan based 1-g SAR estimation* procedures of KDB 447498 is ≤ 1.4 W/kg, ≤ 8 mm, ≤ 7 mm and ≤ 5 mm zoom scan resolution may be applied, respectively, for 2 GHz to 3 GHz, 3 GHz to 4 GHz and 4 GHz to 6 GHz.

3.3. Description of interpolation/extrapolation scheme

The local SAR inside the phantom is measured using small dipole sensing elements inside a probe body. The probe tip must not be in contact with the phantom surface in order to minimise measurements errors, but the highest local SAR will occur at the surface of the phantom.

An extrapolation is using to determinate this highest local SAR values. The extrapolation is based on a fourth-order least-square polynomial fit of measured data. The local SAR value is then extrapolated from the liquid surface with a 1 mm step.

The measurements have to be performed over a limited time (due to the duration of the battery) so the step of measurement is high. It could vary between 5 and 8 mm. To obtain an accurate assessment of the maximum SAR averaged over 10 grams and 1 gram requires a very fine resolution in the three dimensional scanned data array.

3.4. Volumetric Scan

The volumetric scan consists to a full 3D scan over a specific area. This 3D scan is useful form multi Tx SAR measurement. Indeed, it is possible with OpenSAR to add, point by point, several volumetric scan to calculate the SAR value of the combined measurement as it is define in the standard IEEE1528 and IEC62209.

3.5. Power Drift

All SAR testing is under the EUT install full charged battery and transmit maximum output power. In OpenSAR measurement software, the power reference measurement and power drift measurement procedures are used for monitoring the power drift of EUT during SAR test. Both these procedures measure the field at a specified reference position before and after the SAR testing. The software will calculate the field difference in V/m. If the power drifts more than $\pm 5\%$, the SAR will be retested.

4. System Verification Procedure

4.1. Tissue Verification

The following tissue formulations are provided for reference only as some of the parameters have not been thoroughly verified. The composition of ingredients may be modified accordingly to achieve the desired target tissue parameters required for routine SAR evaluation.

Ingredients (% of weight)	Head Tissue									
	750	835	900	1800	1900	2000	2450	2600	5200	5800
Frequency Band (MHz)										
Water	34.40	34.40	34.40	55.36	55.36	57.87	57.87	57.87	65.53	65.53
NaCl	0.79	0.79	0.79	0.35	0.35	0.16	0.16	0.16	0.00	0.00
1,2-Propanediol	64.81	64.81	64.81	0.00	0.00	0.00	0.00	0.00	0.00	0.00
Triton X-100	0.00	0.00	0.00	30.45	30.45	19.97	19.97	19.97	24.24	24.24
DGBE	0.00	0.00	0.00	13.84	13.84	22.00	22.00	22.00	10.23	10.23

For SAR measurement of the field distribution inside the phantom, the phantom must be filled with homogeneous tissue simulating liquid to a depth of at least 15 cm. For head SAR testing, the liquid depth from the ear reference point (ERP) of the phantom to the liquid top surface is larger than 15 cm.

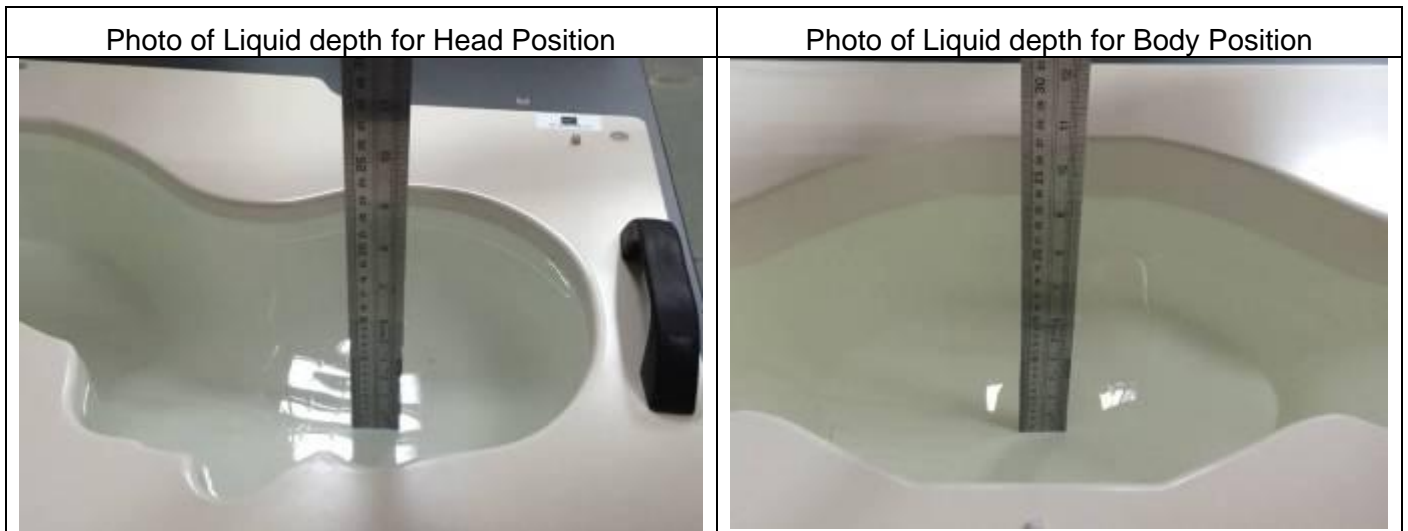

4.1.1. Tissue Dielectric Parameter Check Results

The simulating liquids should be checked at the beginning of a series of SAR measurements to determine of the dielectric parameter are within the tolerances of the specified target values. The measured conductivity and relative permittivity should be within $\pm 5\%$ of the target values.

Tissue Type	Measured Frequency (MHz)	Target Tissue		Measured Tissue		Liquid Temp.	Test Date
		ϵ_r ($\pm 5\%$)	σ (S/m) ($\pm 5\%$)	ϵ_r	σ (S/m)		
Head 750	750	41.96 (39.86~44.06)	0.89 (0.85~0.93)	41.07	0.90	21.7 °C	Apr. 19, 2024
Head 850	835	41.50 (39.43~43.58)	0.90 (0.86~0.95)	41.00	0.88	21.3 °C	Apr. 08, 2024
Head 1800	1800	40.00 (38.00~42.00)	1.40 (1.33~1.47)	39.20	1.40	21.3 °C	Apr. 10, 2024
Head 1900	1900	40.00 (38.00~42.00)	1.40 (1.33~1.47)	39.03	1.46	21.4 °C	Apr. 09, 2024
Head 2450	2450	39.20 (37.24~41.16)	1.80 (1.71~1.89)	37.67	1.76	21.8 °C	Apr. 12, 2024
Head 2600	2600	39.01 (37.06~40.96)	1.96 (1.86~2.06)	38.82	1.97	21.4 °C	Apr. 16, 2024
Head 3500	3500	37.93 (36.04~39.82)	2.91 (2.77~3.05)	37.88	2.81	21.0 °C	Apr. 07, 2024
Head 5200	5200	36.00 (34.20~37.80)	4.66 (4.43~4.89)	34.48	4.51	21.2 °C	Apr. 21, 2024
Head 5800	5800	35.30 (33.54~37.07)	5.27 (5.01~5.53)	33.91	5.16	21.1 °C	Apr. 20, 2024

NOTE: The dielectric parameters of the tissue-equivalent liquid should be measured under similar ambient conditions and within 2 °C of the conditions expected during the SAR evaluation to satisfy protocol requirements.

4.2. System Verification Procedure

The system verification is performed for verifying the accuracy of the complete measurement system and performance of the software. The dipole is connected to the signal source consisting of signal generator and amplifier via a directional coupler, N-connector cable and adaption to SMA. It is fed with a power of 100mW (below 5GHz) or 100mW (above 5GHz). To adjust this power a power meter is used. The power sensor is connected to the cable before the system verification to measure the power at this point and do adjustments at the signal generator. At the outputs of the directional coupler both return loss as well as forward power are controlled during the system verification to make sure that emitted power at the dipole is kept constant. This can also be checked by the power drift measurement after the test (result on plot).

The system verification is shown as below picture:

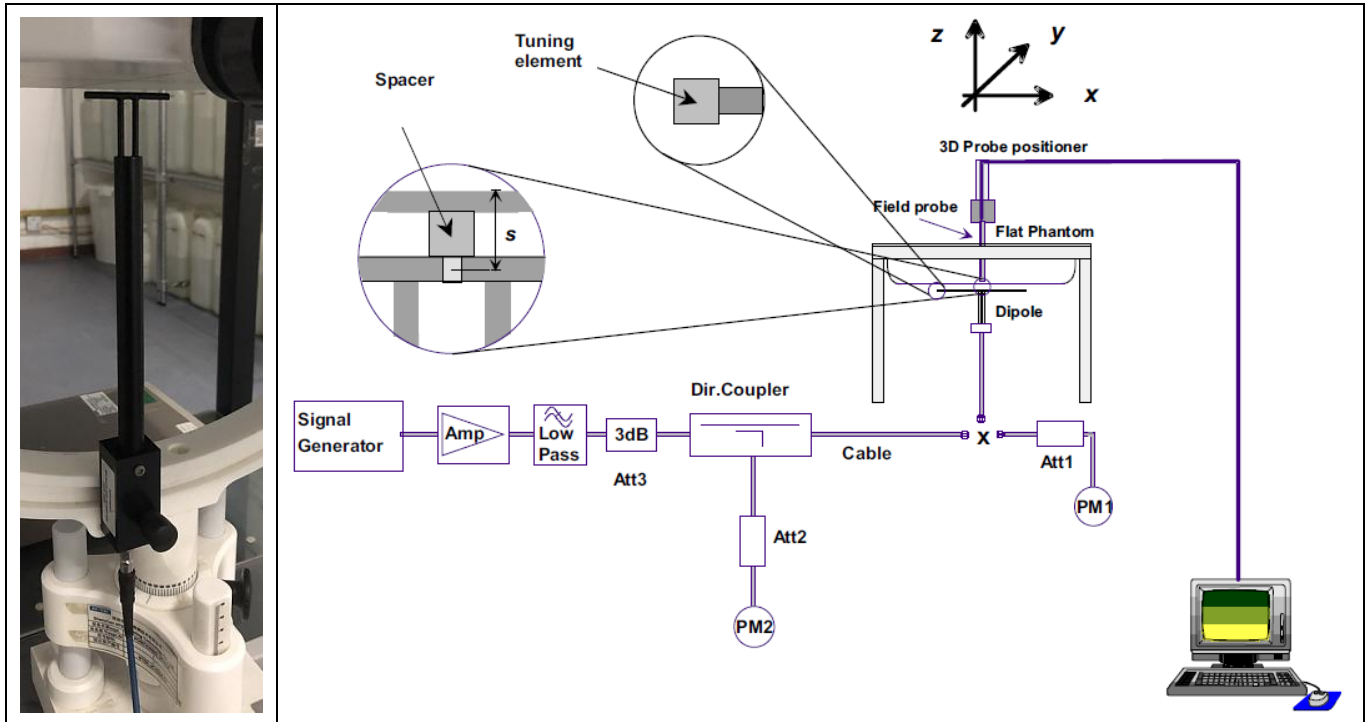

4.2.1. System Verification Results

Comparing to the original SAR value provided by SATIMO, the verification data should be within its specification of $\pm 10\%$. Below table shows the target SAR and measured SAR after normalized to 1W input power. The table below indicates the system performance verification can meet the variation criterion and the plots can be referred to Appendix B of this report.

System Verification	Target SAR (1W)		Measured SAR		Liquid Temp.	Test Date
	$(\pm 10\%)$		(Normalized to 1W)			
	1-g (W/Kg)	10-g (W/Kg)	1-g (W/Kg)	10-g (W/Kg)		
750MHz	8.60 (7.74~9.46)	5.78 (5.20~6.36)	8.34	5.85	21.7 °C	Apr. 19, 2024
835MHz	9.40 (8.46~10.34)	6.28 (5.65~6.91)	8.67	6.41	21.3 °C	Apr. 08, 2024
1800MHz	37.06 (33.35~40.77)	20.01 (18.01~22.01)	34.95	18.84	21.3 °C	Apr. 10, 2024
1900MHz	39.69 (35.72~43.66)	20.92 (18.83~23.01)	36.95	19.34	21.4 °C	Apr. 09, 2024
2450MHz	50.05 (45.05~55.06)	23.80 (21.42~26.18)	47.83	22.79	21.8 °C	Apr. 12, 2024
2600MHz	54.16 (48.74~59.58)	24.85 (22.37~27.34)	50.98	24.56	21.4 °C	Apr. 16, 2024
3500MHz	67.18 (60.47~73.89)	24.50 (22.05~26.95)	70.08	24.19	21.0 °C	Apr. 07, 2024
5200MHz	162.59 (146.33~178.85)	56.21 (50.59~61.83)	154.32	59.49	21.2 °C	Apr. 21, 2024
5800MHz	182.20 (163.98~200.42)	61.32 (55.19~67.45)	188.38	58.52	21.1 °C	Apr. 20, 2024

5. SAR Measurement variability and uncertainty

5.1. SAR measurement variability

Per KDB865664 D01 SAR measurement 100 MHz to 6 GHz, SAR measurement variability must be assessed for each frequency band, which is determined by the SAR probe calibration point and tissue-equivalent medium used for the device measurements. The additional measurements are repeated after the completion of all measurements requiring the same head or body tissue-equivalent medium in a frequency band. The test device should be returned to ambient conditions (normal room temperature) with the battery fully charged before it is re-mounted on the device holder for the repeated measurement(s) to minimize any unexpected variations in the repeated results.

- 1) Repeated measurement is not required when the original highest measured SAR is < 0.80 W/kg; steps 2) through 4) do not apply.
- 2) When the original highest measured SAR is ≥ 0.80 W/kg, repeat that measurement once.
- 3) Perform a second repeated measurement only if the ratio of largest to smallest SAR for the original and first repeated measurements is > 1.20 or when the original or repeated measurement is ≥ 1.45 W/kg (~ 10% from the 1-g SAR limit).
- 4) Perform a third repeated measurement only if the original, first or second repeated measurement is ≥ 1.5 W/kg and the ratio of largest to smallest SAR for the original, first and second repeated measurements is > 1.20 .

5.2. SAR measurement uncertainty

Per KDB865664 D01 SAR Measurement 100 MHz to 6 GHz, when the highest measured 1-g SAR within a frequency band is < 1.5 W/kg, the extensive SAR measurement uncertainty analysis described in IEEE Std 1528-2013 is not required in SAR reports submitted for equipment approval. The equivalent ratio (1.5/1.6) is applied to extremity and occupational exposure conditions.

6. RF Exposure Positions

6.1. Ear and handset reference point

Figure 6.1.1 shows the front, back, and side views of the SAM phantom. The center-of-mouth reference point is labeled “M”, the left ear reference point (ERP) is marked “LE”, and the right ERP is marked “RE”.



Fig 6.1.1 Front, back, and side views of SAM phantom

6.2. Definition of the cheek position

1. Define two imaginary lines on the handset, the vertical centerline and the horizontal line. The vertical centerline passes through two points on the front side of the handset: the midpoint of the width w_t of the handset at the level of the acoustic output (point A in Figure 6.2.1 and Figure 6.2.2), and the midpoint of the width w_b of the bottom of the handset (point B). The horizontal line is perpendicular to the vertical centerline and passes through the center of the acoustic output (see Figure 6.2.1). The two lines intersect at point A. Note that for many handsets, point A coincides with the center of the acoustic output; however, the acoustic output may be located elsewhere on the horizontal line. Also note that the vertical centerline is not necessarily parallel to the front face of the handset (see Figure 6.2.2), especially for clamshell handsets, handsets with flip covers, and other irregularly-shaped handsets.
2. Position the handset close to the surface of the phantom such that point A is on the (virtual) extension of the line passing through points RE and LE on the phantom (see Figure 6.2.3), such that the plane defined by the vertical centerline and the horizontal line of the handset is approximately parallel to the sagittal plane of the phantom.
3. Translate the handset towards the phantom along the line passing through RE and LE until handset point A touches the pinna at the ERP
4. While maintaining the handset in this plane, rotate it around the LE-RE line until the vertical centerline is in the plane normal to the plane containing B-M and N-F lines, i.e., the Reference Plane.
5. Rotate the handset around the vertical centerline until the handset (horizontal line) is parallel to the N-F line.

6. While maintaining the vertical centerline in the Reference Plane, keeping point A on the line passing through RE and LE, and maintaining the handset contact with the pinna, rotate the handset about the N-F line until any point on the handset is in contact with a phantom point below the pinna on the cheek. See Figure 6.2.3. The actual rotation angles should be documented in the test report.

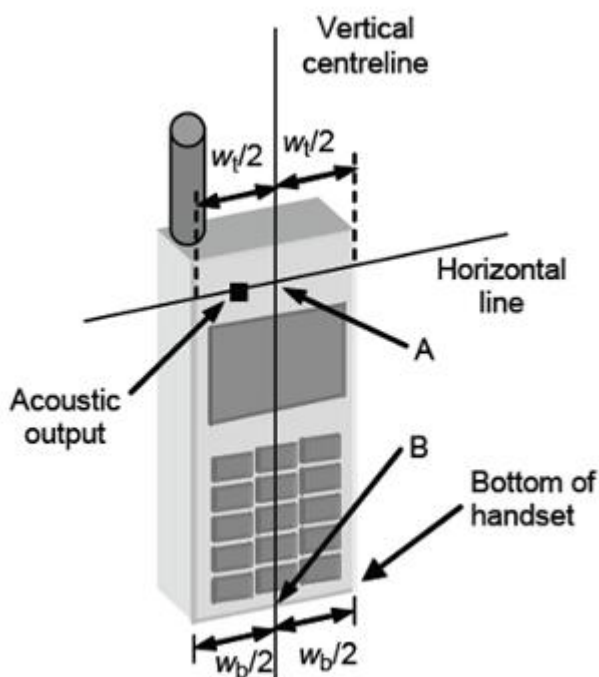

Fig 6.2.1 Handset vertical and horizontal reference lines—"fixed case"

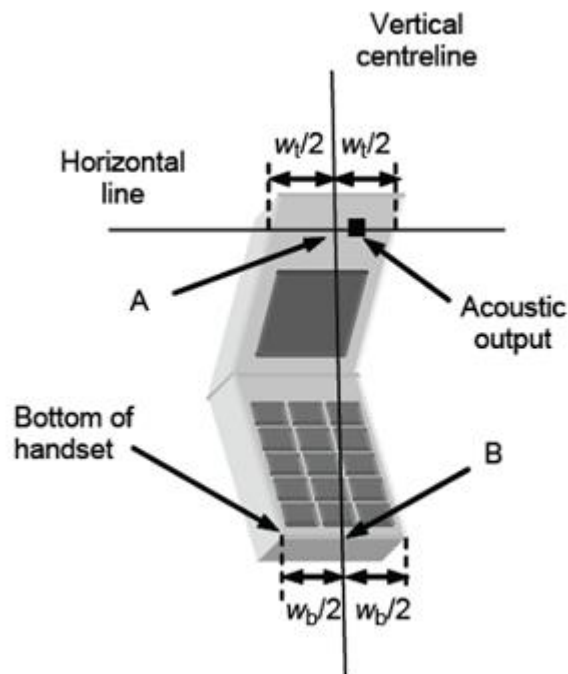

Fig 6.2.2 Handset vertical and horizontal reference lines—"clam-shell case"

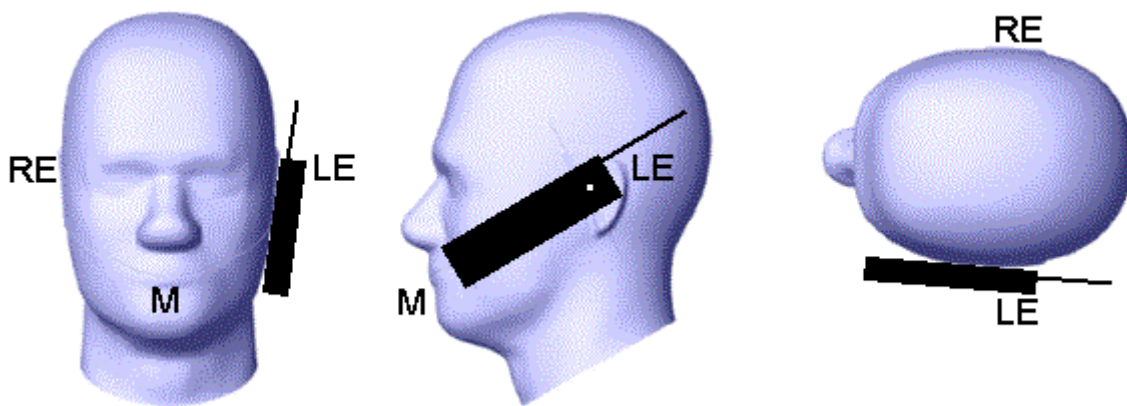

Fig 6.2.3 cheek or touch position. The reference points for the right ear (RE), left ear (LE), and mouth (M), which establish the Reference Plane for handset positioning, are indicated.

6.3. Definition of the tilt position

1. While maintaining the orientation of the handset, retract the handset parallel to the reference plane far enough away from the phantom to enable a rotation of the device by 15 degree.
2. Rotate the Handset around the horizontal line by 15 degree (see Figure 6.3.1).
3. While maintaining the orientation of the handset, move the handset towards the phantom on a line passing through RE and LE until any part of the handset touches the ear. The tilt position is obtained when the contact is on the pinna. If the contact is at any location other than the pinna, e.g., the antenna with the back of the phantom head, the angle of the handset shall be reduced. In this case, the tilt position is obtained if any part of the handset is in contact with the pinna as well as a second part of the handset is in contact with the phantom, e.g., the antenna with the back of the head.

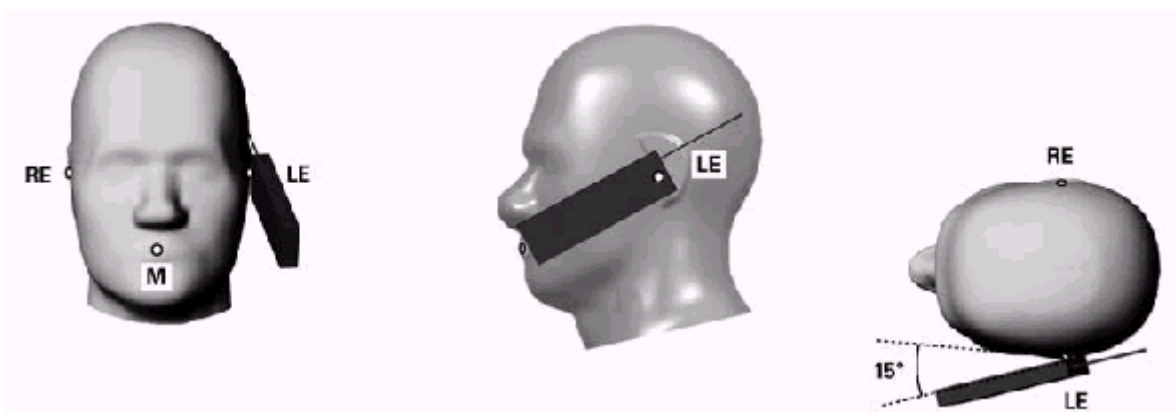

Figure 6.3.1 – Tilt position of the wireless device on the left side of SAM

6.4. Body Worn Accessory

1. Body-worn operating configurations are tested with the belt-clips and holsters attached to the device and positioned against a flat phantom in a normal use configuration (see Figure 6.4.1). Per KDB 648474 D04, body-worn accessory exposure is typically related to voice mode operations when handsets are carried in body-worn accessories. The body-worn accessory procedures in FCC KDB 447498 D01 should be used to test for body-worn accessory SAR compliance, without a headset connected to it. This enables the test results for such configuration to be compatible with that required for hotspot mode when the body-worn accessory test separation distance is greater than or equal to that required for hotspot mode, when applicable. When the reported SAR for body-worn accessory, measured without a headset connected to the handset is < 1.2 W/kg, the highest reported SAR configuration for that wireless mode and frequency band should be repeated for that body-worn accessory with a headset attached to the handset.
2. Accessories for body-worn operation configurations are divided into two categories: those that do not contain metallic components and those that do contain metallic components and those that do contain metallic components. When multiple accessories that do not contain metallic components are supplied with the device, the device is tested with only the accessory that dictates the closest

spacing to the body. Then multiple accessories that contain metallic components are tested with the device with each accessory. If multiple accessories share an identical metallic component (i.e. the same metallic belt-clip used with different holsters with no other metallic components) only the accessory that dictates the closest spacing to the body is tested.

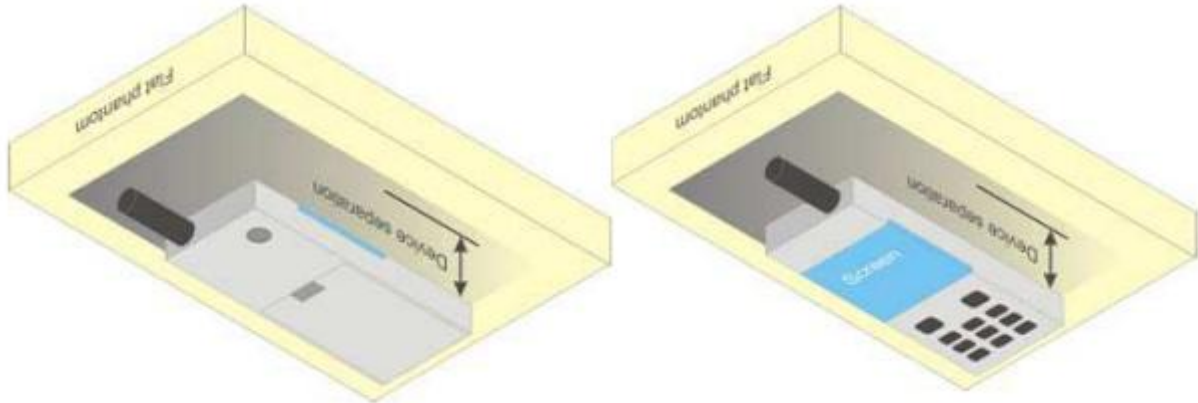

Figure 6.4.1 – Test positions for body-worn devices

6.5. Wireless Router Devices

Some battery-operated handsets have the capability to transmit and receive user through simultaneous transmission of WLAN simultaneously with a separate licensed transmitter. The FCC has provided guidance in FCC KDB Publication 941225 D06 where SAR test considerations for handsets ($L \times W \geq 9 \text{ cm} \times 5 \text{ cm}$) are based on a composite test separation distance of 10mm from the front, back and edges of the device containing transmitting antennas within 2.5cm of their edges, determined from general mixed use conditions for this type of devices. Since the hotspot SAR results may overlap with the body-worn accessory SAR requirements, the more conservative configurations can be considered, thus excluding some body-worn accessory SAR tests.

When the user enables the personal wireless router functions for the handset, actual operations include simultaneous transmission of both the WLAN transmitter and another licensed transmitter. Both transmitters often do not transmit at the same transmitting frequency and thus cannot be evaluated for SAR under actual use conditions due to the limitations of the SAR assessment probes. Therefore, SAR must be evaluated for each frequency transmission and mode separately and spatially summed with the WLAN transmitter according to FCC KDB Publication 447498 D01 publication procedures. The “Portable Hotspot” feature on the handset was NOT activated during SAR assessments, to ensure the SAR measurements were evaluated for a single transmission frequency RF signal at a time.

7. RF Output Power

7.1. GSM Conducted Power

Band GSM850	Burst-Averaged output Power (dBm)				Frame-Averaged output Power (dBm)			
Tx Channel	Tune-up	128	189	251	Tune-up	128	189	251
Frequency (MHz)	(dBm)	824.2	836.4	848.8	(dBm)	824.2	836.4	848.8
GSM (GMSK)	32.50	32.27	32.41	32.23	23.47	23.24	23.38	23.20
GPRS(GMSK,1 Tx slot)	32.50	32.26	32.40	32.22	23.47	23.23	23.37	23.19
GPRS(GMSK,2 Tx slot)	31.50	31.27	31.24	31.21	25.48	25.25	25.22	25.19
GPRS(GMSK,3 Tx slot)	29.50	29.26	29.39	29.21	25.24	25.00	25.13	24.95
GPRS(GMSK,4 Tx slot)	28.50	28.11	28.23	28.00	25.49	25.10	25.22	24.99
EGPRS(8PSK,1 Tx slot)	27.00	26.52	26.40	26.70	17.97	17.49	17.37	17.67
EGPRS(8PSK,2 Tx slot)	26.00	25.58	25.53	25.72	19.98	19.56	19.51	19.70
EGPRS(8PSK,3 Tx slot)	24.00	23.43	23.64	23.50	19.74	19.17	19.38	19.24
EGPRS(8PSK,4 Tx slot)	23.00	22.47	22.32	22.63	19.99	19.46	19.31	19.62
Band GSM1900	Burst-Averaged output Power (dBm)				Frame-Averaged output Power (dBm)			
Tx Channel	Tune-up	512	661	810	Tune-up	512	661	810
Frequency (MHz)	(dBm)	1850.2	1880	1909.8	(dBm)	1850.2	1880	1909.8
GSM (GMSK)	30.00	29.49	29.63	29.79	20.97	20.46	20.60	20.76
GPRS(GMSK,1 Tx slot)	30.00	29.35	29.54	29.69	20.97	20.32	20.51	20.66
GPRS(GMSK,2 Tx slot)	29.00	28.47	28.62	28.82	22.98	22.45	22.60	22.80
GPRS(GMSK,3 Tx slot)	27.00	26.57	26.66	26.94	22.74	22.31	22.40	22.68
GPRS(GMSK,4 Tx slot)	26.00	25.27	25.44	25.67	22.99	22.26	22.43	22.66
EGPRS(8PSK,1 Tx slot)	26.50	25.87	26.28	26.39	17.47	16.84	17.25	17.36
EGPRS(8PSK,2 Tx slot)	25.50	25.24	24.80	25.19	19.48	19.22	18.78	19.17
EGPRS(8PSK,3 Tx slot)	24.00	22.73	22.62	23.52	19.74	18.47	18.36	19.26
EGPRS(8PSK,4 Tx slot)	22.00	21.67	21.88	21.95	18.99	18.66	18.87	18.94

7.2. WCDMA Conducted Power

WCDMA Band 2	Burst-Averaged output Power (dBm)			
Tx Channel	Tune-up	9262	9400	9538
Frequency (MHz)	(dBm)	1852.4	1880	1907.6
RMC12.2K	24.00	23.82	23.80	23.56
HSDPA Sub 1	23.00	22.87	22.85	22.86
HSDPA Sub 2	22.50	22.24	22.48	22.41

HSDPA Sub 3	21.50	21.41	20.99	21.38
HSDPA Sub 4	21.50	21.36	21.33	21.03
HSUPA Sub 1	23.00	21.90	22.62	22.62
HSUPA Sub 2	23.00	22.67	22.73	22.73
HSUPA Sub 3	22.00	21.37	21.57	21.52
HSUPA Sub 4	23.00	22.82	22.81	22.80
HSUPA Sub 5	22.50	21.51	22.16	22.28
WCDMA Band 4	Burst-Averaged output Power (dBm)			
Tx Channel	Tune-up (dBm)	1312	1413	1513
Frequency (MHz)		1712.4	1732.6	1752.6
RMC12.2K	23.50	23.25	23.08	23.32
HSDPA Sub 1	22.50	22.31	22.13	22.37
HSDPA Sub 2	22.50	21.87	21.88	22.01
HSDPA Sub 3	21.00	20.97	20.88	20.71
HSDPA Sub 4	21.50	20.87	20.83	21.09
HSUPA Sub 1	22.50	21.61	21.94	22.25
HSUPA Sub 2	22.50	22.26	22.01	22.13
HSUPA Sub 3	21.50	20.58	20.79	21.25
HSUPA Sub 4	22.50	22.28	22.09	22.35
HSUPA Sub 5	22.00	20.52	21.36	21.73
WCDMA Band 5	Burst-Averaged output Power (dBm)			
Tx Channel	Tune-up (dBm)	4132	4182	4233
Frequency (MHz)		826.4	836.4	846.6
RMC12.2K	24.00	23.60	23.52	23.52
HSDPA Sub 1	23.00	22.62	22.56	22.57
HSDPA Sub 2	22.50	22.04	22.13	22.20
HSDPA Sub 3	21.50	20.97	21.11	21.11
HSDPA Sub 4	21.50	21.35	20.87	21.29
HSUPA Sub 1	22.50	21.68	22.39	22.44
HSUPA Sub 2	23.00	22.53	22.53	22.46
HSUPA Sub 3	21.50	20.79	21.29	21.33
HSUPA Sub 4	23.00	22.65	22.57	22.59
HSUPA Sub 5	22.00	21.31	21.92	21.88

7.3. LTE Conducted Power

Band	Band Width	Modulation	RB Configuration		Tune-up (dBm)	Channel/Frequency(MHz)		
			RB Size	RB Offset		18607/1850.7	18900/1880	19193/1909.3
LTE Band 2	1.4MHz	QPSK	1	0	21.50	21.07	21.32	21.34
			1	2	21.50	21.03	21.29	21.36
			1	5	21.50	21.03	21.30	21.31
			3	0	21.50	21.08	21.25	21.31
			3	1	21.50	21.06	21.23	21.31
			3	2	21.50	21.08	21.19	21.32
		16QAM	6	0	20.50	20.05	20.25	20.33
			1	0	21.00	20.34	20.61	20.54
			1	2	21.00	20.29	20.46	20.55
			1	5	21.00	20.34	20.55	20.65
			3	0	20.50	20.06	20.19	20.30
			3	1	20.50	20.05	20.15	20.28
			3	2	20.50	20.06	20.23	20.36
			6	0	19.50	19.20	19.38	19.47
Band	Band Width	Modulation	RB Configuration		Tune-up (dBm)	Channel/Frequency(MHz)		
			RB Size	RB Offset		18615/1851.5	18900/1880	19185/1908.5
LTE Band 2	3MHz	QPSK	1	0	21.50	21.00	21.22	21.35
			1	7	21.50	20.98	21.27	21.31
			1	14	21.50	20.99	21.27	21.30
			8	0	20.50	20.06	20.21	20.36
			8	4	20.50	20.06	20.25	20.33
			8	7	20.50	20.07	20.25	20.34
			15	0	20.50	20.08	20.26	20.37
		16QAM	1	0	21.00	20.29	20.50	20.62
			1	7	21.00	20.33	20.57	20.58
			1	14	21.00	20.34	20.55	20.56
			8	0	19.50	19.13	19.29	19.48
			8	4	19.50	19.14	19.32	19.46
			8	7	19.50	19.15	19.32	19.44
			15	0	19.50	19.10	19.31	19.40
Band	Band	Modulation	RB		Tune-up	Channel/Frequency(MHz)		

	Width	Configuration	Configuration		(dBm)			
			RB Size	RB Offset		18625/1852.5	18900/1880	19175/1907.5
LTE Band 2	5MHz	QPSK	1	0	21.50	21.13	21.34	21.46
			1	12	21.50	21.04	21.32	21.40
			1	24	21.50	21.11	21.30	21.39
			12	0	20.50	20.13	20.29	20.43
			12	6	20.50	20.11	20.29	20.44
			12	11	20.50	20.11	20.30	20.40
			25	0	20.50	20.12	20.32	20.45
		16QAM	1	0	21.00	20.33	20.61	20.72
			1	12	21.00	20.32	20.66	20.62
			1	24	21.00	20.37	20.54	20.70
			12	0	19.50	19.13	19.27	19.46
			12	6	19.50	19.13	19.30	19.45
			12	11	19.50	19.08	19.34	19.46
			25	0	19.50	19.13	19.33	19.46
Band	Band Width	Modulation	RB Configuration		Tune-up (dBm)	Channel/Frequency(MHz)		
			RB Size	RB Offset		18650/1855	18900/1880	19150/1905
LTE Band 2	10MHz	QPSK	1	0	21.50	21.12	21.26	21.47
			1	24	21.50	21.01	21.32	21.48
			1	49	21.50	21.09	21.30	21.41
			25	0	20.50	20.11	20.31	20.47
			25	12	20.50	20.08	20.30	20.46
			25	24	20.50	20.12	20.29	20.49
			50	0	21.00	20.11	20.28	20.50
		16QAM	1	0	21.00	20.37	20.70	20.84
			1	24	21.00	20.32	20.70	20.63
			1	49	21.00	20.36	20.53	20.63
			25	0	20.00	19.09	19.28	19.46
			25	12	20.00	19.07	19.30	19.47
			25	24	20.00	19.11	19.32	19.50
			50	0	19.50	19.13	19.28	19.49
Band	Band Width	Modulation	RB Configuration		Tune-up (dBm)	Channel/Frequency(MHz)		
			RB Size	RB Offset		18675/1857.5	18900/1880	19125/1902.5
LTE	15MHz	QPSK	1	0	21.50	21.10	21.28	21.40

Band 2			1	37	21.50	21.09	21.37	21.47
			1	74	21.50	21.18	21.25	21.41
			36	0	21.00	20.10	20.29	20.47
			36	18	21.00	20.13	20.32	20.50
			36	37	21.00	20.16	20.27	20.51
			75	0	20.50	20.13	20.27	20.46
			1	0	21.00	20.48	20.59	20.70
		16QAM	1	37	21.00	20.39	20.76	20.74
			1	74	21.00	20.56	20.48	20.70
			36	0	19.50	19.11	19.27	19.43
			36	18	19.50	19.13	19.31	19.45
			36	37	19.50	19.14	19.28	19.48
			75	0	19.50	19.13	19.27	19.46
			Band	Band Width	Modulation	RB Configuration		Tune-up (dBm)
RB Size	RB Offset	18700/1860				18900/1880	19100/1900	
LTE Band 2	20MHz	QPSK	1	0	21.50	21.13	21.25	21.37
			1	49	21.50	21.10	21.38	21.47
			1	99	21.50	21.27	21.25	21.46
			50	0	21.00	20.13	20.30	20.51
			50	24	21.00	20.19	20.33	20.51
			50	49	21.00	20.20	20.33	20.56
			100	0	21.00	20.17	20.30	20.54
		16QAM	1	0	21.00	20.34	20.61	20.63
			1	49	21.00	20.35	20.77	20.81
			1	99	21.00	20.68	20.48	20.81
			50	0	20.00	19.12	19.30	19.52
			50	24	20.00	19.18	19.31	19.51
			50	49	20.00	19.23	19.32	19.53
			100	0	20.00	19.18	19.29	19.52

Band	Band Width	Modulation	RB Configuration		Tune-up (dBm)	Channel/Frequency(MHz)		
			RB Size	RB Offset		19957/1710.7	20175/1732.5	20393/1754.3
LTE Band 4	1.4MHz	QPSK	1	0	23.50	22.99	22.87	22.99
			1	2	23.50	22.97	22.87	23.02
			1	5	23.50	22.94	22.97	22.99
			3	0	23.00	22.92	22.88	22.98

Band	Band Width	Modulation	RB Configuration		Tune-up (dBm)	Channel/Frequency(MHz)		
			RB Size	RB Offset		19965/1711.5	20175/1732.5	20385/1753.5
		16QAM	3	1	23.00	22.91	22.88	22.94
			3	2	23.00	22.95	22.94	22.98
			6	0	22.50	21.90	21.91	22.01
			1	0	22.50	22.22	22.18	22.32
			1	2	22.50	22.14	22.13	22.33
			1	5	22.50	22.22	22.28	22.41
			3	0	22.00	21.85	21.98	21.99
			3	1	22.00	21.85	21.86	21.98
			3	2	22.00	21.82	21.86	21.93
			6	0	21.50	21.01	21.05	21.08
Band	Band Width	Modulation	RB Configuration		Tune-up (dBm)	Channel/Frequency(MHz)		
			RB Size	RB Offset		19975/1712.5	20175/1732.5	20375/1752.5
LTE Band 4	3MHz	QPSK	1	0	23.00	22.95	22.96	22.89
			1	7	23.00	22.87	22.86	22.93
			1	14	23.00	22.87	22.94	22.98
			8	0	22.50	21.90	21.90	22.00
			8	4	22.50	21.91	21.90	22.02
			8	7	22.50	21.88	21.88	22.00
			15	0	22.00	21.89	21.89	22.00
		16QAM	1	0	22.50	22.12	22.11	22.17
			1	7	22.50	22.27	22.30	22.30
			1	14	22.50	22.30	22.23	22.28
			8	0	21.50	21.02	20.96	21.02
			8	4	21.50	20.97	20.99	21.05
			8	7	21.50	20.94	20.95	21.05
			15	0	21.50	20.92	20.96	21.01
Band	Band Width	Modulation	RB Configuration		Tune-up (dBm)	Channel/Frequency(MHz)		
			RB Size	RB Offset		19975/1712.5	20175/1732.5	20375/1752.5
LTE Band 4	5MHz	QPSK	1	0	23.50	22.99	22.96	22.95
			1	12	23.50	22.95	22.92	22.98
			1	24	23.50	22.91	23.01	23.06
			12	0	22.50	21.95	21.97	22.01
			12	6	22.50	21.91	21.97	22.02
			12	11	22.50	21.91	21.97	22.03
			25	0	22.50	21.95	21.96	22.01
		16QAM	1	0	22.50	22.23	22.29	22.41

Band	Band Width	Modulation	RB Configuration		Tune-up (dBm)	Channel/Frequency(MHz)		
			RB Size	RB Offset		20000/1715	20175/1732.5	20350/1750
			1	12	22.50	22.30	22.14	22.25
			1	24	22.50	22.31	22.26	22.35
			12	0	21.50	20.91	21.00	21.05
			12	6	21.50	20.97	20.99	21.00
			12	11	21.50	20.93	20.99	21.09
			25	0	21.50	20.96	20.97	21.03
LTE Band 4	10MHz	QPSK	1	0	23.50	22.98	22.95	22.90
			1	24	23.50	22.87	22.96	22.97
			1	49	23.50	22.91	22.99	23.06
			25	0	22.50	21.92	21.95	22.01
			25	12	22.50	21.91	21.96	22.02
			25	24	22.50	21.89	21.97	22.02
		16QAM	50	0	22.50	21.94	21.97	22.03
			1	0	23.00	22.30	22.37	22.29
			1	24	23.00	22.18	22.30	22.30
			1	49	23.00	22.32	22.27	22.53
			25	0	21.50	20.94	20.94	20.99
			25	12	21.50	20.92	20.96	20.99
			25	24	21.50	20.89	20.97	21.03
			50	0	21.50	20.92	20.95	21.01
			RB Configuration		Tune-up (dBm)	Channel/Frequency(MHz)		
			RB Size	RB Offset		20025/1717.5	20175/1732.5	20325/1747.5
LTE Band 4	15MHz	QPSK	1	0	23.50	23.00	22.93	22.96
			1	37	23.50	22.92	23.04	23.02
			1	74	23.50	23.00	23.05	23.07
			36	0	22.50	21.92	21.95	21.97
			36	18	22.50	21.92	21.99	22.02
			36	37	22.50	21.93	22.00	22.04
			75	0	22.50	21.94	21.97	22.01
		16QAM	1	0	22.50	22.38	22.39	22.23
			1	37	22.50	22.14	22.27	22.38
			1	74	22.50	22.38	22.32	22.45
			36	0	21.00	20.91	20.92	20.95
			36	18	21.00	20.90	20.98	20.98

Band	Band Width	Modulation	RB Configuration		Tune-up (dBm)	Channel/Frequency(MHz)		
			RB Size	RB Offset		20050/1720	20175/1732.5	20300/1745
			36	37		21.00	20.94	21.00
75	0	21.50	20.94	20.96	21.02			
LTE Band 4	20MHz	QPSK	1	0	23.50	22.90	22.88	22.90
			1	49	23.50	22.93	22.99	23.01
			1	99	23.50	23.01	22.97	23.07
			50	0	22.50	21.95	21.96	22.04
			50	24	22.50	21.95	22.03	22.05
			50	49	22.50	22.05	22.04	22.04
			100	0	22.50	21.99	21.98	22.02
		16QAM	1	0	22.50	22.23	22.25	22.23
			1	49	22.50	22.29	22.41	22.25
			1	99	22.50	22.43	22.33	22.23
			50	0	21.50	20.94	20.94	21.04
			50	24	21.50	20.94	21.01	21.05
			50	49	21.50	21.05	21.02	21.05
			100	0	21.50	21.00	20.97	21.02

Band	Band Width	Modulation	RB Configuration		Tune-up (dBm)	Channel/Frequency(MHz)		
			RB Size	RB Offset		20407/824.7	20525/836.5	20643/848.3
			1	0		23.50	22.99	23.12
1	2	23.50	22.98	23.11	22.90			
1	5	23.50	23.02	23.09	22.97			
3	0	23.50	22.95	23.09	22.96			
3	1	23.50	23.02	23.06	22.91			
3	2	23.50	23.02	23.10	22.94			
6	0	22.50	21.96	22.12	21.91			
LTE Band 5	1.4MHz	QPSK	1	0	22.50	22.21	22.49	22.26
			1	2	22.50	22.27	22.42	22.25
			1	5	22.50	22.28	22.35	22.13
			3	0	22.50	21.92	22.14	21.94
			3	1	22.50	21.96	22.02	21.86
			3	2	22.50	21.89	22.07	21.96
			6	0	21.50	21.07	21.21	21.07
Band	Band	Modulation	RB		Tune-up	Channel/Frequency(MHz)		

	Width		Configuration		(dBm)			
			RB Size	RB Offset		20415/825.5	20525/836.5	20635/847.5
LTE Band 5	3MHz	QPSK	1	0	23.50	22.98	23.15	22.97
			1	7	23.50	23.02	23.15	22.91
			1	14	23.50	23.01	23.13	22.94
			8	0	22.50	21.96	22.11	22.10
			8	4	22.50	21.96	22.13	22.00
			8	7	22.50	21.98	22.13	21.97
			15	0	22.50	22.00	22.13	21.97
		16QAM	1	0	22.50	22.34	22.44	22.21
			1	7	22.50	22.31	22.41	22.30
			1	14	22.50	22.28	22.49	22.13
			8	0	21.50	21.03	21.22	21.13
			8	4	21.50	21.07	21.17	20.99
			8	7	21.50	21.04	21.17	20.99
			15	0	21.50	21.03	21.16	21.01
Band	Band Width	Modulation	RB Configuration		Tune-up (dBm)	Channel/Frequency(MHz)		
			RB Size	RB Offset		20425/826.5	20525/836.5	20625/846.5
LTE Band 5	5MHz	QPSK	1	0	23.50	23.04	23.16	23.07
			1	12	23.50	23.03	23.17	23.01
			1	24	23.50	23.08	23.17	22.98
			12	0	22.50	22.03	22.18	22.11
			12	6	22.50	22.05	22.16	22.04
			12	11	22.50	22.05	22.12	21.92
			25	0	22.50	22.06	22.17	22.08
		16QAM	1	0	23.00	22.41	22.52	22.37
			1	12	23.00	22.35	22.48	22.37
			1	24	23.00	22.28	22.51	22.19
			12	0	21.50	21.10	21.23	21.13
			12	6	21.50	21.08	21.20	21.09
			12	11	21.50	21.10	21.13	20.95
			25	0	21.50	21.08	21.19	21.09
Band	Band Width	Modulation	RB Configuration		Tune-up (dBm)	Channel/Frequency(MHz)		
			RB Size	RB Offset		20450/829	20525/836.5	20600/844
LTE	10MHz	QPSK	1	0	23.50	23.08	23.15	23.18

Band 5		1	24	23.50	23.05	23.14	23.04
		1	49	23.50	23.15	23.14	22.99
		25	0	22.50	22.03	22.16	22.07
		25	12	22.50	22.06	22.14	22.07
		25	24	22.50	22.09	22.10	21.97
		50	0	22.50	22.06	22.15	22.06
	16QAM	1	0	23.00	22.34	22.39	22.47
		1	24	23.00	22.29	22.51	22.28
		1	49	23.00	22.45	22.45	22.26
		25	0	21.50	21.01	21.19	21.06
		25	12	21.50	21.10	21.14	21.08
		25	24	21.50	21.11	21.11	21.00
		50	0	21.50	21.08	21.15	21.03

Band	Band Width	Modulation	RB Configuration		Tune-up (dBm)	Channel/Frequency(MHz)		
			RB Size	RB Offset		20775/2502.5	21100/2535	21425/2567.5
LTE Band 7	5MHz	QPSK	1	0	23.00	22.76	22.90	22.97
			1	12	23.00	22.81	22.87	22.90
			1	24	23.00	22.80	22.95	22.98
			12	0	22.50	21.80	21.98	22.00
			12	6	22.50	21.81	21.96	22.03
			12	11	22.50	21.84	22.02	22.03
		16QAM	25	0	22.50	21.86	22.00	22.04
			1	0	22.50	22.04	22.19	22.23
			1	12	22.50	22.06	22.11	22.28
			1	24	22.50	22.04	22.16	22.15
			12	0	21.50	20.83	21.01	21.04
			12	6	21.50	20.87	21.00	21.00
			12	11	21.50	20.88	21.01	21.06
			25	0	21.50	20.88	21.02	21.05
Band	Band Width	Modulation	RB Configuration		Tune-up (dBm)	Channel/Frequency(MHz)		
			RB Size	RB Offset		20800/2505	21100/2535	21400/2565
LTE Band 7	10MHz	QPSK	1	0	23.00	22.82	22.91	23.00
			1	24	23.00	22.81	22.91	22.90
			1	49	23.00	22.84	22.98	22.92
			25	0	22.50	21.85	21.96	22.04

			25	12	22.50	21.90	22.00	22.04	
			25	24	22.50	21.88	22.08	22.07	
			50	0	22.50	21.90	22.03	22.05	
		16QAM	1	0	22.50	22.16	22.29	22.26	
			1	24	22.50	22.09	22.24	22.33	
			1	49	22.50	22.09	22.25	22.18	
			25	0	21.50	20.92	20.95	21.05	
			25	12	21.50	20.89	21.01	21.03	
			25	24	21.50	20.89	21.09	21.08	
			50	0	21.50	20.87	21.05	21.06	
Band	Band Width		Modulation	RB Configuration		Tune-up (dBm)	Channel/Frequency(MHz)		
				RB Size	RB Offset		20825/2507.5	21100/2535	21375/2562.5
LTE Band 7	15MHz	QPSK	1	0	23.50	22.79	22.93	22.91	
			1	37	23.50	22.91	23.06	22.98	
			1	74	23.50	22.90	22.97	23.00	
			36	0	22.50	21.91	21.96	22.01	
			36	18	22.50	21.90	22.04	22.02	
			36	37	22.50	21.87	22.12	22.07	
			75	0	22.50	21.91	22.03	22.05	
		16QAM	1	0	22.50	22.06	22.26	22.20	
			1	37	22.50	22.22	22.38	22.28	
			1	74	22.50	22.20	22.21	22.15	
			36	0	21.50	20.92	20.95	21.03	
			36	18	21.50	20.94	21.03	21.02	
			36	37	21.50	20.87	21.10	21.05	
			75	0	21.50	20.94	21.04	21.07	
Band	Band Width	Modulation	RB Configuration		Tune-up (dBm)	Channel/Frequency(MHz)			
			RB Size	RB Offset		20850/2510	21100/2535	21350/2560	
LTE Band 7	20MHz	QPSK	1	0	23.50	22.81	22.91	22.96	
			1	49	23.50	22.94	23.04	23.01	
			1	99	23.50	22.78	22.97	23.00	
			50	0	22.50	21.97	21.96	22.08	
			50	24	22.50	21.97	22.11	22.07	
			50	49	22.50	21.87	22.13	22.11	
			100	0	22.50	21.95	22.06	22.08	
		16QAM	1	0	22.50	22.03	22.20	22.20	

			1	49	22.50	22.24	22.29	22.20
			1	99	22.50	22.16	22.32	22.21
			50	0	21.50	20.99	20.96	21.08
			50	24	21.50	20.99	21.11	21.05
			50	49	21.50	20.91	21.16	21.09
			100	0	21.50	20.96	21.11	21.10

Band	Band Width	Modulation	RB Configuration		Tune-up (dBm)	Channel/Frequency(MHz)		
			RB Size	RB Offset		23017/699.7	23095/707.5	23173/715.3
LTE Band 12	1.4MHz	QPSK	1	0	23.00	22.90	22.59	22.58
			1	2	23.00	22.80	22.57	22.56
			1	5	23.00	22.89	22.56	22.58
			3	0	23.00	22.89	22.57	22.59
			3	1	23.00	22.89	22.58	22.60
			3	2	23.00	22.91	22.56	22.60
			6	0	22.00	21.87	21.62	21.64
		16QAM	1	0	22.50	22.01	21.89	21.94
			1	2	22.50	22.07	21.92	21.89
			1	5	22.50	22.04	21.81	21.87
			3	0	22.00	21.80	21.55	21.55
			3	1	22.00	21.81	21.64	21.66
			3	2	22.00	21.86	21.51	21.62
			6	0	21.00	20.95	20.73	20.71

Band	Band Width	Modulation	RB Configuration		Tune-up (dBm)	Channel/Frequency(MHz)		
			RB Size	RB Offset		23025/700.5	23095/707.5	23165/714.5
LTE Band 12	3MHz	QPSK	1	0	23.00	22.88	22.62	22.56
			1	7	23.00	22.81	22.59	22.56
			1	14	23.00	22.86	22.57	22.61
			8	0	22.00	21.83	21.64	21.68
			8	4	22.00	21.84	21.67	21.60
			8	7	22.00	21.83	21.60	21.58
			15	0	22.00	21.87	21.66	21.60
		16QAM	1	0	22.50	22.24	21.87	21.84
			1	7	22.50	22.05	21.93	21.85
			1	14	22.50	22.05	21.85	21.84
			8	0	21.00	20.96	20.71	20.72

Band	Band Width	Modulation	RB Configuration		Tune-up (dBm)	Channel/Frequency(MHz)		
			RB Size	RB Offset		23035/701.5	23095/707.5	23155/713.5
			8	4	21.00	20.92	20.69	20.68
			8	7	21.00	20.91	20.69	20.59
			15	0	21.00	20.90	20.70	20.62
LTE Band 12	5MHz	QPSK	1	0	23.00	22.94	22.78	22.62
			1	12	23.00	22.88	22.65	22.59
			1	24	23.00	22.79	22.63	22.65
			12	0	22.00	21.91	21.75	21.59
			12	6	22.00	21.89	21.68	21.66
			12	11	22.00	21.82	21.67	21.58
		16QAM	25	0	22.00	21.89	21.74	21.62
			1	0	22.50	22.21	22.01	21.91
			1	12	22.50	22.19	21.96	21.98
			1	24	22.50	22.14	21.97	21.97
			12	0	21.00	20.90	20.76	20.61
			12	6	21.00	20.89	20.71	20.72
			12	11	21.00	20.83	20.71	20.65
			25	0	21.00	20.88	20.73	20.64
			RB Configuration		Tune-up (dBm)	Channel/Frequency(MHz)		
			RB Size	RB Offset		23060/704	23095/707.5	23130/711
LTE Band 12	10MHz	QPSK	1	0	23.00	22.98	22.89	22.79
			1	24	23.00	22.74	22.69	22.53
			1	49	23.00	22.67	22.57	22.65
			25	0	22.00	21.82	21.83	21.66
			25	12	22.00	21.80	21.68	21.61
			25	24	22.00	21.63	21.68	21.59
			50	0	22.00	21.77	21.76	21.62
		16QAM	1	0	22.50	22.36	22.13	22.07
			1	24	22.50	22.10	21.98	21.90
			1	49	22.50	22.01	21.91	21.92
			25	0	21.00	20.84	20.82	20.64
			25	12	21.00	20.76	20.70	20.63
			25	24	21.00	20.67	20.69	20.59
			50	0	21.00	20.75	20.79	20.62

Band	Band Width	Modulation	RB Configuration		Tune-up (dBm)	Channel/Frequency(MHz)		
			RB Size	RB Offset		23755/706.5	23790/710	23825/713.5
LTE Band 17	5MHz	QPSK	1	0	23.00	22.75	22.62	22.62
			1	12	23.00	22.62	22.61	22.61
			1	24	23.00	22.61	22.65	22.65
			12	0	22.00	21.76	21.67	21.65
			12	6	22.00	21.70	21.65	21.63
			12	11	22.00	21.67	21.67	21.57
			25	0	22.00	21.74	21.71	21.61
		16QAM	1	0	22.50	22.03	21.92	21.95
			1	12	22.50	22.00	21.87	21.83
			1	24	22.50	21.97	21.92	21.98
			12	0	21.00	20.81	20.68	20.66
			12	6	21.00	20.72	20.69	20.68
			12	11	21.00	20.64	20.66	20.58
			25	0	21.00	20.75	20.71	20.68

Band	Band Width	Modulation	RB Configuration		Tune-up (dBm)	Channel/Frequency(MHz)		
			RB Size	RB Offset		23780/709	23790/710	23800/711
LTE Band 17	10MHz	QPSK	1	0	23.00	22.80	22.73	22.76
			1	24	23.00	22.62	22.63	22.59
			1	49	23.00	22.65	22.68	22.65
			25	0	22.00	21.75	21.69	21.65
			25	12	22.00	21.64	21.67	21.63
			25	24	22.00	21.66	21.67	21.61
			50	0	22.00	21.71	21.66	21.67
		16QAM	1	0	22.50	22.08	21.99	22.06
			1	24	22.50	21.89	21.99	21.85
			1	49	22.50	21.91	22.05	22.00
			25	0	21.00	20.78	20.67	20.68
			25	12	21.00	20.65	20.65	20.61
			25	24	21.00	20.66	20.69	20.64
			50	0	21.00	20.71	20.66	20.66

Band	Band Width	Modulation	RB Configuration	Tune-up (dBm)	Channel/Frequency(MHz)
------	------------	------------	------------------	---------------	------------------------

38			1	74	23.50	22.89	22.87	22.90			
			36	0	22.00	21.93	21.96	21.93			
			36	18	22.00	21.91	21.95	21.92			
			36	37	22.00	21.89	21.92	21.92			
			75	0	22.00	21.93	21.95	21.93			
		16QAM	1	0	22.50	22.21	22.20	22.16			
			1	37	22.50	22.17	22.24	22.11			
			1	74	22.50	22.13	22.08	22.13			
			36	0	21.00	20.92	20.94	20.92			
			36	18	21.00	20.88	20.93	20.88			
			36	37	21.00	20.87	20.91	20.89			
			75	0	21.00	20.98	20.99	20.97			
			Band	Band Width	Modulation	RB Configuration		Tune-up (dBm)	Channel/Frequency(MHz)		
						RB Size	RB Offset		37850/2580	38000/2595	38150/2610
LTE Band 38	20MHz	QPSK	1	0	23.50	22.99	22.95	22.94			
			1	49	23.50	22.96	23.02	22.90			
			1	99	23.50	22.93	22.84	22.88			
			50	0	22.00	21.98	21.98	21.97			
			50	24	22.00	21.99	22.00	21.95			
			50	49	22.00	21.97	21.96	21.95			
			100	0	22.00	21.93	21.97	21.94			
		16QAM	1	0	22.50	22.24	22.21	22.18			
			1	49	22.50	22.20	22.27	22.15			
			1	99	22.50	22.18	22.07	22.12			
			50	0	21.50	21.02	21.01	20.99			
			50	24	21.50	21.01	21.03	20.97			
			50	49	21.50	20.99	20.99	20.97			
			100	0	21.50	21.00	21.03	20.98			

Band	Band Width	Modulation	RB Configuration		Tune-up (dBm)	Channel/Frequency(MHz)		
			RB Size	RB Offset		39675/2498.5	40620/2593	41565/2687.5
LTE Band 41	5MHz	QPSK	1	0	25.00	24.78	24.86	23.94
			1	12	25.00	24.80	24.84	23.48
			1	24	25.00	24.88	24.86	23.37
			12	0	24.00	23.78	23.91	23.70
			12	6	24.00	23.80	23.90	23.49

			12	11	24.00	23.81	23.90	23.40
			25	0	24.00	23.76	23.92	23.58
		16QAM	1	0	24.50	23.84	24.11	23.92
			1	12	24.50	23.83	24.11	23.55
			1	24	24.50	23.87	24.11	23.44
			12	0	23.50	22.81	22.97	23.12
			12	6	23.50	22.81	22.97	23.14
			12	11	23.50	22.85	22.97	23.12
			25	0	23.50	22.88	22.99	23.15
Band	Band Width	Modulation	RB Configuration		Tune-up (dBm)	Channel/Frequency(MHz)		
			RB Size	RB Offset		39700/2501	40620/2593	41540/2685
LTE Band 41	10MHz	QPSK	1	0	25.00	24.57	24.87	23.99
			1	24	25.00	24.60	24.87	23.61
			1	49	25.00	24.64	24.81	23.27
			25	0	24.00	23.74	23.97	23.80
			25	12	24.00	23.78	23.93	23.62
			25	24	24.00	23.80	23.90	23.45
			50	0	24.00	23.81	23.96	23.65
		16QAM	1	0	24.50	23.85	24.13	24.01
			1	24	24.50	23.87	24.15	23.68
			1	49	24.50	23.93	24.08	23.38
			25	0	23.50	22.85	23.03	23.17
			25	12	23.50	22.89	22.99	23.15
			25	24	23.50	22.92	22.97	23.13
			50	0	23.50	22.88	23.01	23.17
Band	Band Width	Modulation	RB Configuration		Tune-up (dBm)	Channel/Frequency(MHz)		
			RB Size	RB Offset		39725/2503.5	40620/2593	41515/2682.5
LTE Band 41	15MHz	QPSK	1	0	25.00	24.59	24.87	24.34
			1	37	25.00	24.68	24.91	23.81
			1	74	25.00	24.68	24.80	23.20
			36	0	24.50	23.83	23.99	24.03
			36	18	24.50	23.86	23.97	23.84
			36	37	24.50	23.87	23.93	23.48
			75	0	24.00	23.84	23.97	23.80
		16QAM	1	0	24.50	23.81	24.12	24.10
			1	37	24.50	23.93	24.16	23.87

Band	Band Width	Modulation	RB Configuration		Tune-up (dBm)	Channel/Frequency(MHz)		
			RB Size	RB Offset		39750/2506	40620/2593	41490/2680
			1	74	24.50	23.94	24.08	23.29
			36	0	23.50	22.82	22.99	23.03
			36	18	23.50	22.87	22.97	23.01
			36	37	23.50	22.89	22.94	22.99
			75	0	23.50	22.90	23.01	23.08
LTE Band 41	20MHz	QPSK	1	0	25.00	24.59	24.86	24.39
			1	49	25.00	24.70	24.92	23.90
			1	99	25.00	24.61	24.78	23.15
			50	0	24.50	23.85	24.02	24.04
			50	24	24.50	23.91	24.00	23.94
			50	49	24.50	23.88	23.97	23.55
			100	0	24.00	23.84	23.98	23.89
		16QAM	1	0	24.50	23.86	24.10	24.13
			1	49	24.50	23.96	24.21	23.98
			1	99	24.50	23.97	24.08	23.26
			50	0	23.50	22.91	23.06	23.11
			50	24	23.50	22.99	23.07	23.10
			50	49	23.50	22.96	23.02	23.05
			100	0	23.50	22.93	23.05	23.08

Band	Band Width	Modulation	RB Configuration		Tune-up (dBm)	Channel/Frequency(MHz)	
			RB Size	RB Offset		40140/2545	41140/2645
LTE Band 41	20MHz	QPSK	1	0	25.00	24.51	24.35
			1	49	25.00	24.65	23.86
			1	99	24.50	24.50	23.12
			50	0	24.50	23.75	24.01
			50	24	24.00	23.87	23.83
			50	49	24.00	23.82	23.51
			100	0	24.00	23.76	23.79
		16QAM	1	0	24.50	23.82	24.08
			1	49	24.00	23.91	23.91
			1	99	24.00	23.92	23.22
			50	0	23.50	22.89	23.07
			50	24	23.50	22.93	23.03

			50	49	23.50	22.94	23.02
			100	0	23.50	22.88	23.04

7.4. NR SA Power

Band	SCS (kHz)	Bandwidth (MHz)	UL Channel	RB Allocation	Modulation	Tune-up	Power (dBm)
n78	30	10	630334	1@1	DFT_BPSK	27.00	26.77
n78	30	10	630334	24@0	DFT_QPSK	26.00	25.96
n78	30	10	630334	12@6	DFT_QPSK	27.00	26.96
n78	30	10	630334	1@1	DFT_QPSK	27.00	26.92
n78	30	10	630334	1@22	DFT_QPSK	28.00	27.05
n78	30	10	630334	1@1	DFT_QAM16	26.00	25.83
n78	30	10	630334	1@1	DFT_QAM64	25.00	24.48
n78	30	10	630334	1@1	DFT_QAM256	23.00	22.24
n78	30	10	630334	1@1	CP_QPSK	26.00	25.43
n78	30	10	633333	1@1	DFT_BPSK	28.00	27.30
n78	30	10	633333	24@0	DFT_QPSK	27.00	26.57
n78	30	10	633333	12@6	DFT_QPSK	28.00	27.53
n78	30	10	633333	1@1	DFT_QPSK	28.00	27.47
n78	30	10	633333	1@22	DFT_QPSK	28.00	27.65
n78	30	10	633333	1@1	DFT_QAM16	27.00	26.42
n78	30	10	633333	1@1	DFT_QAM64	26.00	25.01
n78	30	10	633333	1@1	DFT_QAM256	23.00	22.78
n78	30	10	633333	1@1	CP_QPSK	26.00	25.87
n78	30	10	636333	1@1	DFT_BPSK	28.00	27.83
n78	30	10	636333	24@0	DFT_QPSK	27.00	26.93
n78	30	10	636333	12@6	DFT_QPSK	28.00	27.94
n78	30	10	636333	1@1	DFT_QPSK	28.00	27.94
n78	30	10	636333	1@22	DFT_QPSK	28.00	27.93
n78	30	10	636333	1@1	DFT_QAM16	27.00	26.86
n78	30	10	636333	1@1	DFT_QAM64	26.00	25.58
n78	30	10	636333	1@1	DFT_QAM256	24.00	23.26
n78	30	10	636333	1@1	CP_QPSK	27.00	26.37
n78	30	15	630500	1@1	DFT_BPSK	27.00	26.80
n78	30	15	630500	36@0	DFT_QPSK	27.00	26.09
n78	30	15	630500	18@9	DFT_QPSK	28.00	27.17
n78	30	15	630500	1@1	DFT_QPSK	27.00	26.90
n78	30	15	630500	1@36	DFT_QPSK	28.00	27.22

n78	30	15	630500	1@1	DFT_QAM16	26.00	25.91
n78	30	15	630500	1@1	DFT_QAM64	25.00	24.48
n78	30	15	630500	1@1	DFT_QAM256	23.00	22.29
n78	30	15	630500	1@1	CP_QPSK	26.00	25.30
n78	30	15	633333	1@1	DFT_BPSK	28.00	27.24
n78	30	15	633333	36@0	DFT_QPSK	27.00	26.53
n78	30	15	633333	18@9	DFT_QPSK	28.00	27.55
n78	30	15	633333	1@1	DFT_QPSK	28.00	27.42
n78	30	15	633333	1@36	DFT_QPSK	28.00	27.68
n78	30	15	633333	1@1	DFT_QAM16	27.00	26.36
n78	30	15	633333	1@1	DFT_QAM64	25.00	24.97
n78	30	15	633333	1@1	DFT_QAM256	23.00	22.72
n78	30	15	633333	1@1	CP_QPSK	26.00	25.79
n78	30	15	636166	1@1	DFT_BPSK	28.00	27.80
n78	30	15	636166	36@0	DFT_QPSK	28.00	27.00
n78	30	15	636166	18@9	DFT_QPSK	28.00	27.92
n78	30	15	636166	1@1	DFT_QPSK	28.00	27.91
n78	30	15	636166	1@36	DFT_QPSK	28.00	27.88
n78	30	15	636166	1@1	DFT_QAM16	27.00	26.91
n78	30	15	636166	1@1	DFT_QAM64	26.00	25.55
n78	30	15	636166	1@1	DFT_QAM256	24.00	23.29
n78	30	15	636166	1@1	CP_QPSK	27.00	26.34
n78	30	20	630667	1@1	DFT_BPSK	27.00	26.86
n78	30	20	630667	50@0	DFT_QPSK	27.00	26.19
n78	30	20	630667	25@12	DFT_QPSK	28.00	27.23
n78	30	20	630667	1@1	DFT_QPSK	27.00	26.98
n78	30	20	630667	1@49	DFT_QPSK	28.00	27.33
n78	30	20	630667	1@1	DFT_QAM16	26.00	25.93
n78	30	20	630667	1@1	DFT_QAM64	25.00	24.53
n78	30	20	630667	1@1	DFT_QAM256	23.00	22.32
n78	30	20	630667	1@1	CP_QPSK	26.00	25.33
n78	30	20	633333	1@1	DFT_BPSK	28.00	27.22
n78	30	20	633333	50@0	DFT_QPSK	27.00	26.56
n78	30	20	633333	25@12	DFT_QPSK	28.00	27.58
n78	30	20	633333	1@1	DFT_QPSK	28.00	27.36
n78	30	20	633333	1@49	DFT_QPSK	28.00	27.71
n78	30	20	633333	1@1	DFT_QAM16	27.00	26.33
n78	30	20	633333	1@1	DFT_QAM64	25.00	24.88
n78	30	20	633333	1@1	DFT_QAM256	23.00	22.70

n78	30	20	633333	1@1	CP_QPSK	26.00	25.76
n78	30	20	636000	1@1	DFT_BPSK	28.00	27.76
n78	30	20	636000	50@0	DFT_QPSK	28.00	27.02
n78	30	20	636000	25@12	DFT_QPSK	28.00	27.91
n78	30	20	636000	1@1	DFT_QPSK	28.00	27.90
n78	30	20	636000	1@49	DFT_QPSK	28.00	27.94
n78	30	20	636000	1@1	DFT_QAM16	27.00	26.85
n78	30	20	636000	1@1	DFT_QAM64	26.00	25.42
n78	30	20	636000	1@1	DFT_QAM256	24.00	23.20
n78	30	20	636000	1@1	CP_QPSK	27.00	26.26
n78	30	40	631334	1@1	DFT_BPSK	28.00	27.01
n78	30	40	631334	100@0	DFT_QPSK	27.00	26.32
n78	30	40	631334	50@25	DFT_QPSK	28.00	27.39
n78	30	40	631334	1@1	DFT_QPSK	28.00	27.09
n78	30	40	631334	1@104	DFT_QPSK	28.00	27.29
n78	30	40	631334	1@1	DFT_QAM16	27.00	26.08
n78	30	40	631334	1@1	DFT_QAM64	25.00	24.64
n78	30	40	631334	1@1	DFT_QAM256	23.00	22.45
n78	30	40	631334	1@1	CP_QPSK	26.00	25.39
n78	30	40	633333	1@1	DFT_BPSK	28.00	27.20
n78	30	40	633333	100@0	DFT_QPSK	27.00	26.58
n78	30	40	633333	50@25	DFT_QPSK	28.00	27.58
n78	30	40	633333	1@1	DFT_QPSK	28.00	27.30
n78	30	40	633333	1@104	DFT_QPSK	28.00	27.59
n78	30	40	633333	1@1	DFT_QAM16	27.00	26.27
n78	30	40	633333	1@1	DFT_QAM64	25.00	24.84
n78	30	40	633333	1@1	DFT_QAM256	23.00	22.64
n78	30	40	633333	1@1	CP_QPSK	26.00	25.66
n78	30	40	635333	1@1	DFT_BPSK	28.00	27.59
n78	30	40	635333	100@0	DFT_QPSK	27.00	26.86
n78	30	40	635333	50@25	DFT_QPSK	28.00	27.84
n78	30	40	635333	1@1	DFT_QPSK	28.00	27.67
n78	30	40	635333	1@104	DFT_QPSK	28.00	27.94
n78	30	40	635333	1@1	DFT_QAM16	27.00	26.67
n78	30	40	635333	1@1	DFT_QAM64	26.00	25.26
n78	30	40	635333	1@1	DFT_QAM256	24.00	23.03
n78	30	40	635333	1@1	CP_QPSK	27.00	26.01
n78	30	50	631667	1@1	DFT_BPSK	27.00	26.97
n78	30	50	631667	128@0	DFT_QPSK	27.00	26.33

n78	30	50	631667	64@32	DFT_QPSK	28.00	27.40
n78	30	50	631667	1@1	DFT_QPSK	28.00	27.14
n78	30	50	631667	1@131	DFT_QPSK	28.00	27.59
n78	30	50	631667	1@1	DFT_QAM16	27.00	26.02
n78	30	50	631667	1@1	DFT_QAM64	25.00	24.68
n78	30	50	631667	1@1	DFT_QAM256	23.00	22.47
n78	30	50	631667	1@1	CP_QPSK	26.00	25.41
n78	30	50	633333	1@1	DFT_BPSK	28.00	27.25
n78	30	50	633333	128@0	DFT_QPSK	27.00	26.53
n78	30	50	633333	64@32	DFT_QPSK	28.00	27.62
n78	30	50	633333	1@1	DFT_QPSK	28.00	27.47
n78	30	50	633333	1@131	DFT_QPSK	28.00	27.73
n78	30	50	633333	1@1	DFT_QAM16	27.00	26.35
n78	30	50	633333	1@1	DFT_QAM64	25.00	24.89
n78	30	50	633333	1@1	DFT_QAM256	23.00	22.72
n78	30	50	633333	1@1	CP_QPSK	26.00	25.70
n78	30	50	635000	1@1	DFT_BPSK	28.00	27.58
n78	30	50	635000	128@0	DFT_QPSK	27.00	26.83
n78	30	50	635000	64@32	DFT_QPSK	28.00	27.80
n78	30	50	635000	1@1	DFT_QPSK	28.00	27.70
n78	30	50	635000	1@131	DFT_QPSK	28.00	27.92
n78	30	50	635000	1@1	DFT_QAM16	27.00	26.69
n78	30	50	635000	1@1	DFT_QAM64	26.00	25.30
n78	30	50	635000	1@1	DFT_QAM256	24.00	23.05
n78	30	50	635000	1@1	CP_QPSK	27.00	26.13
n78	30	60	632000	1@1	DFT_BPSK	27.00	26.97
n78	30	60	632000	162@0	DFT_QPSK	27.00	26.40
n78	30	60	632000	81@40	DFT_QPSK	28.00	27.43
n78	30	60	632000	1@1	DFT_QPSK	28.00	27.10
n78	30	60	632000	1@160	DFT_QPSK	28.00	27.64
n78	30	60	632000	1@1	DFT_QAM16	27.00	26.05
n78	30	60	632000	1@1	DFT_QAM64	25.00	24.63
n78	30	60	632000	1@1	DFT_QAM256	23.00	22.43
n78	30	60	632000	1@1	CP_QPSK	26.00	25.36
n78	30	60	633333	1@1	DFT_BPSK	28.00	27.27
n78	30	60	633333	162@0	DFT_QPSK	27.00	26.54
n78	30	60	633333	81@40	DFT_QPSK	28.00	27.55
n78	30	60	633333	1@1	DFT_QPSK	28.00	27.38
n78	30	60	633333	1@160	DFT_QPSK	28.00	27.72

n78	30	60	633333	1@1	DFT_QAM16	27.00	26.37
n78	30	60	633333	1@1	DFT_QAM64	26.00	25.02
n78	30	60	633333	1@1	DFT_QAM256	23.00	22.75
n78	30	60	633333	1@1	CP_QPSK	26.00	25.74
n78	30	60	634666	1@1	DFT_BPSK	28.00	27.31
n78	30	60	634666	162@0	DFT_QPSK	27.00	26.81
n78	30	60	634666	81@40	DFT_QPSK	28.00	27.77
n78	30	60	634666	1@1	DFT_QPSK	28.00	27.43
n78	30	60	634666	1@160	DFT_QPSK	28.00	27.97
n78	30	60	634666	1@1	DFT_QAM16	27.00	26.39
n78	30	60	634666	1@1	DFT_QAM64	26.00	25.00
n78	30	60	634666	1@1	DFT_QAM256	23.00	22.78
n78	30	60	634666	1@1	CP_QPSK	26.00	25.81
n78	30	80	632667	1@1	DFT_BPSK	28.00	27.04
n78	30	80	632667	216@0	DFT_QPSK	27.00	26.53
n78	30	80	632667	108@54	DFT_QPSK	28.00	27.52
n78	30	80	632667	1@1	DFT_QPSK	28.00	27.14
n78	30	80	632667	1@215	DFT_QPSK	28.00	27.80
n78	30	80	632667	1@1	DFT_QAM16	27.00	26.15
n78	30	80	632667	1@1	DFT_QAM64	25.00	24.71
n78	30	80	632667	1@1	DFT_QAM256	23.00	22.45
n78	30	80	632667	1@1	CP_QPSK	26.00	25.50
n78	30	80	633333	1@1	DFT_BPSK	28.00	27.28
n78	30	80	633333	216@0	DFT_QPSK	27.00	26.63
n78	30	80	633333	108@54	DFT_QPSK	28.00	27.63
n78	30	80	633333	1@1	DFT_QPSK	28.00	27.37
n78	30	80	633333	1@215	DFT_QPSK	28.00	27.93
n78	30	80	633333	1@1	DFT_QAM16	27.00	26.38
n78	30	80	633333	1@1	DFT_QAM64	25.00	24.97
n78	30	80	633333	1@1	DFT_QAM256	23.00	22.73
n78	30	80	633333	1@1	CP_QPSK	26.00	25.85
n78	30	80	634000	1@1	DFT_BPSK	28.00	27.44
n78	30	80	634000	216@0	DFT_QPSK	27.00	26.75
n78	30	80	634000	108@54	DFT_QPSK	28.00	27.75
n78	30	80	634000	1@1	DFT_QPSK	28.00	27.53
n78	30	80	634000	1@215	DFT_QPSK	28.00	27.92
n78	30	80	634000	1@1	DFT_QAM16	27.00	26.54
n78	30	80	634000	1@1	DFT_QAM64	26.00	25.10
n78	30	80	634000	1@1	DFT_QAM256	23.00	22.86

n78	30	80	634000	1@1	CP_QPSK	26.00	25.91
n78	30	90	633000	1@1	DFT_BPSK	28.00	27.02
n78	30	90	633000	240@0	DFT_QPSK	27.00	26.57
n78	30	90	633000	120@60	DFT_QPSK	28.00	27.58
n78	30	90	633000	1@1	DFT_QPSK	28.00	27.26
n78	30	90	633000	1@243	DFT_QPSK	28.00	27.86
n78	30	90	633000	1@1	DFT_QAM16	27.00	26.16
n78	30	90	633000	1@1	DFT_QAM64	25.00	24.68
n78	30	90	633000	1@1	DFT_QAM256	23.00	22.46
n78	30	90	633000	1@1	CP_QPSK	26.00	25.39
n78	30	90	633333	1@1	DFT_BPSK	28.00	27.15
n78	30	90	633333	240@0	DFT_QPSK	27.00	26.67
n78	30	90	633333	120@60	DFT_QPSK	28.00	27.63
n78	30	90	633333	1@1	DFT_QPSK	28.00	27.35
n78	30	90	633333	1@243	DFT_QPSK	28.00	27.91
n78	30	90	633333	1@1	DFT_QAM16	27.00	26.29
n78	30	90	633333	1@1	DFT_QAM64	25.00	24.78
n78	30	90	633333	1@1	DFT_QAM256	23.00	22.61
n78	30	90	633333	1@1	CP_QPSK	26.00	25.59
n78	30	90	633666	1@1	DFT_BPSK	28.00	27.33
n78	30	90	633666	240@0	DFT_QPSK	27.00	26.74
n78	30	90	633666	120@60	DFT_QPSK	28.00	27.73
n78	30	90	633666	1@1	DFT_QPSK	28.00	27.53
n78	30	90	633666	1@243	DFT_QPSK	28.00	27.83
n78	30	90	633666	1@1	DFT_QAM16	27.00	26.45
n78	30	90	633666	1@1	DFT_QAM64	26.00	25.04
n78	30	90	633666	1@1	DFT_QAM256	23.00	22.82
n78	30	90	633666	1@1	CP_QPSK	26.00	25.79
n78	30	100	633333	1@1	DFT_BPSK	28.00	27.04
n78	30	100	633333	270@0	DFT_QPSK	27.00	26.65
n78	30	100	633333	135@67	DFT_QPSK	28.00	27.59
n78	30	100	633333	1@1	DFT_QPSK	28.00	27.27
n78	30	100	633333	1@271	DFT_QPSK	28.00	27.88
n78	30	100	633333	1@1	DFT_QAM16	27.00	26.16
n78	30	100	633333	1@1	DFT_QAM64	25.00	24.68
n78	30	100	633333	1@1	DFT_QAM256	23.00	22.55
n78	30	100	633333	1@1	CP_QPSK	26.00	25.53

7.5. WLAN & Bluetooth Output Power

Mode	Channel	Frequency (MHz)	Tune-up (dBm)	Output Power (dBm)
802.11b	1	2412	17.50	16.91
	6	2437	17.50	17.42
	11	2462	17.50	17.33
802.11g	1	2412	14.50	14.11
	6	2437	14.50	14.39
	11	2462	14.50	14.19
802.11n HT20	1	2412	12.50	12.24
	6	2437	12.50	12.20
	11	2462	12.50	12.23
802.11n HT40	3	2422	12.50	12.25
	6	2437	12.50	12.36
	9	2452	12.50	12.39

NOTE: Power measurement results of WLAN 2.4G.

Mode	Channel	Frequency (MHz)	Tune-up (dBm)	Output Power (dBm)
802.11a	36	5180	12.00	11.67
	40	5200	12.00	11.82
	48	5240	12.00	11.58
802.11n HT20	36	5180	12.00	11.75
	40	5200	12.00	11.45
	48	5240	12.00	11.60
802.11n HT40	38	5190	12.00	11.71
	46	5230	12.00	11.67
802.11ac VHT20	36	5180	12.50	11.62
	40	5200	12.50	12.07
	48	5240	12.50	12.10
802.11ac VHT40	38	5190	12.50	11.60
	46	5230	12.50	12.18
802.11ac VHT80	42	5210	12.00	11.86

NOTE: Power measurement results of WLAN 5.2G.

Mode	Channel	Frequency (MHz)	Tune-up (dBm)	Output Power (dBm)
802.11a	149	5745	11.50	10.80
	157	5785	11.50	11.49
	165	5825	11.50	11.39
802.11n HT20	149	5745	11.50	11.15
	157	5785	11.50	11.36
	165	5825	11.50	11.23
802.11n HT40	151	5755	11.50	11.25
	159	5795	11.50	11.45
802.11ac VHT20	149	5745	11.50	10.43
	157	5785	11.50	11.33
	165	5825	11.50	11.31
802.11ac VHT40	151	5755	12.00	11.24
	159	5795	12.00	11.50
802.11ac VHT80	155	5775	11.50	11.25

NOTE: Power measurement results of WLAN 5.8G.

BR+EDR	Output Power (dBm)				
	Channel	Tune-up (dBm)	Data Rates		
			1M	2M	3M
	0CH	10.00	9.43	9.04	9.02
	39CH	10.00	9.54	8.91	8.89
	78CH	10.00	9.81	9.18	9.19

BLE	Channel	Tune-up (dBm)	Output Power (dBm)	
			1M	2M
		0CH	-3.00	-4.10
	19CH	-2.00	-2.91	-2.91
	39CH	-3.00	-3.18	-3.01

NOTE: Power measurement results of Bluetooth.

7.6. NFC

The power is too low, so SAR testing is not necessary.

8. Antenna Location

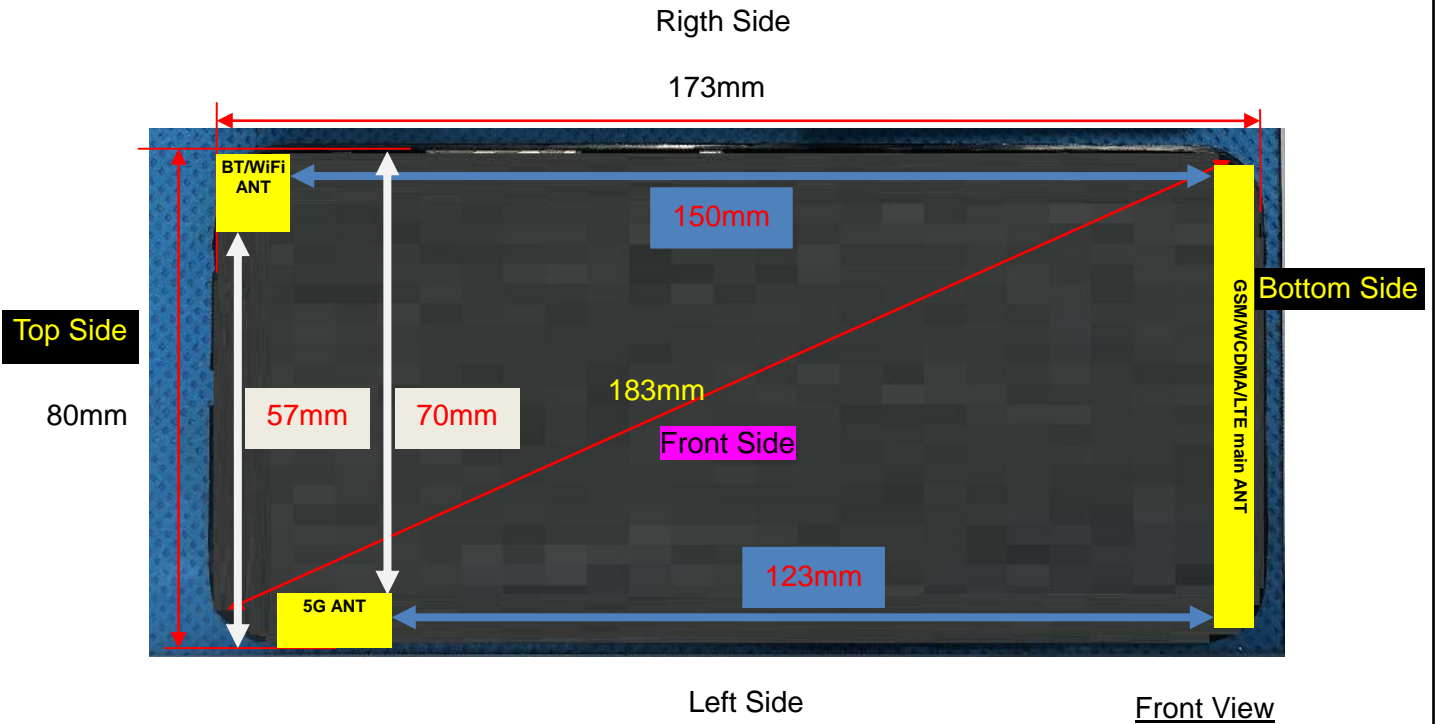

Note: Since the confidentiality request of EUT, the antenna location example diagram see as above.

Distance of the Antenna to the EUT surface/edge						
Antennas	Front Side	Back Side	Left Side	Right Side	Top Side	Bottom Side
WWAN Main ANT	≤ 25mm	≤ 25mm	≤ 25mm	≤ 25mm	> 25mm	≤ 25mm
WLAN & Bluetooth	≤ 25mm	≤ 25mm	>25mm	≤ 25mm	≤ 25mm	>25mm
5G	≤ 25mm	≤ 25mm	≤ 25mm	>25mm	≤ 25mm	>25mm
Positions for SAR tests						
Antennas	Front Side	Back Side	Left Side	Right Side	Top Side	Bottom Side
WWAN Main ANT	Yes	Yes	Yes	Yes	NO	Yes
WLAN & Bluetooth	Yes	Yes	NO	Yes	Yes	NO
5G	Yes	Yes	Yes	NO	Yes	NO

9. Stand-alone SAR test exclusion

Refer to FCC KDB 447498D01, the 1-g SAR and 10-g SAR test exclusion thresholds for 100 MHz to 6 GHz at test separation distances ≤ 50 mm are determined by:

$$[(\text{max. power of channel, including tune-up tolerance, mW}) / (\text{min. test separation distance, mm})] \cdot [\sqrt{f_{\text{GHZ}}}] \leq 3.0 \text{ for 1-g SAR and } \leq 7.5 \text{ for 10-g extremity SAR, where:}$$

- f_{GHZ} is the RF channel transmit frequency in GHz
- Power and distance are rounded to the nearest mW and mm before calculation
- The result is rounded to one decimal place for comparison

When the minimum test separation distance is < 5 mm, a distance of 5 mm is applied to determine

SAR test exclusion.

Mode	P_{max} (dBm)	P_{max} (mW)	Distance (mm)	f (GHz)	Calculation Result	SAR Exclusion threshold	SAR test exclusion
Bluetooth	10.00	10.00	5	2.480	3.14	3	NO

NOTE: Standalone SAR test exclusion for Bluetooth.

10. SAR Results

10.1. SAR measurement Result

10.1.1. SAR measurement Result of GSM850

Test Position of Head	Test channel /Freq.	Mode	SAR Value (W/kg)		Power Drift(%)	Conducted Power (dBm)	Tune-up Power (dBm)	Scaled SAR 1-g (W/Kg)	Date	Plot
			1-g	10-g						
Left Cheek	189/836.4	GPRS(GMSK 4TS)	0.155	0.115	-0.29	28.23	28.50	0.165	2024/4/08	1#
Left Tilt 15 Degree	189/836.4	GPRS(GMSK 4TS)	0.081	0.059	0.49	28.23	28.50	0.086	2024/4/08	
Right Cheek	189/836.4	GPRS(GMSK 4TS)	0.133	0.096	0.25	28.23	28.50	0.142	2024/4/08	
Right Tilt 15 Degree	189/836.4	GPRS(GMSK 4TS)	0.071	0.053	0.08	28.23	28.50	0.076	2024/4/08	

NOTE: Head SAR test results of GSM850.

Test Position of Body-Worn with 10mm	Test channel /Freq.	Test Mode	SAR Value (W/kg)		Power Drift (±5%)	Conducted power (dBm)	Tune-up power (dBm)	Scaled SAR 1g (W/Kg)	Date	Plot
			1g	10g						
Front Side	189/836.4	GPRS(GMSK 4TS)	0.179	0.115	-2.22	28.23	28.50	0.190	2024/4/08	
Back Side	189/836.4	GPRS(GMSK 4TS)	0.442	0.247	-0.55	28.23	28.50	0.470	2024/4/08	2#

NOTE: Body-Worn SAR test results of GSM850

Test Position of Hotspot	Test channel /Freq.	Mode	SAR Value (W/kg)		Power Drift(%)	Conducted Power (dBm)	Tune-up Power (dBm)	Scaled SAR 1-g (W/Kg)	Date	Plot
			1-g	10-g						

with 10mm										
Front Side	189/836.4	GPRS(GMSK 4TS)	0.179	0.115	-2.22	28.23	28.50	0.190	2024/4/08	
Back Side	189/836.4	GPRS(GMSK 4TS)	0.442	0.247	-0.55	28.23	28.50	0.470	2024/4/08	2#
Left Side	189/836.4	GPRS(GMSK 4TS)	0.144	0.079	3.22	28.23	28.50	0.153	2024/4/08	
Right Side	189/836.4	GPRS(GMSK 4TS)	0.148	0.083	2.81	28.23	28.50	0.157	2024/4/08	
Bottom Side	189/836.4	GPRS(GMSK 4TS)	0.225	0.121	-2.58	28.23	28.50	0.239	2024/4/08	

NOTE: Hotspot SAR test results of GSM850

10.1.2. SAR measurement Result of GSM1900

Test Position of Head	Test channel /Freq.	Mode	SAR Value (W/kg)		Power Drift(%)	Conducted Power (dBm)	Tune-up Power (dBm)	Scaled SAR 1-g (W/Kg)	Date	Plot
			1-g	10-g						
Left Cheek	661/1880	GPRS(GMSK 4TS)	0.182	0.100	-0.58	25.44	26.00	0.207	2024/4/09	3#
Left Tilt 15 Degree	661/1880	GPRS(GMSK 4TS)	0.098	0.053	-0.61	25.44	26.00	0.111	2024/4/09	
Right Cheek	661/1880	GPRS(GMSK 4TS)	0.168	0.090	-0.91	25.44	26.00	0.191	2024/4/09	
Right Tilt 15 Degree	661/1880	GPRS(GMSK 4TS)	0.080	0.044	-2.17	25.44	26.00	0.091	2024/4/09	

NOTE: Head SAR test results of GSM1900

Test Position of Body-Worn with 10mm	Test channel /Freq.	Test Mode	SAR Value (W/kg)		Power Drift (±5%)	Conducted power (dBm)	Tune-up power (dBm)	Scaled SAR 1g (W/Kg)	Date	Plot
			1g	10g						
Front Side	661/1880	GPRS(GMSK 4TS)	0.101	0.061	-3.67	25.44	26.00	0.115	2024/4/09	
Back Side	661/1880	GPRS(GMSK 4TS)	0.411	0.212	-3.98	25.44	26.00	0.468	2024/4/09	4#

NOTE: Body-Worn SAR test results of GSM1900

Test Position	Test channel	Mode	SAR Value (W/kg)	Power Drift(%)	Conducte d Power	Tune-up Power	Scale d	Date	Plot
---------------	--------------	------	------------------	----------------	------------------	---------------	---------	------	------

of Hotspot with 10mm	/Freq.		1-g	10-g		(dBm)	(dBm)	SAR 1-g (W/Kg)		
Front Side	661/1880	GPRS(GMSK 4TS)	0.101	0.061	-3.67	25.44	26.00	0.115	2024/4/09	
Back Side	661/1880	GPRS(GMSK 4TS)	0.411	0.212	-3.98	25.44	26.00	0.468	2024/4/09	4#
Left Side	661/1880	GPRS(GMSK 4TS)	0.138	0.070	3.23	25.44	26.00	0.157	2024/4/09	
Right Side	661/1880	GPRS(GMSK 4TS)	0.142	0.072	0.95	25.44	26.00	0.162	2024/4/09	
Bottom Side	661/1880	GPRS(GMSK 4TS)	0.215	0.109	2.93	25.44	26.00	0.245	2024/4/09	

NOTE: Hotspot SAR test results of GSM1900

10.1.3. SAR measurement Result of WCDMA Band 2

Test Position of Head	Test channel /Freq	Mode	SAR Value (W/kg)		Power Drift(%)	Conducted Power (dBm)	Tune-up Power (dBm)	Scaled SAR 1-g (W/Kg)	Date	Plot
			1-g	10-g						
Left Cheek	9400/1880	RMC12.2K	0.234	0.126	-0.59	23.80	24.00	0.245	2024/4/09	5#
Left Tilt 15 Degree	9400/1880	RMC12.2K	0.119	0.063	-3.86	23.80	24.00	0.125	2024/4/09	
Right Cheek	9400/1880	RMC12.2K	0.208	0.109	3.07	23.80	24.00	0.218	2024/4/09	
Right Tilt 15 Degree	9400/1880	RMC12.2K	0.106	0.056	3.54	23.80	24.00	0.111	2024/4/09	

NOTE: Head SAR test results of WCDMA Band 2

Test Position of Body-Worn with 10mm	Test channel /Freq.	Test Mode	SAR Value (W/kg)		Power Drift (±5%)	Conducted power (dBm)	Tune-up power (dBm)	Scaled SAR 1g (W/Kg)	Date	Plot
			1g	10g						
Front Side	9400/1880	RMC12.2K	0.336	0.166	-1.89	23.80	24.00	0.352	2024/4/09	
Back Side	9400/1880	RMC12.2K	0.538	0.274	-3.90	23.80	24.00	0.563	2024/4/09	6#

NOTE: Body-Worn SAR test results of WCDMA Band 2

Test Position	Test channel /Freq.	Mode	SAR Value (W/kg)	Power Drift(%)	Conducte d Power	Tune-u p Power	Scaled SAR	Date	Plot
---------------	---------------------	------	------------------	----------------	------------------	----------------	------------	------	------

of Hotspot with 10mm			1-g	10-g)	(dBm)	(dBm)	1-g (W/Kg)		
Front Side	9400/1880	RMC12.2K	0.336	0.166	-1.89	23.80	24.00	0.352	2024/4/09	
Back Side	9400/1880	RMC12.2K	0.538	0.274	-3.90	23.80	24.00	0.563	2024/4/09	6#
Left Side	9400/1880	RMC12.2K	0.174	0.089	2.73	23.80	24.00	0.182	2024/4/09	
Right Side	9400/1880	RMC12.2K	0.178	0.093	-2.25	23.80	24.00	0.186	2024/4/09	
Bottom Side	9400/1880	RMC12.2K	0.290	0.142	1.70	23.80	24.00	0.304	2024/4/09	

NOTE: Hotspot SAR test results of WCDMA Band 2

10.1.4. SAR measurement Result of WCDMA Band 4

Test Position of Head	Test channel /Freq	Mode	SAR Value (W/kg)		Power Drift(%)	Conducted Power (dBm)	Tune-up Power (dBm)	Scaled SAR 1-g (W/Kg)	Date	Plot
			1-g	10-g						
Left Cheek	1413/1732.6	RMC12.2K	0.294	0.170	0.73	23.08	23.50	0.324	2024/4/10	7#
Left Tilt 15 Degree	1413/1732.6	RMC12.2K	0.149	0.083	-1.76	23.08	23.50	0.164	2024/4/10	
Right Cheek	1413/1732.6	RMC12.2K	0.260	0.149	2.71	23.08	23.50	0.286	2024/4/10	
Right Tilt 15 Degree	1413/1732.6	RMC12.2K	0.132	0.076	3.16	23.08	23.50	0.145	2024/4/10	

NOTE: Head SAR test results of WCDMA Band 4

Test Position of Body-Worn with 10mm	Test channel /Freq.	Test Mode	SAR Value (W/kg)		Power Drift (±5%)	Conducted power (dBm)	Tune-up power (dBm)	Scaled SAR 1g (W/Kg)	Date	Plot
			1g	10g						
Front Side	1413/1732.6	RMC12.2K	0.204	0.118	1.63	23.08	23.50	0.225	2024/4/10	
Back Side	1413/1732.6	RMC12.2K	0.292	0.170	0.78	23.08	23.50	0.322	2024/4/10	8#

NOTE: Body-Worn SAR test results of WCDMA Band 4

Test Position of Hotspot with 10mm	Test channel /Freq.	Mode	SAR Value (W/kg)		Power Drift(%)	Conducted Power (dBm)	Tune-up Power (dBm)	Scaled SAR 1-g (W/Kg)	Date	Plot
			1-g	10-g						
Front Side	1413/1732.6	RMC12.2K	0.204	0.118	1.63	23.08	23.50	0.225	2024/4/10	
Back Side	1413/1732.6	RMC12.2K	0.292	0.170	0.78	23.08	23.50	0.322	2024/4/10	8#
Left Side	1413/1732.6	RMC12.2K	0.090	0.052	-1.75	23.08	23.50	0.099	2024/4/10	
Right Side	1413/1732.6	RMC12.2K	0.102	0.057	-0.82	23.08	23.50	0.112	2024/4/10	
Bottom Side	1413/1732.6	RMC12.2K	0.160	0.093	0.53	23.08	23.50	0.176	2024/4/10	

NOTE: Hotspot SAR test results of WCDMA Band 4

10.1.5. SAR measurement Result of WCDMA Band 5

Test Position of Head	Test channel /Freq	Mode	SAR Value (W/kg)		Power Drift(%)	Conducted Power (dBm)	Tune-up Power (dBm)	Scaled SAR 1-g (W/Kg)	Date	Plot
			1-g	10-g						
Left Cheek	4182/836.4	RMC12.2K	0.080	0.063	-2.07	23.52	24.00	0.089	2024/4/08	9#
Left Tilt 15 Degree	4182/836.4	RMC12.2K	0.044	0.034	2.85	23.52	24.00	0.049	2024/4/08	
Right Cheek	4182/836.4	RMC12.2K	0.074	0.056	2.93	23.52	24.00	0.083	2024/4/08	
Right Tilt 15 Degree	4182/836.4	RMC12.2K	0.039	0.029	0.92	23.52	24.00	0.044	2024/4/08	

NOTE: Head SAR test results of WCDMA Band 5

Test Position of Body-Worn with 10mm	Test channel /Freq.	Test Mode	SAR Value (W/kg)		Power Drift (±5%)	Conducted power (dBm)	Tune-up power (dBm)	Scaled SAR 1g (W/Kg)	Date	Plot
			1g	10g						
Front Side	4182/836.4	RMC12.2K	0.150	0.087	-0.44	23.52	24.00	0.168	2024/4/08	
Back Side	4182/836.4	RMC12.2K	0.221	0.130	-2.45	23.52	24.00	0.247	2024/4/08	10#

NOTE: Body-Worn SAR test results of WCDMA Band 5

Test Position of Hotspot with 10mm	Test channel /Freq.	Mode	SAR Value (W/kg)		Power Drift(%)	Conducted Power (dBm)	Tune-up Power (dBm)	Scaled SAR 1-g (W/Kg)	Date	Plot
			1-g	10-g						
Front Side	4182/836.4	RMC12.2K	0.150	0.087	-0.44	23.52	24.00	0.168	2024/4/08	
Back Side	4182/836.4	RMC12.2K	0.221	0.130	-2.45	23.52	24.00	0.247	2024/4/08	10#
Left Side	4182/836.4	RMC12.2K	0.072	0.041	2.74	23.52	24.00	0.080	2024/4/08	
Right Side	4182/836.4	RMC12.2K	0.075	0.043	1.90	23.52	24.00	0.084	2024/4/08	
Bottom Side	4182/836.4	RMC12.2K	0.130	0.076	1.51	23.52	24.00	0.145	2024/4/08	

NOTE: Hotspot SAR test results of WCDMA Band 5

10.1.6. SAR measurement Result of LTE Band 2

Test Position of Head	Test channel /Freq.	Mode	SAR Value (W/kg)		Power Drift(%)	Conducte d Power (dBm)	Tune-up Power (dBm)	Scaled SAR 1-g (W/Kg)	Date	Plot
			1-g	10-g						
1RB										
Left Cheek	18900/1880	20M QPSK(1,49)	0.221	0.118	0.03	21.38	21.50	0.227	2024/4/09	19#
Left Tilt 15 Degree	18900/1880	20M QPSK(1,49)	0.116	0.059	-2.46	21.38	21.50	0.119	2024/4/09	
Right Cheek	18900/1880	20M QPSK(1,49)	0.203	0.107	3.08	21.38	21.50	0.209	2024/4/09	
Right Tilt 15 Degree	18900/1880	20M QPSK(1,49)	0.092	0.048	1.27	21.38	21.50	0.095	2024/4/09	
50%RB										
Left Cheek	18900/1880	20M QPSK(50,49)	0.116	0.068	-0.51	20.33	21.00	0.135	2024/4/09	
Left Tilt	18900/1880	20M QPSK(50,49)	0.069	0.033	-4.82	20.33	21.00	0.081	2024/4/09	

15 Degree										
Right Cheek	18900/1880	20M QPSK(50,49)	0.102	0.055	-0.11	20.33	21.00	0.119	2024/4/09	
Right Tilt 15 Degree	18900/1880	20M QPSK(50,49)	0.053	0.027	3.50	20.33	21.00	0.062	2024/4/09	

NOTE: Head SAR test results of LTE Band 2

Test Position of Body-Worn with 10mm	Test channel /Freq.	Test Mode	SAR Value (W/kg)		Power Drift (±5%)	Conducted power (dBm)	Tune-up power (dBm)	Scaled SAR 1g (W/Kg)	Date	Plot
			1g	10g						
1RB										
Front Side	18900/1880	20M QPSK(1,49)	0.354	0.180	-0.13	21.38	21.50	0.364	2024/4/09	
Back Side	18900/1880	20M QPSK(1,49)	0.562	0.285	-0.87	21.38	21.50	0.578	2024/4/09	20#
50%RB										
Front Side	18900/1880	20M QPSK(50,49)	0.198	0.108	-0.18	20.33	21.00	0.231	2024/4/09	
Back Side	18900/1880	20M QPSK(50,49)	0.321	0.148	4.64	20.33	21.00	0.375	2024/4/09	

NOTE: Body-Worn SAR test results of LTE Band 2

Test Position of Hotspot with 10mm	Test channel /Freq.	Mode	SAR Value (W/kg)		Power Drift(%)	Conducte d Power (dBm)	Tune-u p Power (dBm)	Scaled SAR 1-g (W/Kg)	Date	Plot
			1-g	10-g						
1RB										
Front Side	18900/1880	20M QPSK(1,49)	0.354	0.180	-0.13	21.38	21.50	0.364	2024/4/09	
Back Side	18900/1880	20M QPSK(1,49)	0.562	0.285	-0.87	21.38	21.50	0.578	2024/4/09	20#
Left Side	18900/1880	20M QPSK(1,49)	0.180	0.091	-0.29	21.38	21.50	0.185	2024/4/09	
Right Side	18900/1880	20M QPSK(1,49)	0.183	0.094	-0.81	21.38	21.50	0.188	2024/4/09	
Bottom Side	18900/1880	20M QPSK(1,49)	0.300	0.148	3.52	21.38	21.50	0.308	2024/4/09	
50%RB										
Front Side	18900/1880	20M QPSK(50,49)	0.198	0.108	-0.18	20.33	21.00	0.231	2024/4/09	
Back Side	18900/1880	20M QPSK(50,49)	0.321	0.148	4.64	20.33	21.00	0.375	2024/4/09	
Left Side	18900/1880	20M QPSK(50,49)	0.092	0.047	-4.03	20.33	21.00	0.107	2024/4/09	
Right Side	18900/1880	20M QPSK(50,49)	0.102	0.050	2.09	20.33	21.00	0.119	2024/4/09	

Bottom Side	18900/1880	20M QPSK(50,49)	0.172	0.075	-4.83	20.33	21.00	0.201	2024/4/09	
-------------	------------	-----------------	-------	-------	-------	-------	-------	-------	-----------	--

NOTE: Hotspot SAR test results of LTE Band 2

10.1.7. SAR measurement Result of LTE Band 4

Test Position of Head	Test channel /Freq.	Mode	SAR Value (W/kg)		Power Drift(%)	Conducted Power (dBm)	Tune-up Power (dBm)	Scaled SAR 1-g (W/Kg)	Date	Plot
			1-g	10-g						
1RB										
Left Cheek	20175/1732.5	20M QPSK(1,99)	0.336	0.196	-0.27	22.97	23.50	0.380	2024/4/10	21#
Left Tilt 15 Degree	20175/1732.5	20M QPSK(1,99)	0.169	0.098	2.79	22.97	23.50	0.191	2024/4/10	
Right Cheek	20175/1732.5	20M QPSK(1,99)	0.288	0.160	3.05	22.97	23.50	0.325	2024/4/10	
Right Tilt 15 Degree	20175/1732.5	20M QPSK(1,99)	0.141	0.081	-2.90	22.97	23.50	0.159	2024/4/10	
50%RB										
Left Cheek	20175/1732.5	20M QPSK(50,49)	0.188	0.102	-2.65	22.04	22.50	0.209	2024/4/10	
Left Tilt 15 Degree	20175/1732.5	20M QPSK(50,49)	0.093	0.052	3.71	22.04	22.50	0.103	2024/4/10	
Right Cheek	20175/1732.5	20M QPSK(50,49)	0.167	0.094	1.13	22.04	22.50	0.186	2024/4/10	
Right Tilt 15 Degree	20175/1732.5	20M QPSK(50,49)	0.074	0.043	2.93	22.04	22.50	0.082	2024/4/10	

NOTE: Head SAR test results of LTE Band 4

Test Position of Body-Worn with	Test channel /Freq.	Test Mode	SAR Value (W/kg)		Power Drift (±5%)	Conducted power (dBm)	Tune-up power (dBm)	Scaled SAR 1g (W/Kg)	Date	Plot
			1g	10g						

10mm											
1RB											
Front Side	20175/1732.5	20M QPSK(1,99)	0.222	0.125	-2.56	22.97	23.50	0.251	2024/4/10		
Back Side	20175/1732.5	20M QPSK(1,99)	0.334	0.194	-3.22	22.97	23.50	0.377	2024/4/10	22#	
50%RB											
Front Side	20175/1732.5	20M QPSK(50,49)	0.127	0.069	0.16	22.04	22.50	0.141	2024/4/10		
Back Side	20175/1732.5	20M QPSK(50,49)	0.176	0.100	0.79	22.04	22.50	0.196	2024/4/10		

NOTE: Body-Worn SAR test results of LTE Band 4

Test Position of Hotspot with 10mm	Test channel /Freq.	Mode	SAR Value (W/kg)		Power Drift(%)	Conducted Power (dBm)	Tune-up Power (dBm)	Scaled SAR 1-g (W/Kg)	Date	Plot
			1-g	10-g						
1RB										
Front Side	20175/1732.5	20M QPSK(1,99)	0.222	0.125	-2.56	22.97	23.50	0.251	2024/4/10	
Back Side	20175/1732.5	20M QPSK(1,99)	0.334	0.194	-3.22	22.97	23.50	0.377	2024/4/10	22#
Left Side	20175/1732.5	20M QPSK(1,99)	0.105	0.060	3.25	22.97	23.50	0.119	2024/4/10	
Right Side	20175/1732.5	20M QPSK(1,99)	0.108	0.063	-1.47	22.97	23.50	0.122	2024/4/10	
Bottom Side	20175/1732.5	20M QPSK(1,99)	0.175	0.102	-3.12	22.97	23.50	0.198	2024/4/10	
50%RB										
Front Side	20175/1732.5	20M QPSK(50,49)	0.127	0.069	0.16	22.04	22.50	0.141	2024/4/10	
Back Side	20175/1732.5	20M QPSK(50,49)	0.176	0.100	0.79	22.04	22.50	0.196	2024/4/10	
Left Side	20175/1732.5	20M QPSK(50,49)	0.058	0.033	4.80	22.04	22.50	0.064	2024/4/10	
Right Side	20175/1732.5	20M QPSK(50,49)	0.065	0.037	0.69	22.04	22.50	0.072	2024/4/10	
Bottom	20175/1732.5	20M QPSK(50,49)	0.104	0.058	2.21	22.04	22.50	0.116	2024/4/10	

1RB										
Front Side	20525/836.5	10M QPSK(1,0)	0.162	0.092	-2.47	23.15	23.50	0.176	2024/4/08	
Back Side	20525/836.5	10M QPSK(1,0)	0.240	0.139	1.02	23.15	23.50	0.260	2024/4/08	24#
50%RB										
Front Side	20525/836.5	10M QPSK(25,0)	0.096	0.046	-3.10	22.16	22.50	0.104	2024/4/08	
Back Side	20525/836.5	10M QPSK(25,0)	0.140	0.070	2.83	22.16	22.50	0.151	2024/4/08	

NOTE: Body-Worn SAR test results of LTE Band 5

Test Position of Hotspot with 10mm	Test channel /Freq.	Mode	SAR Value (W/kg)		Power Drift(%)	Conducted Power (dBm)	Tune-up Power (dBm)	Scaled SAR 1-g (W/Kg)	Date	Plot
			1-g	10-g						
1RB										
Front Side	20525/836.5	10M QPSK(1,0)	0.162	0.092	-2.47	23.15	23.50	0.176	2024/4/08	
Back Side	20525/836.5	10M QPSK(1,0)	0.240	0.139	1.02	23.15	23.50	0.260	2024/4/08	24#
Left Side	20525/836.5	10M QPSK(1,0)	0.087	0.048	0.15	23.15	23.50	0.094	2024/4/08	
Right Side	20525/836.5	10M QPSK(1,0)	0.092	0.051	-0.31	23.15	23.50	0.100	2024/4/08	
Bottom Side	20525/836.5	10M QPSK(1,0)	0.125	0.069	1.85	23.15	23.50	0.135	2024/4/08	
50%RB										
Front Side	20525/836.5	10M QPSK(25,0)	0.096	0.046	-3.10	22.16	22.50	0.104	2024/4/08	
Back Side	20525/836.5	10M QPSK(25,0)	0.140	0.070	2.83	22.16	22.50	0.151	2024/4/08	
Left Side	20525/836.5	10M QPSK(25,0)	0.044	0.029	-3.51	22.16	22.50	0.048	2024/4/08	
Right Side	20525/836.5	10M QPSK(25,0)	0.053	0.030	4.98	22.16	22.50	0.057	2024/4/08	
Bottom Side	20525/836.5	10M QPSK(25,0)	0.066	0.036	3.06	22.16	22.50	0.071	2024/4/08	

NOTE: Hotspot SAR test results of LTE Band 5

10.1.9. SAR measurement Result of LTE Band 7

Test Position of Head	Test channel /Freq.	Mode	SAR Value (W/kg)		Power Drift(%)	Conducted Power (dBm)	Tune-up Power (dBm)	Scaled SAR 1-g (W/Kg)	Date	Plot
			1-g	10-g						
1RB										
Left Cheek	21100/2535	20M QPSK(1,49)	0.438	0.261	1.47	23.04	23.50	0.487	2024/4/16	25#
Left Tilt 15 Degree	21100/2535	20M QPSK(1,49)	0.228	0.133	0.51	23.04	23.50	0.253	2024/4/16	
Right Cheek	21100/2535	20M QPSK(1,49)	0.389	0.232	3.85	23.04	23.50	0.432	2024/4/16	
Right Tilt 15 Degree	21100/2535	20M QPSK(1,49)	0.207	0.123	-0.68	23.04	23.50	0.230	2024/4/16	
50%RB										
Left Cheek	21100/2535	20M QPSK(50,49)	0.249	0.152	-2.00	22.13	22.50	0.271	2024/4/16	
Left Tilt 15 Degree	21100/2535	20M QPSK(50,49)	0.137	0.073	1.24	22.13	22.50	0.149	2024/4/16	
Right Cheek	21100/2535	20M QPSK(50,49)	0.201	0.138	3.95	22.13	22.50	0.219	2024/4/16	
Right Tilt 15 Degree	21100/2535	20M QPSK(50,49)	0.109	0.072	1.92	22.13	22.50	0.119	2024/4/16	

NOTE: Head SAR test results of LTE Band 7

Test Position of Body-Worn with 10mm	Test channel /Freq.	Mode	SAR Value (W/kg)		Power Drift(%)	Conducted Power (dBm)	Tune-up Power (dBm)	Scaled SAR 1-g (W/Kg)	Date	Plot
			1-g	10-g						
1RB										
Front Side	21100/2535	20M QPSK(1,49)	0.425	0.254	-0.29	23.04	23.50	0.472	2024/4/16	
Back Side	21100/2535	20M QPSK(1,49)	0.586	0.329	1.62	23.04	23.50	0.651	2024/4/16	26#
50%RB										

Front Side	21100/2535	20M QPSK(50,49)	0.243	0.143	-2.91	22.13	22.50	0.265	2024/4/16	
Back Side	21100/2535	20M QPSK(50,49)	0.329	0.167	-1.12	22.13	22.50	0.358	2024/4/16	

NOTE: Body-Worn SAR test results of LTE Band 7

Test Position of Hotspot with 10mm	Test channel /Freq.	Mode	SAR Value (W/kg)		Power Drift(%)	Conducted Power (dBm)	Tune-up Power (dBm)	Scaled SAR 1-g (W/Kg)	Date	Plot
			1-g	10-g						
1RB										
Front Side	21100/2535	20M QPSK(1,49)	0.425	0.254	-0.29	23.04	23.50	0.472	2024/4/16	
Back Side	21100/2535	20M QPSK(1,49)	0.586	0.329	1.62	23.04	23.50	0.651	2024/4/16	26#
Left Side	21100/2535	20M QPSK(1,49)	0.186	0.104	-2.40	23.04	23.50	0.207	2024/4/16	
Right Side	21100/2535	20M QPSK(1,49)	0.189	0.107	1.79	23.04	23.50	0.210	2024/4/16	
Bottom Side	21100/2535	20M QPSK(1,49)	0.305	0.163	-3.99	23.04	23.50	0.339	2024/4/16	
50%RB										
Front Side	21100/2535	20M QPSK(50,49)	0.243	0.143	-2.91	22.13	22.50	0.265	2024/4/16	
Back Side	21100/2535	20M QPSK(50,49)	0.329	0.167	-1.12	22.13	22.50	0.358	2024/4/16	
Left Side	21100/2535	20M QPSK(50,49)	0.108	0.061	1.02	22.13	22.50	0.118	2024/4/16	
Right Side	21100/2535	20M QPSK(50,49)	0.112	0.064	0.46	22.13	22.50	0.122	2024/4/16	
Bottom Side	21100/2535	20M QPSK(50,49)	0.176	0.095	4.83	22.13	22.50	0.192	2024/4/16	

NOTE: Hotspot SAR test results of LTE Band 7

10.1.10. SAR measurement Result of LTE Band 12

Test Position of Head	Test channel /Freq.	Mode	SAR Value (W/kg)		Power Drift(%)	Conducted Power (dBm)	Tune-up Power (dBm)	Scaled SAR 1-g (W/Kg)	Date	Plot
			1-g	10-g						

1RB										
Left Cheek	23095/707.5	10M QPSK(1,0)	0.118	0.096	0.27	22.89	23.00	0.121	2024/4/19	27#
Left Tilt 15 Degree	23095/707.5	10M QPSK(1,0)	0.070	0.054	-1.30	22.89	23.00	0.072	2024/4/19	
Right Cheek	23095/707.5	10M QPSK(1,0)	0.111	0.090	-2.53	22.89	23.00	0.114	2024/4/19	
Right Tilt 15 Degree	23095/707.5	10M QPSK(1,0)	0.057	0.045	-2.19	22.89	23.00	0.058	2024/4/19	
50%RB										
Left Cheek	23095/707.5	10M QPSK(25,0)	0.062	0.050	-2.82	21.83	22.00	0.064	2024/4/19	
Left Tilt 15 Degree	23095/707.5	10M QPSK(25,0)	0.042	0.029	-3.59	21.83	22.00	0.044	2024/4/19	
Right Cheek	23095/707.5	10M QPSK(25,0)	0.058	0.047	2.97	21.83	22.00	0.060	2024/4/19	
Right Tilt 15 Degree	23095/707.5	10M QPSK(25,0)	0.030	0.026	-4.48	21.83	22.00	0.031	2024/4/19	

NOTE: Head SAR test results of LTE Band 12

Test Position of Body-Worn with 10mm	Test channel /Freq.	Mode	SAR Value (W/kg)		Power Drift(%)	Conducted Power (dBm)	Tune-up Power (dBm)	Scaled SAR 1-g (W/Kg)	Date	Plot
			1-g	10-g						
1RB										
Front Side	23095/707.5	10M QPSK(1,0)	0.150	0.115	-2.99	22.89	23.00	0.154	2024/4/19	
Back Side	23095/707.5	10M QPSK(1,0)	0.239	0.183	-0.75	22.89	23.00	0.245	2024/4/19	28#
50%RB										
Front Side	23095/707.5	10M QPSK(25,0)	0.076	0.060	-0.01	21.83	22.00	0.079	2024/4/19	
Back Side	23095/707.5	10M QPSK(25,0)	0.128	0.106	-0.04	21.83	22.00	0.133	2024/4/19	

NOTE: Body-Worn SAR test results of LTE Band 12

Test Position of Hotspot	Test channel /Freq.	Mode	SAR Value (W/kg)		Power Drift(%)	Conducted Power (dBm)	Tune-up Power (dBm)	Scaled SAR 1-g (W/Kg)	Date	Plot
			1-g	10-g						

with 10mm										
1RB										
Front Side	23095/707.5	10M QPSK(1,0)	0.150	0.115	-2.99	22.89	23.00	0.154	2024/4/19	
Back Side	23095/707.5	10M QPSK(1,0)	0.239	0.183	-0.75	22.89	23.00	0.245	2024/4/19	28#
Left Side	23095/707.5	10M QPSK(1,0)	0.078	0.057	1.55	22.89	23.00	0.080	2024/4/19	
Right Side	23095/707.5	10M QPSK(1,0)	0.082	0.060	0.26	22.89	23.00	0.084	2024/4/19	
Bottom Side	23095/707.5	10M QPSK(1,0)	0.135	0.099	3.32	22.89	23.00	0.138	2024/4/19	
50%RB										
Front Side	23095/707.5	10M QPSK(25,0)	0.076	0.060	-0.01	21.83	22.00	0.079	2024/4/19	
Back Side	23095/707.5	10M QPSK(25,0)	0.128	0.106	-0.04	21.83	22.00	0.133	2024/4/19	
Left Side	23095/707.5	10M QPSK(25,0)	0.040	0.033	-4.19	21.83	22.00	0.042	2024/4/19	
Right Side	23095/707.5	10M QPSK(25,0)	0.043	0.035	-4.58	21.83	22.00	0.045	2024/4/19	
Bottom Side	23095/707.5	10M QPSK(25,0)	0.078	0.053	4.04	21.83	22.00	0.081	2024/4/19	

NOTE: Hotspot SAR test results of LTE Band 12

10.1.11. SAR measurement Result of LTE Band 17

Test Position of Head	Test channel /Freq.	Mode	SAR Value (W/kg)		Power Drift(%)	Conducted Power (dBm)	Tune-up Power (dBm)	Scaled SAR 1-g (W/Kg)	Date	Plot
			1-g	10-g						
1RB										
Left Cheek	23790/710	10M QPSK(1,0)	0.116	0.094	0.41	22.73	23.00	0.123	2024/4/19	29#
Left Tilt 15 Degree	23790/710	10M QPSK(1,0)	0.062	0.049	-0.71	22.73	23.00	0.066	2024/4/19	
Right	23790/710	10M QPSK(1,0)	0.106	0.082	-3.13	22.73	23.00	0.113	2024/4/19	

Cheek										
Right Tilt 15 Degree	23790/710	10M QPSK(1,0)	0.056	0.045	-3.95	22.73	23.00	0.060	2024/4/19	
50%RB										
Left Cheek	23790/710	10M QPSK(25,0)	0.066	0.053	0.51	21.69	22.00	0.071	2024/4/19	
Left Tilt 15 Degree	23790/710	10M QPSK(25,0)	0.034	0.027	-1.48	21.69	22.00	0.037	2024/4/19	
Right Cheek	23790/710	10M QPSK(25,0)	0.057	0.048	4.26	21.69	22.00	0.061	2024/4/19	
Right Tilt 15 Degree	23790/710	10M QPSK(25,0)	0.028	0.027	-1.38	21.69	22.00	0.030	2024/4/19	

NOTE: Head SAR test results of LTE Band 17

Test Position of Body-Worn with 10mm	Test channel /Freq.	Mode	SAR Value (W/kg)		Power Drift(%)	Conducted Power (dBm)	Tune-up Power (dBm)	Scaled SAR 1-g (W/Kg)	Date	Plot
			1-g	10-g						
1RB										
Front Side	23790/710	10M QPSK(1,0)	0.162	0.118	0.32	22.73	23.00	0.172	2024/4/19	
Back Side	23790/710	10M QPSK(1,0)	0.235	0.179	-0.87	22.73	23.00	0.250	2024/4/19	30#
50%RB										
Front Side	23790/710	10M QPSK(25,0)	0.090	0.064	-3.45	21.69	22.00	0.097	2024/4/19	
Back Side	23790/710	10M QPSK(25,0)	0.139	0.093	-1.77	21.69	22.00	0.149	2024/4/19	

NOTE: Body-Worn SAR test results of LTE Band 17

Test Position of Hotspot with 10mm	Test channel /Freq.	Mode	SAR Value (W/kg)		Power Drift(%)	Conducted Power (dBm)	Tune-up Power (dBm)	Scaled SAR 1-g (W/Kg)	Date	Plot
			1-g	10-g						
1RB										
Front Side	23790/710	10M QPSK(1,0)	0.162	0.118	0.32	22.73	23.00	0.172	2024/4/19	
Back Side	23790/710	10M QPSK(1,0)	0.235	0.179	-0.87	22.73	23.00	0.250	2024/4/19	30#

Left Side	23790/710	10M QPSK(1,0)	0.075	0.055	2.25	22.73	23.00	0.080	2024/4/19	
Right Side	23790/710	10M QPSK(1,0)	0.084	0.063	-3.81	22.73	23.00	0.089	2024/4/19	
Bottom Side	23790/710	10M QPSK(1,0)	0.140	0.102	-0.35	22.73	23.00	0.149	2024/4/19	
50%RB										
Front Side	23790/710	10M QPSK(25,0)	0.090	0.064	-3.45	21.69	22.00	0.097	2024/4/19	
Back Side	23790/710	10M QPSK(25,0)	0.139	0.093	-1.77	21.69	22.00	0.149	2024/4/19	
Left Side	23790/710	10M QPSK(25,0)	0.044	0.028	-2.25	21.69	22.00	0.047	2024/4/19	
Right Side	23790/710	10M QPSK(25,0)	0.046	0.034	-1.40	21.69	22.00	0.049	2024/4/19	
Bottom Side	23790/710	10M QPSK(25,0)	0.079	0.057	-0.75	21.69	22.00	0.085	2024/4/19	

NOTE: Hotspot SAR test results of LTE Band 17

10.1.12. SAR measurement Result of LTE Band 38

Test Position of Head	Test channel /Freq.	Mode	SAR Value (W/kg)		Power Drift(%)	Conducted Power (dBm)	Tune-up Power (dBm)	Scaled SAR 1-g (W/Kg)	Date	Plot
			1-g	10-g						
1RB										
Left Cheek	38000/2595	20M QPSK(1,49)	0.347	0.199	2.01	23.02	23.50	0.388	2024/4/16	31#
Left Tilt 15 Degree	38000/2595	20M QPSK(1,49)	0.189	0.108	3.84	23.02	23.50	0.211	2024/4/16	
Right Cheek	38000/2595	20M QPSK(1,49)	0.317	0.180	-2.84	23.02	23.50	0.354	2024/4/16	
Right Tilt 15 Degree	38000/2595	20M QPSK(1,49)	0.155	0.085	-1.91	23.02	23.50	0.173	2024/4/16	
50%RB										
Left Cheek	38000/2595	20M QPSK(50,24)	0.191	0.108	1.97	22.00	22.00	0.191	2024/4/16	

Left Tilt 15 Degree	38000/2595	20M QPSK(50,24)	0.113	0.063	-0.26	22.00	22.00	0.113	2024/4/16	
Right Cheek	38000/2595	20M QPSK(50,24)	0.183	0.103	-4.14	22.00	22.00	0.183	2024/4/16	
Right Tilt 15 Degree	38000/2595	20M QPSK(50,24)	0.086	0.048	-2.43	22.00	22.00	0.086	2024/4/16	

NOTE: Head SAR test results of LTE Band 38

Test Position of Body-Worn with 10mm	Test channel /Freq.	Mode	SAR Value (W/kg)		Power Drift(%)	Conducted Power (dBm)	Tune-up Power (dBm)	Scaled SAR 1-g (W/Kg)	Date	Plot
			1-g	10-g						
1RB										
Front Side	38000/2595	20M QPSK(1,49)	0.252	0.154	-2.75	23.02	23.50	0.281	2024/4/16	
Back Side	38000/2595	20M QPSK(1,49)	0.400	0.249	4.83	23.02	23.50	0.447	2024/4/16	32#
50%RB										
Front Side	38000/2595	20M QPSK(50,24)	0.142	0.085	-3.30	22.00	22.00	0.142	2024/4/16	
Back Side	38000/2595	20M QPSK(50,24)	0.228	0.141	0.48	22.00	22.00	0.228	2024/4/16	

NOTE: Body-Worn SAR test results of LTE Band 38

Test Position of Hotspot with 10mm	Test channel /Freq.	Mode	SAR Value (W/kg)		Power Drift(%)	Conducted Power (dBm)	Tune-up Power (dBm)	Scaled SAR 1-g (W/Kg)	Date	Plot
			1-g	10-g						
1RB										
Front Side	38000/2595	20M QPSK(1,49)	0.252	0.154	-2.75	23.02	23.50	0.281	2024/4/16	
Back Side	38000/2595	20M QPSK(1,49)	0.400	0.249	4.83	23.02	23.50	0.447	2024/4/16	32#
Left Side	38000/2595	20M QPSK(1,49)	0.129	0.079	0.47	23.02	23.50	0.144	2024/4/16	
Right Side	38000/2595	20M QPSK(1,49)	0.132	0.084	-1.29	23.02	23.50	0.147	2024/4/16	
Bottom Side	38000/2595	20M QPSK(1,49)	0.220	0.130	-2.23	23.02	23.50	0.246	2024/4/16	
50%RB										

Front Side	38000/2595	20M QPSK(50,24)	0.142	0.085	-3.30	22.00	22.00	0.142	2024/4/16	
Back Side	38000/2595	20M QPSK(50,24)	0.228	0.141	0.48	22.00	22.00	0.228	2024/4/16	
Left Side	38000/2595	20M QPSK(50,24)	0.073	0.045	1.49	22.00	22.00	0.073	2024/4/16	
Right Side	38000/2595	20M QPSK(50,24)	0.075	0.048	3.79	22.00	22.00	0.075	2024/4/16	
Bottom Side	38000/2595	20M QPSK(50,24)	0.123	0.070	2.68	22.00	22.00	0.123	2024/4/16	

NOTE: Hotspot SAR test results of LTE Band 38

10.1.13. SAR measurement Result of LTE Band 41

Test Position of Head	Test channel /Freq.	Mode	SAR Value (W/kg)		Power Drift(%)	Conducted Power (dBm)	Tune-up Power (dBm)	Scaled SAR 1-g (W/Kg)	Date	Plot
			1-g	10-g						
1RB										
Left Cheek	40620/2593	20M QPSK(1,49)	0.322	0.208	2.38	24.92	25.00	0.328	2024/4/16	33#
Left Tilt 15 Degree	40620/2593	20M QPSK(1,49)	0.187	0.120	0.29	24.92	25.00	0.190	2024/4/16	
Right Cheek	40620/2593	20M QPSK(1,49)	0.292	0.183	-2.29	24.92	25.00	0.297	2024/4/16	
Right Tilt 15 Degree	40620/2593	20M QPSK(1,49)	0.149	0.096	-0.10	24.92	25.00	0.152	2024/4/16	
50%RB										
Left Cheek	40620/2593	20M QPSK(50,0)	0.187	0.124	0.15	24.02	24.50	0.209	2024/4/16	
Left Tilt 15 Degree	40620/2593	20M QPSK(50,0)	0.107	0.064	-3.69	24.02	24.50	0.120	2024/4/16	
Right Cheek	40620/2593	20M QPSK(50,0)	0.160	0.109	-1.22	24.02	24.50	0.179	2024/4/16	
Right Tilt 15 Degree	40620/2593	20M QPSK(50,0)	0.080	0.055	-0.94	24.02	24.50	0.089	2024/4/16	

Degree										
--------	--	--	--	--	--	--	--	--	--	--

NOTE: Head SAR test results of LTE Band 41

Test Position of Body-Worn with 10mm	Test channel /Freq.	Mode	SAR Value (W/kg)		Power Drift(%)	Conducted Power (dBm)	Tune-up Power (dBm)	Scaled SAR 1-g (W/Kg)	Date	Plot
			1-g	10-g						
1RB										
Front Side	40620/2593	20M QPSK(1,49)	0.192	0.128	-0.66	24.92	25.00	0.196	2024/4/16	
Back Side	40620/2593	20M QPSK(1,49)	0.292	0.194	-1.30	24.92	25.00	0.297	2024/4/16	34#
50%RB										
Front Side	40620/2593	20M QPSK(50,0)	0.104	0.066	4.98	24.02	24.50	0.116	2024/4/16	
Back Side	40620/2593	20M QPSK(50,0)	0.153	0.101	4.60	24.02	24.50	0.171	2024/4/16	

NOTE: Body-Worn SAR test results of LTE Band 41

Test Position of Hotspot with 10mm	Test channel /Freq.	Mode	SAR Value (W/kg)		Power Drift(%)	Conducted Power (dBm)	Tune-up Power (dBm)	Scaled SAR 1-g (W/Kg)	Date	Plot
			1-g	10-g						
1RB										
Front Side	40620/2593	20M QPSK(1,49)	0.192	0.128	-0.66	24.92	25.00	0.196	2024/4/16	
Back Side	40620/2593	20M QPSK(1,49)	0.292	0.194	-1.30	24.92	25.00	0.297	2024/4/16	34#
Left Side	40620/2593	20M QPSK(1,49)	0.090	0.057	-0.75	24.92	25.00	0.092	2024/4/16	
Right Side	40620/2593	20M QPSK(1,49)	0.093	0.059	-2.04	24.92	25.00	0.095	2024/4/16	
Bottom Side	40620/2593	20M QPSK(1,49)	0.150	0.096	-0.67	24.92	25.00	0.153	2024/4/16	
50%RB										
Front Side	40620/2593	20M QPSK(50,0)	0.104	0.066	4.98	24.02	24.50	0.116	2024/4/16	
Back Side	40620/2593	20M QPSK(50,0)	0.153	0.101	4.60	24.02	24.50	0.171	2024/4/16	
Left Side	40620/2593	20M QPSK(50,0)	0.053	0.034	-4.89	24.02	24.50	0.059	2024/4/16	
Right Side	40620/2593	20M	0.055	0.037	-2.29	24.02	24.50	0.061	2024/4/16	

Side		QPSK(50,0)								
Bottom Side	40620/2593	20M QPSK(50,0)	0.087	0.052	-2.34	24.02	24.50	0.097	2024/4/16	

NOTE: Hotspot SAR test results of LTE Band 41

10.1.14. SAR measurement Result of NR n78

Test Position of Head	Test channel /Freq.	Mode	SAR Value (W/kg)		Power Drift(%)	Conducted Power (dBm)	Tune-up Power (dBm)	Scaled SAR 1-g (W/Kg)	Date	Plot
			1-g	10-g						
1RB										
Left Cheek	633333/3499.99	100M QPSK(1,1)	0.135	0.093	-2.05	27.27	28.00	0.160	2024/4/7	35#
Left Tilt 15 Degree	633333/3499.99	100M QPSK(1,1)	0.074	0.050	-1.11	27.27	28.00	0.088	2024/4/7	
Right Cheek	633333/3499.99	100M QPSK(1,1)	0.118	0.081	-0.19	27.27	28.00	0.140	2024/4/7	
Right Tilt 15 Degree	633333/3499.99	100M QPSK(1,1)	0.065	0.043	1.73	27.27	28.00	0.077	2024/4/7	
50%RB										
Left Cheek	633333/3499.99	100M QPSK(135,67)	0.070	0.052	-3.83	27.59	28.00	0.077	2024/4/7	
Left Tilt 15 Degree	633333/3499.99	100M QPSK(135,67)	0.039	0.027	2.30	27.59	28.00	0.043	2024/4/7	
Right Cheek	633333/3499.99	100M QPSK(135,67)	0.063	0.048	0.04	27.59	28.00	0.069	2024/4/7	
Right Tilt 15 Degree	633333/3499.99	100M QPSK(135,67)	0.033	0.025	-0.92	27.59	28.00	0.036	2024/4/7	

NOTE: Head SAR test results of NR n78

Test Position of Body-Worn with 10mm	Test channel /Freq.	Mode	SAR Value (W/kg)		Power Drift(%)	Conducted Power (dBm)	Tune-up Power (dBm)	Scaled SAR 1-g (W/Kg)	Date	Plot
			1-g	10-g						

1RB										
Front Side	633333/3499.99	100M QPSK(1,1)	0.084	0.057	-3.81	27.27	28.00	0.099	2024/4/7	
Back Side	633333/3499.99	100M QPSK(1,1)	0.101	0.071	2.35	27.27	28.00	0.119	2024/4/7	36#
50%RB										
Front Side	633333/3499.99	100M QPSK(135,67)	0.049	0.032	1.66	27.59	28.00	0.054	2024/4/7	
Back Side	633333/3499.99	100M QPSK(135,67)	0.055	0.041	2.50	27.59	28.00	0.060	2024/4/7	

NOTE: Body-Worn SAR test results of NR n78

Test Position of Hotspot with 10mm	Test channel /Freq.	Mode	SAR Value (W/kg)		Power Drift(%)	Conducted Power (dBm)	Tune-up Power (dBm)	Scaled SAR 1-g (W/Kg)	Date	Plot
			1-g	10-g						
1RB										
Front Side	633333/3499.99	100M QPSK(1,1)	0.084	0.057	-3.81	27.27	28.00	0.099	2024/4/7	
Back Side	633333/3499.99	100M QPSK(1,1)	0.101	0.071	2.35	27.27	28.00	0.119	2024/4/7	36#
Left Side	633333/3499.99	100M QPSK(1,1)	0.039	0.027	-0.98	27.27	28.00	0.046	2024/4/7	
Top Side	633333/3499.99	100M QPSK(1,1)	0.045	0.031	1.37	27.27	28.00	0.053	2024/4/7	
50%RB										
Front Side	633333/3499.99	100M QPSK(135,67)	0.049	0.032	1.66	27.59	28.00	0.054	2024/4/7	
Back Side	633333/3499.99	100M QPSK(135,67)	0.055	0.041	2.50	27.59	28.00	0.060	2024/4/7	
Left Side	633333/3499.99	100M QPSK(135,67)	0.021	0.014	4.01	27.59	28.00	0.023	2024/4/7	
Top Side	633333/3499.99	100M QPSK(135,67)	0.025	0.017	4.88	27.59	28.00	0.027	2024/4/7	

NOTE: Hotspot SAR test results of NR n78

10.1.15. SAR measurement Result of WLAN2.4G

Test Position of Head	Test channel /Freq.	Mode	SAR Value (W/kg)		Power Drift(%)	Conducted Power (dBm)	Tune-up Power (dBm)	Scaled SAR 1-g	Date	Plot
			1-g	10-g						

								(W/Kg)		
Left Cheek	6/2437	802.11b	0.221	0.105	-1.18	17.42	17.50	0.225	2024/4/12	17#
Left Tilt 15 Degree	6/2437	802.11b	0.118	0.054	3.58	17.42	17.50	0.120	2024/4/12	
Right Cheek	6/2437	802.11b	0.205	0.095	-0.76	17.42	17.50	0.209	2024/4/12	
Right Tilt 15 Degree	6/2437	802.11b	0.107	0.050	2.38	17.42	17.50	0.109	2024/4/12	

NOTE: Head SAR test results of WLAN2.4G

Test Position of Body-Worn with 10mm	Test channel /Freq.	Mode	SAR Value (W/kg)		Power Drift(%)	Conducted Power (dBm)	Tune-up Power (dBm)	Scaled SAR 1-g (W/Kg)	Date	Plot
			1-g	10-g						
Front Side	6/2437	802.11b	0.036	0.023	-0.36	17.42	17.50	0.037	2024/4/12	
Back Side	6/2437	802.11b	0.058	0.037	1.21	17.42	17.50	0.059	2024/4/12	18#

NOTE: Body-worn SAR test results of WLAN2.4G

Test Position of Hotspot with 10mm	Test channel /Freq.	Mode	SAR Value (W/kg)		Power Drift(%)	Conducted Power (dBm)	Tune-up Power (dBm)	Scaled SAR 1-g (W/Kg)	Date	Plot
			1-g	10-g						
Front Side	6/2437	802.11b	0.036	0.023	-0.36	17.42	17.50	0.037	2024/4/12	
Back Side	6/2437	802.11b	0.058	0.037	1.21	17.42	17.50	0.059	2024/4/12	18#
Right Side	6/2437	802.11b	0.024	0.015	0.70	17.42	17.50	0.024	2024/4/12	
Top Side	6/2437	802.11b	0.030	0.018	-1.99	17.42	17.50	0.031	2024/4/12	

NOTE: Hotspot SAR test results of WLAN2.4G

10.1.16. SAR measurement Result of WLAN5.2G

Test	Test	Mode	SAR Value (W/kg)	Power	Conducted	Tune-up	Scaled	Date	Plot
------	------	------	------------------	-------	-----------	---------	--------	------	------

Position of Head	channel /Freq.		1-g	10-g	Drift(%)	Power (dBm)	Power (dBm)	SAR 1-g (W/Kg)		
Left Cheek	46/5230	802.11ac VHT40	0.141	0.079	-1.93	12.18	12.50	0.152	2024/4/21	13#
Left Tilt 15 Degree	46/5230	802.11ac VHT40	0.079	0.042	3.42	12.18	12.50	0.085	2024/4/21	
Right Cheek	46/5230	802.11ac VHT40	0.123	0.067	-2.61	12.18	12.50	0.132	2024/4/21	
Right Tilt 15 Degree	46/5230	802.11ac VHT40	0.056	0.030	-3.49	12.18	12.50	0.060	2024/4/21	

NOTE: Head SAR test results of WLAN5.2G

Test Position of Body-Worn with 10mm	Test channel /Freq.	Mode	SAR Value (W/kg)		Power Drift(%)	Conducted Power (dBm)	Tune-up Power (dBm)	Scaled SAR 1-g (W/Kg)	Date	Plot
			1-g	10-g						
Front Side	46/5230	802.11ac VHT40	0.102	0.085	-2.01	12.18	12.50	0.110	2024/4/21	
Back Side	46/5230	802.11ac VHT40	0.125	0.106	-2.06	12.18	12.50	0.135	2024/4/21	15#

NOTE: Body-worn SAR test results of WLAN5.2G

Test Position of Hotspot with 10mm	Test channel /Freq.	Mode	SAR Value (W/kg)		Power Drift(%)	Conducted Power (dBm)	Tune-up Power (dBm)	Scaled SAR 1-g (W/Kg)	Date	Plot
			1-g	10-g						
Front Side	46/5230	802.11ac VHT40	0.102	0.085	-2.01	12.18	12.50	0.110	2024/4/21	
Back Side	46/5230	802.11ac VHT40	0.125	0.106	-2.06	12.18	12.50	0.135	2024/4/21	15#
Right Side	46/5230	802.11ac VHT40	0.051	0.043	0.79	12.18	12.50	0.055	2024/4/21	
Top Side	46/5230	802.11ac VHT40	0.055	0.045	-3.72	12.18	12.50	0.059	2024/4/21	

NOTE: Hotspot SAR test results of WLAN5.2G

10.1.17. SAR measurement Result of WLAN5.8G

Test Position of Head	Test channel /Freq.	Mode	SAR Value (W/kg)		Power Drift(%)	Conducted Power (dBm)	Tune-up Power (dBm)	Scaled SAR 1-g (W/Kg)	Date	Plot
			1-g	10-g						
Left Cheek	159/5795	802.11ac VHT40	0.141	0.076	-2.83	11.50	12.00	0.158	2024/4/20	14#
Left Tilt 15 Degree	159/5795	802.11ac VHT40	0.074	0.038	-3.08	11.50	12.00	0.083	2024/4/20	
Right Cheek	159/5795	802.11ac VHT40	0.131	0.067	-2.90	11.50	12.00	0.147	2024/4/20	
Right Tilt 15 Degree	159/5795	802.11ac VHT40	0.068	0.036	-2.05	11.50	12.00	0.076	2024/4/20	

NOTE: Head SAR test results of WLAN5.8G

Test Position of Body-Worn with 10mm	Test channel /Freq.	Mode	SAR Value (W/kg)		Power Drift(%)	Conducted Power (dBm)	Tune-up Power (dBm)	Scaled SAR 1-g (W/Kg)	Date	Plot
			1-g	10-g						
Front Side	159/5795	802.11ac VHT40	0.084	0.062	0.57	11.50	12.00	0.094	2024/4/20	
Back Side	159/5795	802.11ac VHT40	0.114	0.089	0.68	11.50	12.00	0.128	2024/4/20	16#

NOTE: Body-worn SAR test results of WLAN5.8G

Test Position of Hotspot with 10mm	Test channel /Freq.	Mode	SAR Value (W/kg)		Power Drift(%)	Conducted Power (dBm)	Tune-up Power (dBm)	Scaled SAR 1-g (W/Kg)	Date	Plot
			1-g	10-g						
Front Side	159/5795	802.11ac VHT40	0.084	0.062	0.57	11.50	12.00	0.094	2024/4/20	
Back Side	159/5795	802.11ac VHT40	0.114	0.089	0.68	11.50	12.00	0.128	2024/4/20	16#
Right Side	159/5795	802.11ac VHT40	0.036	0.028	0.06	11.50	12.00	0.040	2024/4/20	
Top Side	159/5795	802.11ac VHT40	0.040	0.032	2.96	11.50	12.00	0.045	2024/4/20	

NOTE: Hotspot SAR test results of WLAN5.8G

10.1.18. SAR measurement Result of Bluetooth

Test Position of Head	Test channel /Freq.	Mode	SAR Value (W/kg)		Power Drift(%)	Conducted Power (dBm)	Tune-up Power (dBm)	Scaled SAR 1-g (W/Kg)	Date	Plot
			1-g	10-g						
Left Cheek	78/2480	1DH5	0.212	0.109	-3.34	9.81	10.00	0.221	2024/4/12	11#
Left Tilt 15 Degree	78/2480	1DH5	0.110	0.055	-2.23	9.81	10.00	0.115	2024/4/12	
Right Cheek	78/2480	1DH5	0.186	0.096	-2.36	9.81	10.00	0.194	2024/4/12	
Right Tilt 15 Degree	78/2480	1DH5	0.092	0.046	0.31	9.81	10.00	0.096	2024/4/12	

NOTE: Head SAR test results of Bluetooth

Test Position of Body-Worn with 10mm	Test channel /Freq.	Mode	SAR Value (W/kg)		Power Drift(%)	Conducted Power (dBm)	Tune-up Power (dBm)	Scaled SAR 1-g (W/Kg)	Date	Plot
			1-g	10-g						
Front Side	78/2480	1DH5	0.050	0.029	2.39	9.81	10.00	0.052	2024/4/12	
Back Side	78/2480	1DH5	0.060	0.036	-0.76	9.81	10.00	0.063	2024/4/12	12#

NOTE: Body-worn SAR test results of Bluetooth

Test Position of Hotspot with 10mm	Test channel /Freq.	Mode	SAR Value (W/kg)		Power Drift(%)	Conducted Power (dBm)	Tune-up Power (dBm)	Scaled SAR 1-g (W/Kg)	Date	Plot
			1-g	10-g						
Front Side	78/2480	1DH5	0.050	0.029	2.39	9.81	10.00	0.052	2024/4/12	
Back Side	78/2480	1DH5	0.060	0.036	-0.76	9.81	10.00	0.063	2024/4/12	12#
Right	78/2480	1DH5	0.021	0.012	-1.00	9.81	10.00	0.022	2024/4/12	

Side									
Top Side	78/2480	1DH5	0.027	0.015	-3.71	9.81	10.00	0.028	2024/4/12

NOTE: Hotspot SAR test results of Bluetooth

10.2. Simultaneous Transmission Analysis

Per KDB 447498 D01, simultaneous transmission SAR is compliant if,

- 1) Scalar SAR summation $< 1.6\text{W/kg}$.
- 2) $\text{SPLSR} = (\text{SAR}_1 + \text{SAR}_2)^{1.5} / (\text{min. separation distance, mm})$, and the peak separation distance is determined from the square root of $[(x_1-x_2)^2 + (y_1-y_2)^2 + (z_1-z_2)^2]$, where (x_1, y_1, z_1) and (x_2, y_2, z_2) are the coordinates of the extrapolated peak SAR locations in the zoom scan. If $\text{SPLSR} \leq 0.04$, simultaneously transmission SAR measurement is not necessary.

Test Position		Scaled SAR _{MAX}		Σ 1-g SAR (W/Kg)	SPLSR	Remark
		WWAN	DTS			
Head	Left Cheek	0.487	0.225	0.712	N/A	N/A
	Left Tilt 15 Degree	0.253	0.120	0.373	N/A	N/A
	Right Cheek	0.432	0.209	0.641	N/A	N/A
	Right Tilt 15 Degree	0.230	0.109	0.339	N/A	N/A
Body-Worn	Front Side	0.472	0.037	0.509	N/A	N/A
	Back Side	0.651	0.059	0.710	N/A	N/A
Hotspot	Front Side	0.472	0.037	0.509	N/A	N/A
	Back Side	0.651	0.059	0.710	N/A	N/A
	Left Side	0.207	N/A	0.207	N/A	N/A
	Right Side	0.210	0.024	0.234	N/A	N/A
	Top Side	N/A	0.031	0.031	N/A	N/A
	Bottom Side	0.339	N/A	0.339	N/A	N/A

Test Position		Scaled SAR _{MAX}		Σ 1-g SAR (W/Kg)	SPLSR	Remark
		WWAN	NII			
Head	Left Cheek	0.487	0.158	0.645	N/A	N/A
	Left Tilt 15 Degree	0.253	0.085	0.338	N/A	N/A
	Right Cheek	0.432	0.147	0.579	N/A	N/A

	Right Tilt 15 Degree	0.230	0.076	0.306	N/A	N/A
Body-Worn	Front Side	0.472	0.110	0.582	N/A	N/A
	Back Side	0.651	0.135	0.786	N/A	N/A
Hotspot	Front Side	0.472	0.110	0.582	N/A	N/A
	Back Side	0.651	0.135	0.786	N/A	N/A
	Left Side	0.207	N/A	0.207	N/A	N/A
	Right Side	0.210	0.055	0.265	N/A	N/A
	Top Side	N/A	0.059	0.059	N/A	N/A
	Bottom Side	0.339	N/A	0.339	N/A	N/A

Test Position		Scaled SAR _{MAX}		Σ 1-g SAR (W/Kg)	SPLSR	Remark
		WWAN	DSS			
Head	Left Cheek	0.487	0.221	0.708	N/A	N/A
	Left Tilt 15 Degree	0.253	0.115	0.368	N/A	N/A
	Right Cheek	0.432	0.194	0.626	N/A	N/A
	Right Tilt 15 Degree	0.230	0.096	0.326	N/A	N/A
Body-Worn	Front Side	0.472	0.052	0.524	N/A	N/A
	Back Side	0.651	0.063	0.714	N/A	N/A
Hotspot	Front Side	0.472	0.052	0.524	N/A	N/A
	Back Side	0.651	0.063	0.714	N/A	N/A
	Left Side	0.207	N/A	0.207	N/A	N/A
	Right Side	0.210	0.022	0.232	N/A	N/A
	Top Side	N/A	0.028	0.028	N/A	N/A
	Bottom Side	0.339	N/A	0.339	N/A	N/A

Test Position		Scaled SAR _{MAX}			Σ 1-g SAR (W/Kg)	SPLSR	Remark
		LTE Band 2	NR n78	WIFI/BT			
Head	Left Cheek	0.227	0.160	0.225	0.612	N/A	N/A
	Left Tilt 15 Degree	0.119	0.088	0.120	0.327	N/A	N/A
	Right	0.209	0.140	0.209	0.558	N/A	N/A

	Cheek						
	Right Tilt 15 Degree	0.095	0.077	0.109	0.281	N/A	N/A
Body-Worn	Front Side	0.364	0.099	0.110	0.573	N/A	N/A
	Back Side	0.578	0.119	0.135	0.832	N/A	N/A
Hotspot	Front Side	0.364	0.099	0.110	0.573	N/A	N/A
	Back Side	0.578	0.119	0.135	0.832	N/A	N/A
	Left Side	0.185	0.046	N/A	0.231	N/A	N/A
	Right Side	0.188	N/A	0.055	0.243	N/A	N/A
	Top Side	N/A	0.053	0.059	0.112	N/A	N/A
	Bottom Side	0.308	N/A	N/A	0.308	N/A	N/A

11. Appendix A. Photo documentation

Refer to appendix Test Setup photo---SAR

12. Appendix B. System Check Plots

Table of contents
MEASUREMENT 1 System Performance Check - 750MHz
MEASUREMENT 2 System Performance Check - 835MHz
MEASUREMENT 3 System Performance Check - 1800MHz
MEASUREMENT 4 System Performance Check - 1900MHz
MEASUREMENT 5 System Performance Check - 2450MHz
MEASUREMENT 6 System Performance Check - 2600MHz
MEASUREMENT 7 System Performance Check - 3500MHz
MEASUREMENT 8 System Performance Check - 5200MHz
MEASUREMENT 9 System Performance Check - 5800MHz

MEASUREMENT 1

Date of measurement: 19/4/2024

A. Experimental conditions.

<u>Area Scan</u>	<u>dx=15mm dy=15mm, h= 5.00 mm</u>
<u>ZoomScan</u>	<u>5x5x7, dx=8mm dy=8mm dz=5mm</u>
<u>Phantom</u>	<u>Validation plane</u>
<u>Device Position</u>	<u>Dipole</u>
<u>Band</u>	<u>CW750</u>
<u>Channels</u>	<u>Middle</u>
<u>Signal</u>	<u>CW (Crest factor: 1.0)</u>
<u>ConvF</u>	<u>2.37</u>

B. SAR Measurement Results

Frequency (MHz)	750.000000
Relative permittivity (real part)	41.072612
Relative permittivity (imaginary part)	21.692421
Conductivity (S/m)	0.903851
Variation (%)	2.730000

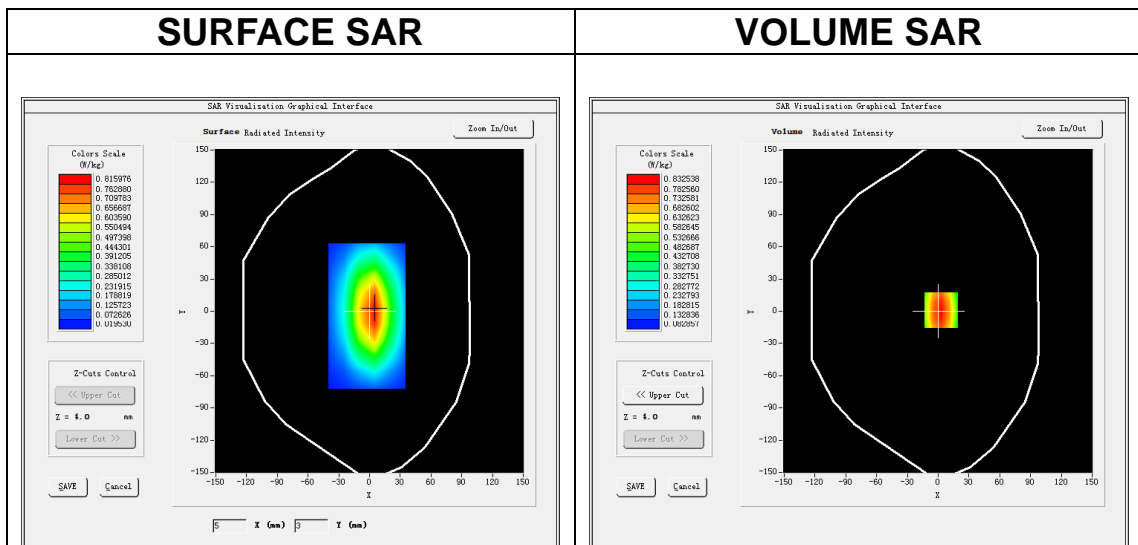

Maximum location: X=3.00, Y=1.00
SAR Peak: 1.14 W/kg

SAR 10g (W/Kg)	0.585332
SAR 1g (W/Kg)	0.834321

Z (mm)	0.00	4.00	9.00	14.00	19.00	24.00	29.00
SAR (W/Kg)	1.1492	0.8317	0.5683	0.3987	0.2835	0.2035	0.1445

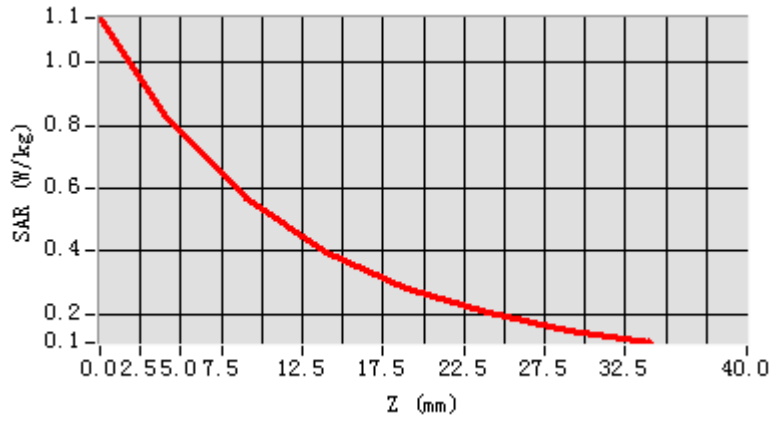

3D screen shot

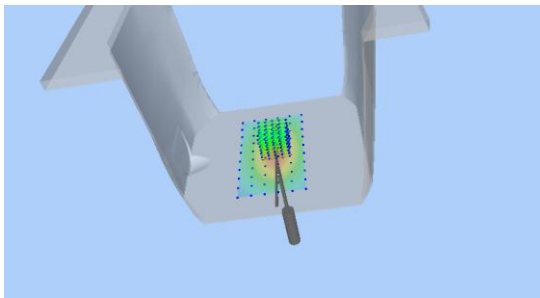

Hot spot position

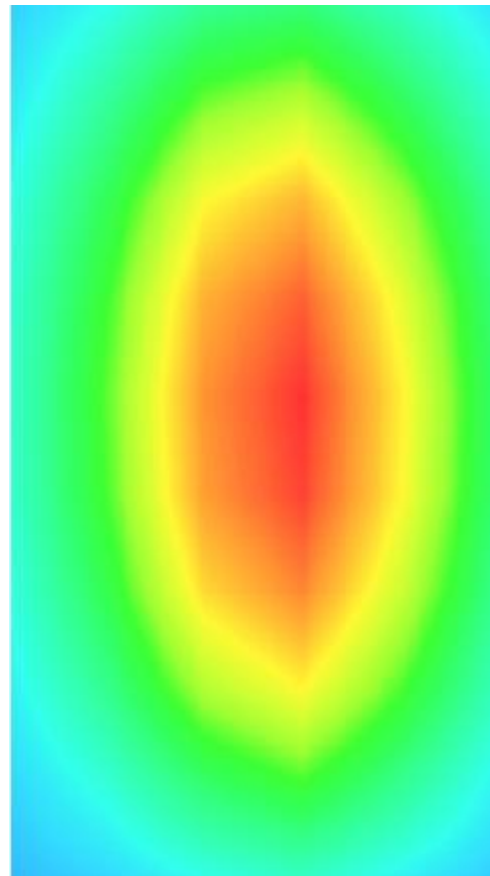

MEASUREMENT 2

Date of measurement: 8/4/2024

A. Experimental conditions.

Area Scan	<u>dx=15mm dy=15mm, h= 5.00 mm</u>
ZoomScan	<u>5x5x7, dx=8mm dy=8mm dz=5mm</u>
Phantom	<u>Validation plane</u>
Device Position	<u>Dipole</u>
Band	<u>CW835</u>
Channels	<u>Middle</u>
Signal	<u>CW (Crest factor: 1.0)</u>
ConvF	<u>2.32</u>

B. SAR Measurement Results

Frequency (MHz)	835.000000
Relative permittivity (real part)	40.997718
Relative permittivity (imaginary part)	19.075080
Conductivity (S/m)	0.884872
Variation (%)	-2.720000

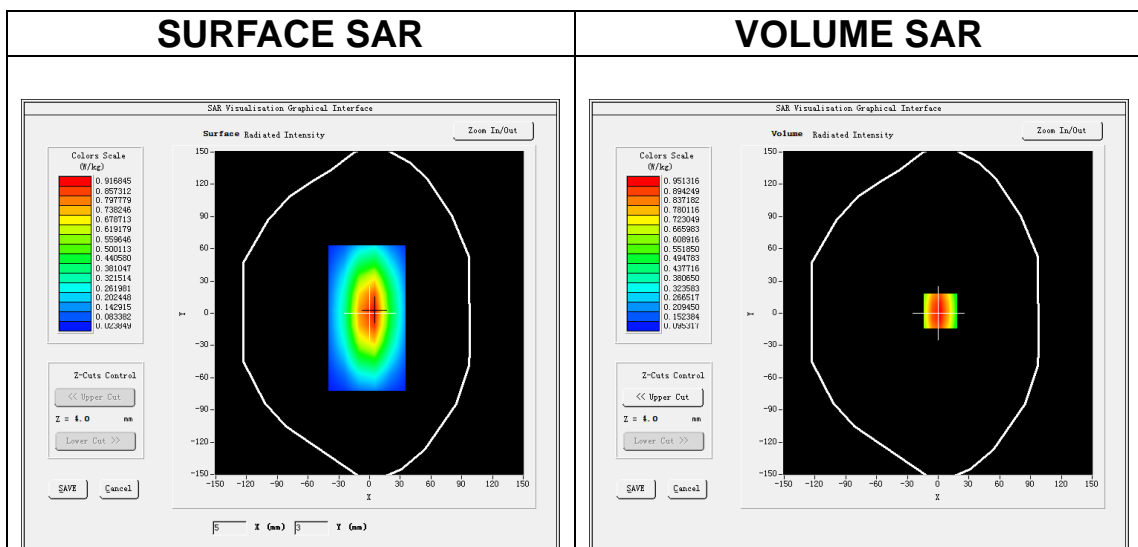

Maximum location: X=2.00, Y=2.00
SAR Peak: 1.29 W/kg

SAR 10g (W/Kg)	0.641333
SAR 1g (W/Kg)	0.867172

Z (mm)	0.00	4.00	9.00	14.00	19.00	24.00	29.00
SAR (W/Kg)	1.2821	0.9559	0.6532	0.4562	0.3263	0.2309	0.1726

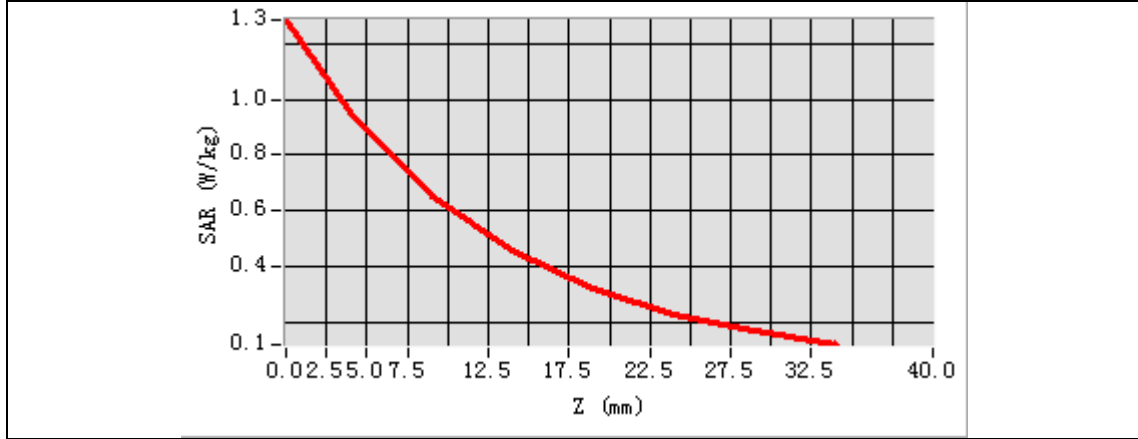

3D screen shot	Hot spot position
<p>A 3D perspective view of a grey, rectangular device. A small, localized area on the front face is highlighted with a color gradient from blue to red, indicating the hot spot location.</p>	<p>A 2D heatmap visualization of the hot spot. It shows a vertical, oval-shaped region with a color gradient from cyan at the edges to red in the center, representing the intensity distribution of the hot spot.</p>

MEASUREMENT 3

Date of measurement: 10/4/2024

A. Experimental conditions.

Area Scan	<u>dx=15mm dy=15mm, h= 5.00 mm</u>
ZoomScan	<u>5x5x7, dx=8mm dy=8mm dz=5mm</u>
Phantom	<u>Validation plane</u>
Device Position	<u>Dipole</u>
Band	<u>CW1800</u>
Channels	<u>Middle</u>
Signal	<u>CW (Crest factor: 1.0)</u>
ConvF	<u>2.45</u>

B. SAR Measurement Results

Frequency (MHz)	1800.000000
Relative permittivity (real part)	39.201404
Relative permittivity (imaginary part)	13.969963
Conductivity (S/m)	1.396996
Variation (%)	2.980000

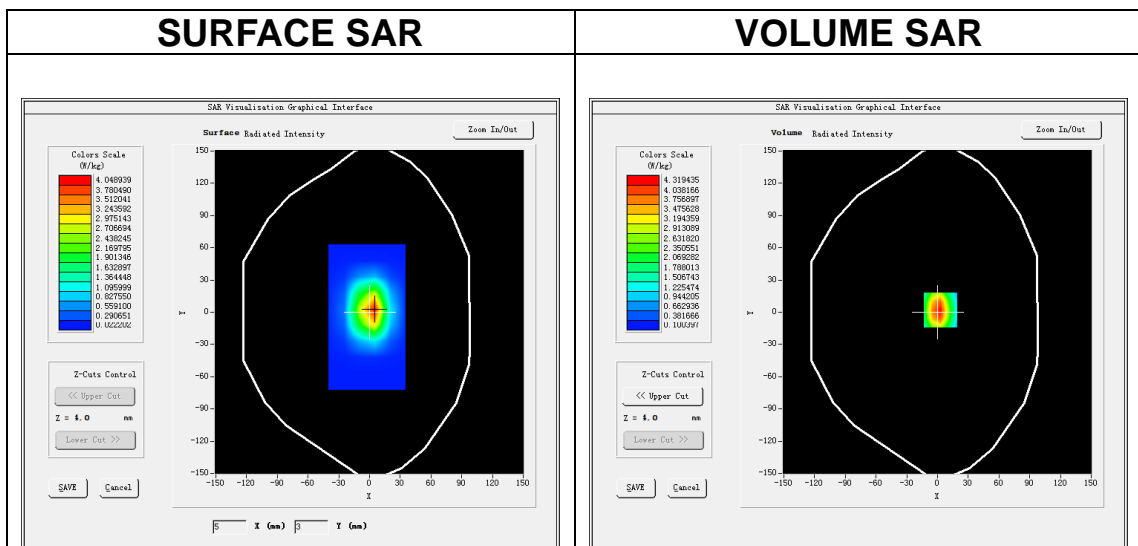

Maximum location: X=3.00, Y=2.00
SAR Peak: 6.82 W/kg

SAR 10g (W/Kg)	1.884307
SAR 1g (W/Kg)	3.495066

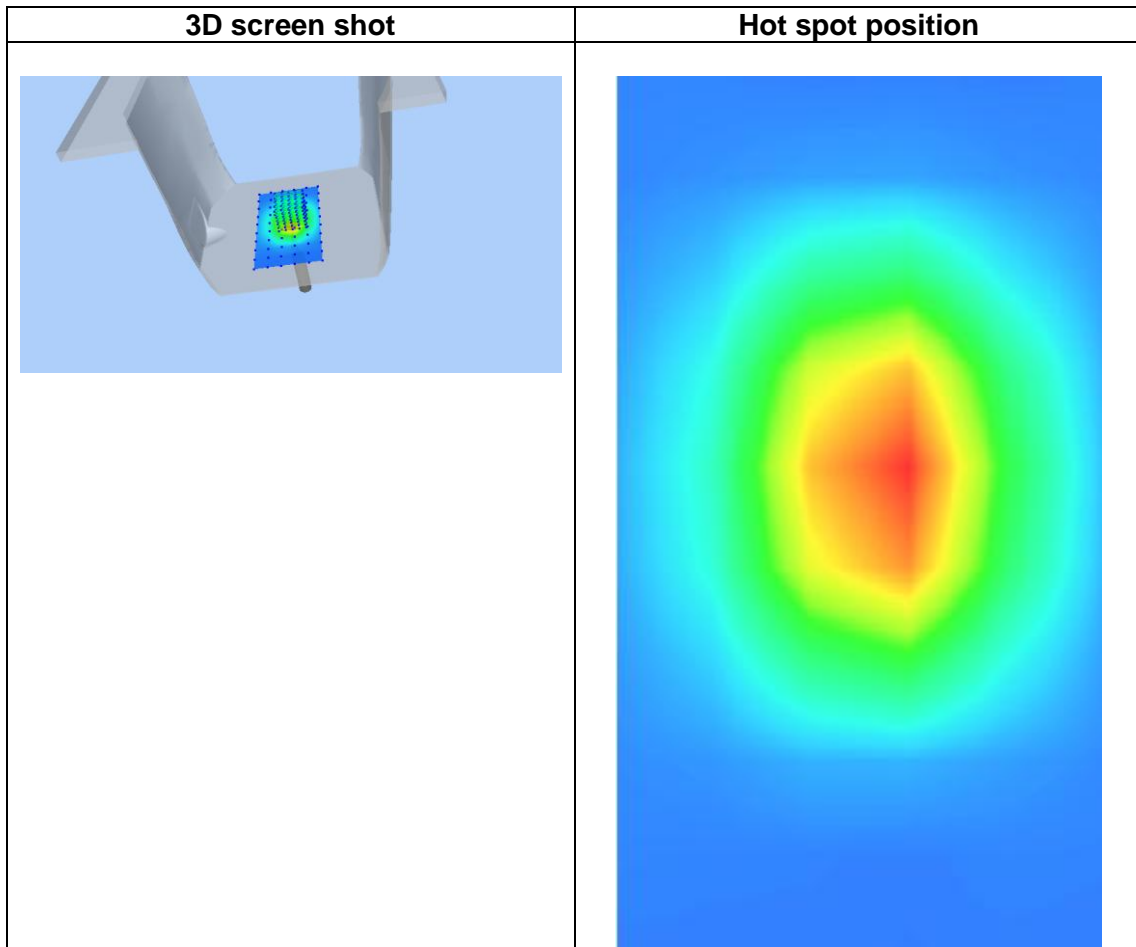
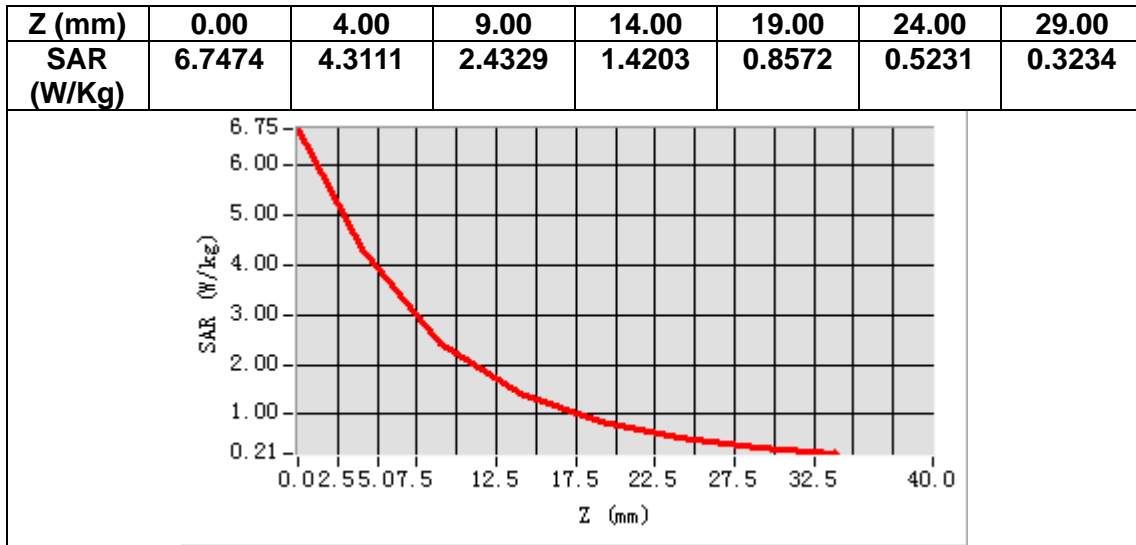

MEASUREMENT 4

Date of measurement: 9/4/2024

A. Experimental conditions.

Area Scan	<u>dx=15mm dy=15mm, h= 5.00 mm</u>
ZoomScan	<u>5x5x7, dx=8mm dy=8mm dz=5mm</u>
Phantom	<u>Validation plane</u>
Device Position	<u>Dipole</u>
Band	<u>CW1900</u>
Channels	<u>Middle</u>
Signal	<u>CW (Crest factor: 1.0)</u>
ConvF	<u>2.63</u>

B. SAR Measurement Results

Frequency (MHz)	1900.000000
Relative permittivity (real part)	39.025523
Relative permittivity (imaginary part)	13.805308
Conductivity (S/m)	1.457227
Variation (%)	2.220000

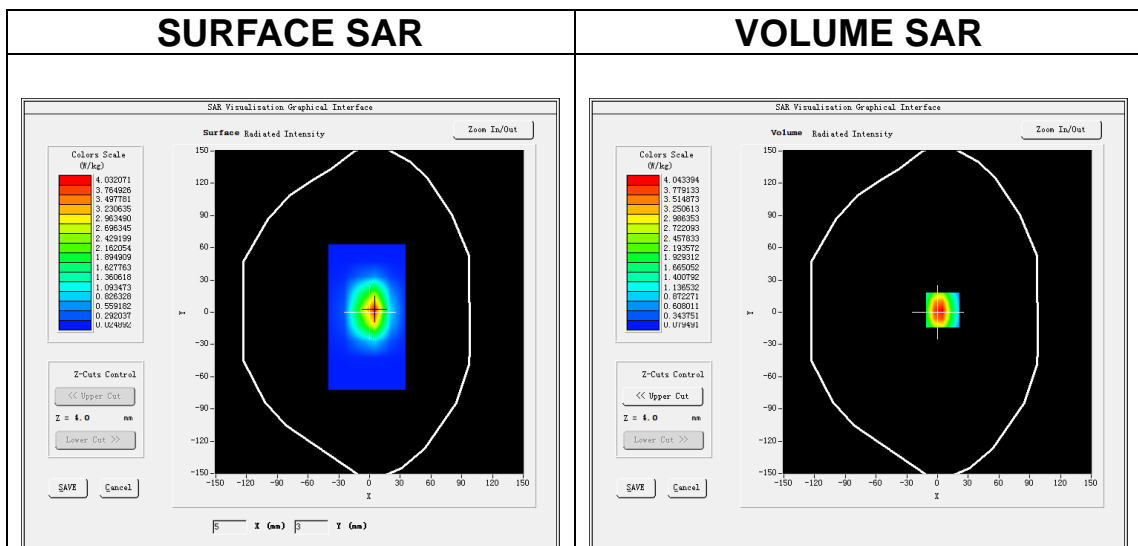

Maximum location: X=5.00, Y=2.00
SAR Peak: 6.70 W/kg

SAR 10g (W/Kg)	1.934347
SAR 1g (W/Kg)	3.695221

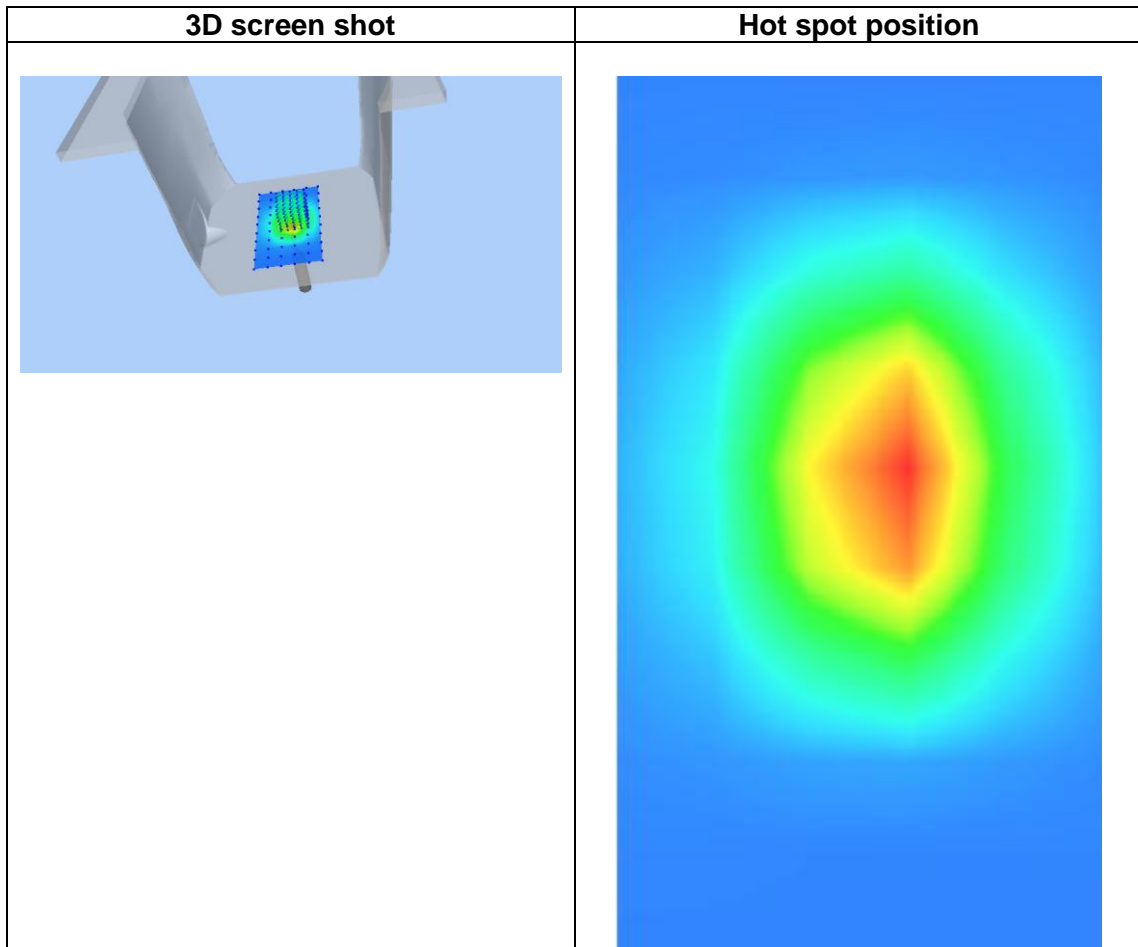
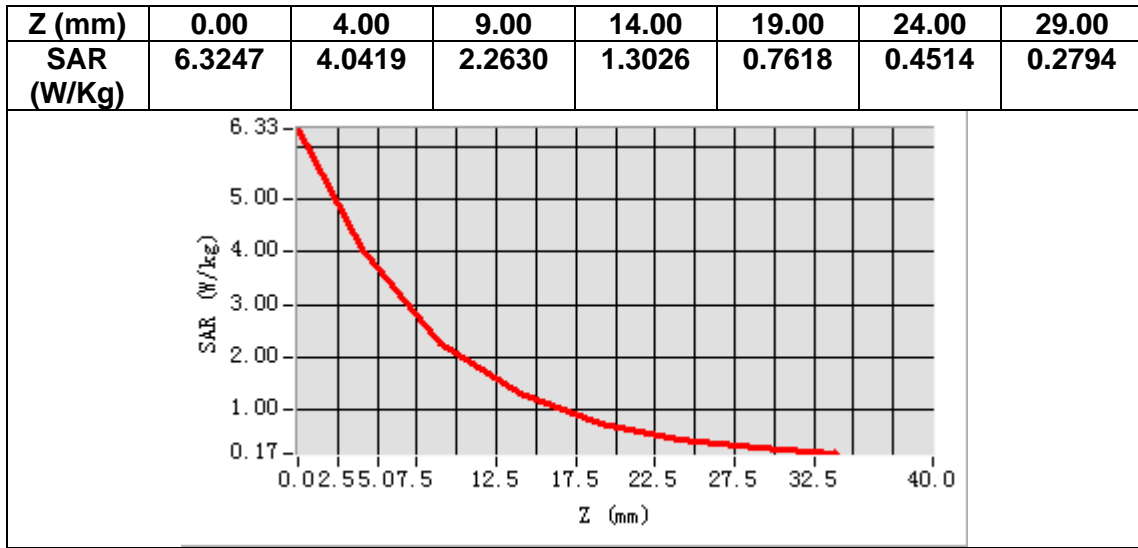

MEASUREMENT 5

Date of measurement: 12/4/2024

A. Experimental conditions.

Area Scan	<u>dx=12mm dy=12mm, h= 5.00 mm</u>
ZoomScan	<u>7x7x7,dx=5mm dy=5mm dz=5mm</u>
Phantom	<u>Validation plane</u>
Device Position	<u>Dipole</u>
Band	<u>CW2450</u>
Channels	<u>Middle</u>
Signal	<u>CW (Crest factor: 1.0)</u>
ConvF	<u>2.85</u>

B. SAR Measurement Results

Frequency (MHz)	2450.000000
Relative permittivity (real part)	37.674635
Relative permittivity (imaginary part)	12.895778
Conductivity (S/m)	1.755259
Variation (%)	1.290000

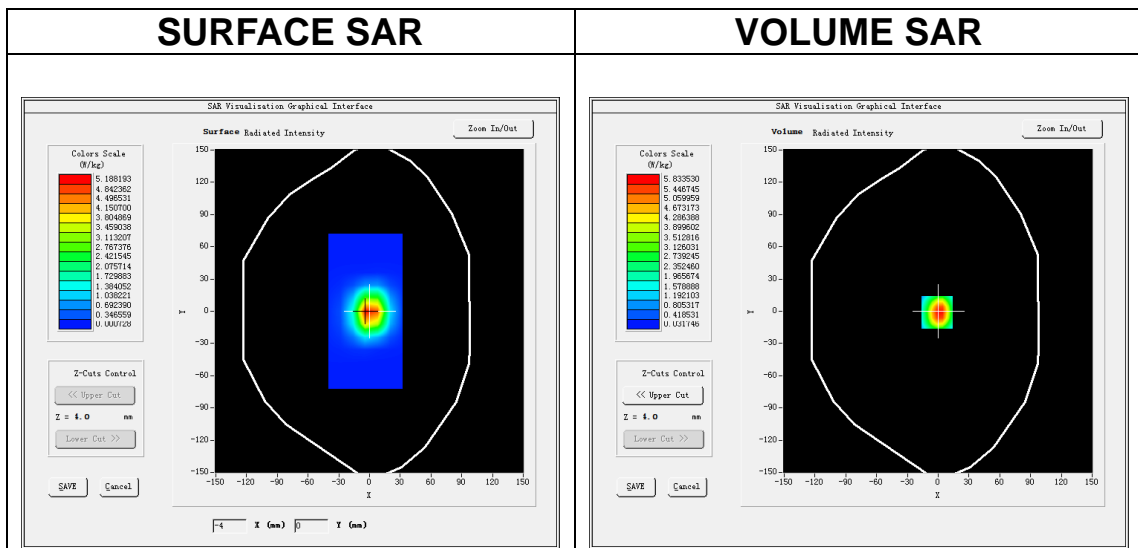

Maximum location: X=-1.00, Y=-1.00
SAR Peak: 9.83 W/kg

SAR 10g (W/Kg)	2.279106
SAR 1g (W/Kg)	4.783340

Z (mm)	0.00	4.00	9.00	14.00	19.00	24.00	29.00
SAR (W/Kg)	9.7197	5.8353	2.9227	1.4626	0.7461	0.3798	0.1960

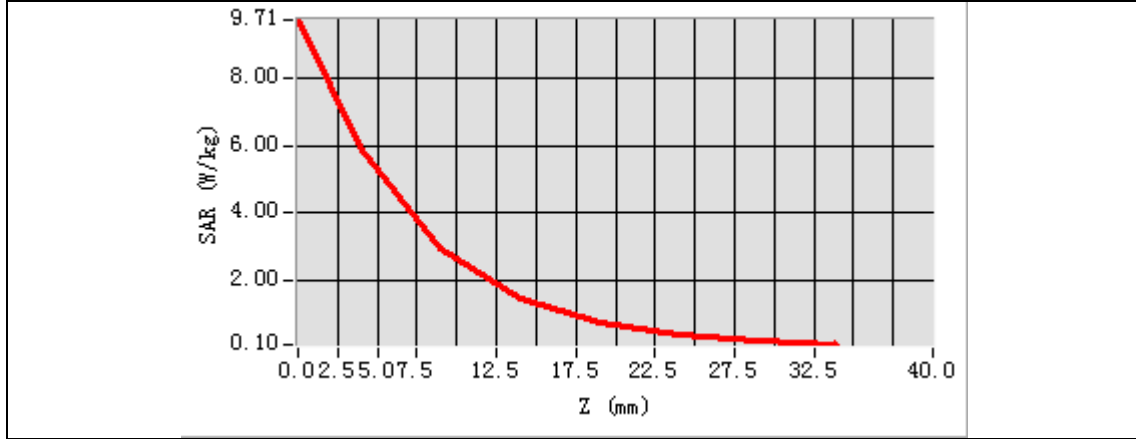

3D screen shot	Hot spot position
<p>A 3D perspective view of a grey, L-shaped device. A small rectangular area on the inner surface of the 'L' is highlighted with a color gradient from blue to red, representing the SAR hot spot.</p>	<p>A 2D heatmap visualization of the hot spot. The hot spot is represented by a central red/orange oval, surrounded by concentric rings of yellow, green, and cyan, all set against a dark blue background.</p>

MEASUREMENT 6

Date of measurement: 16/4/2024

A. Experimental conditions.

Area Scan	<u>dx=12mm dy=12mm, h= 5.00 mm</u>
ZoomScan	<u>7x7x7,dx=5mm dy=5mm dz=5mm</u>
Phantom	<u>Validation plane</u>
Device Position	<u>Dipole</u>
Band	<u>CW2600</u>
Channels	<u>Middle</u>
Signal	<u>CW (Crest factor: 1.0)</u>
ConvF	<u>2.65</u>

B. SAR Measurement Results

Frequency (MHz)	2600.000000
Relative permittivity (real part)	38.822242
Relative permittivity (imaginary part)	13.647932
Conductivity (S/m)	1.971368
Variation (%)	0.250000

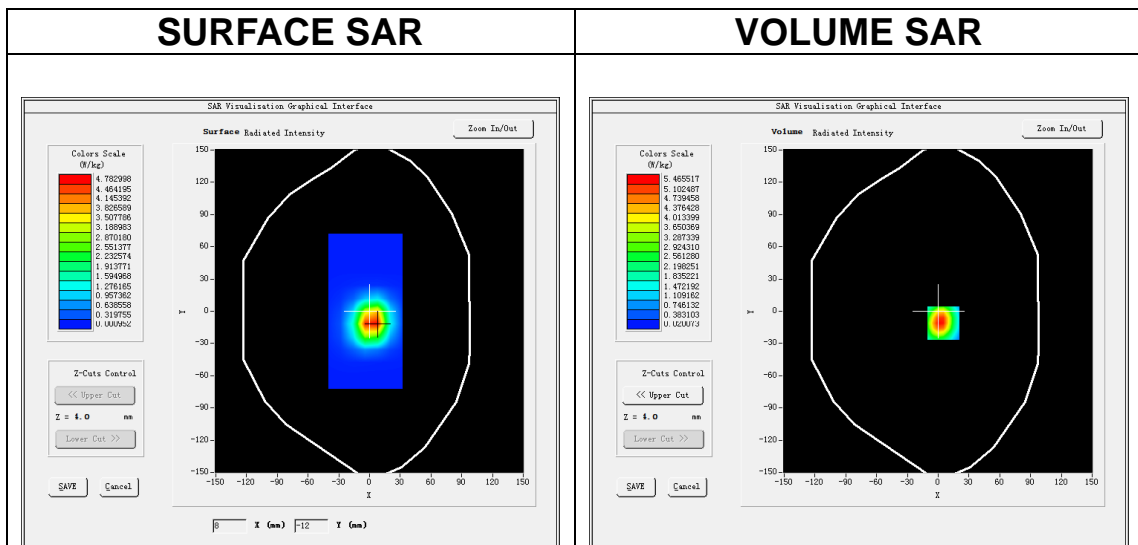

Maximum location: X=5.00, Y=-11.00
SAR Peak: 9.43 W/kg

SAR 10g (W/Kg)	2.456037
SAR 1g (W/Kg)	5.098199

Z (mm)	0.00	4.00	9.00	14.00	19.00	24.00	29.00
SAR (W/Kg)	10.568	5.4632	2.0863	1.3356	0.5061	0.2869	0.1279

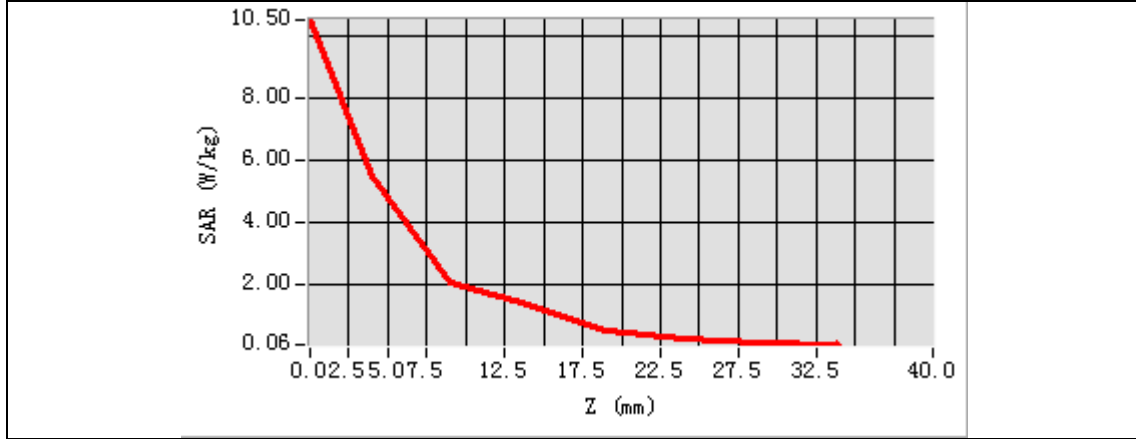

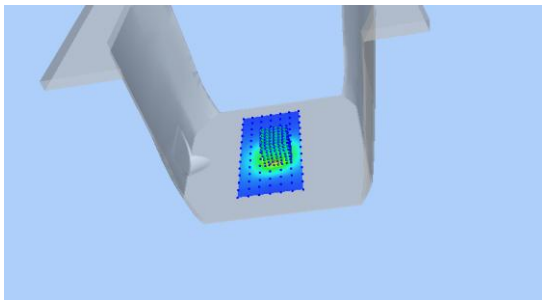
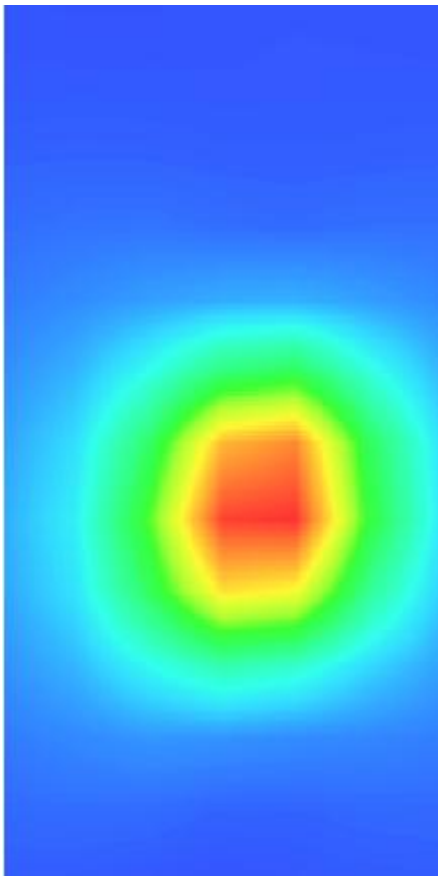
3D screen shot	Hot spot position
	

MEASUREMENT 7

Date of measurement: 7/4/2024

A. Experimental conditions.

Area Scan	<u>dx=12mm dy=12mm, h= 5.00 mm</u>
ZoomScan	<u>7x7x7,dx=5mm dy=5mm dz=5mm</u>
Phantom	<u>Validation plane</u>
Device Position	<u>Dipole</u>
Band	<u>CW3500</u>
Channels	<u>Middle</u>
Signal	<u>CW (Crest factor: 1.0)</u>
ConvF	<u>2.20</u>

B. SAR Measurement Results

Frequency (MHz)	3500.000000
Relative permittivity (real part)	37.884593
Relative permittivity (imaginary part)	14.443988
Conductivity (S/m)	2.808553
Variation (%)	3.220000

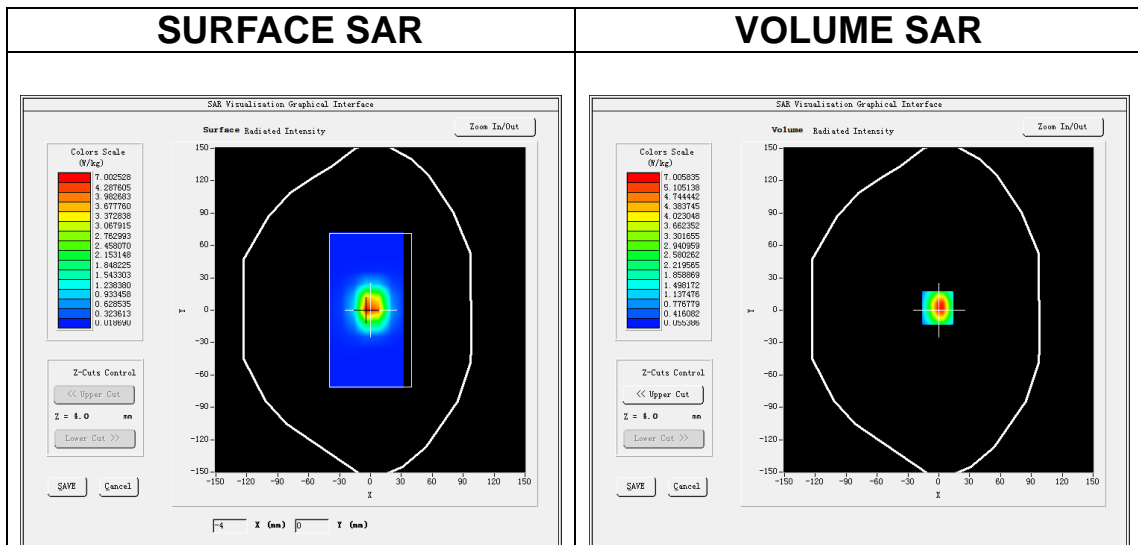

Maximum location: X=-1.00, Y=2.00

SAR Peak: 9.07 W/kg

SAR 10g (W/Kg)	2.419275
SAR 1g (W/Kg)	7.008238

Z (mm)	0.00	4.00	9.00	14.00	19.00	24.00	29.00
SAR (W/Kg)	8.8174	5.4683	2.8989	1.5626	0.8540	0.4790	0.2617

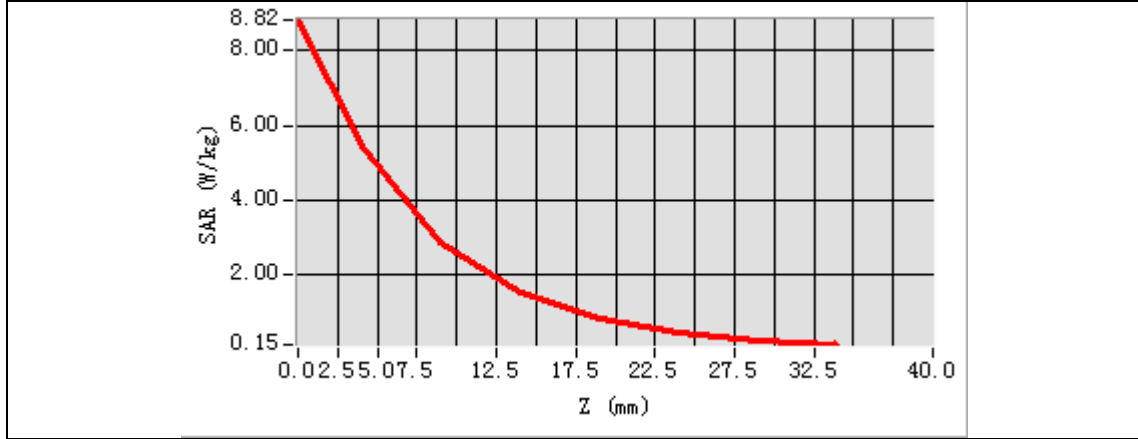

3D screen shot	Hot spot position
<p>A 3D perspective view of a grey, L-shaped device. A small rectangular area on the inner surface of the 'L' is highlighted with a color gradient from blue to red, indicating the location of the maximum SAR exposure.</p>	<p>A 2D heatmap showing a localized area of high SAR exposure. The center of the heatmap is red, transitioning through yellow and green to blue at the edges, representing the spatial distribution of the SAR field.</p>

MEASUREMENT 8

Date of measurement: 21/4/2024

A. Experimental conditions.

Area Scan	<u>dx=10mm dy=10mm, h= 2.00 mm</u>
ZoomScan	<u>7x7x12,dx=4mm dy=4mm dz=2mm</u>
Phantom	<u>Validation plane</u>
Device Position	<u>Dipole</u>
Band	<u>CW5200</u>
Channels	<u>Middle</u>
Signal	<u>CW (Crest factor: 1.0)</u>
ConvF	<u>2.07</u>

B. SAR Measurement Results

Frequency (MHz)	5200.000000
Relative permittivity (real part)	34.478385
Relative permittivity (imaginary part)	15.628512
Conductivity (S/m)	4.514903
Variation (%)	2.800000

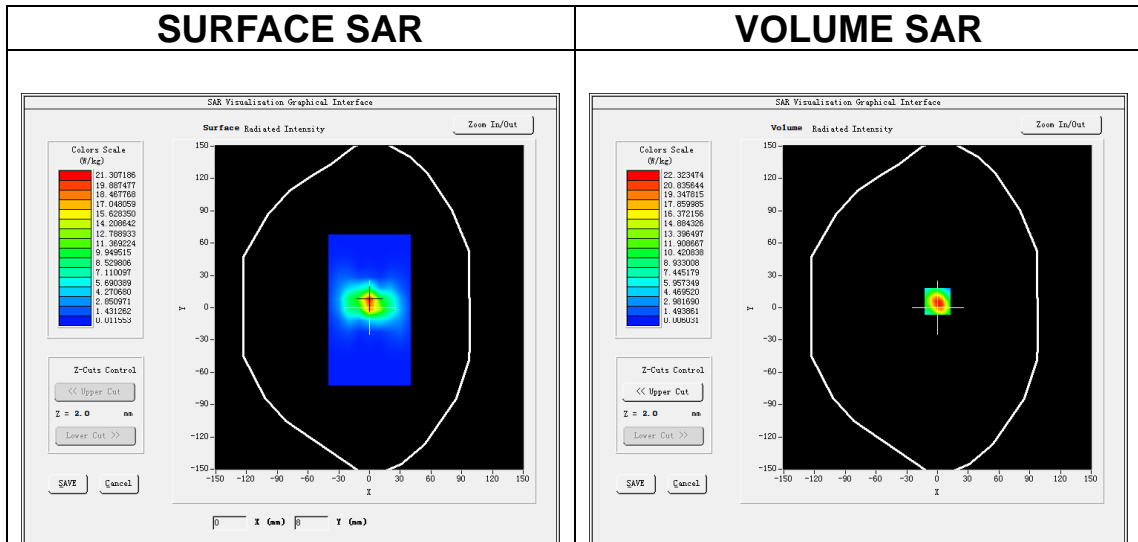

Maximum location: X=0.00, Y=6.00

SAR Peak: 40.06 W/kg

SAR 10g (W/Kg)	5.949162
SAR 1g (W/Kg)	15.432032

Z (m m)	0.00	2.00	4.00	6.00	8.00	10.0 0	12.0 0	14.0 0	16.0 0	18.0 0	20.0 0	22.0 0
SAR (W/ Kg)	37.8 91	22.3 91	11.3 77	5.66 94	2.82 91	1.40 43	0.71 50	0.36 37	0.18 02	0.10 08	0.05 27	0.03 97

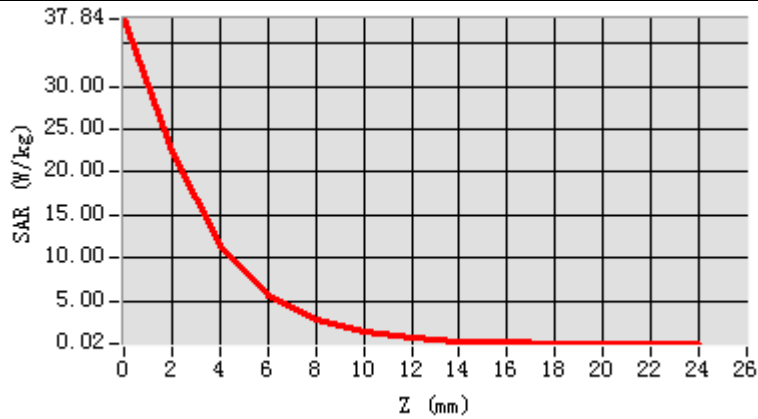

3D screen shot

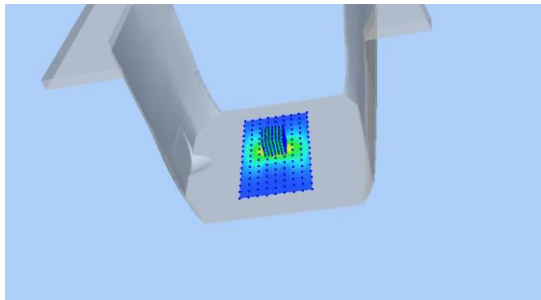

Hot spot position

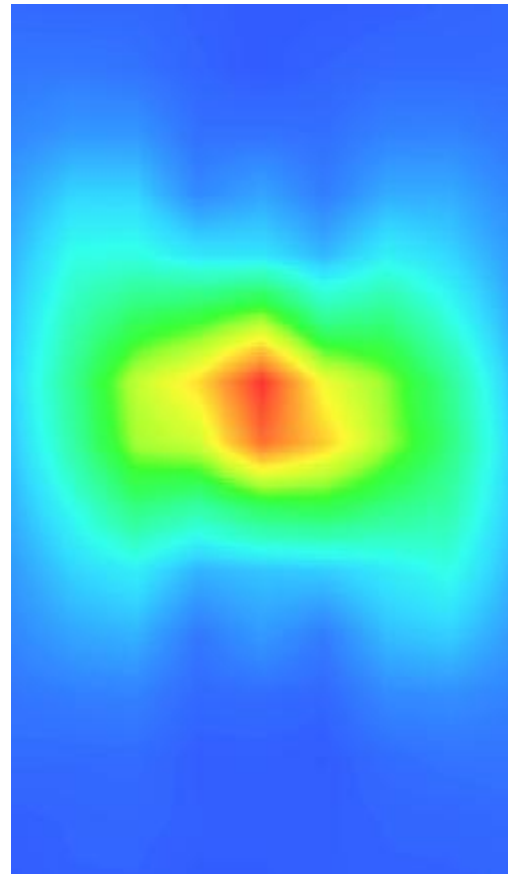

MEASUREMENT 9

Date of measurement: 20/4/2024

A. Experimental conditions.

Area Scan	<u>dx=10mm dy=10mm, h= 2.00 mm</u>
ZoomScan	<u>7x7x12,dx=4mm dy=4mm dz=2mm</u>
Phantom	<u>Validation plane</u>
Device Position	<u>Dipole</u>
Band	<u>CW5800</u>
Channels	<u>Middle</u>
Signal	<u>CW (Crest factor: 1.0)</u>
ConvF	<u>2.04</u>

B. SAR Measurement Results

Frequency (MHz)	5800.000000
Relative permittivity (real part)	33.909535
Relative permittivity (imaginary part)	16.015283
Conductivity (S/m)	5.160480
Variation (%)	-0.500000

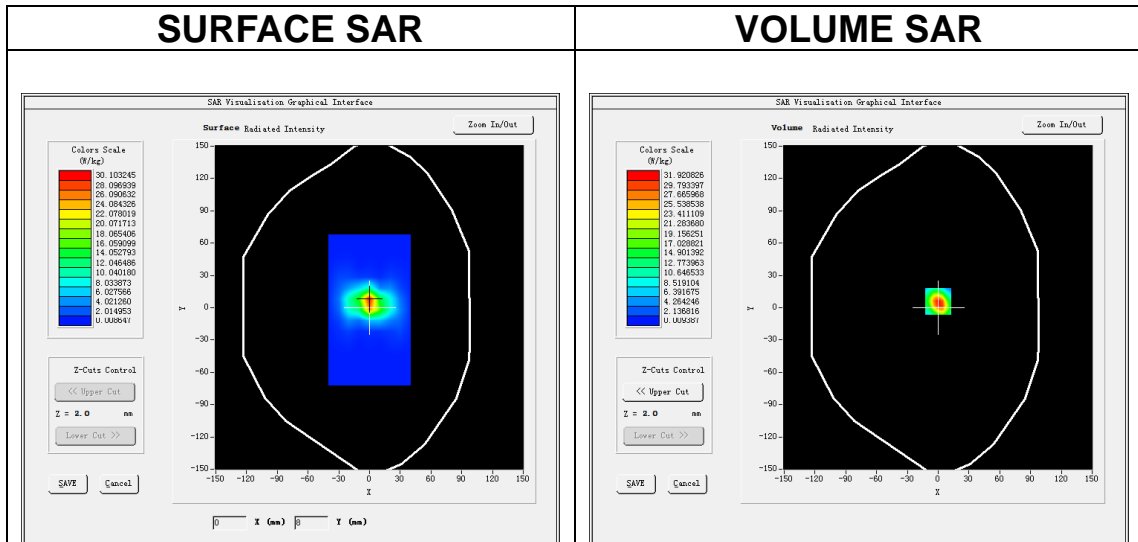

Maximum location: X=0.00, Y=6.00

SAR Peak: 57.37 W/kg

SAR 10g (W/Kg)	5.852228
SAR 1g (W/Kg)	18.838190

Z (m m)	0.00	2.00	4.00	6.00	8.00	10.0	12.0	14.0	16.0	18.0	20.0	22.0
SAR R (W/ Kg)	54.0	31.9	16.1	8.17	4.08	2.05	1.03	0.51	0.27	0.15	0.07	0.04
	36	48	44	66	90	50	61	44	95	72	88	38

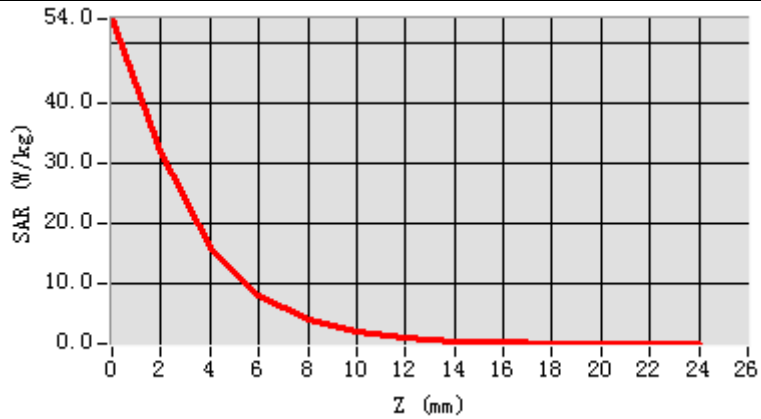

3D screen shot

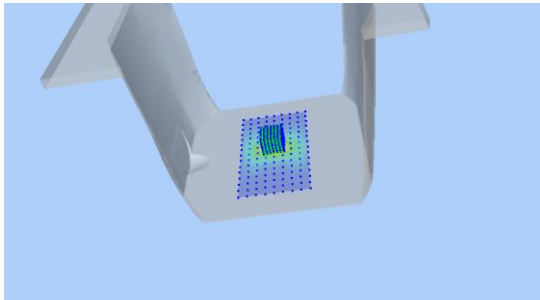

Hot spot position

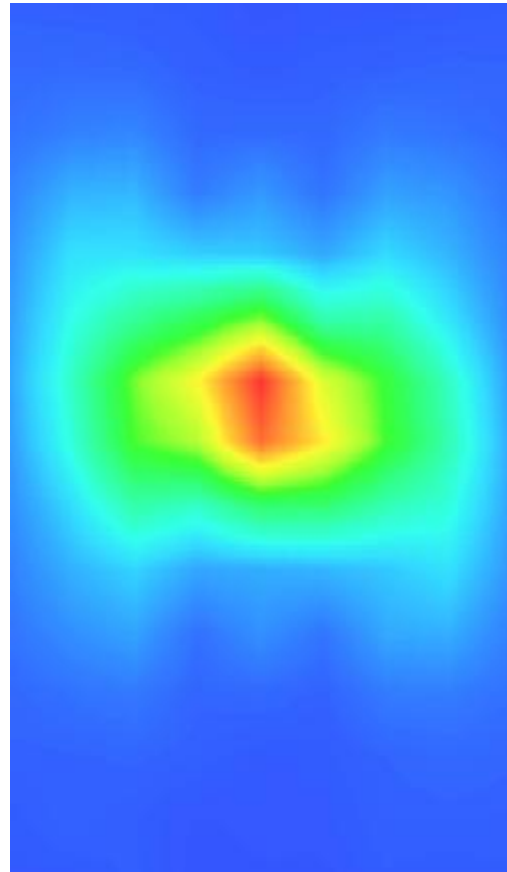

13. Appendix C. Plots of High SAR Measurement

Table of contents
MEASUREMENT 1 GSM 850 Head
MEASUREMENT 2 GSM 850 Body
MEASUREMENT 3 GSM 1900 Head
MEASUREMENT 4 GSM 1900 Body
MEASUREMENT 5 WCDMA Band 2 Head
MEASUREMENT 6 WCDMA Band 2 Body
MEASUREMENT 7 WCDMA Band 4 Head
MEASUREMENT 8 WCDMA Band 4 Body
MEASUREMENT 9 WCDMA Band 5 Head
MEASUREMENT 10 WCDMA Band 5 Body
MEASUREMENT 11 Bluetooth Head
MEASUREMENT 12 Bluetooth Body
MEASUREMENT 13 WLAN 5.2G Head
MEASUREMENT 14 WLAN 5.8G Head
MEASUREMENT 15 WLAN 5.2G Body
MEASUREMENT 16 WLAN 5.8G Body
MEASUREMENT 17 WLAN 2.4G Head
MEASUREMENT 18 WLAN 2.4G Body
MEASUREMENT 19 LTE Band 2 Head
MEASUREMENT 20 LTE Band 2 Body
MEASUREMENT 21 LTE Band 4 Head
MEASUREMENT 22 LTE Band 4 Body
MEASUREMENT 23 LTE Band 5 Head
MEASUREMENT 24 LTE Band 5 Body
MEASUREMENT 25 LTE Band 7 Head
MEASUREMENT 26 LTE Band 7 Body
MEASUREMENT 27 LTE Band 12 Head
MEASUREMENT 28 LTE Band 12 Body
MEASUREMENT 29 LTE Band 17 Head
MEASUREMENT 30 LTE Band 17 Body
MEASUREMENT 31 LTE Band 38 Head
MEASUREMENT 32 LTE Band 38 Body
MEASUREMENT 33 LTE Band 41 Head
MEASUREMENT 34 LTE Band 41 Body
MEASUREMENT 35 NR n78 Head
MEASUREMENT 36 NR n78 Body

MEASUREMENT 1

Date of measurement: 8/4/2024

A. Experimental conditions.

Area Scan	<u>dx=15mm dy=15mm, h= 5.00 mm</u>
ZoomScan	<u>5x5x7, dx=8mm dy=8mm dz=5mm</u>
Phantom	<u>Left head</u>
Device Position	<u>Cheek</u>
Band	<u>GSM850</u>
Channels	<u>Middle</u>
Signal	<u>TDMA (Crest factor: 2.0)</u>
ConvF	<u>2.32</u>

B. SAR Measurement Results

Frequency (MHz)	836.400000
Relative permittivity (real part)	41.006798
Relative permittivity (imaginary part)	19.082279
Conductivity (S/m)	0.886690
Variation (%)	-0.290000

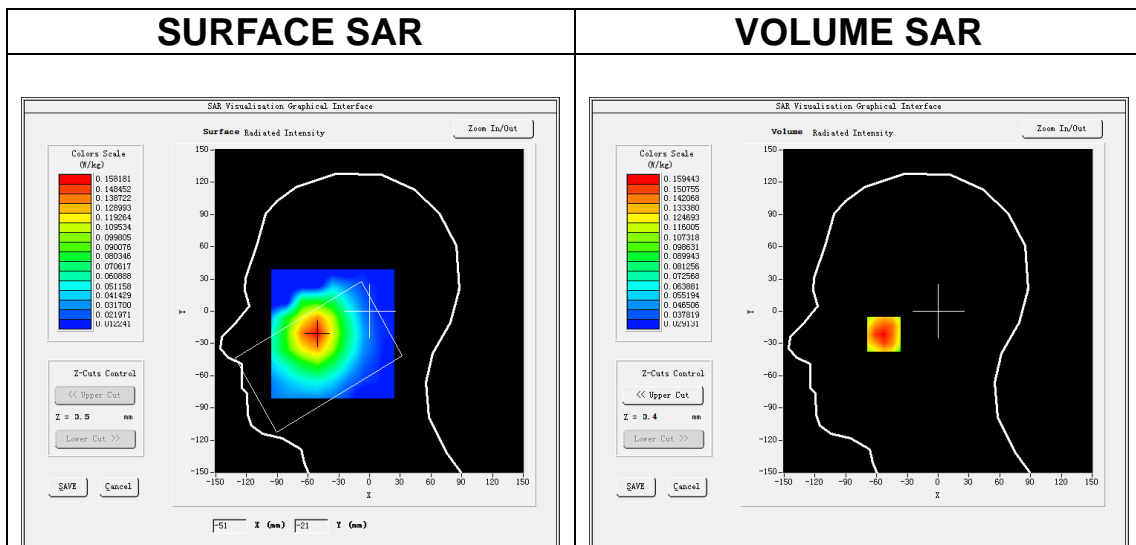

Maximum location: X=-53.00, Y=-21.00
SAR Peak: 0.20 W/kg

SAR 10g (W/Kg)	0.114922
SAR 1g (W/Kg)	0.154822

