

TEST REPORT

Report No.: BCTC2307939313-7E

Applicant: SHENZHEN YUNJI INTELLIGENT TECHNOLOGY
CO.,LTD

Product Name: Smart Phone

Model/Type
reference: WP30 Pro

Tested Date: 2023-07-26 to 2023-09-20

Issued Date: 2023-09-21

Shenzhen BCTC Testing Co., Ltd.



FCC ID: 2ANMU-WP30SPUT

Product Name: Smart Phone
Trademark: OUKITEL
Model/Type reference: WP30 Pro
WP30, WP30 S, WP30 Ultra, WP30 TITAN
Prepared For: SHENZHEN YUNJI INTELLIGENT TECHNOLOGY CO.,LTD
Address: A2 2F BUILDING ENET NEW INDUSTRIAL PARK, DAFU INDUSTRIAL ZONE,
GUANLAN, LONGHUA, Shenzhen, China
Manufacturer: SHENZHEN YUNJI INTELLIGENT TECHNOLOGY CO.,LTD
Address: A2 2F BUILDING ENET NEW INDUSTRIAL PARK, DAFU INDUSTRIAL ZONE,
GUANLAN, LONGHUA, Shenzhen, China
Prepared By: Shenzhen BCTC Testing Co., Ltd.
Address: 1-2/F., Building B, Pengzhou Industrial Park, No.158, Fuyuan 1st Road, Zhancheng,
Fuhai Subdistrict, Bao'an District, Shenzhen, Guangdong, China
Sample Received Date: 2023-07-26
Sample tested Date: 2023-07-26 to 2023-09-20
Issue Date: 2023-09-21
Report No.: BCTC2307939313-7E
Test Standards: FCC Part15.225
ANSI C63.10-2013
Test Results: PASS
Remark: This is NFC radio test report.

Tested by:



Lei Chen/Project Handler

Approved by:



Zero Zhou/Reviewer

The test report is effective only with both signature and specialized stamp. This result(s) shown in this report refer only to the sample(s) tested. Without written approval of Shenzhen BCTC Testing Co., Ltd, this report can't be reproduced except in full. The tested sample(s) and the sample information are provided by the client.

Table Of Content

	Page
Test Report Declaration	
1. Version	5
2. Test Summary	6
3. Measurement Uncertainty	7
4. Product Information And Test Setup	8
4.1 Product Information	8
4.2 Test Setup Configuration	8
4.3 Support Equipment	9
4.4 Channel List	9
4.5 Test Mode	9
5. Test Facility And Test Instrument Used	10
5.1 Test Facility	10
5.2 Test Instrument Used	10
6. Conducted Emissions	12
6.1 Block Diagram Of Test Setup	12
6.2 Limit	12
6.3 Test Procedure	12
6.4 EUT operating Conditions	12
6.5 Test Result	13
7. Radiated Emissions	15
7.1 Block Diagram Of Test Setup	15
7.2 Limit	16
7.3 EUT Operating Conditions	17
7.4 Test Result	17
8. Radiated Band Emission Measurement	20
8.1 Block Diagram Of Test Setup	20
8.2 Limit	20
8.3 Test Procedure	21
8.4 EUT Operating Conditions	21
8.5 Test Result	22
9. Bandwidth Test	23
9.1 Block Diagram Of Test Setup	23
9.2 Test Procedure	23
9.3 EUT Operation Conditions	23
9.4 Test Result	24
10. Transmitter Frequency Stability	25
10.1 Block Diagram Of Test Setup	25
10.2 Limit	25
10.3 Test Procedure	25
10.4 EUT Operating Conditions	25
10.5 Test Result	26
11. Antenna Requirement	27
11.1 Standard Requirement	27



11.2 EUT Antenna27
12. EUT Photographs.....28
13. EUT Test Setup Photographs.....29

(Note: N/A Means Not Applicable)

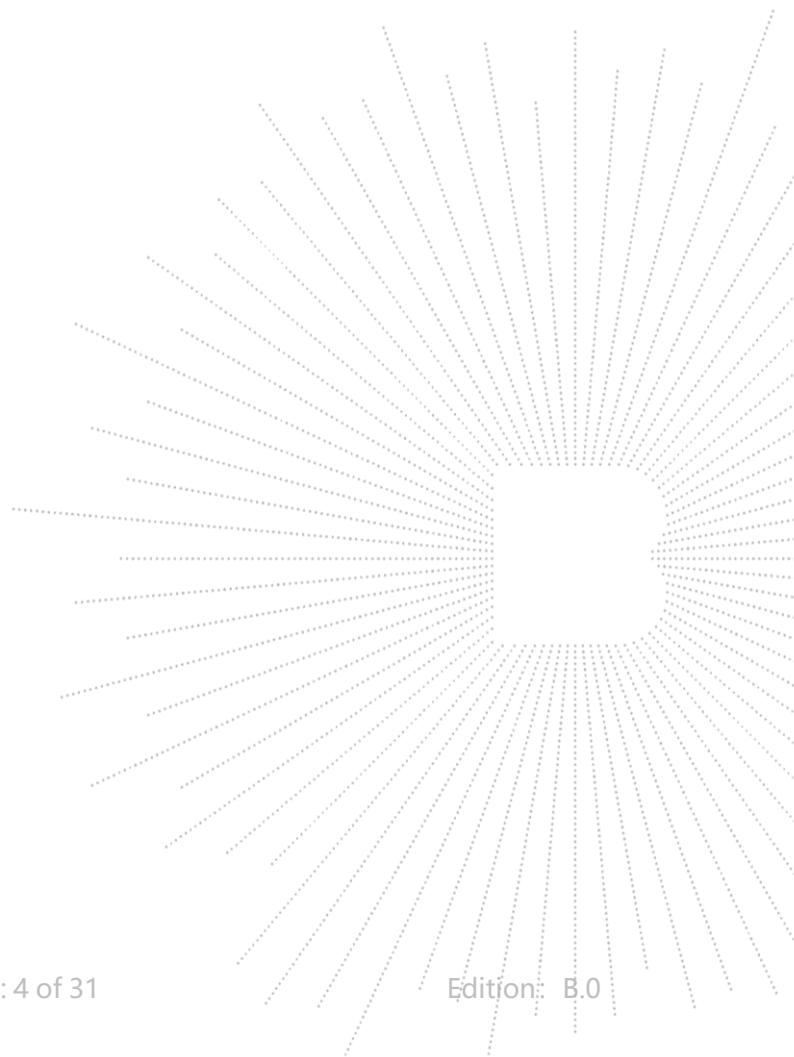

1. Version

Report No.	Issue Date	Description	Approved
BCTC2307939313-7E	2023-09-21	Original	Valid

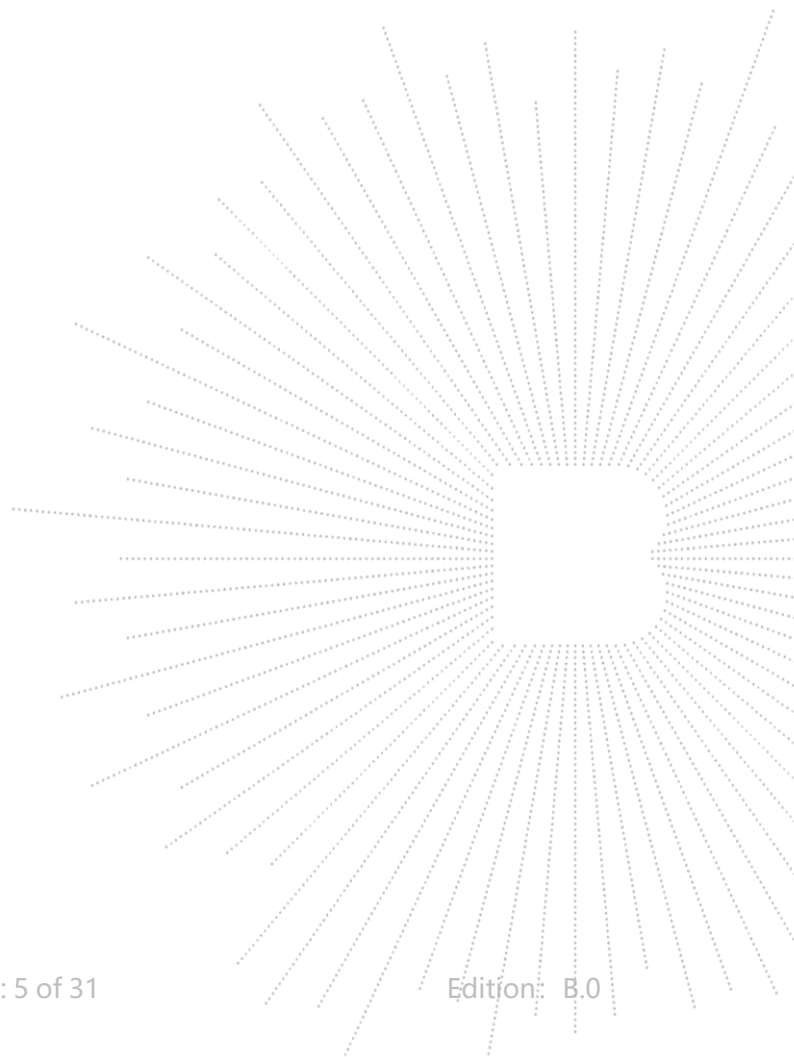

2. Test Summary

The Product has been tested according to the following specifications:

No.	Test Parameter	Clause No	Results
1	15.207	Conducted Emission	PASS
2	Part 15.209(a), 15.225(d)	Radiated Spurious Emission	PASS
3	15.215	Bandwidth	PASS
4	Part 15.209(a), 15.225(a)(b)(c)(d)	Band Edge Emission	PASS
5	Part 15.225(e)	Transmitter Frequency Stability (Temperature & Voltage Variation)	PASS
6	15.203	Antenna Requirement	PASS

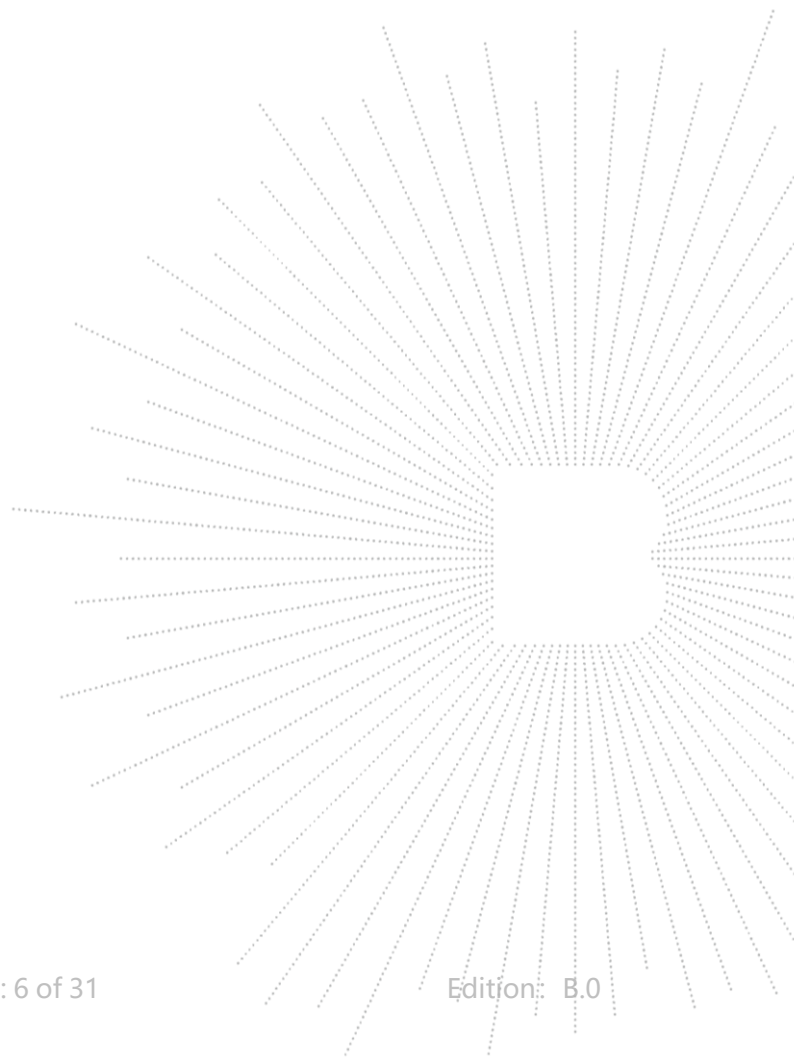

3. Measurement Uncertainty





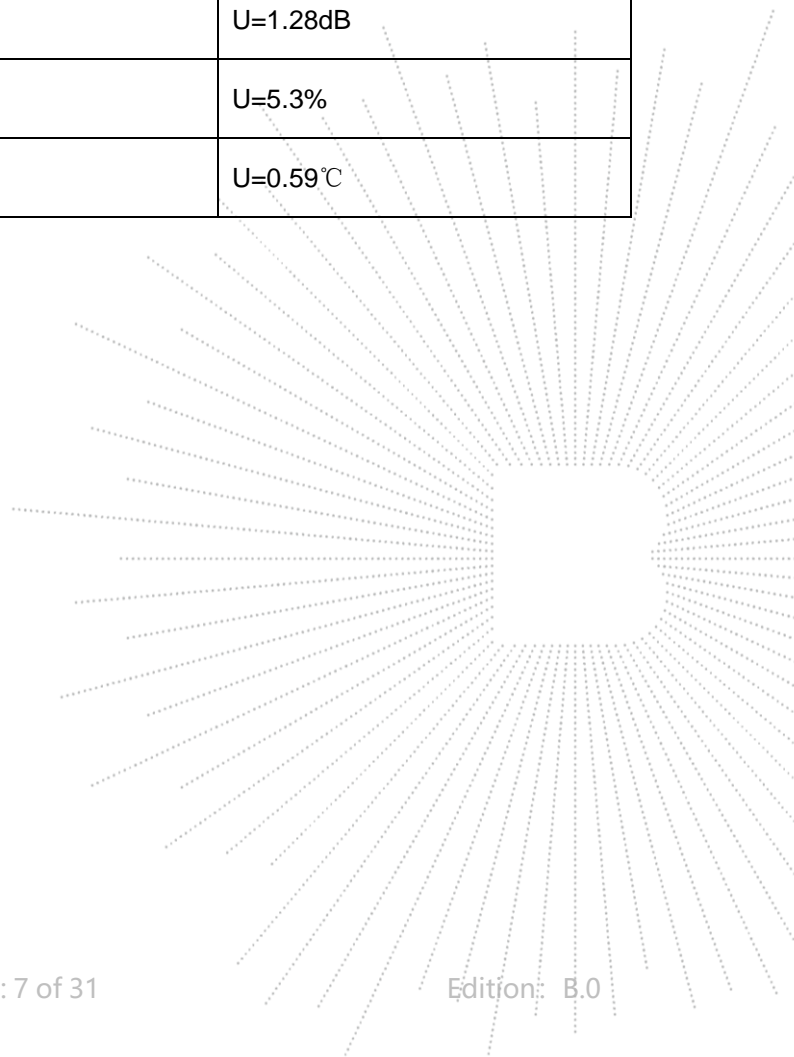

Where relevant, the following measurement uncertainty levels have been estimated for tests performed on the Product as specified in CISPR 16-4-2. This uncertainty represents an expanded uncertainty expressed at approximately the 95% confidence level using a coverage factor of $k=2$.

No.	Item	Uncertainty
1	3m chamber Radiated spurious emission(30MHz-1GHz)	U=4.3dB
2	3m chamber Radiated spurious emission(9KHz-30MHz)	U=3.7dB
3	3m chamber Radiated spurious emission(1GHz-18GHz)	U=4.5dB
4	3m chamber Radiated spurious emission(18GHz-40GHz)	U=3.34dB
5	Conducted Emission (150kHz-30MHz)	U=3.20dB
6	Conducted Adjacent channel power	U=1.38dB
7	Conducted output power uncertainty Above 1G	U=1.576dB
8	Conducted output power uncertainty below 1G	U=1.28dB
9	humidity uncertainty	U=5.3%
10	Temperature uncertainty	U=0.59°C



4. Product Information And Test Setup

4.1 Product Information

Model/Type reference:	WP30 Pro WP30, WP30 S, WP30 Ultra, WP30 TITAN
Model differences:	All the model are the same circuit and RF module, except model names and appearance of the color.
Hardware Version:	M159-MUB-V2
Software Version:	OUKITEL_WP30_Pro_V09_20230804
Operation Frequency:	13.56 MHz
Modulation Type:	ASK
Number Of Channel	1 CH
Antenna installation:	Internal Antenna
Antenna Gain:	0 dBi
Ratings:	DC 9V from adapter
Battery:	DC 7.74V,5500mAh/42.57Wh Model: HJ-PD120W-US Input: 100-240V- 50/60Hz 1.8A Output: 5.0V  3.0A 15.0W OR 9.0V  3.0A 27.0W OR 12.0V  3.0A 36.0W OR 15.0V  3.0A 45.0W OR 20.0V  5.0A 100.0W MAX PPS: 3.6V-20.0V  6.0A 120W MAX
Adapter Information:	

4.2 Test Setup Configuration

See test photographs attached in *EUT TEST SETUP PHOTOGRAPHS* for the actual connections between Product and support equipment.
Radiated Spurious Emission

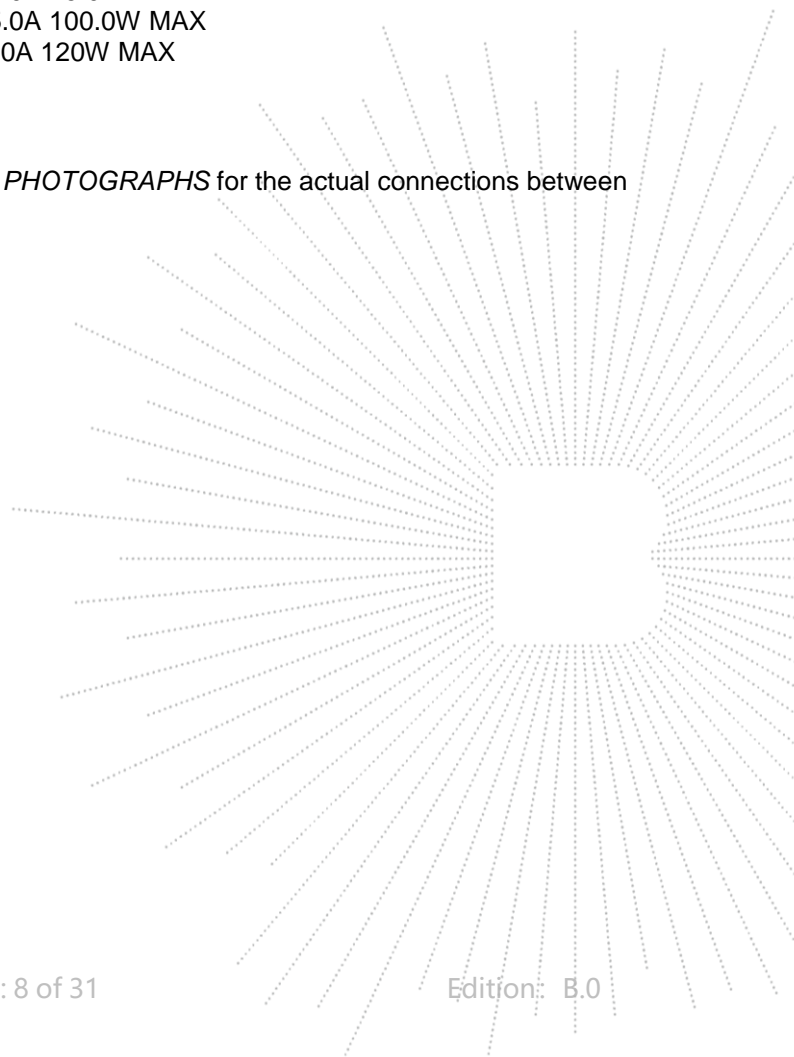
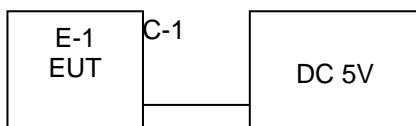

4.3 Support Equipment

No.	Device Type	Brand	Model	Series No.	Note
E-1	Smart Phone	OUKITEL	WP30 Pro	N/A	EUT
E-2	Adapter	N/A	HJ-PD120W-US	N/A	Auxiliary

Item	Shielded Type	Ferrite Core	Length	Note
C-1	N/A	N/A	1M	DC cable unshielded

Notes:

1. All the equipment/cables were placed in the worst-case configuration to maximize the emission during the test.
2. Grounding was established in accordance with the manufacturer's requirements and conditions for the intended use.

4.4 Channel List

Channel List	
Channel	Frequency(MHz)
01	13.56

4.5 Test Mode

To investigate the maximum EMI emission characteristics generated from EUT, the test system was pre-scanning tested based on the consideration of following EUT operation mode or test configuration mode which possibly have effect on EMI emission level. Each of these EUT operation mode(s) or test configuration mode(s) mentioned above was evaluated respectively.

For All Mode	Description
Mode 1	TX Mode

Link mode(conducted emission and Radiated emission)	
Final Test Mode	Description
Mode 1	TX Mode

Notes:

- (1) The measurements are performed at the highest, middle, lowest available channels.
- (2) Fully-charged battery is used during the test.

5. Test Facility And Test Instrument Used

5.1 Test Facility

All measurement facilities used to collect the measurement data are located at Shenzhen BCTC Testing Co., Ltd. Address:1-2/F., Building B, Pengzhou Industrial Park, No.158, Fuyuan 1st Road, Zhancheng, Fuhai Subdistrict, Bao'an District, Shenzhen, Guangdong, China. The site and apparatus are constructed in conformance with the requirements of ANSI C63.4 and CISPR 16-1-1 other equivalent standards.

FCC Test Firm Registration Number: 712850

A2LA certificate registration number is: CN1212

ISED Registered No.: 23583

ISED CAB identifier: CN0017

5.2 Test Instrument Used

Conducted Emissions Test					
Equipment	Manufacturer	Model#	Serial#	Last Cal.	Next Cal.
Receiver	R&S	ESR3	102075	May 15, 2023	May 14, 2024
LISN	R&S	ENV216	101375	May 15, 2023	May 14, 2024
Software	Frad	EZ-EMC	EMC-CON 3A1	\	\
Attenuator	\	10dB DC-6GHz	1650	May 15, 2023	May 14, 2024

RF Conducted Test					
Equipment	Manufacturer	Model#	Serial#	Last Cal.	Next Cal.
Power Metter	Keysight	E4419	\	May 15, 2023	May 14, 2024
Power Sensor (AV)	Keysight	E9300A	\	May 15, 2023	May 14, 2024
Signal Analyzer20kHz-26.5GHz	Keysight	N9020A	MY49100060	May 15, 2023	May 14, 2024
Spectrum Analyzer9kHz-40GHz	R&S	FSP40	100363	May 15, 2023	May 14, 2024
Communication test set	R&S	CMW500	126173	Nov. 08, 2022	Nov. 07, 2023
Radio frequency control box	MAIWEI	MW200-RFC B	\	\	\
Software	MAIWEI	MTS 8200	\	\	\

Radiated Emissions Test (966 Chamber01)					
Equipment	Manufacturer	Model#	Serial#	Last Cal.	Next Cal.
966 chamber	ChengYu	966 Room	966	May 15, 2023	May 14, 2026
Receiver	R&S	ESR3	102075	May 15, 2023	May 14, 2024
Receiver	R&S	ESRP	101154	May 15, 2023	May 14, 2024
Amplifier	Schwarzbeck	BBV9744	9744-0037	May 15, 2023	May 14, 2024
TRILOG Broadband Antenna	Schwarzbeck	VULB9163	942	May 29, 2023	May 28, 2024
Loop Antenna(9KHz -30MHz)	Schwarzbeck	FMZB1519B	00014	May 31, 2023	May 30, 2024
Amplifier	SKET	LAPA_01G18 G-45dB	\	May 15, 2023	May 14, 2024
Horn Antenna	Schwarzbeck	BBHA9120D	1541	May 31, 2023	May 30, 2024
Amplifier(18G Hz-40GHz)	MITEQ	TTA1840-35-HG	2034381	May 15, 2023	May 14, 2024
Horn Antenna(18G Hz-40GHz)	Schwarzbeck	BBHA9170	00822	May 31, 2023	May 30, 2024
Spectrum Analyzer9kHz-40GHz	R&S	FSP40	100363	May 15, 2023	May 14, 2024
Communication test set	R&S	CMW500	126173	Nov. 08, 2022	Nov. 07, 2023
Software	Frad	EZ-EMC	FA-03A2 RE	\	\

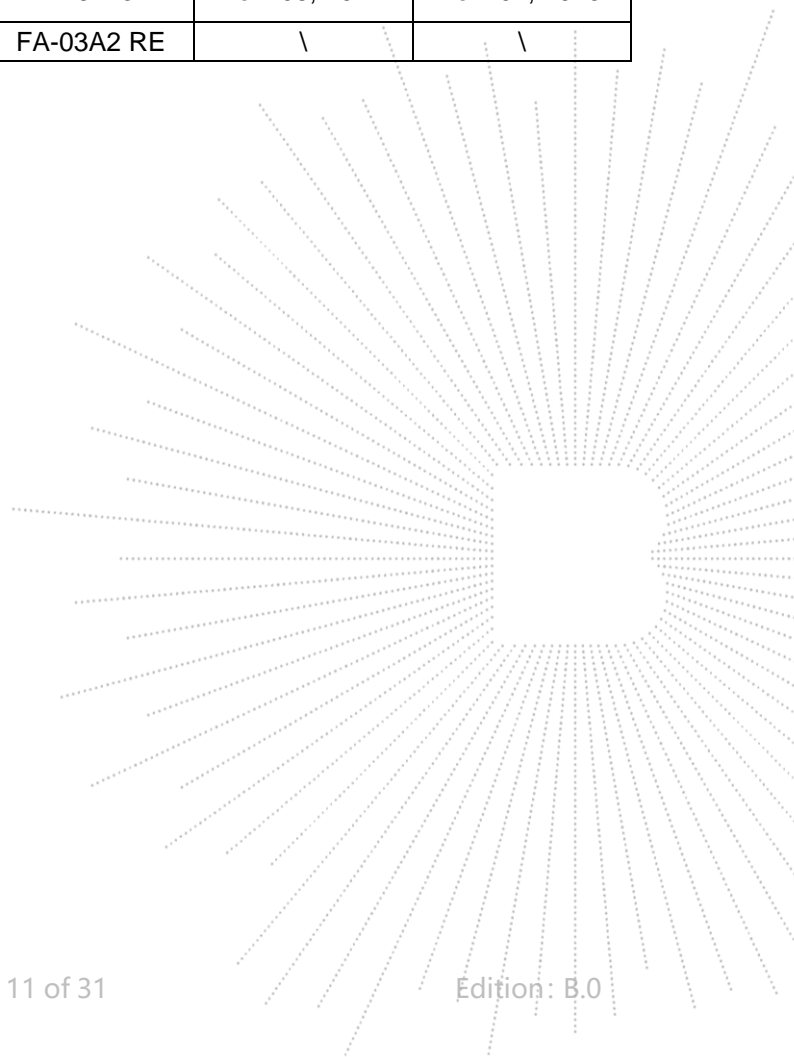

6. Conducted Emissions

6.1 Block Diagram Of Test Setup

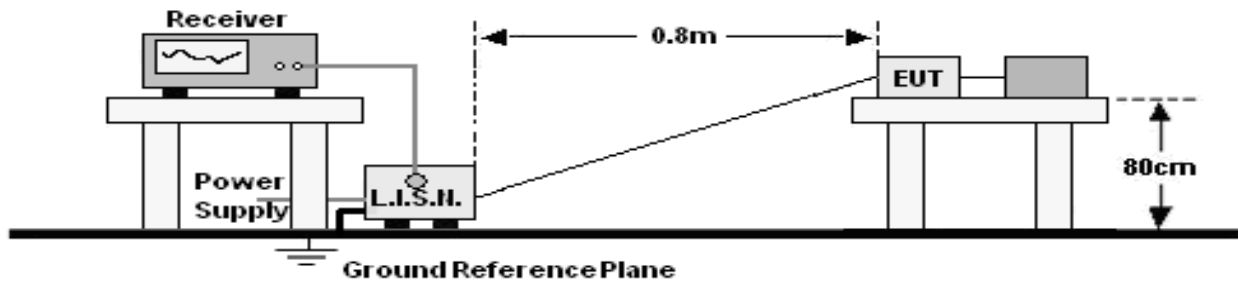

6.2 Limit

FREQUENCY (MHz)	Limit (dBuV)	
	Quas-peak	Average
0.15 -0.5	66 - 56 *	56 - 46 *
0.50 -5.0	56.00	46.00
5.0 -30.0	60.00	50.00

Notes:
 1. *Decreasing linearly with logarithm of frequency.
 2. The lower limit shall apply at the transition frequencies.

6.3 Test Procedure

Receiver Parameters	Setting
Attenuation	10 dB
Start Frequency	0.15 MHz
Stop Frequency	30 MHz
IF Bandwidth	9 kHz

- The Product was placed on a nonconductive table 0.8 m above the horizontal ground reference plane, and 0.4 m from the vertical ground reference plane, and connected to the main through Line Impedance Stability Network (L.I.S.N).
- The RBW of the receiver was set at 9 kHz in 150 kHz ~ 30MHz with Peak and AVG detector in Max Hold mode. Run the receiver's pre-scan to record the maximum disturbance generated from Product in all power lines in the full band.
- For each frequency whose maximum record was higher or close to limit, measure its QP and AVG values and record.

6.4 EUT operating Conditions

The EUT was configured for testing in a typical fashion (as a customer would normally use it). The EUT has been programmed to continuously transmit during test. This operating condition was tested and used to collect the included data.

6.5 Test Result

Temperature:	26 °C	Relative Humidity:	54%
Pressure:	101KPa	Phase :	L
Test Mode:	Mode 1	Test Voltage :	AC120V/60Hz

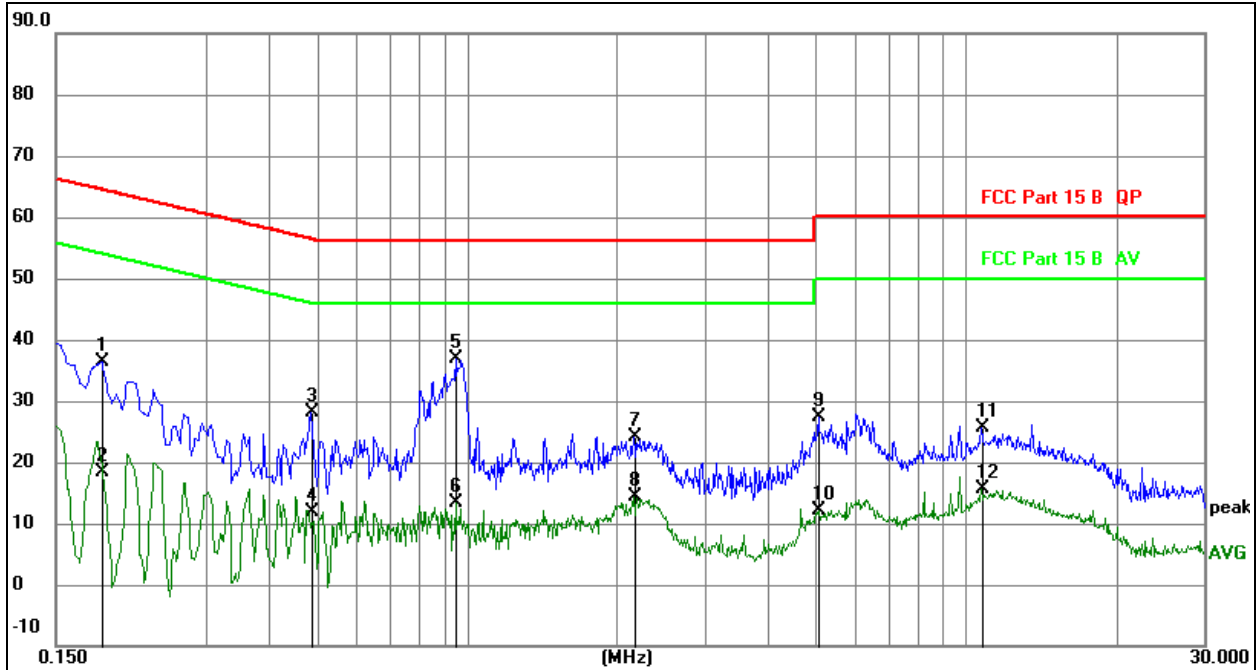

Remark:

1. All readings are Quasi-Peak and Average values.
2. Factor = Insertion Loss + Cable Loss.
3. Measurement = Reading Level + Correct Factor
4. Over = Measurement - Limit

No.	Mk.	Freq. MHz	Reading Level	Correct Factor dB	Measure- ment dBuV	Limit dBuV	Over dB	Detector
1		0.1860	26.81	9.58	36.39	64.21	-27.82	QP
2		0.1860	8.87	9.58	18.45	54.21	-35.76	AVG
3		0.4875	18.63	9.62	28.25	56.21	-27.96	QP
4		0.4875	2.23	9.62	11.85	46.21	-34.36	AVG
5	*	0.9510	27.27	9.71	36.98	56.00	-19.02	QP
6		0.9510	3.76	9.71	13.47	46.00	-32.53	AVG
7		2.1570	14.37	9.74	24.11	56.00	-31.89	QP
8		2.1570	4.58	9.74	14.32	46.00	-31.68	AVG
9		5.0775	17.65	9.80	27.45	60.00	-32.55	QP
10		5.0775	2.38	9.80	12.18	50.00	-37.82	AVG
11		10.7790	15.89	9.66	25.55	60.00	-34.45	QP
12		10.7790	5.91	9.66	15.57	50.00	-34.43	AVG

Temperature:	26 °C	Relative Humidity:	54%
Pressure:	101KPa	Phase :	N
Test Mode:	Mode 1	Test Voltage :	AC120V/60Hz

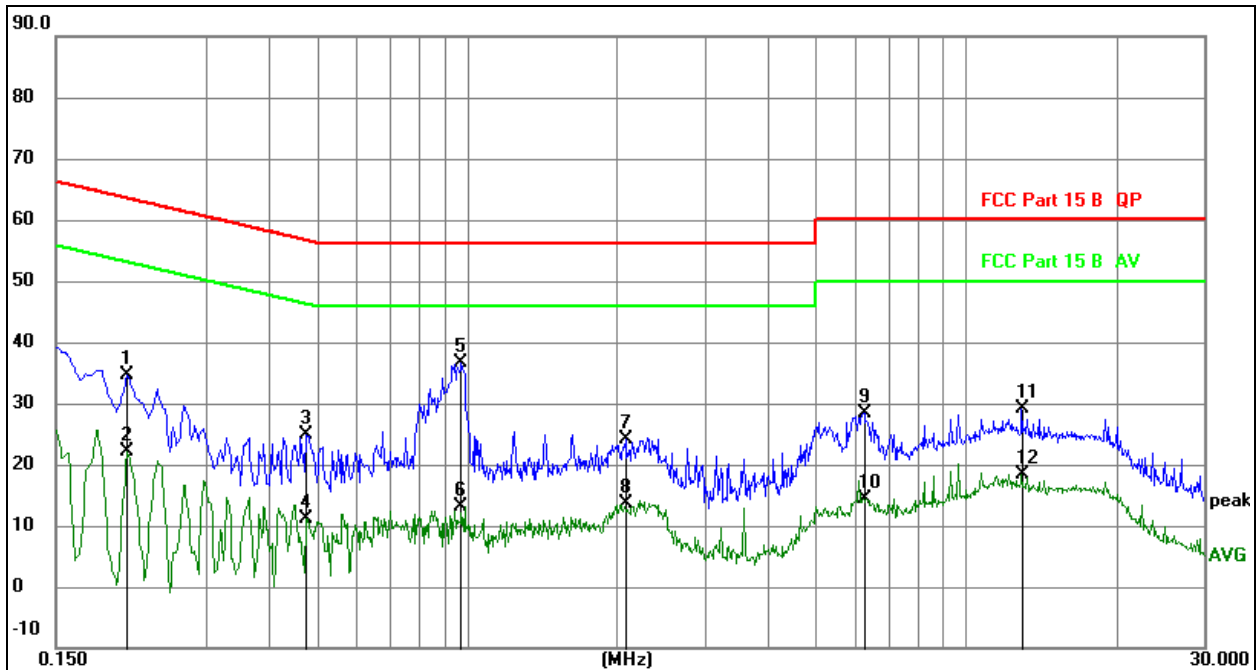
Remark:

1. All readings are Quasi-Peak and Average values.
2. Factor = Insertion Loss + Cable Loss.
3. Measurement = Reading Level + Correct Factor
4. Over = Measurement - Limit

No.	Mk.	Freq. MHz	Reading Level	Correct Factor dB	Measure- ment dBuV	Limit dBuV	Over dB	Detector
1		0.2083	25.12	9.61	34.73	63.27	-28.54	QP
2		0.2083	12.50	9.61	22.11	53.27	-31.16	AVG
3		0.4761	15.33	9.62	24.95	56.41	-31.46	QP
4		0.4761	1.61	9.62	11.23	46.41	-35.18	AVG
5	*	0.9735	26.96	9.72	36.68	56.00	-19.32	QP
6		0.9735	3.35	9.72	13.07	46.00	-32.93	AVG
7		2.0768	14.43	9.73	24.16	56.00	-31.84	QP
8		2.0768	3.87	9.73	13.60	46.00	-32.40	AVG
9		6.2520	18.61	9.76	28.37	60.00	-31.63	QP
10		6.2520	4.63	9.76	14.39	50.00	-35.61	AVG
11		12.9199	19.59	9.66	29.25	60.00	-30.75	QP
12		12.9199	8.77	9.66	18.43	50.00	-31.57	AVG

7. Radiated Emissions

7.1 Block Diagram Of Test Setup

(A) Radiated Emission Test-Up Frequency Below 30MHz

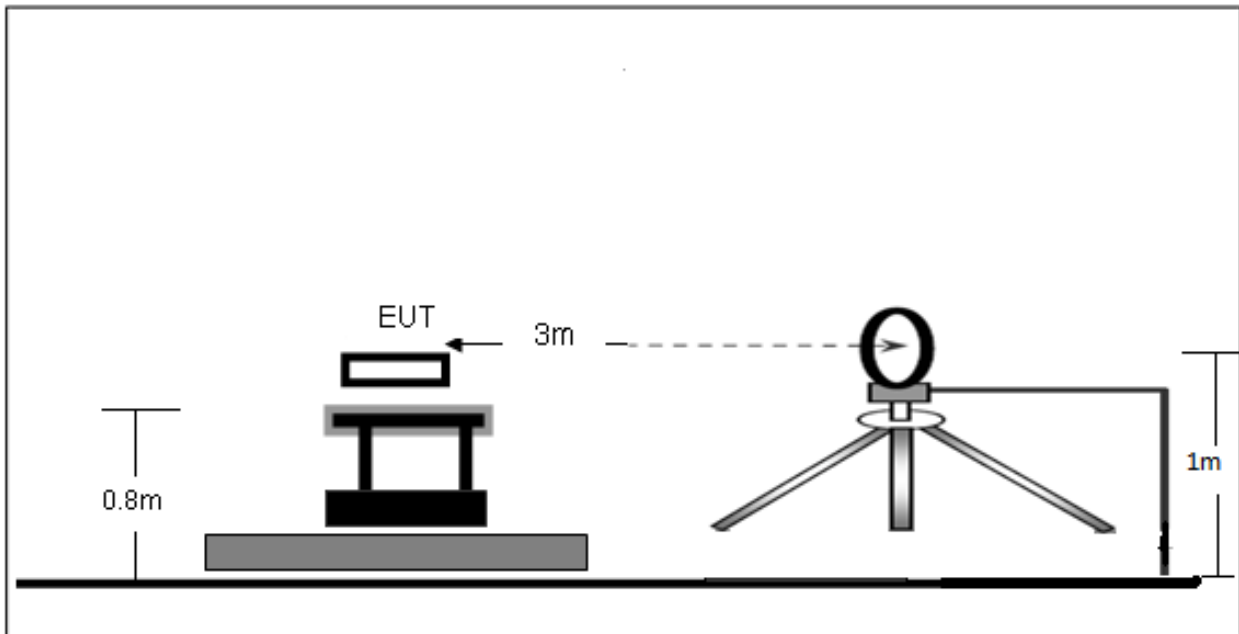

(B) Radiated Emission Test-Up Frequency 30MHz~1GHz

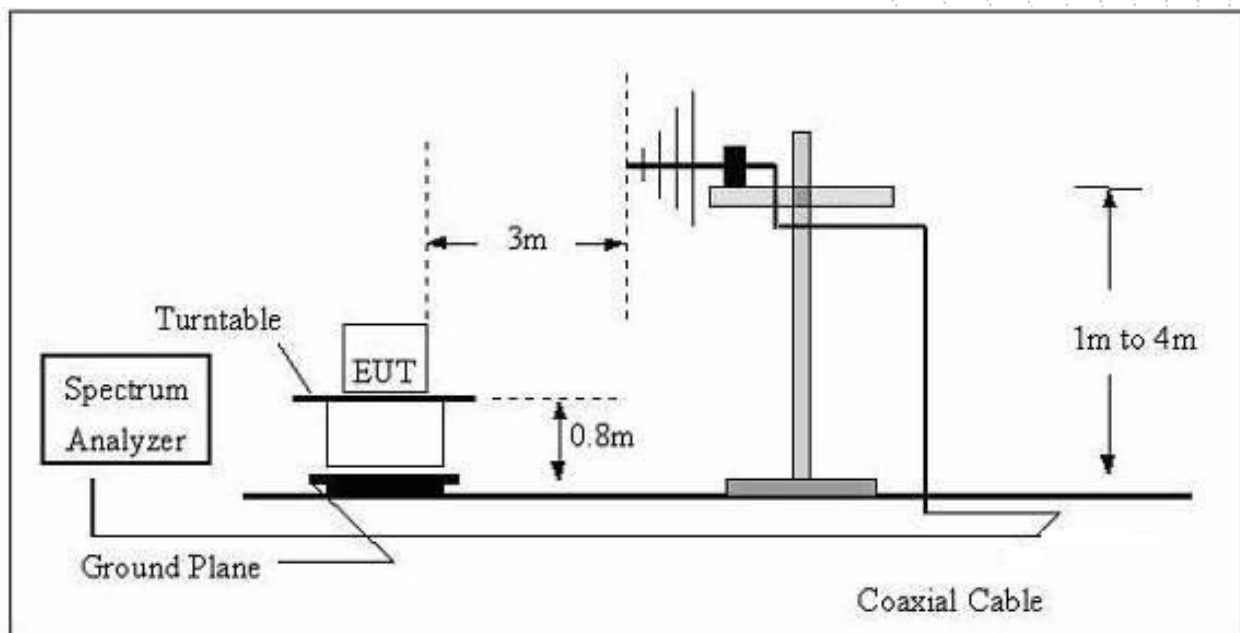

7.2 Limit

20dBc in any 100 kHz bandwidth outside the operating frequency band. In case the emission fall within the restricted band specified on 15.205(a), then the 15.209(a) limit in the table below has to be followed.

Frequency (MHz)	Field Strength uV/m	Distance (m)	Field Strength Limit at 3m Distance	
			uV/m	dBuV/m
0.009 ~ 0.490	2400/F(kHz)	300	10000 * 2400/F(kHz)	$20\log^{(2400/F(kHz))} + 80$
0.490 ~ 1.705	24000/F(kHz)	30	100 * 24000/F(kHz)	$20\log^{(24000/F(kHz))} + 40$
1.705 ~ 30	30	30	100 * 30	$20\log^{(30)} + 40$
30 ~ 88	100	3	100	$20\log^{(100)}$
88 ~ 216	150	3	150	$20\log^{(150)}$
216 ~ 960	200	3	200	$20\log^{(200)}$
Above 960	500	3	500	$20\log^{(500)}$

Receiver Parameter	Setting
Attenuation	Auto
Start ~ Stop Frequency	9kHz~150kHz / RB 200Hz for QP
Start ~ Stop Frequency	150kHz~30MHz / RB 9kHz for QP
Start ~ Stop Frequency	30MHz~1000MHz / RB 120kHz for QP

Below 1GHz test procedure as below:

- a. The EUT was placed on the top of a rotating table 0.8 meters above the ground at a 3 meter semi-anechoic chamber. The table was rotated 360 degrees to determine the position of the highest radiation.
 - b. The EUT was set 3 meters away from the interference-receiving antenna, which was mounted on the top of a variable-height antenna tower.
 - c. The antenna height is varied from one meter to four meters above the ground to determine the maximum value of the field strength. Both horizontal and vertical polarizations of the antenna are set to make the measurement.
 - d. For each suspected emission, the EUT was arranged to its worst case and then the antenna was tuned to heights from 1 meter to 4 meters (for the test frequency of below 30MHz, the antenna was tuned to heights 1 meter) and the rotatable table was turned from 0 degrees to 360 degrees to find the maximum reading.
 - e. The test-receiver system was set to Peak Detect Function and Specified Bandwidth with Maximum Hold Mode.
 - f. If the emission level of the EUT in peak mode was 10dB lower than the limit specified, then testing could be stopped and the peak values of the EUT would be reported. Otherwise the emissions that did not have 10dB margin would be re-tested one by one using peak, quasi-peak or average method as specified and then reported in a data sheet.
- Above 1GHz test procedure as below:
- g. Different between above is the test site, change from Semi- Anechoic Chamber to fully Anechoic Chamber and change form table 0.8 metre to 1.5 metre(Above 18GHz the distance is 1 meter and table is 1.5 metre).
 - h. Test the EUT in the lowest channel ,the middle channel ,the Highest channel.

Note:

Both horizontal and vertical antenna polarities were tested and performed pretest to three orthogonal axis. The worst case emissions were reported.

7.3 EUT Operating Conditions

The EUT was configured for testing in a typical fashion (as a customer would normally use it). The EUT has been programmed to continuously transmit during test. This operating condition was tested and used to collect the included data.

7.4 Test Result

Temperature:	26°C	Relative Humidity:	54%
Pressure:	101 kpa	Test Voltage :	DC 5V
Test Mode :	Mode 1	Polarization:	Coaxial

Frequency (KHz)	Meter Reading (dBμV)	Factor (dB)	Emission Level (dBμV/m)	Limits (dBμV/m)	Margin (dB)	Detector Type
22.84	64.91	20.15	85.06	140.43	-55.37	PK
22.84	40.93	20.15	61.08	120.43	-59.35	AV
61.92	52.81	20.33	73.14	131.77	-58.63	PK
61.92	38.45	20.33	58.78	111.77	-52.99	AV
151.73	54.04	20.55	74.59	123.98	-49.39	PK
151.73	47.92	20.55	68.47	103.98	-35.51	AV
526.17	25.82	20.64	46.46	73.18	-26.72	QP
754.30	29.32	21.26	50.58	70.05	-19.47	QP
1200.42	18.20	22.32	40.52	66.02	-25.50	QP

Note:

Pre-scan in the all of mode, the worst case in of was recorded.

Factor = antenna factor + cable loss – pre-amplifier.

Margin = Emission Level- Limit.

The amplitude of spurious emissions which are attenuated by more than 20dB below the permissible value has no need to be reported.

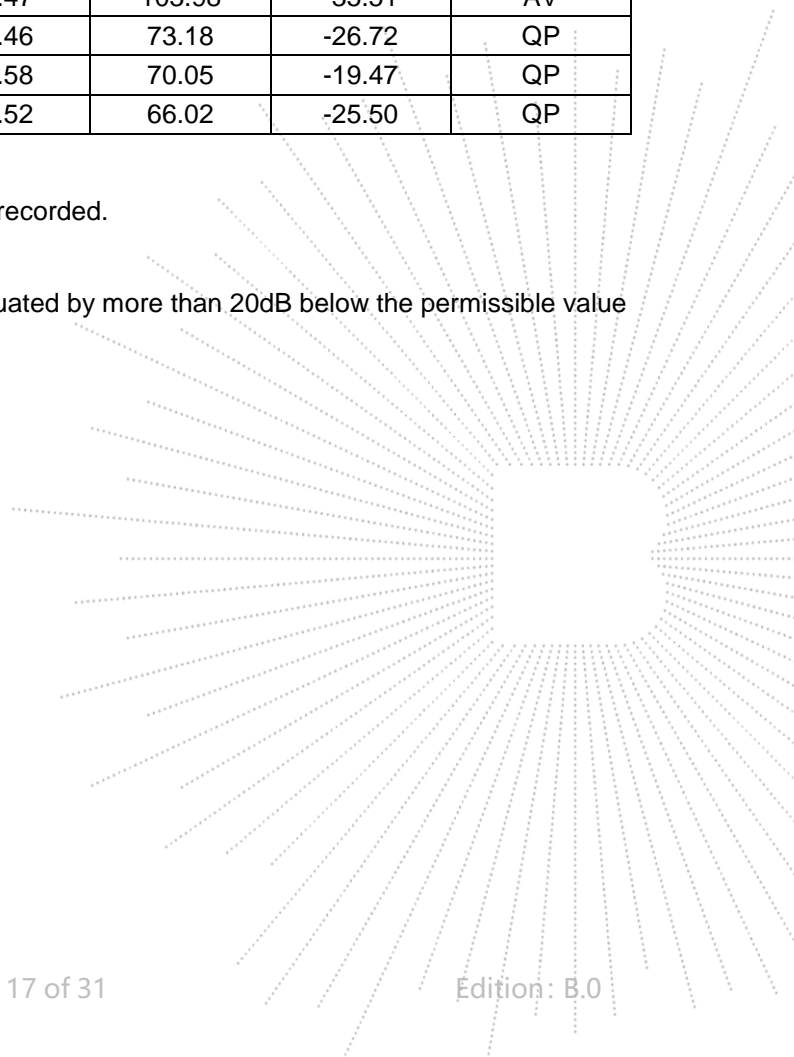

Between 30MHz – 1GHz

Temperature:	26 °C	Relative Humidity:	54%
Pressure:	101KPa	Phase :	Horizontal
Test Mode:	Mode 1	Test Voltage:	AC120V/60Hz

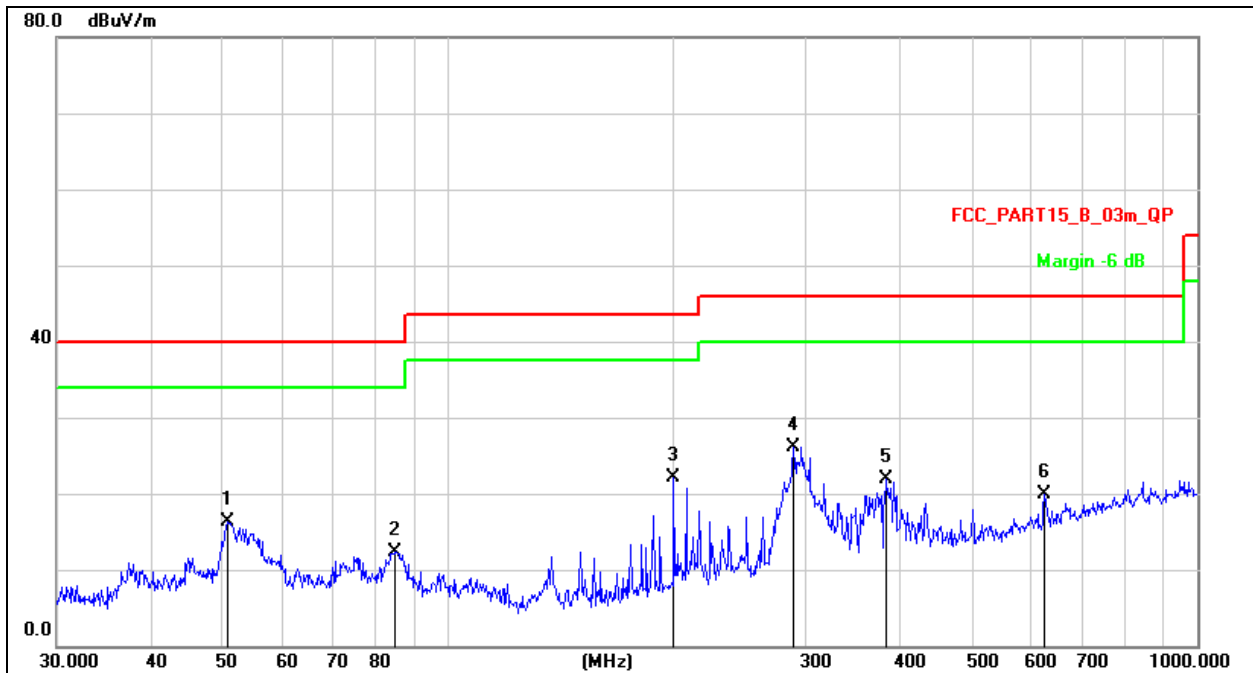

Remark:

1. Factor = Antenna Factor + Cable Loss – Pre-amplifier.
2. Measurement=Reading Level+ Correct Factor
3. Over=Measurement-Limit

No.	Mk.	Freq. MHz	Reading Level dBuV	Correct Factor dB	Measure- ment dBuV/m	Limit dB/m	Over dB	Detector
1		50.7637	31.91	-15.70	16.21	40.00	-23.79	QP
2		84.7019	32.82	-20.46	12.36	40.00	-27.64	QP
3		199.9856	39.51	-17.37	22.14	43.50	-21.36	QP
4	*	289.0021	40.99	-14.85	26.14	46.00	-19.86	QP
5		383.9318	34.30	-12.40	21.90	46.00	-24.10	QP
6		625.0780	28.00	-8.05	19.95	46.00	-26.05	QP

Temperature:	26 °C	Relative Humidity:	54%
Pressure:	101KPa	Phase :	Vertical
Test Mode:	Mode 1	Test Voltage:	AC120V/60Hz

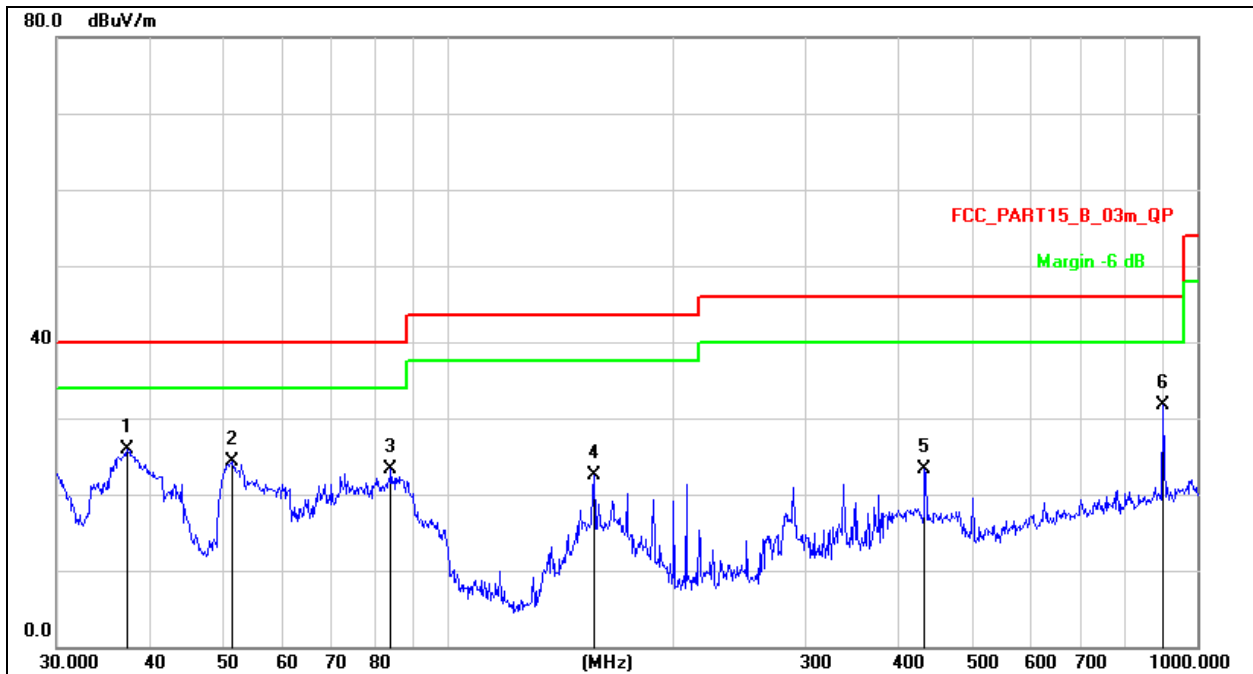

Remark:
 1. Factor = Antenna Factor + Cable Loss – Pre-amplifier.
 2. Measurement=Reading Level+ Correct Factor
 3. Over= Measurement-Limit

No.	Mk.	Freq. MHz	Reading Level dBuV	Correct Factor dB	Measure- ment dBuV/m	Limit dB/m	Over dB	Detector
1	*	37.2855	43.07	-17.17	25.90	40.00	-14.10	QP
2		51.4807	40.11	-15.81	24.30	40.00	-15.70	QP
3		83.8156	44.04	-20.67	23.37	40.00	-16.63	QP
4		156.4578	43.13	-20.57	22.56	43.50	-20.94	QP
5		432.5457	35.03	-11.74	23.29	46.00	-22.71	QP
6		900.1474	36.31	-4.59	31.72	46.00	-14.28	QP

8. Radiated Band Emission Measurement

8.1 Block Diagram Of Test Setup

Radiated Emission Test-Up Frequency Below 30MHz

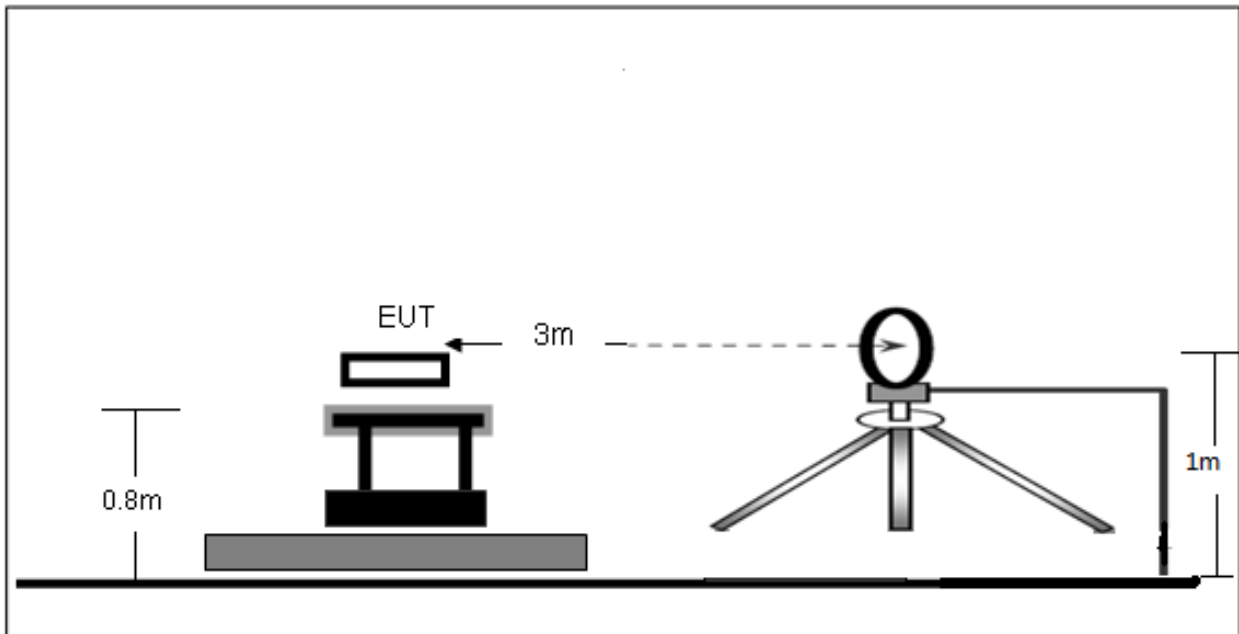

8.2 Limit

FCC Part15 C Section 15.209 and 15.225

LIMITS OF RADIATED EMISSION MEASUREMENT (Below 30MHz)

- 15.848 microvolts/m (84 dB μ V/m) at 30 m, within the band 13.553– 13.567 MHz.
- 334 microvolts/m (50.5 dB μ V/m) at 30 m, within the bands 13.410– 13.553 MHz and 13.567– 13.710 MHz.
- 106 microvolts/m (40.5 dB μ V/m) at 30 m, within the bands 13.110– 13.410 MHz and 13.710– 14.010 MHz.
- 30 microvolts/m (29.5 dB μ V/m) at 30 m, outside the band 13.110– 14.010 MHz.

Notes:

- (1) The limit for radiated test was performed according to FCC PART 15C.
- (2) The tighter limit applies at the band edges.
- (3) Emission level (dB μ V/m)=20log Emission level (uV/m).

8.3 Test Procedure

- a. The Product is placed on a turntable 0.8 meters above the ground in the chamber, 3 meter away from the antenna (loop antenna). The maximum values of the field strength are recorded by adjusting the polarizations of the test antenna and rotating the turntable.
- b. For each suspected emission, the Product was arranged to its worst case and then turn table was turned from 0 degrees to 360 degrees to find the maximum reading.
- c. The test frequency analyzer system was set to Peak Detect (300Hz RBW in 9kHz to 150kHz and 10kHz RBW in 150kHz to 30MHz) Function and Specified Bandwidth with Maximum Hold Mode.

8.4 EUT Operating Conditions

The EUT tested system was configured as the statements of 4.5 Unless otherwise a special operating condition is specified in the follows during the testing.
The report only show the worst antenna Polarity's data.

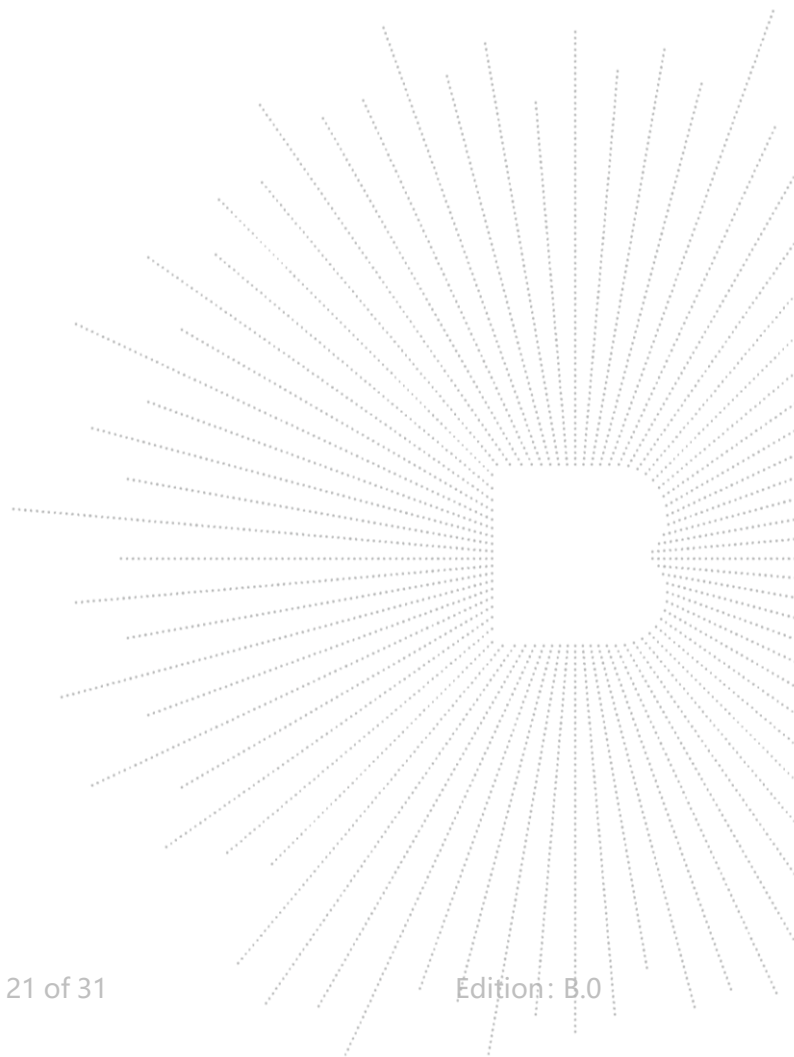

8.5 Test Result

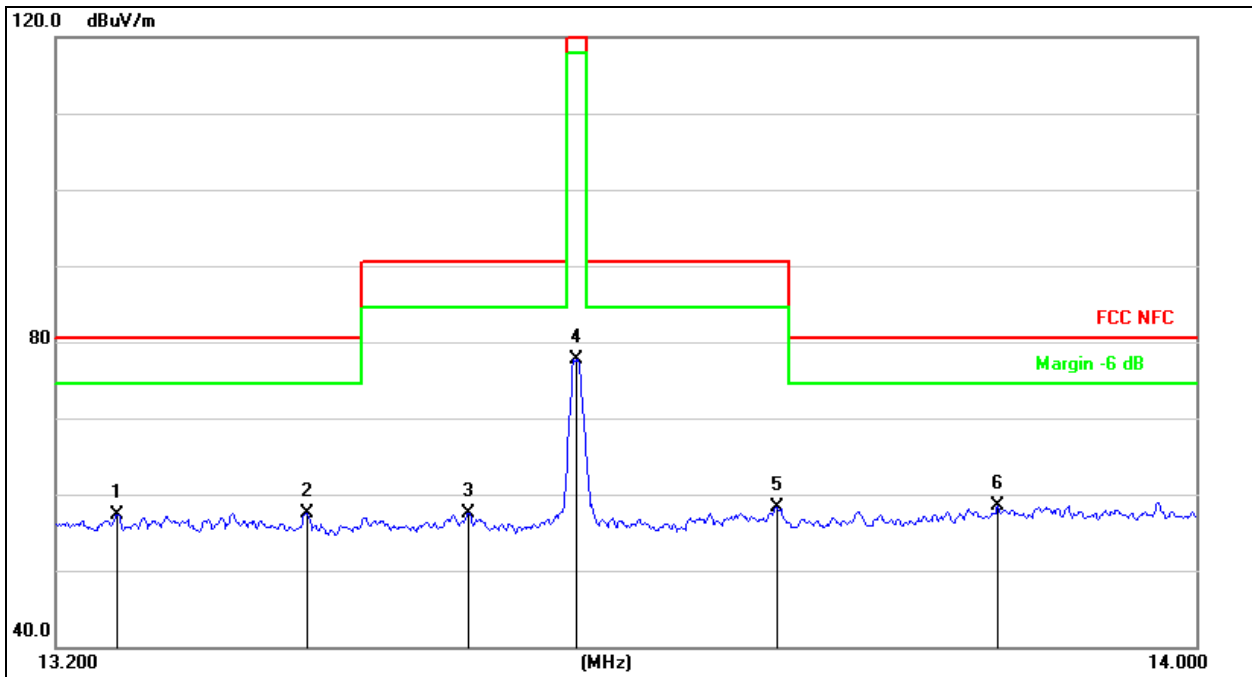

No.	Mk.	Freq. MHz	Reading Level dBuV	Correct Factor dB	Measure- ment dBuV/m	Limit dB/m	Over dB	Detector
1		13.2423	36.89	20.42	57.31	80.50	-23.19	peak
2		13.3719	37.11	20.43	57.54	80.50	-22.96	peak
3		13.4847	37.10	20.44	57.54	90.50	-32.96	peak
4		13.5600	57.33	20.44	77.77	124.0	-46.23	peak
5		13.7004	37.89	20.45	58.34	90.50	-32.16	peak
6	*	13.8574	37.97	20.46	58.43	80.50	-22.07	peak

9. Bandwidth Test

9.1 Block Diagram Of Test Setup



9.2 Test Procedure

FCC Part15 (15.215)	
Section	Test Item
15.215	Bandwidth

1. Set RBW = 1% to 5% of the OBW
2. Set the video bandwidth (VBW) \geq RBW.
3. Detector = Peak.
4. Trace mode = max hold.
5. Sweep = auto couple.
6. Allow the trace to stabilize.
7. Measure the maximum width of the emission that is constrained by the frequencies associated with the two outermost amplitude points (upper and lower frequencies) that are attenuated by 20 dB relative to the maximum level measured in the fundamental emission.

9.3 EUT Operation Conditions

The EUT tested system was configured as the statements of 4.2 Unless otherwise a special operating condition is specified in the follows during the testing.

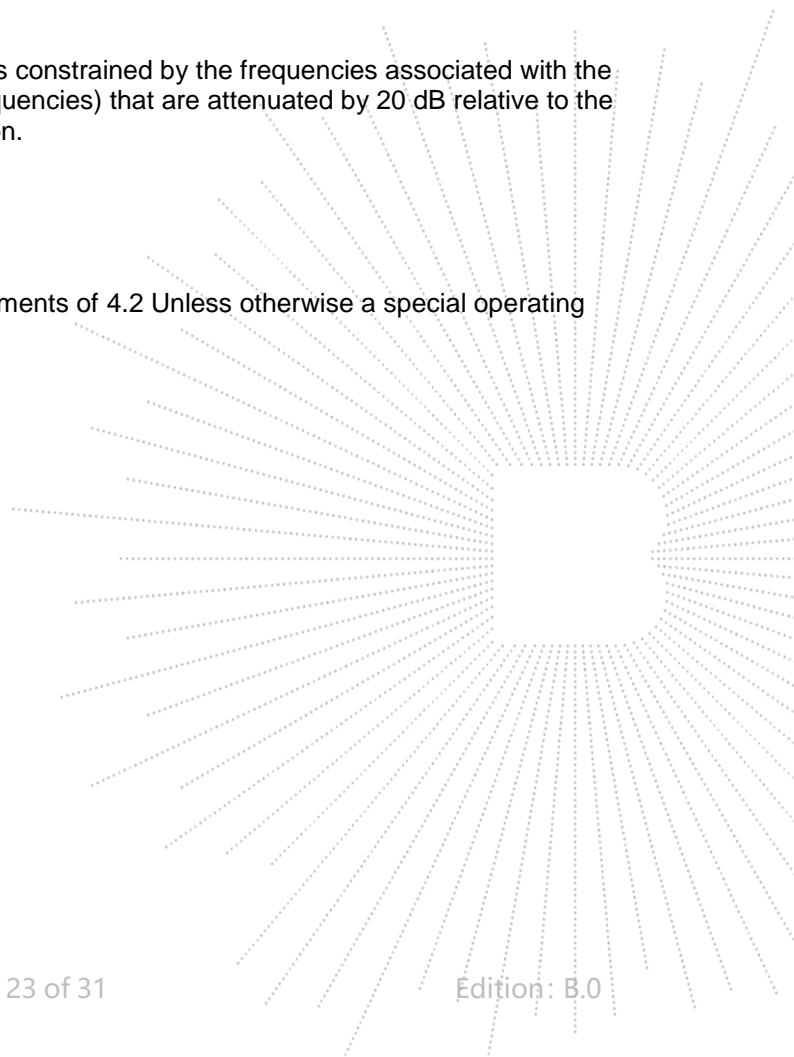

9.4 Test Result

Temperature:	26°C	Relative Humidity:	54%
Test Mode:	ASK	Test Voltage :	DC 5V

Frequency (MHz)	-20dB bandwidth (kHz)
13.56	0.073

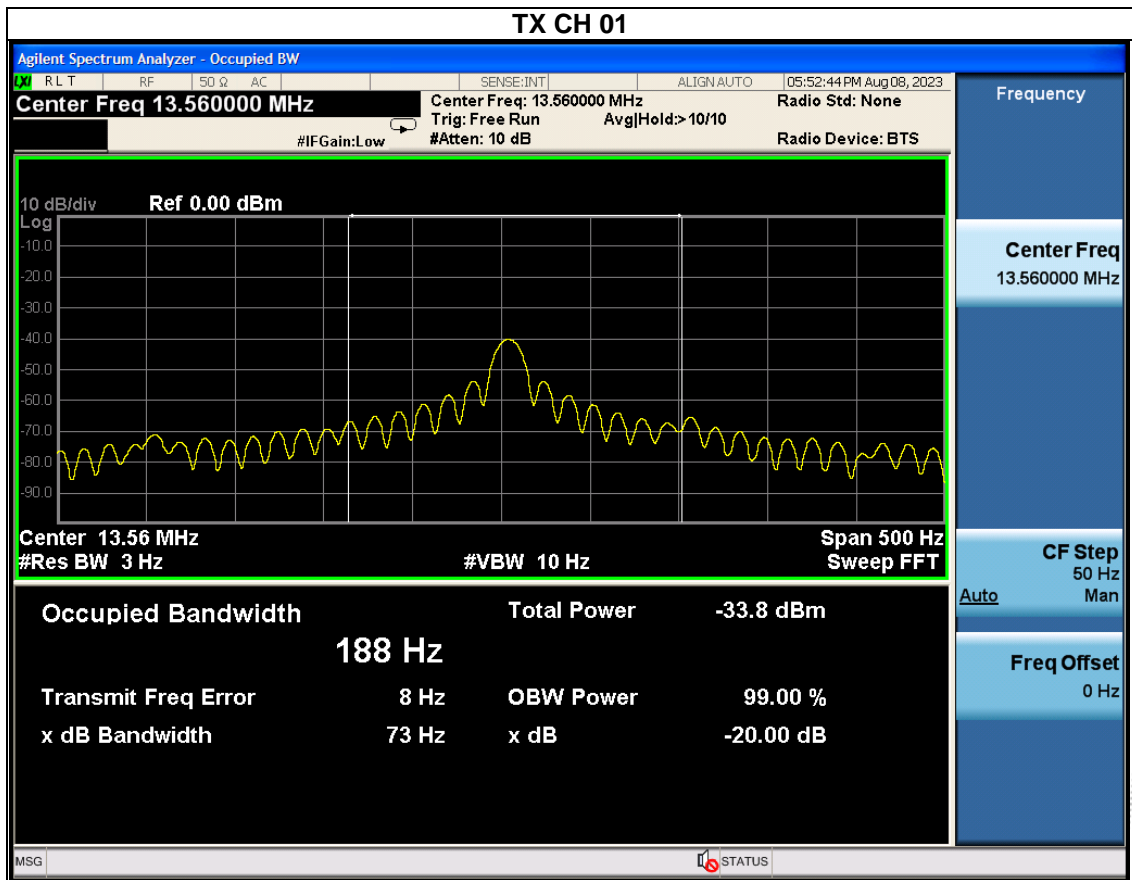

10. Transmitter Frequency Stability

10.1 Block Diagram Of Test Setup

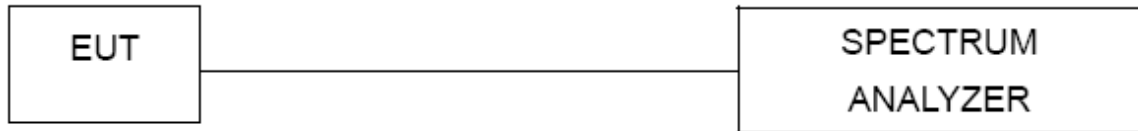

10.2 Limit

The frequency tolerance of the carrier signal shall be maintained within $\pm 0.01\%$ of the operating frequency over a temperature variation of -20 degrees to $+50$ degrees C at normal supply voltage, and for a variation in the primary supply voltage from 85% to 115% of the rated supply voltage at a temperature of 20 degrees C. For battery operated equipment, the equipment tests shall be performed using a new battery.
Limit: $\pm 0.01\%$ of $13.56\text{MHz} = 1356\text{Hz}$

10.3 Test Procedure

1. Set RBW = 10 kHz.
2. Set the video bandwidth (VBW) \geq RBW.
3. Detector = Peak.
4. Trace mode = max hold.
5. Sweep = auto couple.
6. Allow the trace to stabilize.
7. The transmitter output (antenna port) was connected to the spectrum analyzer.

10.4 EUT Operating Conditions

The EUT tested system was configured as the statements of 4.5 Unless otherwise a special operating condition is specified in the follows during the testing.

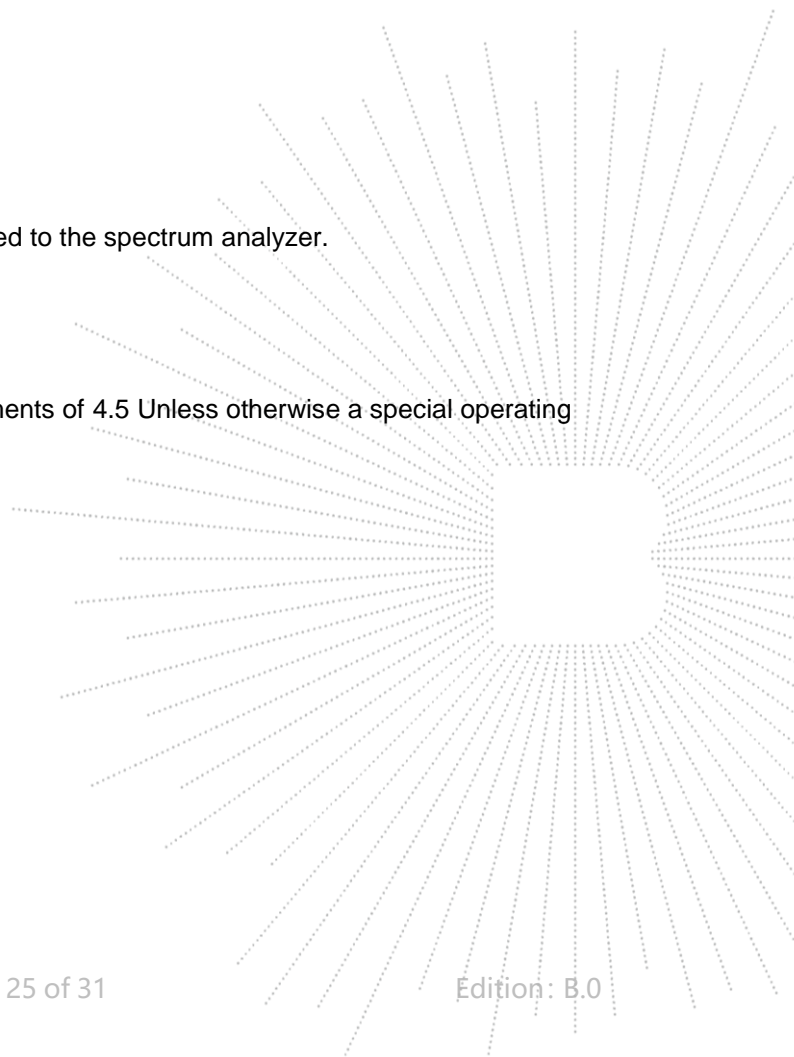

10.5 Test Result

Temperature :	26°C	Relative Humidity :	54%
Pressure :	101kPa	Test Voltage :	DC 7.74V
Test Mode :	TX Mode		

Test Conditions			Frequency Deviation		Limit
Frequency MHz	Power(Vdc)	Temperature (°C)	Measured Freq.	Frequency Error(Hz)	
13.56	7.74	-20	13.56003	30	1356
	7.74	-10	13.56007	70	1356
	7.74	0	13.56005	50	1356
	7.74	10	13.56004	40	1356
	7.74	20	13.56010	100	1356
	7.74	30	13.56006	60	1356
	7.74	40	13.56002	20	1356
	7.74	50	13.56008	80	1356
	8.51	20	13.56005	50	1356
	6.96	20	13.56007	70	1356

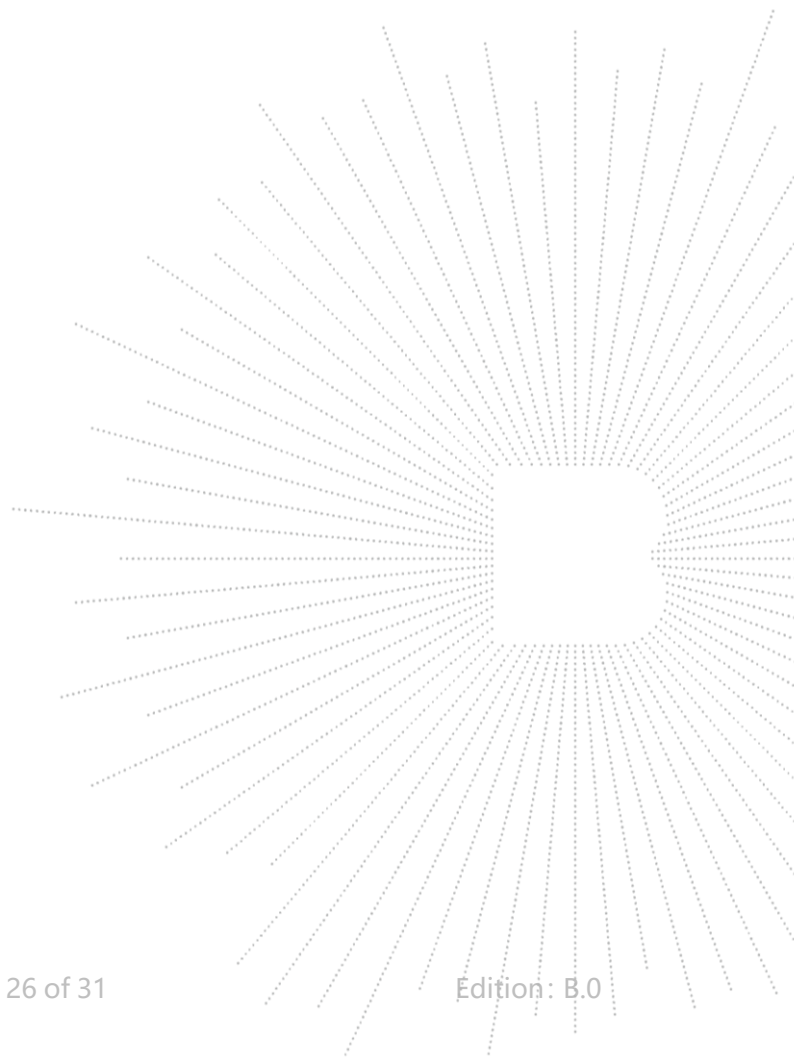

11. Antenna Requirement

11.1 Standard Requirement

15.203 requirement: For intentional device, according to 15.203: an intentional radiator shall be designed to ensure that no antenna other than that furnished by the responsible party shall be used with the device.

11.2 EUT Antenna

The EUT antenna is Internal Antenna, It comply with the standard requirement.

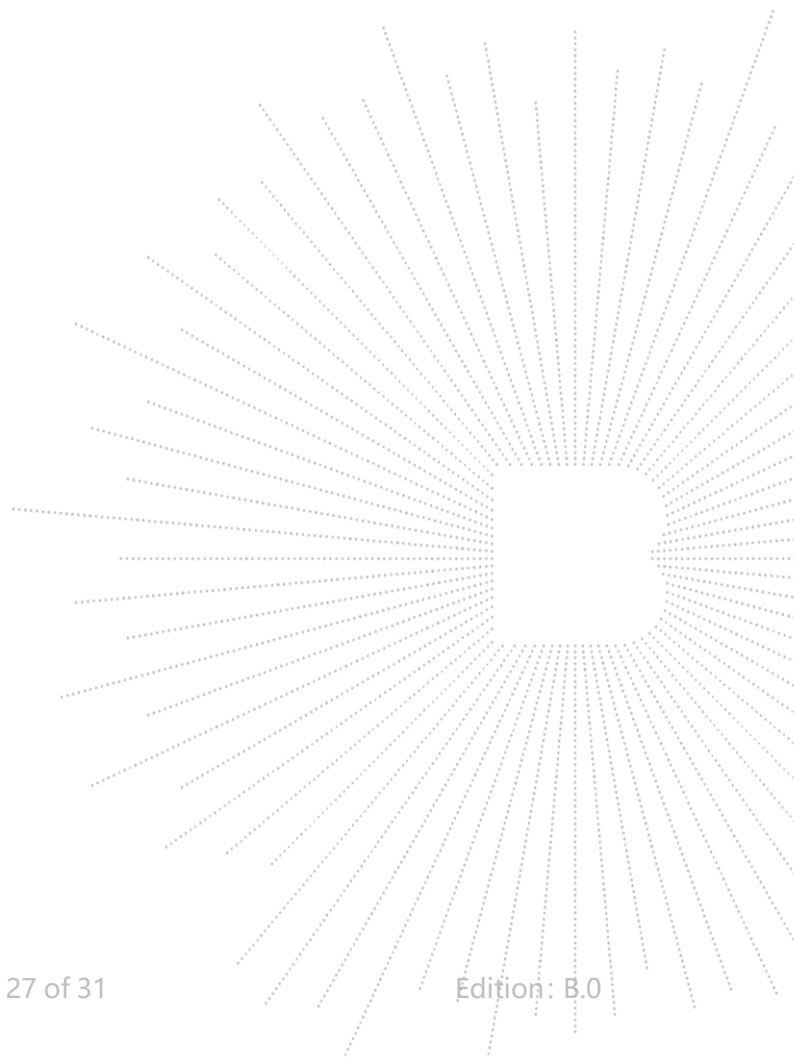

12. EUT Photographs

EUT Photo 1



EUT Photo 2



13. EUT Test Setup Photographs

Conducted Emissions Photo

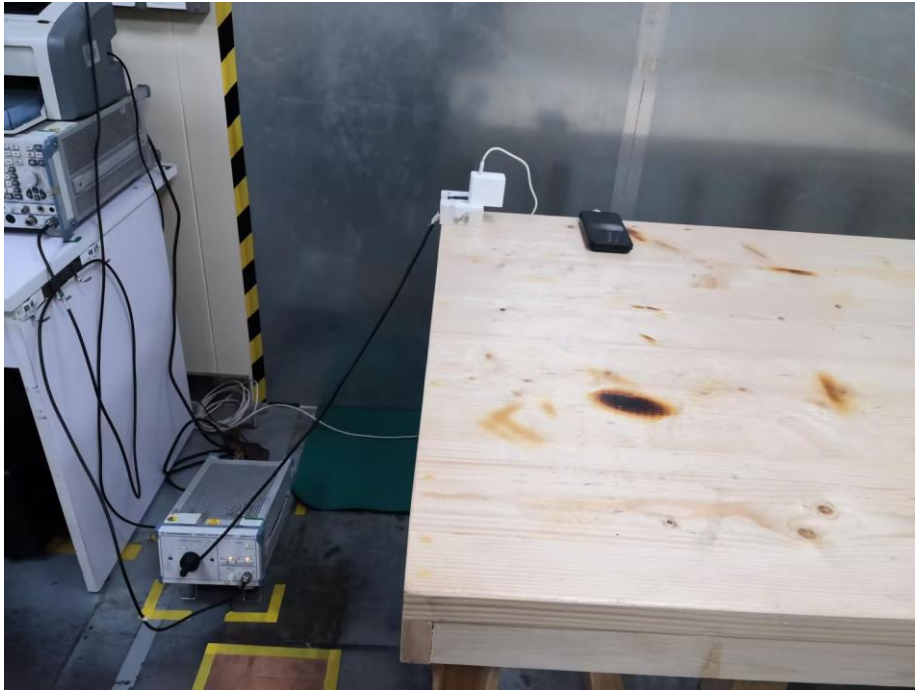

Radiated Measurement Photos

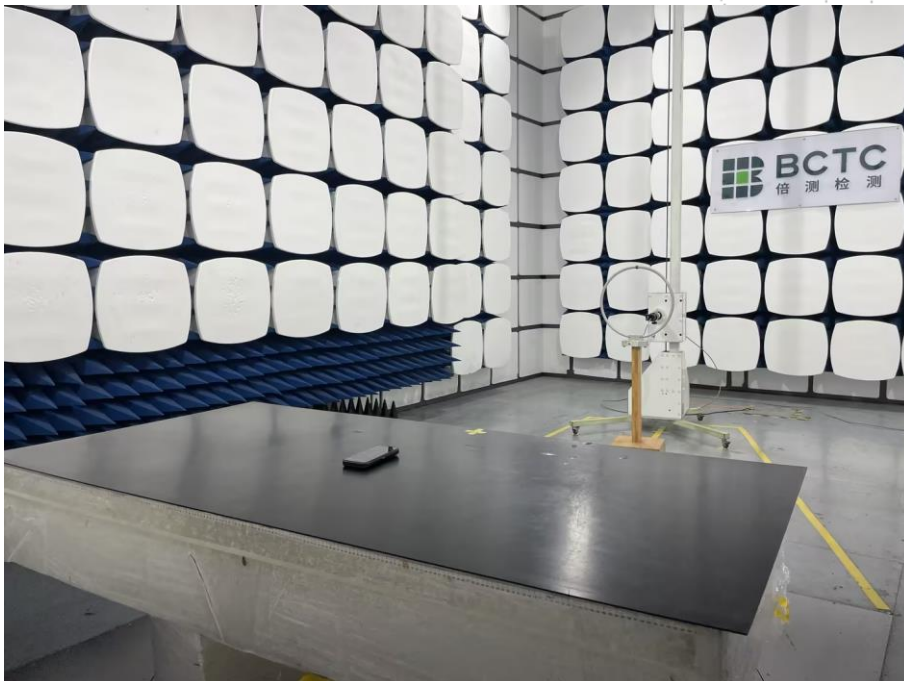

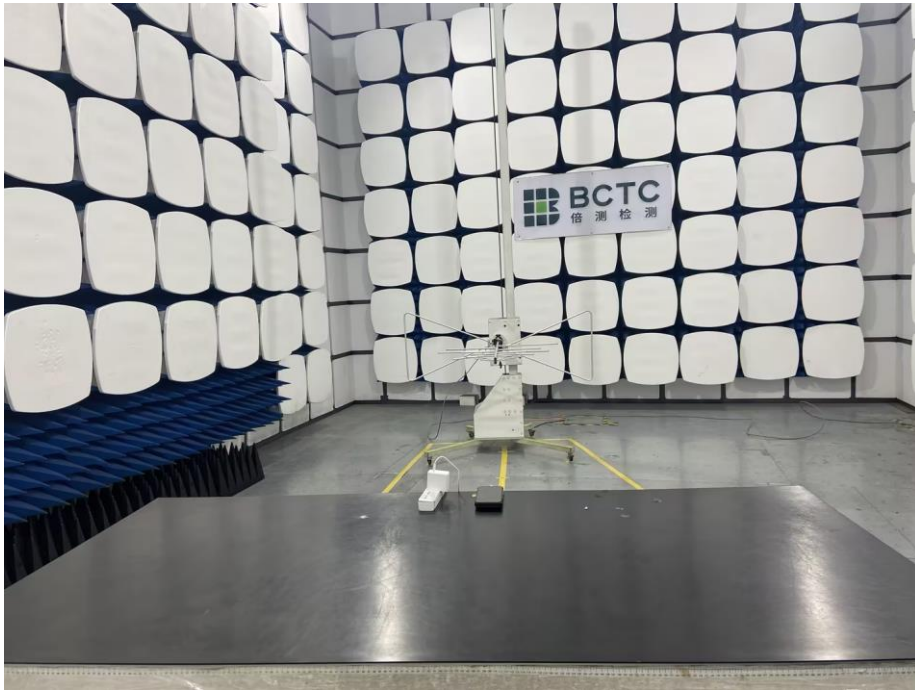

STATEMENT

1. The equipment lists are traceable to the national reference standards.
2. The test report can not be partially copied unless prior written approval is issued from our lab.
3. The test report is invalid without the "special seal for inspection and testing".
4. The test report is invalid without the signature of the approver.
5. The test process and test result is only related to the Unit Under Test.
6. Sample information is provided by the client and the laboratory is not responsible for its authenticity.
7. The quality system of our laboratory is in accordance with ISO/IEC17025.
8. If there is any objection to this test report, the client should inform issuing laboratory within 15 days from the date of receiving test report.

Address:

1-2/F., Building B, Pengzhou Industrial Park, No.158, Fuyuan 1st Road, Zhancheng, Fuhai Subdistrict, Bao'an District, Shenzhen, Guangdong, China

TEL: 400-788-9558

P.C.: 518103

FAX: 0755-33229357

Website: <http://www.chnbctc.com>E-Mail: bctc@bctc-lab.com.cn

***** END *****

