

2 Laboratories Introduction

Waltek Services Test Group Ltd. is one of the largest and the most comprehensive third party testing organizations in China, our headquarter located in Shenzhen (CNAS Registration No. L3110, A2LA Certificate Number: 4243.01) and have branches in Foshan (CNAS Registration No. L6478), Dongguan (CNAS Registration No. L9950), Zhongshan, Suzhou (CNAS Registration No. L7754), Ningbo and Hong Kong, Our test capability covered four large fields: safety test. Electronic Magnetic Compatibility(EMC), reliability and energy performance, Chemical test. Meanwhile, Waltek has got recognition as registration and accreditation laboratory from EMSD (Electrical and Mechanical Services Department), and American Energy star, FCC(The Federal Communications Commission), CPSC(Consumer Product Safety Commission), CEC(California energy efficiency), IC(Industry Canada) and ELI(Efficient Lighting Initiative). It's the strategic partner and data recognition laboratory of international authoritative organizations, such as UL, Intertek(ETL-SEMKO), CSA, TÜV Rheinland, TÜV SÜD, etc. As a professional, comprehensive, justice international test organization, we still keep the scientific and rigorous work attitude to help each client satisfy the international standards and assist their product enter into globe market smoothly.

Waltek Services (Shenzhen) Co., Ltd.

A. Accreditations for Conformity Assessment (International)

Country/Region	Accreditation Body	Scope	Note
USA	CNAS (Registration No.: L3110) A2LA (Certificate No.: 4243.01)	FCC ID \ DOC \ VOC	1
Canada		IC ID \ VOC	2
Japan		MIC-T \ MIC-R	-
Europe		EMCD \ RED	-
Taiwan		NCC	-
Hong Kong		OFCA	-
Australia		RCM	-
India	International Services	WPC	-
Thailand		NTC	-
Singapore		IDA	-
Note:			
1. FCC Designation No.: CN1201. Test Firm Registration No.: 523476.			
2. IC Canada Registration No.: 7760A			

B. TCBs and Notify Bodies Recognized Testing Laboratory.

Recognized Testing Laboratory of ...	Notify body number
--------------------------------------	--------------------

Waltek Services (Shenzhen) Co.,Ltd.
<http://www.waltek.com.cn>

TUV Rheinland	Optional.
Intertek	
TUV SUD	
SGS	
Phoenix Testlab GmbH	0700
Element Materials Technology Warwick Ltd	0891
Timco Engineering, Inc.	1177
Eurofins Product Service GmbH	0681

3 Contents

	Page
1 COVER PAGE	1
2 LABORATORIES INTRODUCTION	2
3 CONTENTS	4
4 REVISION HISTORY	6
5 GENERAL INFORMATION	7
5.1 GENERAL DESCRIPTION OF E.U.T.	7
5.2 DETAILS OF E.U.T.	7
5.3 TEST MODE.....	10
6 TEST SUMMARY	12
7 EQUIPMENT USED DURING TEST	13
7.1 EQUIPMENTS LIST.....	13
7.2 MEASUREMENT UNCERTAINTY.....	14
7.3 TEST EQUIPMENT CALIBRATION.....	14
8 RF OUTPUT POWER	15
8.1 EUT OPERATION.....	15
8.2 TEST PROCEDURE.....	15
8.3 TEST RESULT.....	16
9 PEAK-TO-AVERAGE RATIO	55
9.1 EUT OPERATION.....	55
9.2 TEST PROCEDURE.....	55
9.3 TEST RESULT.....	55
10 BANDWIDTH	56
10.1 EUT OPERATION.....	56
10.2 TEST PROCEDURE.....	56
10.3 TEST RESULT.....	57
11 SPURIOUS EMISSIONS AT ANTENNA TERMINALS	89
11.1 EUT OPERATION.....	89
11.2 TEST PROCEDURE.....	89
11.3 TEST RESULT.....	89
12 SPURIOUS RADIATED EMISSIONS	90
12.1 EUT OPERATION.....	90
12.2 TEST SETUP.....	90
12.3 SPECTRUM ANALYZER SETUP.....	91
12.4 TEST PROCEDURE.....	92
12.5 SUMMARY OF TEST RESULTS.....	93
13 BAND EDGE MEASUREMENT	99
13.1 EUT OPERATION.....	99
13.2 TEST PROCEDURE.....	99
13.3 TEST RESULT.....	100
14 FREQUENCY STABILITY	101
14.1 EUT OPERATION.....	101
14.2 TEST PROCEDURE.....	101
14.3 TEST RESULT.....	102

15	RF EXPOSURE.....	128
16	PHOTOGRAPHS OF TEST SETUP AND EUT.....	129

4 Revision History

Test report No.	Date of Receipt sample	Date of Test	Date of Issue	Purpose	Comment	Approved
WTS17S12975 35-4E	2017-12-09	2017-12-10 to 2017-12- 21	2017-12-22	original	-	Replaced
WTS17S12975 35-4E V1	2017-12-09	2017-12-10 to 2017-12- 21	2018-01-04	Version 1	Updated	Valid

5 General Information

5.1 General Description of E.U.T.

Product:	Smart Phone
Model(s):	U7 Plus
Model Description:	N/A
GSM Band(s):	GSM 850/900/1800/1900MHz
GPRS/EGPRS Class:	12
WCDMA Band(s):	FDD Band I/II/IV/V/VIII
LTE Band(s):	FDD Band 2/4/5/7/12/17
Wi-Fi Specification:	2.4G-802.11b/g/n HT20/n HT40
Bluetooth Version:	Bluetooth v4.0 with BLE
GPS:	Support
NFC:	N/A
Hardware Version:	HCT-T637MB-A1
Software Version:	OUKITEL_U7_Plus_nm_V1.1
Highest frequency (Exclude Radio):	2.0GHz
Storage Location:	Internal Storage

Note: This EUT has two SIM card slots, and use same one RF module. We found that RF parameters are the same, when we insert the card 1 and card 2. So we usually performed the test under main card slot 1.

5.2 Details of E.U.T.

Operation Frequency:	GSM/GPRS/EDGE 850: 824~849MHz
	PCS/GPRS/EDGE 1900: 1850~1910MHz
	WCDMA Band II: 1850~1910MHz
	WCDMA Band V: 824~849MHz
	WCDMA Band IV: 1710~1755MHz
	LTE Band 2: 1850~1910MHz
	LTE Band 4: 1710~1755MHz
	LTE Band 5: 842~849MHz
	LTE Band 7: 2500-2570MHz
	LTE Band 12: 699-716MHz
	LTE Band 17: 704-716MHz
	WiFi:
	802.11b/g/n HT20: 2412~2462MHz
	802.11n HT40: 2422~2452MHz
Bluetooth: 2402~2480MHz	

Max. RF output power:	GSM 850: 32.57dBm PCS1900: 29.98dBm WCDMA Band II: 22.52dBm WCDMA Band V: 22.36dBm WCDMA Band IV: 22.29dBm LTE Band 2: 22.98dBm LTE Band 4: 22.92dBm LTE Band 5: 22.99dBm LTE Band 7: 21.96dBm LTE Band 12: 22.97dBm LTE Band 17: 23.58dBm WiFi(2.4G): 9.38Bm Bluetooth: 0.91dBm
Type of Modulation:	GSM,GPRS: GMSK EDGE: GMSK, 8PSK WCDMA: BPSK, 16QAM LTE: QPSK, 16QAM WiFi: CCK, OFDM Bluetooth: GFSK, Pi/4 DQPSK, 8DPSK
Antenna installation:	GSM/WCDMA/LTE: internal permanent antenna WiFi/Bluetooth: internal permanent antenna
Antenna Gain:	GSM 850: -2.9dBi PCS1900: -1.7dBi WCDMA Band II: -1.7dBi WCDMA Band V: -2.9dBi WCDMA Band IV: -2.1dBi LTE Band 2: -1.7dBi LTE Band 4: -2.1dBi LTE Band 5: -2.9dBi LTE Band 7: 3.3dBi LTE Band 12: -2.8dBi LTE Band 17: -2.8dBi WiFi(2.4G):-0.6dBi Bluetooth:-0.6dBi
Ratings:	Battery DC 3.8V, 2500mAh DC 5V, 1.0A, charging from adapter (Adapter Input: 100-240V~50/60Hz 0.25A)
Adapter:	Manufacture: Shenzhen ACT Industrial Co.,Ltd. Model No.: APS-M006050100W-G
Type of Emission:	LTE Band 2 1.4MHz: 1M09G7D(QPSK), 1M09W7D(16QAM)

LTE Band 2 3MHz: 2M73G7D(QPSK), 2M73W7D(16QAM)
LTE Band 2 5MHz: 4M50G7D(QPSK), 4M50W7D(16QAM)
LTE Band 2 10 MHz: 8M92G7D(QPSK), 8M92W7D(16QAM)
LTE Band 2 15MHz: 13M45G7D(QPSK), 13M45W7D(16QAM)
LTE Band 2 20MHz: 17M89G7D(QPSK), 17M9W7D(16QAM)
LTE Band 4 1.4MHz: 1M09G7D(QPSK), 1M09W7D(16QAM)
LTE Band 4 3MHz: 2M73G7D(QPSK), 2M72W7D(16QAM)
LTE Band 4 5MHz: 4M50G7D(QPSK), 4M50W7D(16QAM)
LTE Band 4 10 MHz: 8M93G7D(QPSK), 8M92W7D(16QAM)
LTE Band 4 15MHz: 13M46G7D(QPSK), 13M46W7D(16QAM)
LTE Band 4 20MHz: 17M9G7D(QPSK), 17M9W7D(16QAM)
LTE Band 5 1.4MHz: 1M09G7D(QPSK), 1M09W7D(16QAM)
LTE Band 5 3MHz: 2M73G7D(QPSK), 2M72W7D(16QAM)
LTE Band 5 5MHz: 4M49G7D(QPSK), 4M49W7D(16QAM)
LTE Band 5 10 MHz: 8M93G7D(QPSK), 8M92W7D(16QAM)
LTE Band 7 5MHz: 4M50G7D(QPSK), 4M50W7D(16QAM)
LTE Band 7 10 MHz: 8M93G7D(QPSK), 8M92W7D(16QAM)
LTE Band 7 15MHz: 13M48G7D(QPSK), 13M47W7D(16QAM)
LTE Band 7 20MHz: 17M92G7D(QPSK), 17M92W7D(16QAM)
LTE Band 12 1.4MHz: 1M09G7D(QPSK), 1M08W7D(16QAM)
LTE Band 12 3MHz: 2M72G7D(QPSK), 2M72W7D(16QAM)
LTE Band 12 5MHz: 4M49G7D(QPSK), 4M49W7D(16QAM)
LTE Band 12 10MHz: 8M93G7D(QPSK), 8M92W7D(16QAM)
LTE Band 17 5MHz: 4M49G7D(QPSK), 4M49W7D(16QAM)
LTE Band 17 10 MHz: 8M93G7D(QPSK), 8M92W7D(16QAM)

5.3 Test Mode

All test mode(s) and condition(s) mentioned were considered and evaluated respectively by performing full tests, the worst data were recorded and reported.

Support Band	Test Mode BW(MHz)	Channel Frequency	Channel Number
LTE Band 2	1.4	1850.7 MHz	18607
		1880.0 MHz	18900
		1909.3 MHz	19193
	3	1851.5 MHz	18615
		1880.0 MHz	18900
		1908.5 MHz	19185
	5	1852.5 MHz	18625
		1880.0 MHz	18900
		1907.5 MHz	19175
	10	1855.0 MHz	18650
		1880.0 MHz	18900
		1905.0 MHz	19150
	15	1857.5 MHz	18675
		1880.0 MHz	18900
		1902.5 MHz	19125
20	1860.0 MHz	18700	
	1880.0 MHz	18900	
	1900.0 MHz	19100	
LTE Band 4	1.4	1710.7 MHz	19957
		1732.5 MHz	20175
		1754.3 MHz	20393
	3	1711.5 MHz	19965
		1732.5 MHz	20175
		1753.5 MHz	20385
	5	1712.5 MHz	19975
		1732.5 MHz	20175
		1752.5 MHz	20375
	10	1715.0 MHz	20000
		1732.5 MHz	20175
		1750.0 MHz	20350
	15	1717.5 MHz	20025
		1732.5 MHz	20175
		1747.5 MHz	20325
20	1720.0 MHz	20050	
	1732.5 MHz	20175	
	1745.0 MHz	20300	
LTE Band 5	1.4	824.7 MHz	20407
		836.5 MHz	20525
		848.3 MHz	20643

	3	825.5 MHz	20415
		836.5 MHz	20525
		847.5 MHz	20635
	5	826.5 MHz	20425
		836.5 MHz	20525
		846.5 MHz	20625
	10	829.0 MHz	20450
		836.5 MHz	20525
		844.0 MHz	20600
LTE Band 7	5	2502.5 MHz	20775
		2535 MHz	21100
		2567.5 MHz	21425
	10	2505.0 MHz	20800
		2535 MHz	21100
		2565.0 MHz	21400
	15	2507.5 MHz	20825
		2535 MHz	21100
		2562.5 MHz	21375
20	2510.0 MHz	20850	
	2535 MHz	21100	
	2560.0 MHz	21350	
LTE Band 12	1.4	699.7 MHz	23017
		707.5 MHz	23095
		715.3 MHz	23173
	3	700.5 MHz	23025
		707.5 MHz	23095
		714.5 MHz	23165
	5	701.5 MHz	23035
		707.5 MHz	23095
		713.5 MHz	23155
10	704.0 MHz	23060	
	707.5 MHz	23095	
	711 MHz	23130	
LTE Band 17	5	706.5 MHz	23755
		710.0 MHz	23790
		713.5 MHz	23825
	10	709.0 MHz	23780
		710.0 MHz	23790
		711.0 MHz	23800

6 Test Summary

Test Items	Test Requirement	Result
RF Output Power	2.1046 22.913 (a) 24.232 (c) 27.50(h.2) 27.50(d.4)	PASS
Peak-to-Average Ratio	24.232 (d) 27.50(d)	PASS
Bandwidth	2.1049 22.905 22.917 24.238 27.53(a)	PASS
Spurious Emissions at Antenna Terminal	2.1051 22.917 (a) 24.238 (a) 27.53(h) 27.53(m)(4)	PASS
Field Strength of Spurious Radiation	2.1053 22.917 (a) 24.238 (a) 27.53(h) 27.53(m)(4)	PASS
Out of band emission	22.917 (a) 24.238 (a) 27.53(h) 27.53(m)(4)	PASS
Frequency Stability	2.1055 22.355 24.235 27.5(h) 27.54	PASS
Maximum Permissible Exposure (SAR)	1.1307 2.1093	PASS

7 Equipment Used during Test

7.1 Equipments List

Conducted Emissions Test Site 1#						
Item	Equipment	Manufacturer	Model No.	Serial No.	Last Calibration Date	Calibration Due Date
1.	EMI Test Receiver	R&S	ESCI	100947	2017-09-12	2018-09-11
2.	LISN	R&S	ENV216	101215	2017-09-12	2018-09-11
3.	Cable	Top	TYPE16(3.5M)	-	2017-09-12	2018-09-11
Conducted Emissions Test Site 2#						
Item	Equipment	Manufacturer	Model No.	Serial No.	Last Calibration Date	Calibration Due Date
1.	EMI Test Receiver	R&S	ESCI	101155	2017-09-12	2018-09-11
2.	LISN	SCHWARZBECK	NSLK 8128	8128-289	2017-09-12	2018-09-11
3.	Limiter	York	MTS-IMP-136	261115-001-0024	2017-09-12	2018-09-11
4.	Cable	LARGE	RF300	-	2017-09-12	2018-09-11
3m Semi-anechoic Chamber for Radiation Emissions Test site 1#						
Item	Equipment	Manufacturer	Model No.	Serial No.	Last Calibration Date	Calibration Due Date
1	Spectrum Analyzer	R&S	FSP	100091	2017-04-29	2018-04-28
2	Active Loop Antenna	Beijing Dazhi	ZN30900A	-	2017-04-09	2018-04-08
3	Trilog Broadband Antenna	SCHWARZBECK	VULB9163	336	2017-04-09	2018-04-08
4	Coaxial Cable (below 1GHz)	Top	TYPE16(13M)	-	2017-09-12	2018-09-11
5	Broad-band Horn Antenna	SCHWARZBECK	BBHA 9120 D	667	2017-04-09	2018-04-08
6	Broad-band Horn Antenna	SCHWARZBECK	BBHA 9170	335	2017-04-09	2018-04-08
7	Broadband Preamplifier	COMPLIANCE DIRECTION	PAP-1G18	2004	2017-04-13	2018-04-12
8	Coaxial Cable (above 1GHz)	Top	1GHz-25GHz	EW02014-7	2017-04-13	2018-04-12
9	Signal Generator	R&S	SMR20	100046	2017-09-12	2018-09-11
10	Smart Antenna	SCHWARZBECK	HA08	-	2017-04-09	2018-04-08
3m Semi-anechoic Chamber for Radiation Emissions Test site 2#						
Item	Equipment	Manufacturer	Model No.	Serial No	Last Calibration Date	Calibration Due Date
1	Test Receiver	R&S	ESCI	101296	2017-04-13	2018-04-12
2	Trilog Broadband Antenna	SCHWARZBECK	VULB9160	9160-3325	2017-04-09	2018-04-08

3	Amplifier	Compliance pirection systems inc	PAP-0203	22024	2017-04-13	2018-04-12
4	Cable	HUBER+SUHNER	CBL2	525178	2017-04-13	2018-04-12
RF Conducted Testing						
Item	Equipment	Manufacturer	Model No.	Serial No.	Last Calibration Date	Calibration Due Date
1.	EMC Analyzer (9k~26.5GHz)	Agilent	E7405A	MY45114943	2017-09-12	2018-09-11
2.	Spectrum Analyzer	Agilent	N9020A	MY49100060	2017-09-12	2018-09-11
3.	Universal Radio Communication Tester	R&S	CMW 500	127818	2017-04-13	2018-04-12
4	Signal Analyzer (9k~26.5GHz)	Agilent	N9010A	MY50520207	2017-09-12	2018-09-11

7.2 Measurement Uncertainty

Parameter	Uncertainty
Conducted Emission	± 3.64 dB(AC mains 150KHz~30MHz)
Radiated Spurious Emissions	± 5.08 dB (Bilog antenna 30M~1000MHz)
	± 5.47 dB (Horn antenna 1000M~25000MHz)
Radio Frequency	± 1 x 10 ⁻⁷ Hz
RF Power	± 0.42 dB
RF Power Density	± 0.7dB
Conducted Spurious Emissions	± 2.76 dB (9kHz~26500MHz)
Confidence interval: 95%. Confidence factor:k=2	

7.3 Test Equipment Calibration

All the test equipments used are valid and calibrated by CEPREI Certification Body that address is No.110 Dongguan Zhuang RD. Guangzhou, P.R.China.

8 RF OUTPUT POWER

Test Requirement:	FCC Part 2.1046, 22.913 (a), 24.232 (c), 27.50(h.2); 27.50(d.4)
Test Method:	TIA/EIA-603-D:2010 KDB971168 D01 v02r02
Test Mode:	TX transmitting

8.1 EUT Operation

Operating Environment :

Temperature:	22.5 °C
Humidity:	52.1 % RH
Atmospheric Pressure:	101.2kPa

8.2 Test Procedure

Conducted method:

The RF output of the transmitter was connected to the wireless test set and the spectrum analyzer through sufficient attenuation.

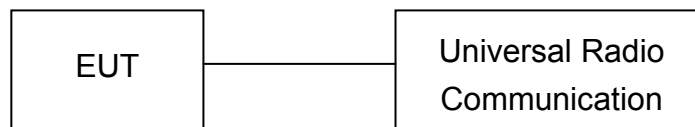

Radiated method:

1. The setup of EUT is according with per TIA/EIA Standard 603D:2010.
2. The measurement antenna was placed at a distance of 3 meters from the EUT. During the tests, the antenna height and polarization as well as EUT azimuth were varied in order to identify the maximum level of emissions from the EUT. The test was performed by placing the EUT on 3-orthogonal axis.
3. The frequency range up to tenth harmonic of the fundamental frequency was investigated.
4. Remove the EUT and replace it with substitution antenna. A signal generator was connected to the substitution antenna by a non-radiating cable. The absolute levels of the spurious emissions were measured by the substitution.

8.3 Test Result

Conducted Power

LTE Band 2:

BW(MHz)	Ch	Freq(MHz)	Mode	UL RB Allocation	UL RB Offset	Average Power (dbm)	Tune up limited(dBm)	MPR (dB)
1.4MHz	18607	1850.7	QPSK	1	0	22.52	22.0±1	/
				1	2	22.57	22.0±1	/
				1	5	22.53	22.0±1	/
				3	0	22.54	22.0±1	/
				3	1	22.53	22.0±1	/
				3	2	22.53	22.0±1	/
			16QAM	6	0	21.55	21.0±1	1.0
				1	0	21.6	21.0±1	1.0
				1	2	21.65	21.0±1	1.0
				1	5	21.58	21.0±1	1.0
				3	0	21.52	21.0±1	1.0
				3	1	21.51	21.0±1	1.0
	18900	1880	QPSK	3	2	21.55	21.0±1	1.0
				6	0	20.61	21.0±1	1.0
				1	0	22.65	22.0±1	/
				1	2	22.72	22.0±1	/
				1	5	22.7	22.0±1	/
				3	0	22.66	22.0±1	/
			16QAM	3	1	22.68	22.0±1	/
				3	2	22.72	22.0±1	/
				6	0	21.65	21.0±1	1.0
				1	0	21	21.0±1	1.0
				1	2	21.06	21.0±1	1.0
				1	5	21	21.0±1	1.0
	19193	1909.3	QPSK	3	0	21.9	21.0±1	1.0
				3	1	21.81	21.0±1	1.0
				3	2	21.87	21.0±1	1.0
				6	0	20.57	21.0±1	1.0
				1	0	22.72	22.0±1	/
				1	2	22.82	22.0±1	/
16QAM			1	5	22.75	22.0±1	/	
			3	0	22.71	22.0±1	/	
			3	1	22.7	22.0±1	/	
			3	2	22.69	22.0±1	/	
			6	0	21.56	21.0±1	1.0	
			1	0	21.52	21.0±1	1.0	
16QAM	1	2	21.55	21.0±1	1.0			
	1	5	21.51	21.0±1	1.0			
	3	0	21.7	21.0±1	1.0			
	3	1	21.71	21.0±1	1.0			
	3	2	21.73	21.0±1	1.0			
	6	0	20.66	21.0±1	1.0			

BW(MHz)	Ch	Freq(MHz)	Mode	UL RB Allocation	UL RB Offset	Average Power (dbm)	Tune up limited(dBm)	MPR (dB)
3MHz	18615	1851.5	QPSK	1	0	22.45	22.0±1	/
				1	8	22.46	22.0±1	/
				1	14	22.44	22.0±1	/
				6	0	21.61	21.0±1	1.0
				6	4	21.62	21.0±1	1.0
				6	9	21.63	21.0±1	1.0
				15	0	21.58	21.0±1	1.0
			16QAM	1	0	21.41	21.0±1	1.0
				1	8	21.42	21.0±1	1.0
				1	14	21.39	21.0±1	1.0
				6	0	20.72	21.0±1	1.0
				6	4	20.74	21.0±1	1.0
				6	9	20.73	21.0±1	1.0
				15	0	20.62	21.0±1	1.0
				18900	1880	QPSK	1	0
	1	8	22.73				22.0±1	/
	1	14	22.7				22.0±1	/
	6	0	21.76				21.0±1	1.0
	6	4	21.77				21.0±1	1.0
	6	9	21.77				21.0±1	1.0
	15	0	21.71				21.0±1	1.0
	16QAM	1	0			21.02	21.0±1	1.0
		1	8			21.05	21.0±1	1.0
		1	14			21	21.0±1	1.0
		6	0			20.82	21.0±1	1.0
		6	4			20.84	21.0±1	1.0
		6	9			20.82	21.0±1	1.0
		15	0			20.74	21.0±1	1.0
		19185	1908.5			QPSK	1	0
	1			8	22.76		22.0±1	/
1	14			22.74	22.0±1		/	
6	0			21.76	21.0±1		1.0	
6	4			21.79	21.0±1		1.0	
6	9			21.75	21.0±1		1.0	
15	0			21.71	21.0±1		1.0	
16QAM	1			0	21.62	21.0±1	1.0	
	1			8	21.6	21.0±1	1.0	
	1			14	21.55	21.0±1	1.0	
	6			0	20.77	21.0±1	1.0	
	6			4	20.77	21.0±1	1.0	
	6			9	20.76	21.0±1	1.0	
	15			0	20.66	21.0±1	1.0	

BW(MHz)	Ch	Freq(MHz)	Mode	UL RB Allocation	UL RB Offset	Average Power (dbm)	Tune up limited(dBm)	MPR (dB)
5MHz	18625	1852.5	QPSK	1	0	22.71	22.0±1	/
				1	12	22.68	22.0±1	/
				1	24	22.64	22.0±1	/
				12	0	21.7	21.0±1	1.0
				12	6	21.68	21.0±1	1.0
				12	11	21.69	21.0±1	1.0
				25	0	21.64	21.0±1	1.0
			16QAM	1	0	21.81	21.0±1	1.0
				1	12	21.79	21.0±1	1.0
				1	24	21.79	21.0±1	1.0
				12	0	20.75	21.0±1	1.0
				12	6	20.76	21.0±1	1.0
				12	11	20.76	21.0±1	1.0
				25	0	20.66	21.0±1	1.0
	18900	1880	QPSK	1	0	22.81	22.0±1	/
				1	12	22.81	22.0±1	/
				1	24	22.77	22.0±1	/
				12	0	21.79	21.0±1	1.0
				12	6	21.77	21.0±1	1.0
				12	11	21.8	21.0±1	1.0
				25	0	21.75	21.0±1	1.0
			16QAM	1	0	21.28	21.0±1	1.0
				1	12	21.26	21.0±1	1.0
				1	24	21.23	21.0±1	1.0
				12	0	20.92	21.0±1	1.0
				12	6	20.91	21.0±1	1.0
				12	11	20.93	21.0±1	1.0
25				0	20.8	21.0±1	1.0	
19175	1907.5	QPSK	1	0	22.78	22.0±1	/	
			1	12	22.75	22.0±1	/	
			1	24	22.69	22.0±1	/	
			12	0	21.76	21.0±1	1.0	
			12	6	21.74	21.0±1	1.0	
			12	11	21.71	21.0±1	1.0	
			25	0	21.69	21.0±1	1.0	
		16QAM	1	0	21.81	21.0±1	1.0	
			1	12	21.74	21.0±1	1.0	
			1	24	21.71	21.0±1	1.0	
			12	0	20.81	21.0±1	1.0	
			12	6	20.79	21.0±1	1.0	
			12	11	20.78	21.0±1	1.0	
			25	0	20.65	21.0±1	1.0	

BW(MHz)	Ch	Freq(MHz)	Mode	UL RB Allocation	UL RB Offset	Average Power (dbm)	Tune up limited(dBm)	MPR (dB)
10MHz	18650	1855	QPSK	1	0	22.7	22.0±1	/
				1	24	22.74	22.0±1	/
				1	49	22.58	22.0±1	/
				25	0	21.68	21.0±1	1.0
				25	12	21.66	21.0±1	1.0
				25	24	21.68	21.0±1	1.0
				50	0	21.69	21.0±1	1.0
			16QAM	1	0	21.58	21.0±1	1.0
				1	24	21.6	21.0±1	1.0
				1	49	21.55	21.0±1	1.0
				25	0	20.69	21.0±1	1.0
				25	12	20.68	21.0±1	1.0
				25	24	20.69	21.0±1	1.0
				50	0	20.66	21.0±1	1.0
	18900	1880	QPSK	1	0	22.83	22.0±1	/
				1	24	22.82	22.0±1	/
				1	49	22.74	22.0±1	/
				25	0	21.77	21.0±1	1.0
				25	12	21.75	21.0±1	1.0
				25	24	21.79	21.0±1	1.0
				50	0	21.78	21.0±1	1.0
			16QAM	1	0	21.12	21.0±1	1.0
				1	24	21.14	21.0±1	1.0
				1	49	21.07	21.0±1	1.0
				25	0	20.82	21.0±1	1.0
				25	12	20.79	21.0±1	1.0
				25	24	20.81	21.0±1	1.0
				50	0	20.79	21.0±1	1.0
	19150	1905	QPSK	1	0	22.81	22.0±1	/
				1	24	22.84	22.0±1	/
1				49	22.27	22.0±1	/	
25				0	21.73	21.0±1	1.0	
25				12	21.72	21.0±1	1.0	
25				24	21.73	21.0±1	1.0	
50				0	21.72	21.0±1	1.0	
16QAM			1	0	21.73	21.0±1	1.0	
			1	24	21.71	21.0±1	1.0	
			1	49	21.27	21.0±1	1.0	
			25	0	20.83	21.0±1	1.0	
			25	12	20.8	21.0±1	1.0	
			25	24	20.81	21.0±1	1.0	
			50	0	20.76	21.0±1	1.0	

BW(MHz)	Ch	Freq(MHz)	Mode	UL RB Allocation	UL RB Offset	Average Power (dbm)	Tune up limited(dBm)	MPR (dB)
15MHz	18675	1857.5	QPSK	1	0	22.73	22.0±1	/
				1	37	22.69	22.0±1	/
				1	74	22.72	22.0±1	/
				36	0	21.74	21.0±1	1.0
				36	16	21.75	21.0±1	1.0
				36	35	21.76	21.0±1	1.0
				75	0	21.76	21.0±1	1.0
			16QAM	1	0	21.59	21.0±1	1.0
				1	37	21.57	21.0±1	1.0
				1	74	21.63	21.0±1	1.0
				36	0	20.73	21.0±1	1.0
				36	16	20.72	21.0±1	1.0
				36	35	20.75	21.0±1	1.0
				75	0	20.73	21.0±1	1.0
	18900	1880	QPSK	1	0	22.83	22.0±1	/
				1	37	22.8	22.0±1	/
				1	74	22.82	22.0±1	/
				36	0	21.85	21.0±1	1.0
				36	16	21.82	21.0±1	1.0
				36	35	21.85	21.0±1	1.0
				75	0	21.84	21.0±1	1.0
			16QAM	1	0	21.17	21.0±1	1.0
				1	37	21.12	21.0±1	1.0
				1	74	21.13	21.0±1	1.0
				36	0	20.86	21.0±1	1.0
				36	16	20.86	21.0±1	1.0
				36	35	20.87	21.0±1	1.0
				75	0	20.85	21.0±1	1.0
	19125	1902.5	QPSK	1	0	22.79	22.0±1	/
				1	37	22.76	22.0±1	/
1				74	22.33	22.0±1	/	
36				0	21.78	21.0±1	1.0	
36				16	21.81	21.0±1	1.0	
36				35	21.8	21.0±1	1.0	
75				0	21.81	21.0±1	1.0	
16QAM			1	0	21.08	21.0±1	1.0	
			1	37	21	21.0±1	1.0	
			1	74	21.66	21.0±1	1.0	
			36	0	20.75	21.0±1	1.0	
			36	16	20.78	21.0±1	1.0	
			36	35	20.74	21.0±1	1.0	
			75	0	20.77	21.0±1	1.0	

BW(MHz)	Ch	Freq(MHz)	Mode	UL RB Allocation	UL RB Offset	Average Power (dbm)	Tune up limited(dBm)	MPR (dB)
20MHz	18700	1860	QPSK	1	0	22.79	22.0±1	/
				1	49	22.77	22.0±1	/
				1	99	22.62	22.0±1	/
				50	0	21.72	21.0±1	1.0
				50	24	21.7	21.0±1	1.0
				50	49	21.77	21.0±1	1.0
				100	0	21.74	21.0±1	1.0
			16QAM	1	0	21.24	21.0±1	1.0
				1	49	21.26	21.0±1	1.0
				1	99	21.15	21.0±1	1.0
				50	0	20.75	21.0±1	1.0
				50	24	20.77	21.0±1	1.0
				50	49	20.79	21.0±1	1.0
				100	0	20.77	21.0±1	1.0
	18900	1880	QPSK	1	0	22.93	22.0±1	/
				1	49	22.98	22.0±1	/
				1	99	22.87	22.0±1	/
				50	0	21.81	21.0±1	1.0
				50	24	21.96	21.0±1	1.0
				50	49	21.8	21.0±1	1.0
				100	0	21.81	21.0±1	1.0
			16QAM	1	0	22.26	21.0±1	1.0
				1	49	22.21	21.0±1	1.0
				1	99	22.19	21.0±1	1.0
				50	0	20.82	21.0±1	1.0
				50	24	20.78	21.0±1	1.0
				50	49	20.82	21.0±1	1.0
				100	0	20.81	21.0±1	1.0
	19100	1900	QPSK	1	0	22.78	22.0±1	/
				1	49	22.76	22.0±1	/
1				99	22.23	22.0±1	/	
50				0	21.78	21.0±1	1.0	
50				24	21.75	21.0±1	1.0	
50				49	21.75	21.0±1	1.0	
100				0	21.77	21.0±1	1.0	
16QAM			1	0	21.12	21.0±1	1.0	
			1	49	21.09	21.0±1	1.0	
			1	99	21.62	21.0±1	1.0	
			50	0	20.77	21.0±1	1.0	
			50	24	20.74	21.0±1	1.0	
			50	49	20.75	21.0±1	1.0	
			100	0	20.79	21.0±1	1.0	

LTE Band 4:

BW(MHz)	Ch	Freq(MHz)	Mode	UL RB Allocation	UL RB Offset	Average Power (dbm)	Tune up limited(dBm)	MPR (dB)
1.4MHz	19957	1710.7	QPSK	1	0	22.68	22.0±1	/
				1	2	22.7	22.0±1	/
				1	5	22.68	22.0±1	/
				3	0	22.74	22.0±1	/
				3	1	22.74	22.0±1	/
				3	2	22.75	22.0±1	/
			16QAM	6	0	21.71	21.0±1	1.0
				1	0	21.79	21.0±1	1.0
				1	2	21.86	21.0±1	1.0
				1	5	21.81	21.0±1	1.0
				3	0	21.76	21.0±1	1.0
				3	1	21.76	21.0±1	1.0
	20175	1732.5	QPSK	3	2	21.79	21.0±1	1.0
				6	0	20.85	21.0±1	1.0
				1	0	22.72	22.0±1	/
				1	2	22.76	22.0±1	/
				1	5	22.73	22.0±1	/
				3	0	22.76	22.0±1	/
			16QAM	3	1	22.78	22.0±1	/
				3	2	22.78	22.0±1	/
				6	0	21.76	21.0±1	1.0
				1	0	21.07	21.0±1	1.0
				1	2	21.06	21.0±1	1.0
				1	5	21.04	21.0±1	1.0
	20393	1754.3	QPSK	3	0	21.93	21.0±1	1.0
				3	1	21.87	21.0±1	1.0
				3	2	21.89	21.0±1	1.0
				6	0	20.62	21.0±1	1.0
				1	0	22.61	22.0±1	/
				1	2	22.7	22.0±1	/
16QAM			1	5	22.61	22.0±1	/	
			3	0	22.71	22.0±1	/	
			3	1	22.67	22.0±1	/	
			3	2	22.7	22.0±1	/	
			6	0	21.63	21.0±1	1.0	
			1	0	21.62	21.0±1	1.0	
16QAM	1	2	21.66	21.0±1	1.0			
	1	5	21.64	21.0±1	1.0			
	3	0	21.83	21.0±1	1.0			
	3	1	21.82	21.0±1	1.0			
	3	2	21.82	21.0±1	1.0			
	6	0	20.78	21.0±1	1.0			

BW(MHz)	Ch	Freq(MHz)	Mode	UL RB Allocation	UL RB Offset	Average Power (dbm)	Tune up limited(dBm)	MPR (dB)
3MHz	19965	1711.5	QPSK	1	0	22.66	22.0±1	/
				1	8	22.66	22.0±1	/
				1	14	22.66	22.0±1	/
				6	0	21.73	21.0±1	1.0
				6	4	21.78	21.0±1	1.0
				6	9	21.77	21.0±1	1.0
				15	0	21.73	21.0±1	1.0
			16QAM	1	0	21.57	21.0±1	1.0
				1	8	21.6	21.0±1	1.0
				1	14	21.58	21.0±1	1.0
				8	0	20.85	21.0±1	1.0
				8	4	20.87	21.0±1	1.0
				8	9	20.85	21.0±1	1.0
				15	0	20.76	21.0±1	1.0
	20175	1732.5	QPSK	1	0	22.7	22.0±1	/
				1	8	22.71	22.0±1	/
				1	14	22.68	22.0±1	/
				6	0	21.78	21.0±1	1.0
				6	4	21.81	21.0±1	1.0
				6	9	21.78	21.0±1	1.0
				15	0	21.73	21.0±1	1.0
			16QAM	1	0	21.04	21.0±1	1.0
				1	8	21.02	21.0±1	1.0
				1	14	21.01	21.0±1	1.0
				6	0	20.82	21.0±1	1.0
				6	4	20.83	21.0±1	1.0
				6	9	20.8	21.0±1	1.0
				15	0	20.72	21.0±1	1.0
	20385	1753.5	QPSK	1	0	22.64	22.0±1	/
				1	8	22.63	22.0±1	/
1				14	22.62	22.0±1	/	
6				0	21.69	21.0±1	1.0	
6				4	21.72	21.0±1	1.0	
6				9	21.68	21.0±1	1.0	
15				0	21.66	21.0±1	1.0	
16QAM			1	0	21.65	21.0±1	1.0	
			1	8	21.62	21.0±1	1.0	
			1	14	21.58	21.0±1	1.0	
			8	0	20.71	21.0±1	1.0	
			8	4	20.72	21.0±1	1.0	
			8	9	20.69	21.0±1	1.0	
			15	0	20.6	21.0±1	1.0	

BW(MHz)	Ch	Freq(MHz)	Mode	UL RB Allocation	UL RB Offset	Average Power (dbm)	Tune up limited(dBm)	MPR (dB)
5MHz	19975	1712.5	QPSK	1	0	22.71	22.0±1	/
				1	49	22.75	22.0±1	/
				1	99	22.7	22.0±1	/
				12	0	21.78	21.0±1	1.0
				12	24	21.79	21.0±1	1.0
				12	49	21.8	21.0±1	1.0
				25	0	21.74	21.0±1	1.0
			16QAM	1	0	21.9	21.0±1	1.0
				1	49	21.91	21.0±1	1.0
				1	99	21.89	21.0±1	1.0
				12	0	20.85	21.0±1	1.0
				12	24	20.87	21.0±1	1.0
				12	49	20.86	21.0±1	1.0
				25	0	20.76	21.0±1	1.0
	20175	1732.5	QPSK	1	0	22.76	22.0±1	/
				1	49	22.78	22.0±1	/
				1	99	22.72	22.0±1	/
				12	0	21.78	21.0±1	1.0
				12	24	21.75	21.0±1	1.0
				12	49	21.72	21.0±1	1.0
				25	0	21.74	21.0±1	1.0
			16QAM	1	0	21.26	21.0±1	1.0
				1	49	21.23	21.0±1	1.0
				1	99	21.16	21.0±1	1.0
				12	0	20.89	21.0±1	1.0
				12	24	20.87	21.0±1	1.0
				12	49	20.84	21.0±1	1.0
25				0	20.77	21.0±1	1.0	
20375	1752.5	QPSK	1	0	22.68	22.0±1	/	
			1	49	22.67	22.0±1	/	
			1	99	22.6	22.0±1	/	
			12	0	21.7	21.0±1	1.0	
			12	24	21.69	21.0±1	1.0	
			12	49	21.69	21.0±1	1.0	
			25	0	21.66	21.0±1	1.0	
		16QAM	1	0	21.76	21.0±1	1.0	
			1	49	21.76	21.0±1	1.0	
			1	99	21.7	21.0±1	1.0	
			12	0	20.75	21.0±1	1.0	
			12	24	20.74	21.0±1	1.0	
			12	49	20.72	21.0±1	1.0	
			25	0	20.6	21.0±1	1.0	

BW(MHz)	Ch	Freq(MHz)	Mode	UL RB Allocation	UL RB Offset	Average Power (dbm)	Tune up limited(dBm)	MPR (dB)
10MHz	20000	1715	QPSK	1	0	22.7	22.0±1	/
				1	49	22.76	22.0±1	/
				1	99	22.75	22.0±1	/
				25	0	21.77	21.0±1	1.0
				25	24	21.77	21.0±1	1.0
				25	49	21.77	21.0±1	1.0
				50	0	21.78	21.0±1	1.0
			16QAM	1	0	21.53	21.0±1	1.0
				1	49	21.69	21.0±1	1.0
				1	99	21.68	21.0±1	1.0
				25	0	20.77	21.0±1	1.0
				25	24	20.79	21.0±1	1.0
				25	49	20.81	21.0±1	1.0
				50	0	20.77	21.0±1	1.0
	20175	1732.5	QPSK	1	0	22.77	22.0±1	/
				1	49	22.75	22.0±1	/
				1	99	22.74	22.0±1	/
				25	0	21.74	21.0±1	1.0
				25	24	21.73	21.0±1	1.0
				25	49	21.73	21.0±1	1.0
				50	0	21.76	21.0±1	1.0
			16QAM	1	0	21.1	21.0±1	1.0
				1	49	21.06	21.0±1	1.0
				1	99	21.03	21.0±1	1.0
				25	0	20.75	21.0±1	1.0
				25	24	20.75	21.0±1	1.0
				25	49	20.72	21.0±1	1.0
				50	0	20.75	21.0±1	1.0
	20350	1750	QPSK	1	0	22.58	22.0±1	/
				1	49	22.67	22.0±1	/
1				99	22.68	22.0±1	/	
25				0	21.67	21.0±1	1.0	
25				24	21.64	21.0±1	1.0	
25				49	21.67	21.0±1	1.0	
50				0	21.65	21.0±1	1.0	
16QAM			1	0	21.46	21.0±1	1.0	
			1	49	21.67	21.0±1	1.0	
			1	99	21.64	21.0±1	1.0	
			25	0	20.72	21.0±1	1.0	
			25	24	20.73	21.0±1	1.0	
			25	49	20.74	21.0±1	1.0	
			50	0	20.66	21.0±1	1.0	

BW(MHz)	Ch	Freq(MHz)	Mode	UL RB Allocation	UL RB Offset	Average Power (dbm)	Tune up limited(dBm)	MPR (dB)
15MHz	20025	1717.5	QPSK	1	0	22.74	22.0±1	/
				1	49	22.74	22.0±1	/
				1	99	22.77	22.0±1	/
				36	0	21.8	21.0±1	1.0
				36	24	21.8	21.0±1	1.0
				36	49	21.81	21.0±1	1.0
				75	0	21.81	21.0±1	1.0
			16QAM	1	0	21.63	21.0±1	1.0
				1	49	21.67	21.0±1	1.0
				1	99	21.68	21.0±1	1.0
				36	0	20.78	21.0±1	1.0
				36	24	20.79	21.0±1	1.0
				36	49	20.81	21.0±1	1.0
				75	0	20.81	21.0±1	1.0
	20175	1732.5	QPSK	1	0	22.77	22.0±1	/
				1	49	22.74	22.0±1	/
				1	99	22.73	22.0±1	/
				36	0	21.8	21.0±1	1.0
				36	24	21.81	21.0±1	1.0
				36	49	21.81	21.0±1	1.0
				75	0	21.82	21.0±1	1.0
			16QAM	1	0	21.13	21.0±1	1.0
				1	49	21.03	21.0±1	1.0
				1	99	21.02	21.0±1	1.0
				36	0	20.82	21.0±1	1.0
				36	24	20.8	21.0±1	1.0
				36	49	20.8	21.0±1	1.0
75				0	20.77	21.0±1	1.0	
20325	1747.5	QPSK	1	0	22.75	22.0±1	/	
			1	49	22.71	22.0±1	/	
			1	99	22.7	22.0±1	/	
			36	0	21.74	21.0±1	1.0	
			36	24	21.75	21.0±1	1.0	
			36	49	21.74	21.0±1	1.0	
			75	0	21.76	21.0±1	1.0	
		16QAM	1	0	21	21.0±1	1.0	
			1	49	21.02	21.0±1	1.0	
			1	99	21.01	21.0±1	1.0	
			36	0	20.68	21.0±1	1.0	
			36	24	20.68	21.0±1	1.0	
			36	49	20.68	21.0±1	1.0	
			75	0	20.7	21.0±1	1.0	

BW(MHz)	Ch	Freq(MHz)	Mode	UL RB Allocation	UL RB Offset	Average Power (dbm)	Tune up limited(dBm)	MPR (dB)
20MHz	20050	1720	QPSK	1	0	22.8	22.0±1	/
				1	49	22.79	22.0±1	/
				1	99	22.81	22.0±1	/
				50	0	21.79	21.0±1	1.0
				50	24	21.75	21.0±1	1.0
				50	49	21.8	21.0±1	1.0
				100	0	21.77	21.0±1	1.0
			16QAM	1	0	21.28	21.0±1	1.0
				1	49	21.29	21.0±1	1.0
				1	99	21.28	21.0±1	1.0
				50	0	20.83	21.0±1	1.0
				50	24	20.8	21.0±1	1.0
				50	49	20.83	21.0±1	1.0
				100	0	20.81	21.0±1	1.0
	20175	1732.5	QPSK	1	0	22.83	22.0±1	/
				1	49	22.92	22.0±1	/
				1	99	22.45	22.0±1	/
				50	0	21.77	21.0±1	1.0
				50	24	21.93	21.0±1	1.0
				50	49	21.76	21.0±1	1.0
				100	0	21.74	21.0±1	1.0
			16QAM	1	0	21.2	21.0±1	1.0
				1	49	21.11	21.0±1	1.0
				1	99	21.86	21.0±1	1.0
				50	0	20.77	21.0±1	1.0
				50	24	20.73	21.0±1	1.0
				50	49	20.72	21.0±1	1.0
				100	0	20.72	21.0±1	1.0
	20300	1745	QPSK	1	0	22.74	22.0±1	/
				1	49	22.49	22.0±1	/
1				99	22.69	22.0±1	/	
50				0	21.7	21.0±1	1.0	
50				24	21.68	21.0±1	1.0	
50				49	21.7	21.0±1	1.0	
100				0	21.69	21.0±1	1.0	
16QAM			1	0	21.04	21.0±1	1.0	
			1	49	21.93	21.0±1	1.0	
			1	99	21.02	21.0±1	1.0	
			50	0	20.64	21.0±1	1.0	
			50	24	20.62	21.0±1	1.0	
			50	49	20.64	21.0±1	1.0	
			100	0	20.68	21.0±1	1.0	

LTE Band 5:

BW(MHz)	Ch	Freq(MHz)	Mode	UL RB Allocation	UL RB Offset	Average Power (dbm)	Tune up limited(dBm)	MPR (dB)
1.4MHz	20407	824.7	QPSK	1	0	22	22.0±1	/
				1	2	22.89	22.0±1	/
				1	5	22.86	22.0±1	/
				3	0	22.88	22.0±1	/
				3	1	22.95	22.0±1	/
				3	2	22.77	22.0±1	/
			16QAM	6	0	21.98	21.0±1	1.0
				1	0	21.56	21.0±1	1.0
				1	2	21.59	21.0±1	1.0
				1	5	21.56	21.0±1	1.0
				3	0	21.61	21.0±1	1.0
				3	1	21.69	21.0±1	1.0
	20525	836.5	QPSK	3	2	21.12	21.0±1	1.0
				6	0	21.16	21.0±1	1.0
				1	0	22.93	22.0±1	/
				1	2	22.95	22.0±1	/
				1	5	22.9	22.0±1	/
				3	0	22.96	22.0±1	/
			16QAM	3	1	22.97	22.0±1	/
				3	2	22.97	22.0±1	/
				6	0	21.91	21.0±1	1.0
				1	0	21.2	21.0±1	1.0
				1	2	21.21	21.0±1	1.0
				1	5	21.18	21.0±1	1.0
	20634	848.3	QPSK	3	0	21.12	21.0±1	1.0
				3	1	21.07	21.0±1	1.0
				3	2	21.08	21.0±1	1.0
				6	0	20.83	21.0±1	1.0
				1	0	22.82	22.0±1	/
				1	2	22.15	22.0±1	/
16QAM			1	5	22.87	22.0±1	/	
			3	0	22.94	22.0±1	/	
			3	1	22.95	22.0±1	/	
			3	2	22.95	22.0±1	/	
			6	0	21.98	21.0±1	1.0	
			1	0	21.79	21.0±1	1.0	
16QAM	1	2	21.82	21.0±1	1.0			
	1	5	21.8	21.0±1	1.0			
	3	0	21.96	21.0±1	1.0			
	3	1	21.96	21.0±1	1.0			
	3	2	21.95	21.0±1	1.0			
	6	0	21.05	21.0±1	1.0			

BW(MHz)	Ch	Freq(MHz)	Mode	UL RB Allocation	UL RB Offset	Average Power (dbm)	Tune up limited(dBm)	MPR (dB)
3MHz	20415	825.5	QPSK	1	0	22.91	22.0±1	/
				1	8	22.95	22.0±1	/
				1	14	22.89	22.0±1	/
				6	0	21.07	21.0±1	1.0
				6	4	21.07	21.0±1	1.0
				6	9	21.02	21.0±1	1.0
				15	0	21.04	21.0±1	1.0
			16QAM	1	0	21.86	21.0±1	1.0
				1	8	21.89	21.0±1	1.0
				1	14	21.8	21.0±1	1.0
				8	0	21.2	21.0±1	1.0
				8	4	21.23	21.0±1	1.0
				8	9	21.19	21.0±1	1.0
				15	0	21.12	21.0±1	1.0
				20525	836.5	QPSK	1	0
	1	8	22.92				22.0±1	/
	1	14	22.87				22.0±1	/
	6	0	21.97				21.0±1	1.0
	6	4	21.97				21.0±1	1.0
	6	9	21.98				21.0±1	1.0
	15	0	21.92				21.0±1	1.0
	16QAM	1	0			21.19	21.0±1	1.0
		1	8			21.2	21.0±1	1.0
		1	14			21.16	21.0±1	1.0
		6	0			21.05	21.0±1	1.0
		6	4			21.04	21.0±1	1.0
		6	9			21.02	21.0±1	1.0
		15	0			20.97	21.0±1	1.0
		20635	847.5			QPSK	1	0
	1			8	22.87		22.0±1	/
1	14			22.84	22.0±1		/	
6	0			21.95	21.0±1		1.0	
6	4			21.96	21.0±1		1.0	
6	9			21.90	21.0±1		1.0	
15	0			21.93	21.0±1		1.0	
16QAM	1			0	21.79	21.0±1	1.0	
	1			8	21.79	21.0±1	1.0	
	1			14	21.77	21.0±1	1.0	
	8			0	20.99	21.0±1	1.0	
	8			4	20.98	21.0±1	1.0	
	8			9	20.97	21.0±1	1.0	
	15			0	20.86	21.0±1	1.0	

BW(MHz)	Ch	Freq(MHz)	Mode	UL RB Allocation	UL RB Offset	Average Power (dbm)	Tune up limited(dBm)	MPR (dB)
5MHz	20425	826.5	QPSK	1	0	22.88	22.0±1	/
				1	49	22.89	22.0±1	/
				1	99	22.92	22.0±1	/
				12	0	21.08	21.0±1	1.0
				12	24	21.05	21.0±1	1.0
				12	49	21.04	21.0±1	1.0
				25	0	21.01	21.0±1	1.0
			16QAM	1	0	21.22	21.0±1	1.0
				1	49	21.16	21.0±1	1.0
				1	99	21.12	21.0±1	1.0
				12	0	21.22	21.0±1	1.0
				12	24	21.18	21.0±1	1.0
				12	49	21.2	21.0±1	1.0
				25	0	21.11	21.0±1	1.0
	20525	836.5	QPSK	1	0	22.71	22.0±1	/
				1	49	22.96	22.0±1	/
				1	99	22.91	22.0±1	/
				12	0	21.98	21.0±1	1.0
				12	24	21.94	21.0±1	1.0
				12	49	21.95	21.0±1	1.0
				25	0	21.92	21.0±1	1.0
			16QAM	1	0	21.43	21.0±1	1.0
				1	49	21.39	21.0±1	1.0
				1	99	21.35	21.0±1	1.0
				12	0	21.16	21.0±1	1.0
				12	24	21.12	21.0±1	1.0
				12	49	21.13	21.0±1	1.0
25				0	21.02	21.0±1	1.0	
20625	846.5	QPSK	1	0	22.9	22.0±1	/	
			1	49	22.49	22.0±1	/	
			1	99	22.51	22.0±1	/	
			12	0	21.95	21.0±1	1.0	
			12	24	21.94	21.0±1	1.0	
			12	49	21.94	21.0±1	1.0	
			25	0	21.88	21.0±1	1.0	
		16QAM	1	0	21.95	21.0±1	1.0	
			1	49	21.92	21.0±1	1.0	
			1	99	21.91	21.0±1	1.0	
			12	0	21.04	21.0±1	1.0	
			12	24	21	21.0±1	1.0	
			12	49	20.98	21.0±1	1.0	
			25	0	20.87	21.0±1	1.0	

BW(MHz)	Ch	Freq(MHz)	Mode	UL RB Allocation	UL RB Offset	Average Power (dbm)	Tune up limited(dBm)	MPR (dB)
10MHz	20450	829	QPSK	1	0	22.86	22.0±1	/
				1	49	22.79	22.0±1	/
				1	99	22.96	22.0±1	/
				25	0	21.05	21.0±1	1.0
				25	24	21.02	21.0±1	1.0
				25	49	21	21.0±1	1.0
				50	0	21.05	21.0±1	1.0
			16QAM	1	0	21.97	21.0±1	1.0
				1	49	21.9	21.0±1	1.0
				1	99	21.81	21.0±1	1.0
				25	0	21.14	21.0±1	1.0
				25	24	21.12	21.0±1	1.0
				25	49	21.08	21.0±1	1.0
				50	0	21.1	21.0±1	1.0
	20525	836.5	QPSK	1	0	22.97	22.0±1	/
				1	49	22.99	22.0±1	/
				1	99	22.93	22.0±1	/
				25	0	21.96	21.0±1	1.0
				25	24	21.98	21.0±1	1.0
				25	49	21.93	21.0±1	1.0
				50	0	21.96	21.0±1	1.0
			16QAM	1	0	21.28	21.0±1	1.0
				1	49	21.21	21.0±1	1.0
				1	99	21.24	21.0±1	1.0
				25	0	21.03	21.0±1	1.0
				25	24	20.99	21.0±1	1.0
				25	49	21	21.0±1	1.0
				50	0	21.02	21.0±1	1.0
	20600	844	QPSK	1	0	22.96	22.0±1	/
				1	49	22.94	22.0±1	/
1				99	22.11	22.0±1	/	
25				0	21.92	21.0±1	1.0	
25				24	21.88	21.0±1	1.0	
25				49	21.92	21.0±1	1.0	
50				0	21.93	21.0±1	1.0	
16QAM			1	0	21.87	21.0±1	1.0	
			1	49	21.86	21.0±1	1.0	
			1	99	21.8	21.0±1	1.0	
			25	0	21.04	21.0±1	1.0	
			25	24	21.01	21.0±1	1.0	
			25	49	21.02	21.0±1	1.0	
			50	0	21	21.0±1	1.0	

LTE Band 7:

BW(MHz)	Ch	Freq(MHz)	Mode	UL RB Allocation	UL RB Offset	Average Power (dbm)	Tune up limited(dBm)	MPR (dB)
5MHz	20775	2502.5	QPSK	1	0	21.87	21.0±1	/
				1	49	21.86	21.0±1	/
				1	99	21.55	21.0±1	/
				12	0	20.68	20.0±1	1.0
				12	24	20.65	20.0±1	1.0
				12	49	20.68	20.0±1	1.0
				25	0	20.65	20.0±1	1.0
			16QAM	1	0	20.77	20.0±1	1.0
				1	49	20.78	20.0±1	1.0
				1	99	20.75	20.0±1	1.0
				12	0	19.8	20.0±1	1.0
				12	24	19.78	20.0±1	1.0
				12	49	19.82	20.0±1	1.0
				25	0	19.73	20.0±1	1.0
	21100	2535	QPSK	1	0	21.71	21.0±1	/
				1	49	21.69	21.0±1	/
				1	99	21.65	21.0±1	/
				12	0	20.65	20.0±1	1.0
				12	24	20.63	20.0±1	1.0
				12	49	20.64	20.0±1	1.0
				25	0	20.59	20.0±1	1.0
			16QAM	1	0	20.03	20.0±1	1.0
				1	49	20.08	20.0±1	1.0
				1	99	20.04	20.0±1	1.0
				12	0	19.7	20.0±1	1.0
				12	24	19.69	20.0±1	1.0
				12	49	19.73	20.0±1	1.0
25				0	19.57	20.0±1	1.0	
21425	2567.5	QPSK	1	0	21.84	21.0±1	/	
			1	49	21.91	21.0±1	/	
			1	99	21.55	21.0±1	/	
			12	0	20.91	20.0±1	1.0	
			12	24	20.88	20.0±1	1.0	
			12	49	20.91	20.0±1	1.0	
			25	0	20.84	20.0±1	1.0	
		16QAM	1	0	20.85	20.0±1	1.0	
			1	49	20.8	20.0±1	1.0	
			1	99	20.69	20.0±1	1.0	
			12	0	19.84	20.0±1	1.0	
			12	24	19.81	20.0±1	1.0	
			12	49	19.84	20.0±1	1.0	
			25	0	19.69	20.0±1	1.0	

BW(MHz)	Ch	Freq(MHz)	Mode	UL RB Allocation	UL RB Offset	Average Power (dbm)	Tune up limited(dBm)	MPR (dB)
10MHz	20800	2505	QPSK	1	0	21.77	21.0±1	/
				1	49	21.75	21.0±1	/
				1	99	21.72	21.0±1	/
				25	0	20.75	20.0±1	1.0
				25	24	20.73	20.0±1	1.0
				25	49	20.72	20.0±1	1.0
				50	0	20.76	20.0±1	1.0
			16QAM	1	0	20.63	20.0±1	1.0
				1	49	20.58	20.0±1	1.0
				1	99	20.52	20.0±1	1.0
				25	0	19.74	20.0±1	1.0
				25	24	19.74	20.0±1	1.0
				25	49	19.76	20.0±1	1.0
				50	0	19.77	20.0±1	1.0
	21100	2535	QPSK	1	0	21.68	21.0±1	/
				1	49	21.7	21.0±1	/
				1	99	21.71	21.0±1	/
				25	0	20.62	20.0±1	1.0
				25	24	20.64	20.0±1	1.0
				25	49	20.66	20.0±1	1.0
				50	0	20.63	20.0±1	1.0
			16QAM	1	0	20.86	20.0±1	1.0
				1	49	20.92	20.0±1	1.0
				1	99	20.96	20.0±1	1.0
				25	0	19.53	20.0±1	1.0
				25	24	19.56	20.0±1	1.0
				25	49	19.64	20.0±1	1.0
				50	0	19.53	20.0±1	1.0
	21400	2565	QPSK	1	0	21.94	21.0±1	/
				1	49	21.96	21.0±1	/
1				99	21.18	21.0±1	/	
25				0	20.76	20.0±1	1.0	
25				24	20.79	20.0±1	1.0	
25				49	20.8	20.0±1	1.0	
50				0	20.8	20.0±1	1.0	
16QAM			1	0	20.69	20.0±1	1.0	
			1	49	20.72	20.0±1	1.0	
			1	99	20.28	20.0±1	1.0	
			25	0	19.77	20.0±1	1.0	
			25	24	19.81	20.0±1	1.0	
			25	49	19.85	20.0±1	1.0	
			50	0	19.78	20.0±1	1.0	

BW(MHz)	Ch	Freq(MHz)	Mode	UL RB Allocation	UL RB Offset	Average Power (dbm)	Tune up limited(dBm)	MPR (dB)
15MHz	20825	2507.5	QPSK	1	0	21.87	21.0±1	/
				1	49	21.75	21.0±1	/
				1	99	21.73	21.0±1	/
				36	0	20.89	20.0±1	1.0
				36	24	20.83	20.0±1	1.0
				36	49	20.81	20.0±1	1.0
				75	0	20.86	20.0±1	1.0
			16QAM	1	0	20.67	20.0±1	1.0
				1	49	20.58	20.0±1	1.0
				1	99	20.54	20.0±1	1.0
				36	0	19.85	20.0±1	1.0
				36	24	19.78	20.0±1	1.0
				36	49	19.74	20.0±1	1.0
				75	0	19.85	20.0±1	1.0
	21100	2535	QPSK	1	0	21.73	21.0±1	/
				1	49	21.73	21.0±1	/
				1	99	21.75	21.0±1	/
				36	0	20.81	20.0±1	1.0
				36	24	20.8	20.0±1	1.0
				36	49	20.81	20.0±1	1.0
				75	0	20.81	20.0±1	1.0
			16QAM	1	0	20.86	20.0±1	1.0
				1	49	20.93	20.0±1	1.0
				1	99	20.99	20.0±1	1.0
				36	0	19.69	20.0±1	1.0
				36	24	19.74	20.0±1	1.0
				36	49	19.76	20.0±1	1.0
75				0	19.71	20.0±1	1.0	
21375	2562.5	QPSK	1	0	21.94	21.0±1	/	
			1	49	21.95	21.0±1	/	
			1	99	21.28	21.0±1	/	
			36	0	20.01	20.0±1	1.0	
			36	24	20.01	20.0±1	1.0	
			36	49	20.99	20.0±1	1.0	
			75	0	20.98	20.0±1	1.0	
		16QAM	1	0	20.88	20.0±1	1.0	
			1	49	20.89	20.0±1	1.0	
			1	99	20.57	20.0±1	1.0	
			36	0	19.71	20.0±1	1.0	
			36	24	19.72	20.0±1	1.0	
			36	49	19.74	20.0±1	1.0	
			75	0	19.74	20.0±1	1.0	

BW(MHz)	Ch	Freq(MHz)	Mode	UL RB Allocation	UL RB Offset	Average Power (dbm)	Tune up limited(dBm)	MPR (dB)
20MHz	20850	2510	QPSK	1	0	21.84	21.0±1	/
				1	49	21.71	21.0±1	/
				1	99	21.76	21.0±1	/
				50	0	20.8	20.0±1	1.0
				50	24	20.71	20.0±1	1.0
				50	49	20.7	20.0±1	1.0
				100	0	20.64	20.0±1	1.0
			16QAM	1	0	20.15	20.0±1	1.0
				1	49	20.03	20.0±1	1.0
				1	99	20.98	20.0±1	1.0
				50	0	19.75	20.0±1	1.0
				50	24	19.68	20.0±1	1.0
				50	49	19.65	20.0±1	1.0
				100	0	19.74	20.0±1	1.0
	21100	2535	QPSK	1	0	21.77	21.0±1	/
				1	49	21.93	21.0±1	/
				1	99	21.85	21.0±1	/
				50	0	20.46	20.0±1	1.0
				50	24	20.97	20.0±1	1.0
				50	49	20.63	20.0±1	1.0
				100	0	20.72	20.0±1	1.0
			16QAM	1	0	20.79	20.0±1	1.0
				1	49	20.03	20.0±1	1.0
				1	99	20.74	20.0±1	1.0
				50	0	19.54	20.0±1	1.0
				50	24	19.63	20.0±1	1.0
				50	49	19.75	20.0±1	1.0
				100	0	19.67	20.0±1	1.0
	21350	2560	QPSK	1	0	21.87	21.0±1	/
				1	49	21.91	21.0±1	/
1				99	21.29	21.0±1	/	
50				0	20.72	20.0±1	1.0	
50				24	20.73	20.0±1	1.0	
50				49	20.76	20.0±1	1.0	
100				0	20.73	20.0±1	1.0	
16QAM			1	0	20.96	20.0±1	1.0	
			1	49	20.92	20.0±1	1.0	
			1	99	20.88	20.0±1	1.0	
			50	0	19.64	20.0±1	1.0	
			50	24	19.56	20.0±1	1.0	
			50	49	19.64	20.0±1	1.0	
			100	0	19.62	20.0±1	1.0	

LTE Band 12:

BW(MHz)	Ch	Freq(MHz)	Mode	UL RB Allocation	UL RB Offset	Average Power (dbm)	Tune up limited(dBm)	MPR (dB)
1.4MHz	23017	699.7	QPSK	1	0	22.79	22.0±1	/
				1	2	22.8	22.0±1	/
				1	5	22.79	22.0±1	/
				3	0	22.82	22.0±1	/
				3	1	22.8	22.0±1	/
				3	2	22.8	22.0±1	/
			16QAM	6	0	21.82	21.0±1	1.0
				1	0	21.82	21.0±1	1.0
				1	2	21.87	21.0±1	1.0
				1	5	21.84	21.0±1	1.0
				3	0	21.83	21.0±1	1.0
				3	1	21.83	21.0±1	1.0
	23095	707.5	QPSK	3	2	21.85	21.0±1	1.0
				6	0	20.92	21.0±1	1.0
				1	0	22.83	22.0±1	/
				1	2	22.89	22.0±1	/
				1	5	22.85	22.0±1	/
				3	0	22.82	22.0±1	/
			16QAM	3	1	22.83	22.0±1	/
				3	2	22.83	22.0±1	/
				6	0	21.84	21.0±1	1.0
				1	0	21.08	21.0±1	1.0
				1	2	21.09	21.0±1	1.0
				1	5	21.07	21.0±1	1.0
	23173	715.3	QPSK	3	0	21.93	21.0±1	1.0
				3	1	21.89	21.0±1	1.0
				3	2	21.91	21.0±1	1.0
				6	0	20.67	21.0±1	1.0
				1	0	22.81	22.0±1	/
				1	2	22.86	22.0±1	/
16QAM			1	5	22.79	22.0±1	/	
			3	0	22.78	22.0±1	/	
			3	1	22.75	22.0±1	/	
			3	2	22.77	22.0±1	/	
			6	0	21.74	21.0±1	1.0	
			1	0	21.69	21.0±1	1.0	
				1	2	21.71	21.0±1	1.0
				1	5	21.72	21.0±1	1.0
				3	0	21.91	21.0±1	1.0
				3	1	21.88	21.0±1	1.0
				3	2	21.89	21.0±1	1.0
				6	0	20.9	21.0±1	1.0

BW(MHz)	Ch	Freq(MHz)	Mode	UL RB Allocation	UL RB Offset	Average Power (dbm)	Tune up limited(dBm)	MPR (dB)
3MHz	23025	700.5	QPSK	1	0	22.73	22.0±1	/
				1	8	22.75	22.0±1	/
				1	14	22.73	22.0±1	/
				8	0	21.85	21.0±1	1.0
				8	4	21.86	21.0±1	1.0
				8	9	21.85	21.0±1	1.0
				15	0	21.82	21.0±1	1.0
			16QAM	1	0	21.61	21.0±1	1.0
				1	8	21.65	21.0±1	1.0
				1	14	21.58	21.0±1	1.0
				8	0	20.94	21.0±1	1.0
				8	4	20.94	21.0±1	1.0
				8	9	20.91	21.0±1	1.0
				15	0	20.84	21.0±1	1.0
				23095	707.5	QPSK	1	0
	1	8	22.86				22.0±1	/
	1	14	22.84				22.0±1	/
	8	0	21.91				21.0±1	1.0
	8	4	21.94				21.0±1	1.0
	8	9	21.94				21.0±1	1.0
	15	0	21.84				21.0±1	1.0
	16QAM	1	0			21.06	21.0±1	1.0
		1	8			21.09	21.0±1	1.0
		1	14			21.08	21.0±1	1.0
		8	0			20.91	21.0±1	1.0
		8	4			20.95	21.0±1	1.0
		8	9			20.94	21.0±1	1.0
		15	0			20.84	21.0±1	1.0
		23165	714.5			QPSK	1	0
	1			8	22.83		22.0±1	/
1	14			22.79	22.0±1		/	
8	0			21.86	21.0±1		1.0	
8	4			21.89	21.0±1		1.0	
8	9			21.84	21.0±1		1.0	
15	0			21.83	21.0±1		1.0	
16QAM	1			0	21.74	21.0±1	1.0	
	1			8	21.72	21.0±1	1.0	
	1			14	21.69	21.0±1	1.0	
	8			0	20.88	21.0±1	1.0	
	8			4	20.9	21.0±1	1.0	
	8			9	20.84	21.0±1	1.0	
	15			0	20.76	21.0±1	1.0	

BW(MHz)	Ch	Freq(MHz)	Mode	UL RB Allocation	UL RB Offset	Average Power (dbm)	Tune up limited(dBm)	MPR (dB)
5MHz	23035	701.5	QPSK	1	0	22.86	22.0±1	/
				1	49	22.86	22.0±1	/
				1	99	22.79	22.0±1	/
				12	0	21.89	21.0±1	1.0
				12	24	21.89	21.0±1	1.0
				12	49	21.89	21.0±1	1.0
				25	0	21.83	21.0±1	1.0
			16QAM	1	0	21.99	21.0±1	1.0
				1	49	21.01	21.0±1	1.0
				1	99	21.95	21.0±1	1.0
				12	0	20.96	21.0±1	1.0
				12	24	20.93	21.0±1	1.0
				12	49	20.95	21.0±1	1.0
				25	0	20.85	21.0±1	1.0
	23095	707.5	QPSK	1	0	22.92	22.0±1	/
				1	49	22.95	22.0±1	/
				1	99	22.9	22.0±1	/
				12	0	21.88	21.0±1	1.0
				12	24	21.89	21.0±1	1.0
				12	49	21.91	21.0±1	1.0
				25	0	21.85	21.0±1	1.0
			16QAM	1	0	21.32	21.0±1	1.0
				1	49	21.32	21.0±1	1.0
				1	99	21.3	21.0±1	1.0
				12	0	20.99	21.0±1	1.0
				12	24	20.99	21.0±1	1.0
				12	49	20	21.0±1	1.0
				25	0	20.88	21.0±1	1.0
	23155	713.5	QPSK	1	0	22.87	22.0±1	/
				1	49	22.86	22.0±1	/
1				99	22.79	22.0±1	/	
12				0	21.9	21.0±1	1.0	
12				24	21.86	21.0±1	1.0	
12				49	21.86	21.0±1	1.0	
25				0	21.84	21.0±1	1.0	
16QAM			1	0	21.9	21.0±1	1.0	
			1	49	21.87	21.0±1	1.0	
			1	99	21.84	21.0±1	1.0	
			12	0	20.92	21.0±1	1.0	
			12	24	20.9	21.0±1	1.0	
			12	49	20.87	21.0±1	1.0	
			25	0	20.77	21.0±1	1.0	

BW(MHz)	Ch	Freq(MHz)	Mode	UL RB Allocation	UL RB Offset	Average Power (dbm)	Tune up limited(dBm)	MPR (dB)
10MHz	23060	704	QPSK	1	0	22.86	22.0±1	/
				1	49	22.87	22.0±1	/
				1	99	22.95	22.0±1	/
				25	0	21.84	21.0±1	1.0
				25	24	21.84	21.0±1	1.0
				25	49	21.87	21.0±1	1.0
				50	0	21.86	21.0±1	1.0
			16QAM	1	0	21.75	21.0±1	1.0
				1	49	21.71	21.0±1	1.0
				1	99	21.77	21.0±1	1.0
				25	0	20.86	21.0±1	1.0
				25	24	20.83	21.0±1	1.0
				25	49	20.87	21.0±1	1.0
				50	0	20.84	21.0±1	1.0
	23095	707.5	QPSK	1	0	22.87	22.0±1	/
				1	49	22.97	22.0±1	/
				1	99	22.89	22.0±1	/
				25	0	21.84	21.0±1	1.0
				25	24	21.96	21.0±1	1.0
				25	49	21.9	21.0±1	1.0
				50	0	21.85	21.0±1	1.0
			16QAM	1	0	21.13	21.0±1	1.0
				1	49	21.16	21.0±1	1.0
				1	99	21.15	21.0±1	1.0
				25	0	20.85	21.0±1	1.0
				25	24	20.85	21.0±1	1.0
				25	49	20.89	21.0±1	1.0
				50	0	20.84	21.0±1	1.0
	23130	711	QPSK	1	0	22.96	22.0±1	/
				1	49	22.96	22.0±1	/
1				99	22.9	22.0±1	/	
25				0	21.88	21.0±1	1.0	
25				24	21.86	21.0±1	1.0	
25				49	21.87	21.0±1	1.0	
50				0	21.88	21.0±1	1.0	
16QAM			1	0	21.86	21.0±1	1.0	
			1	49	21.83	21.0±1	1.0	
			1	99	21.79	21.0±1	1.0	
			25	0	20.93	21.0±1	1.0	
			25	24	20.93	21.0±1	1.0	
			25	49	20.93	21.0±1	1.0	
			50	0	20.88	21.0±1	1.0	

LTE Band 17:

BW(MHz)	Ch	Freq(MHz)	Mode	UL RB Allocation	UL RB Offset	Average Power (dbm)	Tune up limited(dBm)	MPR (dB)
5MHz	23755	706.5	QPSK	1	0	23.11	23.0±1	/
				1	49	23.11	23.0±1	/
				1	99	23.1	23.0±1	/
				12	0	22.15	22.0±1	1.0
				12	24	22.13	22.0±1	1.0
				12	49	22.15	22.0±1	1.0
				25	0	22.1	22.0±1	1.0
			16QAM	1	0	22.26	22.0±1	1.0
				1	49	22.25	22.0±1	1.0
				1	99	22.24	22.0±1	1.0
				12	0	21.2	22.0±1	1.0
				12	24	21.17	22.0±1	1.0
				12	49	21.2	22.0±1	1.0
				25	0	21.1	22.0±1	1.0
	23790	710	QPSK	1	0	23.18	23.0±1	/
				1	49	23.18	23.0±1	/
				1	99	23.13	23.0±1	/
				12	0	22.16	22.0±1	1.0
				12	24	22.18	22.0±1	1.0
				12	49	22.14	22.0±1	1.0
				25	0	22.11	22.0±1	1.0
			16QAM	1	0	22.6	22.0±1	1.0
				1	49	22.59	22.0±1	1.0
				1	99	22.56	22.0±1	1.0
				12	0	21.26	22.0±1	1.0
				12	24	21.25	22.0±1	1.0
				12	49	21.25	22.0±1	1.0
25				0	21.13	22.0±1	1.0	
23825	713.5	QPSK	1	0	23.17	23.0±1	/	
			1	49	23.12	23.0±1	/	
			1	99	23.01	23.0±1	/	
			12	0	22.16	22.0±1	1.0	
			12	24	22.12	22.0±1	1.0	
			12	49	22.1	22.0±1	1.0	
			25	0	22.09	22.0±1	1.0	
		16QAM	1	0	22.21	22.0±1	1.0	
			1	49	22.15	22.0±1	1.0	
			1	99	22.08	22.0±1	1.0	
			12	0	21.17	22.0±1	1.0	
			12	24	21.14	22.0±1	1.0	
			12	49	21.11	22.0±1	1.0	
			25	0	21.01	22.0±1	1.0	

BW(MHz)	Ch	Freq(MHz)	Mode	UL RB Allocation	UL RB Offset	Average Power (dbm)	Tune up limited(dBm)	MPR (dB)
10MHz	23780	709	QPSK	1	0	23.13	23.0±1	/
				1	49	23.19	23.0±1	/
				1	99	23.12	23.0±1	/
				25	0	22.1	22.0±1	1.0
				25	24	22.12	22.0±1	1.0
				25	49	22.15	22.0±1	1.0
				50	0	22.14	22.0±1	1.0
			16QAM	1	0	22.02	22.0±1	1.0
				1	49	22.02	22.0±1	1.0
				1	99	22	22.0±1	1.0
				25	0	21.11	22.0±1	1.0
				25	24	21.1	22.0±1	1.0
				25	49	21.13	22.0±1	1.0
				50	0	21.09	22.0±1	1.0
	23790	710	QPSK	1	0	23.14	23.0±1	/
				1	49	23.58	23.0±1	/
				1	99	23.11	23.0±1	/
				25	0	22.11	22.0±1	1.0
				25	24	22.71	22.0±1	1.0
				25	49	22.13	22.0±1	1.0
				50	0	22.13	22.0±1	1.0
			16QAM	1	0	22.45	22.0±1	1.0
				1	49	22.44	22.0±1	1.0
				1	99	22.38	22.0±1	1.0
				25	0	21.11	22.0±1	1.0
				25	24	21.12	22.0±1	1.0
				25	49	21.12	22.0±1	1.0
				50	0	21.11	22.0±1	1.0
	23800	711	QPSK	1	0	23.18	23.0±1	/
				1	49	23.19	23.0±1	/
1				99	23.09	23.0±1	/	
25				0	22.12	22.0±1	1.0	
25				24	22.12	22.0±1	1.0	
25				49	22.11	22.0±1	1.0	
50				0	22.13	22.0±1	1.0	
16QAM			1	0	22.07	22.0±1	1.0	
			1	49	22.1	22.0±1	1.0	
			1	99	21.99	22.0±1	1.0	
			25	0	21.16	22.0±1	1.0	
			25	24	21.17	22.0±1	1.0	
			25	49	21.17	22.0±1	1.0	
			50	0	21.12	22.0±1	1.0	

ERP and EIRP

LTE Band 2

Frequency (MHz)	Receiver Reading (dBμV)	Turn table Angle Degree	RX Antenna		Substituted			Absolute Level (dBm)	Part 24E	
			Height (m)	Polar (H/V)	SG Level (dBm)	Cable (dB)	Antenna Gain (dB)		Limit (dBm)	Margin (dB)
LTE Band 2 Channel 18607 – 1.4MHz – QPSK										
1850.70	83.67	31	2.4	H	9.70	0.31	10.40	19.79	33	-13.21
1850.70	84.71	69	1.9	V	11.43	0.31	10.40	21.52	33	-11.48
LTE Band 2 Channel 18900 – 1.4MHz – QPSK										
1880.00	82.63	239	2.4	H	8.78	0.31	10.40	18.87	33	-14.13
1880.00	84.48	61	2.1	V	11.36	0.31	10.40	21.45	33	-11.55
LTE Band 2 Channel 19193 – 1.4MHz – QPSK										
1909.30	83.65	286	1.4	H	9.92	0.32	10.40	20.00	33	-13.00
1909.30	84.03	298	1.9	V	11.07	0.32	10.40	21.15	33	-11.85
LTE Band 2 Channel 18607 – 1.4MHz – 16QAM										
1850.70	82.67	296	2.4	H	8.70	0.31	10.40	18.79	33	-14.21
1850.70	85.00	266	1.8	V	11.72	0.31	10.40	21.81	33	-11.19
LTE Band 2 Channel 18900 – 1.4MHz – 16QAM										
1880.00	83.41	16	1.3	H	9.56	0.31	10.40	19.65	33	-13.35
1880.00	84.24	101	2.2	V	11.12	0.31	10.40	21.21	33	-11.79
LTE Band 2 Channel 19193 – 1.4MHz – 16QAM										
1909.30	82.95	323	2.0	H	9.22	0.32	10.40	19.30	33	-13.70
1909.30	84.17	94	1.1	V	11.21	0.32	10.40	21.29	33	-11.71
LTE Band 2 Channel 18615 – 3MHz – QPSK										
1851.50	83.64	219	1.3	H	9.67	0.31	10.40	19.76	33	-13.24
1851.50	84.24	176	1.5	V	10.96	0.31	10.40	21.05	33	-11.95
LTE Band 2 Channel 18900 – 3MHz – QPSK										
1880.00	83.47	129	2.3	H	9.62	0.31	10.40	19.71	33	-13.29
1880.00	84.49	192	2.1	V	11.37	0.31	10.40	21.46	33	-11.54
LTE Band 2 Channel 19185 – 3MHz – QPSK										
1908.50	82.49	124	1.0	H	8.76	0.32	10.40	18.84	33	-14.16
1908.50	84.18	303	2.0	V	11.22	0.32	10.40	21.30	33	-11.70
LTE Band 2 Channel 18615 – 3MHz – 16QAM										
1851.50	82.69	71	1.3	H	8.72	0.31	10.40	18.81	33	-14.19
1851.50	84.80	180	2.2	V	11.52	0.31	10.40	21.61	33	-11.39
LTE Band 2 Channel 18900 – 3MHz – 16QAM										
1880.00	83.17	296	1.9	H	9.32	0.31	10.40	19.41	33	-13.59
1880.00	84.77	335	1.1	V	11.65	0.31	10.40	21.74	33	-11.26
LTE Band 2 Channel 19185 – 3MHz – 16QAM										
1908.50	83.64	240	1.8	H	9.91	0.32	10.40	19.99	33	-13.01
1908.50	84.58	234	1.5	V	11.62	0.32	10.40	21.70	33	-11.30
LTE Band 2 Channel 18625 – 5MHz – QPSK										
1852.50	82.60	158	1.5	H	8.63	0.31	10.40	18.72	33	-14.28
1852.50	84.14	40	1.2	V	10.86	0.31	10.40	20.95	33	-12.05
LTE Band 2 Channel 18900 – 5MHz – QPSK										

1880.00	82.16	36	2.4	H	8.31	0.31	10.40	18.40	33	-14.60
1880.00	84.22	45	2.0	V	11.10	0.31	10.40	21.19	33	-11.81
LTE Band 2 Channel 19175 – 5MHz – QPSK										
1907.50	83.09	57	1.9	H	9.36	0.32	10.40	19.44	33	-13.56
1907.50	84.09	133	1.1	V	11.13	0.32	10.40	21.21	33	-11.79
LTE Band 2 Channel 18625 – 5MHz – 16QAM										
1852.50	82.63	143	1.6	H	8.66	0.31	10.40	18.75	33	-14.25
1852.50	84.89	101	2.2	V	11.61	0.31	10.40	21.70	33	-11.30
LTE Band 2 Channel 18900 – 5MHz – 16QAM										
1880.00	83.04	21	1.1	H	9.19	0.31	10.40	19.28	33	-13.72
1880.00	84.27	269	1.1	V	11.15	0.31	10.40	21.24	33	-11.76
LTE Band 2 Channel 19175 – 5MHz – 16QAM										
1907.50	82.59	314	2.2	H	8.86	0.32	10.40	18.94	33	-14.06
1907.50	84.41	241	1.5	V	11.45	0.32	10.40	21.53	33	-11.47
LTE Band 2 Channel 18650 – 10MHz – QPSK										
1855.00	82.60	254	1.5	H	8.63	0.31	10.40	18.72	33	-14.28
1855.00	84.19	247	1.8	V	10.91	0.31	10.40	21.00	33	-12.00
LTE Band 2 Channel 18900 – 10MHz – QPSK										
1880.00	82.54	165	1.8	H	8.69	0.31	10.40	18.78	33	-14.22
1880.00	84.79	357	2.0	V	11.67	0.31	10.40	21.76	33	-11.24
LTE Band 2 Channel 19150 – 10MHz – QPSK										
1905.00	82.74	120	2.4	H	9.01	0.32	10.40	19.09	33	-13.91
1905.00	84.59	194	2.3	V	11.63	0.32	10.40	21.71	33	-11.29
LTE Band 2 Channel 18650 – 10MHz – 16QAM										
1855.00	82.81	102	2.4	H	8.84	0.31	10.40	18.93	33	-14.07
1855.00	84.10	93	2.2	V	10.82	0.31	10.40	20.91	33	-12.09
LTE Band 2 Channel 18900 – 10MHz – 16QAM										
1880.00	82.61	278	1.9	H	8.76	0.31	10.40	18.85	33	-14.15
1880.00	84.14	140	2.3	V	11.02	0.31	10.40	21.11	33	-11.89
LTE Band 2 Channel 19150 – 10MHz – 16QAM										
1905.00	82.62	335	1.4	H	8.89	0.32	10.40	18.97	33	-14.03
1905.00	84.11	159	1.4	V	11.15	0.32	10.40	21.23	33	-11.77
LTE Band 2 Channel 18675 – 15MHz – QPSK										
1857.50	82.48	64	2.0	H	8.51	0.31	10.40	18.60	33	-14.40
1857.50	84.59	226	1.5	V	11.31	0.31	10.40	21.40	33	-11.60
LTE Band 2 Channel 18900 – 15MHz – QPSK										
1880.00	83.81	132	2.1	H	9.96	0.31	10.40	20.05	33	-12.95
1880.00	84.22	221	1.6	V	11.10	0.31	10.40	21.19	33	-11.81
LTE Band 2 Channel 19125 – 15MHz – QPSK										
1902.50	82.97	186	1.5	H	9.24	0.32	10.40	19.32	33	-13.68
1902.50	84.67	240	1.3	V	11.71	0.32	10.40	21.79	33	-11.21
LTE Band 2 Channel 18675 – 15MHz – 16QAM										
1857.50	83.69	293	2.2	H	9.72	0.31	10.40	19.81	33	-13.19
1857.50	84.56	326	1.4	V	11.28	0.31	10.40	21.37	33	-11.63
LTE Band 2 Channel 18900 – 15MHz – 16QAM										
1880.00	83.96	308	1.9	H	10.11	0.31	10.40	20.20	33	-12.80
1880.00	84.30	145	1.2	V	11.18	0.31	10.40	21.27	33	-11.73

LTE Band 2 Channel 19125 – 15MHz – 16QAM										
1902.50	83.49	111	2.0	H	9.76	0.32	10.40	19.84	33	-13.16
1902.50	84.72	208	2.4	V	11.76	0.32	10.40	21.84	33	-11.16
LTE Band 2 Channel 18700 – 20MHz – QPSK										
1860.00	83.43	166	1.9	H	9.46	0.31	10.40	19.55	33	-13.45
1860.00	84.27	106	1.3	V	10.99	0.31	10.40	21.08	33	-11.92
LTE Band 2 Channel 18900 – 20MHz – QPSK										
1880.00	83.63	40	2.0	H	9.78	0.31	10.40	19.87	33	-13.13
1880.00	84.13	154	1.7	V	11.01	0.31	10.40	21.10	33	-11.90
LTE Band 2 Channel 19100 – 20MHz – QPSK										
1900.00	83.67	139	2.3	H	9.94	0.32	10.40	20.02	33	-12.98
1900.00	84.37	114	2.2	V	11.41	0.32	10.40	21.49	33	-11.51
LTE Band 2 Channel 18670 – 20MHz – 16QAM										
1860.00	82.96	139	1.4	H	8.99	0.31	10.40	19.08	33	-13.92
1860.00	84.75	30	1.5	V	11.47	0.31	10.40	21.56	33	-11.44
LTE Band 2 Channel 18900 – 20MHz – 16QAM										
1880.00	83.75	13	1.2	H	9.90	0.31	10.40	19.99	33	-13.01
1880.00	84.36	326	2.3	V	11.24	0.31	10.40	21.33	33	-11.67
LTE Band 2 Channel 19100 – 20MHz – 16QAM										
1900.00	83.26	180	2.4	H	9.53	0.32	10.40	19.61	33	-13.39
1900.00	84.96	45	1.1	V	12.00	0.32	10.40	22.08	33	-10.92

LTE Band 4

Frequency (MHz)	Receiver Reading (dBμV)	Turn table Angle Degree	RX Antenna		Substituted			Absolute Level (dBm)	Part 27	
			Height (m)	Polar (H/V)	SG Level (dBm)	Cable (dB)	Antenna Gain (dB)		Limit (dBm)	Margin (dB)
LTE Band 4 Channel 19957 – 1.4MHz – QPSK										
1710.70	82.35	318	1.3	H	8.24	0.30	9.40	17.34	30	-12.66
1710.70	84.84	54	1.4	V	11.31	0.30	9.40	20.41	30	-9.59
LTE Band 4 Channel 20175 – 1.4MHz – QPSK										
1732.50	82.64	260	1.7	H	8.53	0.30	9.40	17.63	30	-12.37
1732.50	84.26	235	2.3	V	10.73	0.30	9.40	19.83	30	-10.17
LTE Band 4 Channel 20393 – 1.4MHz – QPSK										
1754.30	83.27	111	2.3	H	9.16	0.30	9.40	18.26	30	-11.74
1754.30	84.32	133	1.5	V	10.79	0.30	9.40	19.89	30	-10.11
LTE Band 4 Channel 19957 – 1.4MHz – 16QAM										
1710.70	82.89	278	1.1	H	8.78	0.30	9.40	17.88	30	-12.12
1710.70	84.20	229	1.3	V	10.67	0.30	9.40	19.77	30	-10.23
LTE Band 4 Channel 20175 – 1.4MHz – 16QAM										
1732.50	83.80	220	1.6	H	9.69	0.30	9.40	18.79	30	-11.21
1732.50	84.41	22	2.5	V	10.88	0.30	9.40	19.98	30	-10.02
LTE Band 4 Channel 20393 – 1.4MHz – 16QAM										
1754.30	83.19	195	1.7	H	9.08	0.30	9.40	18.18	30	-11.82
1754.30	84.37	305	2.3	V	10.84	0.30	9.40	19.94	30	-10.06
LTE Band 4 Channel 19965 – 3MHz – QPSK										
1711.50	84.65	307	2.1	H	10.54	0.30	9.40	19.64	30	-10.36
1711.50	84.07	331	1.4	V	10.54	0.30	9.40	19.64	30	-10.36
LTE Band 4 Channel 20175 – 3MHz – QPSK										
1732.50	83.67	58	1.3	H	9.56	0.30	9.40	18.66	30	-11.34
1732.50	84.10	0	1.2	V	10.57	0.30	9.40	19.67	30	-10.33
LTE Band 4 Channel 20385 – 3MHz – QPSK										
1753.50	83.77	218	2.4	H	9.66	0.30	9.40	18.76	30	-11.24
1753.50	84.21	74	2.3	V	10.68	0.30	9.40	19.78	30	-10.22
LTE Band 4 Channel 19965 – 3MHz – 16QAM										
1711.50	83.55	339	2.0	H	9.44	0.30	9.40	18.54	30	-11.46
1711.50	84.78	197	1.3	V	11.25	0.30	9.40	20.35	30	-9.65
LTE Band 4 Channel 20175 – 3MHz – 16QAM										
1732.50	84.25	4	2.1	H	10.14	0.30	9.40	19.24	30	-10.76
1732.50	84.26	16	2.1	V	10.73	0.30	9.40	19.83	30	-10.17
LTE Band 4 Channel 20385 – 3MHz – 16QAM										
1753.50	84.37	122	1.7	H	10.26	0.30	9.40	19.36	30	-10.64
1753.50	84.97	64	1.8	V	11.44	0.30	9.40	20.54	30	-9.46
LTE Band 4 Channel 19975 – 5MHz – QPSK										
1712.50	84.01	8	2.0	H	9.90	0.30	9.40	19.00	30	-11.00

1712.50	84.71	266	2.2	V	11.18	0.30	9.40	20.28	30	-9.72
LTE Band 4 Channel 20175 – 5MHz – QPSK										
1732.50	83.95	228	1.4	H	9.84	0.30	9.40	18.94	30	-11.06
1732.50	84.11	316	1.0	V	10.58	0.30	9.40	19.68	30	-10.32
LTE Band 4 Channel 20375 – 5MHz – QPSK										
1752.50	83.64	80	2.3	H	9.53	0.30	9.40	18.63	30	-11.37
1752.50	84.49	282	1.7	V	10.96	0.30	9.40	20.06	30	-9.94
LTE Band 4 Channel 19975 – 5MHz – 16QAM										
1712.50	83.84	34	1.2	H	9.73	0.30	9.40	18.83	30	-11.17
1712.50	84.96	195	1.8	V	11.43	0.30	9.40	20.53	30	-9.47
LTE Band 4 Channel 20175 – 5MHz – 16QAM										
1732.50	83.43	276	1.2	H	9.32	0.30	9.40	18.42	30	-11.58
1732.50	84.78	157	1.8	V	11.25	0.30	9.40	20.35	30	-9.65
LTE Band 4 Channel 20375 – 5MHz – 16QAM										
1752.50	83.54	25	1.2	H	9.43	0.30	9.40	18.53	30	-11.47
1752.50	84.28	255	1.1	V	10.75	0.30	9.40	19.85	30	-10.15
LTE Band 4 Channel 20000 – 10MHz – QPSK										
1715.00	83.90	275	2.4	H	9.79	0.30	9.40	18.89	30	-11.11
1715.00	84.28	146	2.0	V	10.75	0.30	9.40	19.85	30	-10.15
LTE Band 4 Channel 20175 – 10MHz – QPSK										
1732.50	84.12	148	1.3	H	10.01	0.30	9.40	19.11	30	-10.89
1732.50	84.43	298	2.4	V	10.90	0.30	9.40	20.00	30	-10.00
LTE Band 4 Channel 20350 – 10MHz – QPSK										
1750.00	83.69	112	1.3	H	9.58	0.30	9.40	18.68	30	-11.32
1750.00	84.81	139	1.8	V	11.28	0.30	9.40	20.38	30	-9.62
LTE Band 4 Channel 20000 – 10MHz – 16QAM										
1715.00	83.97	82	2.2	H	9.86	0.30	9.40	18.96	30	-11.04
1715.00	84.54	23	2.1	V	11.01	0.30	9.40	20.11	30	-9.89
LTE Band 4 Channel 20175 – 10MHz – 16QAM										
1732.50	83.95	331	2.5	H	9.84	0.30	9.40	18.94	30	-11.06
1732.50	84.99	144	1.9	V	11.46	0.30	9.40	20.56	30	-9.44
LTE Band 4 Channel 20350 – 10MHz – 16QAM										
1750.00	83.93	324	1.2	H	9.82	0.30	9.40	18.92	30	-11.08
1750.00	84.03	267	1.3	V	10.50	0.30	9.40	19.60	30	-10.40
LTE Band 4 Channel 20025 – 15MHz – QPSK										
1717.50	84.17	318	1.3	H	10.06	0.30	9.40	19.16	30	-10.84
1717.50	84.77	280	1.7	V	11.24	0.30	9.40	20.34	30	-9.66
LTE Band 4 Channel 20175 – 15MHz – QPSK										
1732.50	83.94	15	1.7	H	9.83	0.30	9.40	18.93	30	-11.07
1732.50	84.85	72	1.8	V	11.32	0.30	9.40	20.42	30	-9.58
LTE Band 4 Channel 20325 – 15MHz – QPSK										
1747.50	83.82	334	2.5	H	9.71	0.30	9.40	18.81	30	-11.19
1747.50	84.03	353	1.9	V	10.50	0.30	9.40	19.60	30	-10.40
LTE Band 4 Channel 20025 – 15MHz – 16QAM										
1717.50	83.95	143	1.5	H	9.84	0.30	9.40	18.94	30	-11.06
1717.50	85.00	275	1.2	V	11.47	0.30	9.40	20.57	30	-9.43
LTE Band 4 Channel 20175 – 15MHz – 16QAM										

1732.50	83.65	250	1.1	H	9.54	0.30	9.40	18.64	30	-11.36
1732.50	84.83	58	2.1	V	11.30	0.30	9.40	20.40	30	-9.60
LTE Band 4 Channel 20325 – 15MHz – 16QAM										
1747.50	83.91	284	2.0	H	9.80	0.30	9.40	18.90	30	-11.10
1747.50	84.61	167	1.1	V	11.08	0.30	9.40	20.18	30	-9.82
LTE Band 4 Channel 20050 – 20MHz – QPSK										
1720.00	83.87	157	1.5	H	9.76	0.30	9.40	18.86	30	-11.14
1720.00	84.65	217	1.9	V	11.12	0.30	9.40	20.22	30	-9.78
LTE Band 4 Channel 20175 – 20MHz – QPSK										
1732.50	83.92	344	2.3	H	9.81	0.30	9.40	18.91	30	-11.09
1732.50	84.09	79	1.2	V	10.56	0.30	9.40	19.66	30	-10.34
LTE Band 4 Channel 20300 – 20MHz – QPSK										
1745.00	82.98	206	1.7	H	8.87	0.30	9.40	17.97	30	-12.03
1745.00	84.59	63	2.5	V	11.06	0.30	9.40	20.16	30	-9.84
LTE Band 4 Channel 20050 – 20MHz – 16QAM										
1720.00	83.65	53	1.8	H	9.54	0.30	9.40	18.64	30	-11.36
1720.00	84.50	241	1.4	V	10.97	0.30	9.40	20.07	30	-9.93
LTE Band 4 Channel 20175 – 20MHz – 16QAM										
1732.50	83.54	91	1.9	H	9.43	0.30	9.40	18.53	30	-11.47
1732.50	84.67	4	1.4	V	11.14	0.30	9.40	20.24	30	-9.76
LTE Band 4 Channel 20300 – 20MHz – 16QAM										
1745.00	83.77	15	2.1	H	9.66	0.30	9.40	18.76	30	-11.24
1745.00	84.53	204	1.9	V	11.00	0.30	9.40	20.10	30	-9.90

LTE Band 5

Frequency (MHz)	Receiver Reading (dBμV)	Turn table Angle Degree	RX Antenna		Substituted			Absolute Level (dBm)	Part 22H	
			Height (m)	Polar (H/V)	SG Level (dBm)	Cable (dB)	Antenna Gain (dB)		Limit (dBm)	Margin (dB)
LTE Band 5 Channel 20407 – 1.4MHz – QPSK										
824.70	72.04	305	1.9	H	4.93	0.30	9.40	14.03	38.45	-24.42
824.70	79.14	65	2.3	V	11.61	0.30	9.40	20.71	38.45	-17.74
LTE Band 5 Channel 20525 – 1.4MHz – QPSK										
836.50	75.66	248	2.5	H	8.55	0.30	9.40	17.65	38.45	-20.80
836.50	79.36	38	2.2	V	11.83	0.30	9.40	20.93	38.45	-17.52
LTE Band 5 Channel 20643 – 1.4MHz – QPSK										
848.30	74.66	326	2.5	H	7.55	0.30	9.40	16.65	38.45	-21.80
848.30	79.16	15	2.4	V	11.63	0.30	9.40	20.73	38.45	-17.72
LTE Band 5 Channel 20407 – 1.4MHz – 16QAM										
824.70	73.11	198	2.2	H	6.00	0.30	9.40	15.10	38.45	-23.35
824.70	79.73	34	1.4	V	12.20	0.30	9.40	21.30	38.45	-17.15
LTE Band 5 Channel 20525 – 1.4MHz – 16QAM										
836.50	77.25	294	1.5	H	10.14	0.30	9.40	19.24	38.45	-19.21
836.50	79.65	45	1.0	V	12.12	0.30	9.40	21.22	38.45	-17.23
LTE Band 5 Channel 20643 – 1.4MHz – 16QAM										
848.30	72.91	215	1.0	H	5.80	0.30	9.40	14.90	38.45	-23.55
848.30	79.09	358	1.5	V	11.56	0.30	9.40	20.66	38.45	-17.79
LTE Band 5 Channel 20415 – 3MHz – QPSK										
825.50	75.04	251	1.8	H	7.93	0.30	9.40	17.03	38.45	-21.42
825.50	79.80	58	2.1	V	12.27	0.30	9.40	21.37	38.45	-17.08
LTE Band 5 Channel 20525 – 3MHz – QPSK										
836.50	76.86	11	1.5	H	9.75	0.30	9.40	18.85	38.45	-19.60
836.50	79.42	316	2.0	V	11.89	0.30	9.40	20.99	38.45	-17.46
LTE Band 5 Channel 20635 – 3MHz – QPSK										
847.50	76.17	112	2.1	H	9.06	0.30	9.40	18.16	38.45	-20.29
847.50	79.49	91	2.3	V	11.96	0.30	9.40	21.06	38.45	-17.39
LTE Band 5 Channel 20415 – 3MHz – 16QAM										
825.50	78.16	327	2.5	H	11.05	0.30	9.40	20.15	38.45	-18.30
825.50	79.82	218	1.8	V	12.29	0.30	9.40	21.39	38.45	-17.06
LTE Band 5 Channel 20525 – 3MHz – 16QAM										
836.50	76.14	269	1.8	H	9.03	0.30	9.40	18.13	38.45	-20.32
836.50	79.76	233	2.0	V	12.23	0.30	9.40	21.33	38.45	-17.12
LTE Band 5 Channel 20635 – 3MHz – 16QAM										
847.50	73.96	26	2.5	H	6.85	0.30	9.40	15.95	38.45	-22.50
847.50	79.99	335	2.4	V	12.46	0.30	9.40	21.56	38.45	-16.89
LTE Band 5 Channel 20425 – 5MHz – QPSK										
826.50	72.73	199	2.2	H	5.62	0.30	9.40	14.72	38.45	-23.73
826.50	79.58	248	2.1	V	12.05	0.30	9.40	21.15	38.45	-17.30
LTE Band 5 Channel 20525 – 5MHz – QPSK										
836.50	77.94	278	1.8	H	10.83	0.30	9.40	19.93	38.45	-18.52

836.50	79.52	120	1.4	V	11.99	0.30	9.40	21.09	38.45	-17.36
LTE Band 5 Channel 20625 – 5MHz – QPSK										
846.50	74.81	126	1.8	H	7.70	0.30	9.40	16.80	38.45	-21.65
846.50	79.70	140	1.5	V	12.17	0.30	9.40	21.27	38.45	-17.18
LTE Band 5 Channel 20425 – 5MHz – 16QAM										
826.50	74.45	158	1.5	H	7.34	0.30	9.40	16.44	38.45	-22.01
826.50	79.04	214	2.0	V	11.51	0.30	9.40	20.61	38.45	-17.84
LTE Band 5 Channel 20525 – 5MHz – 16QAM										
836.50	77.60	123	2.3	H	10.49	0.30	9.40	19.59	38.45	-18.86
836.50	79.17	284	2.4	V	11.64	0.30	9.40	20.74	38.45	-17.71
LTE Band 5 Channel 20625 – 5MHz – 16QAM										
846.50	72.59	57	2.1	H	5.48	0.30	9.40	14.58	38.45	-23.87
846.50	79.18	96	1.3	V	11.65	0.30	9.40	20.75	38.45	-17.70
LTE Band 5 Channel 20450 – 10MHz – QPSK										
829.00	74.05	38	1.9	H	6.94	0.30	9.40	16.04	38.45	-22.41
829.00	79.34	125	1.0	V	11.81	0.30	9.40	20.91	38.45	-17.54
LTE Band 5 Channel 20525 – 10MHz – QPSK										
836.50	76.38	16	2.2	H	9.27	0.30	9.40	18.37	38.45	-20.08
836.50	79.85	73	1.7	V	12.32	0.30	9.40	21.42	38.45	-17.03
LTE Band 5 Channel 20600 – 10MHz – QPSK										
844.00	73.54	173	2.4	H	6.43	0.30	9.40	15.53	38.45	-22.92
844.00	79.14	95	2.0	V	11.61	0.30	9.40	20.71	38.45	-17.74
LTE Band 5 Channel 20450 – 10MHz – 16QAM										
829.00	76.44	259	2.1	H	9.33	0.30	9.40	18.43	38.45	-20.02
829.00	79.50	82	1.8	V	11.97	0.30	9.40	21.07	38.45	-17.38
LTE Band 5 Channel 20525 – 10MHz – 16QAM										
836.50	76.50	308	1.5	H	9.39	0.30	9.40	18.49	38.45	-19.96
836.50	79.44	232	1.9	V	11.91	0.30	9.40	21.01	38.45	-17.44
LTE Band 5 Channel 20600 – 10MHz – 16QAM										
844.00	77.98	65	1.4	H	10.87	0.30	9.40	19.97	38.45	-18.48
844.00	79.08	298	1.7	V	11.55	0.30	9.40	20.65	38.45	-17.80

LTE Band 7

Frequency (MHz)	Receiver Reading (dBμV)	Turn table Angle Degree	RX Antenna		Substituted			Absolute Level (dBm)	Part 27	
			Height (m)	Polar (H/V)	SG Level (dBm)	Cable (dB)	Antenna Gain (dB)		Limit (dBm)	Margin (dB)
LTE Band 7 Channel 20775 – 5MHz – QPSK										
2502.50	78.63	257	1.3	H	4.63	0.43	10.60	14.80	33	-18.20
2502.50	81.09	107	1.3	V	10.81	0.43	10.60	20.98	33	-12.02
LTE Band 7 Channel 21100 – 5MHz – QPSK										
2535.00	78.52	253	1.7	H	4.52	0.43	10.60	14.69	33	-18.31
2535.00	81.79	111	2.5	V	11.51	0.43	10.60	21.68	33	-11.32
LTE Band 7 Channel 21425 – 5MHz – QPSK										
2567.50	77.90	279	1.0	H	3.79	0.43	10.60	13.96	33	-19.04
2567.50	81.51	41	1.3	V	11.32	0.43	10.60	21.49	33	-11.51
LTE Band 7 Channel 20775 – 5MHz – 16QAM										
2502.50	76.19	247	2.2	H	2.19	0.43	10.60	12.36	33	-20.64
2502.50	81.20	200	1.8	V	10.92	0.43	10.60	21.09	33	-11.91
LTE Band 7 Channel 21100 – 5MHz – 16QAM										
2535.00	79.20	178	1.6	H	5.20	0.43	10.60	15.37	33	-17.63
2535.00	81.15	152	2.4	V	10.87	0.43	10.60	21.04	33	-11.96
LTE Band 7 Channel 21425 – 5MHz – 16QAM										
2567.50	79.62	116	2.0	H	5.51	0.43	10.60	15.68	33	-17.32
2567.50	81.26	203	2.3	V	11.07	0.43	10.60	21.24	33	-11.76
LTE Band 7 Channel 20800 – 10MHz – QPSK										
2505.00	79.67	224	1.1	H	5.67	0.43	10.60	15.84	33	-17.16
2505.00	81.68	184	1.9	V	11.40	0.43	10.60	21.57	33	-11.43
LTE Band 7 Channel 21100 – 10MHz – QPSK										
2535.00	77.89	152	1.7	H	3.89	0.43	10.60	14.06	33	-18.94
2535.00	81.63	103	1.4	V	11.35	0.43	10.60	21.52	33	-11.48
LTE Band 7 Channel 21400 – 10MHz – QPSK										
2565.00	79.93	153	1.5	H	5.82	0.43	10.60	15.99	33	-17.01
2565.00	81.07	198	2.3	V	10.88	0.43	10.60	21.05	33	-11.95
LTE Band 7 Channel 20800 – 10MHz – 16QAM										
2505.00	77.30	34	1.2	H	3.30	0.43	10.60	13.47	33	-19.53
2505.00	81.76	129	2.3	V	11.48	0.43	10.60	21.65	33	-11.35
LTE Band 7 Channel 21100 – 10MHz – 16QAM										
2535.00	77.35	205	2.0	H	3.35	0.43	10.60	13.52	33	-19.48
2535.00	81.15	81	2.2	V	10.87	0.43	10.60	21.04	33	-11.96
LTE Band 7 Channel 21400 – 10MHz – 16QAM										
2565.00	79.77	266	2.3	H	5.66	0.43	10.60	15.83	33	-17.17
2565.00	81.37	22	2.4	V	11.18	0.43	10.60	21.35	33	-11.65
LTE Band 7 Channel 20825 – 15MHz – QPSK										
2507.50	78.76	248	2.4	H	4.76	0.43	10.60	14.93	33	-18.07
2507.50	81.81	333	2.3	V	11.53	0.43	10.60	21.70	33	-11.30
LTE Band 7 Channel 21100 – 15MHz – QPSK										
2535.00	78.88	231	2.3	H	4.88	0.43	10.60	15.05	33	-17.95

2535.00	81.04	355	1.0	V	10.76	0.43	10.60	20.93	33	-12.07
LTE Band 7 Channel 21375 – 15MHz – QPSK										
2562.50	76.68	330	1.2	H	2.57	0.43	10.60	12.74	33	-20.26
2562.50	81.48	267	2.3	V	11.29	0.43	10.60	21.46	33	-11.54
LTE Band 7 Channel 20825 – 15MHz – 16QAM										
2507.50	76.95	138	1.6	H	2.95	0.43	10.60	13.12	33	-19.88
2507.50	81.20	209	1.1	V	10.92	0.43	10.60	21.09	33	-11.91
LTE Band 7 Channel 21100 – 15MHz – 16QAM										
2535.00	78.59	162	1.2	H	4.59	0.43	10.60	14.76	33	-18.24
2535.00	81.10	212	1.7	V	10.82	0.43	10.60	20.99	33	-12.01
LTE Band 7 Channel 21375 – 15MHz – 16QAM										
2562.50	79.81	46	1.5	H	5.70	0.43	10.60	15.87	33	-17.13
2562.50	81.22	193	2.0	V	11.03	0.43	10.60	21.20	33	-11.80
LTE Band 7 Channel 20850 – 20MHz – QPSK										
2510.00	76.38	223	1.6	H	2.38	0.43	10.60	12.55	33	-20.45
2510.00	81.45	254	1.8	V	11.17	0.43	10.60	21.34	33	-11.66
LTE Band 7 Channel 21100 – 20MHz – QPSK										
2535.00	77.43	174	1.7	H	3.43	0.43	10.60	13.60	33	-19.40
2535.00	81.96	182	1.0	V	11.68	0.43	10.60	21.85	33	-11.15
LTE Band 7 Channel 21350 – 20MHz – QPSK										
2560.00	79.71	224	1.2	H	5.60	0.43	10.60	15.77	33	-17.23
2560.00	81.40	226	2.5	V	11.21	0.43	10.60	21.38	33	-11.62
LTE Band 7 Channel 20850 – 20MHz – 16QAM										
2510.00	78.76	323	1.1	H	4.76	0.43	10.60	14.93	33	-18.07
2510.00	81.14	205	1.9	V	10.86	0.43	10.60	21.03	33	-11.97
LTE Band 7 Channel 21100 – 20MHz – 16QAM										
2535.00	76.47	156	1.8	H	2.47	0.43	10.60	12.64	33	-20.36
2535.00	81.55	272	1.4	V	11.27	0.43	10.60	21.44	33	-11.56
LTE Band 7 Channel 21350 – 20MHz – 16QAM										
2560.00	78.71	353	2.0	H	4.60	0.43	10.60	14.77	33	-18.23
2560.00	81.03	55	2.3	V	10.84	0.43	10.60	21.01	33	-11.99

LTE Band 12

Frequency (MHz)	Receiver Reading (dBμV)	Turn table Angle Degree	RX Antenna		Substituted			Absolute Level (dBm)	Part 27	
			Height (m)	Polar (H/V)	SG Level (dBm)	Cable (dB)	Antenna Gain (dB)		Limit (dBm)	Margin (dB)
LTE Band 12 Channel 23017 – 1.4MHz – QPSK										
699.70	86.34	227	1.3	H	15.34	0.20	0.00	15.14	34.77	-19.63
699.70	92.14	7	2.3	V	19.86	0.20	0.00	19.66	34.77	-15.11
LTE Band 12 Channel 23095 – 1.4MHz – QPSK										
707.50	86.52	185	1.9	H	15.52	0.20	0.00	15.32	34.77	-19.45
707.50	92.47	209	2.2	V	20.19	0.20	0.00	19.99	34.77	-14.78
LTE Band 12 Channel 23173 – 1.4MHz – QPSK										
715.30	87.92	197	1.7	H	16.92	0.20	0.00	16.72	34.77	-18.05
715.30	92.76	302	1.1	V	20.48	0.20	0.00	20.28	34.77	-14.49
LTE Band 12 Channel 23017 – 1.4MHz – 16QAM										
699.70	86.36	132	1.7	H	15.36	0.20	0.00	15.16	34.77	-19.61
699.70	92.07	54	2.0	V	19.79	0.20	0.00	19.59	34.77	-15.18
LTE Band 12 Channel 23095 – 1.4MHz – 16QAM										
707.50	86.70	72	2.0	H	15.70	0.20	0.00	15.50	34.77	-19.27
707.50	92.67	144	1.9	V	20.39	0.20	0.00	20.19	34.77	-14.58
LTE Band 12 Channel 23173 – 1.4MHz – 16QAM										
715.30	87.31	94	1.4	H	16.31	0.20	0.00	16.11	34.77	-18.66
715.30	92.81	111	1.6	V	20.53	0.20	0.00	20.33	34.77	-14.44
LTE Band 12 Channel 23025 – 3MHz – QPSK										
700.50	84.16	321	1.4	H	13.16	0.20	0.00	12.96	34.77	-21.81
700.50	92.48	312	1.4	V	20.20	0.20	0.00	20.00	34.77	-14.77
LTE Band 12 Channel 23095 – 3MHz – QPSK										
707.50	86.50	262	2.4	H	15.50	0.20	0.00	15.30	34.77	-19.47
707.50	92.78	327	2.1	V	20.50	0.20	0.00	20.30	34.77	-14.47
LTE Band 12 Channel 23165 – 3MHz – QPSK										
714.50	85.05	233	1.9	H	14.05	0.20	0.00	13.85	34.77	-20.92
714.50	92.74	249	1.7	V	20.46	0.20	0.00	20.26	34.77	-14.51
LTE Band 12 Channel 23025 – 3MHz – 16QAM										
700.50	87.19	67	1.0	H	16.19	0.20	0.00	15.99	34.77	-18.78
700.50	92.24	317	1.5	V	19.96	0.20	0.00	19.76	34.77	-15.01
LTE Band 12 Channel 23095 – 3MHz – 16QAM										
707.50	86.54	88	1.5	H	15.54	0.20	0.00	15.34	34.77	-19.43
707.50	93.35	161	2.5	V	21.07	0.20	0.00	20.87	34.77	-13.90
LTE Band 12 Channel 23165 – 3MHz – 16QAM										
714.50	84.03	261	1.7	H	13.03	0.20	0.00	12.83	34.77	-21.94
714.50	93.05	337	1.8	V	20.77	0.20	0.00	20.57	34.77	-14.20
LTE Band 12 Channel 23035 – 5MHz – QPSK										
701.50	86.78	44	1.5	H	15.78	0.20	0.00	15.58	34.77	-19.19
701.50	92.97	285	1.5	V	20.69	0.20	0.00	20.49	34.77	-14.28
LTE Band 12 Channel 23095 – 5MHz – QPSK										
707.50	84.63	64	1.5	H	13.63	0.20	0.00	13.43	34.77	-21.34

707.50	92.75	7	1.4	V	20.47	0.20	0.00	20.27	34.77	-14.50
LTE Band 12 Channel 23155 – 5MHz – QPSK										
713.50	84.70	357	1.4	H	13.70	0.20	0.00	13.50	34.77	-21.27
713.50	92.49	294	2.1	V	20.21	0.20	0.00	20.01	34.77	-14.76
LTE Band 12 Channel 23035 – 5MHz – 16QAM										
701.50	86.67	27	2.4	H	15.67	0.20	0.00	15.47	34.77	-19.30
701.50	92.57	16	1.9	V	20.29	0.20	0.00	20.09	34.77	-14.68
LTE Band 12 Channel 23095 – 5MHz – 16QAM										
707.50	86.23	95	1.6	H	15.23	0.20	0.00	15.03	34.77	-19.74
707.50	92.45	92	1.5	V	20.17	0.20	0.00	19.97	34.77	-14.80
LTE Band 12 Channel 23155 – 5MHz – 16QAM										
713.50	85.32	174	1.6	H	14.32	0.20	0.00	14.12	34.77	-20.65
713.50	92.39	59	1.5	V	20.11	0.20	0.00	19.91	34.77	-14.86
LTE Band 12 Channel 23060 – 10MHz – QPSK										
704.00	84.88	99	1.6	H	13.88	0.20	0.00	13.68	34.77	-21.09
704.00	92.39	254	2.4	V	20.11	0.20	0.00	19.91	34.77	-14.86
LTE Band 12 Channel 23095 – 10MHz – QPSK										
707.50	84.65	311	2.0	H	13.65	0.20	0.00	13.45	34.77	-21.32
707.50	92.16	215	1.8	V	19.88	0.20	0.00	19.68	34.77	-15.09
LTE Band 12 Channel 23130 – 10MHz – QPSK										
711.00	84.95	156	1.2	H	13.95	0.20	0.00	13.75	34.77	-21.02
711.00	92.83	309	1.3	V	20.55	0.20	0.00	20.35	34.77	-14.42
LTE Band 12 Channel 23060 – 10MHz – 16QAM										
704.00	85.61	188	2.1	H	14.61	0.20	0.00	14.41	34.77	-20.36
704.00	92.11	271	1.6	V	19.83	0.20	0.00	19.63	34.77	-15.14
LTE Band 12 Channel 23095 – 10MHz – 16QAM										
707.50	87.16	257	1.6	H	16.16	0.20	0.00	15.96	34.77	-18.81
707.50	93.23	259	1.8	V	20.95	0.20	0.00	20.75	34.77	-14.02
LTE Band 12 Channel 23130 – 10MHz – 16QAM										
711.00	85.61	191	1.8	H	14.61	0.20	0.00	14.41	34.77	-20.36
711.00	93.77	260	1.1	V	21.49	0.20	0.00	21.29	34.77	-13.48

LTE Band 17

Frequency (MHz)	Receiver Reading (dBμV)	Turn table Angle Degree	RX Antenna		Substituted			Absolute Level (dBm)	Part 27	
			Height (m)	Polar (H/V)	SG Level (dBm)	Cable (dB)	Antenna Gain (dB)		Limit (dBm)	Margin (dB)
LTE Band 17 Channel 23755 – 5MHz – QPSK										
706.50	84.86	43	1.4	H	13.86	0.20	0.00	13.66	34.77	-21.11
706.50	92.61	155	2.1	V	20.33	0.20	0.00	20.13	34.77	-14.64
LTE Band 17 Channel 23790 – 5MHz – QPSK										
710.00	87.58	323	2.2	H	16.58	0.20	0.00	16.38	34.77	-18.39
710.00	92.49	340	1.7	V	20.21	0.20	0.00	20.01	34.77	-14.76
LTE Band 17 Channel 23825 – 5MHz – QPSK										
713.50	84.29	74	2.2	H	13.29	0.20	0.00	13.09	34.77	-21.68
713.50	92.60	71	1.8	V	20.32	0.20	0.00	20.12	34.77	-14.65
LTE Band 17 Channel 23755 – 5MHz – 16QAM										
706.50	86.73	156	1.3	H	15.73	0.20	0.00	15.53	34.77	-19.24
706.50	92.59	214	1.3	V	20.31	0.20	0.00	20.11	34.77	-14.66
LTE Band 17 Channel 23790 – 5MHz – 16QAM										
710.00	85.57	43	1.2	H	14.57	0.20	0.00	14.37	34.77	-20.40
710.00	92.17	170	2.1	V	19.89	0.20	0.00	19.69	34.77	-15.08
LTE Band 17 Channel 23825 – 5MHz – 16QAM										
713.50	86.71	166	1.9	H	15.71	0.20	0.00	15.51	34.77	-19.26
713.50	92.68	140	2.2	V	20.40	0.20	0.00	20.20	34.77	-14.57
LTE Band 17 Channel 23780 – 10MHz – QPSK										
709.00	86.64	355	2.0	H	15.64	0.20	0.00	15.44	34.77	-19.33
709.00	92.71	201	1.4	V	20.43	0.20	0.00	20.23	34.77	-14.54
LTE Band 17 Channel 23790 – 10MHz – QPSK										
710.00	86.56	203	2.3	H	15.56	0.20	0.00	15.36	34.77	-19.41
710.00	92.56	158	1.2	V	20.28	0.20	0.00	20.08	34.77	-14.69
LTE Band 17 Channel 23800 – 10MHz – QPSK										
711.00	84.34	311	1.0	H	13.34	0.20	0.00	13.14	34.77	-21.63
711.00	92.61	158	1.3	V	20.33	0.20	0.00	20.13	34.77	-14.64
LTE Band 17 Channel 23780 – 10MHz – 16QAM										
709.00	84.16	101	1.6	H	13.16	0.20	0.00	12.96	34.77	-21.81
709.00	92.02	177	1.8	V	19.74	0.20	0.00	19.54	34.77	-15.23
LTE Band 17 Channel 23790 – 10MHz – 16QAM										
710.00	86.86	280	2.1	H	15.86	0.20	0.00	15.66	34.77	-19.11
710.00	93.36	111	1.1	V	21.08	0.20	0.00	20.88	34.77	-13.89
LTE Band 17 Channel 23800 – 10MHz – 16QAM										
711.00	84.10	292	1.7	H	13.10	0.20	0.00	12.90	34.77	-21.87
711.00	93.42	59	1.2	V	21.14	0.20	0.00	20.94	34.77	-13.83

9 Peak-to-Average Ratio

Test Requirement:	24.232 (d), 27.50(d)
Test Method:	N/A
Test Mode:	TX transmitting

9.1 EUT Operation

Operating Environment :

Temperature:	22.5 °C
Humidity:	52.3% RH
Atmospheric Pressure:	101.2kPa

9.2 Test Procedure

1. The EUT was connected to spectrum analyzer and system simulator via a power divider.
2. Set EUT to transmit at maximum output power.
3. When the duty cycle is less than 98%, then signal gating will be implemented on the spectrum analyzer by triggering from the system simulator.
4. Set the CCDF (Complementary Cumulative Distribution Function) option of the spectrum analyzer. Record the maximum PAPR level associated with a probability of 0.1%.

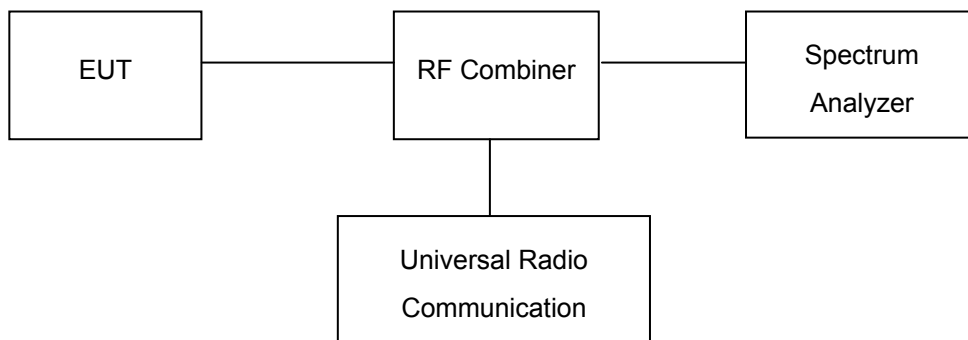

9.3 Test Result

PASS

LTE Band

Please refer to the Appendix Band 2/4/5/7/12/17 LTE Peak to Average Ratio.

10 BANDWIDTH

Test Requirement:	FCC Part 2.1049, 22.917, 22.905, 24.238, 27.53(a)
Test Method:	TIA/EIA-603-D:2010 KDB971168 D01 v02r02
Test Mode:	TX transmitting

10.1 EUT Operation

Operating Environment :

Temperature:	22.5 °C
Humidity:	52.3% RH
Atmospheric Pressure:	101.2kPa

10.2 Test Procedure

The RF output of the transmitter was connected to the wireless test set and the spectrum analyzer through sufficient attenuation.

The resolution bandwidth of the spectrum analyzer was set in the range of 1 to 5 % of the anticipated OBW and the 26 dB & 99%bandwidth was recorded.

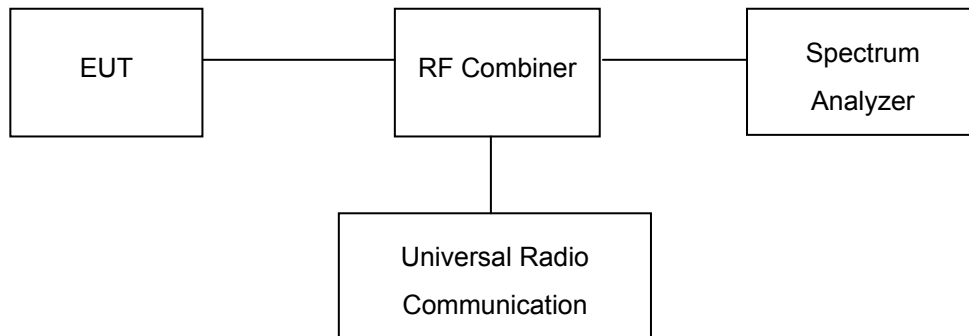

10.3 Test Result

LTE Band 2 (Part 24E):

BW(MHz)	Channel	Frequency (MHz)	Modulation	99% Occupied Bandwidth (MHz)	26 dB Bandwidth (MHz)
1.4	18607	1850.7	QPSK	1.09	1.24
			16QAM	1.09	1.25
1.4	18900	1880	QPSK	1.09	1.25
			16QAM	1.09	1.23
1.4	19193	1909.3	QPSK	1.09	1.24
			16QAM	1.09	1.26
3	18615	1851.5	QPSK	2.72	2.96
			16QAM	2.72	2.96
3	18900	1880	QPSK	2.73	2.96
			16QAM	2.73	2.97
3	19185	1908.5	QPSK	2.73	2.96
			16QAM	2.72	2.97
5	18625	1852.5	QPSK	4.5	4.88
			16QAM	4.5	4.84
5	18900	1880	QPSK	4.5	4.86
			16QAM	4.5	4.86
5	19175	1907.5	QPSK	4.49	4.85
			16QAM	4.5	4.86
10	18650	1855	QPSK	8.92	9.38
			16QAM	8.92	9.39
10	18900	1880	QPSK	8.91	9.35
			16QAM	8.92	9.36
10	19150	1905	QPSK	8.92	9.37
			16QAM	8.92	9.37
15	18675	1857.5	QPSK	13.45	14.26
			16QAM	13.45	14.26
15	18900	1880	QPSK	13.45	14.23
			16QAM	13.44	14.25
15	19125	1902.5	QPSK	13.45	14.26
			16QAM	13.45	14.27
20	18700	1860	QPSK	17.89	18.76

			16QAM	17.88	18.77
20	18900	1880	QPSK	17.88	18.75
			16QAM	17.88	18.76
20	19100	1900	QPSK	17.88	18.77
			16QAM	17.9	18.78

LTE Band 4 (Part 27):

BW(MHz)	Channel	Frequency (MHz)	Modulation	99% Occupied Bandwidth (MHz)	26 dB Bandwidth (MHz)
1.4	19957	1710.7	QPSK	1.09	1.24
			16QAM	1.09	1.25
1.4	2.175	1732.5	QPSK	1.09	1.24
			16QAM	1.09	1.23
1.4	20393	1754.3	QPSK	1.09	1.24
			16QAM	1.09	1.25
3	19965	1711.5	QPSK	2.72	2.96
			16QAM	2.72	2.96
3	2.175	1732.5	QPSK	2.72	2.96
			16QAM	2.72	2.96
3	2.385	1753.5	QPSK	2.73	2.96
			16QAM	2.72	2.96
5	19975	1712.5	QPSK	4.5	4.85
			16QAM	4.5	4.83
5	20175	1732.5	QPSK	4.5	4.84
			16QAM	4.49	4.85
5	20375	1752.5	QPSK	4.49	4.85
			16QAM	4.5	4.87
10	2000	1715	QPSK	8.93	9.39
			16QAM	8.92	9.38
10	20175	1732.5	QPSK	8.91	9.34
			16QAM	8.91	9.36
10	20350	1750	QPSK	8.93	9.37
			16QAM	8.92	9.39
15	20025	1717.5	QPSK	13.46	14.26
			16QAM	13.46	14.26
15	20175	1732.5	QPSK	13.44	14.23

			16QAM	13.43	14.24
15	20325	1747.5	QPSK	13.45	14.24
			16QAM	13.45	14.25
20	20050	1720	QPSK	17.9	18.75
			16QAM	17.9	18.76
20	20175	1732.5	QPSK	17.86	18.75
			16QAM	17.86	18.74
20	20300	1745	QPSK	17.88	18.76
			16QAM	17.89	18.74

LTE Band 5 (Part 22H):

BW(MHz)	Channel	Frequency (MHz)	Modulation	99% Occupied Bandwidth (MHz)	26 dB Bandwidth (MHz)
1.4	20407	824.7	QPSK	1.08	1.22
			16QAM	1.08	1.24
1.4	20525	836.5	QPSK	1.08	1.24
			16QAM	1.09	1.23
1.4	20643	848.3	QPSK	1.09	1.31
			16QAM	1.08	1.26
3	20415	825.5	QPSK	2.71	2.94
			16QAM	2.72	2.94
3	20525	836.5	QPSK	2.72	2.96
			16QAM	2.72	2.95
3	20635	847.5	QPSK	2.73	2.98
			16QAM	2.72	2.96
5	20425	826.5	QPSK	4.49	4.81
			16QAM	4.49	4.8
5	20525	836.5	QPSK	4.49	4.84
			16QAM	4.49	4.82
5	20625	846.5	QPSK	4.49	4.84
			16QAM	4.49	4.82
10	20450	829.0	QPSK	8.93	9.34
			16QAM	8.93	9.38
10	20525	836.5	QPSK	8.93	9.37
			16QAM	8.92	9.36
10	20600	844.0	QPSK	8.93	9.36
			16QAM	8.92	9.33

LTE Band 7 (Part 27):

BW(MHz)	Channel	Frequency (MHz)	Modulation	99% Occupied Bandwidth (MHz)	26 dB Bandwidth (MHz)
5	20775	2502.5	QPSK	4.5	4.85
			16QAM	4.5	4.83
5	21100	2535	QPSK	4.5	4.91
			16QAM	4.5	4.85
5	21425	2567.5	QPSK	4.5	4.9
			16QAM	4.5	4.87
10	20850	2510	QPSK	8.93	9.41
			16QAM	8.92	9.39
10	21100	2535	QPSK	8.92	9.37
			16QAM	8.91	9.39
10	21400	2565	QPSK	8.92	9.45
			16QAM	8.91	9.39
15	20800	2505	QPSK	13.48	14.3
			16QAM	13.47	14.27
15	21100	2535	QPSK	13.48	14.33
			16QAM	13.46	14.28
15	21375	2562.5	QPSK	13.46	14.86
			16QAM	13.44	14.29
20	20825	2507.5	QPSK	17.92	18.78
			16QAM	17.92	18.77
20	21100	2535	QPSK	17.9	18.82
			16QAM	17.89	18.8
20	21350	2560	QPSK	17.86	19.08
			16QAM	17.85	18.78

LTE Band 12 (Part 27):

BW(MHz)	Channel	Frequency (MHz)	Modulation	99% Occupied Bandwidth (MHz)	26 dB Bandwidth (MHz)
1.4	23017	699.7	QPSK	1.08	1.22
			16QAM	1.08	1.24
1.4	23095	707.5	QPSK	1.08	1.24
			16QAM	1.08	1.23
1.4	23173	715.3	QPSK	1.09	1.22
			16QAM	1.08	1.23
3	23025	700.5	QPSK	2.72	2.95
			16QAM	2.72	2.94
3	23095	707.5	QPSK	2.72	2.95
			16QAM	2.72	2.96
3	23165	714.5	QPSK	2.72	2.96
			16QAM	2.72	2.95
5	23035	701.5	QPSK	4.49	4.81
			16QAM	4.49	4.82
5	23095	707.5	QPSK	4.49	4.84
			16QAM	4.49	4.83
5	23155	713.5	QPSK	4.49	4.8
			16QAM	4.49	4.81
10	23060	704	QPSK	8.91	9.3
			16QAM	8.92	9.32
10	23095	707.5	QPSK	8.92	9.34
			16QAM	8.93	9.3
10	23130	711	QPSK	8.92	9.33
			16QAM	8.92	9.33

LTE Band 17 (Part 27)

BW(MHz)	Channel	Frequency (MHz)	Modulation	99% Occupied Bandwidth (MHz)	26 dB Bandwidth (MHz)
5	23755	706.5	QPSK	4.49	4.83
			16QAM	4.49	4.81
5	23790	710	QPSK	4.49	4.83
			16QAM	4.49	4.81
5	23825	713.5	QPSK	4.49	4.79
			16QAM	4.49	4.8
10	23780	709	QPSK	8.93	9.39
			16QAM	8.92	9.34
10	23790	710	QPSK	8.91	9.32
			16QAM	8.91	9.3
10	23800	711	QPSK	8.92	9.29
			16QAM	8.91	9.32

Test Plots
LTE Band 2 (Part 24E)

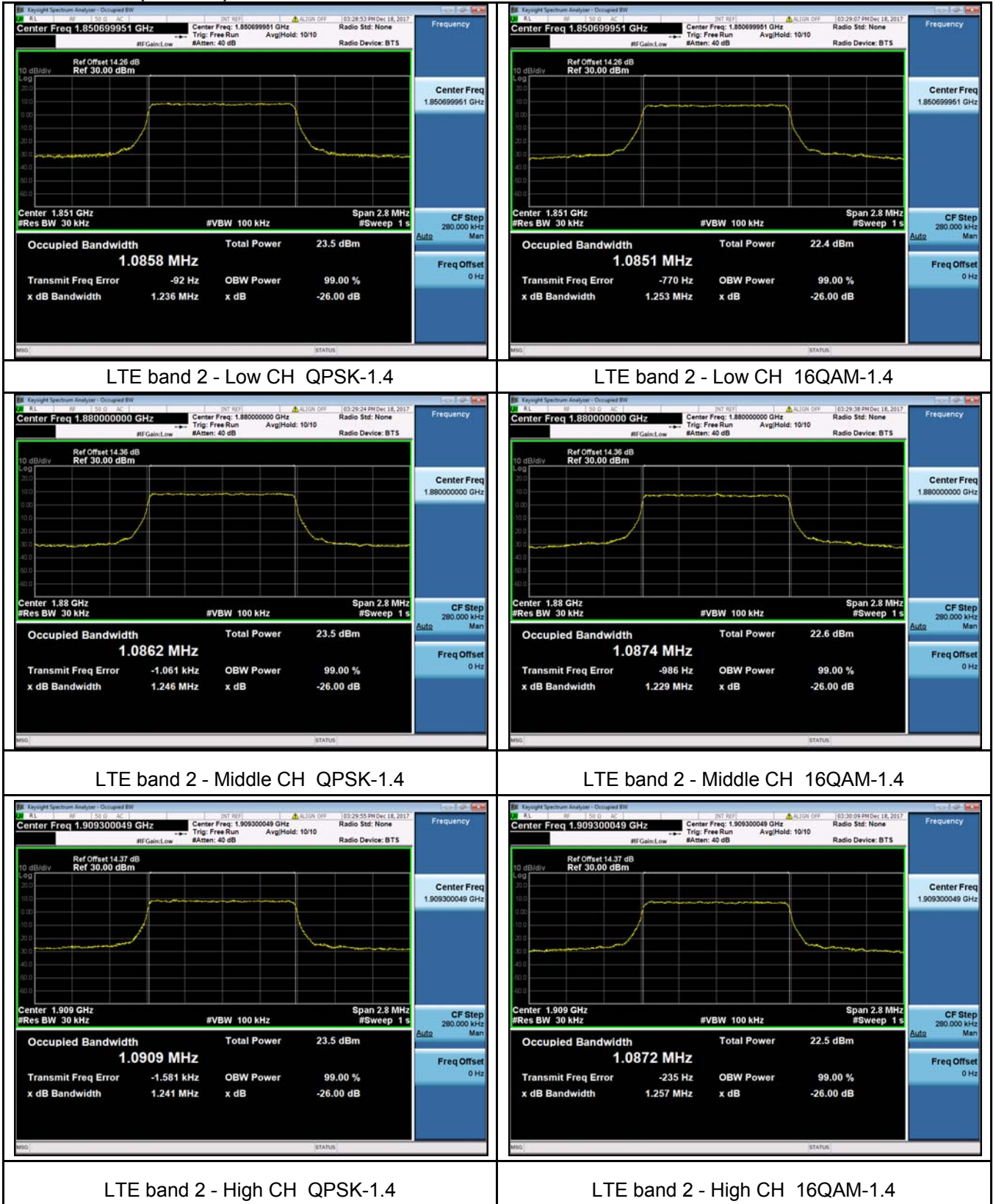



LTE band 2 - Low CH QPSK-3



LTE band 2 - Low CH 16QAM-3

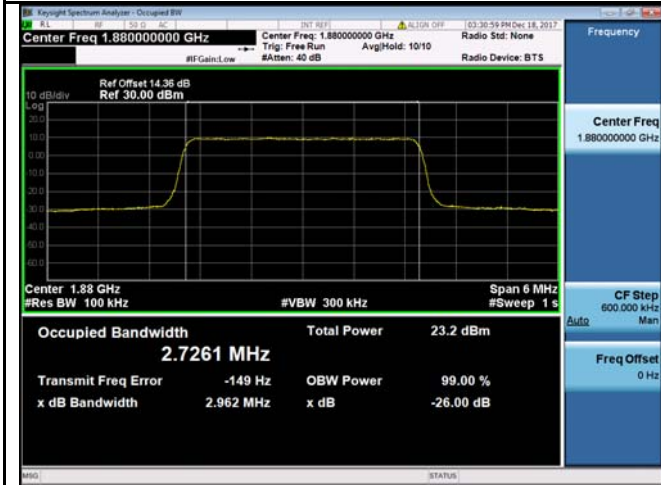

LTE band 2 - Middle CH QPSK-3

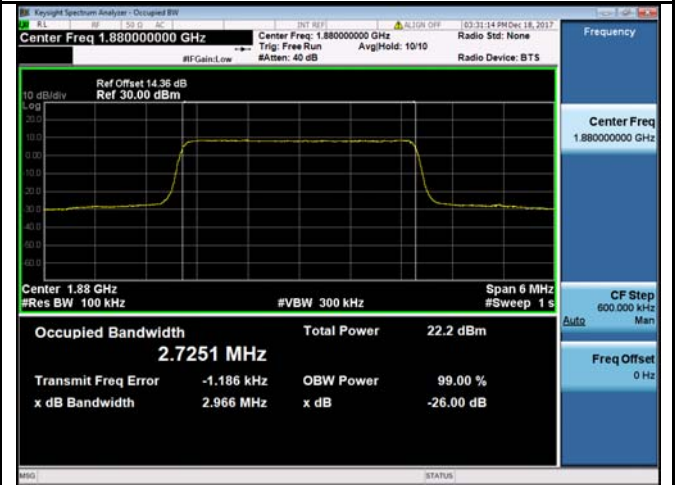

LTE band 2 - Middle CH 16QAM-3

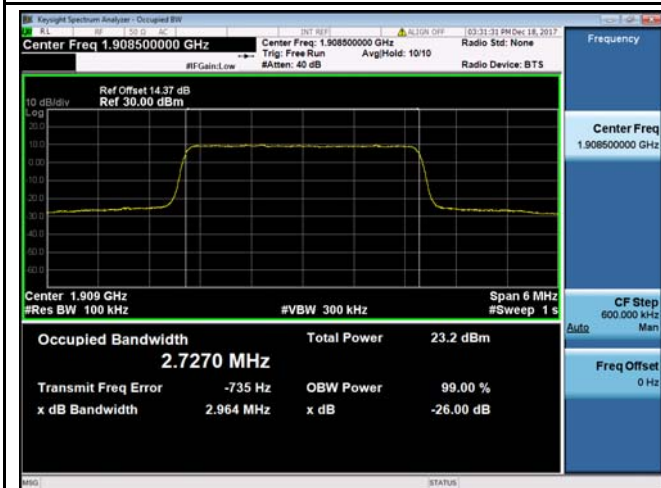

LTE band 2 - High CH QPSK-3

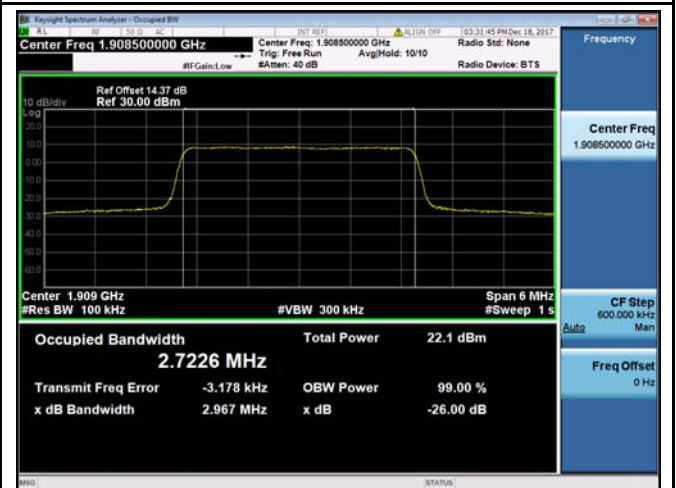

LTE band 2 - High CH 16QAM-3

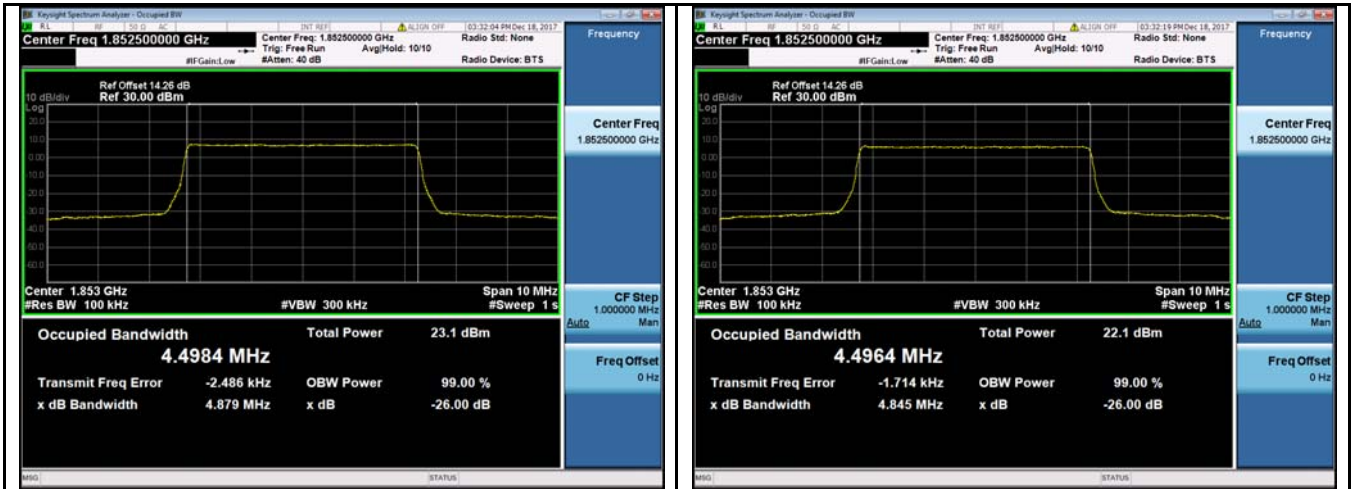

LTE band 2 - Low CH QPSK-5

LTE band 2 - Low CH 16QAM-5

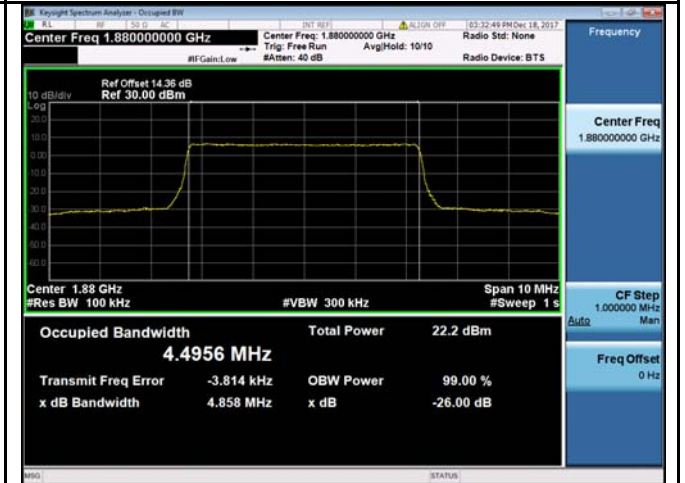

LTE band 2 - Middle CH QPSK-5

LTE band 2 - Middle CH 16QAM-5

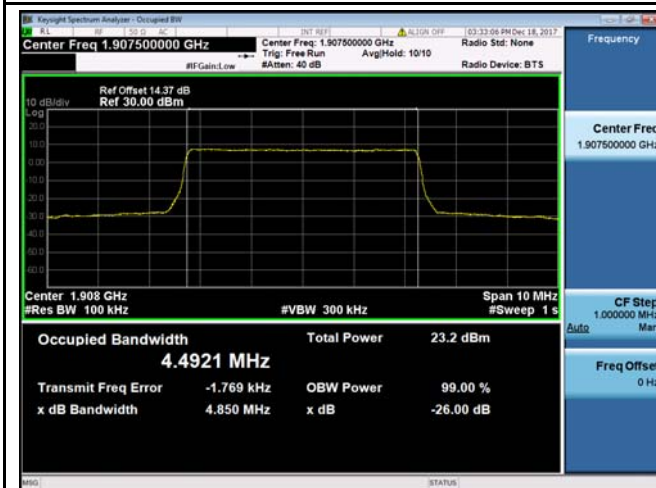

LTE band 2 - High CH QPSK-5

LTE band 2 - High CH 16QAM-5





LTE band 2 - Low CH QPSK-15

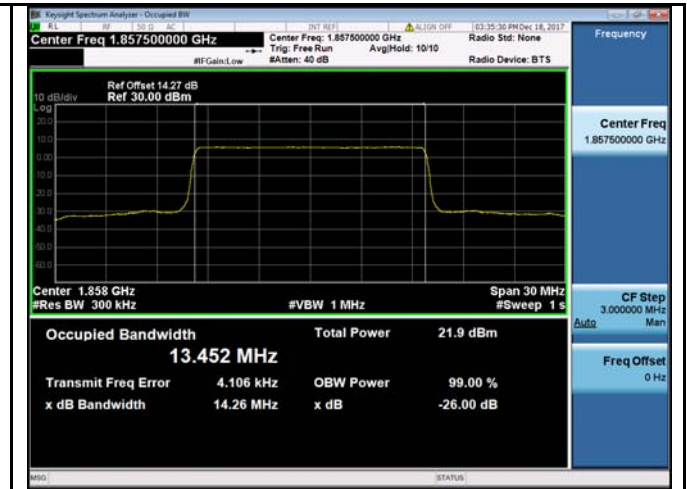

LTE band 2 - Low CH 16QAM-15

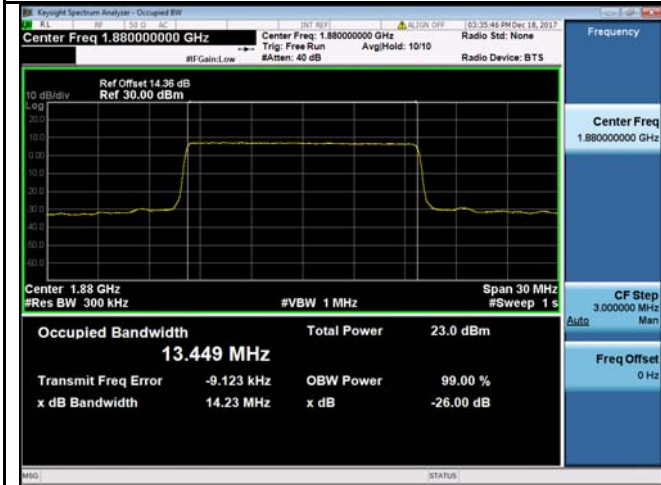

LTE band 2 - Middle CH QPSK-15

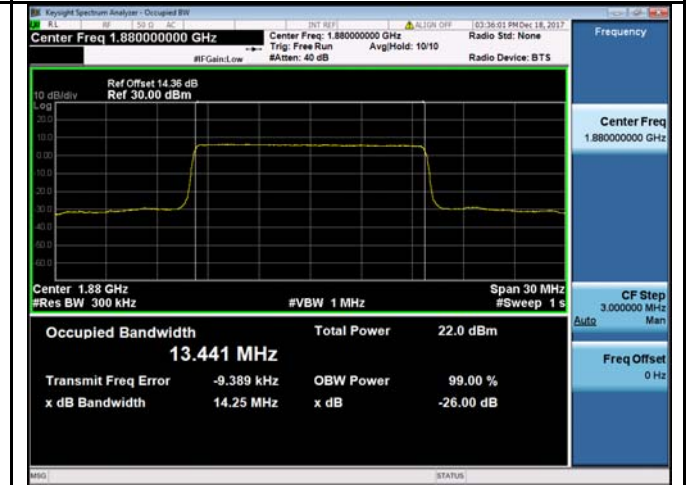

LTE band 2 - Middle CH 16QAM-15



LTE band 2 - High CH QPSK-15

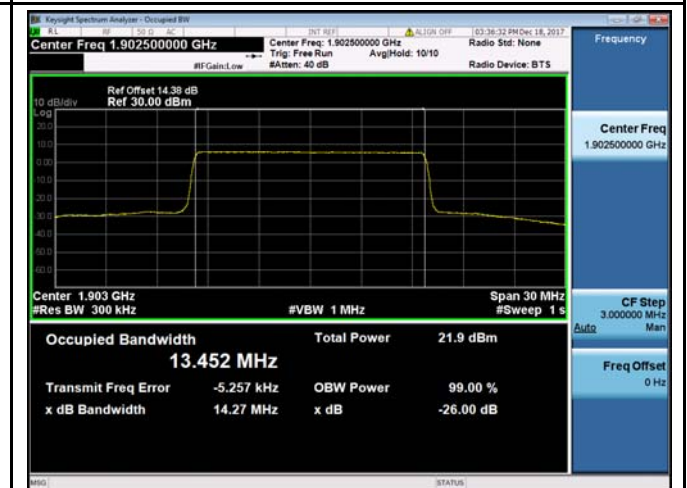

LTE band 2 - High CH 16QAM-15



LTE band 2 - Low CH QPSK-20

LTE band 2 - Low CH 16QAM-20

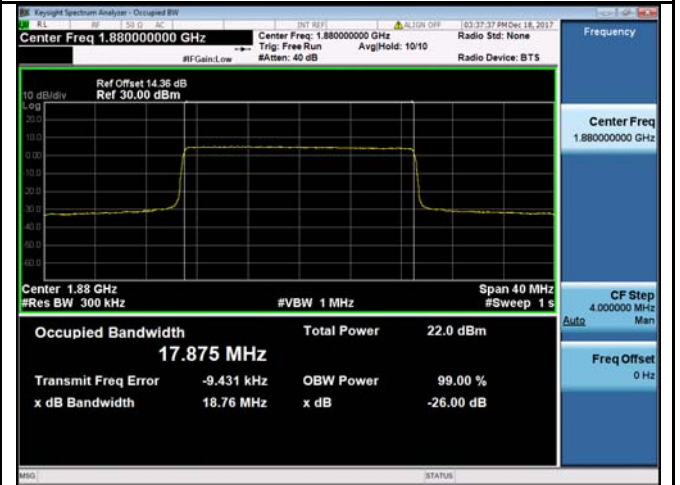
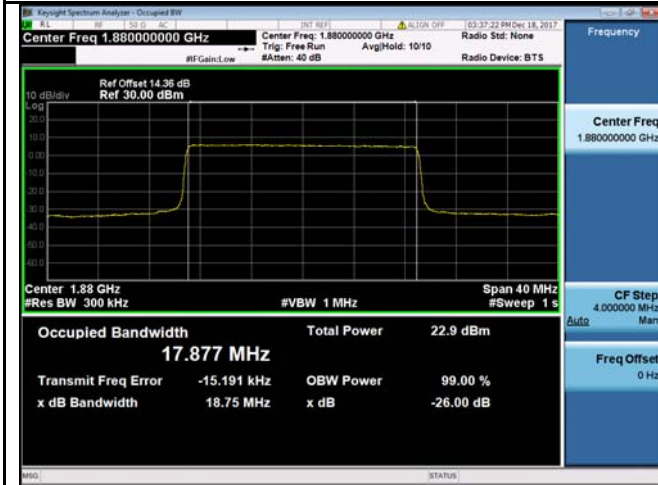

LTE band 2 - Middle CH QPSK-20

LTE band 2 - Middle CH 16QAM-20

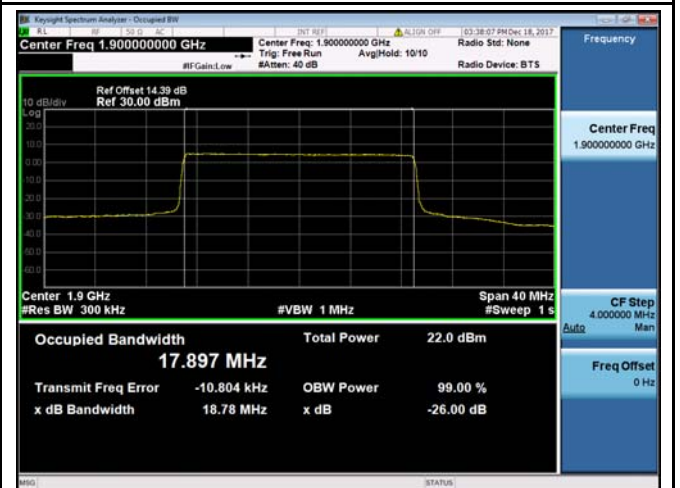
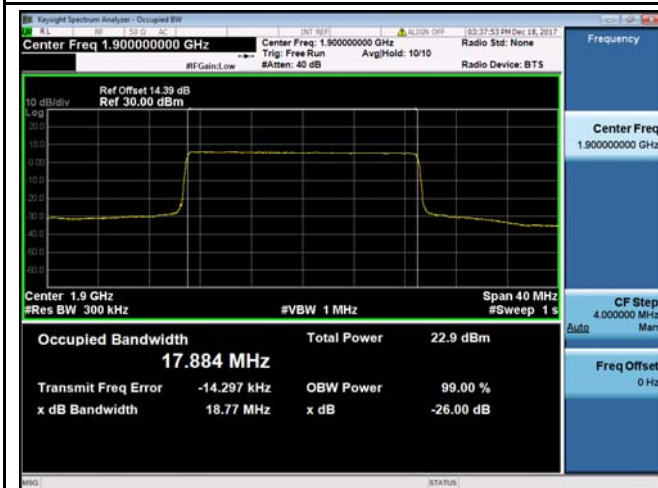

LTE band 2 - High CH QPSK-20

LTE band 2 - High CH 16QAM-20

LTE Band 4 (Part 27)

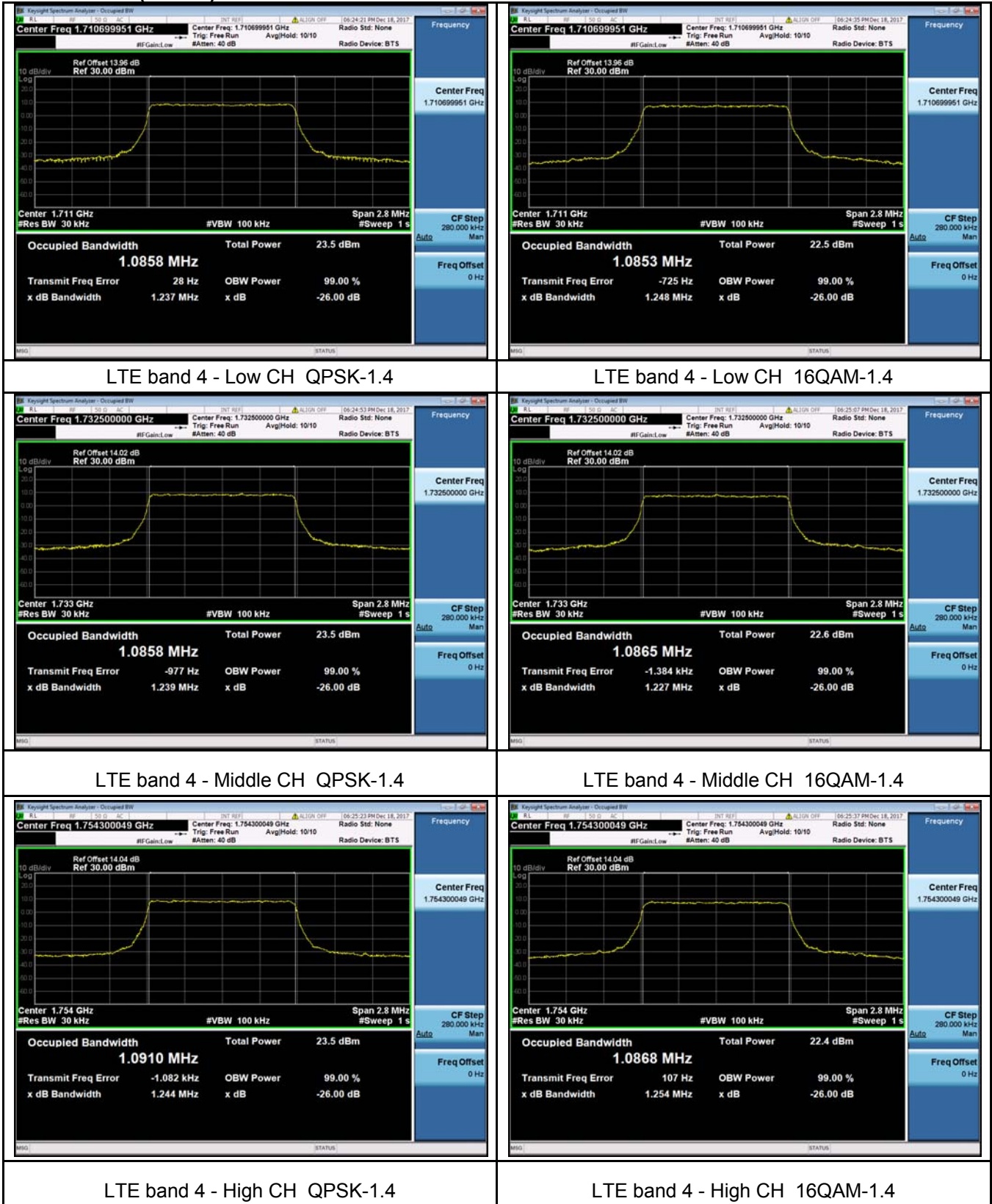

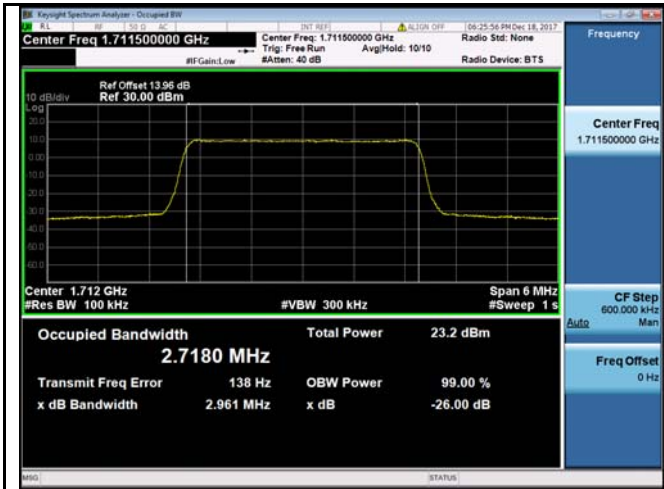

LTE band 4 - Low CH QPSK-3



LTE band 4 - Low CH 16QAM-3

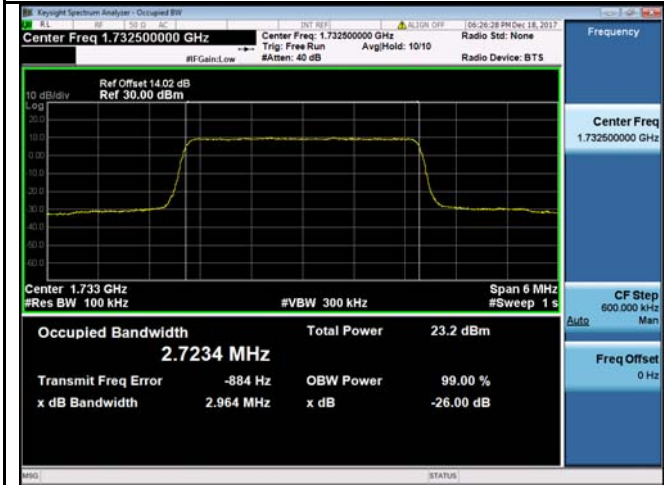

LTE band 4 - Middle CH QPSK-3

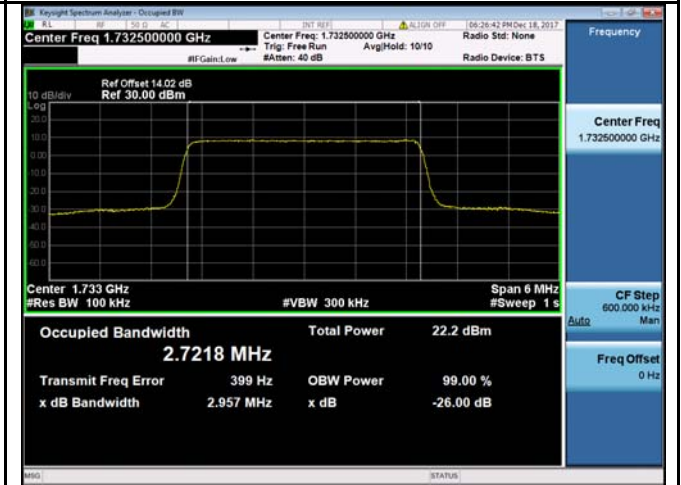

LTE band 4 - Middle CH 16QAM-3

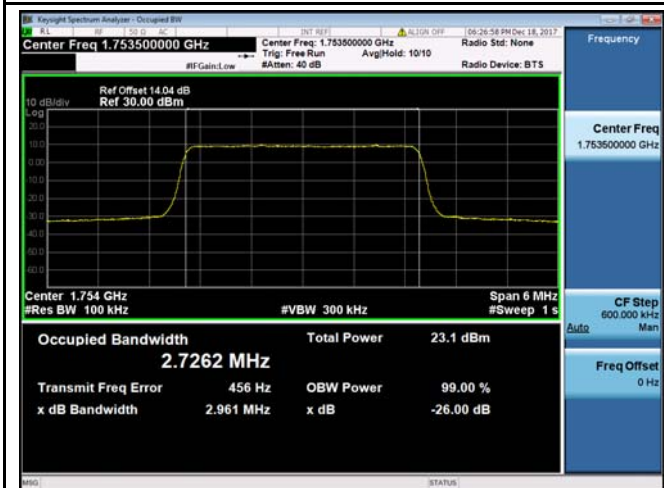

LTE band 4 - High CH QPSK-3

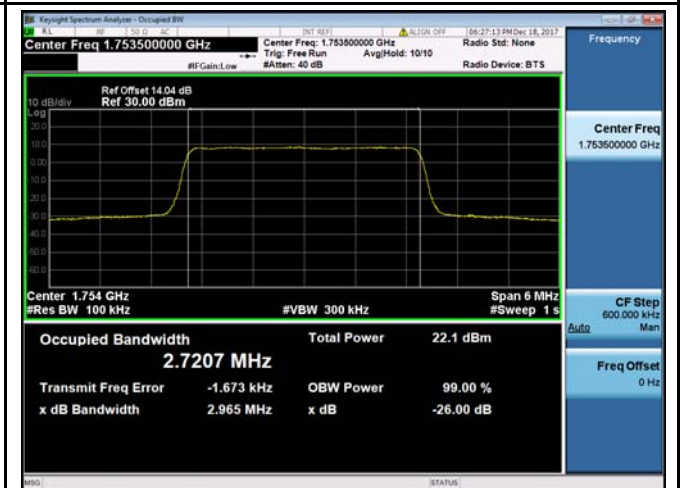

LTE band 4 - High CH 16QAM-3



LTE band 4 - Low CH QPSK-5



LTE band 4 - Low CH 16QAM-5

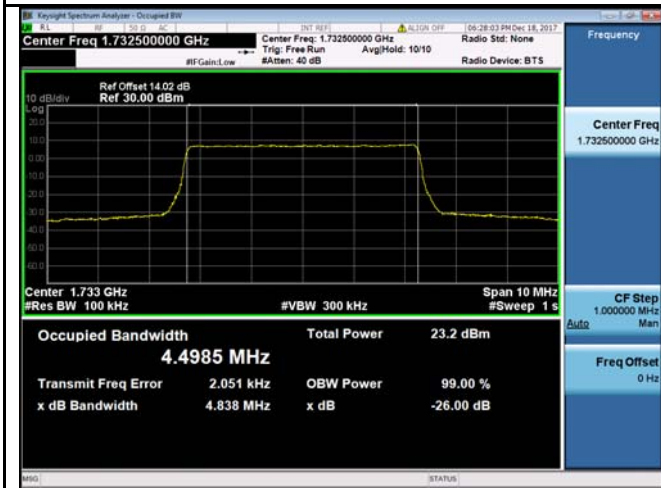

LTE band 4 - Middle CH QPSK-5

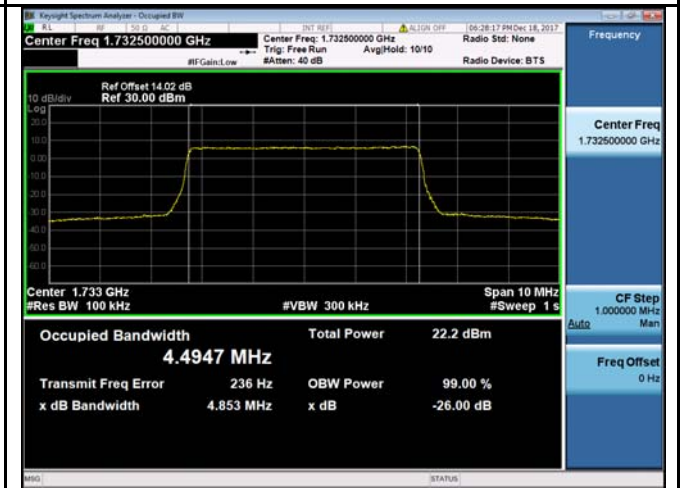

LTE band 4 - Middle CH 16QAM-5



LTE band 4 - High CH QPSK-5



LTE band 4 - High CH 16QAM-5



LTE band 4 - Low CH QPSK-10

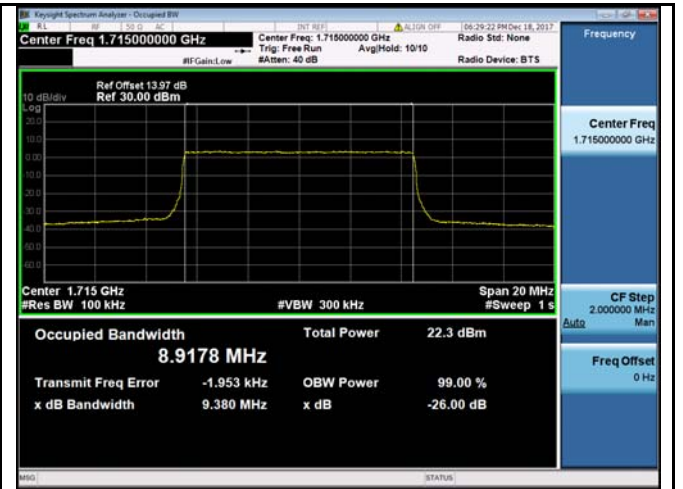

LTE band 4 - Low CH 16QAM-10



LTE band 4 - Middle CH QPSK-10

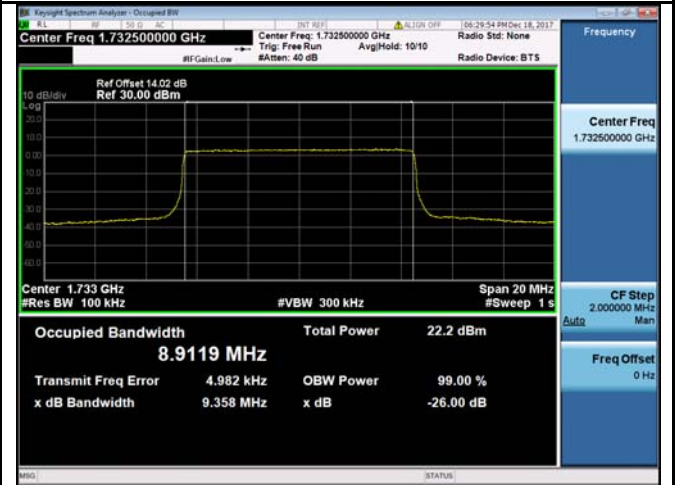

LTE band 4 - Middle CH 16QAM-10



LTE band 4 - High CH QPSK-10

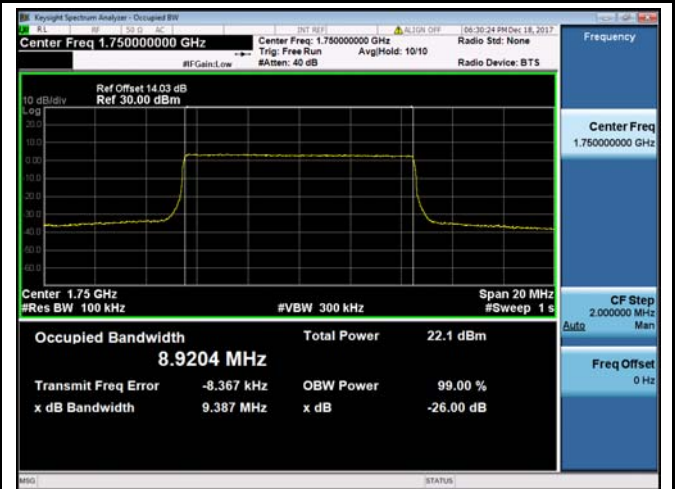

LTE band 4 - High CH 16QAM-10



LTE band 4 - Low CH QPSK-15

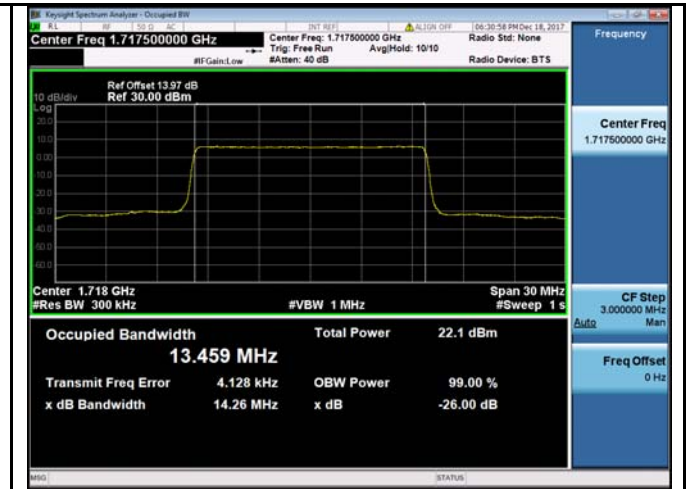

LTE band 4 - Low CH 16QAM-15

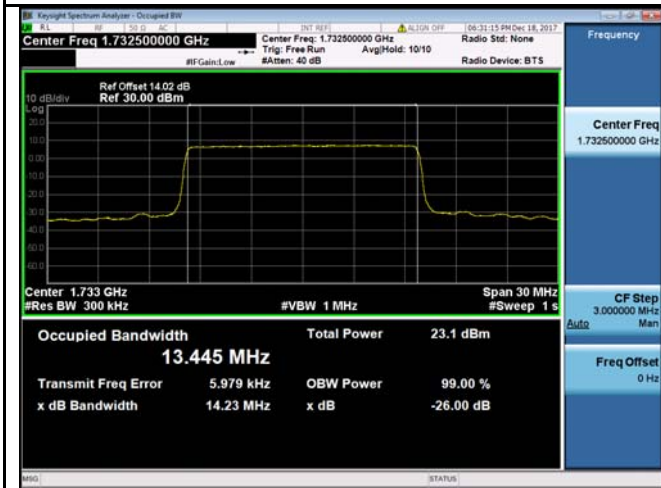

LTE band 4 - Middle CH QPSK-15

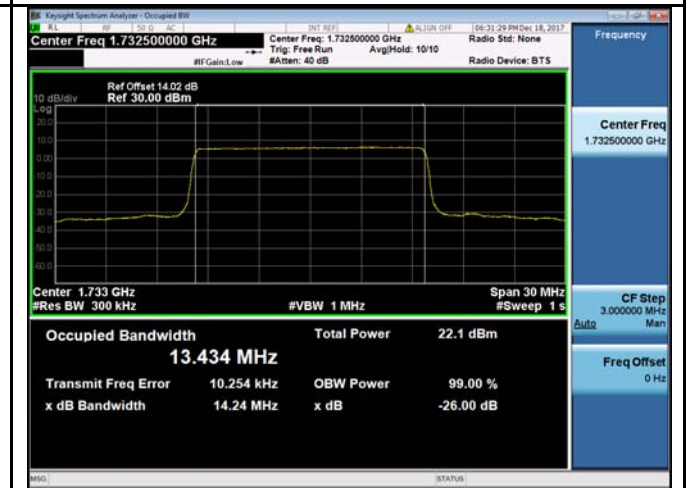

LTE band 4 - Middle CH 16QAM-15



LTE band 4 - High CH QPSK-15

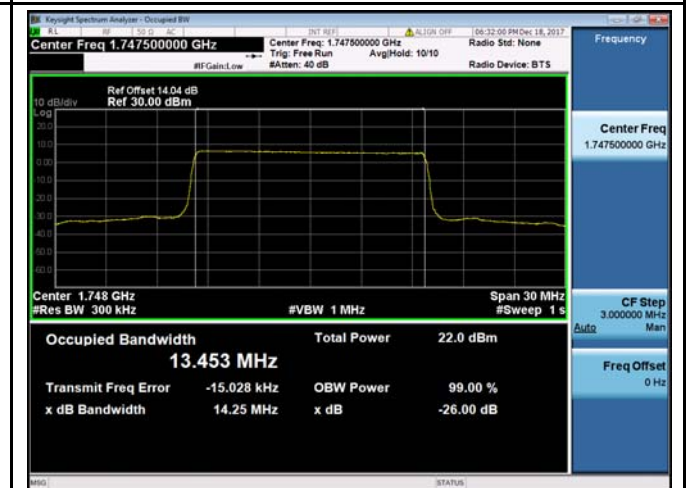

LTE band 4 - High CH 16QAM-15

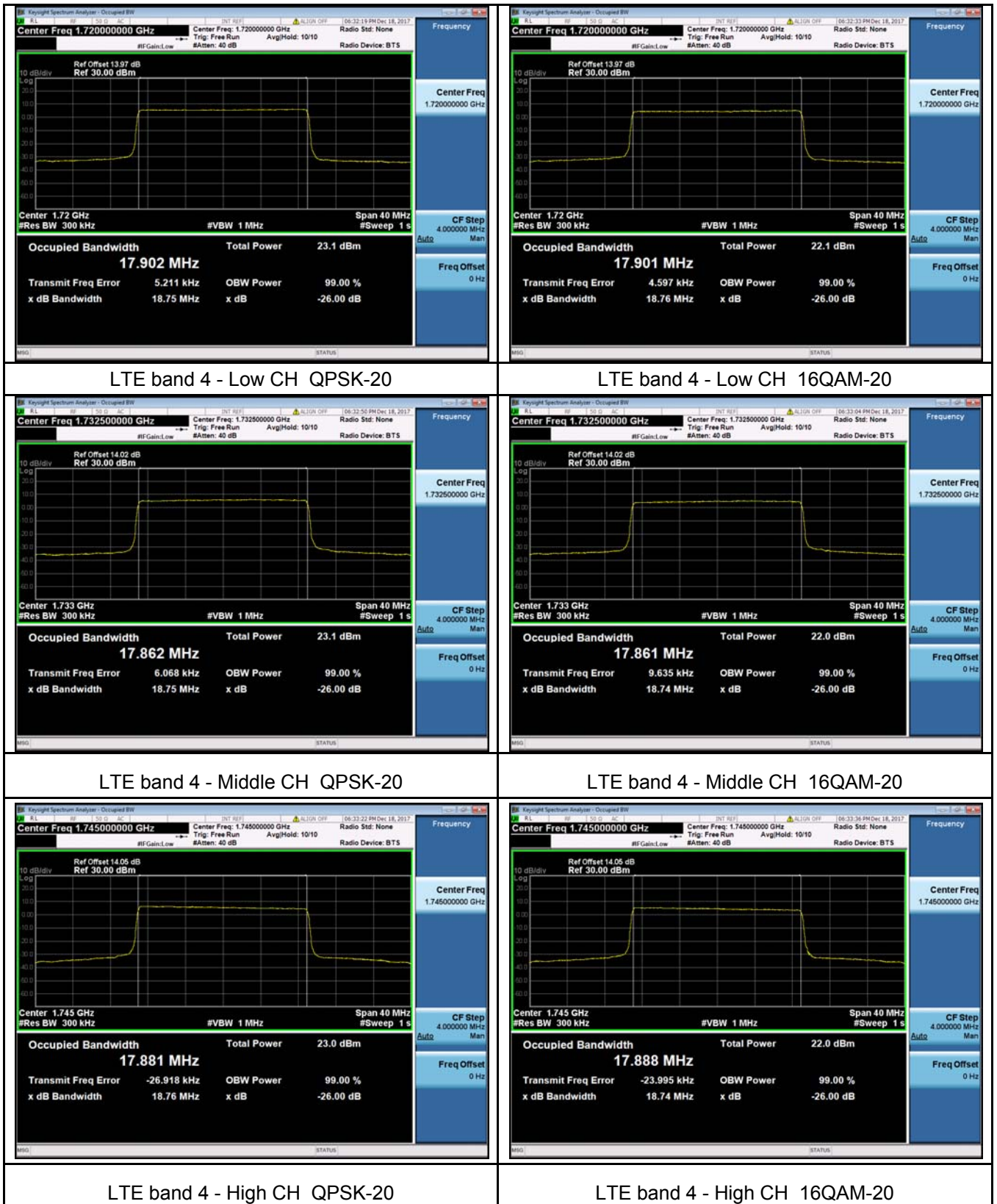

LTE Band 5 (Part 22H)

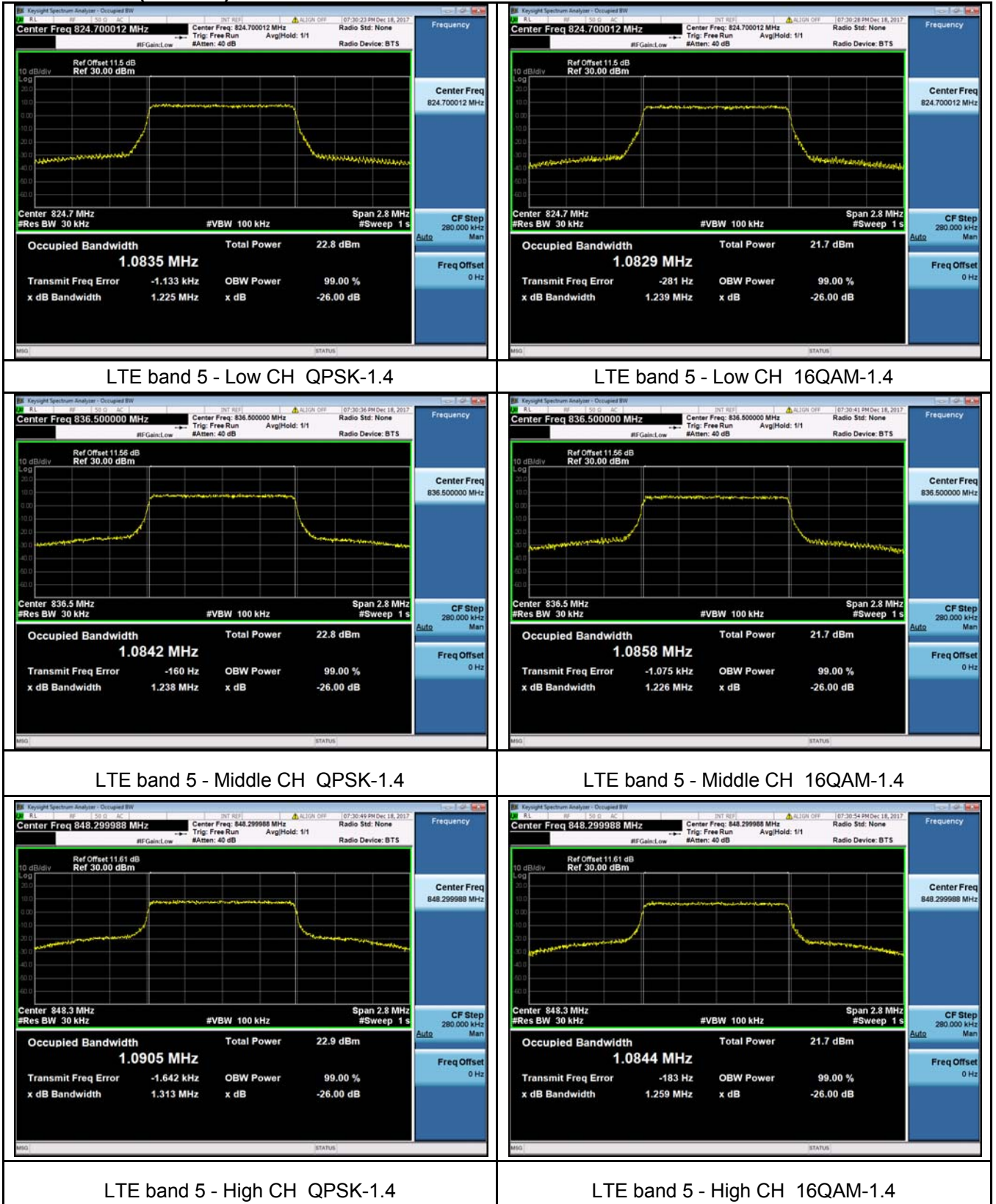

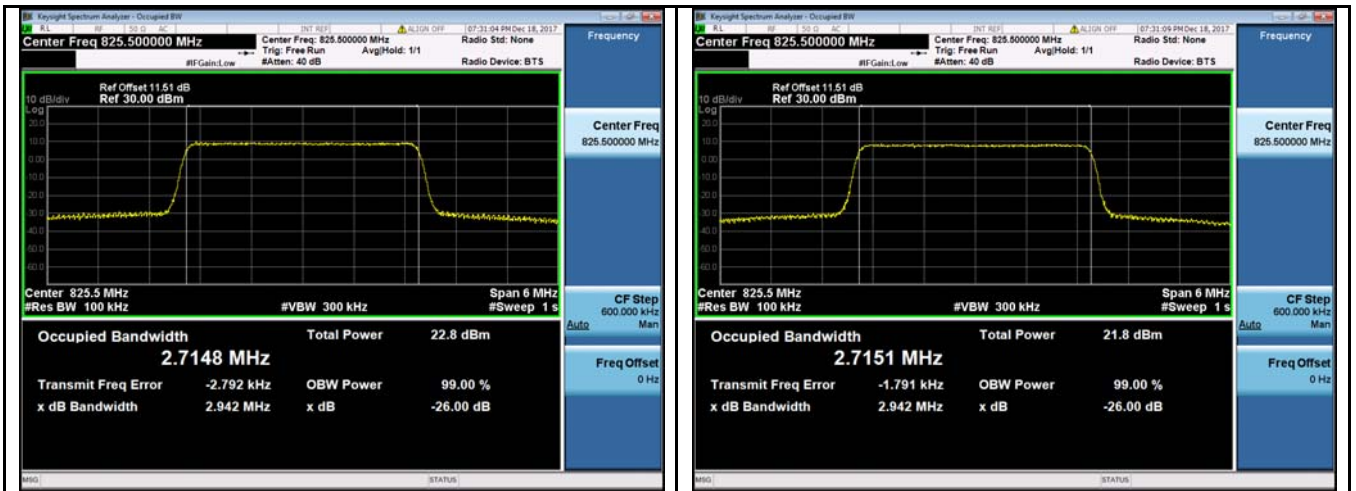

LTE band 5 - Low CH QPSK-3

LTE band 5 - Low CH 16QAM-3

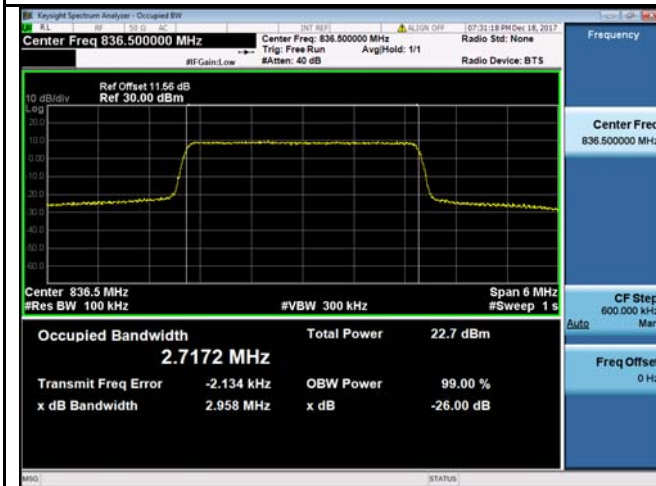

LTE band 5 - Middle CH QPSK-3

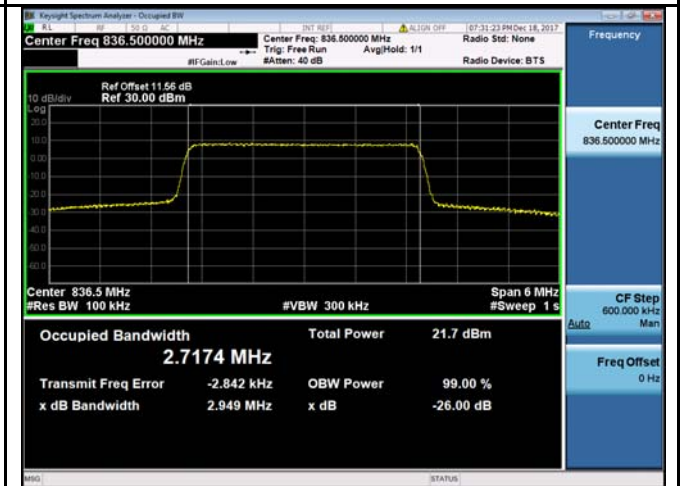

LTE band 5 - Middle CH 16QAM-3

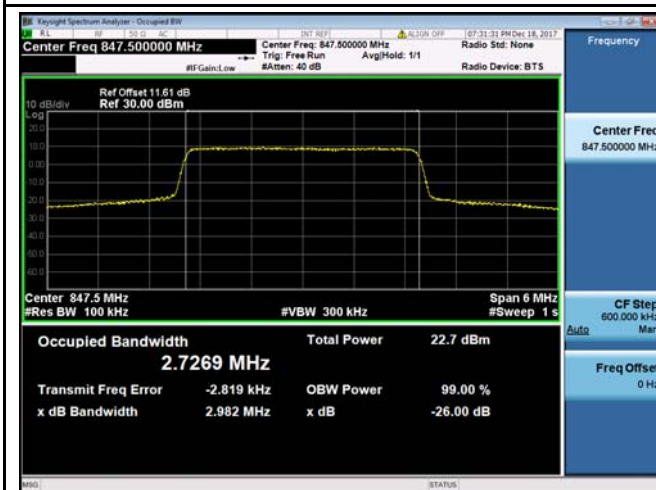

LTE band 5 - High CH QPSK-3

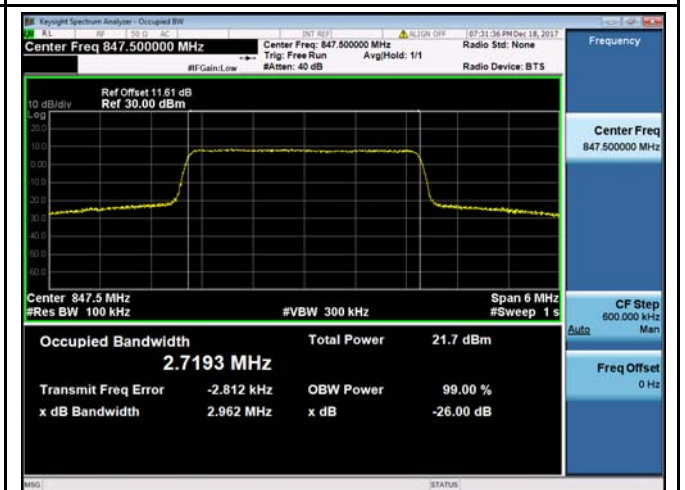

LTE band 5 - High CH 16QAM-3

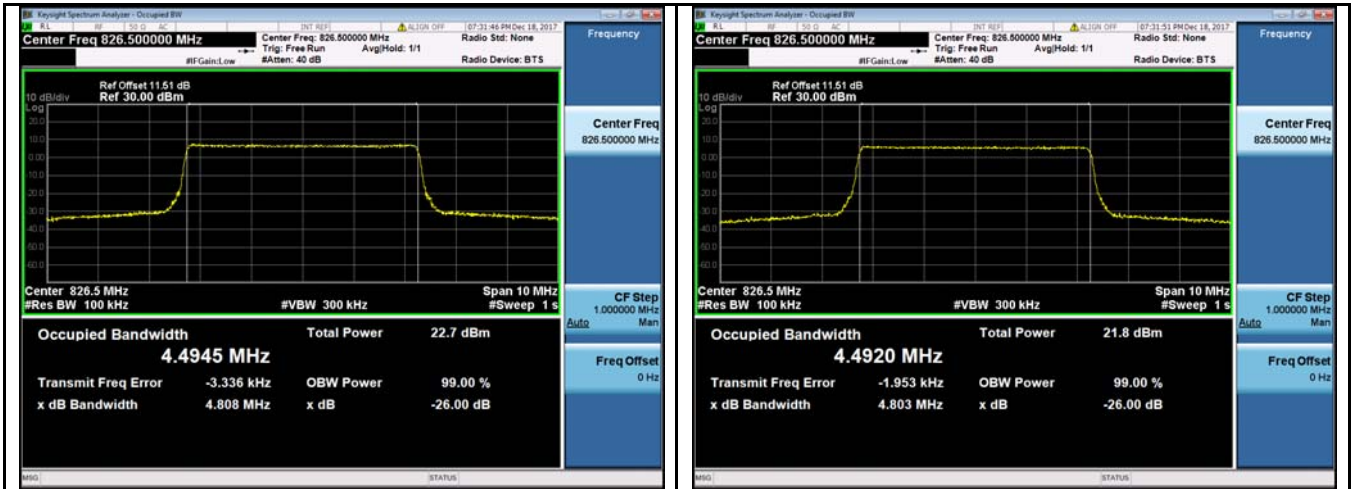

LTE band 5 - Low CH QPSK-5

LTE band 5 - Low CH 16QAM-5

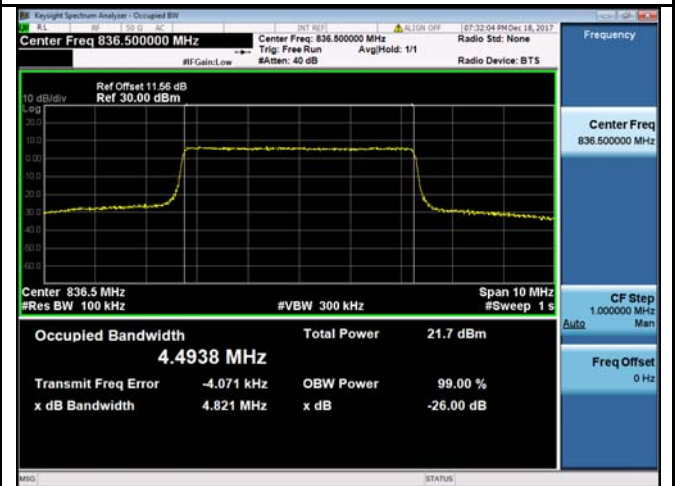

LTE band 5 - Middle CH QPSK-5

LTE band 5 - Middle CH 16QAM-5



LTE band 5 - High CH QPSK-5

LTE band 5 - High CH 16QAM-5

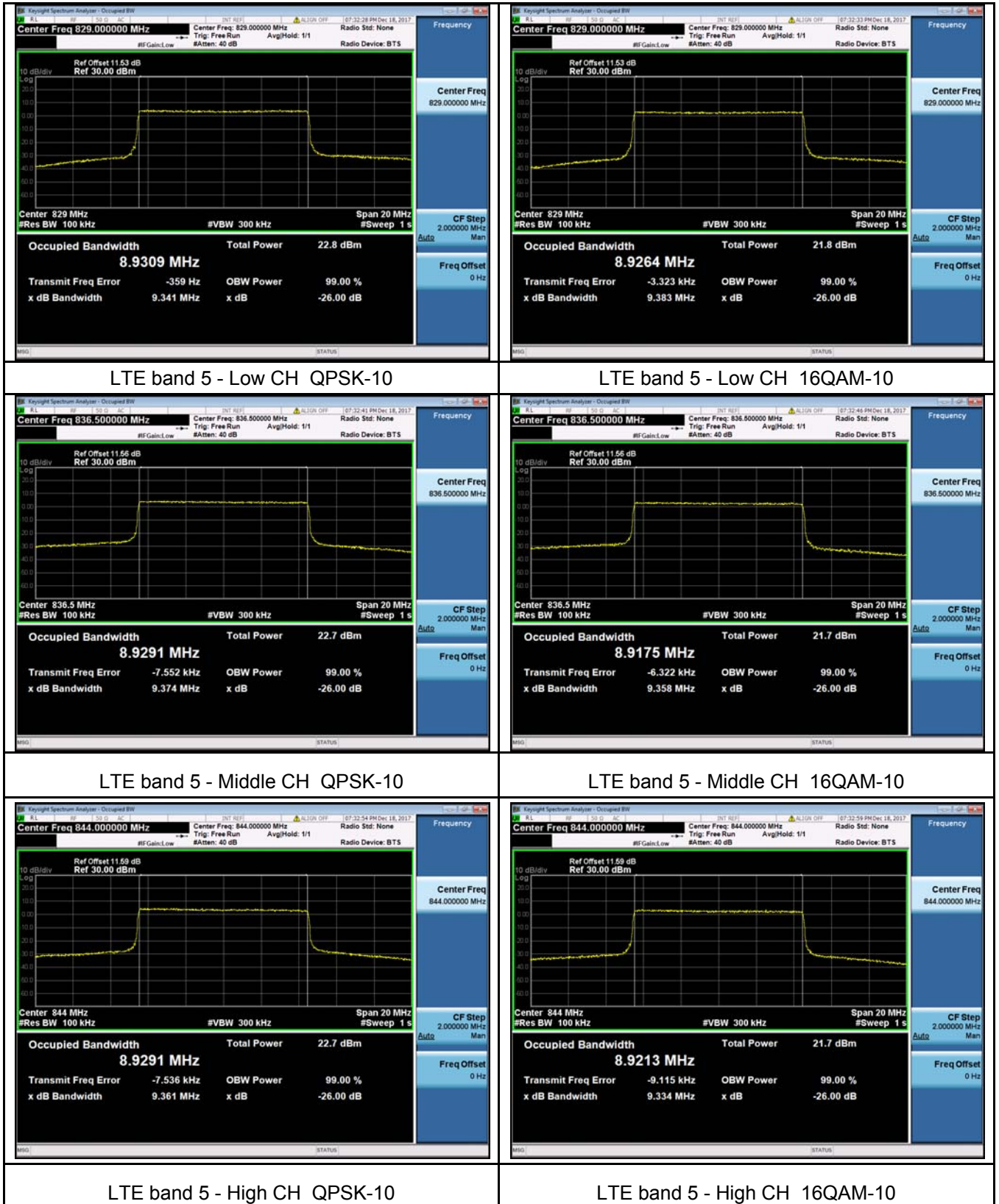

LTE Band 7 (Part 27)

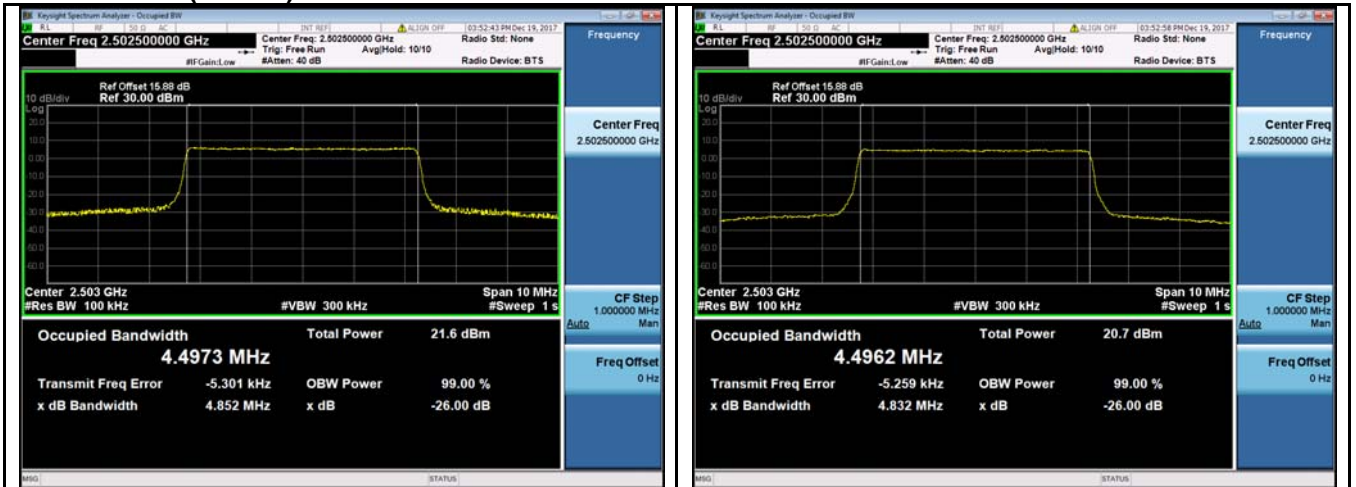

LTE band 7 - Low CH QPSK-5

LTE band 7 - Low CH 16QAM-5

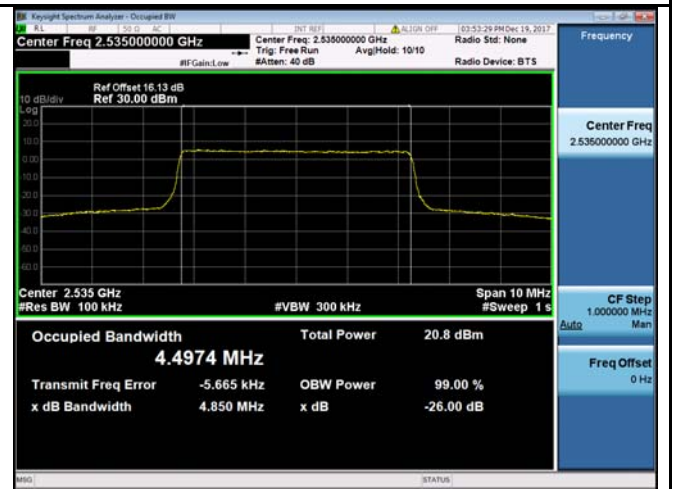
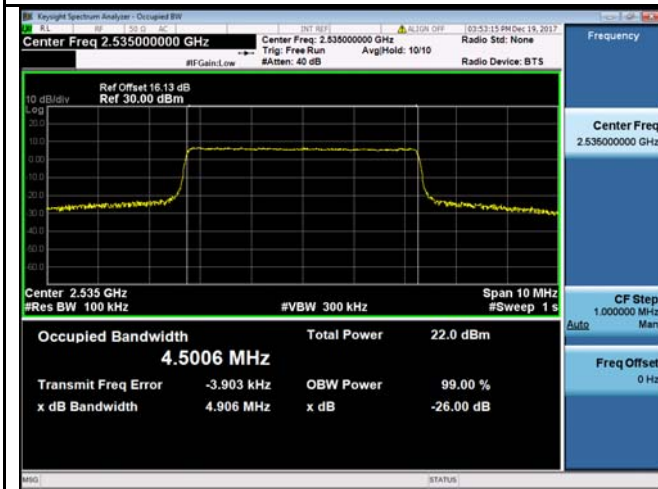

LTE band 7 - Middle CH QPSK-5

LTE band 7 - Middle CH 16QAM-5



LTE band 7 - High CH QPSK-5

LTE band 7 - High CH 16QAM-5

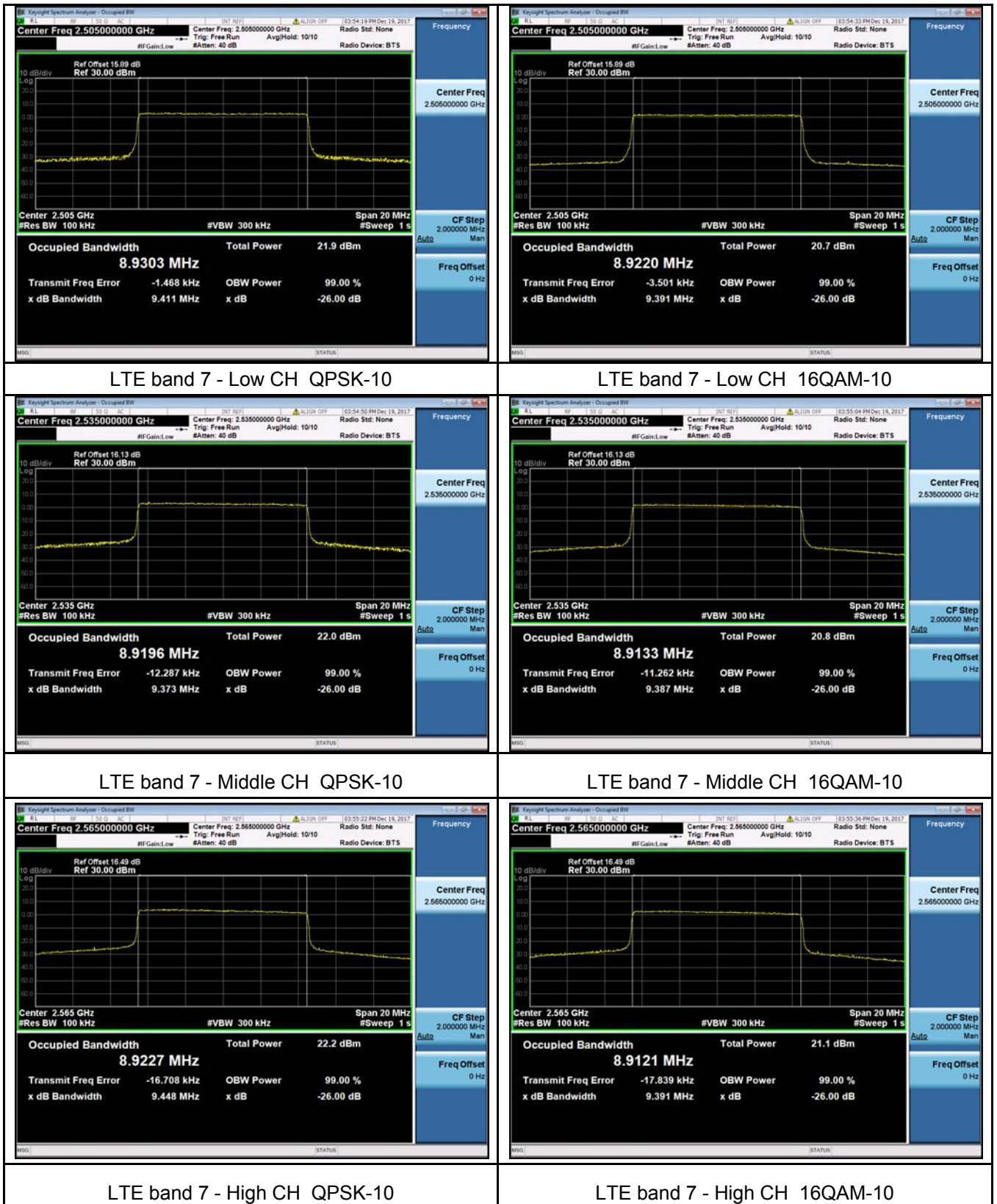

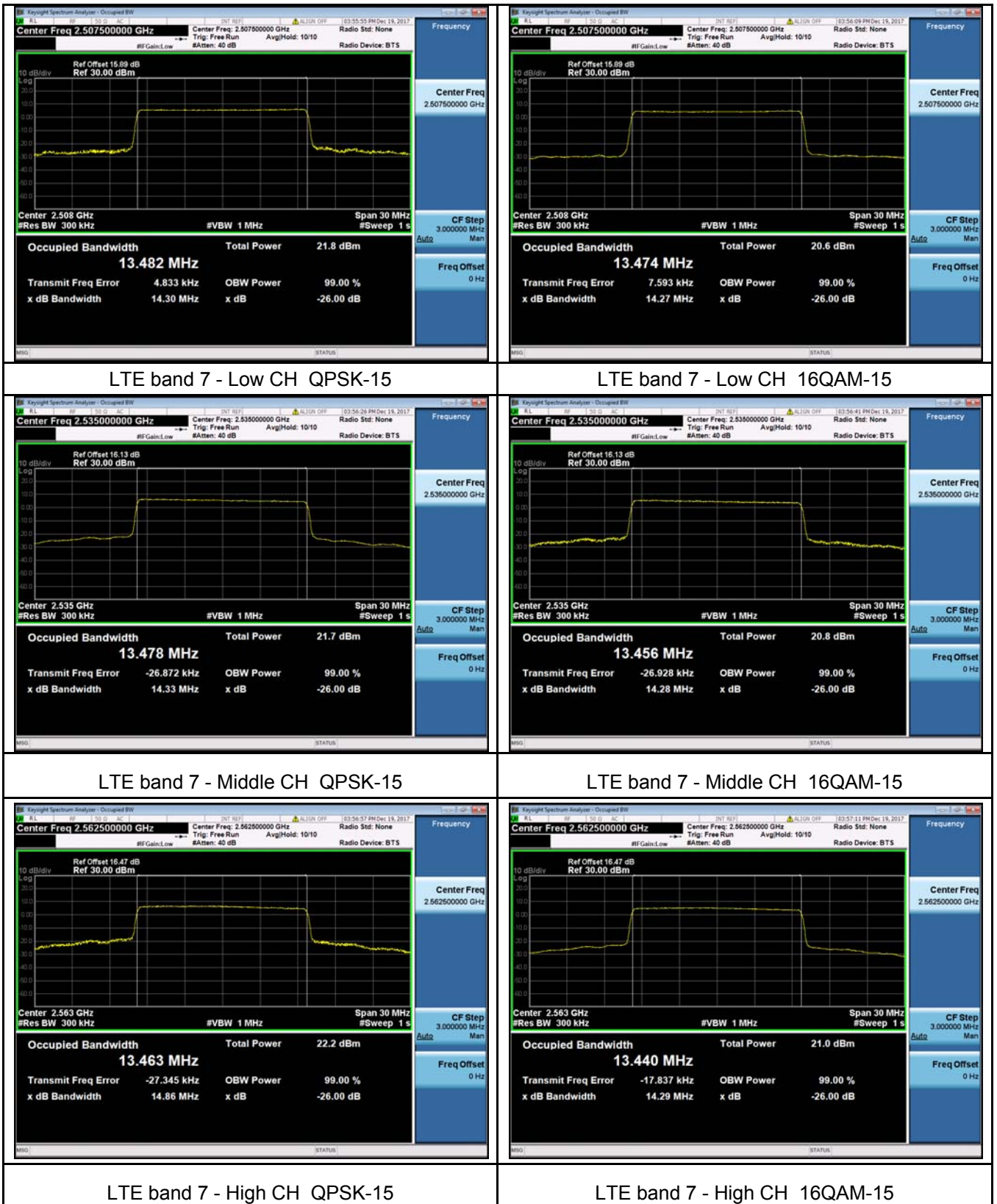



LTE band 7 - Low CH QPSK-20

LTE band 7 - Low CH 16QAM-20

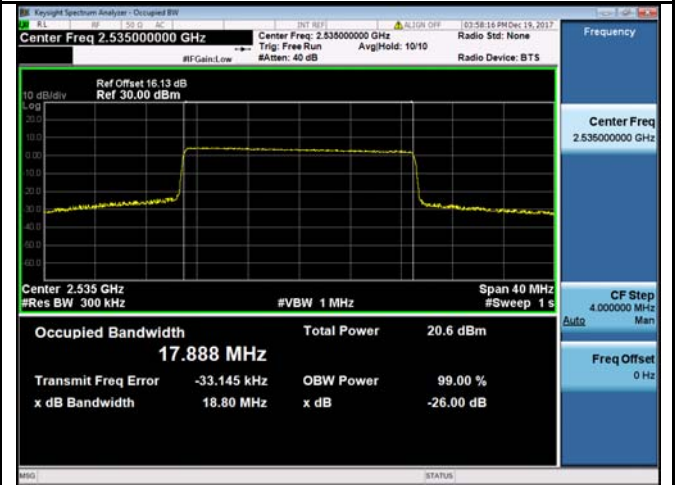

LTE band 7 - Middle CH QPSK-20

LTE band 7 - Middle CH 16QAM-20



LTE band 7 - High CH QPSK-20

LTE band 7 - High CH 16QAM-20

LTE Band 12 (Part 27)

Waltek Services (Shenzhen) Co.,Ltd.
<http://www.waltek.com.cn>

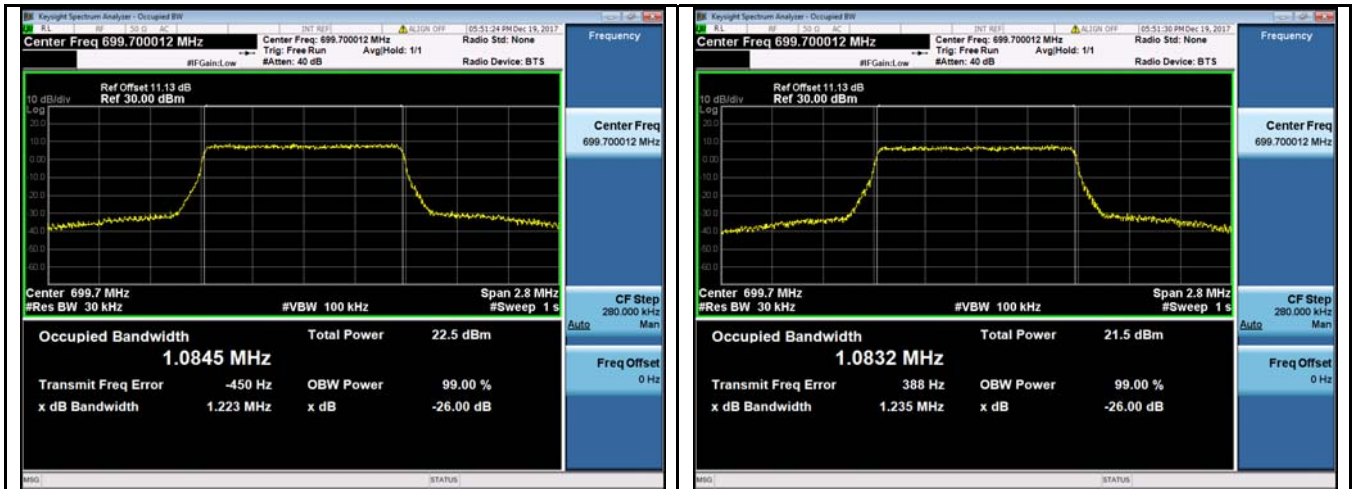

LTE band 12 - Low CH QPSK-1.4

LTE band 12 - Low CH 16QAM-1.4



LTE band 12 - Middle CH QPSK-1.4

LTE band 12 - Middle CH 16QAM-1.4

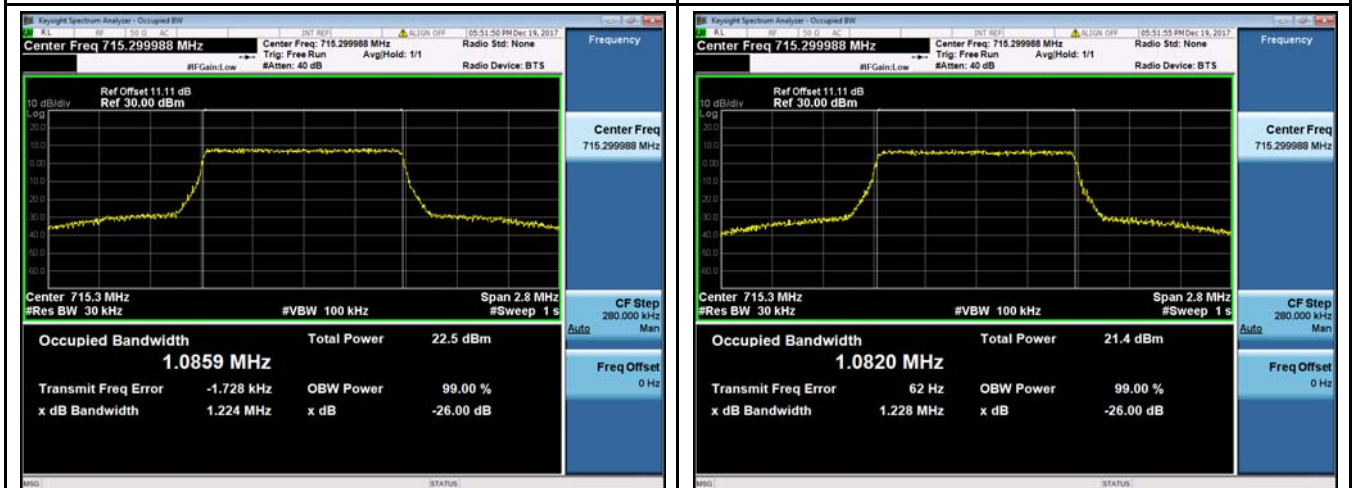

LTE band 12 - High CH QPSK-1.4

LTE band 12 - High CH 16QAM-1.4