

FCC SAR EVALUATION REPORT

In accordance with the requirements of
FCC 47 CFR Part 2(2.1093), ANSI/IEEE C95.1-1992 and
IEEE Std 1528-2013

Product Name : Tablet

Trademark : OUKITEL

Model Name : RT7 TITAN 5G

Family Model : RT7 \RT7 S\RT7 Pro\RT7 Ultra\RT7 TITAN

FCC ID : 2ANMU-RT7SPUT

Report No. : S23060602311001

Prepared for

SHENZHEN YUNJI INTELLIGENT TECHNOLOGY CO.,LTD
A2 2F BUILDING ENET NEW INDUSTRIAL PARK, DAFU
INDUSTRIAL ZONE, GUANLAN, LONGHUA, SHENZHEN CHINA

Prepared by

Shenzhen NTEK Testing Technology Co., Ltd.
1&5/F, Building C, 1&2/F, Building E, Fenda Science Park, Sanwei Community,
Hangcheng Street, Baoan District, Shenzhen ,Guangdong, China
Tel. 400-800-6106, 0755-2320 0050, 0755-2320 0090
Website: <http://www.ntek.org.cn>

TEST RESULT CERTIFICATION

Applicant's name.....: SHENZHEN YUNJI INTELLIGENT TECHNOLOGY CO.,LTD
Address.....: A2 2F BUILDING ENET NEW INDUSTRIAL PARK, DAFU INDUSTRIAL ZONE, GUANLAN, LONGHUA, SHENZHEN CHINA
Manufacturer's Name.....: SHENZHEN YUNJI INTELLIGENT TECHNOLOGY CO.,LTD
Address.....: A2 2F BUILDING ENET NEW INDUSTRIAL PARK, DAFU INDUSTRIAL ZONE, GUANLAN, LONGHUA, SHENZHEN CHINA

Product description

Product name.....: Tablet
Trademark.....: OUKITEL
Model Name.....: RT7 TITAN 5G
Family Model.....: RT7 \RT7 S\RT7 Pro\RT7 Ultra\RT7 TITAN

Standards.....: FCC 47 CFR Part 2(2.1093);
ANSI/IEEE C95.1-1992
IEEE Std 1528-2013;
Published RF exposure KDB procedures

This device described above has been tested by Shenzhen NTEK. In accordance with the measurement methods and procedures specified in IEEE Std 1528-2013 and KDB 865664 D01. Testing has shown that this device is capable of compliance with localized specific absorption rate (SAR) specified in FCC 47 CFR Part 2(2.1093) and ANSI/IEEE C95.1-1992. The test results in this report apply only to the tested sample of the stated device/equipment. Other similar device/equipment will not necessarily produce the same results due to production tolerance and measurement uncertainties.

This report shall not be reproduced except in full, without the written approval of Shenzhen NTEK, this document may be altered or revised by Shenzhen NTEK, personal only, and shall be noted in the revision of the document.

Test Sample Number..... S230606023013

Date of Test

Date (s) of performance of tests.....: Jun. 20, 2023 ~ Jul. 03, 2023

Date of Issue.....: Aug. 01, 2023

Test Result.....: Pass

Prepared By (Test Engineer) : Jack Li
Approved By (Lab Manager) : Alex Li

※ ※ **Revision History** ※ ※

REV.	DESCRIPTION	ISSUED DATE	REMARK
Rev.1.0	Initial Test Report Release	Aug. 01, 2023	Jack Li

TABLE OF CONTENTS

1.	General Information	6
1.1.	RF exposure limits.....	6
1.2.	Statement of Compliance	7
1.3.	EUT Description	7
1.4.	Test specification(s)	8
1.5.	Ambient Condition.....	9
2.	SAR Measurement System	10
2.1.	SATIMO SAR Measurement Set-up Diagram	10
2.2.	Robot	11
2.3.	E-Field Probe.....	12
2.3.1.	E-Field Probe Calibration	12
2.4.	SAM phantoms	13
2.4.1.	Technical Data	14
2.5.	Device Holder	15
2.6.	Test Equipment List	16
3.	SAR Measurement Procedures	19
3.1.	Power Reference	19
3.2.	Area scan & Zoom scan.....	19
3.3.	Description of interpolation/extrapolation scheme	21
3.4.	Volumetric Scan	21
3.5.	Power Drift	21
4.	System Verification Procedure	22
4.1.	Tissue Verification	22
4.1.1.	Tissue Dielectric Parameter Check Results	23
4.2.	System Verification Procedure	24
4.2.1.	System Verification Results.....	25
5.	SAR Measurement variability and uncertainty	26
5.1.	SAR measurement variability.....	26
5.2.	SAR measurement uncertainty	26
6.	RF Exposure Positions.....	27
6.1.	Tablet host platform exposure conditions.....	27
7.	RF Output Power	28
7.1.	GSM Conducted Power	28
7.2.	WCDMA Conducted Power	29
7.3.	LTE Conducted Power	30
7.4.	NR SA Power	42
7.5.	WLAN & Bluetooth Output Power	48
7.5.1.	Output Power Results Of WLAN	48
7.5.2.	Output Power Results Of Bluetooth	49
8.	Antenna Location.....	50

9.	Stand-alone SAR test exclusion.....	50
10.	SAR Results	51
10.1.	SAR measurement results.....	51
11.	SAR Results	51
11.1.	SAR measurement results.....	51
11.1.1.	SAR measurement Result of GSM850.....	51
11.1.2.	SAR measurement Result of GSM1900.....	52
11.1.3.	SAR measurement Result of WCDMA Band 2.....	53
11.1.4.	SAR measurement Result of WCDMA Band 4.....	54
11.1.5.	SAR measurement Result of WCDMA Band 5.....	55
11.1.6.	SAR measurement Result of LTE Band 2	56
11.1.7.	SAR measurement Result of LTE Band 4	57
11.1.8.	SAR measurement Result of LTE Band 5	59
11.1.9.	SAR measurement Result of LTE Band 7	60
11.1.10.	SAR measurement Result of LTE Band 12	62
11.1.11.	SAR measurement Result of LTE Band 17	63
11.1.12.	SAR measurement Result of NR n78.....	64
11.1.13.	SAR measurement Result of WLAN 2.4G	65
11.1.14.	SAR measurement Result of WLAN 5.2G	65
11.1.15.	SAR measurement Result of WLAN 5.8G	66
11.2.	SAR Summation Scenario.....	67
12.	Appendix A. Photo documentation	68
13.	Appendix B. System Check Plots.....	69
14.	Appendix C. Plots of High SAR Measurement.....	88
15.	Appendix D. Calibration Certificate	119

1. General Information

1.1. RF exposure limits

(A).Limits for Occupational/Controlled Exposure (W/kg)

Whole-Body	Partial-Body	Hands, Wrists, Feet and Ankles
0.4	8.0	20.0

(B).Limits for General Population/Uncontrolled Exposure (W/kg)

Whole-Body	Partial-Body	Hands, Wrists, Feet and Ankles
0.08	1.6	4.0

NOTE: **Whole-Body SAR** is averaged over the entire body, **partial-body SAR** is averaged over any 1 gram of tissue defined as a tissue volume in the shape of a cube. **SAR for hands, wrists, feet and ankles** is averaged over any 10 grams of tissue defined as a tissue volume in the shape of a cube.

Occupational/Controlled Environments:

Are defined as locations where there is exposure that may be incurred by people who are aware of the potential for exposure, (i.e. as a result of employment or occupation).

General Population/Uncontrolled Environments:

Are defined as locations where there is the exposure of individuals who have no knowledge or control of their exposure.

NOTE
TRUNK LIMIT
1.6 W/kg
APPLIED TO THIS EUT

1.2. Statement of Compliance

The maximum results of Specific Absorption Rate (SAR) found during testing for RT7 TITAN 5G are as follows.

RF Exposure Conditions		Max. Reported SAR Value(W/kg)
1-g Body-Worn (Separation distance of 0mm)		1.193
1-g Hotspot (Separation distance of 0mm)		1.193
Max Simultaneous Tx	Body-Worn	1.455
	Hotspot	1.455

Note: The Max Simultaneous Tx is calculated based on the same configuration and test position. This device is in compliance with Specific Absorption Rate (SAR) for general population/uncontrolled exposure limits (1.6 W/kg) specified in FCC 47 CFR Part 2(2.1093) and ANSI/IEEE C95.1-1992, and had been tested in accordance with the measurement methods and procedures specified in IEEE Std 1528-2013 & KDB 865664 D01.

1.3. EUT Description

Device Information			
Product Name	Tablet		
Trade Name	OUKITEL		
Model Name	RT7 TITAN 5G		
Family Model	RT7 \RT7 S\RT7 Pro\RT7 Ultra\RT7 TITAN		
Model Difference	All the model are the same circuit and RF module,except the model names.		
FCC ID	2ANMU-RT7SPUT		
Device Phase	Identical Prototype		
Exposure Category	General population / Uncontrolled environment		
Antenna	FPC Antenna		
Battery	DC 3.87V, 32000mAh, 123.84Wh		
Hardware version	TP758_MAIN_PCB_1.1		
Software version	OUKITEL_P07_EEA_V03		
Device Operating Configurations			
Supporting Mode(s)	GSM 850/1900, WCDMA Band 2/4/5, LTE Band 2/4/5/7/12/17, NR SA n78, WLAN 2.4G/5G, Bluetooth		
Test Modulation	GSM(GMSK/8PSK), WCDMA(QPSK), LTE(QPSK/16QAM), NR(DFT-s-OFDM:PI/2 BPSK/QPSK/16-QAM/64QAM/256QAM CP-OFDM: QPSK/16-QAM/64QAM/256QAM), WLAN(DSSS/OFDM), Bluetooth(GFSK, $\pi/4$ -DQPSK, 8DPSK),		
Device Class	B		
Operating Frequency Range(s)	Band	Tx (MHz)	Rx (MHz)
	GSM 850	824-849	869-894
	GSM 1900	1850-1910	1930-1990

	WCDMA Band 2	1850-1910	1930-1990
	WCDMA Band 4	1710-1755	2110-2155
	WCDMA Band 5	824-849	869-894
	LTE Band 2	1850-1910	1930-1990
	LTE Band 4	1710-1755	2110-2155
	LTE Band 5	824-849	869-894
	LTE Band 7	2500-2570	2620-2690
	LTE Band 12	699-716	729-746
	LTE Band 17	704-716	734-746
	NR n78	3450-3550	
	WLAN 2.4G	2412-2462	
	WLAN 5.2G	5180-5240	
	WLAN 5.8G	5745-5825	
	Bluetooth	2402-2480	
GPRS Multislot Class(12)	Max Number of Timeslots in Uplink		4
	Max Number of Timeslots in Downlink		4
	Max Total Timeslot		5
EGPRS Multislot Class(12)	Max Number of Timeslots in Uplink		4
	Max Number of Timeslots in Downlink		4
	Max Total Timeslot		5
Power Class	4, tested with power level 5(GSM 850)		
	1, tested with power level 0(GSM 1900)		
	3, tested with power control "all 1"(WCDMA Band 2)		
	3, tested with power control "all 1"(WCDMA Band 4)		
	3, tested with power control "all 1"(WCDMA Band 5)		
	3, tested with power control all Max.(LTE Band 2)		
	3, tested with power control all Max.(LTE Band 4)		
	3, tested with power control all Max.(LTE Band 5)		
	3, tested with power control all Max.(LTE Band 7)		
	3, tested with power control all Max.(LTE Band 12)		
	3, tested with power control all Max.(LTE Band 17)		
3, tested with power control all Max.(NR n78)			

1.4. Test specification(s)

FCC 47 CFR Part 2(2.1093)
ANSI/IEEE C95.1-1992
IEEE Std 1528-2013
KDB 865664 D01 SAR measurement 100 MHz to 6 GHz
KDB 865664 D02 RF Exposure Reporting

KDB 447498 D01 General RF Exposure Guidance
KDB 248227 D01 802.11 Wi-Fi SAR
KDB 941225 D01 3G SAR Procedures
KDB 941225 D05 SAR for LTE Devices
KDB 616217 D04 SAR for laptop and tablets

1.5. Ambient Condition

Ambient temperature	20°C – 24°C
Relative Humidity	30% – 70%

2. SAR Measurement System

2.1. SATIMO SAR Measurement Set-up Diagram

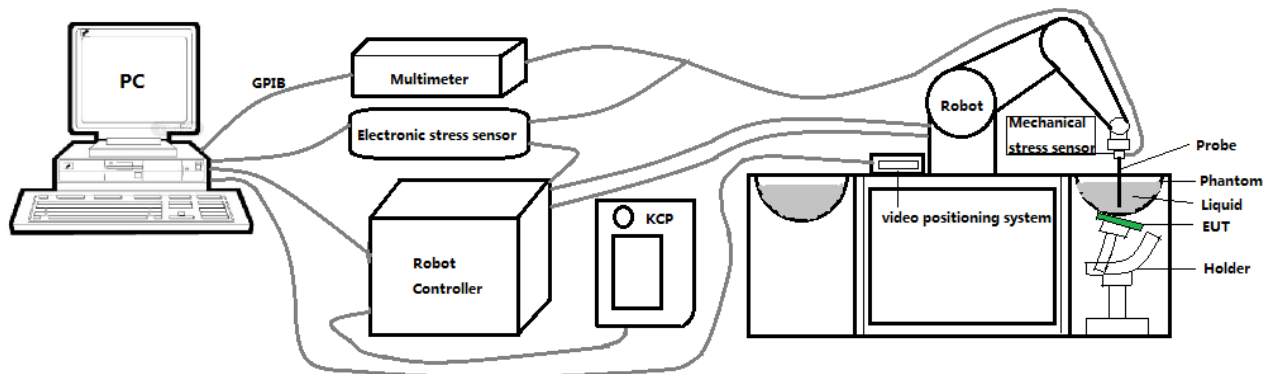

These measurements were performed with the automated near-field scanning system OPENSAR from SATIMO. The system is based on a high precision robot (working range: 901 mm), which positions the probes with a positional repeatability of better than ± 0.03 mm. The SAR measurements were conducted with dosimetric probe (manufactured by SATIMO), designed in the classical triangular configuration and optimized for dosimetric evaluation.

The first step of the field measurement is the evaluation of the voltages induced on the probe by the device under test. Probe diode detectors are nonlinear. Below the diode compression point, the output voltage is proportional to the square of the applied E-field; above the diode compression point, it is linear to the applied E-field. The compression point depends on the diode, and a calibration procedure is necessary for each sensor of the probe.

The Keithley multimeter reads the voltage of each sensor and send these three values to the PC. The corresponding E field value is calculated using the probe calibration factors, which are stored in the working directory. This evaluation includes linearization of the diode characteristics. The field calculation is done separately for each sensor. Each component of the E field is displayed on the "Dipole Area Scan Interface" and the total E field is displayed on the "3D Interface"

2.2. Robot

The SATIMO SAR system uses the high precision robots from KUKA. For the 6-axis controller system, the robot controller version (KUKA) from KUKA is used. The KUKA robot series have many features that are important for our application:



- High precision (repeatability ± 0.03 mm)
- High reliability (industrial design)
- Jerk-free straight movements
- Low ELF interference (the closed metallic construction shields against motor control fields)

2.3. E-Field Probe

This E-field detection probe is composed of three orthogonal dipoles linked to special Schottky diodes with low detection thresholds. The probe allows the measurement of electric fields in liquids such as the one defined in the IEEE and CENELEC standards.

For the measurements the Specific Dosimetric E-Field Probe SN 08/16 EPGO287 with following specifications is used



- Dynamic range: 0.01-100 W/kg
- Tip Diameter : 2.5 mm
- Distance between probe tip and sensor center: 1 mm
- Distance between sensor center and the inner phantom surface: 2 mm (repeatability better than ± 1 mm).
- Probe linearity: ± 0.08 dB
- Axial isotropy: ± 0.01 dB
- Hemispherical Isotropy: ± 0.01 dB
- Calibration range: 650MHz to 5900MHz for head & body simulating liquid.
- Lower detection limit: 8mW/kg

Angle between probe axis (evaluation axis) and surface normal line: less than 30° .

2.3.1. E-Field Probe Calibration

Each probe needs to be calibrated according to a dosimetric assessment procedure with accuracy better than $\pm 10\%$. The spherical isotropy shall be evaluated and within ± 0.25 dB. The sensitivity parameters (Norm X, Norm Y, and Norm Z), the diode compression parameter (DCP) and the conversion factor (Conv F) of the probe are tested. The calibration data can be referred to appendix D of this report.

2.4. SAM phantoms

Photo of SAM phantom SN 16/15 SAM119



The SAM phantom is used to measure the SAR relative to people exposed to electro-magnetic field radiated by mobile phones.

2.4.1. Technical Data

Serial Number	Shell thickness	Filling volume	Dimensions	Positionner Material	Permittivity	Loss Tangent
SN 16/15 SAM119	2 mm ±0.2 mm	27 liters	Length:1000 mm Width:500 mm Height:200 mm	Gelcoat with fiberglass	3.4	0.02

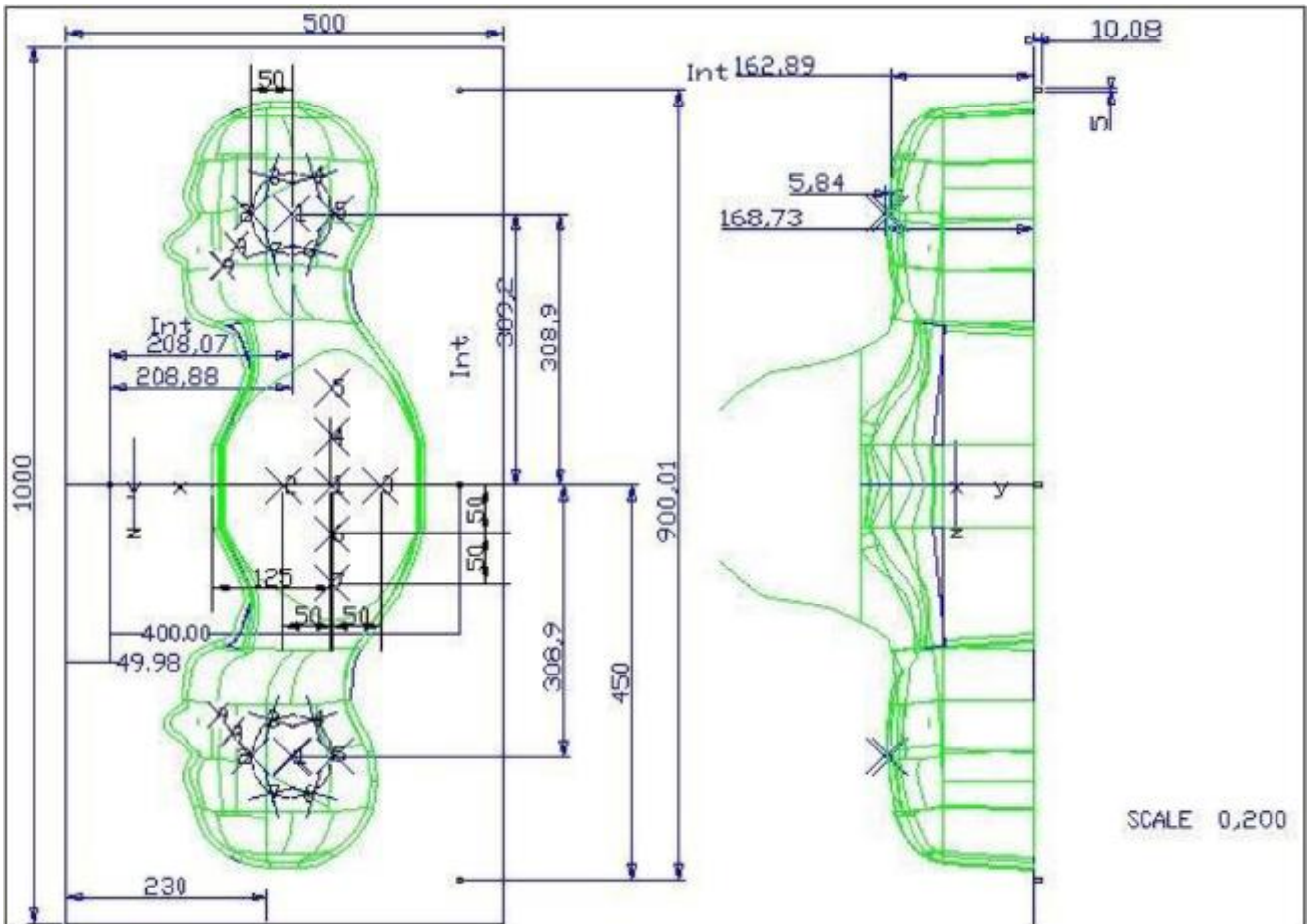

Serial Number	Left Head(mm)		Right Head(mm)		Flat Part(mm)	
	1	2	1	2	1	2
SN 16/15 SAM119	2	2.02	2	2.08	1	2.09
	3	2.05	3	2.06	2	2.06
	4	2.07	4	2.07	3	2.08
	5	2.08	5	2.08	4	2.10
	6	2.05	6	2.07	5	2.10
	7	2.05	7	2.05	6	2.07
	8	2.07	8	2.06	7	2.07
	9	2.08	9	2.06	-	-

The test, based on ultrasonic system, allows measuring the thickness with an accuracy of 10 µm.

2.5. Device Holder

The positioning system allows obtaining cheek and tilting position with a very good accuracy. In compliance with CENELEC, the tilt angle uncertainty is lower than 1 degree.

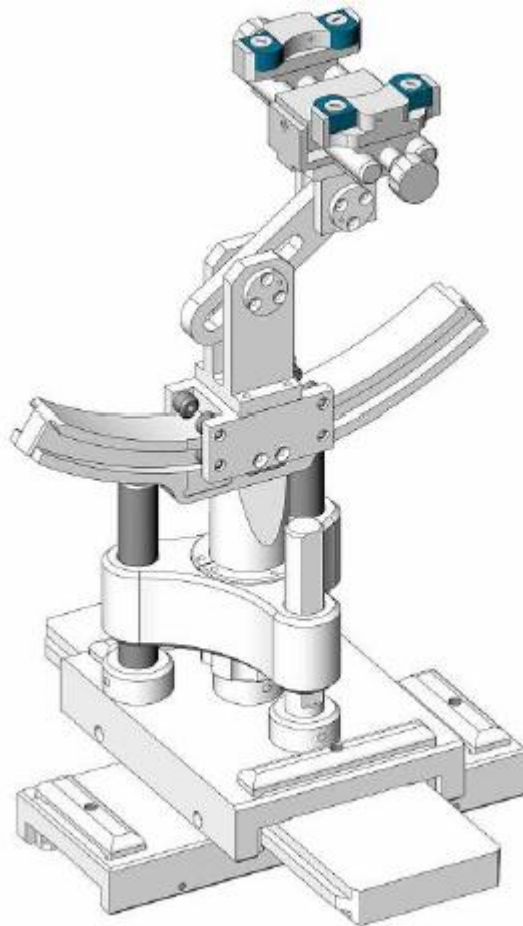

Serial Number	Holder Material	Permittivity	Loss Tangent
SN 16/15 MSH100	Delrin	3.7	0.005

2.6. Test Equipment List

This table gives a complete overview of the SAR measurement equipment.

Devices used during the test described are marked

	Manufacturer	Name of Equipment	Type/Model	Serial Number	Calibration	
					Last Cal.	Due Date
<input checked="" type="checkbox"/>	MVG	E FIELD PROBE	SSE2	SN 08/16 EPGO287	Jan. 10, 2023	Jan. 09, 2024
<input checked="" type="checkbox"/>	MVG	750 MHz Dipole	SID750	SN 03/15 DIP 0G750-355	Mar. 01, 2021	Feb. 28, 2024
<input checked="" type="checkbox"/>	MVG	835 MHz Dipole	SID835	SN 03/15 DIP 0G835-347	Mar. 01, 2021	Feb. 28, 2024
<input type="checkbox"/>	MVG	900 MHz Dipole	SID900	SN 03/15 DIP 0G900-348	Mar. 01, 2021	Feb. 28, 2024
<input checked="" type="checkbox"/>	MVG	1800 MHz Dipole	SID1800	SN 03/15 DIP 1G800-349	Mar. 01, 2021	Feb. 28, 2024
<input checked="" type="checkbox"/>	MVG	1900 MHz Dipole	SID1900	SN 03/15 DIP 1G900-350	Mar. 01, 2021	Feb. 28, 2024
<input type="checkbox"/>	MVG	2000 MHz Dipole	SID2000	SN 03/15 DIP 2G000-351	Mar. 01, 2021	Feb. 28, 2024
<input type="checkbox"/>	MVG	2300 MHz Dipole	SID2300	SN 03/16 DIP 2G300-358	Mar. 01, 2021	Feb. 28, 2024
<input checked="" type="checkbox"/>	MVG	2450 MHz Dipole	SID2450	SN 03/15 DIP 2G450-352	Mar. 01, 2021	Feb. 28, 2024
<input checked="" type="checkbox"/>	MVG	2600 MHz Dipole	SID2600	SN 03/15 DIP 2G600-356	Mar. 01, 2021	Feb. 28, 2024
<input checked="" type="checkbox"/>	MVG	3700 MHz Dipole	SID3700	SN 09/12 DIP 3G/700-361	Oct. 15 2022	Oct. 14 2025
<input checked="" type="checkbox"/>	MVG	5000 MHz Dipole	SWG5500	SN 13/14 WGA 33	Mar. 01, 2021	Feb. 28, 2024
<input checked="" type="checkbox"/>	MVG	Liquid measurement Kit	SCLMP	SN 21/15 OCPG 72	NCR	NCR
<input checked="" type="checkbox"/>	MVG	Power Amplifier	N.A	AMPLISAR_28/14_003	NCR	NCR
<input checked="" type="checkbox"/>	KEITHLEY	Millivoltmeter	2000	4072790	NCR	NCR
<input checked="" type="checkbox"/>	R&S	Universal radio communication tester	CMU200	117858	May 29, 2023	May 28, 2024
<input checked="" type="checkbox"/>	R&S	Wideband radio communication tester	CMW500	103917	May 29, 2023	May 28, 2024

<input checked="" type="checkbox"/>	HP	Network Analyzer	8753D	3410J01136	May 29, 2023	May 28, 2024
<input checked="" type="checkbox"/>	Agilent	MXG Vector Signal Generator	N5182A	MY47070317	May 29, 2023	May 28, 2024
<input checked="" type="checkbox"/>	Agilent	Power meter	E4419B	MY45102538	May 29, 2023	May 28, 2024
<input checked="" type="checkbox"/>	Agilent	Power sensor	E9301A	MY41495644	May 29, 2023	May 28, 2024
<input checked="" type="checkbox"/>	Agilent	Power sensor	E9301A	US39212148	May 29, 2023	May 28, 2024
<input checked="" type="checkbox"/>	MCLI/USA	Directional Coupler	CB11-20	0D2L51502	Jul. 04, 2023	Jul. 03, 2024
<input checked="" type="checkbox"/>	N/A	Thermometer	N/A	LES-085	Mar. 27, 2023	Mar. 26, 2026
<input checked="" type="checkbox"/>	MVG	SAM Phantom	SSM2	SN 16/15 SAM119	NCR	NCR
<input checked="" type="checkbox"/>	MVG	Device Holder	SMPPD	SN 16/15 MSH100	NCR	NCR
<input checked="" type="checkbox"/>	Shenzhen Tianxu Communication Technology Co., Ltd.	Human Simulating Liquid	Head 750	Head 750	NCR	NCR
<input checked="" type="checkbox"/>	Shenzhen Tianxu Communication Technology Co., Ltd.	Human Simulating Liquid	Head 835	Head 835	NCR	NCR
<input checked="" type="checkbox"/>	Shenzhen Tianxu Communication Technology Co., Ltd.	Human Simulating Liquid	Head 1800	Head 1800	NCR	NCR
<input checked="" type="checkbox"/>	Shenzhen Tianxu Communication Technology Co., Ltd.	Human Simulating Liquid	Head 1900	Head 1900	NCR	NCR
<input checked="" type="checkbox"/>	Shenzhen Tianxu Communication Technology Co., Ltd.	Human Simulating Liquid	Head 2450	Head 2450	NCR	NCR

<input checked="" type="checkbox"/>	Shenzhen Tianxu Communication Technology Co., Ltd.	Human Simulating Liquid	Head 2600	Head 2600	NCR	NCR
<input checked="" type="checkbox"/>	Shenzhen Tianxu Communication Technology Co., Ltd.	Human Simulating Liquid	Head 3500	Head 3500	NCR	NCR
<input checked="" type="checkbox"/>	Shenzhen Tianxu Communication Technology Co., Ltd.	Human Simulating Liquid	Head 5200	Head 5200	NCR	NCR
<input checked="" type="checkbox"/>	Shenzhen Tianxu Communication Technology Co., Ltd.	Human Simulating Liquid	Head 5800	Head 5800	NCR	NCR

3. SAR Measurement Procedures

The measurement procedures are as follows:

<Conducted power measurement>

- (a) For WWAN power measurement, use base station simulator to configure EUT WWAN transmission in conducted connection with RF cable, at maximum power in each supported wireless interface and frequency band.
- (b) Read the WWAN RF power level from the base station simulator.
- (c) For WLAN/Bluetooth power measurement, use engineering software to configure EUT WLAN/Bluetooth continuously transmission, at maximum RF power in each supported wireless interface and frequency band.
- (d) Connect EUT RF port through RF cable to the power meter, and measure WLAN/Bluetooth output power.

<SAR measurement>

- (a) Use base station simulator to configure EUT WWAN transmission in radiated connection, and engineering software to configure EUT WLAN/Bluetooth continuously transmission, at maximum RF power, in the highest power channel.
- (b) Place the EUT in the positions as Appendix A demonstrates.
- (c) Set scan area, grid size and other setting on the OPENSAR software.
- (d) Measure SAR results for the highest power channel on each testing position.
- (e) Find out the largest SAR result on these testing positions of each band.
- (f) Measure SAR results for other channels in worst SAR testing position if the reported SAR of highest power channel is larger than 0.8 W/kg.

According to the test standard, the recommended procedure for assessing the peak spatial-average SAR value consists of the following steps:

- (a) Power reference measurement
- (b) Area scan
- (c) Zoom scan
- (d) Power drift measurement

3.1. Power Reference

The Power Reference Measurement and Power Drift Measurements are for monitoring the power drift of the device under test in the batch process. The minimum distance of probe sensors to surface determines the closest measurement point to phantom surface. This distance cannot be smaller than the distance of sensor calibration points to probe tip as defined in the probe properties.

3.2. Area scan & Zoom scan

The area scan is a 2D scan to find the hot spot location on the DUT. The zoom scan is a 3D scan above the hot spot to calculate the 1g and 10g SAR value.

Measurement of the SAR distribution with a grid of 8 to 16 mm * 8 to 16 mm and a constant distance to the inner surface of the phantom. Since the sensors cannot directly measure at the inner phantom surface, the values between the sensors and the inner phantom surface are extrapolated. With these values the area of the maximum SAR is calculated by an interpolation scheme. Around this point, a cube of 30 * 30 * 30 mm or 32 * 32 * 32 mm is assessed by measuring 5 or 8 * 5 or 8 * 4 or 5 mm. With these data, the peak spatial-average SAR value can be calculated.

From the scanned SAR distribution, identify the position of the maximum SAR value, in addition identify the positions of any local maxima with SAR values within 2 dB of the maximum value that will not be within the zoom scan of other peaks; additional peaks shall be measured only when the primary peak is within 2 dB of the SAR compliance limit (e.g., 1 W/kg for 1,6 W/kg 1 g limit, or 1,26 W/kg for 2 W/kg, 10 g limit).

Area scan & Zoom scan scan parameters extracted from FCC KDB 865664 D01 SAR measurement 100 MHz to 6 GHz.

		≤ 3 GHz	> 3 GHz	
Maximum distance from closest measurement point (geometric center of probe sensors) to phantom surface		5 ± 1 mm	½·δ·ln(2) ± 0.5 mm	
Maximum probe angle from probe axis to phantom surface normal at the measurement location		30° ± 1°	20° ± 1°	
Maximum area scan spatial resolution: Δx _{Area} , Δy _{Area}		≤ 2 GHz: ≤ 15 mm 2 – 3 GHz: ≤ 12 mm	3 – 4 GHz: ≤ 12 mm 4 – 6 GHz: ≤ 10 mm	
		When the x or y dimension of the test device, in the measurement plane orientation, is smaller than the above, the measurement resolution must be ≤ the corresponding x or y dimension of the test device with at least one measurement point on the test device.		
Maximum zoom scan spatial resolution: Δx _{Zoom} , Δy _{Zoom}		≤ 2 GHz: ≤ 8 mm 2 – 3 GHz: ≤ 5 mm *	3 – 4 GHz: ≤ 5 mm * 4 – 6 GHz: ≤ 4 mm *	
Maximum zoom scan spatial resolution, normal to phantom surface	uniform grid: Δz _{Zoom} (n)	≤ 5 mm	3 – 4 GHz: ≤ 4 mm 4 – 5 GHz: ≤ 3 mm 5 – 6 GHz: ≤ 2 mm	
	graded grid	Δz _{Zoom} (1): between 1 st two points closest to phantom surface	≤ 4 mm	3 – 4 GHz: ≤ 3 mm 4 – 5 GHz: ≤ 2.5 mm 5 – 6 GHz: ≤ 2 mm
		Δz _{Zoom} (n>1): between subsequent points	≤ 1.5·Δz _{Zoom} (n-1)	
Minimum zoom scan volume	x, y, z	≥ 30 mm	3 – 4 GHz: ≥ 28 mm 4 – 5 GHz: ≥ 25 mm 5 – 6 GHz: ≥ 22 mm	

Note: δ is the penetration depth of a plane-wave at normal incidence to the tissue medium; see draft standard IEEE P1528-2011 for details.

* When zoom scan is required and the *reported* SAR from the *area scan based 1-g SAR estimation* procedures of KDB 447498 is ≤ 1.4 W/kg, ≤ 8 mm, ≤ 7 mm and ≤ 5 mm zoom scan resolution may be applied, respectively, for 2 GHz to 3 GHz, 3 GHz to 4 GHz and 4 GHz to 6 GHz.

3.3. Description of interpolation/extrapolation scheme

The local SAR inside the phantom is measured using small dipole sensing elements inside a probe body. The probe tip must not be in contact with the phantom surface in order to minimise measurements errors, but the highest local SAR will occur at the surface of the phantom.

An extrapolation is using to determinate this highest local SAR values. The extrapolation is based on a fourth-order least-square polynomial fit of measured data. The local SAR value is then extrapolated from the liquid surface with a 1 mm step.

The measurements have to be performed over a limited time (due to the duration of the battery) so the step of measurement is high. It could vary between 5 and 8 mm. To obtain an accurate assessment of the maximum SAR averaged over 10 grams and 1 gram requires a very fine resolution in the three dimensional scanned data array.

3.4. Volumetric Scan

The volumetric scan consists to a full 3D scan over a specific area. This 3D scan is useful form multi Tx SAR measurement. Indeed, it is possible with OpenSAR to add, point by point, several volumetric scan to calculate the SAR value of the combined measurement as it is define in the standard IEEE1528 and IEC62209.

3.5. Power Drift

All SAR testing is under the EUT install full charged battery and transmit maximum output power. In OpenSAR measurement software, the power reference measurement and power drift measurement procedures are used for monitoring the power drift of EUT during SAR test. Both these procedures measure the field at a specified reference position before and after the SAR testing. The software will calculate the field difference in V/m. If the power drifts more than $\pm 5\%$, the SAR will be retested.

4. System Verification Procedure

4.1. Tissue Verification

The following tissue formulations are provided for reference only as some of the parameters have not been thoroughly verified. The composition of ingredients may be modified accordingly to achieve the desired target tissue parameters required for routine SAR evaluation.

Ingredients (% of weight)	Head Tissue								
	750	835	900	1800	1900	2000	2450	2600	5000
Frequency Band (MHz)	750	835	900	1800	1900	2000	2450	2600	5000
Water	34.40	34.40	34.40	55.36	55.36	71.88	71.88	71.88	65.53
NaCl	0.79	0.79	0.79	0.35	0.35	0.16	0.16	0.16	0.00
1,2-Propanediol	64.81	64.81	64.81	0.00	0.00	0.00	0.00	0.00	0.00
Triton X-100	0.00	0.00	0.00	30.45	30.45	19.97	19.97	19.97	17.24
DGBE	0.00	0.00	0.00	13.84	13.84	7.99	7.99	7.99	0.00

For SAR measurement of the field distribution inside the phantom, the phantom must be filled with homogeneous tissue simulating liquid to a depth of at least 15 cm. For head SAR testing, the liquid depth from the ear reference point (ERP) of the phantom to the liquid top surface is larger than 15 cm.

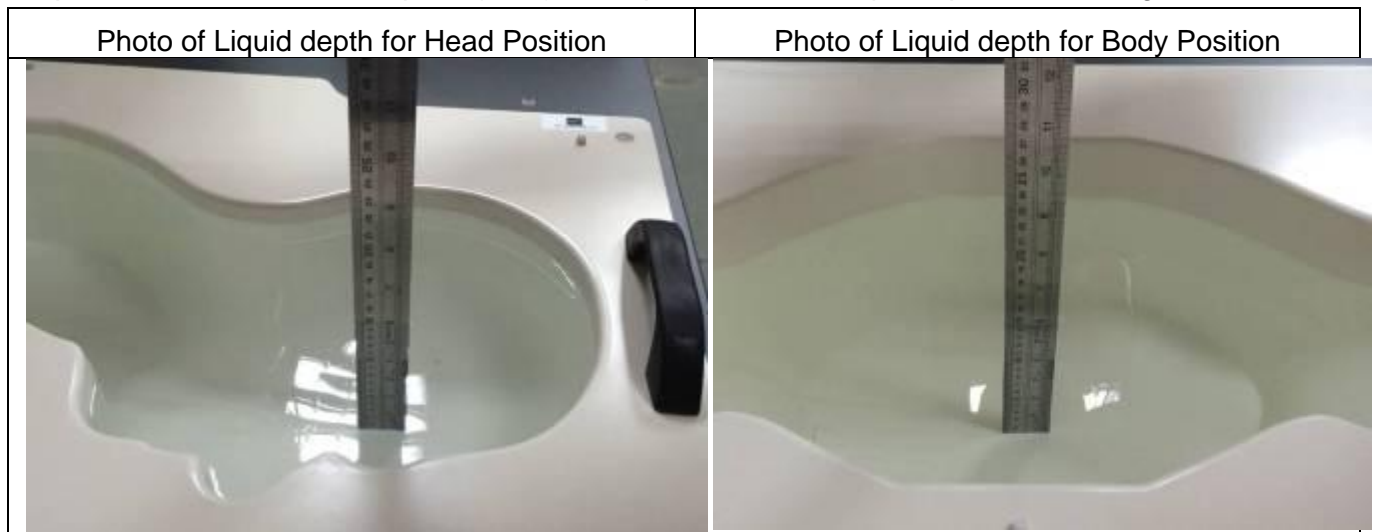

4.1.1. Tissue Dielectric Parameter Check Results

The simulating liquids should be checked at the beginning of a series of SAR measurements to determine if the dielectric parameters are within the tolerances of the specified target values. The measured conductivity and relative permittivity should be within $\pm 5\%$ of the target values.

Tissue Type	Measured Frequency (MHz)	Target Tissue		Measured Tissue		Liquid Temp.	Test Date
		ϵ_r ($\pm 5\%$)	σ (S/m) ($\pm 5\%$)	ϵ_r	σ (S/m)		
Head 750	750	41.96 (39.86~44.06)	0.89 (0.85~0.93)	40.20	0.89	21.8 °C	Jun. 20, 2023
Head 850	835	41.50 (39.43~43.58)	0.90 (0.86~0.95)	40.59	0.90	21.2 °C	Jun. 25, 2023
Head 1800	1800	40.00 (38.00~42.00)	1.40 (1.33~1.47)	38.56	1.37	21.4 °C	Jun. 26, 2023
Head 1900	1900	40.00 (38.00~42.00)	1.40 (1.33~1.47)	38.61	1.43	21.1 °C	Jun. 21, 2023
Head 2450	2450	39.20 (37.24~41.16)	1.80 (1.71~1.89)	37.96	1.77	21.6 °C	Jun. 28, 2023
Head 2600	2600	39.01 (37.06~40.96)	1.96 (1.86~2.06)	37.72	1.93	21.4 °C	Jun. 29, 2023
Head 3700	3700	37.64 (35.76~39.52)	3.17 (3.02~3.32)	37.63	3.06	21.4 °C	Jun. 30, 2023
Head 5200	5200	36.00 (34.20~37.80)	4.66 (4.43~4.89)	35.13	4.53	21.7 °C	Jun. 22, 2023
Head 5800	5800	35.30 (33.54~37.07)	5.27 (5.01~5.53)	34.21	5.14	21.3 °C	Jul. 03, 2023

NOTE: The dielectric parameters of the tissue-equivalent liquid should be measured under similar ambient conditions and within 2 °C of the conditions expected during the SAR evaluation to satisfy protocol requirements.

4.2. System Verification Procedure

The system verification is performed for verifying the accuracy of the complete measurement system and performance of the software. The dipole is connected to the signal source consisting of signal generator and amplifier via a directional coupler, N-connector cable and adaption to SMA. It is fed with a power of 100mW (below 5GHz) or 100mW (above 5GHz). To adjust this power a power meter is used. The power sensor is connected to the cable before the system verification to measure the power at this point and do adjustments at the signal generator. At the outputs of the directional coupler both return loss as well as forward power are controlled during the system verification to make sure that emitted power at the dipole is kept constant. This can also be checked by the power drift measurement after the test (result on plot).

The system verification is shown as below picture:

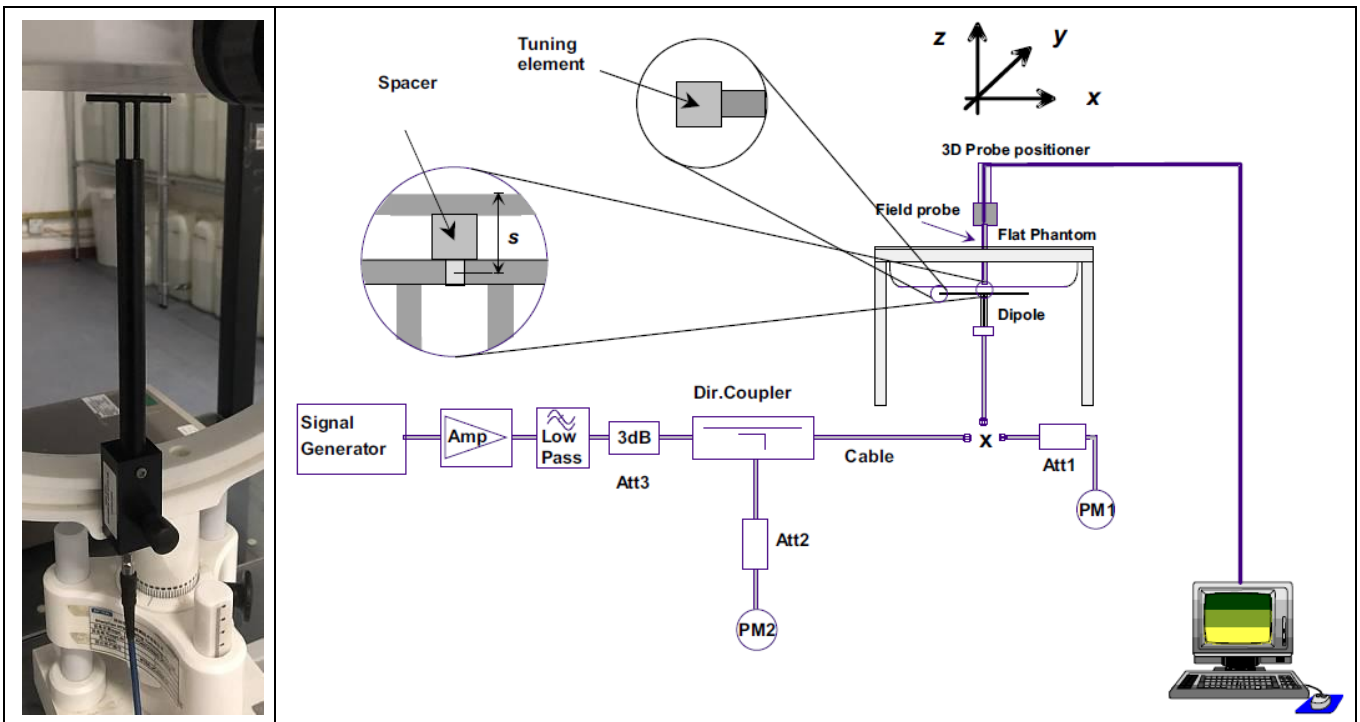

4.2.1. System Verification Results

Comparing to the original SAR value provided by SATIMO, the verification data should be within its specification of $\pm 10\%$. Below table shows the target SAR and measured SAR after normalized to 1W input power. The table below indicates the system performance verification can meet the variation criterion and the plots can be referred to Appendix B of this report.

System Verification	Target SAR (1W) ($\pm 10\%$)		Measured SAR (Normalized to 1W)		Liquid Temp.	Delta (%)		Test Date
	1-g (W/Kg)	10-g (W/Kg)	1-g (W/Kg)	10-g (W/Kg)		1-g ($\pm 10\%$)	10-g ($\pm 10\%$)	
750MHz	8.53 (7.68~9.38)	5.56 (5.01~6.11)	8.75	5.30	21.8 °C	2.58%	-4.68%	Jun. 20, 2023
835MHz	9.84 (8.86~10.82)	6.22 (5.60~6.84)	9.32	5.89	21.2 °C	-5.28%	-5.31%	Jun. 25, 2023
1800MHz	37.96 (34.17~41.75)	19.81 (17.83~21.79)	35.35	18.62	21.4 °C	-6.88%	-6.01%	Jun. 26, 2023
1900MHz	40.37 (36.34~44.40)	20.48 (18.44~22.52)	42.20	21.41	21.1 °C	4.53%	4.54%	Jun. 21, 2023
2450MHz	53.69 (48.33~59.05)	23.94 (21.55~26.33)	53.48	22.03	21.6 °C	-0.39%	-6.45%	Jun. 28, 2023
2600MHz	55.83 (50.25~61.41)	24.19 (21.78~26.60)	53.09	25.37	21.4 °C	-4.91%	4.88%	Jun. 29, 2023
3700MHz	66.30 (59.67~72.93)	24.16 (22.96~26.57)	66.20	23.09	21.4 °C	-0.15%	-4.43%	Jun. 30, 2023
5200MHz	162.34 (146.11~178.57)	55.42 (49.88~60.96)	164.76	54.05	21.7 °C	1.49%	-2.47%	Jun. 22, 2023
5800MHz	178.89 (161.01~196.77)	59.32 (53.39~65.25)	190.87	62.51	21.3 °C	6.70%	5.38%	Jul. 03, 2023

5. SAR Measurement variability and uncertainty

5.1. SAR measurement variability

Per KDB865664 D01 SAR measurement 100 MHz to 6 GHz, SAR measurement variability must be assessed for each frequency band, which is determined by the SAR probe calibration point and tissue-equivalent medium used for the device measurements. The additional measurements are repeated after the completion of all measurements requiring the same head or body tissue-equivalent medium in a frequency band. The test device should be returned to ambient conditions (normal room temperature) with the battery fully charged before it is re-mounted on the device holder for the repeated measurement(s) to minimize any unexpected variations in the repeated results.

- 1) Repeated measurement is not required when the original highest measured SAR is < 0.80 W/kg; steps 2) through 4) do not apply.
- 2) When the original highest measured SAR is ≥ 0.80 W/kg, repeat that measurement once.
- 3) Perform a second repeated measurement only if the ratio of largest to smallest SAR for the original and first repeated measurements is > 1.20 or when the original or repeated measurement is ≥ 1.45 W/kg (~ 10% from the 1-g SAR limit).
- 4) Perform a third repeated measurement only if the original, first or second repeated measurement is ≥ 1.5 W/kg and the ratio of largest to smallest SAR for the original, first and second repeated measurements is > 1.20 .

5.2. SAR measurement uncertainty

Per KDB865664 D01 SAR Measurement 100 MHz to 6 GHz, when the highest measured 1-g SAR within a frequency band is < 1.5 W/kg, the extensive SAR measurement uncertainty analysis described in IEEE Std 1528-2013 is not required in SAR reports submitted for equipment approval. The equivalent ratio (1.5/1.6) is applied to extremity and occupational exposure conditions.

6. RF Exposure Positions

6.1. Tablet host platform exposure conditions

Refer to KDB616217 D04, when the modular approach is used, transmitters and modules must be initially tested for standalone operations in generic host conditions according to the following minimum test separation distance and antenna installation requirements for incorporation in the tablet platform. The separation distance required for incorporation in qualified hosts is described in KDB 447498; item 5) of section 4.1 and item 1) of section 5.2.2 etc.

- ≤ 5 mm between the antenna and user for both back surface and edge exposure conditions
- the antennas used by the host must have been tested for equipment approval or qualify for SAR test exclusion
- the antenna polarization, physical orientation, rotation and installation configurations used by the host must have been tested for compliance or qualify for test exclusion
- when the *SAR Test Exclusion Threshold* in KDB 447498 applies, a *test separation distance* of 5 mm is required to determine test exclusion for the tablet platform

The antennas embedded in tablets are typically ≤ 5 mm from the outer housing. The required antenna to user test separation distance is a “not to exceed test” distance required to apply the modular approach. Instead of the typical zero gap tablet edge test requirement between the edge of a tablet and the user, when an antenna has been tested at ≤ 5 mm according to the modular approach it can be incorporated into tablets with at least twice the tested distance from the outer housing of the tablet edge; otherwise, the tablet edge zero gap test requirement applies. When the dedicated host approach is applied, the back surface and edges of the tablet should be tested for SAR compliance with the tablet touching the phantom.

7. RF Output Power

7.1. GSM Conducted Power

Band GSM850		Burst-Averaged output Power (dBm)			Frame-Averaged output Power (dBm)			
Tx Channel	Tune -	128	189	251	Tune -	128	189	251
Frequency (MHz)	up (dBm)	824.2	836.4	848.8	up (dBm)	824.2	836.4	848.8
GSM (GMSK)	33.50	33.31	33.27	33.33	24.47	24.28	24.24	24.30
GPRS(GMSK, 1 TS)	33.50	33.48	33.43	33.49	24.47	24.45	24.40	24.46
GPRS(GMSK, 2 TS)	33.00	32.74	32.69	32.76	26.98	26.72	26.67	26.74
GPRS(GMSK, 3 TS)	31.50	30.98	30.97	31.05	27.24	26.72	26.71	26.79
GPRS(GMSK, 4 TS)	30.00	29.85	29.87	29.94	26.99	26.84	26.86	26.93
EGPRS(8PSK, 1 TS)	28.50	27.36	28.37	27.29	19.47	18.33	19.34	18.26
EGPRS(8PSK, 2 TS)	26.50	26.48	26.48	26.37	20.48	20.46	20.46	20.35
EGPRS(8PSK, 3 TS)	24.50	24.31	24.22	24.00	20.24	20.05	19.96	19.74
EGPRS(8PSK, 4 TS)	23.50	22.70	23.37	22.88	20.49	19.69	20.36	19.87
Band GSM1900		Burst-Averaged output Power (dBm)			Frame-Averaged output Power (dBm)			
Tx Channel	Tune -	512	661	810	Tune -	512	661	810
Frequency (MHz)	up (dBm)	1850.2	1880	1909.8	up (dBm)	1850.2	1880	1909.8
GSM (GMSK)	32.50	32.11	32.11	31.83	23.47	23.08	23.08	22.80
GPRS(GMSK, 1 TS)	32.50	32.08	32.11	31.81	23.47	23.05	23.08	22.78
GPRS(GMSK, 2 TS)	31.50	31.19	31.18	30.90	25.48	25.17	25.16	24.88
GPRS(GMSK, 3 TS)	29.50	29.16	29.14	28.89	25.24	24.90	24.88	24.63
GPRS(GMSK, 4 TS)	28.50	28.11	28.15	27.89	25.49	25.10	25.14	24.88
EGPRS(8PSK, 1 TS)	29.00	27.24	27.85	28.74	19.97	18.21	18.82	19.71
EGPRS(8PSK, 2 TS)	28.00	26.65	26.89	27.55	21.98	20.63	20.87	21.53
EGPRS(8PSK, 3 TS)	25.00	24.48	24.84	24.92	20.74	20.22	20.58	20.66
EGPRS(8PSK, 4 TS)	24.50	23.10	23.32	24.01	21.49	20.09	20.31	21.00

Note: The frame-averaged power is linearly scaled the maximum burst averaged power over 8 time slots. The calculated method are shown as below:

Frame-averaged power = Maximum burst averaged power (1 Tx Slot) - 9.03 dB

Frame-averaged power = Maximum burst averaged power (2 Tx Slots) - 6.02 dB

Frame-averaged power = Maximum burst averaged power (3 Tx Slots) - 4.26 dB

Frame-averaged power = Maximum burst averaged power (4 Tx Slots) - 3.01 dB

7.2. WCDMA Conducted Power

WCDMA Band 2		Burst-Averaged output Power (dBm)			
Tx Channel	Tune-up (dBm)	9262	9400	9538	
Frequency (MHz)		1852.4	1880	1907.6	
RMC12.2K	25.00	23.95	24.50	24.72	
HSDPA Sub 1	24.00	22.92	23.47	23.70	
HSDPA Sub 2	23.50	22.36	23.17	23.29	
HSDPA Sub 3	22.50	21.45	22.05	21.84	
HSDPA Sub 4	22.50	21.45	22.16	22.29	
HSUPA Sub 1	24.00	22.23	23.33	23.53	
HSUPA Sub 2	24.00	22.88	23.36	23.51	
HSUPA Sub 3	22.50	21.15	22.24	22.37	
HSUPA Sub 4	24.00	22.89	23.45	23.73	
HSUPA Sub 5	23.00	21.24	22.62	22.96	
WCDMA Band 4		Burst-Averaged output Power (dBm)			
Tx Channel	Tune-up (dBm)	1312	1413	1513	
Frequency (MHz)		1712.4	1732.6	1752.6	
RMC12.2K	25.50	25.50	25.48	25.49	
HSDPA Sub 1	25.00	24.97	24.23	24.08	
HSDPA Sub 2	25.00	24.53	23.66	23.75	
HSDPA Sub 3	24.00	23.56	22.80	22.54	
HSDPA Sub 4	24.00	23.57	22.80	22.76	
HSUPA Sub 1	24.50	23.34	24.04	23.90	
HSUPA Sub 2	25.00	24.78	24.15	23.93	
HSUPA Sub 3	23.50	23.23	22.88	22.69	
HSUPA Sub 4	25.00	24.93	24.23	24.06	
HSUPA Sub 5	24.00	23.35	23.52	23.40	
WCDMA Band 5		Burst-Averaged output Power (dBm)			
Tx Channel	Tune-up (dBm)	4132	4182	4233	
Frequency (MHz)		826.4	836.4	846.6	
RMC12.2K	24.00	23.71	23.57	23.56	
HSDPA Sub 1	23.00	22.84	22.74	22.72	
HSDPA Sub 2	22.50	22.45	22.40	22.39	
HSDPA Sub 3	21.50	21.46	20.92	20.80	
HSDPA Sub 4	21.50	21.15	21.39	21.06	
HSUPA Sub 1	23.00	22.04	22.59	22.55	

HSUPA Sub 2	23.00	22.69	22.69	22.60
HSUPA Sub 3	21.50	21.24	21.48	21.35
HSUPA Sub 4	23.00	22.88	22.77	22.71
HSUPA Sub 5	22.50	21.57	22.34	22.10

7.3. LTE Conducted Power

Band	Band Width	Modulation	RB Configuration		Tune-up (dBm)	Channel/Frequency(MHz)		
			RB Size	RB Offset		18607/1850.7	18900/1880	19193/1909.3
LTE Band 2	1.4MHz	QPSK	1	0	25.50	23.52	24.85	25.03
			1	2	25.50	24.24	24.82	25.07
			1	5	25.50	24.24	24.85	25.06
			3	0	25.50	24.22	24.78	25.07
			3	1	25.50	24.20	24.78	25.09
			3	2	25.50	24.19	24.78	25.07
		16QAM	6	0	24.50	23.23	23.81	24.03
			1	0	24.50	23.46	23.73	24.23
			1	2	24.50	23.46	23.74	24.22
			1	5	24.50	23.49	23.75	24.23
			3	0	24.50	23.47	23.91	24.22
			3	1	24.50	23.45	23.91	24.22
			3	2	24.50	23.46	23.89	24.21
			6	0	23.50	22.38	22.92	23.24
Band	Band Width	Modulation	RB Configuration		Tune-up (dBm)	Channel/Frequency(MHz)		
			RB Size	RB Offset		18615/1851.5	18900/1880	19185/1908.5
LTE Band 2	3MHz	QPSK	1	0	25.50	24.18	24.78	25.02
			1	7	25.50	24.22	24.87	25.04
			1	14	25.50	24.21	24.81	25.03
			8	0	24.00	23.24	23.69	23.99
			8	4	24.00	23.18	23.74	24.00
			8	7	24.00	23.18	23.74	23.98
			15	0	24.50	23.21	23.76	24.05
		16QAM	1	0	24.50	23.44	23.69	24.45
			1	7	24.50	23.46	23.72	24.45
			1	14	24.50	23.40	23.74	24.44

Band	Band Width	Modulation	RB Configuration		Tune-up (dBm)	Channel/Frequency(MHz)		
			RB Size	RB Offset		18625/1852.5	18900/1880	19175/1907.5
			8	0	23.50	22.21	22.70	23.07
			8	4	23.50	22.21	22.72	23.06
			8	7	23.50	22.22	22.75	23.02
			15	0	23.50	22.14	22.82	23.02
LTE Band 2	5MHz	QPSK	1	0	25.50	24.23	24.77	25.04
			1	12	25.50	24.24	24.84	25.02
			1	24	25.50	24.27	24.84	24.95
			12	0	24.50	23.25	23.73	23.98
			12	6	24.50	23.20	23.76	24.03
			12	11	24.50	23.11	23.79	23.93
			25	0	24.00	23.23	23.77	23.95
		16QAM	1	0	24.50	23.65	24.10	24.24
			1	12	24.50	23.64	24.17	24.23
			1	24	24.50	23.64	24.10	24.12
			12	0	23.00	22.13	22.76	22.92
			12	6	23.00	22.15	22.79	23.00
			12	11	23.00	22.10	22.81	22.91
			25	0	23.00	22.23	22.75	22.94
			RB Configuration		Tune-up (dBm)	Channel/Frequency(MHz)		
			RB Size	RB Offset		18650/1855	18900/1880	19150/1905
LTE Band 2	10MHz	QPSK	1	0	25.00	24.30	24.64	24.46
			1	24	25.00	24.35	24.82	24.54
			1	49	25.00	24.37	24.50	24.50
			25	0	24.50	23.26	23.66	23.83
			25	12	24.50	23.23	23.81	23.97
			25	24	24.50	23.17	23.89	24.02
			50	0	24.00	23.26	23.75	23.98
		16QAM	1	0	24.00	23.10	23.81	23.62
			1	24	24.00	23.19	23.80	23.66
			1	49	24.00	23.16	23.89	23.70
			25	0	23.50	22.26	22.66	22.85
			25	12	23.50	22.21	22.81	23.01

Band	Band Width	Modulation	RB Configuration		Tune-up (dBm)	Channel/Frequency(MHz)		
			RB Size	RB Offset		18675/1857.5	18900/1880	19125/1902.5
			25	24	23.50	22.16	22.91	23.01
			50	0	23.00	22.24	22.74	22.96
LTE Band 2	15MHz	QPSK	1	0	24.50	23.73	24.03	24.32
			1	37	24.50	23.86	24.26	24.49
			1	74	24.50	23.89	24.12	24.49
			36	0	24.50	23.25	23.59	23.85
			36	18	24.50	23.28	23.74	23.97
			36	37	24.50	23.25	23.80	24.08
			75	0	24.50	23.28	23.74	24.03
		16QAM	1	0	24.00	22.84	23.22	23.76
			1	37	24.00	22.98	23.44	23.95
			1	74	24.00	23.08	23.31	23.90
			36	0	23.50	22.36	22.57	22.91
			36	18	23.50	22.36	22.72	23.01
			36	37	23.50	22.35	22.76	23.11
			75	0	23.00	22.29	22.73	22.98
Band	Band Width	Modulation	RB Configuration		Tune-up (dBm)	Channel/Frequency(MHz)		
			RB Size	RB Offset		18700/1860	18900/1880	19100/1900
LTE Band 2	20MHz	QPSK	1	0	24.50	23.67	24.07	24.21
			1	49	24.50	23.89	24.35	24.43
			1	99	24.50	24.06	24.17	24.46
			50	0	24.50	23.39	23.56	24.03
			50	24	24.50	23.35	23.77	23.99
			50	49	24.50	23.39	23.81	24.24
			100	0	24.50	23.39	23.69	24.12
		16QAM	1	0	24.00	22.91	23.45	23.45
			1	49	24.00	23.10	23.69	23.69
			1	99	24.00	23.26	23.57	23.75
			50	0	23.50	22.45	22.57	23.01
			50	24	23.50	22.36	22.80	22.91
			50	49	23.50	22.35	22.86	23.24
			100	0	23.50	22.39	22.67	23.11

Band	Band Width	Modulation	RB Configuration		Tune-up (dBm)	Channel/Frequency(MHz)		
			RB Size	RB Offset		19957/1710.7	20175/1732.5	20393/1754.3
LTE Band 4	1.4MHz	QPSK	1	0	25.00	23.93	24.29	24.00
			1	2	25.00	24.95	24.29	24.00
			1	5	25.00	24.87	24.26	23.98
			3	0	25.00	24.87	24.26	24.00
			3	1	25.00	24.87	24.25	24.00
			3	2	25.00	24.84	24.25	23.97
		16QAM	6	0	24.00	23.91	23.24	22.98
			1	0	24.50	24.17	23.16	23.17
			1	2	24.50	24.15	23.18	23.19
			1	5	24.50	24.15	23.14	23.17
			3	0	24.50	24.13	23.37	23.17
			3	1	24.50	24.13	23.38	23.17
			3	2	24.50	24.14	23.39	23.13
			6	0	23.50	23.07	22.36	22.16
Band	Band Width	Modulation	RB Configuration		Tune-up (dBm)	Channel/Frequency(MHz)		
			RB Size	RB Offset		19965/1711.5	20175/1732.5	20385/1753.5
LTE Band 4	3MHz	QPSK	1	0	25.00	24.92	24.25	24.05
			1	7	25.00	24.84	24.24	24.05
			1	14	25.00	24.83	24.19	24.02
			8	0	24.00	23.88	23.18	22.95
			8	4	24.00	23.91	23.23	22.97
			8	7	24.00	23.84	23.15	22.98
			15	0	24.00	23.84	23.19	22.98
		16QAM	1	0	24.50	24.34	23.51	22.92
			1	7	24.50	24.34	23.47	22.91
			1	14	24.50	24.26	23.41	22.86
			8	0	23.00	22.94	22.22	21.98
			8	4	23.00	22.92	22.21	21.97
			8	7	23.00	22.86	22.19	21.95
			15	0	23.00	22.89	22.15	22.06
Ban	Band	Modulatio	RB		Tune-u	Channel/Frequency(MHz)		

d	Width	n	Configuratio n		p (dBm)			
			RB Size	RB Offset		19975/1712. 5	20175/1732. 5	20375/1752. 5
LTE Band 4	5MHz	QPSK	1	0	25.00	24.97	24.36	24.09
			1	12	25.00	24.93	24.30	24.08
			1	24	25.00	24.94	24.19	24.07
			12	0	24.00	23.91	23.31	23.03
			12	6	24.00	23.90	23.22	23.00
			12	11	24.00	23.80	23.11	22.96
			25	0	24.00	23.91	23.24	23.00
		16QAM	1	0	24.50	24.38	23.65	23.56
			1	12	24.50	24.32	23.60	23.57
			1	24	24.50	24.31	23.51	23.55
			12	0	23.00	22.82	22.25	22.05
			12	6	23.00	22.81	22.23	21.99
			12	11	23.00	22.76	22.17	21.95
			25	0	23.00	22.90	22.21	21.98
Band	Band Width	Modulatio n	RB Configuratio n		Tune-u p (dBm)	Channel/Frequency(MHz)		
			RB Size	RB Offset		20000/1715	20175/1732. 5	20350/1750
LTE Band 4	10MHz	QPSK	1	0	25.00	24.93	24.38	24.04
			1	24	25.00	24.86	24.32	24.08
			1	49	25.00	24.74	24.16	24.03
			25	0	24.00	23.90	23.29	23.02
			25	12	24.00	23.88	23.21	22.99
			25	24	24.00	23.73	23.20	22.92
			50	0	24.00	23.88	23.30	23.01
		16QAM	1	0	24.50	24.09	23.28	23.43
			1	24	24.50	24.01	23.20	23.48
			1	49	24.50	23.88	23.04	23.40
			25	0	23.00	22.91	22.31	22.05
			25	12	23.00	22.86	22.24	22.02
			25	24	23.00	22.71	22.22	21.97
			50	0	23.00	22.87	22.26	22.01
Band	Band Width	Modulatio n	RB Configuratio n		Tune-u p (dBm)	Channel/Frequency(MHz)		

LTE Band 5	1.4MHz	QPSK	1	0	24.50	23.23	24.20	24.22
			1	2	24.50	24.27	24.21	24.21
			1	5	24.50	24.27	24.23	24.21
			3	0	24.50	24.19	24.24	24.14
			3	1	24.50	24.17	24.22	24.18
			3	2	24.50	24.14	24.21	24.15
			6	0	23.50	23.21	23.19	23.14
		16QAM	1	0	24.00	23.46	23.08	23.36
			1	2	24.00	23.45	23.11	23.33
			1	5	24.00	23.52	23.09	23.35
			3	0	23.50	23.44	23.36	23.32
			3	1	23.50	23.44	23.35	23.35
			3	2	23.50	23.43	23.33	23.33
			6	0	22.50	22.38	22.32	22.32
Band	Band Width	Modulation	RB Configuration		Tune-up (dBm)	Channel/Frequency(MHz)		
			RB Size	RB Offset		20415/825.5	20525/836.5	20635/847.5
LTE Band 5	3MHz	QPSK	1	0	24.50	24.21	24.21	24.17
			1	7	24.50	24.29	24.25	24.16
			1	14	24.50	24.21	24.21	24.13
			8	0	23.50	23.23	23.12	23.10
			8	4	23.50	23.20	23.15	23.10
			8	7	23.50	23.23	23.18	23.12
			15	0	23.50	23.23	23.19	23.11
		16QAM	1	0	24.00	23.49	23.11	23.52
			1	7	24.00	23.50	23.11	23.55
			1	14	24.00	23.48	23.09	23.55
			8	0	22.50	22.23	22.15	22.11
			8	4	22.50	22.19	22.16	22.10
			8	7	22.50	22.23	22.17	22.16
			15	0	22.50	22.19	22.23	22.14
Band	Band Width	Modulation	RB Configuration		Tune-up (dBm)	Channel/Frequency(MHz)		
			RB Size	RB Offset		20425/826.5	20525/836.5	20625/846.5
LTE Band 5	5MHz	QPSK	1	0	24.50	24.34	24.26	24.21
			1	12	24.50	24.36	24.27	24.20
			1	24	24.50	24.41	24.27	24.24
			12	0	23.50	23.22	23.20	23.16

Band	Band Width	Modulation	RB Configuration		Tune-up (dBm)	Channel/Frequency(MHz)		
			RB Size	RB Offset		20450/829	20525/836.5	20600/844
			12	6	23.50	23.28	23.22	23.11
			12	11	23.50	23.28	23.14	23.09
			25	0	23.50	23.30	23.21	23.15
		16QAM	1	0	24.00	23.75	23.54	23.63
			1	12	24.00	23.70	23.55	23.59
			1	24	24.00	23.73	23.59	23.67
			12	0	22.50	22.21	22.20	22.10
			12	6	22.50	22.22	22.21	22.10
			12	11	22.50	22.21	22.17	22.11
			25	0	22.50	22.34	22.15	22.16
LTE Band 5	10MHz	QPSK	1	0	24.50	24.30	24.24	24.21
			1	24	24.50	24.33	24.30	24.23
			1	49	24.50	24.27	24.23	24.11
			25	0	23.50	23.26	23.14	23.18
			25	12	23.50	23.27	23.21	23.14
			25	24	23.50	23.26	23.24	23.15
			50	0	23.50	23.31	23.22	23.19
		16QAM	1	0	24.00	23.23	23.60	23.39
			1	24	24.00	23.27	23.66	23.37
			1	49	24.00	23.10	23.60	23.32
			25	0	22.50	22.25	22.19	22.22
			25	12	22.50	22.27	22.23	22.17
			25	24	22.50	22.24	22.24	22.13
			50	0	22.50	22.25	22.21	22.20

Band	Band Width	Modulation	RB Configuration		Tune-up (dBm)	Channel/Frequency(MHz)		
			RB Size	RB Offset		20775/2502.5	21100/2535	21425/2567.5
LTE Band 7	5MHz	QPSK	1	0	25.50	25.35	24.83	24.81
			1	12	25.50	25.26	24.85	24.88
			1	24	25.50	25.24	24.87	24.86
			12	0	25.00	24.76	24.27	24.32
			12	6	25.00	24.70	24.28	24.28
			12	11	25.00	24.71	24.29	24.29
			25	0	25.00	24.71	24.34	24.30

Band	Band Width	Modulation	RB Configuration		Tune-up (dBm)	Channel/Frequency(MHz)		
			RB Size	RB Offset		20800/2505	21100/2535	21400/2565
		16QAM	1	0	25.00	24.69	24.14	24.26
			1	12	25.00	24.66	24.17	24.30
			1	24	25.00	24.60	24.16	24.29
			12	0	24.00	23.71	23.28	23.31
			12	6	24.00	23.66	23.30	23.29
			12	11	24.00	23.64	23.29	23.27
			25	0	24.00	23.74	23.27	23.28
LTE Band 7	10MHz	QPSK	1	0	25.50	25.24	24.83	24.74
			1	24	25.50	25.19	24.88	24.79
			1	49	25.50	25.19	24.87	24.78
			25	0	25.00	24.69	24.30	24.32
			25	12	25.00	24.62	24.29	24.32
			25	24	25.00	24.66	24.40	24.33
			50	0	25.00	24.69	24.34	24.37
		16QAM	1	0	24.50	24.10	24.21	23.96
			1	24	24.50	24.05	24.29	24.00
			1	49	24.50	24.00	24.28	24.01
			25	0	24.00	23.70	23.34	23.32
			25	12	24.00	23.64	23.33	23.31
			25	24	24.00	23.65	23.43	23.39
			50	0	24.00	23.69	23.37	23.36
Band	Band Width	Modulation	RB Configuration		Tune-up (dBm)	Channel/Frequency(MHz)		
			RB Size	RB Offset		20825/2507.5	21100/2535	21375/2562.5
LTE Band 7	15MHz	QPSK	1	0	25.00	25.00	24.74	24.60
			1	37	25.00	25.00	24.82	24.67
			1	74	25.00	24.79	24.78	24.61
			36	0	25.00	24.63	24.26	24.26
			36	18	25.00	24.62	24.30	24.31
			36	37	25.00	24.54	24.32	24.33
			75	0	25.00	24.63	24.38	24.33
		16QAM	1	0	25.00	24.58	23.96	23.83
			1	37	25.00	24.52	24.00	23.94
			1	74	25.00	24.41	24.00	23.89
			36	0	24.00	23.68	23.41	23.20

Band	Band Width	Modulation	RB Configuration		Tune-up (dBm)	Channel/Frequency(MHz)		
			RB Size	RB Offset		20850/2510	21100/2535	21350/2560
						36	18	24.00
			36	37	24.00	23.55	23.42	23.30
			75	0	24.00	23.62	23.34	23.34
LTE Band 7	20MHz	QPSK	1	0	25.50	25.06	24.78	24.66
			1	49	25.50	25.08	24.87	24.84
			1	99	25.50	24.89	24.85	24.76
			50	0	25.00	24.65	24.30	24.27
			50	24	25.00	24.66	24.41	24.36
			50	49	25.00	24.58	24.45	24.36
			100	0	25.00	24.57	24.36	24.36
		16QAM	1	0	24.50	24.33	24.03	24.05
			1	49	24.50	24.38	24.13	24.28
			1	99	24.50	24.17	24.12	24.22
			50	0	24.00	23.57	23.33	23.35
			50	24	24.00	23.63	23.42	23.40
			50	49	24.00	23.58	23.45	23.38
			100	0	24.00	23.62	23.33	23.34

Band	Band Width	Modulation	RB Configuration		Tune-up (dBm)	Channel/Frequency(MHz)		
			RB Size	RB Offset		23017/699.7	23095/707.5	23173/715.3
			LTE Band 12	1.4MHz	QPSK	1	0	24.00
1	2	24.00				23.85	23.67	23.45
1	5	24.00				23.77	23.67	23.42
3	0	24.00				23.76	23.70	23.44
3	1	24.00				23.75	23.68	23.44
3	2	24.00				23.73	23.67	23.41
6	0	23.00				22.78	22.67	22.40
16QAM	1	0			23.50	23.03	22.59	22.60
	1	2			23.50	23.05	22.59	22.61
	1	5			23.50	23.04	22.54	22.60
	3	0			23.50	23.03	22.84	22.61
	3	1			23.50	23.02	22.81	22.57
	3	2			23.50	23.04	22.82	22.58
	6	0			22.00	21.92	21.79	21.58

Band	Band Width	Modulation	RB Configuration		Tune-up (dBm)	Channel/Frequency(MHz)		
			RB Size	RB Offset		23025/700.5	23095/707.5	23165/714.5
LTE Band 12	3MHz	QPSK	1	0	24.00	23.80	23.69	23.45
			1	7	24.00	23.77	23.64	23.48
			1	14	24.00	23.71	23.58	23.41
			8	0	23.00	22.74	22.62	22.39
			8	4	23.00	22.75	22.66	22.37
			8	7	23.00	22.72	22.53	22.37
			15	0	23.00	22.77	22.62	22.37
		16QAM	1	0	23.50	23.22	22.90	22.35
			1	7	23.50	23.26	22.84	22.32
			1	14	23.50	23.17	22.80	22.28
			8	0	22.00	21.79	21.65	21.47
			8	4	22.00	21.81	21.68	21.38
			8	7	22.00	21.75	21.56	21.37
15	0	22.00	21.80	21.54	21.43			
Band	Band Width	Modulation	RB Configuration		Tune-up (dBm)	Channel/Frequency(MHz)		
			RB Size	RB Offset		23035/701.5	23095/707.5	23155/713.5
LTE Band 12	5MHz	QPSK	1	0	24.00	23.84	23.69	23.56
			1	12	24.00	23.82	23.68	23.52
			1	24	24.00	23.82	23.61	23.50
			12	0	23.00	22.78	22.63	22.52
			12	6	23.00	22.70	22.64	22.45
			12	11	23.00	22.69	22.62	22.35
			25	0	23.00	22.75	22.63	22.43
		16QAM	1	0	23.50	23.23	22.99	22.92
			1	12	23.50	23.18	22.99	22.81
			1	24	23.50	23.18	22.92	22.86
			12	0	22.00	21.72	21.62	21.53
			12	6	22.00	21.65	21.68	21.45
			12	11	22.00	21.64	21.67	21.32
25	0	22.00	21.72	21.60	21.43			
Band	Band Width	Modulation	RB Configuration		Tune-up (dBm)	Channel/Frequency(MHz)		
			RB Size	RB Offset		23060/704	23095/707.5	23130/711

LTE Band 12	10MHz	QPSK	1	0	24.00	23.81	23.23	23.23
			1	24	24.00	23.76	23.27	23.06
			1	49	24.00	23.50	23.07	22.95
			25	0	23.00	22.82	22.70	22.48
			25	12	23.00	22.75	22.62	22.54
			25	24	23.00	22.80	22.62	22.30
			50	0	23.00	22.83	22.70	22.41
		16QAM	1	0	23.50	22.85	22.38	22.10
			1	24	23.50	23.09	22.35	21.96
			1	49	23.50	22.84	22.27	21.83
			25	0	22.00	21.85	21.69	21.49
			25	12	22.00	21.77	21.66	21.53
			25	24	22.00	21.80	21.67	21.34
			50	0	22.00	21.79	21.68	21.43

Band	Band Width	Modulation	RB Configuration		Tune-up (dBm)	Channel/Frequency(MHz)		
			RB Size	RB Offset		23755/706.5	23790/710	23825/713.5
LTE Band 17	5MHz	QPSK	1	0	23.50	23.43	23.42	23.29
			1	12	23.50	23.41	23.33	23.25
			1	24	23.50	23.39	23.25	23.24
			12	0	23.00	22.87	22.74	22.77
			12	6	23.00	22.88	22.76	22.65
			12	11	23.00	22.82	22.67	22.57
			25	0	23.00	22.85	22.73	22.65
		16QAM	1	0	23.00	22.82	22.70	22.77
			1	12	23.00	22.75	22.62	22.71
			1	24	23.00	22.74	22.54	22.71
			12	0	22.00	21.83	21.76	21.74
			12	6	22.00	21.80	21.77	21.64
			12	11	22.00	21.78	21.68	21.55
			25	0	22.00	21.88	21.70	21.64
Band	Band Width	Modulation	RB Configuration		Tune-up (dBm)	Channel/Frequency(MHz)		
			RB Size	RB Offset		23780/709	23790/710	23800/711
LTE Band 17	10MHz	QPSK	1	0	23.50	23.36	23.35	23.37
			1	24	23.50	23.36	23.27	23.32
			1	49	23.50	23.15	23.17	23.20

			25	0	23.00	22.77	22.74	22.73
			25	12	23.00	22.79	22.73	22.75
			25	24	23.00	22.72	22.62	22.56
			50	0	23.00	22.74	22.71	22.67
		16QAM	1	0	23.00	22.80	22.56	22.23
			1	24	23.00	22.77	22.48	22.16
			1	49	23.00	22.65	22.37	22.08
			25	0	22.00	21.82	21.75	21.71
			25	12	22.00	21.85	21.78	21.73
			25	24	22.00	21.76	21.61	21.57
			50	0	22.00	21.72	21.72	21.65

7.4. NR SA Power

Band	SCS (kHz)	Bandwidth (MHz)	UL Channel	RB Allocation	Modulation	Tune-up	Power (dBm)
n78	30	10	630334	1@1	DFT_BPSK	20.00	19.55
n78	30	10	630334	24@0	DFT_QPSK	20.00	18.73
n78	30	10	630334	12@6	DFT_QPSK	20.00	19.63
n78	30	10	630334	1@1	DFT_QPSK	20.00	19.53
n78	30	10	630334	1@22	DFT_QPSK	20.00	19.60
n78	30	10	630334	1@1	DFT_QAM16	20.00	18.57
n78	30	10	630334	1@1	DFT_QAM64	18.00	17.28
n78	30	10	630334	1@1	DFT_QAM256	16.00	15.29
n78	30	10	630334	1@1	CP_QPSK	19.00	18.14
n78	30	10	633333	1@1	DFT_BPSK	20.00	19.60
n78	30	10	633333	24@0	DFT_QPSK	20.00	18.64
n78	30	10	633333	12@6	DFT_QPSK	20.00	19.55
n78	30	10	633333	1@1	DFT_QPSK	20.00	19.55
n78	30	10	633333	1@22	DFT_QPSK	20.00	19.38
n78	30	10	633333	1@1	DFT_QAM16	20.50	18.57
n78	30	10	633333	1@1	DFT_QAM64	18.00	17.29
n78	30	10	633333	1@1	DFT_QAM256	17.00	15.32
n78	30	10	633333	1@1	CP_QPSK	19.00	18.11
n78	30	10	636333	1@1	DFT_BPSK	20.00	19.73
n78	30	10	636333	24@0	DFT_QPSK	19.00	18.84
n78	30	10	636333	12@6	DFT_QPSK	20.50	19.77
n78	30	10	636333	1@1	DFT_QPSK	20.50	19.70
n78	30	10	636333	1@22	DFT_QPSK	20.50	19.76

n78	30	10	636333	1@1	DFT_QAM16	20.50	18.76
n78	30	10	636333	1@1	DFT_QAM64	18.00	17.57
n78	30	10	636333	1@1	DFT_QAM256	20.50	15.59
n78	30	10	636333	1@1	CP_QPSK	19.00	18.37
n78	30	15	630500	1@1	DFT_BPSK	20.50	19.60
n78	30	15	630500	36@0	DFT_QPSK	20.50	18.69
n78	30	15	630500	18@9	DFT_QPSK	20.50	19.75
n78	30	15	630500	1@1	DFT_QPSK	20.50	19.51
n78	30	15	630500	1@36	DFT_QPSK	20.50	19.43
n78	30	15	630500	1@1	DFT_QAM16	20.50	18.60
n78	30	15	630500	1@1	DFT_QAM64	18.00	17.21
n78	30	15	630500	1@1	DFT_QAM256	17.00	15.23
n78	30	15	630500	1@1	CP_QPSK	19.00	18.12
n78	30	15	633333	1@1	DFT_BPSK	20.50	19.64
n78	30	15	633333	36@0	DFT_QPSK	20.50	18.66
n78	30	15	633333	18@9	DFT_QPSK	20.50	19.60
n78	30	15	633333	1@1	DFT_QPSK	20.50	19.55
n78	30	15	633333	1@36	DFT_QPSK	20.50	19.30
n78	30	15	633333	1@1	DFT_QAM16	20.50	18.68
n78	30	15	633333	1@1	DFT_QAM64	18.00	17.27
n78	30	15	633333	1@1	DFT_QAM256	16.00	15.26
n78	30	15	633333	1@1	CP_QPSK	19.00	18.13
n78	30	15	636166	1@1	DFT_BPSK	20.50	19.72
n78	30	15	636166	36@0	DFT_QPSK	19.00	18.86
n78	30	15	636166	18@9	DFT_QPSK	20.50	19.77
n78	30	15	636166	1@1	DFT_QPSK	20.50	19.66
n78	30	15	636166	1@36	DFT_QPSK	20.50	19.66
n78	30	15	636166	1@1	DFT_QAM16	19.00	18.73
n78	30	15	636166	1@1	DFT_QAM64	18.00	17.43
n78	30	15	636166	1@1	DFT_QAM256	16.00	15.51
n78	30	15	636166	1@1	CP_QPSK	19.00	18.37
n78	30	20	630667	1@1	DFT_BPSK	20.50	19.53
n78	30	20	630667	50@0	DFT_QPSK	19.00	18.67
n78	30	20	630667	25@12	DFT_QPSK	20.50	19.64
n78	30	20	630667	1@1	DFT_QPSK	20.50	19.51
n78	30	20	630667	1@49	DFT_QPSK	20.50	19.32
n78	30	20	630667	1@1	DFT_QAM16	19.00	18.53
n78	30	20	630667	1@1	DFT_QAM64	18.00	17.25
n78	30	20	630667	1@1	DFT_QAM256	16.00	15.27

n78	30	20	630667	1@1	CP_QPSK	19.00	18.05
n78	30	20	633333	1@1	DFT_BPSK	20.50	19.53
n78	30	20	633333	50@0	DFT_QPSK	20.50	18.62
n78	30	20	633333	25@12	DFT_QPSK	20.50	19.62
n78	30	20	633333	1@1	DFT_QPSK	20.50	19.54
n78	30	20	633333	1@49	DFT_QPSK	20.50	19.30
n78	30	20	633333	1@1	DFT_QAM16	20.50	18.48
n78	30	20	633333	1@1	DFT_QAM64	18.00	17.35
n78	30	20	633333	1@1	DFT_QAM256	16.00	15.26
n78	30	20	633333	1@1	CP_QPSK	19.00	18.07
n78	30	20	636000	1@1	DFT_BPSK	20.50	19.62
n78	30	20	636000	50@0	DFT_QPSK	20.50	18.78
n78	30	20	636000	25@12	DFT_QPSK	20.50	19.75
n78	30	20	636000	1@1	DFT_QPSK	20.50	19.62
n78	30	20	636000	1@49	DFT_QPSK	20.50	19.63
n78	30	20	636000	1@1	DFT_QAM16	20.50	18.67
n78	30	20	636000	1@1	DFT_QAM64	18.00	17.30
n78	30	20	636000	1@1	DFT_QAM256	16.00	15.41
n78	30	20	636000	1@1	CP_QPSK	19.00	18.23
n78	30	40	631334	1@1	DFT_BPSK	20.50	19.18
n78	30	40	631334	100@0	DFT_QPSK	19.00	18.53
n78	30	40	631334	50@25	DFT_QPSK	20.50	19.48
n78	30	40	631334	1@1	DFT_QPSK	20.50	19.14
n78	30	40	631334	1@104	DFT_QPSK	20.50	19.02
n78	30	40	631334	1@1	DFT_QAM16	20.50	18.18
n78	30	40	631334	1@1	DFT_QAM64	18.00	16.87
n78	30	40	631334	1@1	DFT_QAM256	16.00	14.97
n78	30	40	631334	1@1	CP_QPSK	19.00	17.76
n78	30	40	633333	1@1	DFT_BPSK	20.50	19.03
n78	30	40	633333	100@0	DFT_QPSK	20.50	18.45
n78	30	40	633333	50@25	DFT_QPSK	20.50	19.51
n78	30	40	633333	1@1	DFT_QPSK	20.50	18.95
n78	30	40	633333	1@104	DFT_QPSK	20.50	18.88
n78	30	40	633333	1@1	DFT_QAM16	19.00	18.05
n78	30	40	633333	1@1	DFT_QAM64	17.00	16.71
n78	30	40	633333	1@1	DFT_QAM256	15.00	14.75
n78	30	40	633333	1@1	CP_QPSK	18.00	17.59
n78	30	40	635333	1@1	DFT_BPSK	20.50	19.01
n78	30	40	635333	100@0	DFT_QPSK	19.00	18.57

n78	30	40	635333	50@25	DFT_QPSK	20.50	19.68
n78	30	40	635333	1@1	DFT_QPSK	20.50	18.93
n78	30	40	635333	1@104	DFT_QPSK	20.50	19.22
n78	30	40	635333	1@1	DFT_QAM16	19.00	18.00
n78	30	40	635333	1@1	DFT_QAM64	17.00	16.64
n78	30	40	635333	1@1	DFT_QAM256	15.00	14.73
n78	30	40	635333	1@1	CP_QPSK	18.00	17.60
n78	30	50	631667	1@1	DFT_BPSK	20.00	19.47
n78	30	50	631667	128@0	DFT_QPSK	19.00	18.59
n78	30	50	631667	64@32	DFT_QPSK	20.50	19.50
n78	30	50	631667	1@1	DFT_QPSK	20.50	19.36
n78	30	50	631667	1@131	DFT_QPSK	20.50	19.19
n78	30	50	631667	1@1	DFT_QAM16	19.00	18.48
n78	30	50	631667	1@1	DFT_QAM64	18.00	17.07
n78	30	50	631667	1@1	DFT_QAM256	16.00	15.16
n78	30	50	631667	1@1	CP_QPSK	18.00	17.98
n78	30	50	633333	1@1	DFT_BPSK	20.50	19.23
n78	30	50	633333	128@0	DFT_QPSK	20.50	18.48
n78	30	50	633333	64@32	DFT_QPSK	20.50	19.53
n78	30	50	633333	1@1	DFT_QPSK	20.50	19.18
n78	30	50	633333	1@131	DFT_QPSK	20.00	19.19
n78	30	50	633333	1@1	DFT_QAM16	19.00	18.19
n78	30	50	633333	1@1	DFT_QAM64	17.00	16.86
n78	30	50	633333	1@1	DFT_QAM256	15.00	14.99
n78	30	50	633333	1@1	CP_QPSK	18.00	17.80
n78	30	50	635000	1@1	DFT_BPSK	20.00	19.44
n78	30	50	635000	128@0	DFT_QPSK	19.00	18.66
n78	30	50	635000	64@32	DFT_QPSK	20.00	19.64
n78	30	50	635000	1@1	DFT_QPSK	20.00	19.36
n78	30	50	635000	1@131	DFT_QPSK	20.00	19.44
n78	30	50	635000	1@1	DFT_QAM16	20.50	18.39
n78	30	50	635000	1@1	DFT_QAM64	18.00	17.21
n78	30	50	635000	1@1	DFT_QAM256	16.00	15.31
n78	30	50	635000	1@1	CP_QPSK	16.00	15.78
n78	30	60	632000	1@1	DFT_BPSK	19.00	18.00
n78	30	60	632000	162@0	DFT_QPSK	19.00	18.64
n78	30	60	632000	81@40	DFT_QPSK	19.00	18.70
n78	30	60	632000	1@1	DFT_QPSK	20.00	19.39
n78	30	60	632000	1@160	DFT_QPSK	19.00	18.50

n78	30	60	632000	1@1	DFT_QAM16	19.00	18.47
n78	30	60	632000	1@1	DFT_QAM64	18.00	17.14
n78	30	60	632000	1@1	DFT_QAM256	16.00	15.17
n78	30	60	632000	1@1	CP_QPSK	19.00	18.09
n78	30	60	633333	1@1	DFT_BPSK	20.50	19.16
n78	30	60	633333	162@0	DFT_QPSK	20.50	18.42
n78	30	60	633333	81@40	DFT_QPSK	20.50	19.52
n78	30	60	633333	1@1	DFT_QPSK	20.50	19.07
n78	30	60	633333	1@160	DFT_QPSK	20.50	19.23
n78	30	60	633333	1@1	DFT_QAM16	20.50	18.22
n78	30	60	633333	1@1	DFT_QAM64	18.00	16.89
n78	30	60	633333	1@1	DFT_QAM256	16.00	14.88
n78	30	60	633333	1@1	CP_QPSK	18.00	17.72
n78	30	60	634666	1@1	DFT_BPSK	20.50	19.44
n78	30	60	634666	162@0	DFT_QPSK	19.00	18.63
n78	30	60	634666	81@40	DFT_QPSK	20.50	19.54
n78	30	60	634666	1@1	DFT_QPSK	20.50	19.32
n78	30	60	634666	1@160	DFT_QPSK	20.50	19.35
n78	30	60	634666	1@1	DFT_QAM16	19.00	18.41
n78	30	60	634666	1@1	DFT_QAM64	18.00	17.23
n78	30	60	634666	1@1	DFT_QAM256	16.00	15.28
n78	30	60	634666	1@1	CP_QPSK	19.00	18.10
n78	30	80	632667	1@1	DFT_BPSK	20.50	19.14
n78	30	80	632667	216@0	DFT_QPSK	20.50	18.47
n78	30	80	632667	108@54	DFT_QPSK	20.50	19.51
n78	30	80	632667	1@1	DFT_QPSK	20.50	19.05
n78	30	80	632667	1@215	DFT_QPSK	20.50	18.94
n78	30	80	632667	1@1	DFT_QAM16	20.50	18.14
n78	30	80	632667	1@1	DFT_QAM64	17.00	16.79
n78	30	80	632667	1@1	DFT_QAM256	15.00	14.80
n78	30	80	632667	1@1	CP_QPSK	18.00	17.73
n78	30	80	633333	1@1	DFT_BPSK	20.50	19.19
n78	30	80	633333	216@0	DFT_QPSK	19.00	18.48
n78	30	80	633333	108@54	DFT_QPSK	20.50	19.55
n78	30	80	633333	1@1	DFT_QPSK	20.50	19.09
n78	30	80	633333	1@215	DFT_QPSK	19.00	18.97
n78	30	80	633333	1@1	DFT_QAM16	19.00	18.21
n78	30	80	633333	1@1	DFT_QAM64	17.00	16.87
n78	30	80	633333	1@1	DFT_QAM256	15.00	14.96

n78	30	80	633333	1@1	CP_QPSK	18.00	17.76
n78	30	80	634000	1@1	DFT_BPSK	19.00	18.98
n78	30	80	634000	216@0	DFT_QPSK	19.00	18.48
n78	30	80	634000	108@54	DFT_QPSK	20.00	19.57
n78	30	80	634000	1@1	DFT_QPSK	19.00	18.87
n78	30	80	634000	1@215	DFT_QPSK	20.00	19.04
n78	30	80	634000	1@1	DFT_QAM16	18.00	17.98
n78	30	80	634000	1@1	DFT_QAM64	17.00	16.64
n78	30	80	634000	1@1	DFT_QAM256	15.00	14.69
n78	30	80	634000	1@1	CP_QPSK	18.00	17.60
n78	30	90	633000	1@1	DFT_BPSK	20.50	19.01
n78	30	90	633000	240@0	DFT_QPSK	19.00	18.47
n78	30	90	633000	120@60	DFT_QPSK	20.50	19.45
n78	30	90	633000	1@1	DFT_QPSK	19.00	18.89
n78	30	90	633000	1@243	DFT_QPSK	19.00	18.80
n78	30	90	633000	1@1	DFT_QAM16	18.00	17.92
n78	30	90	633000	1@1	DFT_QAM64	17.00	16.78
n78	30	90	633000	1@1	DFT_QAM256	15.00	14.71
n78	30	90	633000	1@1	CP_QPSK	18.00	17.55
n78	30	90	633333	1@1	DFT_BPSK	20.50	19.09
n78	30	90	633333	240@0	DFT_QPSK	19.00	18.48
n78	30	90	633333	120@60	DFT_QPSK	20.50	19.50
n78	30	90	633333	1@1	DFT_QPSK	19.00	18.93
n78	30	90	633333	1@243	DFT_QPSK	19.00	18.82
n78	30	90	633333	1@1	DFT_QAM16	19.00	18.10
n78	30	90	633333	1@1	DFT_QAM64	17.00	16.73
n78	30	90	633333	1@1	DFT_QAM256	17.00	16.55
n78	30	90	633333	1@1	CP_QPSK	18.00	17.61
n78	30	90	633666	1@1	DFT_BPSK	20.00	19.10
n78	30	90	633666	240@0	DFT_QPSK	19.00	18.51
n78	30	90	633666	120@60	DFT_QPSK	20.50	19.60
n78	30	90	633666	1@1	DFT_QPSK	20.50	19.03
n78	30	90	633666	1@243	DFT_QPSK	20.50	18.95
n78	30	90	633666	1@1	DFT_QAM16	19.00	18.14
n78	30	90	633666	1@1	DFT_QAM64	17.00	16.77
n78	30	90	633666	1@1	DFT_QAM256	15.00	14.70
n78	30	90	633666	1@1	CP_QPSK	18.00	17.64
n78	30	100	633333	1@1	DFT_BPSK	19.00	18.86
n78	30	100	633333	270@0	DFT_QPSK	19.00	18.41

n78	30	100	633333	135@67	DFT_QPSK	20.00	19.51
n78	30	100	633333	1@1	DFT_QPSK	19.00	18.77
n78	30	100	633333	1@271	DFT_QPSK	19.00	18.72
n78	30	100	633333	1@1	DFT_QAM16	18.00	17.82
n78	30	100	633333	1@1	DFT_QAM64	17.00	16.55
n78	30	100	633333	1@1	DFT_QAM256	15.00	14.57
n78	30	100	633333	1@1	CP_QPSK	18.00	17.46

7.5. WLAN & Bluetooth Output Power

7.5.1. Output Power Results Of WLAN

Mode	Channel	Frequency (MHz)	Tune-up (dBm)	Output Power (dBm)
802.11b	1	2412	15.50	15.36
	6	2437	15.50	15.11
	11	2462	15.50	14.70
802.11g	1	2412	14.00	13.53
	6	2437	14.00	13.61
	11	2462	14.00	12.90
802.11n HT20	1	2412	13.00	12.41
	6	2437	13.00	12.58
	11	2462	13.00	11.85
802.11n HT40	3	2422	13.00	12.21
	6	2437	13.00	12.60
	9	2452	13.00	12.29

NOTE: Power measurement results of WLAN 2.4G.

Mode	Channel	Frequency (MHz)	Tune-up (dBm)	Output Power (dBm)
802.11a	36	5180	10.50	10.38
	40	5200	10.50	10.07
	48	5240	10.50	9.13
802.11n HT20	36	5180	11.00	10.75
	40	5200	11.00	10.01
	48	5240	11.00	9.06
802.11n HT40	38	5190	11.00	10.59
	46	5230	11.00	9.14
802.11ac VHT20	36	5180	11.00	10.78
	40	5200	11.00	10.03

	48	5240	11.00	9.10
802.11ac VHT40	38	5190	10.50	10.14
	46	5230	10.50	9.14
802.11ac VHT80	42	5210	10.00	9.50

NOTE: Power measurement results of WLAN 5.2G.

Mode	Channel	Frequency (MHz)	Tune-up (dBm)	Output Power (dBm)
802.11a	149	5745	10.50	10.10
	157	5785	10.50	9.56
	165	5825	10.50	9.14
802.11n HT20	149	5745	10.00	9.56
	157	5785	10.00	9.44
	165	5825	10.00	9.14
802.11n HT40	151	5755	10.00	9.52
	159	5795	10.00	9.44
802.11ac VHT20	149	5745	10.00	9.91
	157	5785	10.00	9.43
	165	5825	10.00	9.03
802.11ac VHT40	151	5755	9.50	9.45
	159	5795	9.50	9.39
802.11ac VHT80	155	5775	9.50	9.38

NOTE: Power measurement results of WLAN 5.8G.

7.5.2. Output Power Results Of Bluetooth

BR+EDR	Output Power (dBm)				
	Channel	Tune-up (dBm)	Data Rates		
			1M	2M	3M
	0CH	7.00	6.48	6.50	6.46
	39CH	6.00	4.88	5.05	5.03
	78CH	7.00	6.09	6.19	6.18

BLE	Channel	Tune-up (dBm)	Output Power (dBm)
	0CH	-6.00	-5.71
	19CH	-7.00	-6.80
	39CH	-7.00	-6.37

8. Antenna Location

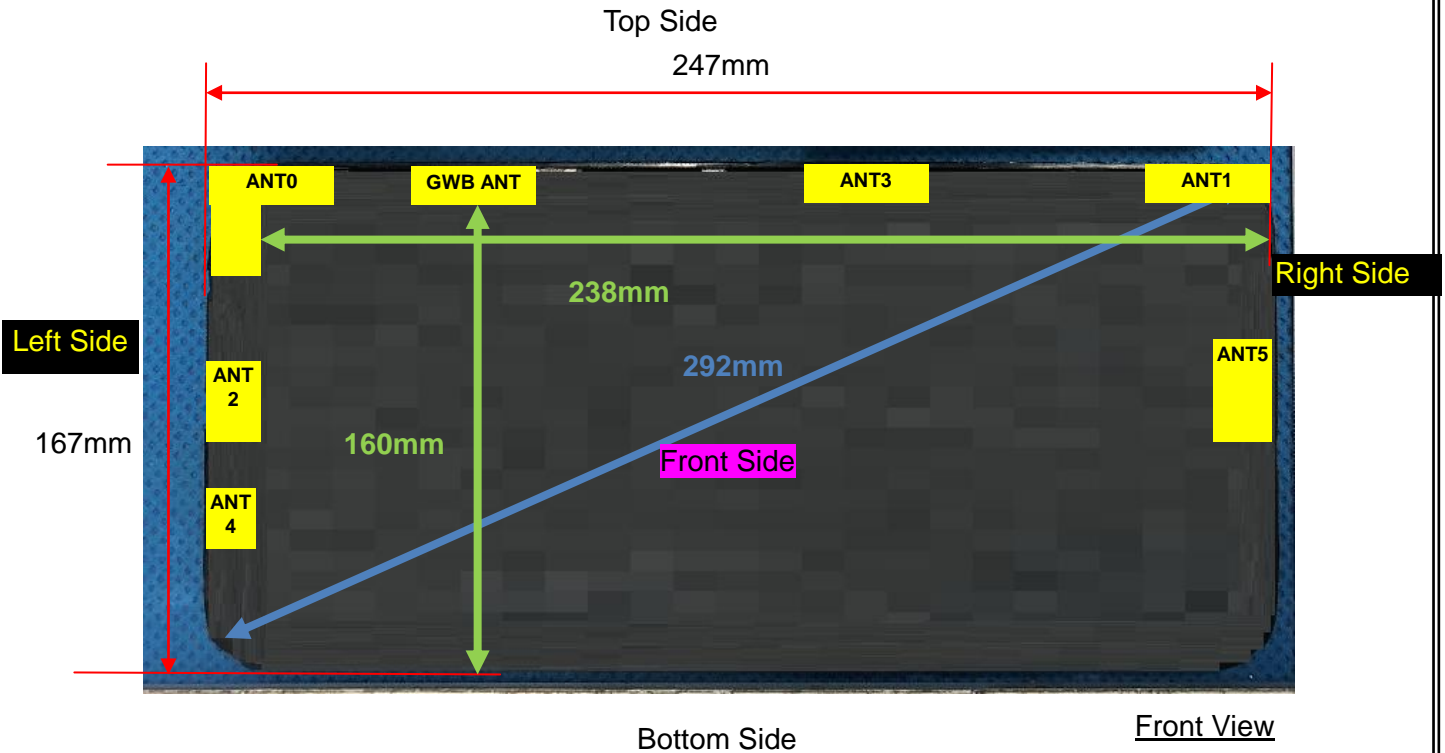

Positions for SAR tests						
Antennas	Front Side	Back Side	Left Side	Right Side	Top Side	Bottom Side
ANT 0	YES	YES	YES	YES	YES	YES
ANT 1	YES	YES	YES	YES	YES	YES
ANT 2	YES	YES	YES	YES	YES	YES
ANT 3	YES	YES	YES	YES	YES	YES
ANT 4	YES	YES	YES	YES	YES	YES
ANT 5	YES	YES	YES	YES	YES	YES
WiFi/BT	YES	YES	YES	YES	YES	YES

9. Stand-alone SAR test exclusion

Refer to FCC KDB 447498D01, the 1-g SAR and 10-g SAR test exclusion thresholds for 100 MHz to 6 GHz at test separation distances ≤ 50 mm are determined by:

$[(\text{max. power of channel, including tune-up tolerance, mW}) / (\text{min. test separation distance, mm})] \cdot [\sqrt{f_{\text{GHz}}}] \leq 3.0$ for 1-g SAR and ≤ 7.5 for 10-g extremity SAR, where:

- f_{GHz} is the RF channel transmit frequency in GHz
- Power and distance are rounded to the nearest mW and mm before calculation
- The result is rounded to one decimal place for comparison

When the minimum test separation distance is < 5 mm, a distance of 5 mm is applied to determine SAR test exclusion.

Mode	P_{max}	P_{max}	Distance	f	Calculation	SAR Exclusion	SAR test
------	------------------	------------------	----------	---	-------------	---------------	----------

	(dBm)	(mW)	(mm)	(GHz)	Result	threshold	exclusion
Bluetooth	7.00	5.01	5	2.480	1.57	3	Yes

NOTE: Standalone SAR test exclusion for Bluetooth.

When standalone SAR test exclusion applies to an antenna that transmits simultaneously with other antennas, the standalone SAR must be estimated according to following to determine simultaneous transmission SAR test exclusion:

$[(\text{max. power of channel, including tune-up tolerance, mW})/(\text{min. test separation distance, mm})] * [\sqrt{f_{(\text{GHz})}}/x] \text{ W/kg}$ for test separation distances $\leq 50\text{mm}$, where $x = 7.5$ for 1-g SAR and $x = 18.75$ for 10-g SAR.

When the minimum test separation distance is $< 5 \text{ mm}$, a distance of 5 mm is applied to determine SAR test exclusion.

Mode	Position	P _{max} (dBm)	P _{max} (mW)	Distance (mm)	f (GHz)	x	Estimated SAR (W/Kg)
Bluetooth	Body	7.00	5.01	5	2.48	7.5	0.210
Bluetooth	Hotspot	7.00	5.01	5	2.48	7.5	0.210

NOTE: Estimated SAR calculation for Bluetooth

10. SAR Results

10.1. SAR measurement results

11. SAR Results

11.1. SAR measurement results

11.1.1. SAR measurement Result of GSM850

Test Position of Body-Worn with 0mm	Test channel /Freq.	Test Mode	SAR Value (W/kg)		Power Drift (±5%)	Conducted power (dBm)	Tune-up power (dBm)	Scaled SAR 1g (W/Kg)	Date	Plot
			1g	10g						
Front Side	189/836.4	GPRS(GMSK 2TS)	0.618	0.395	1.26	30.97	31.50	0.698	2023/6/25	
Back Side	189/836.4	GPRS(GMSK 2TS)	1.021	0.679	-4.33	30.97	31.50	1.154	2023/6/25	
Back Side	128/824.2	GPRS(GMSK 2TS)	1.058	0.702	1.89	30.98	31.50	1.193	2023/6/25	1#
Back Side	251/848.8	GPRS(GMSK 2TS)	1.013	0.667	-0.52	31.05	31.50	1.124	2023/6/25	
BackSide Repeated	128/824.2	GPRS(GMSK 2TS)	1.050	0.700	2.01	30.98	31.50	1.184	2023/6/25	

NOTE: Body-Worn SAR test results of GSM850

Test Position of Hotspot with 0mm	Test channel /Freq.	Mode	SAR Value (W/kg)		Power Drift(%)	Conducted Power (dBm)	Tune-up Power (dBm)	Scaled SAR 1-g (W/Kg)	Date	Plot
			1-g	10-g						
			Front Side	189/836.4						
Back Side	189/836.4	GPRS(GMSK 2TS)	1.021	0.679	-4.33	30.97	31.50	1.154	2023/6/25	
Left Side	189/836.4	GPRS(GMSK 2TS)	0.318	0.211	3.51	30.97	31.50	0.359	2023/6/25	
Right Side	189/836.4	GPRS(GMSK 2TS)	0.315	0.209	-0.84	30.97	31.50	0.356	2023/6/25	
Top Side	189/836.4	GPRS(GMSK 2TS)	0.212	0.156	1.02	30.97	31.50	0.240	2023/6/25	
Bottom Side	189/836.4	GPRS(GMSK 2TS)	0.515	0.325	2.29	30.97	31.50	0.582	2023/6/25	
Back Side	128/824.2	GPRS(GMSK 2TS)	1.058	0.702	1.89	30.98	31.50	1.193	2023/6/25	1#
Back Side	251/848.8	GPRS(GMSK 2TS)	1.013	0.667	-0.52	31.05	31.50	1.124	2023/6/25	
BackSide Repeated	128/824.2	GPRS(GMSK 2TS)	1.050	0.700	2.01	30.98	31.50	1.184	2023/6/25	

NOTE: Hotspot SAR test results of GSM850

11.1.2. SAR measurement Result of GSM1900

Test Position of Body-Worn with 0mm	Test channel /Freq.	Test Mode	SAR Value (W/kg)		Power Drift (±5%)	Conducted power (dBm)	Tune-up power (dBm)	Scaled SAR 1g (W/Kg)	Date	Plot
			1g	10g						
			Front Side	661/1880						
Back Side	661/1880	GPRS(GMSK 2TS)	0.753	0.378	1.88	28.15	28.50	0.816	2023/6/21	
Back Side	512/1850.2	GPRS(GMSK 2TS)	0.957	0.481	0.26	28.11	28.50	1.047	2023/6/21	2#
Back Side	810/1909.8	GPRS(GMSK 2TS)	0.667	0.319	1.92	27.89	28.50	0.768	2023/6/21	
BackSide Repeated	512/1850.2	GPRS(GMSK 2TS)	0.951	0.475	0.14	28.11	28.50	1.040	2023/6/21	

NOTE: Body-Worn SAR test results of GSM1900

Test Position of Hotspot with 0mm	Test channel /Freq.	Mode	SAR Value (W/kg)		Power Drift(%)	Conducted Power (dBm)	Tune-up Power (dBm)	Scaled SAR 1-g (W/Kg)	Date	Plot
			1-g	10-g						
Front Side	661/1880	GPRS(GMSK 2TS)	0.480	0.229	-0.16	28.15	28.50	0.520	2023/6/21	
Back Side	661/1880	GPRS(GMSK 2TS)	0.753	0.378	1.88	28.15	28.50	0.816	2023/6/21	
Left Side	661/1880	GPRS(GMSK 2TS)	0.237	0.119	1.69	28.15	28.50	0.257	2023/6/21	
Right Side	661/1880	GPRS(GMSK 2TS)	0.231	0.112	1.01	28.15	28.50	0.250	2023/6/21	
Top Side	661/1880	GPRS(GMSK 2TS)	0.145	0.095	2.03	28.15	28.50	0.157	2023/6/21	
Bottom Side	661/1880	GPRS(GMSK 2TS)	0.400	0.199	1.70	28.15	28.50	0.434	2023/6/21	
Back Side	512/1850.2	GPRS(GMSK 2TS)	0.957	0.481	0.26	28.11	28.50	1.047	2023/6/21	2#
Back Side	810/1909.8	GPRS(GMSK 2TS)	0.667	0.319	1.92	27.89	28.50	0.768	2023/6/21	
BackSide Repeated	512/1850.2	GPRS(GMSK 2TS)	0.951	0.475	0.14	28.11	28.50	1.040	2023/6/21	

NOTE: Hotspot SAR test results of GSM1900

11.1.3. SAR measurement Result of WCDMA Band 2

Test Position of Body-Worn with 0mm	Test channel /Freq.	Test Mode	SAR Value (W/kg)		Power Drift (±5%)	Conducted power (dBm)	Tune-up power (dBm)	Scaled SAR 1g (W/Kg)	Date	Plot
			1g	10g						
Front Side	9400/1880	RMC12.2K	0.444	0.226	-0.87	24.50	25.00	0.498	2023/6/21	
Back Side	9400/1880	RMC12.2K	0.722	0.379	-0.27	24.50	25.00	0.810	2023/6/21	3#
Back Side	9262/1852.4	RMC12.2K	0.612	0.354	2.14	23.95	25.00	0.779	2023/6/21	
Back Side	9538/1907.6	RMC12.2K	0.602	0.342	0.14	27.72	25.00	0.322	2023/6/21	
BackSide Repeated	9400/1880	RMC12.2K	0.718	0.371	1.25	24.50	25.00	0.806	2023/6/21	

NOTE: Body-Worn SAR test results of WCDMA Band 2

Test Position of Hotspot with 0mm	Test channel /Freq.	Mode	SAR Value (W/kg)		Power Drift(%)	Conducted Power (dBm)	Tune-up Power (dBm)	Scaled SAR 1-g (W/Kg)	Date	Plot
			1-g	10-g						
Front Side	9400/1880	RMC12.2K	0.444	0.226	-0.87	24.50	25.00	0.498	2023/6/21	
Back Side	9400/1880	RMC12.2K	0.722	0.379	-0.27	24.50	25.00	0.810	2023/6/21	3#
Left Side	9400/1880	RMC12.2K	0.225	0.115	-3.00	24.50	25.00	0.252	2023/6/21	
Right Side	9400/1880	RMC12.2K	0.228	0.117	-2.90	24.50	25.00	0.256	2023/6/21	
Top Side	9400/1880	RMC12.2K	0.156	0.098	3.02	24.50	25.00	0.175	2023/6/21	
Bottom Side	9400/1880	RMC12.2K	0.375	0.197	2.72	24.50	25.00	0.421	2023/6/21	
Back Side	9262/1852.4	RMC12.2K	0.612	0.354	2.14	23.95	25.00	0.779	2023/6/21	
Back Side	9538/1907.6	RMC12.2K	0.602	0.342	0.14	27.72	25.00	0.322	2023/6/21	
BackSide Repeated	9400/1880	RMC12.2K	0.718	0.371	1.25	24.50	25.00	0.806	2023/6/21	

NOTE: Hotspot SAR test results of WCDMA Band 2

11.1.4. SAR measurement Result of WCDMA Band 4

Test Position of Body-Worn with 0mm	Test channel /Freq.	Test Mode	SAR Value (W/kg)		Power Drift (±5%)	Conducted power (dBm)	Tune-up power (dBm)	Scaled SAR 1g (W/Kg)	Date	Plot
			1g	10g						
Front Side	1413/1732.6	RMC12.2K	0.648	0.347	-2.72	25.48	25.50	0.651	2023/6/26	
Back Side	1413/1732.6	RMC12.2K	1.039	0.585	-0.88	25.48	25.50	1.044	2023/6/26	
Back Side	1312/1712.4	RMC12.2K	1.017	0.576	-0.02	25.50	25.50	1.017	2023/6/26	
Back Side	1513/1752.6	RMC12.2K	1.126	0.634	-0.37	25.49	25.50	1.129	2023/6/26	4#
BackSide Repeated	1513/1752.6	RMC12.2K	1.121	0.628	1.47	25.49	25.50	1.124	2023/6/26	

NOTE: Body-Worn SAR test results of WCDMA Band 4

Test Position of Hotspot	Test channel /Freq.	Mode	SAR Value (W/kg)		Power Drift(%)	Conducted Power (dBm)	Tune-up Power (dBm)	Scaled SAR 1-g (W/Kg)	Date	Plot
			1-g	10-g						

with Omm										
Front Side	1413/1732.6	RMC12.2K	0.648	0.347	-2.72	25.48	25.50	0.651	2023/6/26	
Back Side	1413/1732.6	RMC12.2K	1.039	0.585	-0.88	25.48	25.50	1.044	2023/6/26	
Left Side	1413/1732.6	RMC12.2K	0.312	0.170	-1.16	25.48	25.50	0.313	2023/6/26	
Right Side	1413/1732.6	RMC12.2K	0.324	0.175	-2.28	25.48	25.50	0.325	2023/6/26	
Top Side	1413/1732.6	RMC12.2K	0.158	0.103	3.20	25.48	25.50	0.159	2023/6/26	
Bottom Side	1413/1732.6	RMC12.2K	0.540	0.289	-2.39	25.48	25.50	0.542	2023/6/26	
Back Side	1312/1712.4	RMC12.2K	1.017	0.576	-0.02	25.50	25.50	1.017	2023/6/26	
Back Side	1513/1752.6	RMC12.2K	1.126	0.634	-0.37	25.49	25.50	1.129	2023/6/26	4#
BackSide Repeated	1513/1752.6	RMC12.2K	1.121	0.628	1.47	25.49	25.50	1.124	2023/6/26	

NOTE: Hotspot SAR test results of WCDMA Band 4

11.1.5. SAR measurement Result of WCDMA Band 5

Test Position of Body-Worn with Omm	Test channel /Freq.	Test Mode	SAR Value (W/kg)		Power Drift (±5%)	Conducted power (dBm)	Tune-up power (dBm)	Scaled SAR 1g (W/Kg)	Date	Plot
			1g	10g						
Front Side	4182/836.4	RMC12.2K	0.180	0.125	-2.50	23.57	24.00	0.199	2023/6/25	
Back Side	4182/836.4	RMC12.2K	0.291	0.208	0.15	23.57	24.00	0.321	2023/6/25	5#

NOTE: Body-Worn SAR test results of WCDMA Band 5

Test Position of Hotspot with Omm	Test channel /Freq.	Mode	SAR Value (W/kg)		Power Drift(%)	Conducted Power (dBm)	Tune-up Power (dBm)	Scaled SAR 1-g (W/Kg)	Date	Plot
			1-g	10-g						
Front Side	4182/836.4	RMC12.2K	0.180	0.125	-2.50	23.57	24.00	0.199	2023/6/25	
Back Side	4182/836.4	RMC12.2K	0.291	0.208	0.15	23.57	24.00	0.321	2023/6/25	5#
Left Side	4182/836.4	RMC12.2K	0.093	0.063	-0.85	23.57	24.00	0.103	2023/6/25	
Right Side	4182/836.4	RMC12.2K	0.096	0.067	2.77	23.57	24.00	0.106	2023/6/25	
Top Side	4182/836.4	RMC12.2K	0.052	0.032	1.02	23.57	24.00	0.057	2023/6/25	

Bottom Side	4182/836.4	RMC12.2K	0.165	0.116	-1.27	23.57	24.00	0.182	2023/6/25	
-------------	------------	----------	-------	-------	-------	-------	-------	-------	-----------	--

NOTE: Hotspot SAR test results of WCDMA Band 5

11.1.6. SAR measurement Result of LTE Band 2

Test Position of Body-Worn with 0mm	Test channel /Freq.	Test Mode	SAR Value (W/kg)		Power Drift (±5%)	Conducted power (dBm)	Tune-up power (dBm)	Scaled SAR 1g (W/Kg)	Date	Plot
			1-g	10-g						
1RB										
Front Side	18900/1880	20M QPSK(1,99)	0.516	0.273	3.21	24.17	24.50	0.557	2023/6/21	
Back Side	18900/1880	20M QPSK(1,99)	0.848	0.448	-0.49	24.17	24.50	0.915	2023/6/21	
Back Side	18700/1860	20M QPSK(1,99)	1.004	0.539	0.68	24.06	24.50	1.111	2023/6/21	9#
Back Side	19100/1900	20M QPSK(1,99)	0.680	0.355	0.53	24.46	24.50	0.686	2023/6/21	
BackSide Repeated	18700/1860	20M QPSK(1,99)	1.000	0.532	0.12	24.06	24.50	1.107	2023/6/21	
50%RB										
Front Side	18900/1880	20M QPSK(50,49)	0.279	0.143	3.47	23.81	24.50	0.327	2023/6/21	
Back Side	18900/1880	20M QPSK(50,49)	0.456	0.232	-0.61	23.81	24.50	0.535	2023/6/21	

NOTE: Body-Worn SAR test results of LTE Band 2

Test Position of Hotspot with 0mm	Test channel /Freq.	Mode	SAR Value (W/kg)		Power Drift(%)	Conducted Power (dBm)	Tune-up Power (dBm)	Scaled SAR 1g (W/Kg)	Date	Plot
			1-g	10-g						
1RB										
Front Side	18900/1880	20M QPSK(1,99)	0.516	0.273	3.21	24.17	24.50	0.557	2023/6/21	
Back Side	18900/1880	20M QPSK(1,99)	0.848	0.448	-0.49	24.17	24.50	0.915	2023/6/21	9#
Left Side	18900/1880	20M QPSK(1,99)	0.261	0.138	-1.02	24.17	24.50	0.282	2023/6/21	
Right Side	18900/1880	20M QPSK(1,99)	0.267	0.141	3.95	24.17	24.50	0.288	2023/6/21	

Top Side	18900/1880	20M QPSK(1,99)	0.189	0.110	0.36	24.17	24.50	0.204	2023/6/21	
Bottom Side	18900/1880	20M QPSK(1,99)	0.435	0.228	1.77	24.17	24.50	0.469	2023/6/21	
Back Side	18700/1860	20M QPSK(1,99)	1.004	0.539	0.68	24.06	24.50	1.111	2023/6/21	
Back Side	19100/1900	20M QPSK(1,99)	0.680	0.355	0.53	24.46	24.50	0.686	2023/6/21	
BackSide Repeated	18700/1860	20M QPSK(1,99)	1.000	0.532	0.12	24.06	24.50	1.107	2023/6/21	
50%RB										
Front Side	18900/1880	20M QPSK(50,49)	0.279	0.143	3.47	23.81	24.50	0.327	2023/6/21	
Back Side	18900/1880	20M QPSK(50,49)	0.456	0.232	-0.61	23.81	24.50	0.535	2023/6/21	
Left Side	18900/1880	20M QPSK(50,49)	0.138	0.074	-4.10	23.81	24.50	0.162	2023/6/21	
Right Side	18900/1880	20M QPSK(50,49)	0.145	0.076	1.48	23.81	24.50	0.170	2023/6/21	
Top Side	18900/1880	20M QPSK(50,49)	0.130	0.067	0.20	23.81	24.50	0.152	2023/6/21	
Bottom Side	18900/1880	20M QPSK(50,49)	0.254	0.124	-1.49	23.81	24.50	0.298	2023/6/21	
100%RB										
Back Side	18900/1880	20M QPSK(50,0)	0.387	0.224	1.02	23.69	24.50	0.466	2023/6/21	

NOTE: Hotspot SAR test results of LTE Band 2

11.1.7. SAR measurement Result of LTE Band 4

Test Position of Body-Worn with 0mm	Test channel /Freq.	Test Mode	SAR Value (W/kg)		Power Drift (±5%)	Conducted power (dBm)	Tune-up power (dBm)	Scaled SAR 1g (W/Kg)	Date	Plot
			1-g	10-g						
1RB										
Front Side	20175/1732.5	20M QPSK(1,0)	0.702	0.384	3.34	25.00	25.00	0.702	2023/6/26	
Back Side	20175/1732.5	20M QPSK(1,0)	1.138	0.628	-0.02	25.00	25.00	1.138	2023/6/26	10#
Back Side	20050/1720	20M QPSK(1,0)	1.120	0.623	-0.23	24.95	25.00	1.133	2023/6/26	

Back Side	20300/1745	20M QPSK(1,0)	1.044	0.565	-2.35	24.98	25.00	1.049	2023/6/26	
BackSide Repeated	20175/1732.5	20M QPSK(1,0)	1.136	0.625	1.20	25.00	25.00	1.136	2023/6/26	
50%RB										
Front Side	20175/1732.5	20M QPSK(50,0)	0.415	0.208	-1.72	23.33	24.00	0.484	2023/6/26	
Back Side	20175/1732.5	20M QPSK(50,0)	0.581	0.334	-1.97	23.33	24.00	0.678	2023/6/26	

NOTE: Body-Worn SAR test results of LTE Band 4

Test Position of Hotspot with 0mm	Test channel /Freq.	Mode	SAR Value (W/kg)		Power Drift(%)	Conducted Power (dBm)	Tune-up Power (dBm)	Scaled SAR 1-g (W/Kg)	Date	Plot
			1-g	10-g						
1RB										
Front Side	20175/1732.5	20M QPSK(1,0)	0.702	0.384	3.34	25.00	25.00	0.702	2023/6/26	
Back Side	20175/1732.5	20M QPSK(1,0)	1.138	0.628	-0.02	25.00	25.00	1.138	2023/6/26	10#
Left Side	20175/1732.5	20M QPSK(1,0)	0.342	0.179	-2.33	25.00	25.00	0.342	2023/6/26	
Right Side	20175/1732.5	20M QPSK(1,0)	0.332	0.154	3.87	25.00	25.00	0.332	2023/6/26	
Top Side	20175/1732.5	20M QPSK(1,0)	0.154	0.095	3.02	25.00	25.00	0.154	2023/6/26	
Bottom Side	20175/1732.5	20M QPSK(1,0)	1.026	0.566	0.75	25.00	25.00	1.026	2023/6/26	
Back Side	20050/1720	20M QPSK(1,0)	1.120	0.623	-0.23	24.95	25.00	1.133	2023/6/26	
Back Side	20300/1745	20M QPSK(1,0)	1.044	0.565	-2.35	24.98	25.00	1.049	2023/6/26	
BackSide Repeated	20175/1732.5	20M QPSK(1,0)	1.136	0.625	1.20	25.00	25.00	1.136	2023/6/26	
50%RB										
Front Side	20175/1732.5	20M QPSK(50,0)	0.415	0.208	-1.72	23.33	24.00	0.484	2023/6/26	
Back Side	20175/1732.5	20M QPSK(50,0)	0.581	0.334	-1.97	23.33	24.00	0.678	2023/6/26	
Left Side	20175/1732.5	20M	0.174	0.098	4.66	23.33	24.00	0.203	2023/6/26	

		QPSK(50,0)								
Right Side	20175/1732.5	20M QPSK(50,0)	0.191	0.084	-3.43	23.33	24.00	0.223	2023/6/26	
Top Side	20175/1732.5	20M QPSK(50,0)	0.087	0.048	2.58	23.33	24.00	0.102	2023/6/26	
Bottom Side	20175/1732.5	20M QPSK(50,0)	0.521	0.300	2.63	23.33	24.00	0.608	2023/6/26	
100%RB										
Back Side	20175/1732.5	20M QPSK(50,0)	0.470	0.285	0.17	23.31	24.00	0.551	2023/6/26	

NOTE: Hotspot SAR test results of LTE Band 4

11.1.8. SAR measurement Result of LTE Band 5

Test Position of Body-Worn with 0mm	Test channel /Freq.	Test Mode	SAR Value (W/kg)		Power Drift (±5%)	Conducted power (dBm)	Tune-up power (dBm)	Scaled SAR 1g (W/Kg)	Date	Plot
			1-g	10-g						
1RB										
Front Side	20525/836.5	10M QPSK(1,24)	0.228	0.154	-1.84	24.30	24.50	0.239	2023/6/25	
Back Side	20525/836.5	10M QPSK(1,24)	0.375	0.263	0.18	24.30	24.50	0.393	2023/6/25	11#
50%RB										
Front Side	20525/836.5	10M QPSK(25,12)	0.120	0.081	3.17	23.21	23.50	0.128	2023/6/25	
Back Side	20525/836.5	10M QPSK(25,12)	0.224	0.133	-0.87	23.21	23.50	0.239	2023/6/25	

NOTE: Body-Worn SAR test results of LTE Band 5

Test Position of Hotspot with 0mm	Test channel /Freq.	Mode	SAR Value (W/kg)		Power Drift(%)	Conducted Power (dBm)	Tune-up Power (dBm)	Scaled SAR 1-g (W/Kg)	Date	Plot
			1-g	10-g						
1RB										
Front Side	20525/836.5	10M QPSK(1,24)	0.228	0.154	-1.84	24.30	24.50	0.239	2023/6/25	
Back Side	20525/836.5	10M QPSK(1,24)	0.375	0.263	0.18	24.30	24.50	0.393	2023/6/25	11#
Left	20525/836.5	10M	0.114	0.080	1.52	24.30	24.50	0.119	2023/6/25	

Side		QPSK(1,24)								
Right Side	20525/836.5	10M QPSK(1,24)	0.117	0.078	2.18	24.30	24.50	0.123	2023/6/25	
Top Side	20525/836.5	10M QPSK(1,24)	0.041	0.029	2.51	24.30	24.50	0.043	2023/6/25	
Bottom Side	20525/836.5	10M QPSK(1,24)	0.205	0.144	-1.30	24.30	24.50	0.215	2023/6/25	
50%RB										
Front Side	20525/836.5	10M QPSK(25,12)	0.120	0.081	3.17	23.21	23.50	0.128	2023/6/25	
Back Side	20525/836.5	10M QPSK(25,12)	0.224	0.133	-0.87	23.21	23.50	0.239	2023/6/25	
Left Side	20525/836.5	10M QPSK(25,12)	0.068	0.043	2.68	23.21	23.50	0.073	2023/6/25	
Right Side	20525/836.5	10M QPSK(25,12)	0.068	0.042	4.60	23.21	23.50	0.073	2023/6/25	
Top Side	20525/836.5	10M QPSK(25,12)	0.032	0.021	1.57	23.21	23.50	0.034	2023/6/25	
Bottom Side	20525/836.5	10M QPSK(25,12)	0.122	0.086	-1.81	23.21	23.50	0.130	2023/6/25	

NOTE: Hotspot SAR test results of LTE Band 5

11.1.9. SAR measurement Result of LTE Band 7

Test Position of Body-Worn with 0mm	Test channel /Freq.	Test Mode	SAR Value (W/kg)		Power Drift (±5%)	Conducted power (dBm)	Tune-up power (dBm)	Scaled SAR 1g (W/Kg)	Date	Plot
			1-g	10-g						
1RB										
Front Side	21100/2535	20M QPSK(1,49)	0.552	0.249	-0.13	24.87	25.50	0.638	2023/6/29	
Back Side	21100/2535	20M QPSK(1,49)	0.907	0.430	-0.13	24.87	25.50	1.049	2023/6/29	
Back Side	20850/2510	20M QPSK(1,49)	0.959	0.459	0.29	25.08	25.50	1.056	2023/6/29	12#
Back Side	21350/2560	20M QPSK(1,49)	0.867	0.406	-1.03	24.84	25.50	1.009	2023/6/29	
BackSide Repeated	20850/2510	20M QPSK(1,49)	0.955	0.446	0.12	25.08	25.50	1.052	2023/6/29	
50%RB										
Front Side	21100/2535	20M	0.281	0.128	-0.82	24.41	25.00	0.322	2023/6/29	

		QPSK(50,24)								
Back Side	21100/2535	20M QPSK(50,24)	0.461	0.238	-4.93	24.41	25.00	0.528	2023/6/29	

NOTE: Body-Worn SAR test results of LTE Band 7

Test Position of Hotspot with 0mm	Test channel /Freq.	Mode	SAR Value (W/kg)		Power Drift(%)	Conducted Power (dBm)	Tune-up Power (dBm)	Scaled SAR 1-g (W/Kg)	Date	Plot
			1-g	10-g						
1RB										
Front Side	21100/2535	20M QPSK(1,49)	0.552	0.249	-0.13	24.87	25.50	0.638	2023/6/29	
Back Side	21100/2535	20M QPSK(1,49)	0.907	0.430	-0.13	24.87	25.50	1.049	2023/6/29	
Left Side	21100/2535	20M QPSK(1,49)	0.279	0.132	0.34	24.87	25.50	0.323	2023/6/29	
Right Side	21100/2535	20M QPSK(1,49)	0.276	0.127	-3.24	24.87	25.50	0.319	2023/6/29	
Top Side	21100/2535	20M QPSK(1,49)	0.122	0.075	2.33	24.87	25.50	0.141	2023/6/29	
Bottom Side	21100/2535	20M QPSK(1,49)	0.470	0.221	-3.49	24.87	25.50	0.543	2023/6/29	
Back Side	20850/2510	20M QPSK(1,49)	0.959	0.459	0.29	25.08	25.50	1.056	2023/6/29	12#
Back Side	21350/2560	20M QPSK(1,49)	0.867	0.406	-1.03	24.84	25.50	1.009	2023/6/29	
BackSide Repeated	20850/2510	20M QPSK(1,49)	0.955	0.446	0.12	25.08	25.50	1.052	2023/6/29	
50%RB										
Front Side	21100/2535	20M QPSK(50,24)	0.281	0.128	-0.82	24.41	25.00	0.322	2023/6/29	
Back Side	21100/2535	20M QPSK(50,24)	0.461	0.238	-4.93	24.41	25.00	0.528	2023/6/29	
Left Side	21100/2535	20M QPSK(50,24)	0.149	0.073	-4.12	24.41	25.00	0.171	2023/6/29	
Right Side	21100/2535	20M QPSK(50,24)	0.145	0.070	2.11	24.41	25.00	0.166	2023/6/29	
Top Side	21100/2535	20M QPSK(50,24)	0.076	0.041	1.20	24.41	25.00	0.087	2023/6/29	
Bottom Side	21100/2535	20M QPSK(50,24)	0.255	0.126	1.18	24.41	25.00	0.292	2023/6/29	

100%RB										
Back Side	21100/2535	20M QPSK(50,0)	0.384	0.210	0.21	24.36	25.00	0.445	2023/6/29	

NOTE: Hotspot SAR test results of LTE Band 7

11.1.10. SAR measurement Result of LTE Band 12

Test Position of Body-Worn with 0mm	Test channel /Freq.	Test Mode	SAR Value (W/kg)		Power Drift (±5%)	Conducted power (dBm)	Tune-up power (dBm)	Scaled SAR 1g (W/Kg)	Date	Plot
			1-g	10-g						
1RB										
Front Side	23095/707.5	10M QPSK(1,0)	0.186	0.133	0.35	23.23	24.00	0.222	2023/6/20	
Back Side	23095/707.5	10M QPSK(1,0)	0.284	0.212	-0.61	23.23	24.00	0.339	2023/6/20	13#
50%RB										
Front Side	23095/707.5	10M QPSK(25,0)	0.105	0.067	-2.66	22.70	23.00	0.113	2023/6/20	
Back Side	23095/707.5	10M QPSK(25,0)	0.166	0.111	-1.98	22.70	23.00	0.178	2023/6/20	

NOTE: Body-Worn SAR test results of LTE Band 12

Test Position of Hotspot with 0mm	Test channel /Freq.	Mode	SAR Value (W/kg)		Power Drift(%)	Conducted Power (dBm)	Tune-up Power (dBm)	Scaled SAR 1-g (W/Kg)	Date	Plot
			1-g	10-g						
1RB										
Front Side	23095/707.5	10M QPSK(1,0)	0.186	0.133	0.35	23.23	24.00	0.222	2023/6/20	
Back Side	23095/707.5	10M QPSK(1,0)	0.284	0.212	-0.61	23.23	24.00	0.339	2023/6/20	13#
Left Side	23095/707.5	10M QPSK(1,0)	0.093	0.067	3.23	23.23	24.00	0.111	2023/6/20	
Right Side	23095/707.5	10M QPSK(1,0)	0.087	0.064	-3.57	23.23	24.00	0.104	2023/6/20	
Top Side	23095/707.5	10M QPSK(1,0)	0.045	0.023	0.54	23.23	24.00	0.054	2023/6/20	
Bottom	23095/707.5	10M	0.160	0.115	-1.09	23.23	24.00	0.191	2023/6/20	

Side		QPSK(1,0)								
50%RB										
Front Side	23095/707.5	10M QPSK(25,0)	0.105	0.067	-2.66	22.70	23.00	0.113	2023/6/20	
Back Side	23095/707.5	10M QPSK(25,0)	0.166	0.111	-1.98	22.70	23.00	0.178	2023/6/20	
Left Side	23095/707.5	10M QPSK(25,0)	0.054	0.035	2.34	22.70	23.00	0.058	2023/6/20	
Right Side	23095/707.5	10M QPSK(25,0)	0.052	0.032	3.50	22.70	23.00	0.056	2023/6/20	
Top Side	23095/707.5	10M QPSK(25,0)	0.023	0.018	1.11	22.70	23.00	0.025	2023/6/20	
Bottom Side	23095/707.5	10M QPSK(25,0)	0.082	0.061	-3.15	22.70	23.00	0.088	2023/6/20	

NOTE: Hotspot SAR test results of LTE Band 12

11.1.11. SAR measurement Result of LTE Band 17

Test Position of Body-Worn with 0mm	Test channel /Freq.	Test Mode	SAR Value (W/kg)		Power Drift (±5%)	Conducted power (dBm)	Tune-up power (dBm)	Scaled SAR 1g (W/Kg)	Date	Plot
			1-g	10-g						
1RB										
Front Side	23790/710	10M QPSK(1,0)	0.198	0.141	-0.55	23.35	23.50	0.205	2023/6/20	
Back Side	23790/710	10M QPSK(1,0)	0.300	0.221	-0.35	23.35	23.50	0.311	2023/6/20	14#
50%RB										
Front Side	23790/710	10M QPSK(25,12)	0.116	0.075	-0.40	22.73	23.00	0.123	2023/6/20	
Back Side	23790/710	10M QPSK(25,12)	0.166	0.122	1.85	22.73	23.00	0.177	2023/6/20	

NOTE: Body-Worn SAR test results of LTE Band 17

Test Position of Hotspot with 0mm	Test channel /Freq.	Mode	SAR Value (W/kg)		Power Drift(%)	Conducted Power (dBm)	Tune-up Power (dBm)	Scaled SAR 1-g (W/Kg)	Date	Plot
			1-g	10-g						
1RB										

Front Side	23790/710	10M QPSK(1,0)	0.198	0.141	-0.55	23.35	23.50	0.205	2023/6/20	
Back Side	23790/710	10M QPSK(1,0)	0.300	0.221	-0.35	23.35	23.50	0.311	2023/6/20	14#
Left Side	23790/710	10M QPSK(1,0)	0.093	0.067	-1.78	23.35	23.50	0.096	2023/6/20	
Right Side	23790/710	10M QPSK(1,0)	0.102	0.074	2.96	23.35	23.50	0.106	2023/6/20	
Top Side	23790/710	10M QPSK(1,0)	0.063	0.036	1.25	23.35	23.50	0.065	2023/6/20	
Bottom Side	23790/710	10M QPSK(1,0)	0.175	0.129	3.49	23.35	23.50	0.181	2023/6/20	
50%RB										
	23790/710	10M QPSK(25,12)	0.116	0.075	-0.40	22.73	23.00	0.123	2023/6/20	
Back Side	23790/710	10M QPSK(25,12)	0.166	0.122	1.85	22.73	23.00	0.177	2023/6/20	
Left Side	23790/710	10M QPSK(25,12)	0.050	0.035	1.52	22.73	23.00	0.053	2023/6/20	
Right Side	23790/710	10M QPSK(25,12)	0.055	0.041	2.47	22.73	23.00	0.059	2023/6/20	
Top Side	23790/710	10M QPSK(25,12)	0.040	0.031	0.19	22.73	23.00	0.043	2023/6/20	
Bottom Side	23790/710	10M QPSK(25,12)	0.088	0.074	3.91	22.73	23.00	0.094	2023/6/20	

NOTE: Hotspot SAR test results of LTE Band 17

11.1.12. SAR measurement Result of NR n78

Test Position of Body-Worn with 0mm	Test channel /Freq.	Test Mode	SAR Value (W/kg)		Power Drift (±5%)	Conducted power (dBm)	Tune-up power (dBm)	Scaled SAR 1g (W/Kg)	Date	Plot
			1-g	10-g						
Front Side	633333/3500	100M QPSK(135,67)	0.025	0.011	1.10	19.51	20.00	0.028	2023/6/30	
Back Side	633333/3500	100M QPSK(135,67)	0.033	0.012	-2.97	19.51	20.00	0.037	2023/6/30	15#

NOTE: Body-Worn SAR test results of NR n78

Test Position	Test channel /Freq.	Mode	SAR Value (W/kg)	Power Drift(%)	Conducted Power	Tune-up Power	Scaled SAR	Date	Plot
---------------	---------------------	------	------------------	----------------	-----------------	---------------	------------	------	------

of Hotspot with 0mm			1-g	10-g		(dBm)	(dBm)	1-g (W/Kg)		
Front Side	633333/3500	100M QPSK(135,67)	0.025	0.011	1.10	19.51	20.00	0.028	2023/6/30	
Back Side	633333/3500	100M QPSK(135,67)	0.033	0.012	-2.97	19.51	20.00	0.037	2023/6/30	15#
Left Side	633333/3500	100M QPSK(135,67)	0.024	0.009	-0.59	19.51	20.00	0.027	2023/6/30	
Right Side	633333/3500	100M QPSK(135,67)	0.012	0.006	-2.75	19.51	20.00	0.013	2023/6/30	
Top Side	633333/3500	100M QPSK(135,67)	0.008	0.004	2.00	19.51	20.00	0.009	2023/6/30	
Bottom Side	633333/3500	100M QPSK(135,67)	0.020	0.008	3.51	19.51	20.00	0.022	2023/6/30	

NOTE: Hotspot SAR test results of NR n78

11.1.13. SAR measurement Result of WLAN 2.4G

Test Position of Body-Worn with 0mm	Test channel /Freq.	Test Mode	SAR Value (W/kg)		Power Drift (±5%)	Conducted power (dBm)	Tune-up power (dBm)	Scaled SAR 1g (W/Kg)	Date	Plot
			1-g	10-g						
Front Side	1/2412	802.11b	0.138	0.068	1.39	15.36	15.50	0.143	2023/6/28	
Back Side	1/2412	802.11b	0.218	0.110	1.45	15.36	15.50	0.225	2023/6/28	6#

NOTE: Body-Worn SAR test results of WLAN 2.4G

Test Position of Hotspot with 0mm	Test channel /Freq.	Mode	SAR Value (W/kg)		Power Drift(%)	Conducted Power (dBm)	Tune-up Power (dBm)	Scaled SAR 1-g (W/Kg)	Date	Plot
			1-g	10-g						
Front Side	1/2412	802.11b	0.138	0.068	1.39	15.36	15.50	0.143	2023/6/28	
Back Side	1/2412	802.11b	0.218	0.110	1.45	15.36	15.50	0.225	2023/6/28	6#
Left Side	1/2412	802.11b	0.065	0.034	0.10	15.36	15.50	0.067	2023/6/28	
Right Side	1/2412	802.11b	0.078	0.038	0.07	15.36	15.50	0.081	2023/6/28	
Top Side	1/2412	802.11b	0.069	0.033	1.28	15.36	15.50	0.071	2023/6/28	
Bottom Side	1/2412	802.11b	0.040	0.027	1.33	15.36	15.50	0.041	2023/6/28	

NOTE: Hotspot SAR test results of WLAN 2.4G

11.1.14. SAR measurement Result of WLAN 5.2G

Test Position of Body-Worn with 0mm	Test channel /Freq	Mode	SAR Value (W/kg)		Power Drift(%)	Conducted Power (dBm)	Tune-up Power (dBm)	Scaled SAR 1-g (W/Kg)	Date	Plot
			1-g	10-g						
Front Side	36/5180	802.11ac VHT20	0.078	0.025	-2.06	10.78	11.00	0.082	2023/6/22	
Back Side	36/5180	802.11ac VHT20	0.106	0.036	0.31	10.78	11.00	0.112	2023/6/22	7#

NOTE: Body-Worn SAR test results of WLAN 5.2G

Test Position of Hotspot with 0mm	Test channel /Freq	Mode	SAR Value (W/kg)		Power Drift(%)	Conducted Power (dBm)	Tune-up Power (dBm)	Scaled SAR 1-g (W/Kg)	Date	Plot
			1-g	10-g						
Front Side	36/5180	802.11ac VHT20	0.078	0.025	-2.06	10.78	11.00	0.082	2023/6/22	
Back Side	36/5180	802.11ac VHT20	0.106	0.036	0.31	10.78	11.00	0.112	2023/6/22	7#
Left Side	36/5180	802.11ac VHT20	0.031	0.010	1.20	10.78	11.00	0.033	2023/6/22	
Right Side	36/5180	802.11ac VHT20	0.028	0.011	1.20	10.78	11.00	0.029	2023/6/22	
Top Side	36/5180	802.11ac VHT20	0.027	0.008	0.74	10.78	11.00	0.028	2023/6/22	
Bottom Side	36/5180	802.11ac VHT20	0.039	0.013	3.45	10.78	11.00	0.041	2023/6/22	

NOTE: Hotspot SAR test results of WLAN 5.2G

11.1.15. SAR measurement Result of WLAN 5.8G

Test Position of Body-Worn with 0mm	Test channel /Freq	Mode	SAR Value (W/kg)		Power Drift(%)	Conducted Power (dBm)	Tune-up Power (dBm)	Scaled SAR 1-g (W/Kg)	Date	Plot
			1-g	10-g						
Front Side	149/5745	802.11a	0.144	0.043	-1.11	10.10	10.50	0.158	2023/7/03	
Back Side	149/5745	802.11a	0.196	0.060	-0.31	10.10	10.50	0.215	2023/7/03	8#

NOTE: Body-Worn SAR test results of WLAN 5.8G

Test Position	Test channel	Mode	SAR Value (W/kg)	Power Drift(%)	Conducted Power	Tune-up Power	Scaled SAR	Date	Plot
---------------	--------------	------	------------------	----------------	-----------------	---------------	------------	------	------

of Hotspot with Omm	/Freq		1-g	10-g		(dBm)	(dBm)	1-g (W/Kg)		
Front Side	149/5745	802.11a	0.144	0.043	-1.11	10.10	10.50	0.158	2023/7/03	
Back Side	149/5745	802.11a	0.196	0.060	-0.31	10.10	10.50	0.215	2023/7/03	8#
Left Side	149/5745	802.11a	0.054	0.020	3.01	10.10	10.50	0.059	2023/7/03	
Right Side	149/5745	802.11a	0.072	0.022	-1.37	10.10	10.50	0.079	2023/7/03	
Top Side	149/5745	802.11a	0.072	0.021	1.60	10.10	10.50	0.079	2023/7/03	
Bottom Side	149/5745	802.11a	0.028	0.013	4.15	10.10	10.50	0.031	2023/7/03	

NOTE: Hotspot SAR test results of WLAN 5.8G

11.2. SAR Summation Scenario

Per KDB 447498 D01, simultaneous transmission SAR is compliant if,

- Scalar SAR summation < 1.6W/kg.
- SPLSR = $(SAR_1 + SAR_2)^{1.5} / (\text{min. separation distance, mm})$, and the peak separation distance is determined from the square root of $[(x_1-x_2)^2 + (y_1-y_2)^2 + (z_1-z_2)^2]$, where (x_1, y_1, z_1) and (x_2, y_2, z_2) are the coordinates of the extrapolated peak SAR locations in the zoom scan. If $SPLSR \leq 0.04$, simultaneously transmission SAR measurement is not necessary.

Test Position		Scaled SAR _{MAX}		Σ 1-g SAR (W/Kg)	SPLSR	Remark
		WWAN	DTS			
Body	Front Side	0.698	0.143	0.841	N/A	N/A
	Back Side	1.193	0.225	1.418	N/A	N/A
	Left Side	0.359	0.067	0.426	N/A	N/A
	Right Side	0.356	0.081	0.437	N/A	N/A
	Top Side	0.240	0.071	0.311	N/A	N/A
	Bottom Side	0.582	0.041	0.623	N/A	N/A

Test Position		Scaled SAR _{MAX}		Σ 1-g SAR (W/Kg)	SPLSR	Remark
		WWAN	NII			
Body	Front Side	0.698	0.158	0.856	N/A	N/A
	Back Side	1.193	0.215	1.408	N/A	N/A
	Left Side	0.359	0.059	0.418	N/A	N/A

	Right Side	0.356	0.079	0.435	N/A	N/A
	Top Side	0.240	0.079	0.319	N/A	N/A
	Bottom Side	0.582	0.041	0.623	N/A	N/A

Test Position		Scaled SAR _{MAX}		Σ 1-g SAR (W/Kg)	SPLSR	Remark
		WWAN	DSS			
Body	Front Side	0.698	0.210	0.908	N/A	N/A
	Back Side	1.193	0.210	1.403	N/A	N/A
	Left Side	0.698	0.210	0.908	N/A	N/A
	Right Side	1.193	0.210	1.403	N/A	N/A
	Top Side	0.359	0.210	0.569	N/A	N/A
	Bottom Side	0.356	0.210	0.566	N/A	N/A

Test Position		Scaled SAR _{MAX}			Σ 1-g SAR (W/Kg)	SPLSR	Remark
		WWAN	DTS	NR			
Body	Front Side	0.698	0.143	0.028	0.869	N/A	N/A
	Back Side	1.193	0.225	0.037	1.455	N/A	N/A
	Left Side	0.359	0.067	0.027	0.453	N/A	N/A
	Right Side	0.356	0.081	0.013	0.450	N/A	N/A
	Top Side	0.240	0.071	0.009	0.320	N/A	N/A
	Bottom Side	0.582	0.041	0.022	0.645	N/A	N/A

12. Appendix A. Photo documentation

Refer to appendix Test Setup photo---SAR

13. Appendix B. System Check Plots

Table of contents
MEASUREMENT 1 System Performance Check - 750MHz
MEASUREMENT 2 System Performance Check - 835MHz
MEASUREMENT 3 System Performance Check - 1800MHz
MEASUREMENT 4 System Performance Check - 1900MHz
MEASUREMENT 5 System Performance Check - 2450MHz
MEASUREMENT 6 System Performance Check - 2600MHz
MEASUREMENT 7 System Performance Check - 3500MHz
MEASUREMENT 8 System Performance Check - 5200MHz
MEASUREMENT 9 System Performance Check - 5800MHz

MEASUREMENT 1

Date of measurement: 20/6/2023

A. Experimental conditions.

Area Scan	<u>dx=15mm dy=15mm, h= 5.00 mm</u>
ZoomScan	<u>5x5x7, dx=8mm dy=8mm dz=5mm</u>
Phantom	<u>Validation plane</u>
Device Position	<u>Dipole</u>
Band	<u>CW750</u>
Channels	<u>Middle</u>
Signal	<u>CW (Crest factor: 1.0)</u>
ConvF	<u>1.49</u>

B. SAR Measurement Results

Frequency (MHz)	750.000000
Relative permittivity (real part)	40.198745
Relative permittivity (imaginary part)	21.365670
Conductivity (S/m)	0.890236
Variation (%)	-2.160000

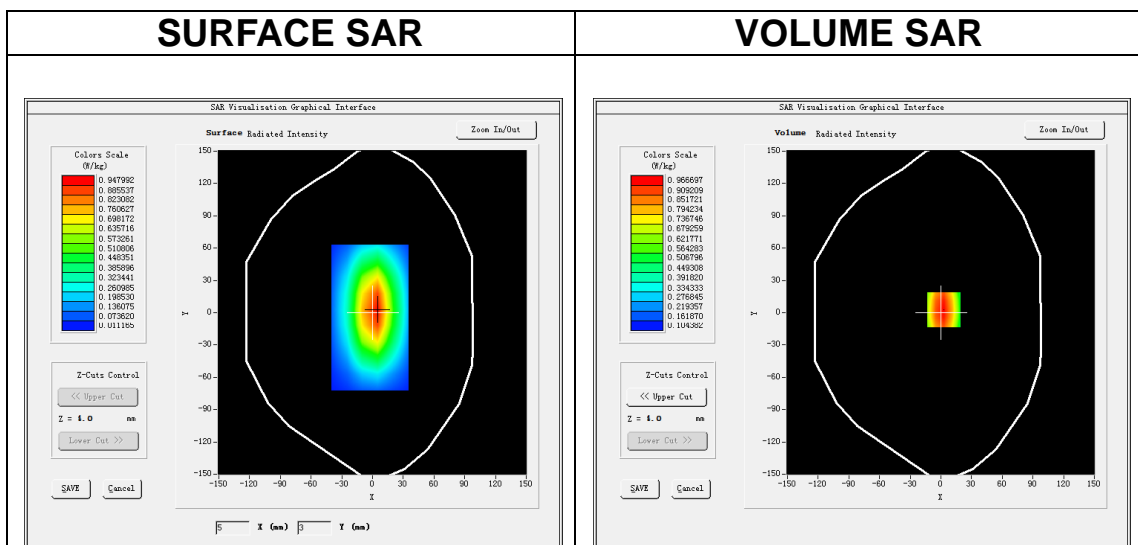

Maximum location: X=3.00, Y=3.00

SAR Peak: 1.30 W/kg

SAR 10g (W/Kg)	0.530318
SAR 1g (W/Kg)	0.875339

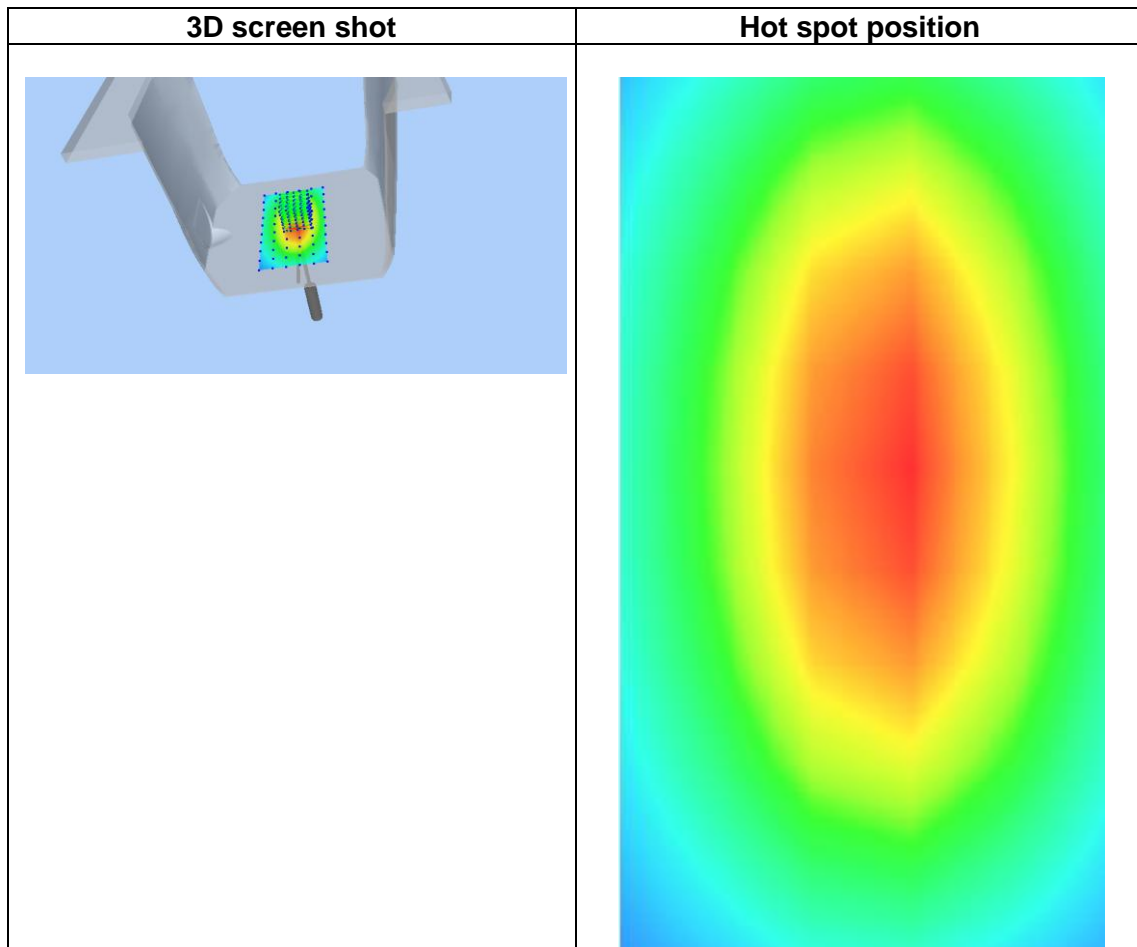
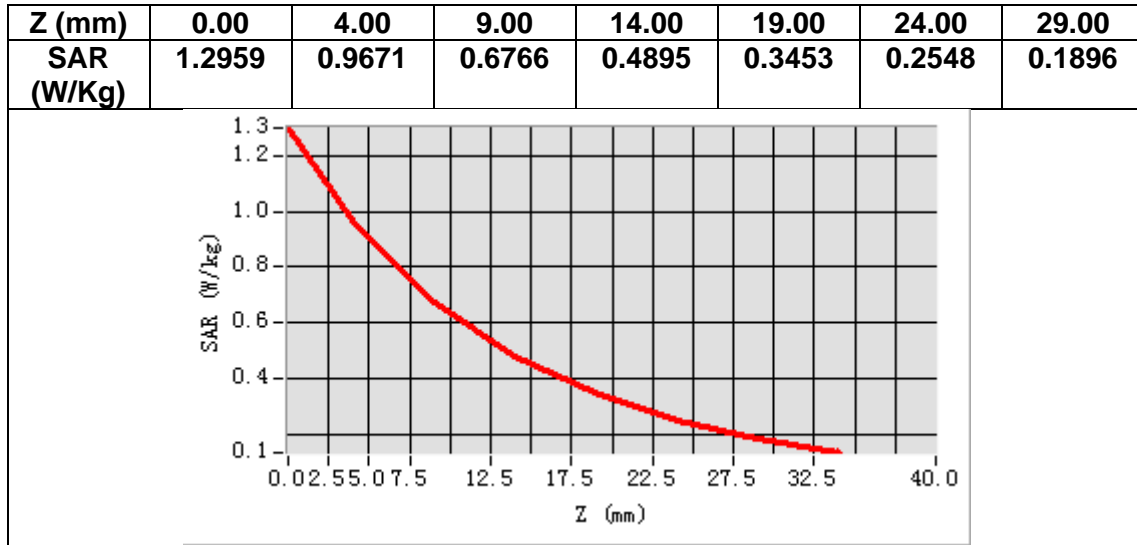

MEASUREMENT 2

Date of measurement: 25/6/2023

A. Experimental conditions.

Area Scan	<u>dx=15mm dy=15mm, h= 5.00 mm</u>
ZoomScan	<u>5x5x7, dx=8mm dy=8mm dz=5mm</u>
Phantom	<u>Validation plane</u>
Device Position	<u>Dipole</u>
Band	<u>CW835</u>
Channels	<u>Middle</u>
Signal	<u>CW (Crest factor: 1.0)</u>
ConvF	<u>1.50</u>

B. SAR Measurement Results

Frequency (MHz)	835.000000
Relative permittivity (real part)	40.586981
Relative permittivity (imaginary part)	19.314151
Conductivity (S/m)	0.895962
Variation (%)	-0.780000

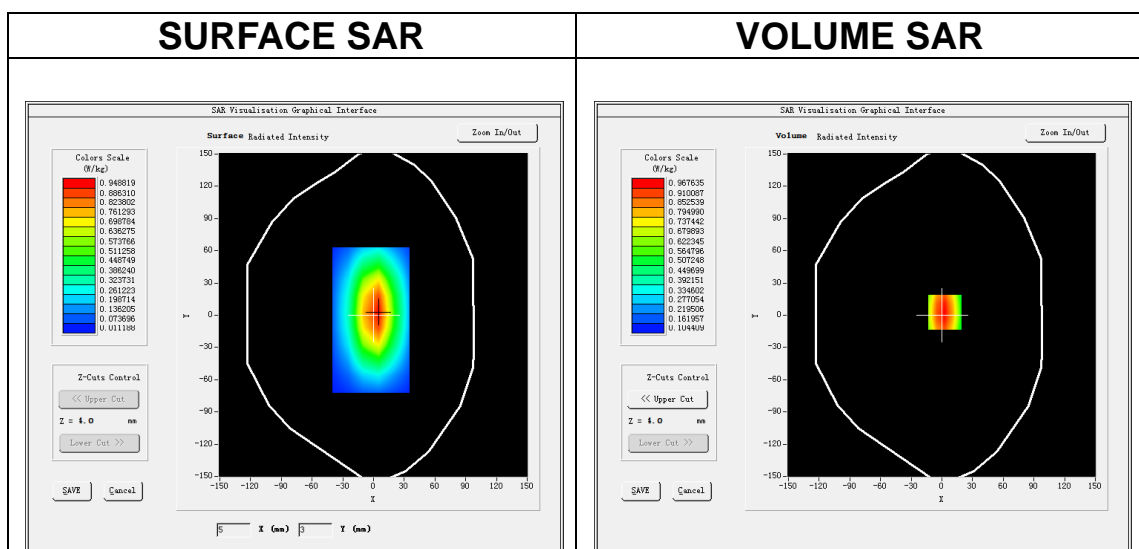

Maximum location: X=3.00, Y=3.00

SAR Peak: 1.30 W/kg

SAR 10g (W/Kg)	0.589115
SAR 1g (W/Kg)	0.932057

Z (mm)	0.00	4.00	9.00	14.00	19.00	24.00	29.00
SAR (W/Kg)	1.3065	0.9634	0.6776	0.4850	0.3468	0.2534	0.1895

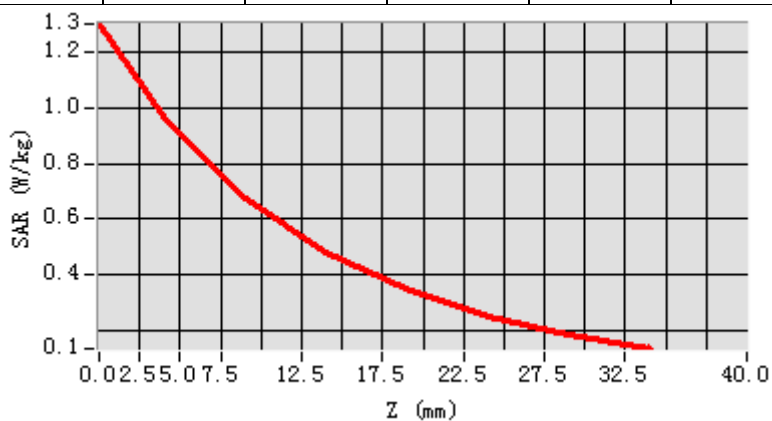

3D screen shot

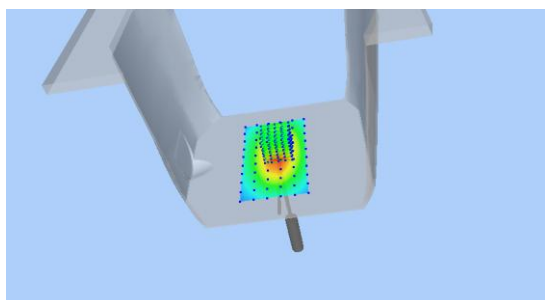

Hot spot position

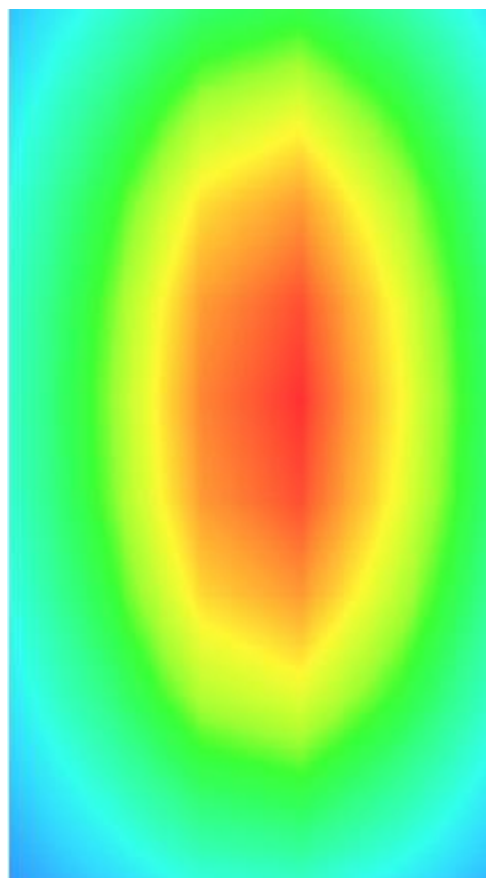

MEASUREMENT 3

Date of measurement: 26/6/2023

A. Experimental conditions.

Area Scan	<u>dx=15mm dy=15mm, h= 5.00 mm</u>
ZoomScan	<u>5x5x7, dx=8mm dy=8mm dz=5mm</u>
Phantom	<u>Validation plane</u>
Device Position	<u>Dipole</u>
Band	<u>CW1800</u>
Channels	<u>Middle</u>
Signal	<u>CW (Crest factor: 1.0)</u>
ConvF	<u>1.73</u>

B. SAR Measurement Results

Frequency (MHz)	1800.000000
Relative permittivity (real part)	38.558010
Relative permittivity (imaginary part)	13.710488
Conductivity (S/m)	1.371049
Variation (%)	-3.570000

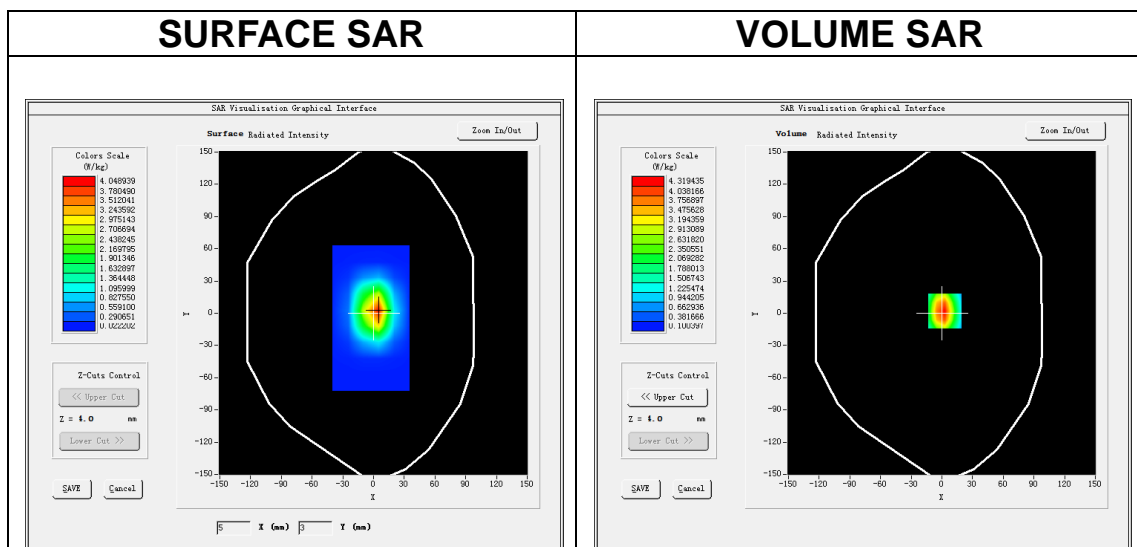

Maximum location: X=3.00, Y=2.00
SAR Peak: 6.82 W/kg

SAR 10g (W/Kg)	1.862138
SAR 1g (W/Kg)	3.535120

Z (mm)	0.00	4.00	9.00	14.00	19.00	24.00	29.00
SAR (W/Kg)	6.7454	4.3152	2.4363	1.4268	0.8532	0.5218	0.3235

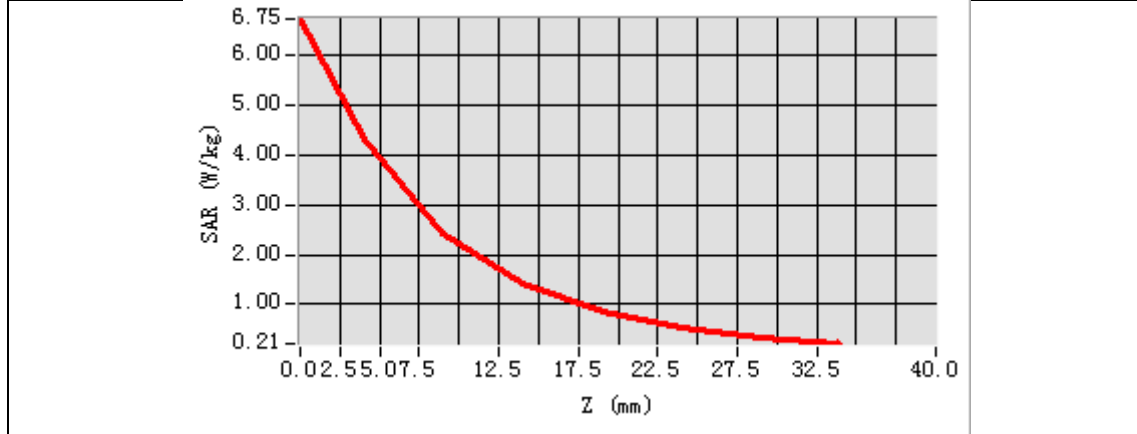

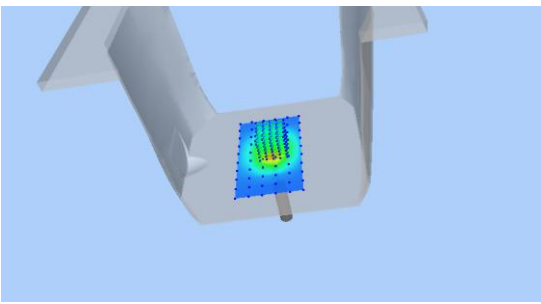
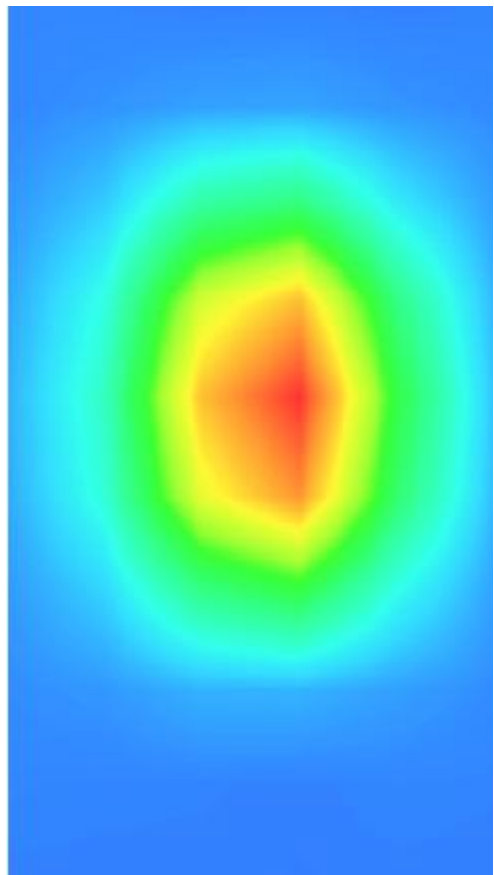
3D screen shot	Hot spot position
	

MEASUREMENT 4

Date of measurement: 21/6/2023

A. Experimental conditions.

<u>Area Scan</u>	<u>dx=15mm dy=15mm, h= 5.00 mm</u>
<u>ZoomScan</u>	<u>5x5x7, dx=8mm dy=8mm dz=5mm</u>
<u>Phantom</u>	<u>Validation plane</u>
<u>Device Position</u>	<u>Dipole</u>
<u>Band</u>	<u>CW1900</u>
<u>Channels</u>	<u>Middle</u>
<u>Signal</u>	<u>CW (Crest factor: 1.0)</u>
<u>ConvF</u>	<u>1.91</u>

B. SAR Measurement Results

Frequency (MHz)	1900.000000
Relative permittivity (real part)	38.608106
Relative permittivity (imaginary part)	13.559062
Conductivity (S/m)	1.431234
Variation (%)	-1.560000

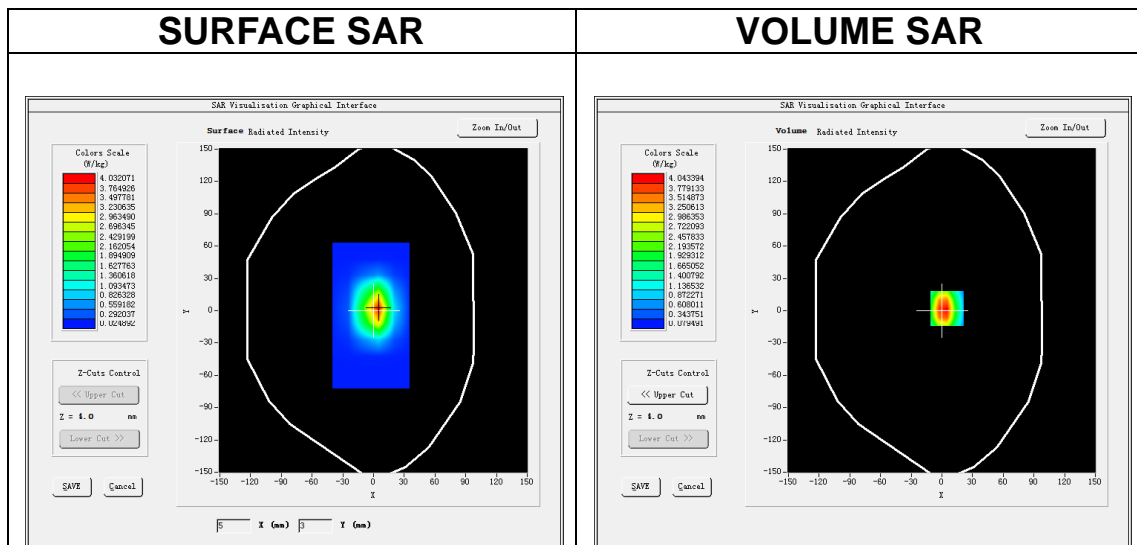

Maximum location: X=5.00, Y=2.00

SAR Peak: 6.70 W/kg

SAR 10g (W/Kg)	2.141012
SAR 1g (W/Kg)	4.220167

Z (mm)	0.00	4.00	9.00	14.00	19.00	24.00	29.00
SAR (W/Kg)	6.3290	4.0491	2.2626	1.3016	0.7652	0.4516	0.2711

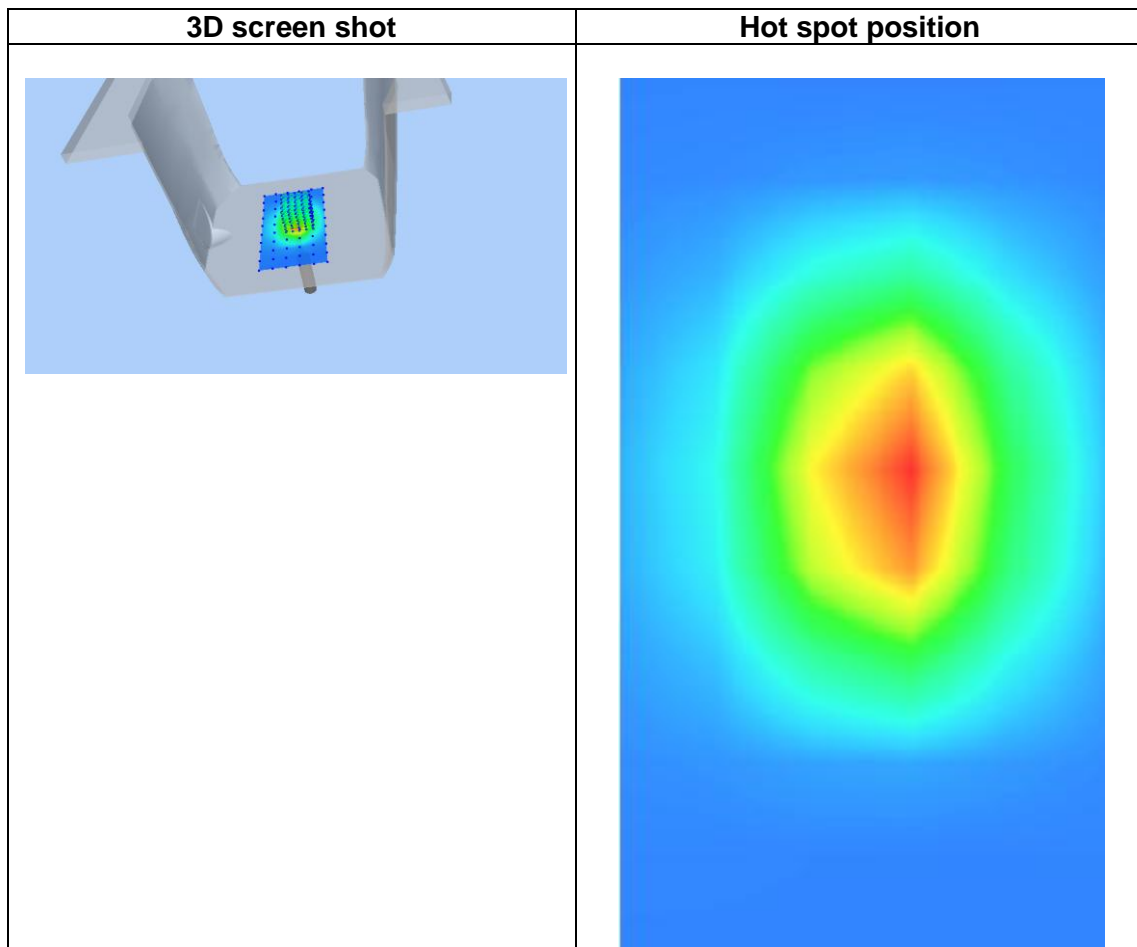
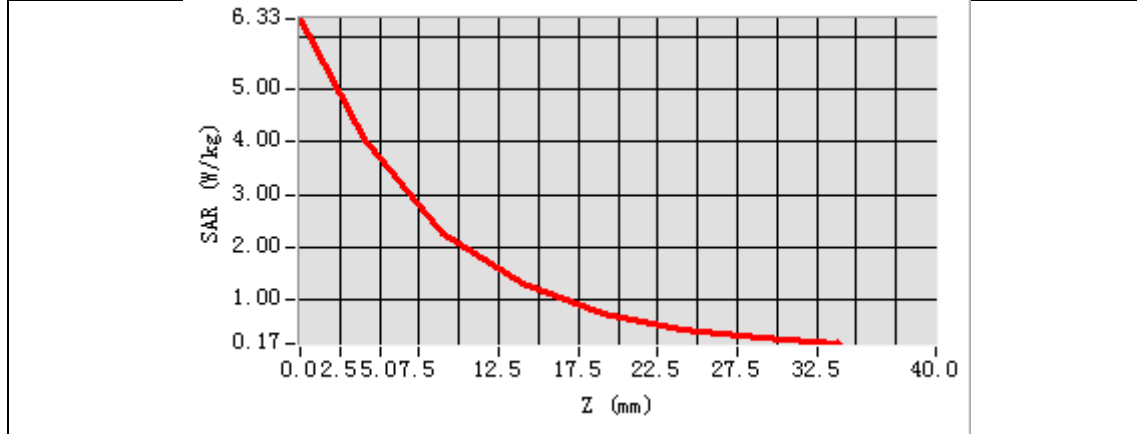

MEASUREMENT 5

Date of measurement: 28/6/2023

A. Experimental conditions.

Area Scan	<u>dx=12mm dy=12mm, h= 5.00 mm</u>
ZoomScan	<u>7x7x7, dx=5mm dy=5mm dz=5mm</u>
Phantom	<u>Validation plane</u>
Device Position	<u>Dipole</u>
Band	<u>CW2450</u>
Channels	<u>Middle</u>
Signal	<u>CW (Crest factor: 1.0)</u>
ConvF	<u>1.98</u>

B. SAR Measurement Results

Frequency (MHz)	2450.000000
Relative permittivity (real part)	37.958860
Relative permittivity (imaginary part)	12.989405
Conductivity (S/m)	1.768002
Variation (%)	-0.280000

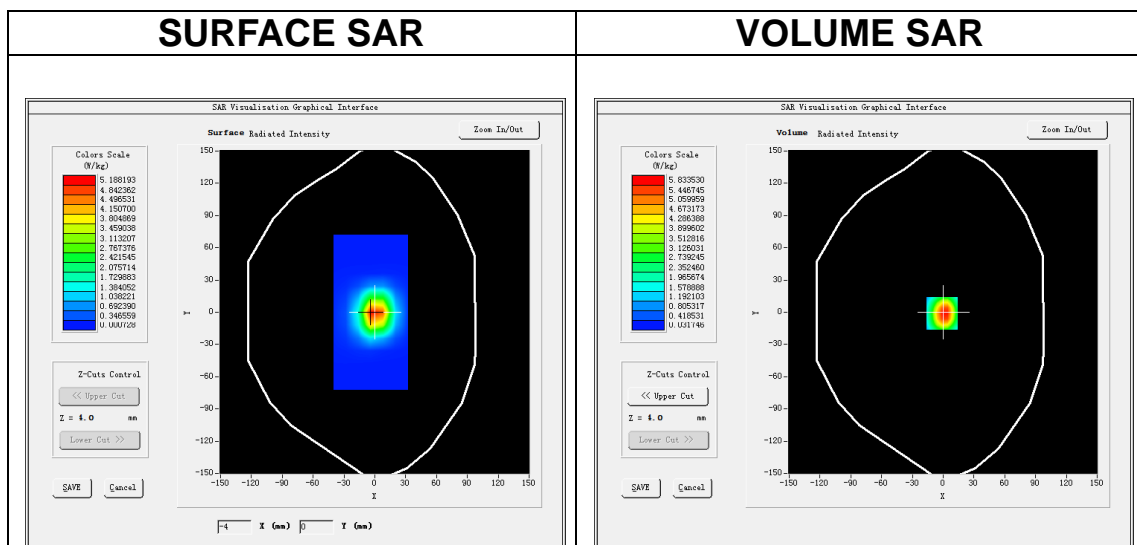

Maximum location: X=-1.00, Y=-1.00

SAR Peak: 9.83 W/kg

SAR 10g (W/Kg)	2.203331
SAR 1g (W/Kg)	5.348268

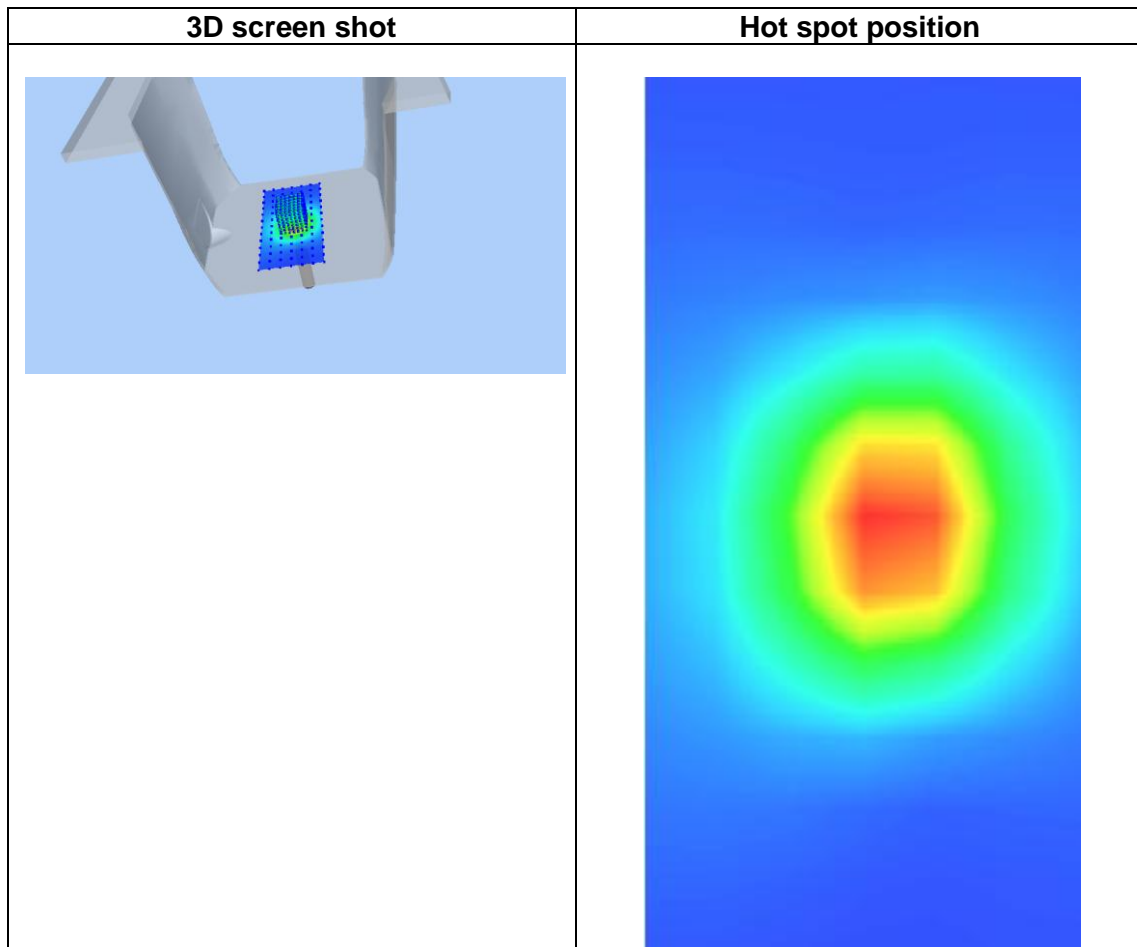
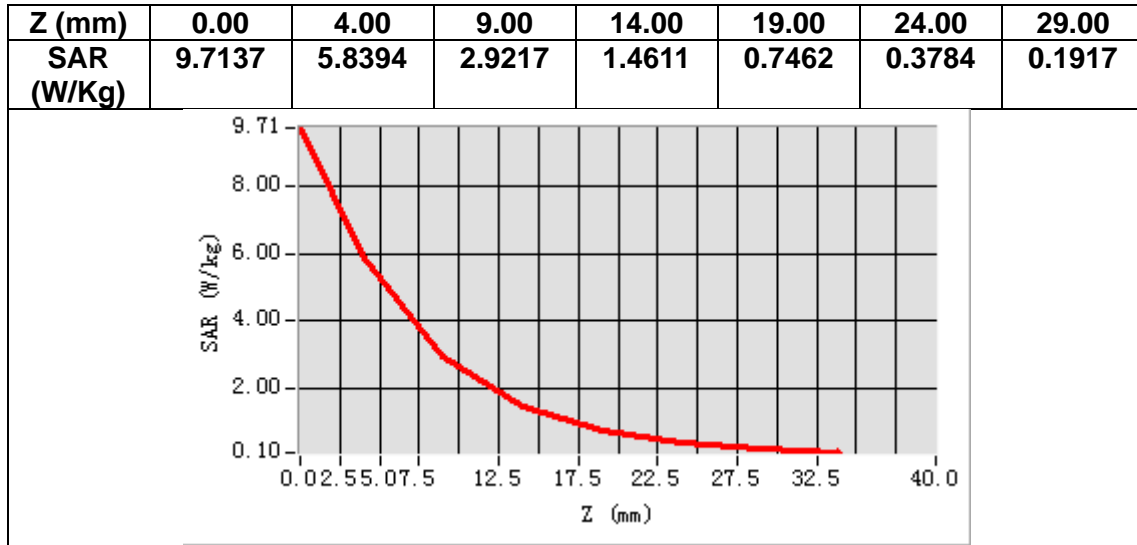

MEASUREMENT 6

Date of measurement: 29/6/2023

A. Experimental conditions.

Area Scan	<u>dx=12mm dy=12mm, h= 5.00 mm</u>
ZoomScan	<u>7x7x7, dx=5mm dy=5mm dz=5mm</u>
Phantom	<u>Validation plane</u>
Device Position	<u>Dipole</u>
Band	<u>CW2600</u>
Channels	<u>Middle</u>
Signal	<u>CW (Crest factor: 1.0)</u>
ConvF	<u>1.87</u>

B. SAR Measurement Results

Frequency (MHz)	2600.000000
Relative permittivity (real part)	37.723199
Relative permittivity (imaginary part)	13.390733
Conductivity (S/m)	1.934217
Variation (%)	2.500000

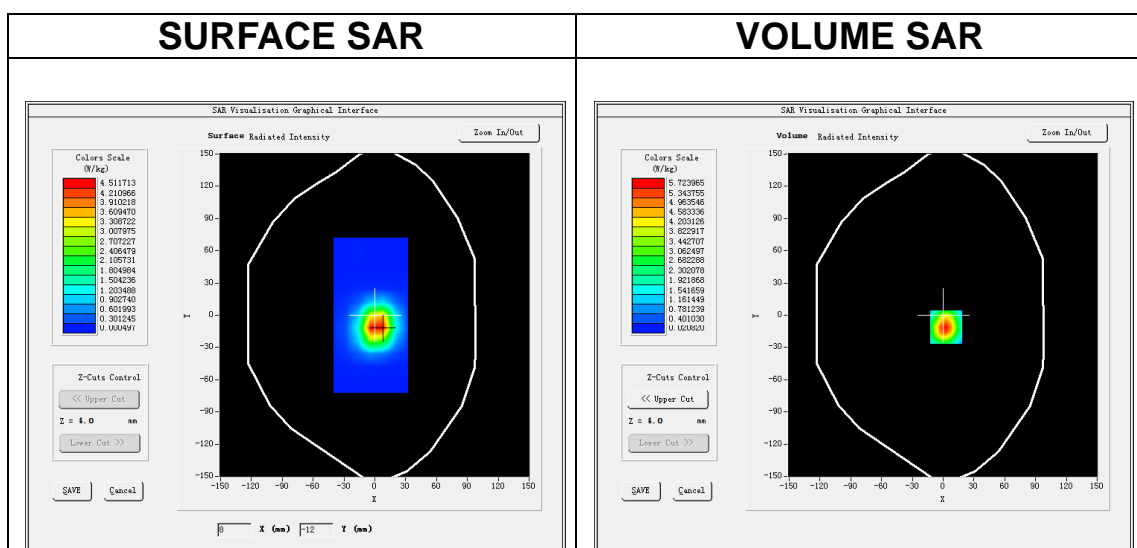

Maximum location: X=3.00, Y=-11.00

SAR Peak: 10.29 W/kg

SAR 10g (W/Kg)	2.537105
SAR 1g (W/Kg)	5.309294

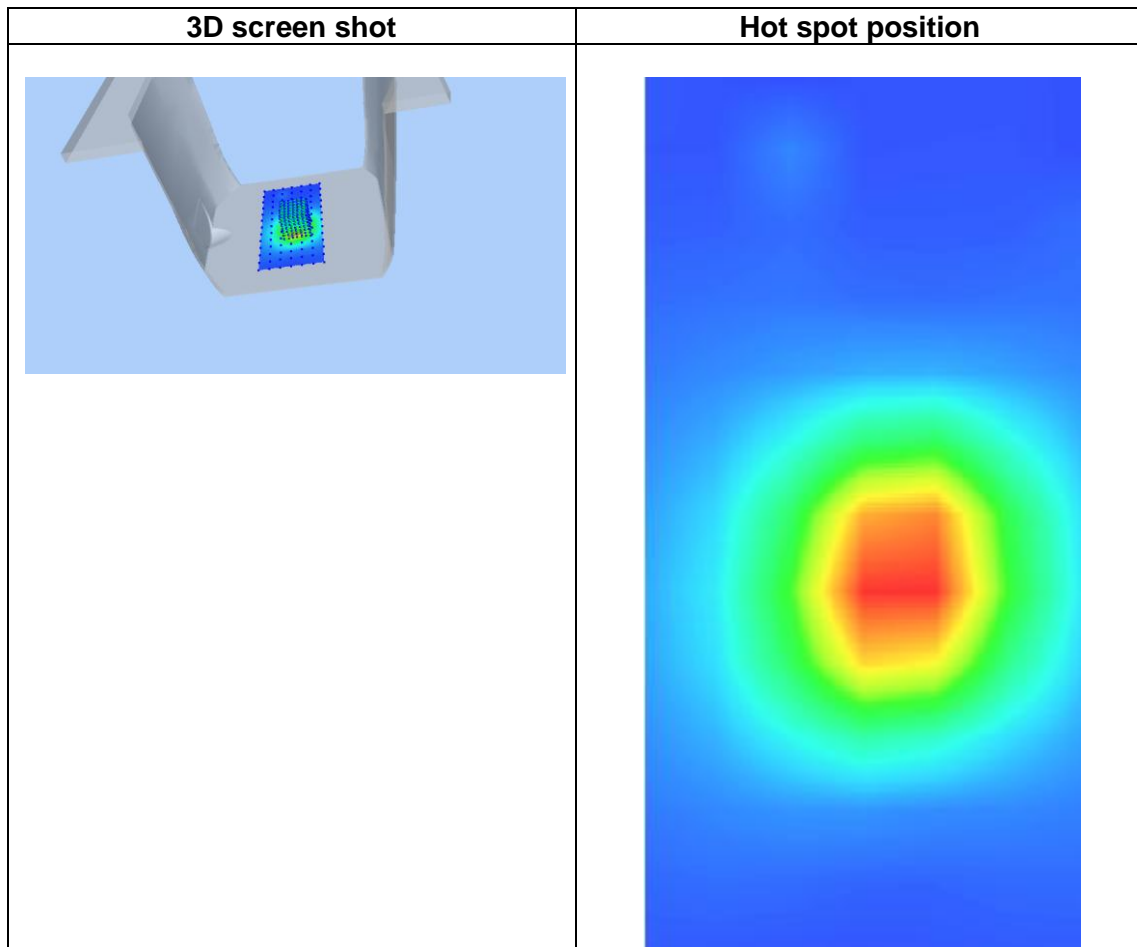
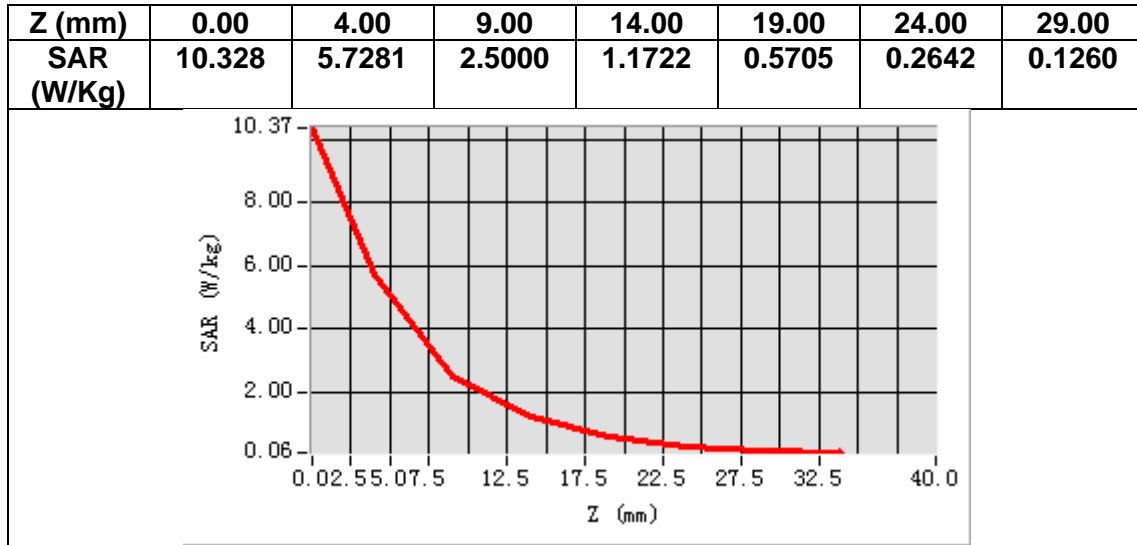

MEASUREMENT 7

Date of measurement: 30/6/2023

A. Experimental conditions.

Area Scan	<u>dx=12mm dy=12mm, h= 5.00 mm</u>
ZoomScan	<u>7x7x7, dx=5mm dy=5mm dz=5mm</u>
Phantom	<u>Validation plane</u>
Device Position	<u>Dipole</u>
Band	<u>CW3500</u>
Channels	<u>Middle</u>
Signal	<u>CW (Crest factor: 1.0)</u>
ConvF	<u>1.85</u>

B. SAR Measurement Results

Frequency (MHz)	3500.000000
Relative permittivity (real part)	38.199215
Relative permittivity (imaginary part)	14.378688
Conductivity (S/m)	2.795856
Variation (%)	-2.070000

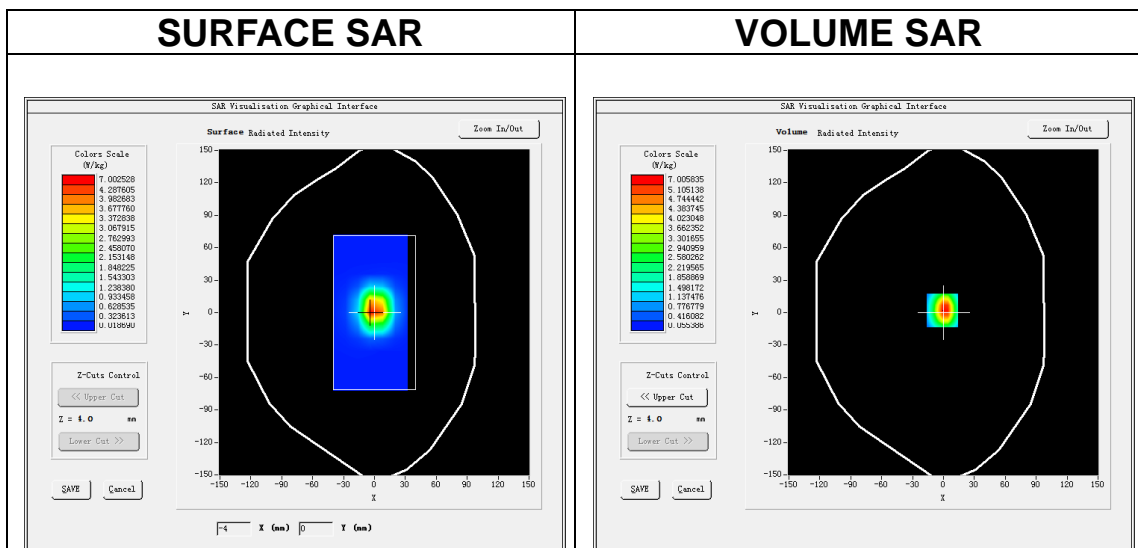

Maximum location: X=-1.00, Y=2.00

SAR Peak: 9.07 W/kg

SAR 10g (W/Kg)	2.569258
SAR 1g (W/Kg)	7.099367

Z (mm)	0.00	4.00	9.00	14.00	19.00	24.00	29.00
SAR (W/Kg)	8.8193	5.4649	2.8947	1.5612	0.8580	0.4720	0.2623

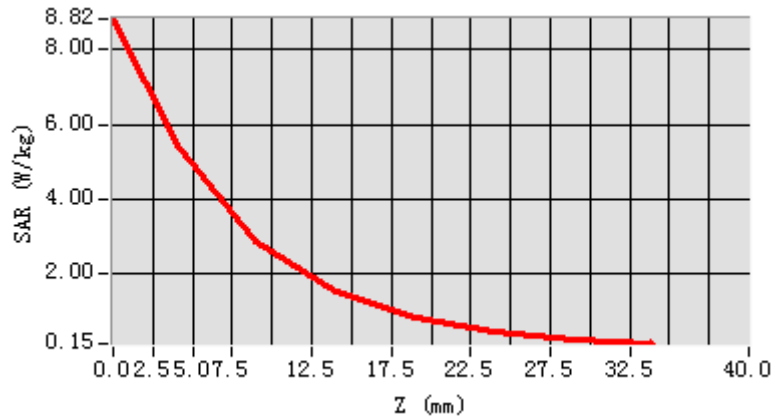

3D screen shot

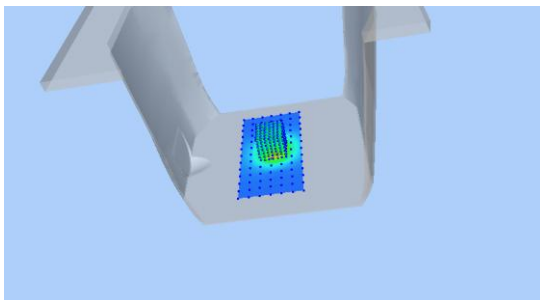

Hot spot position

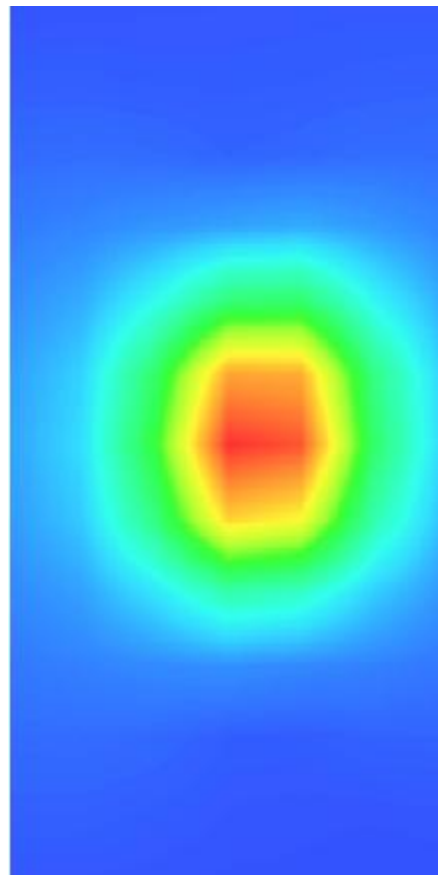

MEASUREMENT 8

Date of measurement: 22/6/2023

A. Experimental conditions.

Area Scan	<u>dx=10mm dy=10mm, h= 2.00 mm</u>
ZoomScan	<u>7x7x12,dx=4mm dy=4mm dz=2mm</u>
Phantom	<u>Validation plane</u>
Device Position	<u>Dipole</u>
Band	<u>CW5200</u>
Channels	<u>Middle</u>
Signal	<u>CW (Crest factor: 1.0)</u>
ConvF	<u>1.80</u>

B. SAR Measurement Results

Frequency (MHz)	5200.000000
Relative permittivity (real part)	35.128088
Relative permittivity (imaginary part)	15.673492
Conductivity (S/m)	4.527898
Variation (%)	3.790000

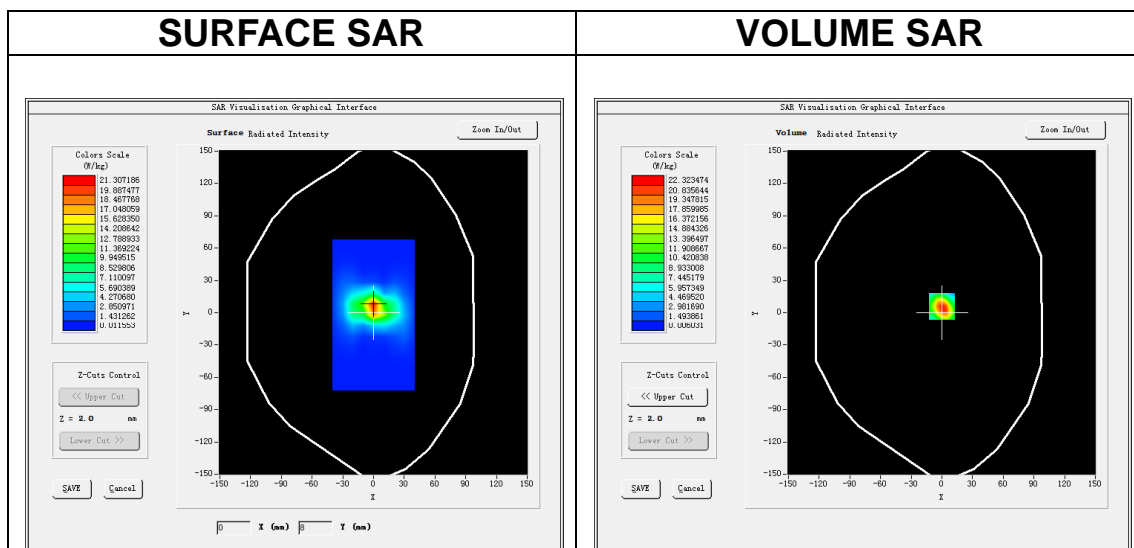

Maximum location: X=0.00, Y=6.00

SAR Peak: 40.06 W/kg

SAR 10g (W/Kg)	5.405217
SAR 1g (W/Kg)	16.476024

Z (m m)	0.00	2.00	4.00	6.00	8.00	10.0	12.0	14.0	16.0	18.0	20.0	22.0
SAR R (W/ Kg)	37.8 23	22.3 59	11.3 97	5.66 31	2.82 50	1.40 23	0.71 98	0.36 20	0.18 37	0.10 96	0.05 42	0.03 27

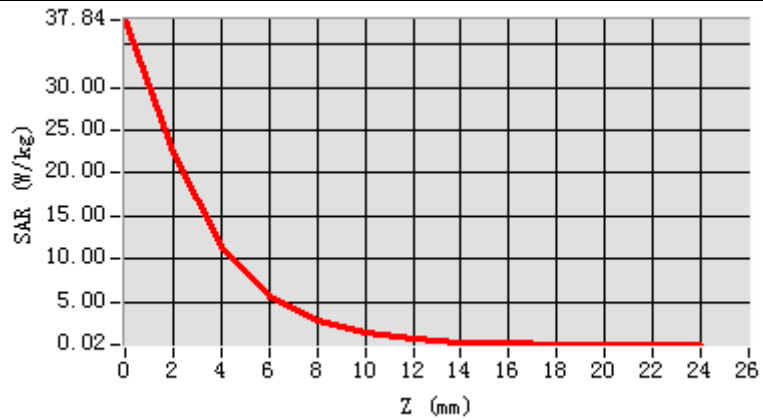

3D screen shot

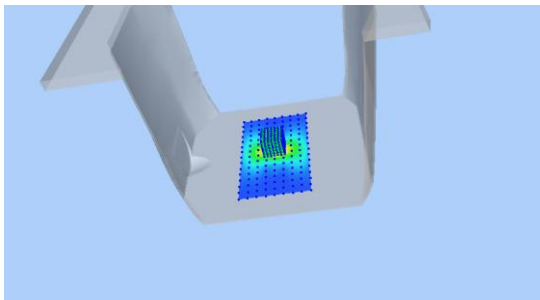

Hot spot position

