



深圳市三好无线通信有限公司

## 天线性能测试报告

### Antenna performance test report

client's name	云基
project name	P03
RF engineer	官炳坤
test date	2021.09.02

#### 1. Antenna matching circuit:

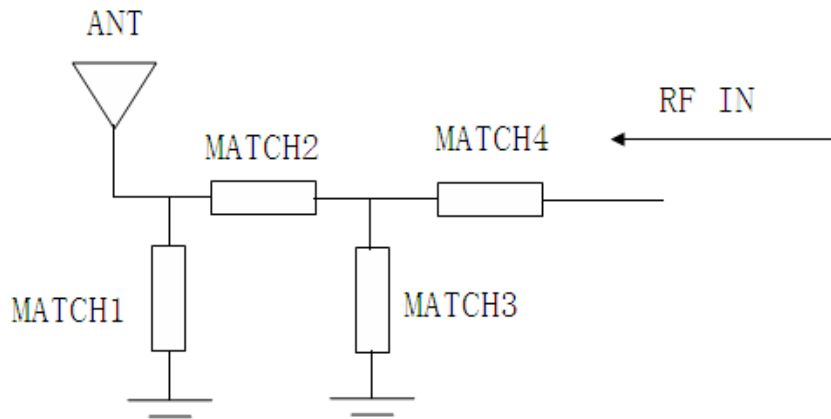

MATCH1	MATCH2	MATCH3	MATCH4
	0Ω		0Ω

### 1、 Antenna test equipment:

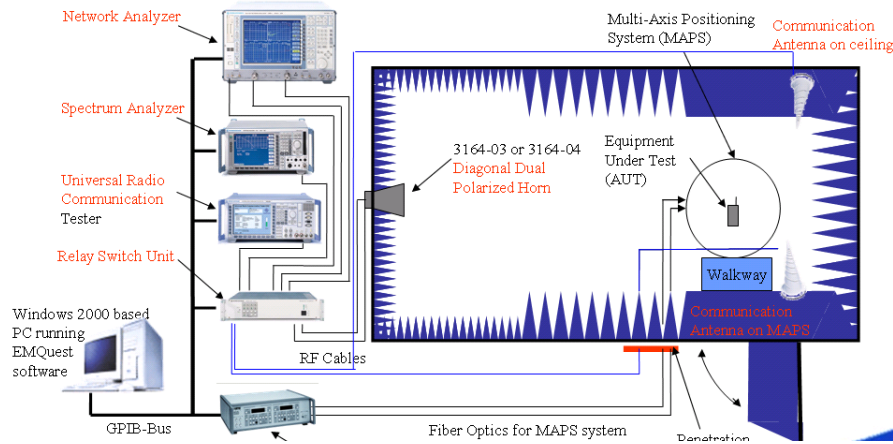

Confidential Information  
Shenzhen 3Good Wireless Communication Co., Ltd

---

**The performance test report is as follows:**

频段	GPS	WIFI2.4	BT	WIFI 5G		
增益	0.97	0.84	0.94	1.02		

Gain&Efficiency				
增益和效率				
frequency	gain	mingain	efficiency	efficiency
频率	增益	最小增益	效率(dBi)	效率(%)
(MHz)	(dBi)	(dBi)		
2400	0.53	-25.99	-4.53	35.20
2410	0.62	-23.61	-3.82	41.49
2420	0.68	-21.67	-3.55	44.17
2430	0.76	-20.53	-4.12	38.73
2440	0.84	-22.03	-3.55	44.13
2450	0.82	-22.31	-3.61	43.57
2460	0.63	-25.15	-3.78	41.84
2470	0.71	-29.64	-3.5	44.65
2480	0.94	-32.07	-3.5	44.65
2490	1.41	-27.68	-3.99	39.88
2500	1.93	-23.97	-3.55	44.15

Confidential Information  
Shenzhen 3Good Wireless Communication Co., Ltd

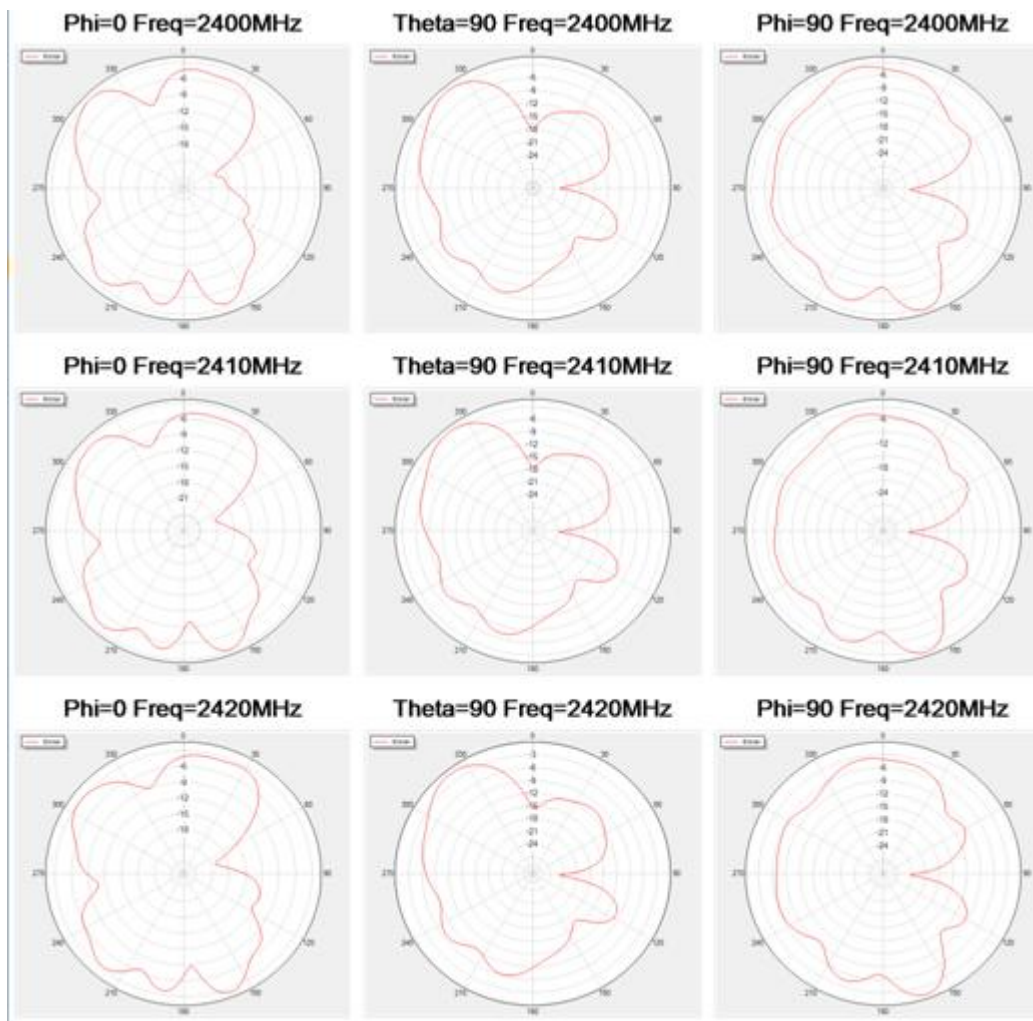

Confidential Information  
Shenzhen 3Good Wireless Communication Co., Ltd

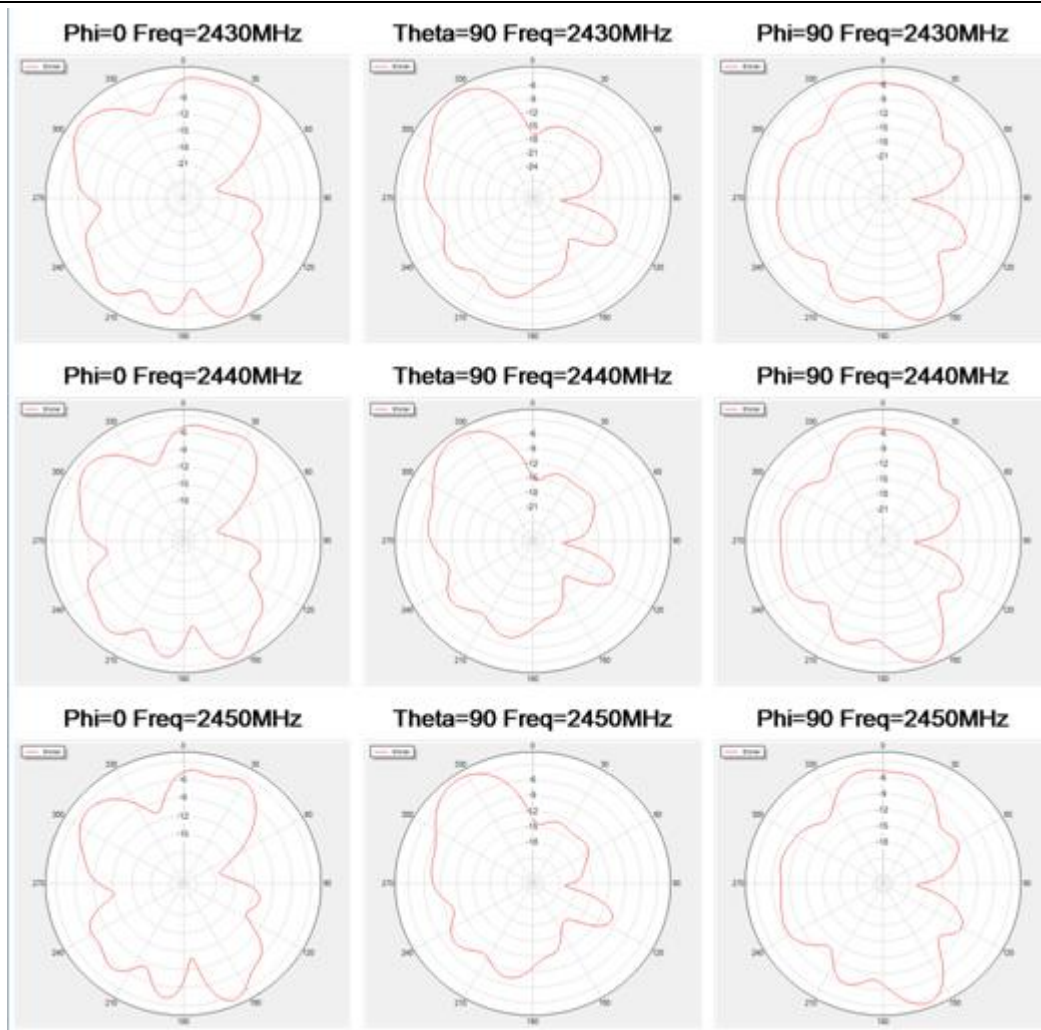

Confidential Information  
Shenzhen 3Good Wireless Communication Co., Ltd

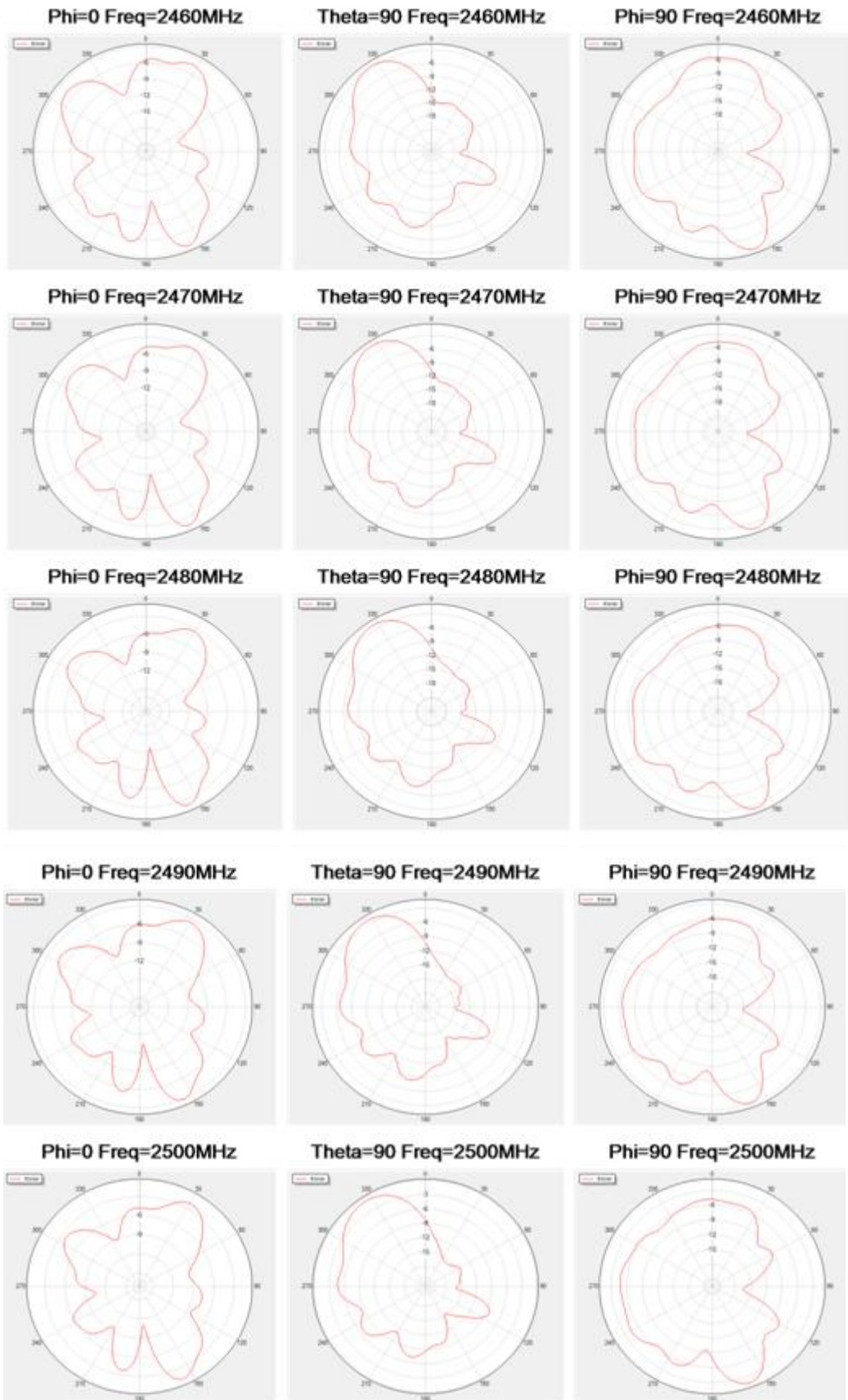

Confidential Information  
Shenzhen 3Good Wireless Communication Co., Ltd

Gain&Efficiency&PhaseCenter					
增益、效率和相位中心					
frequency	gain	gain	directivity	efficiency	efficiency
频率 (MHz)	增益 (dBi)	增益对应角度 (°)	方向性系数 (dB)	效率(dB)	效率(%)
5100	-2.25	$\psi=24,\theta=158$	6.43	-8.69	13.53
5120	-2.66	$\psi=31,\theta=158$	6.36	-9.01	12.55
5140	-2.94	$\psi=29,\theta=158$	6	-8.93	12.79
5160	-2.49	$\psi=357,\theta=159$	6.34	-8.83	13.08
5180	-3.19	$\psi=22,\theta=159$	6.42	-9.61	10.94
5200	-3.62	$\psi=24,\theta=159$	6.47	-10.1	9.78
5220	-2.41	$\psi=351,\theta=159$	6.87	-9.28	11.8
5240	-2.84	$\psi=9,\theta=160$	6.44	-9.28	11.8
5260	-3.57	$\psi=25,\theta=159$	6.28	-9.85	10.35
5280	-3.91	$\psi=329,\theta=151$	6.48	-10.4	9.13
5300	-2.71	$\psi=23,\theta=159$	6.47	-9.19	12.06
5320	-1.92	$\psi=31,\theta=159$	7.03	-8.95	12.73
5340	-2.58	$\psi=33,\theta=159$	6.77	-9.35	11.62
5360	-3.43	$\psi=334,\theta=155$	6.43	-9.85	10.35
5380	-2.13	$\psi=331,\theta=154$	6.62	-8.75	13.34
5400	-1.99	$\psi=332,\theta=155$	6.43	-8.42	14.4
5420	-3.04	$\psi=331,\theta=154$	6.09	-9.13	12.23
5440	-2.72	$\psi=32,\theta=158$	6.38	-9.1	12.31
5460	-2.7	$\psi=335,\theta=156$	6.28	-8.98	12.63
5480	-1.87	$\psi=337,\theta=157$	6.39	-8.25	14.95
5500	-2.22	$\psi=331,\theta=155$	6.28	-8.49	14.15
5520	-2.21	$\psi=333,\theta=155$	6.16	-8.36	14.57
5540	-2.72	$\psi=337,\theta=157$	5.85	-8.56	13.92
5560	-1.71	$\psi=338,\theta=157$	6.16	-7.87	16.33
5580	-1.99	$\psi=338,\theta=157$	6.14	-8.12	15.4
5600	-2.12	$\psi=339,\theta=157$	6.34	-8.46	14.26
5620	-2.32	$\psi=338,\theta=157$	6.44	-8.76	13.29



Confidential Information  
Shenzhen 3Good Wireless Communication Co., Ltd

5640	-2.13	$\psi=340,\theta=158$	5.91	-8.03	15.73
5660	-1.52	$\psi=337,\theta=156$	6.08	-7.61	17.35
5680	-1.44	$\psi=340,\theta=157$	6.32	-7.76	16.76
5700	-1.76	$\psi=343,\theta=159$	6.09	-7.86	16.38
5720	-0.82	$\psi=342,\theta=159$	6.1	-6.92	20.32
5740	1.02	$\psi=338,\theta=158$	6.3	-6.69	21.45
5760	-1	$\psi=337,\theta=158$	6.28	-7.27	18.74
5780	-0.94	$\psi=340,\theta=159$	6.28	-7.22	18.97
5800	-1.08	$\psi=344,\theta=160$	5.8	-6.88	20.5

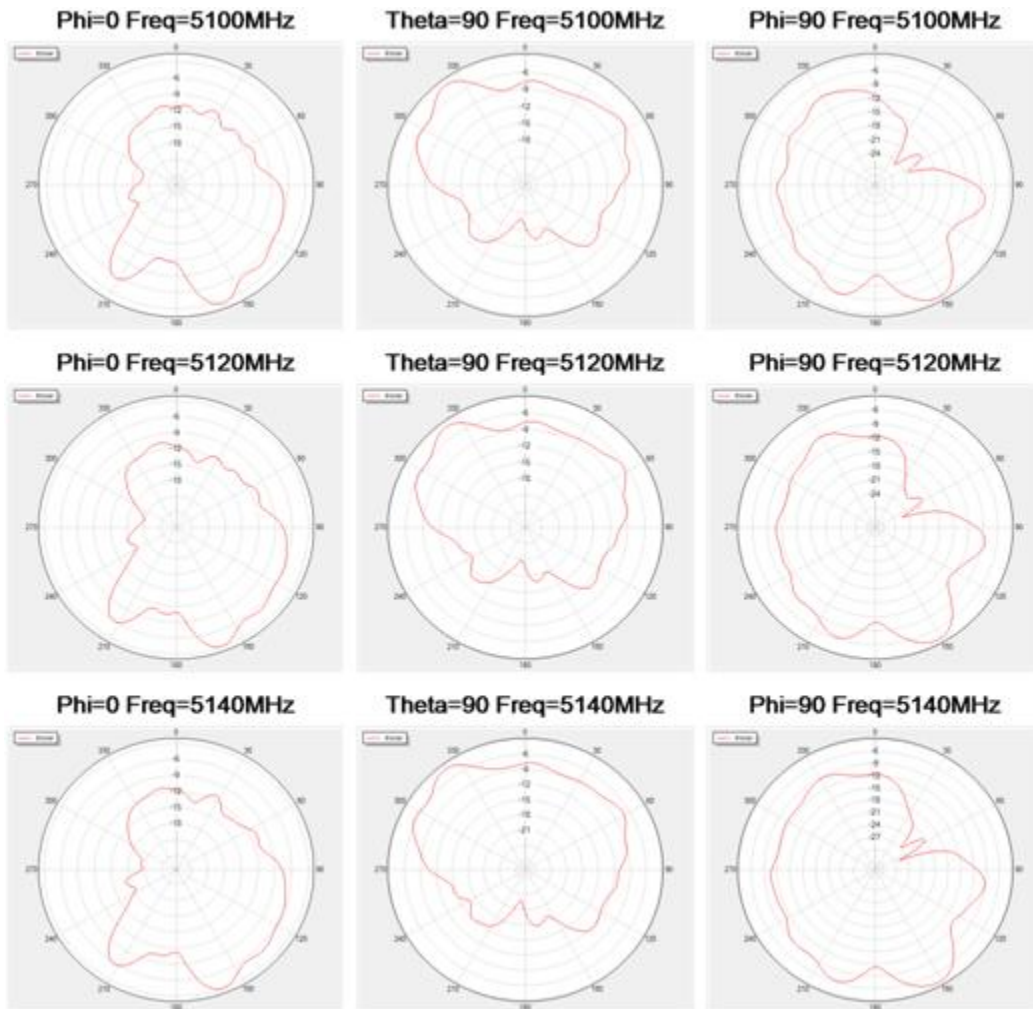



Confidential Information  
Shenzhen 3Good Wireless Communication Co., Ltd

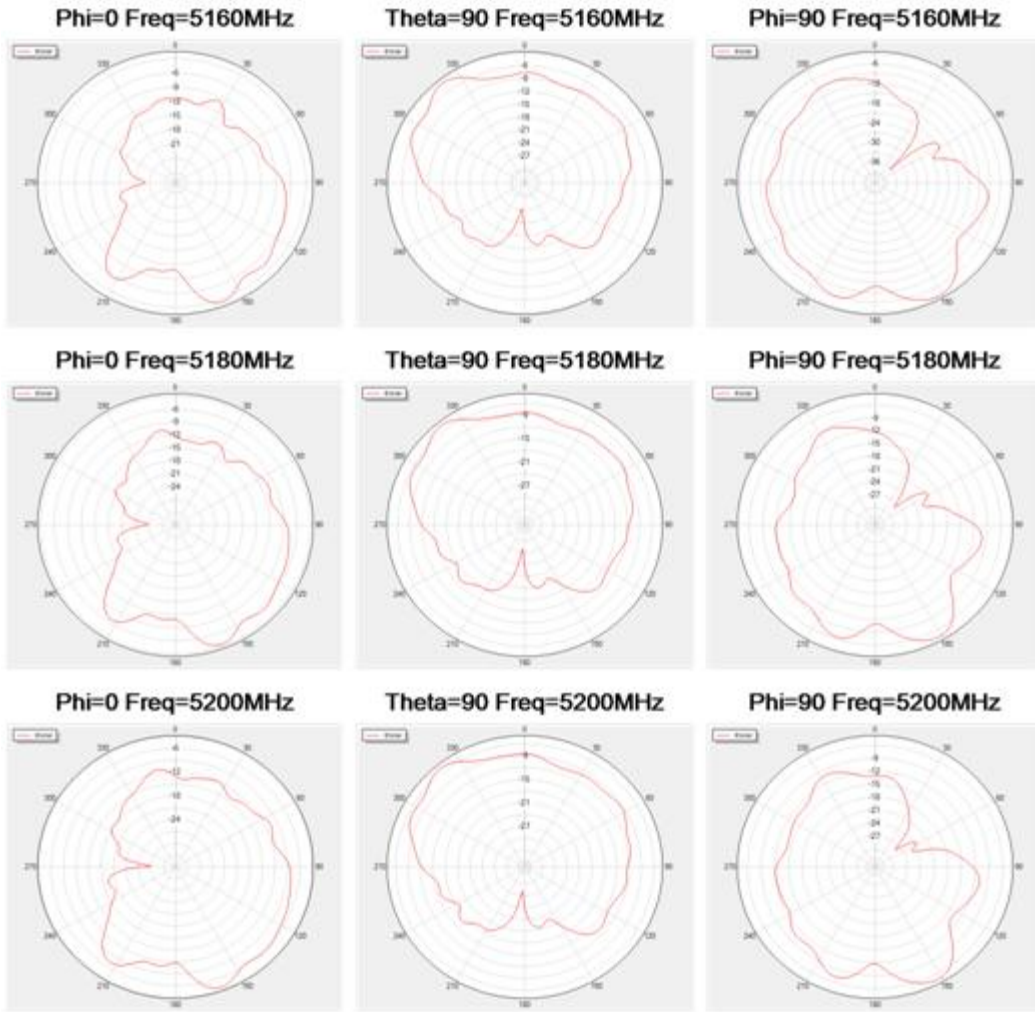

Confidential Information  
Shenzhen 3Good Wireless Communication Co., Ltd

---

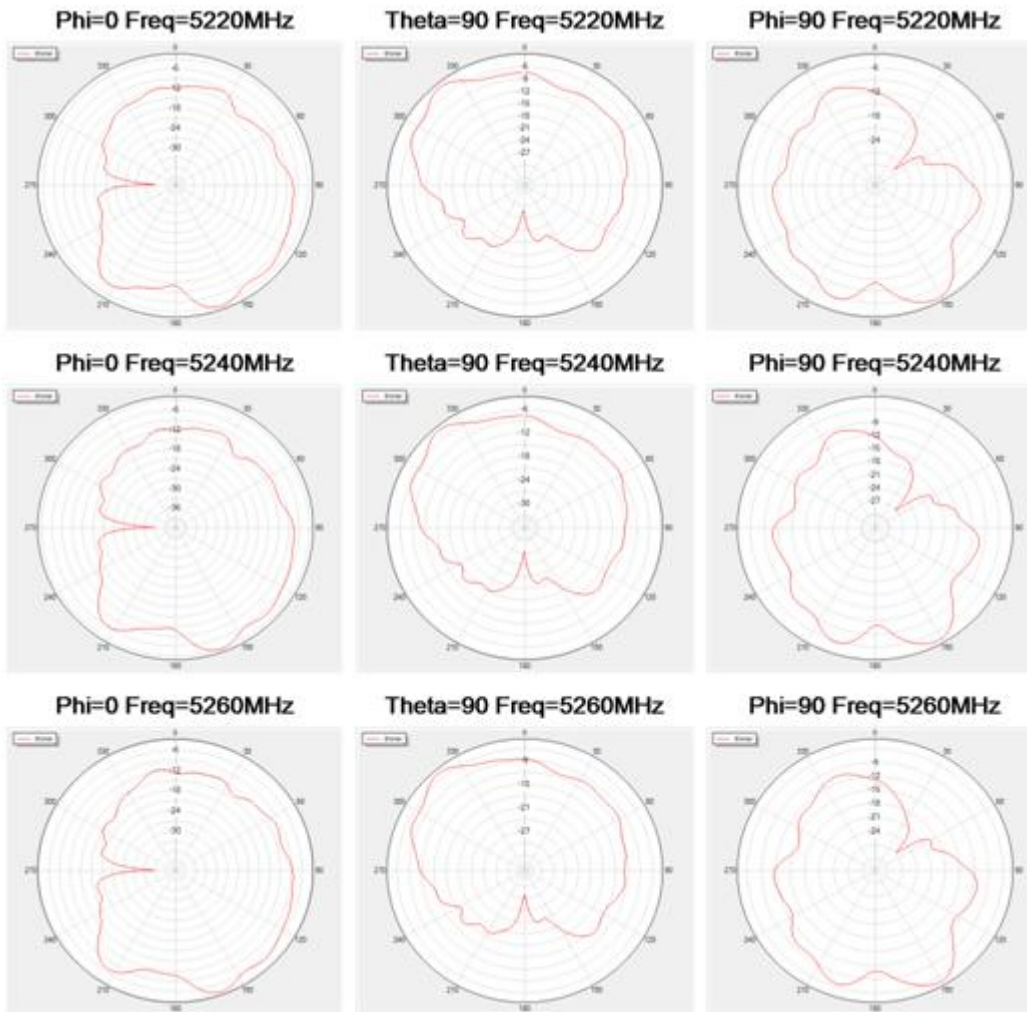

Confidential Information  
Shenzhen 3Good Wireless Communication Co., Ltd

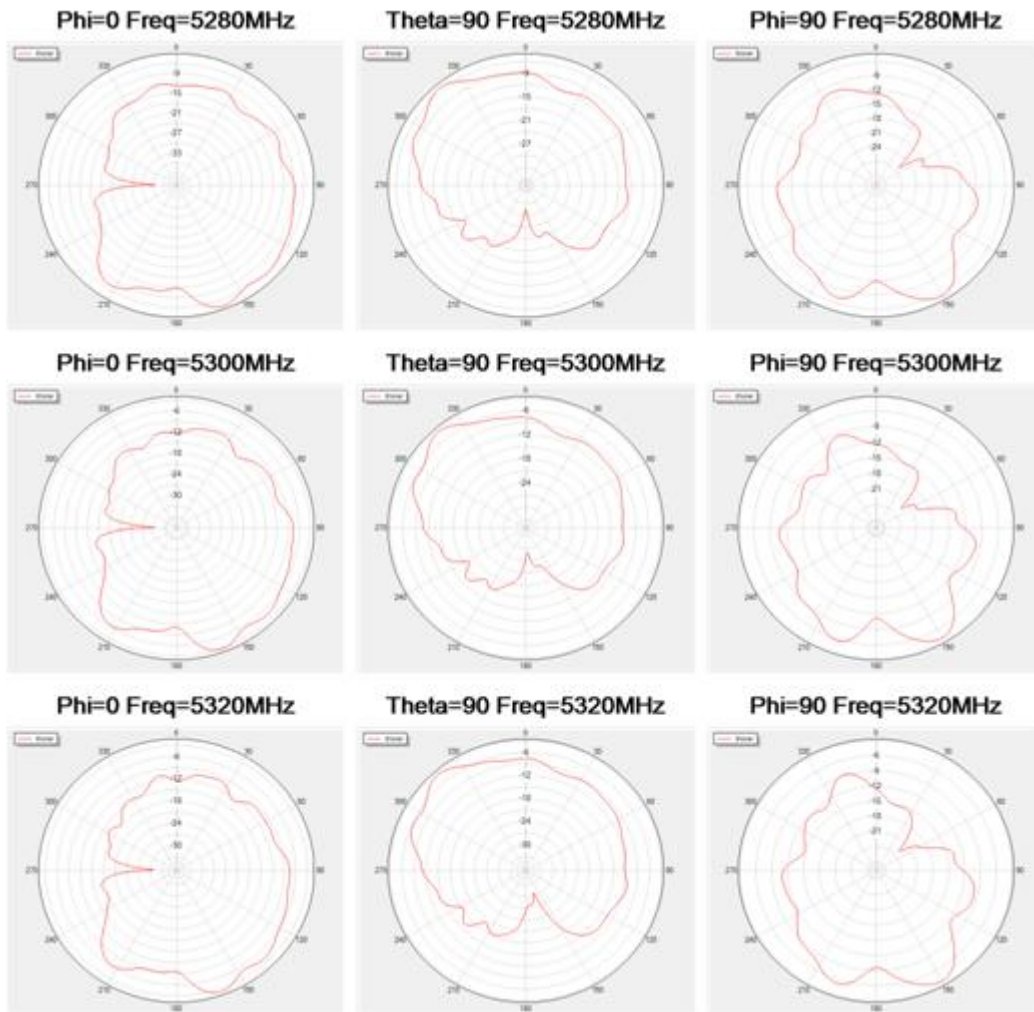

Confidential Information  
Shenzhen 3Good Wireless Communication Co., Ltd

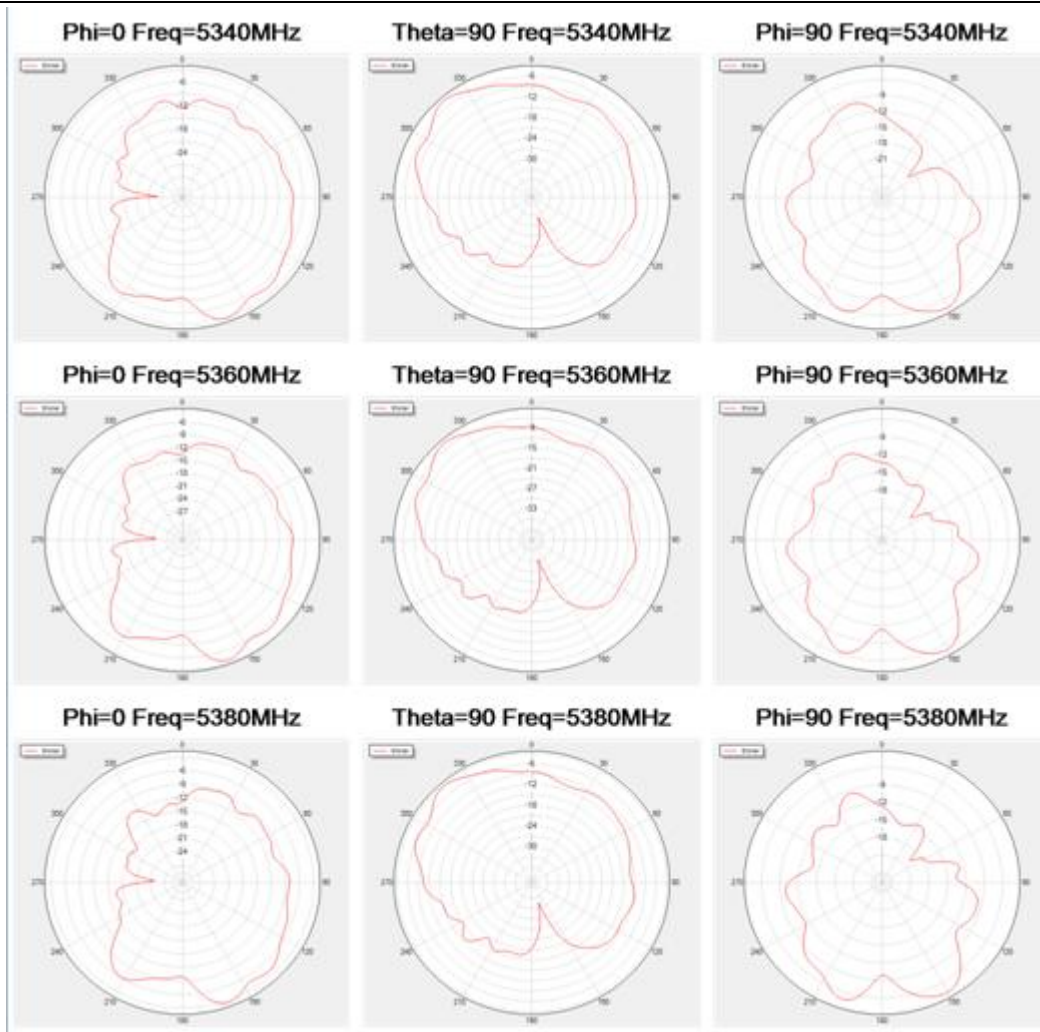

Confidential Information  
Shenzhen 3Good Wireless Communication Co., Ltd

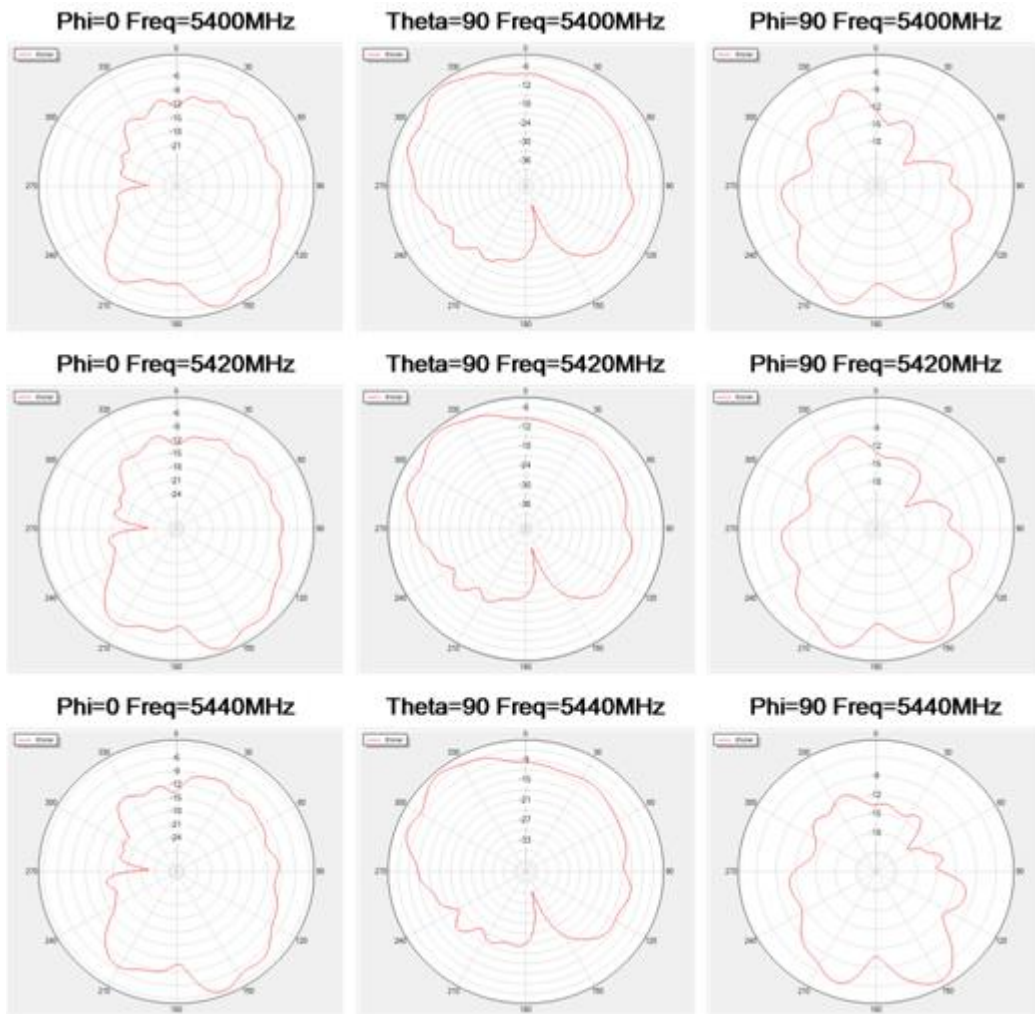



Confidential Information  
Shenzhen 3Good Wireless Communication Co., Ltd

---

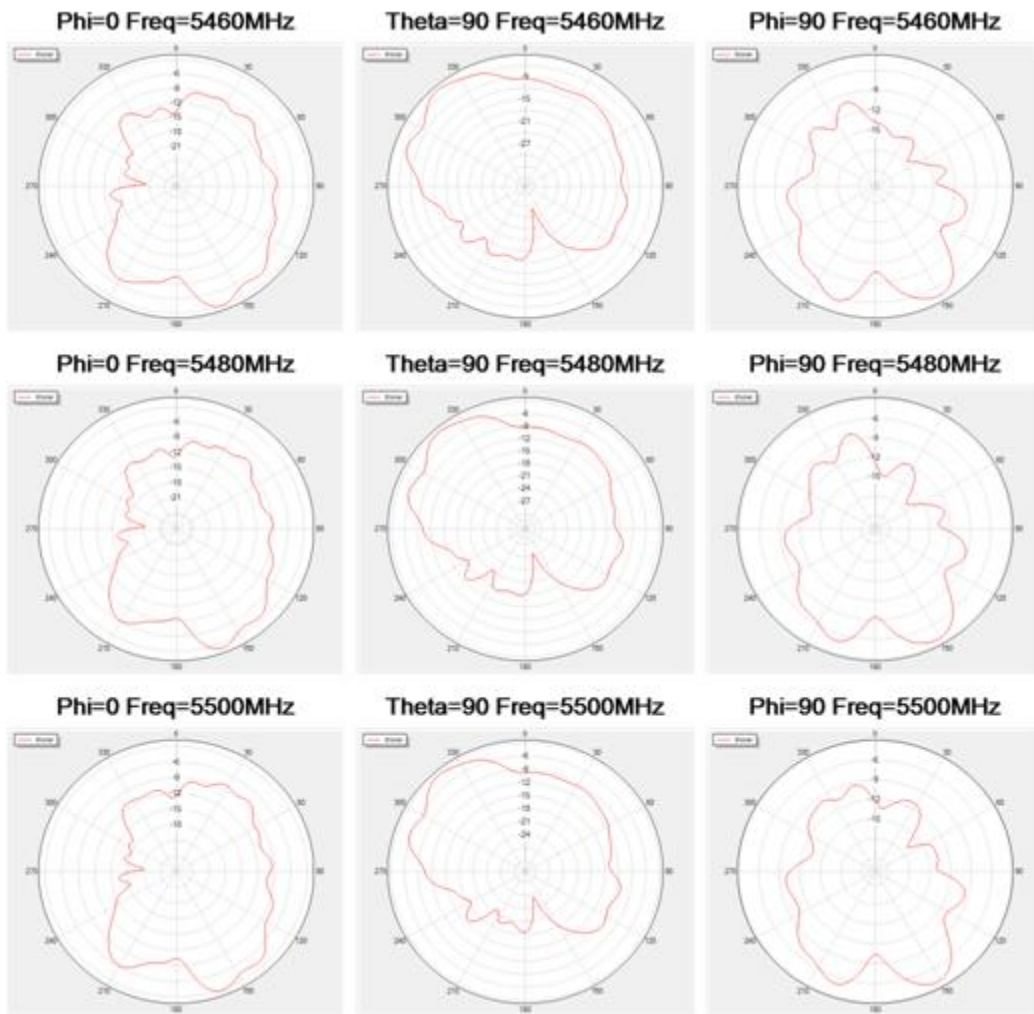

Confidential Information  
Shenzhen 3Good Wireless Communication Co., Ltd

---

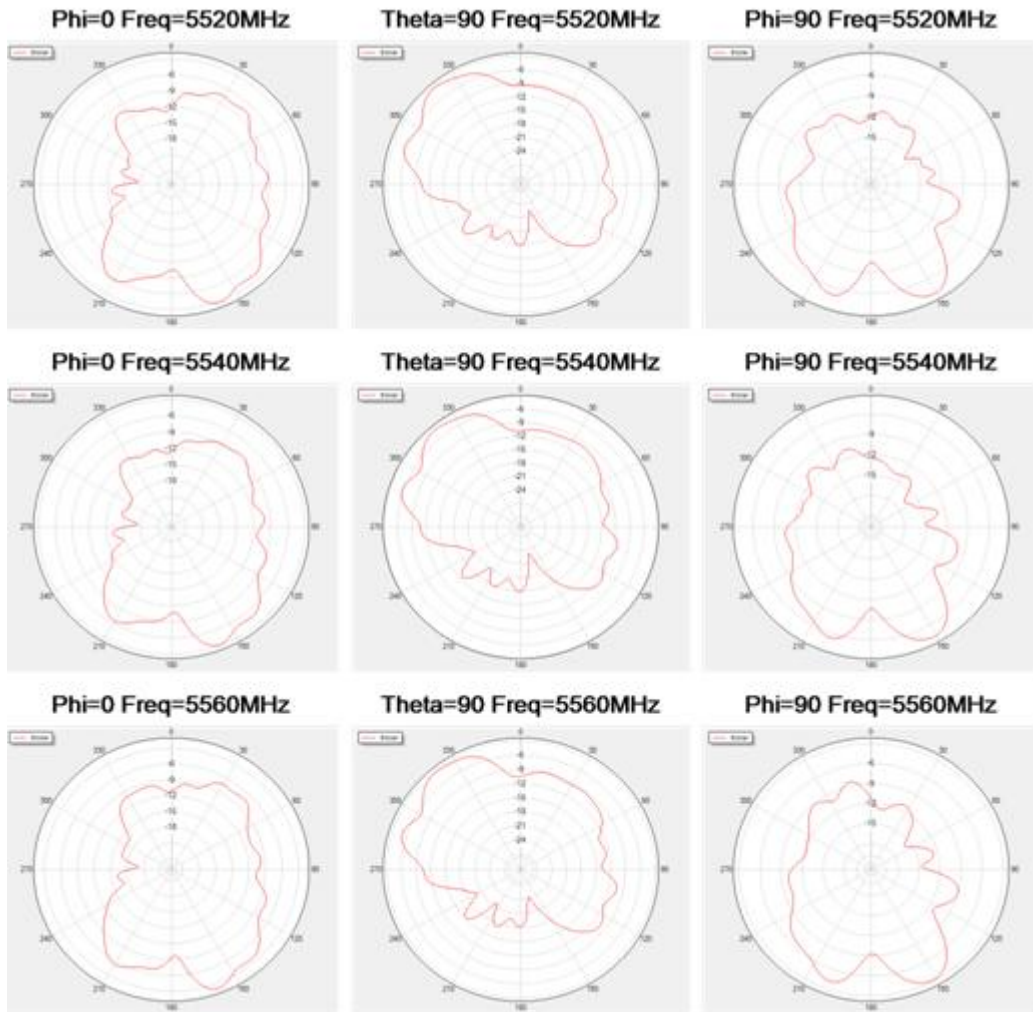



Confidential Information  
Shenzhen 3Good Wireless Communication Co., Ltd

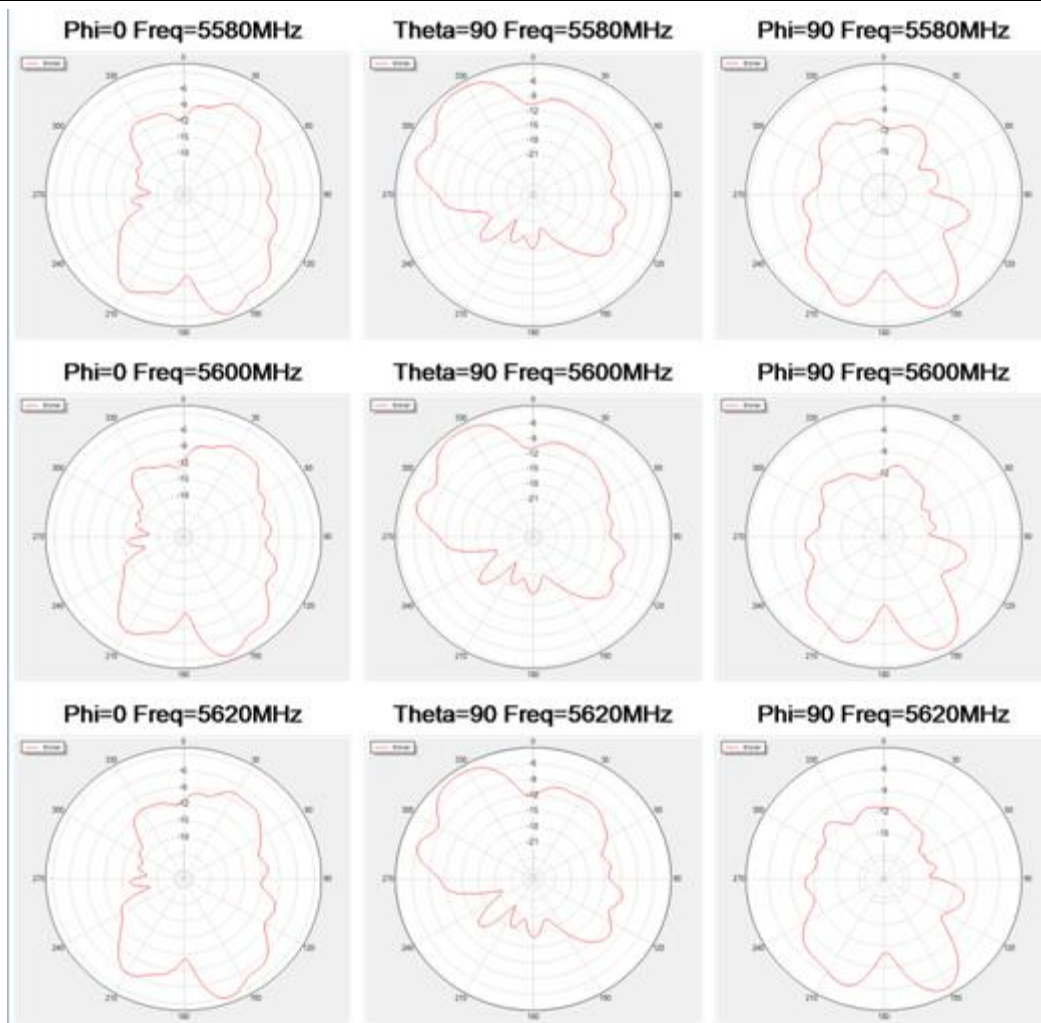

Confidential Information  
Shenzhen 3Good Wireless Communication Co., Ltd

---

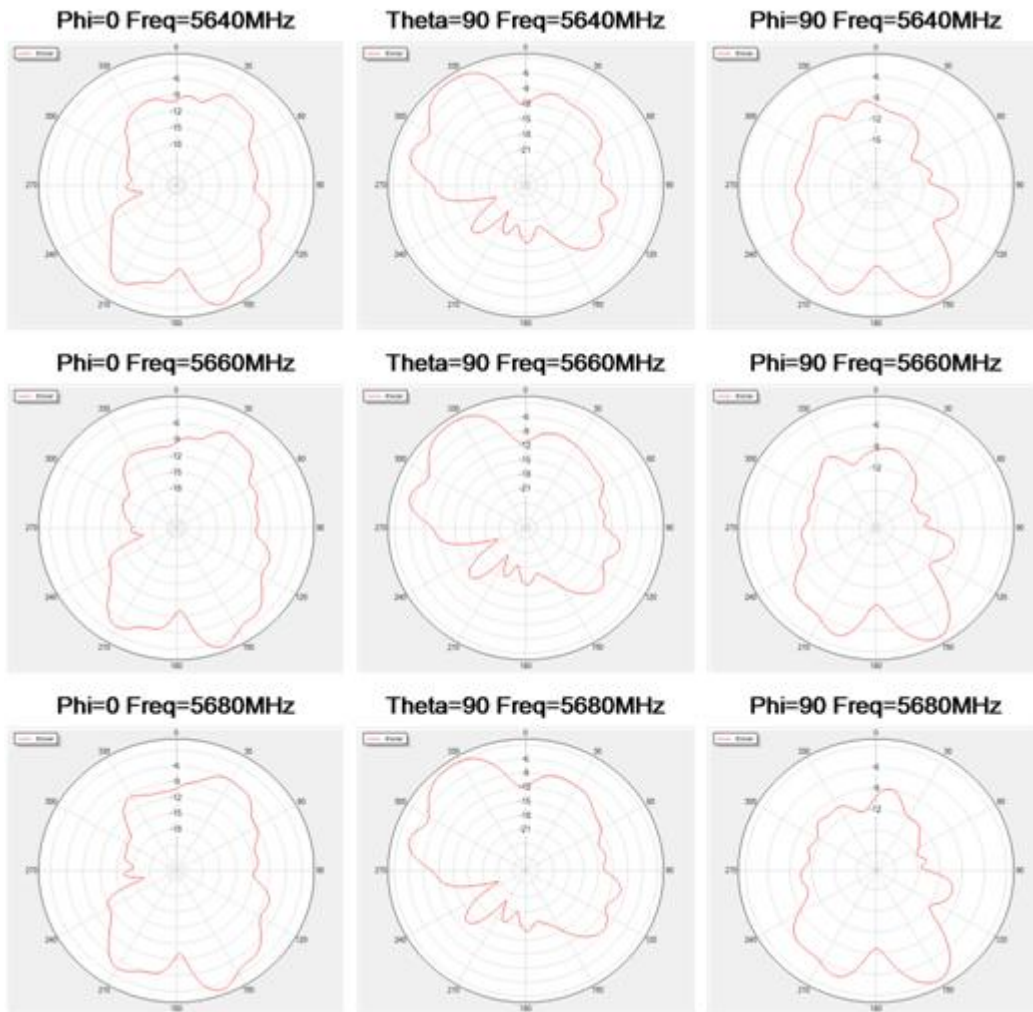

Confidential Information  
Shenzhen 3Good Wireless Communication Co., Ltd

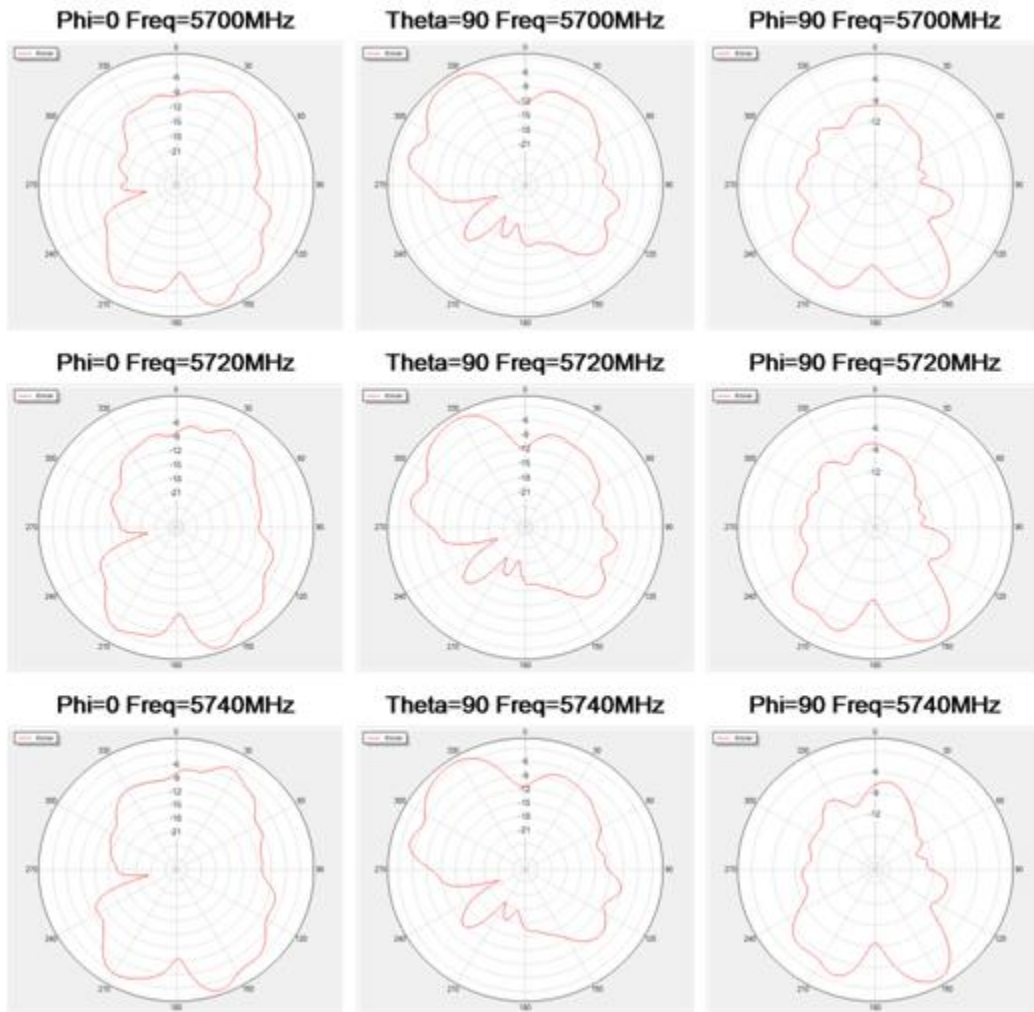

Confidential Information  
Shenzhen 3Good Wireless Communication Co., Ltd

