

TEST REPORT

Report No.: BCTC2211946586-5E

Applicant: SHENZHEN YUNJI INTELLIGENT TECHNOLOGY
CO.,LTD

Product Name: Tablet

Model/Type
reference: RT3

Tested Date: 2022-11-16 to 2022-12-08

Issued Date: 2022-12-09

Shenzhen BCTC Testing Co., Ltd.



FCC ID: 2ANMU-RT3

Product Name: Tablet

Trademark: OUKITEL

Model/Type reference: RT3
RT3 Pro, RT3 S

Prepared For: SHENZHEN YUNJI INTELLIGENT TECHNOLOGY CO.,LTD

Address: A2 2F BUILDING ENET NEW INDUSTRIAL PARK, DAFU INDUSTRIAL ZONE,
GUANLAN, LONGHUA SHENZHEN, 518XXX China

Manufacturer: SHENZHEN YUNJI INTELLIGENT TECHNOLOGY CO.,LTD

Address: A2 2F BUILDING ENET NEW INDUSTRIAL PARK, DAFU INDUSTRIAL ZONE,
GUANLAN, LONGHUA SHENZHEN, 518XXX China

Prepared By: Shenzhen BCTC Testing Co., Ltd.

Address: 1-2/F., Building B, Pengzhou Industrial Park, No.158, Fuyuan 1st Road,
Zhancheng, Fuhai Subdistrict, Bao'an District, Shenzhen, Guangdong, China

Sample Received Date: 2022-11-16

Sample tested Date: 2022-11-16 to 2022-12-08

Issue Date: 2022-12-09

Report No.: BCTC2211946586-5E

Test Standards: FCC CFR Title 47 Part 2
FCC CFR Title 47 Part22 Subpart H
FCC CFR Title 47 Part24 Subpart E
FCC CFR Title 47 Part27 Subpart L
ANSI/ TIA/ EIA-603-D-2010
FCC KDB 971168 D01 Power Meas. License Digital Systems v02v02

Test Results: PASS

Remark: This is GSM & WCDMAradio test report.

Tested by:

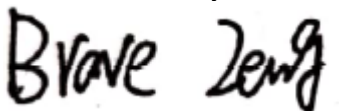
Brave Zeng/ Project Handler

Approved by:

Zero Zhou/Reviewer

The test report is effective only with both signature and specialized stamp. This result(s) shown in this report refer only to the sample(s) tested. Without written approval of Shenzhen BCTC Testing Co., Ltd, this report can't be reproduced except in full. The tested sample(s) and the sample information are provided by the client.



Table Of Content

	Page
Test Report Declaration	
1. Version	4
2. Test Summary	5
3. Measurement Uncertainty	6
4. Product Information And Test Setup	7
4.1 Product Information.....	7
4.2 Test Setup Configuration	8
4.3 Support Equipment	8
4.5 Test Mode	9
5. Test Facility And Test Instrument Used.....	10
5.1 Test Facility.....	10
5.2 Test Instrument Used.....	10
6. RF Output Power.....	11
6.1 Block Diagram Of Test Setup.....	11
6.2 Limit	12
6.3 Test procedure.....	13
6.4 Test Result.....	13
7. Peak-to-average Ratio(PAR) of Transmitter.....	21
7.1 Block Diagram Of Test Setup.....	21
7.2 Limit	21
7.3 Test procedure.....	21
7.4 Test Result.....	21
8. Emission Bandwidth	37
8.1 Block Diagram Of Test Setup.....	37
8.2 Limit	37
8.3 Test procedure.....	37
8.4 Test Result.....	37
9. Out of Band Emissions at Antenna Terminal.....	53
9.1 Block Diagram Of Test Setup.....	53
9.2 Limit	53
9.3 Test procedure.....	53
9.4 Test Result.....	53
10. Spurious Radiated Emissions.....	77
10.1 Block Diagram Of Test Setup.....	77
10.2 Limit	78
10.3 Test procedure.....	78
10.4 Test Result.....	79
11. Frequency Stability.....	82
11.1 Block Diagram Of Test Setup.....	82
11.2 Limit	82
11.3 Test procedure.....	82
11.4 Test Result.....	83
12. EUT Photographs.....	86
13. EUT Test Setup Photographs.....	87

(Note: N/A Means Not Applicable)

 BCTC
 BCTC
 PPR
 检测

1. Version

Report No.	Issue Date	Description	Approved
BCTC2211946586-5E	2022-12-09	Original	Valid

TEC
TC
OVER
檢

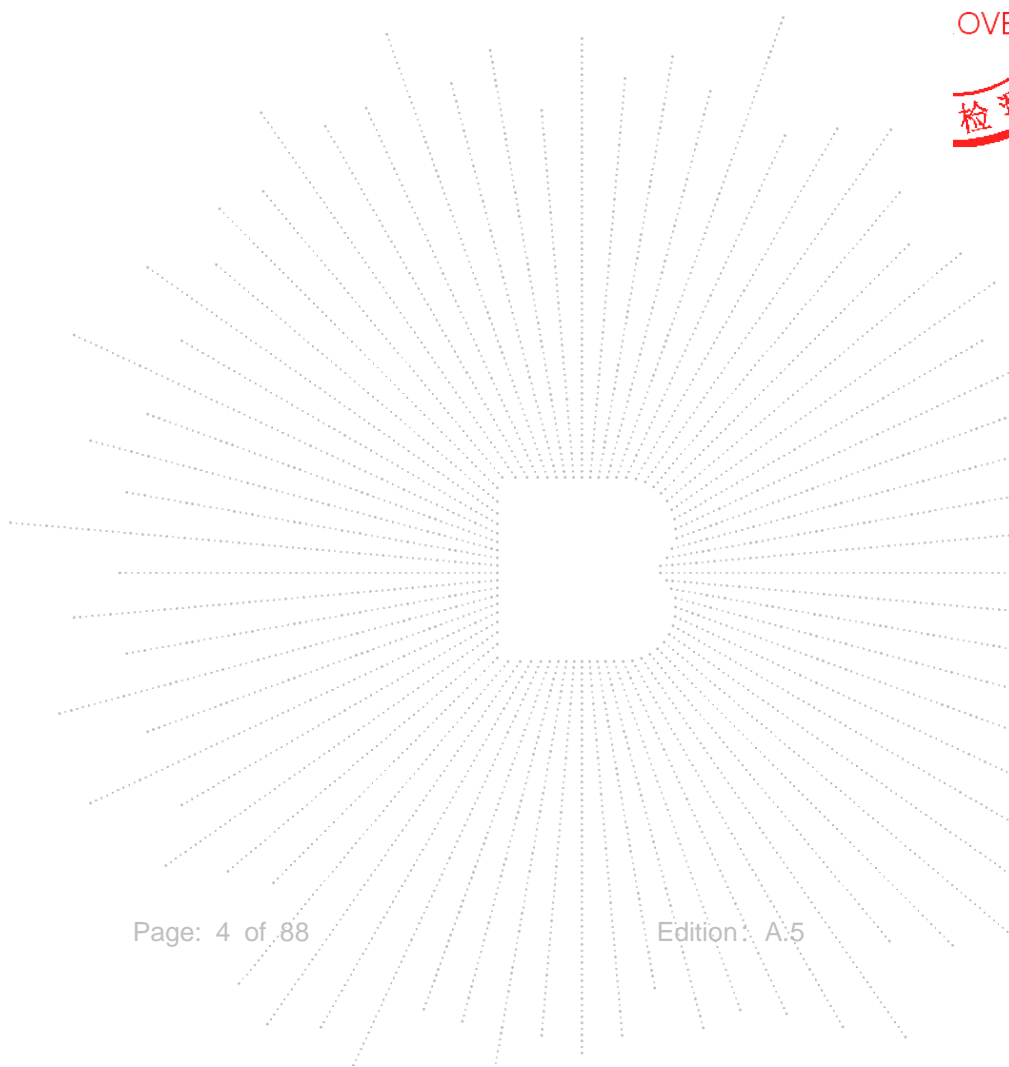

2. Test Summary

The Product has been tested according to the following specifications:

No.	Test Parameter	Clause No.	Results
1	RF Exposure	§1.1307, §2.1093	PASS
2	RF Output Power	§22.913 (a), §24.232 (c), §27.50 (d),	PASS
3	Peak-to-average Ratio(PAR) of Transmitter	§24.232(d), §22.913, §27.50(d),	PASS
4	Emission Bandwidth	§22.917 (b), §24.238(b), §27.53(g)	PASS
5	Spurious Emissions at Antenna Terminal	§22.917 (a), §24.238 (a), §27.53(g), §27.53(h)	PASS
6	Spurious Radiation Emissions	§22.917 (a), §24.238 (a), §27.53(g), §27.53(h)	PASS
7	Out of Band Emissions	§22.917 (a), §24.238 (a), §27.53(g), §27.53(h)	PASS
8	Frequency Stability	§22.355, §24.235, §27.54	PASS

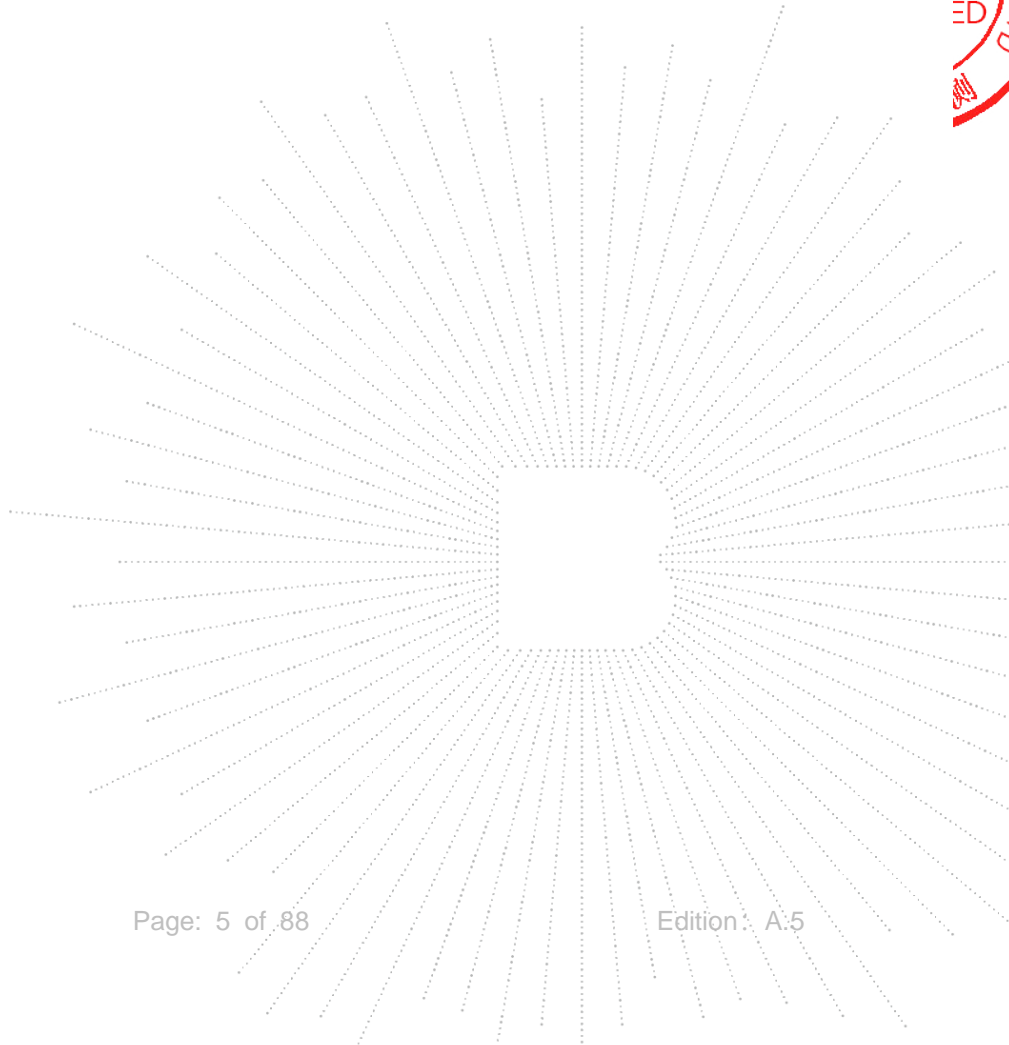

3. Measurement Uncertainty

Where relevant, the following measurement uncertainty levels have been estimated for tests performed on the Product as specified in CISPR 16-4-2. This uncertainty represents an expanded uncertainty expressed at approximately the 95% confidence level using a coverage factor of k=2.

No.	Item	Uncertainty
1	3m chamber Radiated spurious emission(30MHz-1GHz)	U=4.3dB
2	3m chamber Radiated spurious emission(9KHz-30MHz)	U=3.7dB
3	3m chamber Radiated spurious emission(1GHz-18GHz)	U=4.5dB
4	3m chamber Radiated spurious emission(18GHz-40GHz)	U=3.34dB
5	Conducted Emission (150kHz-30MHz)	U=3.20dB
6	Conducted Adjacent channel power	U=1.38dB
7	Conducted output power uncertainty Above 1G	U=1.576dB
8	Conducted output power uncertainty below 1G	U=1.28dB
9	humidity uncertainty	U=5.3%
10	Temperature uncertainty	U=0.59°C



4. Product Information And Test Setup

4.1 Product Information

Model/Type reference:	RT3 RT3 Pro, RT3 S
Model differences:	All the model are the same circuit and RF module, except model names.
Hardware Version:	N/A
Software Version:	N/A
Operation Frequency:	GSM/GPRS/EGPRS 850: TX: 824~849MHz; RX: 869~894MHz; GSM/GPRS/EGPRS 1900: TX:1850~1910MHz; RX:1930~1990MHz; WCDMA Band II: TX: 1852.40~1907.60MHz; Rx: 1932.60~1987.40MHz; WCDMA Band IV: TX: 1712.40~1752.60MHz; RX: 2112.60 – 2452.40MHz WCDMA Band V: TX: 826.40~846.60MHz; RX: 871.40~ 891.60MHz;
GPRS Class:	Class 12
Max RF Output Power:	GSM/GPRS/EGPRS 850: 31.45 dBm, GSM/GPRS/EGPRS 1900: 25.19 dBm WCDMA Band II: 18.97 dBm WCDMA Band IV: 19.42 dBm WCDMA Band V: 21.85 dBm
Type of Modulation:	GSM with GMSK Modulation WCDMA Mode with BPSK Modulation HSDPA Mode with QPSK, 16QAM Modulation HSUPA Mode with QPSK, 16QAM Modulation
Type of Emission:	GSM/GPRS 850: 251KGXW EGPRS 850:253KG7W GSM/GPRS 1900: 248KGXW EGPRS 1900:268KG7W WCDMA Band II: 4M17F9W WCDMA Band IV: 4M16F9W WCDMA Band V: 4M18F9W
Antenna installation:	Internal antenna
Antenna Gain:	GSM850: -0.13 dBi GSM1900: -0.05 dBi WCDMA Band II: -0.05 dBi WCDMA Band IV: 0.03 dBi WCDMA Band V: -0.13 dBi
Connecting I/O Port(s)	Please refer to the User's Manual
Ratings:	DC 5V from adapter/DC 3.85V from battery
Adapter Information:	Model: PS10UA050K2000UU Input: 100-240V~50/60Hz 0.35A Max Output: DC 5V 2.0A 10.0W

4.2 Test Setup Configuration

See test photographs attached in *EUT TEST SETUP PHOTOGRAPHS* for the actual connections between Product and support equipment.

Conducted Emission:

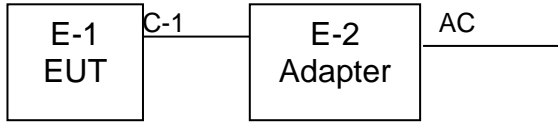

Radiated Spurious Emission

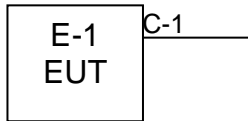

4.3 Support Equipment

No.	Device Type	Brand	Model	Series No.	Note
E-1	Tablet	OUKITEL	RT3	N/A	EUT
E-2	Adapter	N/A	PS10UA050K20 00UU	N/A	Auxiliary

Item	Shielded Type	Ferrite Core	Length	Note
C-1	N/A	N/A	1M	DC cable unshielded

Notes:

- All the equipment/cables were placed in the worst-case configuration to maximize the emission during the test.
- Grounding was established in accordance with the manufacturer's requirements and conditions for the intended use.



4.5 Test Mode

Testing Configure			
Support Band	Support Standard	Channel Frequency	Channel Number
GSM 850	GSM/GPRS/EGPRS	824.2 MHz	128
		836.6 MHz	190
		848.8 MHz	251
PCS 1900	GSM/GPRS/EGPRS	1850.2 MHz	512
		1880.0 MHz	661
		1909.8 MHz	810
WCDMA Band II	WCDMA/HSDPA/HSUPA	1852.4 MHz	9262
		1880.0 MHz	9400
		1907.6 MHz	9538
WCDMA Band IV	WCDMA/HSDPA/HSUPA	1712.4 MHz	1312
		1740 MHz	1450
		1752.6 MHz	1513
WCDMA Band V	WCDMA/HSDPA/HSUPA	826.4 MHz	4132
		836.4 MHz	4182
		846.6 MHz	4233

Note 1: the transmitter has been tested on the communications mode of WCDMA, HSDPA, HSUPA compliance test and record the worst case.
 Note 2: Both the SIM 1 and SIM 2 were tested, the worst mode is the SIM 1, the data recording in the report.

EUT Cable List and Details

Cable Description	Length (M)	Shielded/Unshielded	With Core/Without Core
/	/	/	/
/	/	/	/

Auxiliary Equipment List and Details

Description	Manufacturer	Model	Serial Number
/	/	/	/

Special Cable List and Details

Cable Description	Length (M)	Shielded/Unshielded	With Core/Without Core
/	/	/	/

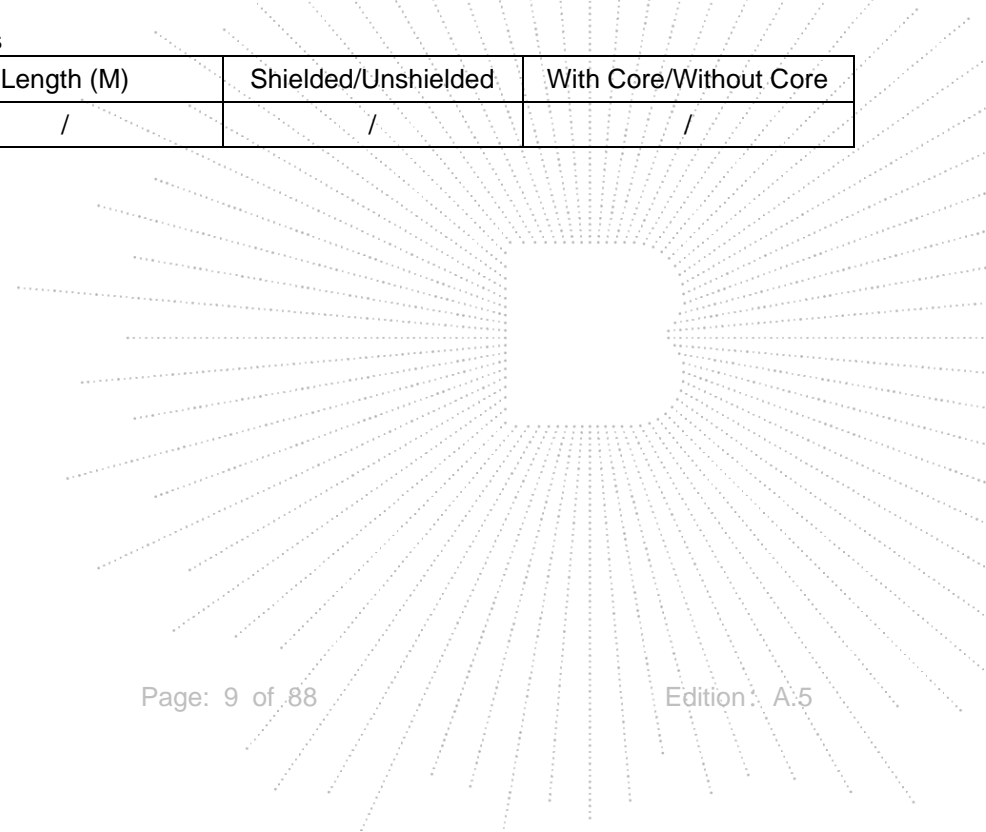

5. Test Facility And Test Instrument Used

5.1 Test Facility

All measurement facilities used to collect the measurement data are located at Shenzhen BCTC Testing Co., Ltd. Address:1-2/F., Building B, Pengzhou Industrial Park, No.158, Fuyuan 1st Road, Zhancheng, Fuhai Subdistrict, Bao'an District, Shenzhen, Guangdong, China. The site and apparatus are constructed in conformance with the requirements of ANSI C63.4 and CISPR 16-1-1 other equivalent standards.

FCC Test Firm Registration Number: 712850

IC Registered No.: 23583

5.2 Test Instrument Used

Radiated Emissions Test (966 Chamber01)					
Equipment	Manufacturer	Model#	Serial#	Last Cal.	Next Cal.
966 chamber	ChengYu	966 Room	966	Jun. 06. 2020	Jun. 05, 2023
Receiver	R&S	ESR3	102075	May 24, 2022	May 23, 2023
Receiver	R&S	ESRP	101154	May 24, 2022	May 23, 2023
Amplifier	SKET	LAPA_01G18 G-45dB	\	May 24, 2022	May 23, 2023
Amplifier	Schwarzbeck	BBV9744	9744-0037	May 24, 2022	May 23, 2023
TRILOG Broadband Antenna	Schwarzbeck	VULB9163	942	May 26, 2022	May 25, 2023
Horn Antenna	Schwarzbeck	BBHA9120D	1541	Jun. 06, 2022	Jun. 05, 2023
Horn Antenna(18G Hz-40GHz)	Schwarzbeck	BBHA9170	00822	Jun. 06, 2022	Jun. 05, 2023
Amplifier(18G Hz-40GHz)	MITEQ	TTA1840-35- HG	2034381	May 26, 2022	May 25, 2023
Loop Antenna(9KHz -30MHz)	Schwarzbeck	FMZB1519B	00014	May 26, 2022	May 25, 2023
Power Metter	Keysight	E4419	\	May 26, 2022	May 25, 2023
Power Sensor (AV)	Keysight	E9300A	\	May 26, 2022	May 25, 2023
Signal Analyzer20kH z-26.5GHz	Keysight	N9020A	MY49100060	May 26, 2022	May 25, 2023
Spectrum Analyzer9kHz- 40GHz	R&S	FSP40	\	May 26, 2022	May 25, 2023
Software	Frad	EZ-EMC	FA-03A2 RE	\	\

6. RF Output Power

6.1 Block Diagram Of Test Setup

Conducted output power test method:

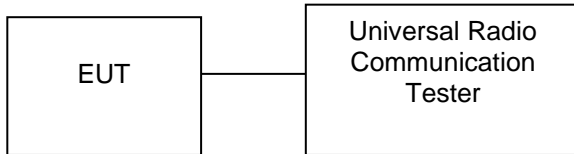

Radiated power test method:

(A) Radiated Emission Test-Up Frequency Below 30MHz

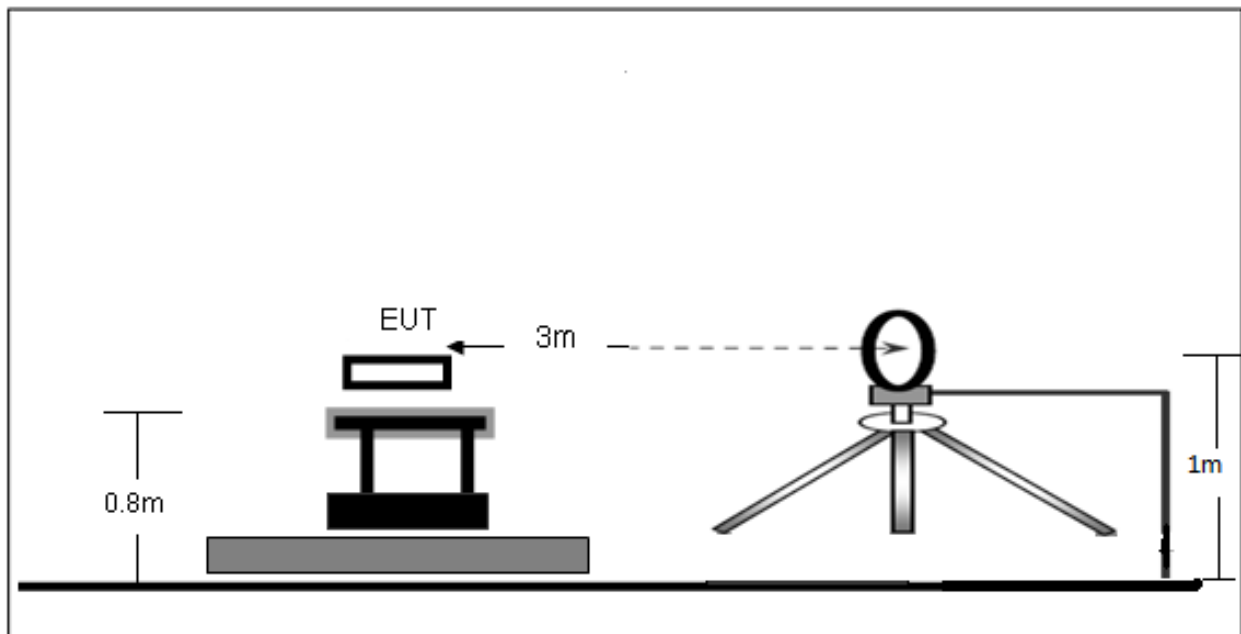

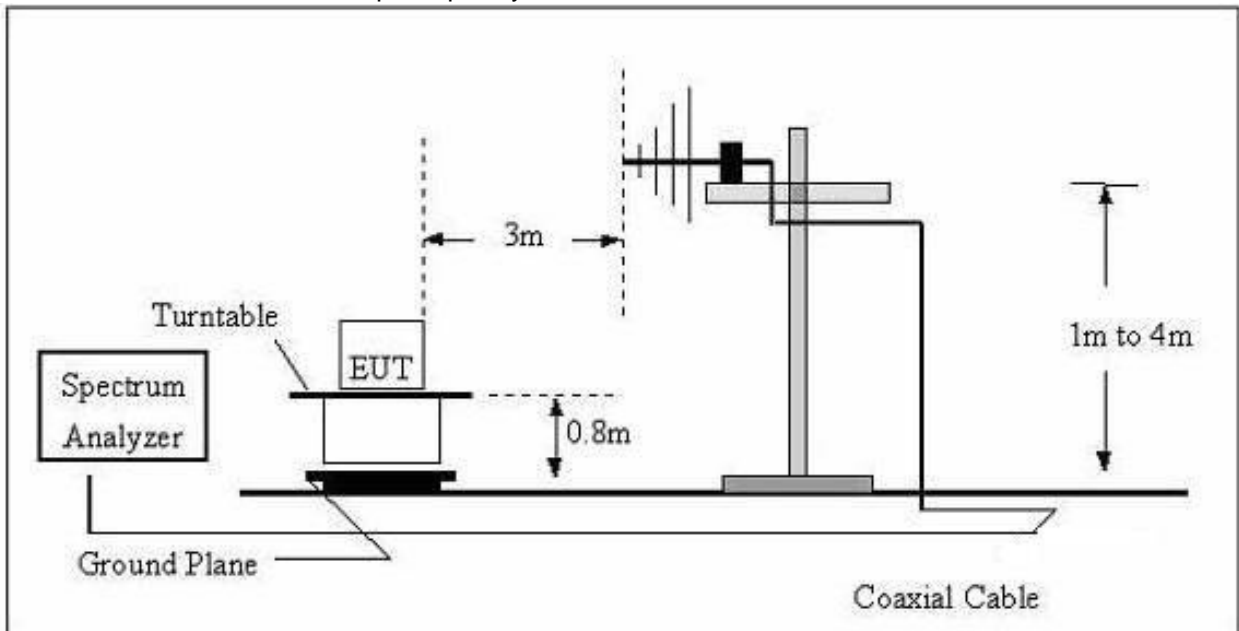
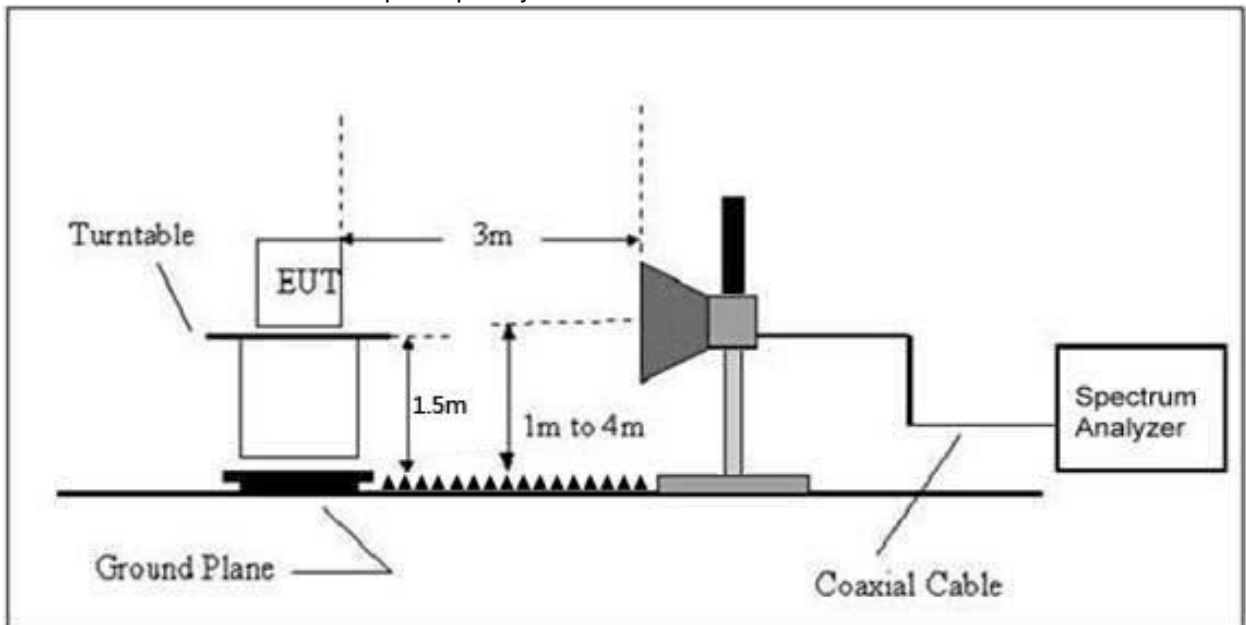
(B) Radiated Emission Test-Up Frequency 30MHz~1GHz

(C) Radiated Emission Test-Up Frequency Above 1GHz

6.2 Limit

According to §22.913(a)(2), The ERP of mobile and portable stations transmitters and auxiliary test transmitters must not exceed 7 Watts.

According to §24.232 (c), Mobile and portable stations are limited to 2 watts EIRP and the equipment must employ a means for limiting power to the minimum necessary for successful communications.

According to §27.50(d)(4), Fixed, mobile, and portable (hand-held) stations operating in the 1710-1755 MHz band and mobile and portable stations operating in the 1695-1710 MHz and 1755-1780 MHz bands are limited to 1 watt EIRP.

6.3 Test procedure

Radiated power test method:

1. The setup of EUT is according with per ANSI/TIA Standard 603D and ANSI C63.4-2014 measurement procedure.
2. The measurement antenna was placed at a distance of 3 meters from the EUT. During the tests, the antenna height and polarization as well as EUT azimuth were varied in order to identify the maximum level of emissions from the EUT. The test was performed by placing the EUT on 3-orthogonal axis.
3. The frequency range up to tenth harmonic of the fundamental frequency was investigated.
4. Remove the EUT and replace it with substitution antenna. A signal generator was connected to the substitution antenna by a non-radiating cable. The absolute levels of the spurious emissions were measured by the substitution.

6.4 Test Result

ERP For GSM Mode GSM850

Frequency (MHz)	Polar (H/V)	Height (Meter)	Table (Degree)	Reading Level (dBm)	Correct Factor (dB)	Measurement (dBm)	FCC Part 22H Limits (dBm)	Result
Low Channel								
824.2	H	1.5	0	27.40	-1.38	26.02	38.45	PASS
824.2	V	1.5	0	27.59	-1.38	26.21	38.45	PASS
Middle Channel								
836.6	H	1.5	0	27.22	-1.10	26.12	38.45	PASS
836.6	V	1.5	0	27.55	-1.10	26.45	38.45	PASS
High Channel								
848.8	H	1.5	0	27.32	-0.82	26.50	38.45	PASS
848.8	V	1.5	0	27.15	-0.82	26.33	38.45	PASS

EIRP For GSM Mode PCS1900

Frequency (MHz)	Polar (H/V)	Height (Meter)	Table (Degree)	Reading Level (dBm)	Correct Factor (dB)	Measurement (dBm)	FCC Part 24E Limits (dBm)	Result
Low Channel								
1850.2	H	1.5	0	50.90	-22.26	28.64	33.00	PASS
1850.2	V	1.5	0	50.00	-22.26	27.74	33.00	PASS
Middle Channel								
1880	H	1.5	0	50.66	-22.16	28.50	33.00	PASS
1880	V	1.5	0	49.17	-22.16	27.01	33.00	PASS
High Channel								
1909.8	H	1.5	0	49.57	-22.05	27.52	33.00	PASS
1909.8	V	1.5	0	49.44	-22.05	27.39	33.00	PASS

ERP For GPRS Mode GSM850

Frequency (MHz)	Polar (H/V)	Height (Meter)	Table (Degree)	Reading Level (dBm)	Correct Factor (dB)	Measurement (dBm)	FCC Part 22H Limits (dBm)	Result
Low Channel								
824.2	H	1.5	0	28.73	-1.38	27.35	38.45	PASS
824.2	V	1.5	0	27.89	-1.38	26.51	38.45	PASS
Middle Channel								
836.6	H	1.5	0	28.38	-1.10	27.28	38.45	PASS
836.6	V	1.5	0	27.52	1.10	28.62	38.45	PASS
High Channel								
848.8	H	1.5	0	28.66	-0.82	27.84	38.45	PASS
848.8	V	1.5	0	27.61	-0.82	26.79	38.45	PASS

EIRP For GPRS Mode PCS1900

Frequency (MHz)	Polar (H/V)	Height (Meter)	Table (Degree)	Reading Level (dBm)	Correct Factor (dB)	Measurement (dBm)	FCC Part 24E Limits (dBm)	Result
Low Channel								
1850.2	H	1.5	0	50.25	-22.26	27.99	33.00	PASS
1850.2	V	1.5	0	49.13	-22.26	26.87	33.00	PASS
Middle Channel								
1880	H	1.5	0	49.98	-22.16	27.82	33.00	PASS
1880	V	1.5	0	49.94	-22.16	27.78	33.00	PASS
High Channel								
1909.8	H	1.5	0	50.99	-22.05	28.94	33.00	PASS
1909.8	V	1.5	0	49.16	-22.05	27.11	33.00	PASS

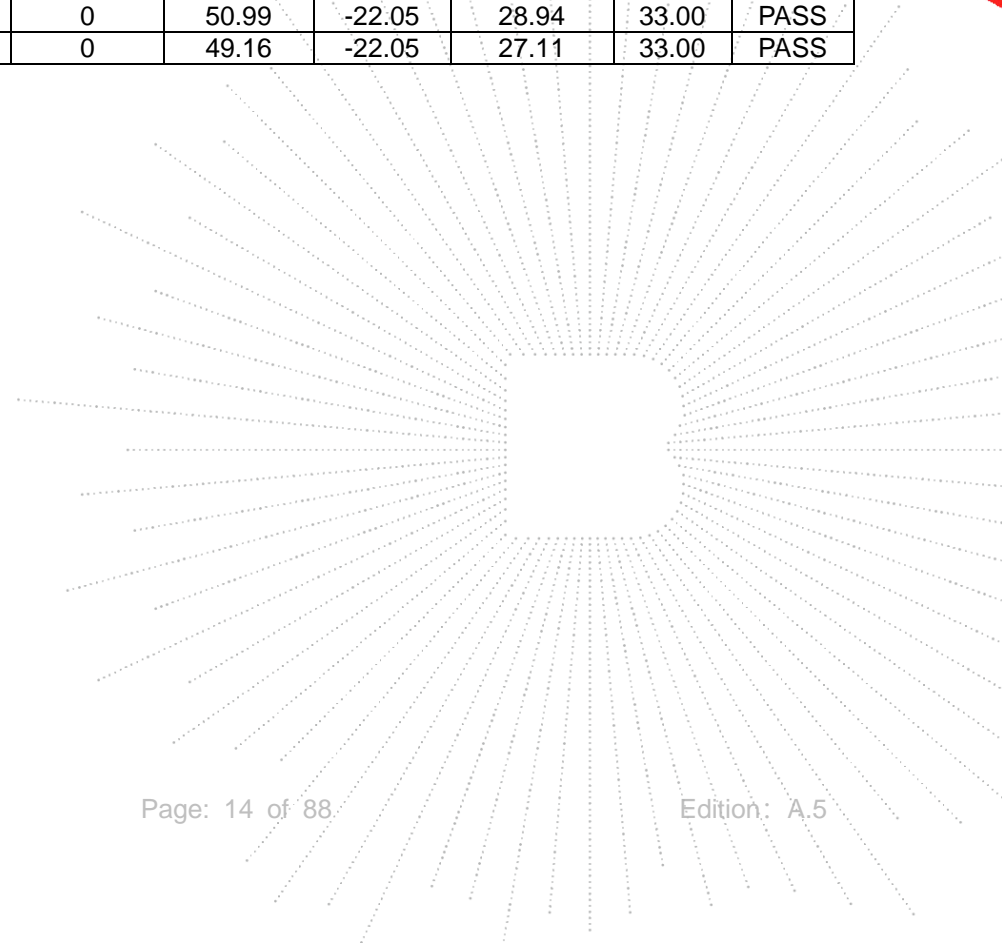

ERP For EGPRS Mode GSM850

Frequency (MHz)	Polar (H/V)	Height (Meter)	Table (Degree)	Reading Level (dBm)	Correct Factor (dB)	Measurement (dBm)	FCC Part 22H Limits (dBm)	Result
Low Channel								
824.2	H	1.5	0	28.36	-1.38	26.98	38.45	PASS
824.2	V	1.5	0	27.93	-1.38	26.55	38.45	PASS
Middle Channel								
836.6	H	1.5	0	27.80	-1.10	26.70	38.45	PASS
836.6	V	1.5	0	27.96	-1.10	26.86	38.45	PASS
High Channel								
848.8	H	1.5	0	28.49	-0.82	27.67	38.45	PASS
848.8	V	1.5	0	27.23	-0.82	26.41	38.45	PASS

EIRP For EGPRS Mode PCS1900

Frequency (MHz)	Polar (H/V)	Height (Meter)	Table (Degree)	Reading Level (dBm)	Correct Factor (dB)	Measurement (dBm)	FCC Part 24E Limits (dBm)	Result
Low Channel								
1850.2	H	1.5	0	49.37	-22.26	27.11	33.00	PASS
1850.2	V	1.5	0	49.41	-22.26	27.15	33.00	PASS
Middle Channel								
1880	H	1.5	0	49.36	-22.16	27.20	33.00	PASS
1880	V	1.5	0	49.28	-22.16	27.12	33.00	PASS
High Channel								
1909.8	H	1.5	0	50.99	-22.05	28.94	33.00	PASS
1909.8	V	1.5	0	49.45	-22.05	27.40	33.00	PASS

BCTC
 3C
 PPR
 检测

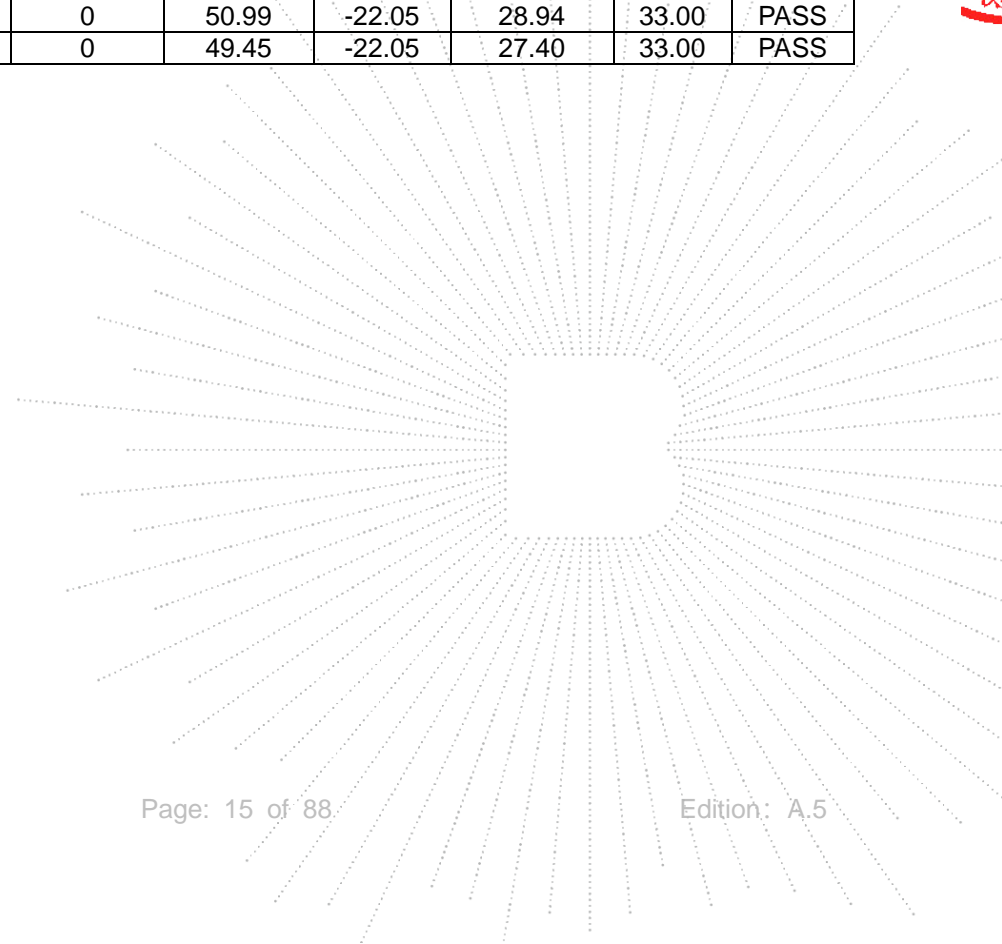

EIRP For WCDMA Mode Band II

Frequency (MHz)	Polar (H/V)	Height (Meter)	Table (Degree)	Reading Level (dBm)	Correct Factor (dB)	Measurement (dBm)	FCC Part 24E Limits (dBm)	Result
Low Channel								
1852.4	H	1.5	0	41.65	-22.25	19.40	33.00	PASS
1852.4	V	1.5	0	40.92	-22.25	18.67	33.00	PASS
Middle Channel								
1880	H	1.5	0	41.33	-22.16	19.17	33.00	PASS
1880	V	1.5	0	40.16	-22.16	18.00	33.00	PASS
High Channel								
1907.6	H	1.5	0	41.50	-22.06	19.44	33.00	PASS
1907.6	V	1.5	0	40.99	-22.06	18.93	33.00	PASS

EIRP For HSDPA Mode Band II

Frequency (MHz)	Polar (H/V)	Height (Meter)	Table (Degree)	Reading Level (dBm)	Correct Factor (dB)	Measurement (dBm)	FCC Part 24E Limits (dBm)	Result
Low Channel								
1852.4	H	1.5	0	40.70	-22.25	18.45	33.00	PASS
1852.4	V	1.5	0	40.62	-22.25	18.37	33.00	PASS
Middle Channel								
1880	H	1.5	0	41.44	-22.16	19.28	33.00	PASS
1880	V	1.5	0	41.03	-22.16	18.87	33.00	PASS
High Channel								
1907.6	H	1.5	0	40.70	-22.06	18.64	33.00	PASS
1907.6	V	1.5	0	41.02	-22.06	18.96	33.00	PASS

EIRP For HSUPA Mode Band II

Frequency (MHz)	Polar (H/V)	Height (Meter)	Table (Degree)	Reading Level (dBm)	Correct Factor (dB)	Measurement (dBm)	FCC Part 24E Limits (dBm)	Result
Low Channel								
1852.4	H	1.5	0	41.34	-22.25	19.09	33.00	PASS
1852.4	V	1.5	0	40.71	-22.25	18.46	33.00	PASS
Middle Channel								
1880	H	1.5	0	41.10	-22.16	18.94	33.00	PASS
1880	V	1.5	0	40.19	-22.16	18.03	33.00	PASS
High Channel								
1907.6	H	1.5	0	40.30	-22.06	18.24	33.00	PASS
1907.6	V	1.5	0	40.73	-22.06	18.67	33.00	PASS

 TE
 TC
 OVE
 檢

EIRP For WCDMA Mode Band IV

Frequency (MHz)	Polar (H/V)	Height (Meter)	Table (Degree)	Reading Level (dBm)	Correct Factor (dB)	Measurement (dBm)	FCC Part 27L Limits (dBm)	Result
Low Channel								
1712.4	H	1.5	0	40.69	-22.71	17.98	33.00	PASS
1712.4	V	1.5	0	40.63	-22.71	17.92	33.00	PASS
Middle Channel								
1740	H	1.5	0	40.25	-22.67	17.58	33.00	PASS
1740	V	1.5	0	40.89	-22.67	18.22	33.00	PASS
High Channel								
1752.6	H	1.5	0	40.27	-22.60	17.67	33.00	PASS
1752.6	V	1.5	0	39.97	-22.60	17.37	33.00	PASS

EIRP For HSDPA Mode Band IV

Frequency (MHz)	Polar (H/V)	Height (Meter)	Table (Degree)	Reading Level (dBm)	Correct Factor (dB)	Measurement (dBm)	FCC Part 27L Limits (dBm)	Result
Low Channel								
1712.4	H	1.5	0	41.14	-22.71	18.43	33.00	PASS
1712.4	V	1.5	0	40.04	-22.71	17.33	33.00	PASS
Middle Channel								
1740	H	1.5	0	40.23	-22.67	17.56	33.00	PASS
1740	V	1.5	0	40.68	-22.67	18.01	33.00	PASS
High Channel								
1752.6	H	1.5	0	41.16	-22.60	18.56	33.00	PASS
1752.6	V	1.5	0	40.32	-22.60	17.72	33.00	PASS

EIRP For HSUPA Mode Band IV

Frequency (MHz)	Polar (H/V)	Height (Meter)	Table (Degree)	Reading Level (dBm)	Correct Factor (dB)	Measurement (dBm)	FCC Part 27L Limits (dBm)	Result
Low Channel								
1712.4	H	1.5	0	41.56	-22.71	18.85	33.00	PASS
1712.4	V	1.5	0	40.29	-22.71	17.58	33.00	PASS
Middle Channel								
1740	H	1.5	0	40.78	-22.67	18.11	33.00	PASS
1740	V	1.5	0	40.28	-22.67	17.61	33.00	PASS
High Channel								
1752.6	H	1.5	0	40.77	-22.60	18.17	33.00	PASS
1752.6	V	1.5	0	40.68	-22.60	18.08	33.00	PASS



ERP For WCDMA Mode Band V

Frequency (MHz)	Polar (H/V)	Height (Meter)	Table (Degree)	Reading Level (dBm)	Correct Factor (dB)	Measurement (dBm)	FCC Part 22H Limits (dBm)	Result
Low Channel								
826.4	H	1.5	0	17.73	-1.33	16.40	30	PASS
826.4	V	1.5	0	18.60	-1.33	17.27	30	PASS
Middle Channel								
836.4	H	1.5	0	17.99	-1.10	16.89	30	PASS
836.4	V	1.5	0	18.48	-1.10	17.38	30	PASS
High Channel								
846.6	H	1.5	0	18.75	-0.87	17.88	30	PASS
846.6	V	1.5	0	18.65	-0.87	17.78	30	PASS

ERP For HSDPA Mode Band V

Frequency (MHz)	Polar (H/V)	Height (Meter)	Table (Degree)	Reading Level (dBm)	Correct Factor (dB)	Measurement (dBm)	FCC Part 22H Limits (dBm)	Result
Low Channel								
826.4	H	1.5	0	18.11	-1.33	16.78	30	PASS
826.4	V	1.5	0	17.88	-1.33	16.55	30	PASS
Middle Channel								
836.4	H	1.5	0	19.50	-1.10	18.40	30	PASS
836.4	V	1.5	0	17.87	-1.10	16.77	30	PASS
High Channel								
846.6	H	1.5	0	19.35	-0.87	18.48	30	PASS
846.6	V	1.5	0	18.15	-0.87	17.28	30	PASS

ERP For HSUPA Mode Band V

Frequency (MHz)	Polar (H/V)	Height (Meter)	Table (Degree)	Reading Level (dBm)	Correct Factor (dB)	Measurement (dBm)	FCC Part 22H Limits (dBm)	Result
Low Channel								
826.4	H	1.5	0	19.22	-1.33	17.89	30	PASS
826.4	V	1.5	0	17.51	-1.33	16.18	30	PASS
Middle Channel								
836.4	H	1.5	0	19.03	-1.10	17.93	30	PASS
836.4	V	1.5	0	17.84	-1.10	16.74	30	PASS
High Channel								
846.6	H	1.5	0	18.84	-0.87	17.97	30	PASS
846.6	V	1.5	0	17.66	-0.87	16.79	30	PASS

Correction Factor= S.G. Power - Cable loss + Antenna Gain- SPA. Reading

Max. Conducted Output Power

For Cellular Band (GSM850)

Band	GSM850			Limit (dBm)
Channel	128	190	251	
Frequency(MHz)	824.2	836.6	848.8	
GSM	31.42	31.43	31.36	33.0
GPRS Slot -1	31.45	31.42	31.36	33.0
GPRS Slot -2	30.94	30.86	30.84	33.0
GPRS Slot -3	29.59	29.42	29.42	33.0
GPRS Slot -4	28.66	28.49	28.50	33.0
EGPRS Slot -1	26.29	25.95	26.65	33.0
EGPRS Slot -2	25.21	24.96	25.39	33.0
EGPRS Slot -3	23.16	22.93	22.94	33.0
EGPRS Slot -4	21.74	21.52	21.68	33.0

For PCS Band (GSM1900)

Band	GSM1900			Limit (dBm)
Channel	512	661	810	
Frequency(MHz)	1850.2	1880	1909.8	
GSM	25.04	25.08	25.06	33.0
GPRS Slot -1	25.10	25.14	25.19	33.0
GPRS Slot -2	24.76	24.83	24.87	33.0
GPRS Slot -3	23.78	23.81	23.86	33.0
GPRS Slot -4	22.98	23.00	23.03	33.0
EGPRS Slot -1	24.66	24.68	24.09	33.0
EGPRS Slot -2	23.97	23.90	23.62	33.0
EGPRS Slot -3	22.61	21.84	21.43	33.0
EGPRS Slot -4	20.63	20.77	19.97	33.0

Band	WCDMA Band II		
Channel	9262	9400	9538
Frequency(MHz)	1852.4	1880.0	1907.6
WCDMA RMC 12.2K	18.49	18.69	18.97
HSDPA Subtest-1	17.52	17.76	18.02
HSDPA Subtest-2	17.19	17.25	17.76
HSDPA Subtest-3	15.92	16.30	16.51
HSDPA Subtest-4	16.04	16.19	16.52
HSUPA Subtest-1	15.93	17.46	17.78
HSUPA Subtest-2	17.35	17.70	17.83
HSUPA Subtest-3	15.56	16.45	16.55
HSUPA Subtest-4	17.50	17.72	18.00
HSUPA Subtest-5	15.82	17.05	16.95

Band	WCDMA Band IV		
Channel	1312	1450	1513
Frequency(MHz)	1712.4	1740	1752.6
WCDMA RMC 12.2K	19.42	19.10	18.69
HSDPA Subtest-1	18.48	18.16	17.78
HSDPA Subtest-2	17.99	17.68	17.17
HSDPA Subtest-3	16.85	16.72	16.23
HSDPA Subtest-4	17.10	16.73	16.29
HSUPA Subtest-1	16.88	17.96	17.59
HSUPA Subtest-2	18.30	17.99	17.65
HSUPA Subtest-3	17.02	16.74	16.54
HSUPA Subtest-4	18.47	18.12	17.72
HSUPA Subtest-5	17.15	17.58	17.01

Band	WCDMA Band V		
Channel	4132	4182	4233
Frequency(MHz)	826.4	836.4	846.6
WCDMA RMC 12.2K	21.85	21.85	21.69
HSDPA Subtest-1	20.86	20.85	20.68
HSDPA Subtest-2	20.49	20.16	20.38
HSDPA Subtest-3	19.39	19.25	18.85
HSDPA Subtest-4	19.42	19.58	19.26
HSUPA Subtest-1	18.74	20.71	20.53
HSUPA Subtest-2	20.71	20.79	20.61
HSUPA Subtest-3	19.13	19.56	19.30
HSUPA Subtest-4	20.84	20.86	20.71
HSUPA Subtest-5	19.45	20.16	19.97

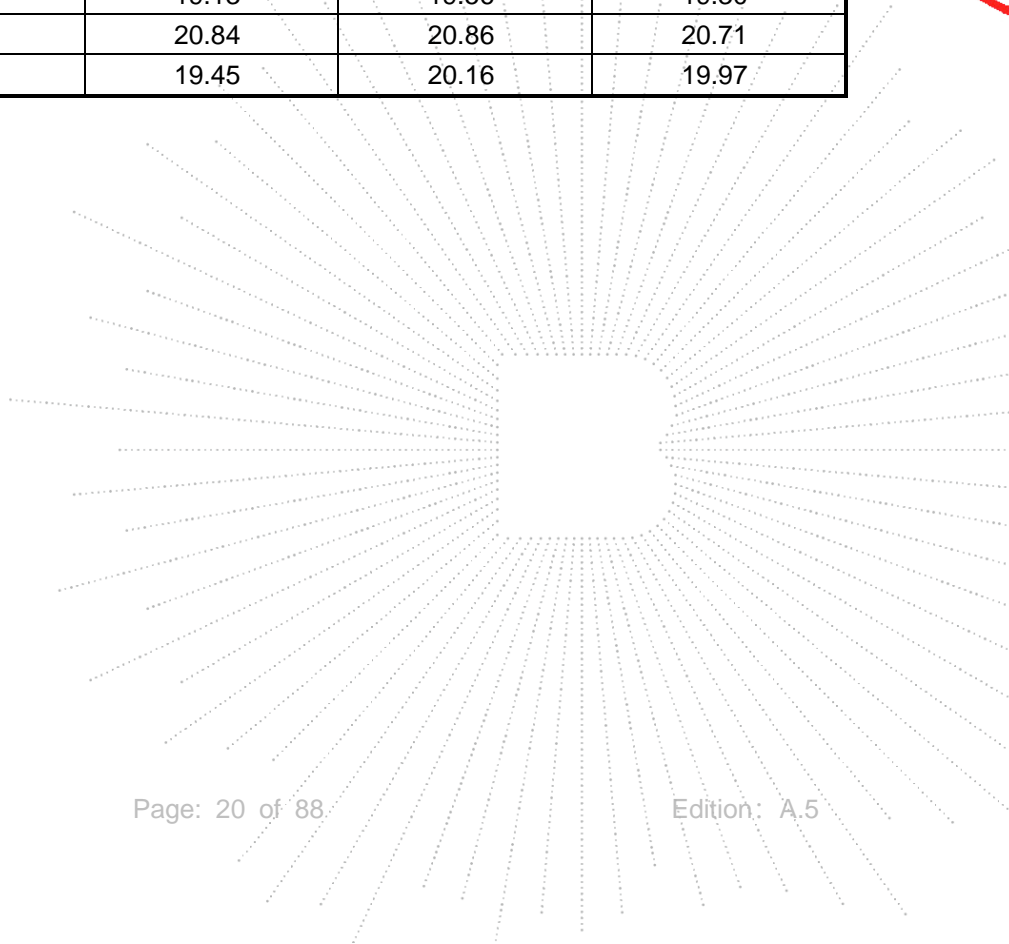

7. Peak-to-average Ratio(PAR) of Transmitter

7.1 Block Diagram Of Test Setup

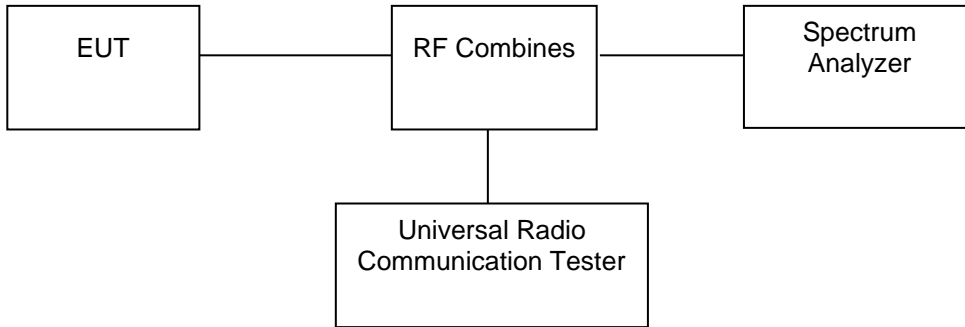

7.2 Limit

According to §24.232(d), Power measurements for transmissions by stations authorized under this section may be made either in accordance with a Commission-approved average power technique or in compliance with paragraph (e) of this section. In both instances, equipment employed must be authorized in accordance with the provisions of §24.51. In measuring transmissions in this band using an average power technique, the peak-to-average ratio (PAR) of the transmission may not exceed 13 dB.

According to §27.50(B), the peak-to-average power ratio (PAPR) of the transmitter output power must not exceed 13 dB. The PAPR measurements should be made using either an instrument with complementary cumulative distribution function (CCDF) capabilities to determine that PAPR will not exceed 13 dB for more than 0.1 percent of the time or other Commission approved procedure. The measurement must be performed using a signal corresponding to the highest PAPR expected during periods of continuous transmission.

7.3 Test procedure

The RF output terminal of the transmitter was connected to the input of the spectrum analyzer via a suitable attenuation. The RBW of the spectrum analyzer was set to 30kHz and the peak-to-average ratio (PAR) of the transmission was recorded. Record the maximum PAPR level associated with a probability of 0.1%.

7.4 Test Result

Band	Channel	Frequency (MHz)	Result (dB)	high Limit (dB)	Verdict
GSM850	128	824.2	2.67	13.00	PASS
GSM850	190	836.6	2.62	13.00	PASS
GSM850	251	848.8	2.64	13.00	PASS
GPRS850	128	824.2	2.71	13.00	PASS
GPRS850	190	836.6	2.66	13.00	PASS
GPRS850	251	848.8	2.67	13.00	PASS
EGPRS850	128	824.2	8.47	13.00	PASS
EGPRS850	190	836.6	7.18	13.00	PASS
EGPRS850	251	848.8	7.84	13.00	PASS

GSM850 Channel=128

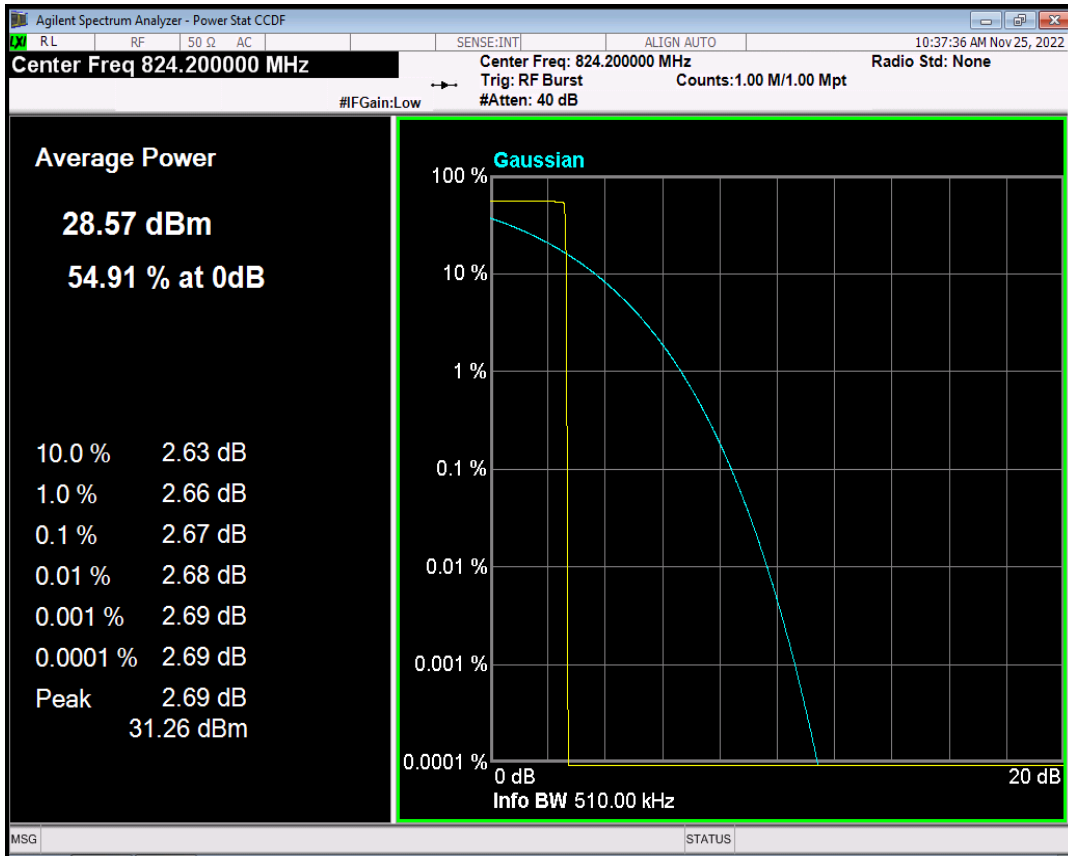

GSM850 Channel=190

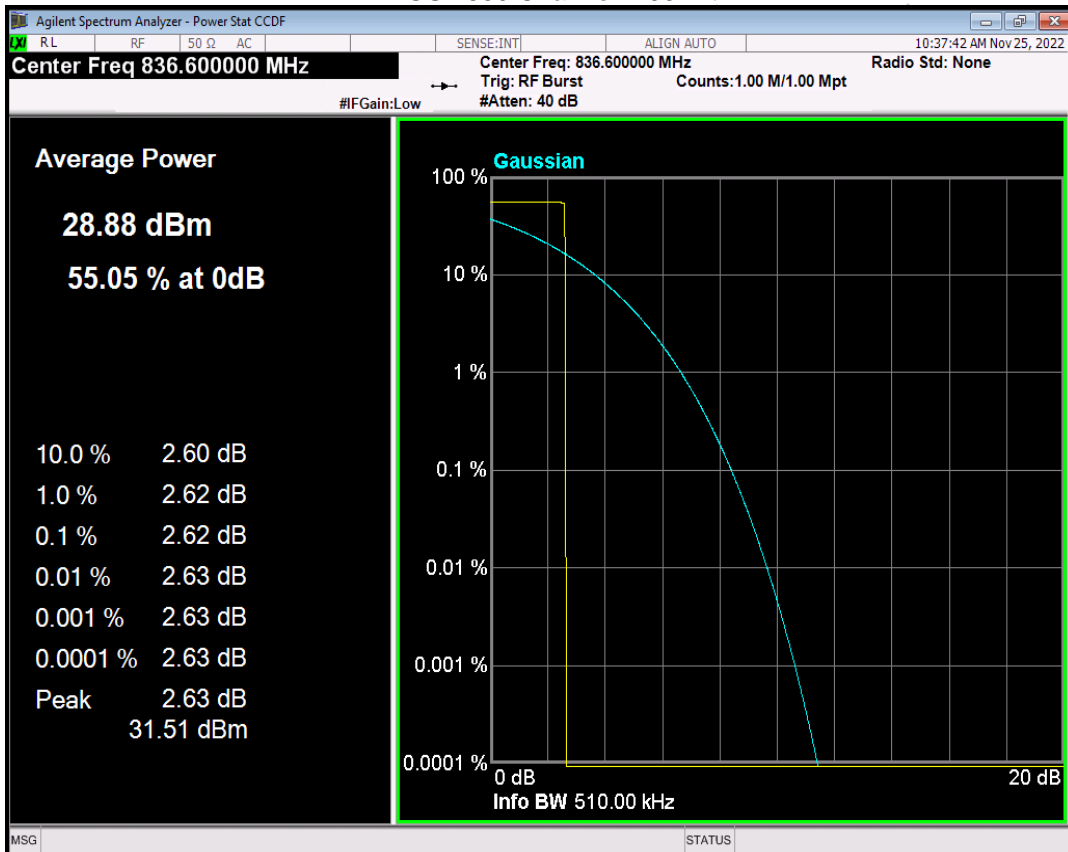

GSM850 Channel=251

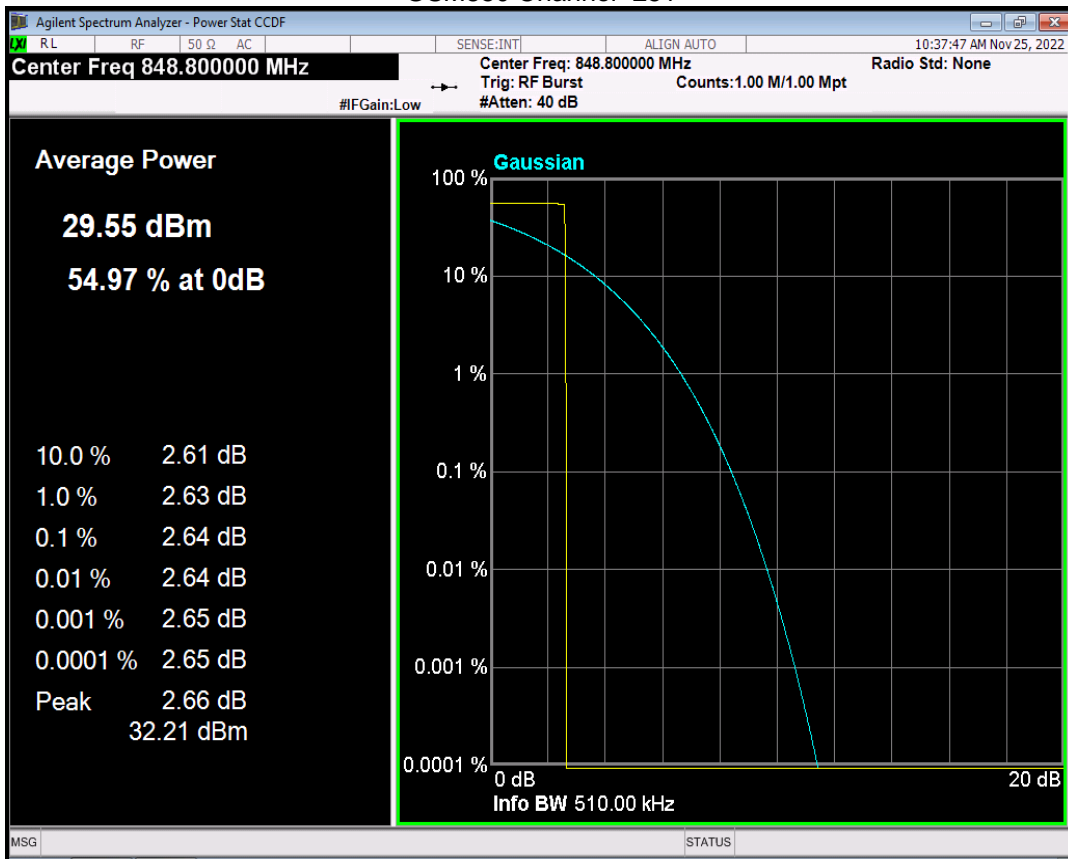

GPRS850 Channel=128

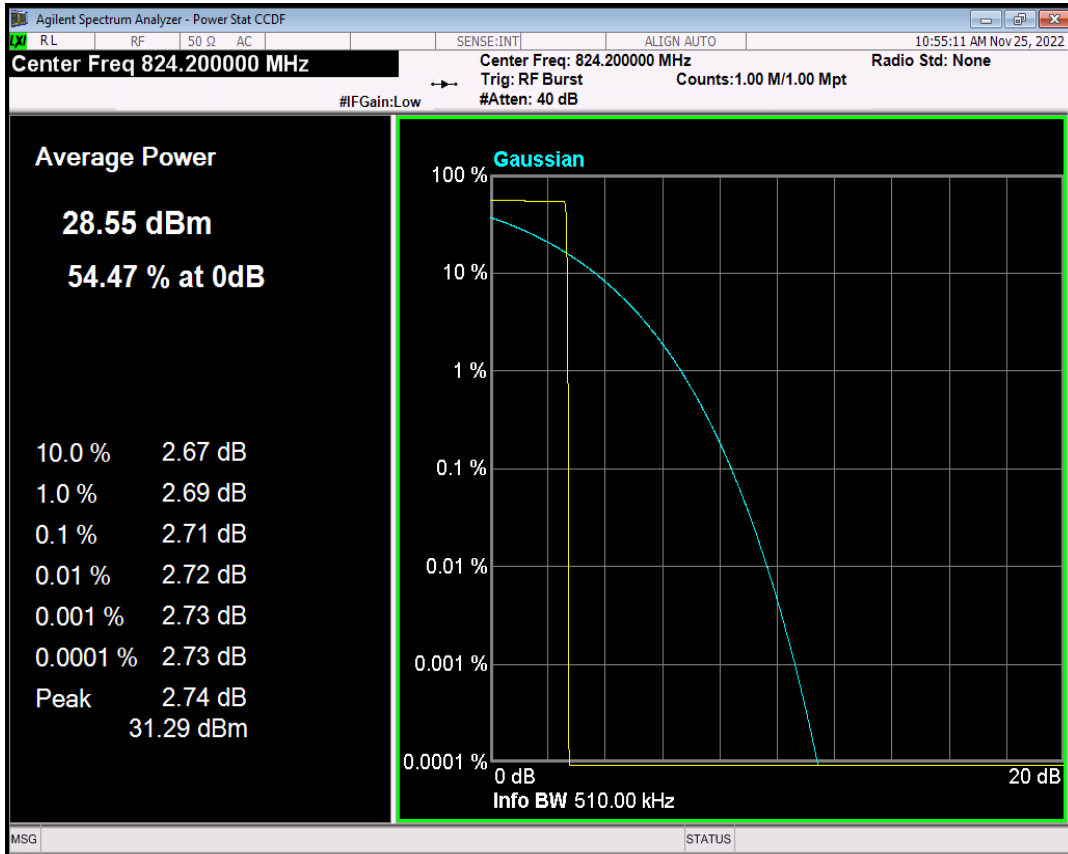

GPRS850 Channel=190

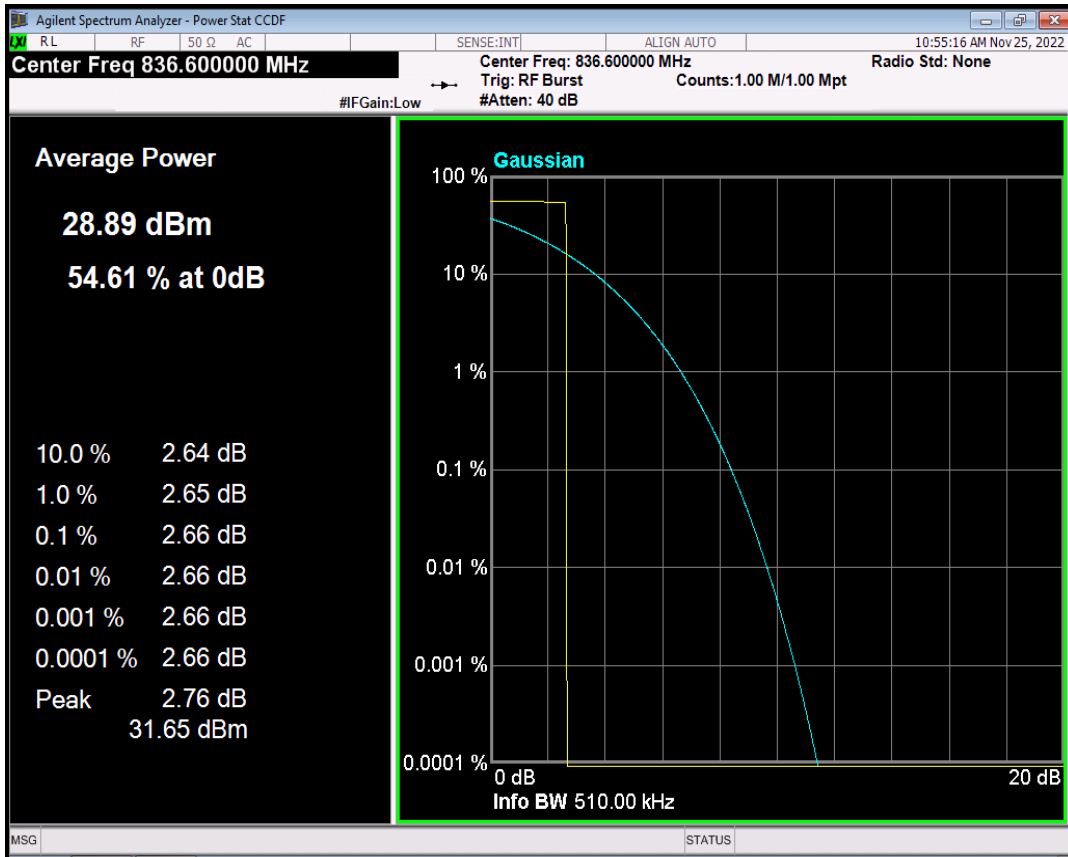

GPRS850 Channel=251

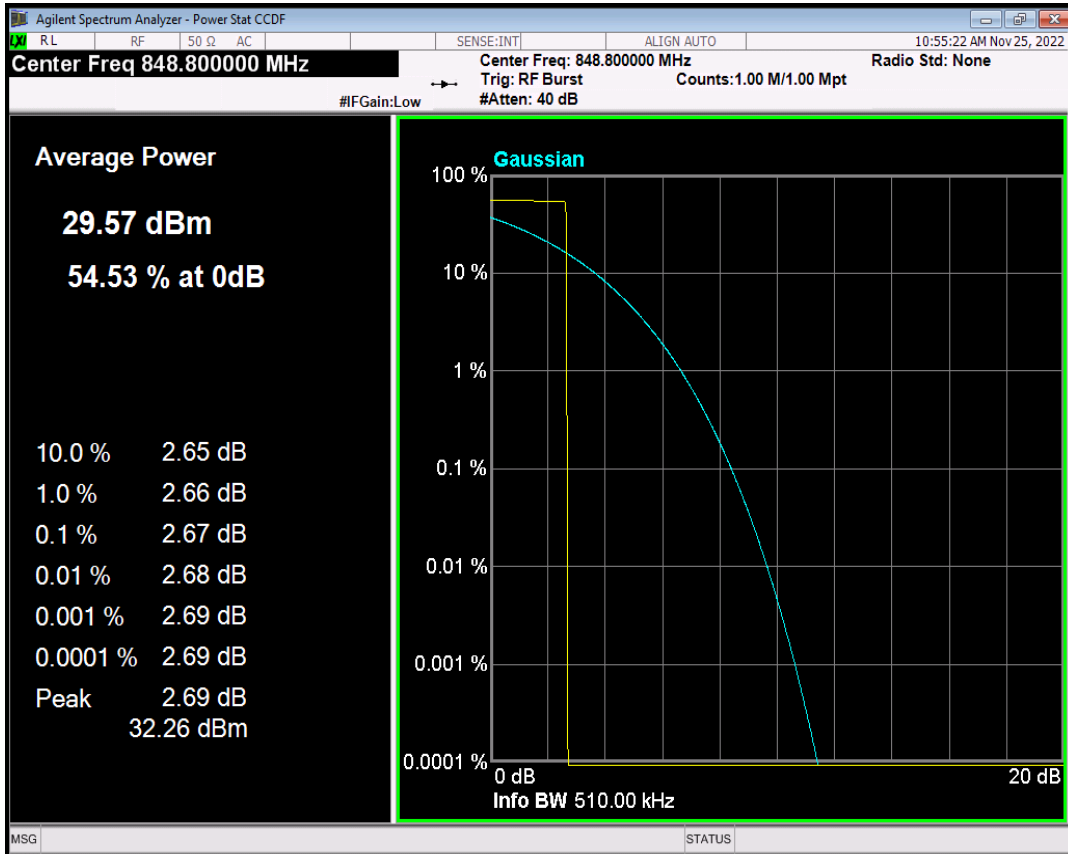

CO.LTD

EGPRS850 Channel=128

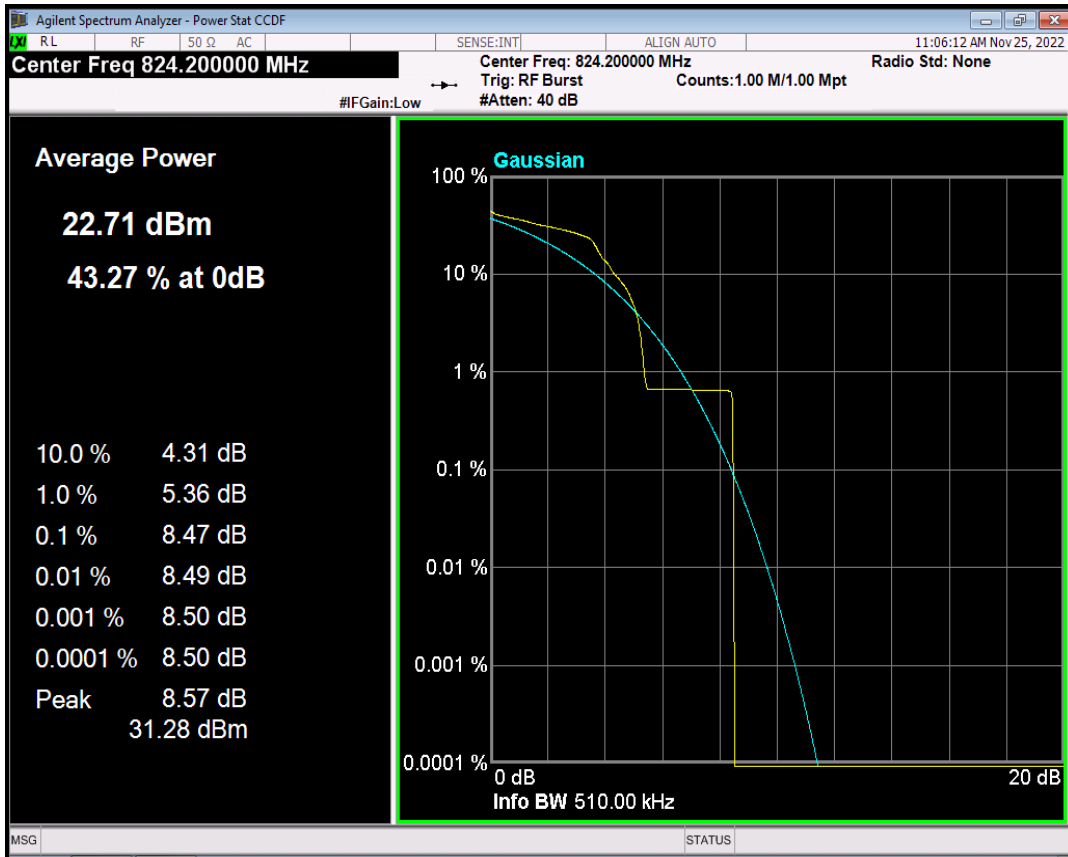

EGPRS850 Channel=190

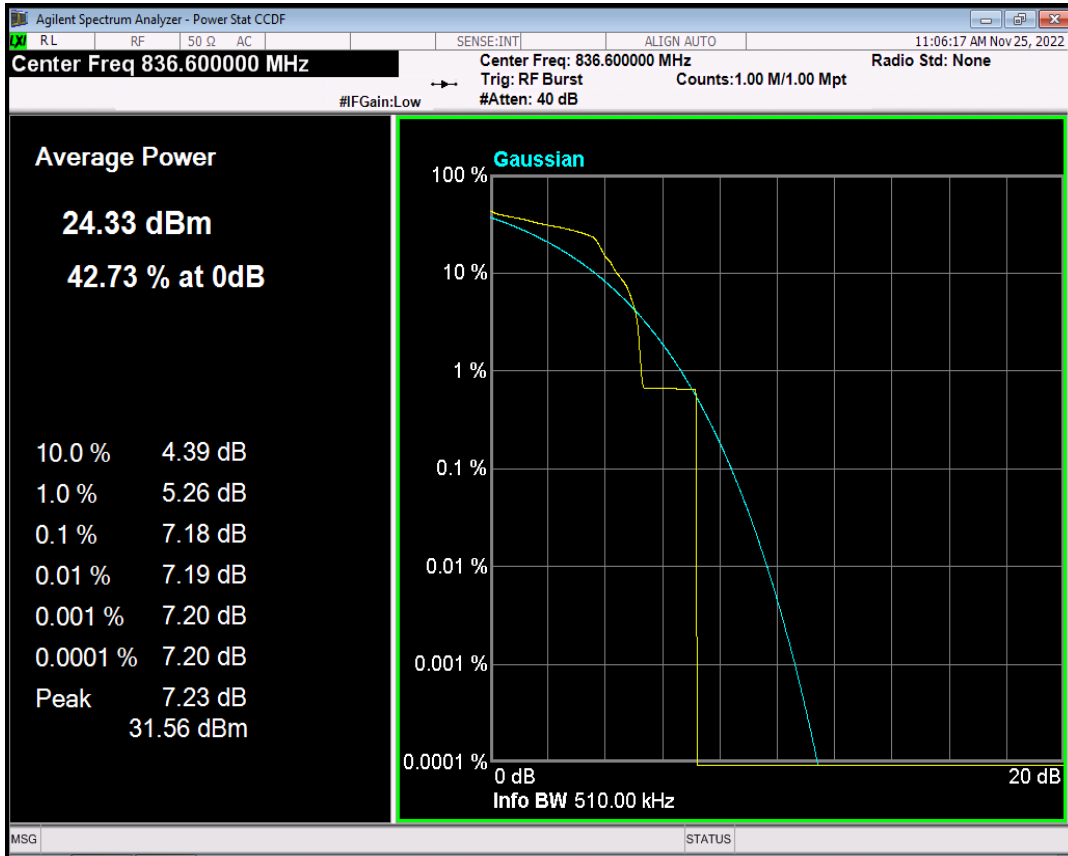

SHENZHEN

EGPRS850 Channel=251

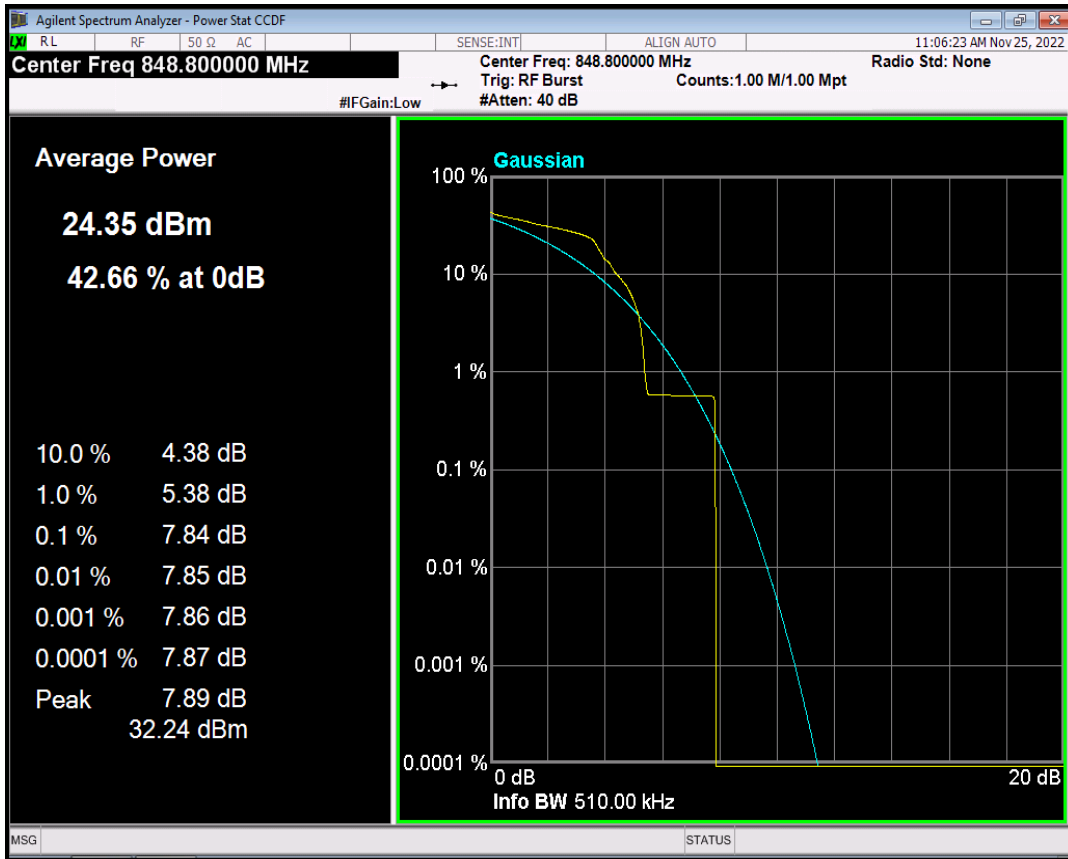

Band	Channel	Frequency (MHz)	Result (dB)	high Limit (dB)	Verdict
GSM1900	512	1850.2	2.64	13.00	PASS
GSM1900	661	1880	2.63	13.00	PASS
GSM1900	810	1909.8	2.64	13.00	PASS
GPRS1900	512	1850.2	2.68	13.00	PASS
GPRS1900	661	1880	2.66	13.00	PASS
GPRS1900	810	1909.8	2.67	13.00	PASS
EGPRS1900	512	1850.2	4.71	13.00	PASS
EGPRS1900	661	1880	4.69	13.00	PASS
EGPRS1900	810	1909.8	4.84	13.00	PASS

GSM1900 Channel=512

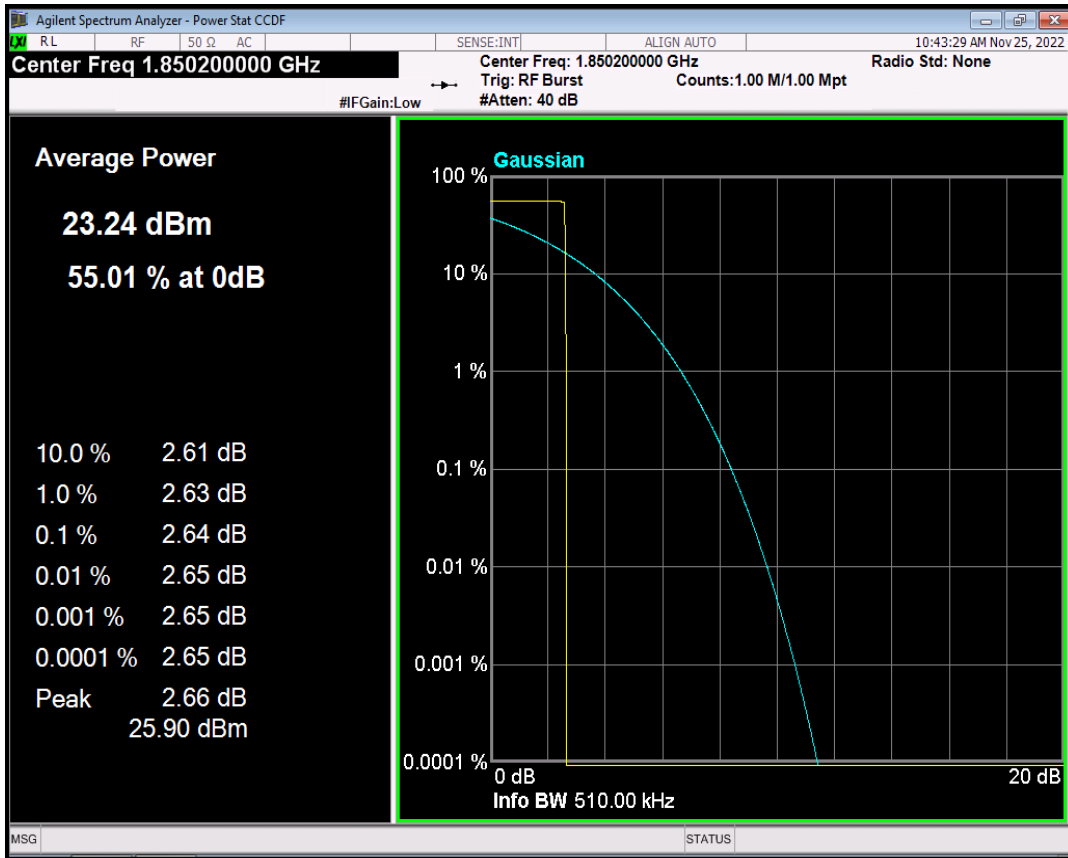

GSM1900 Channel=661

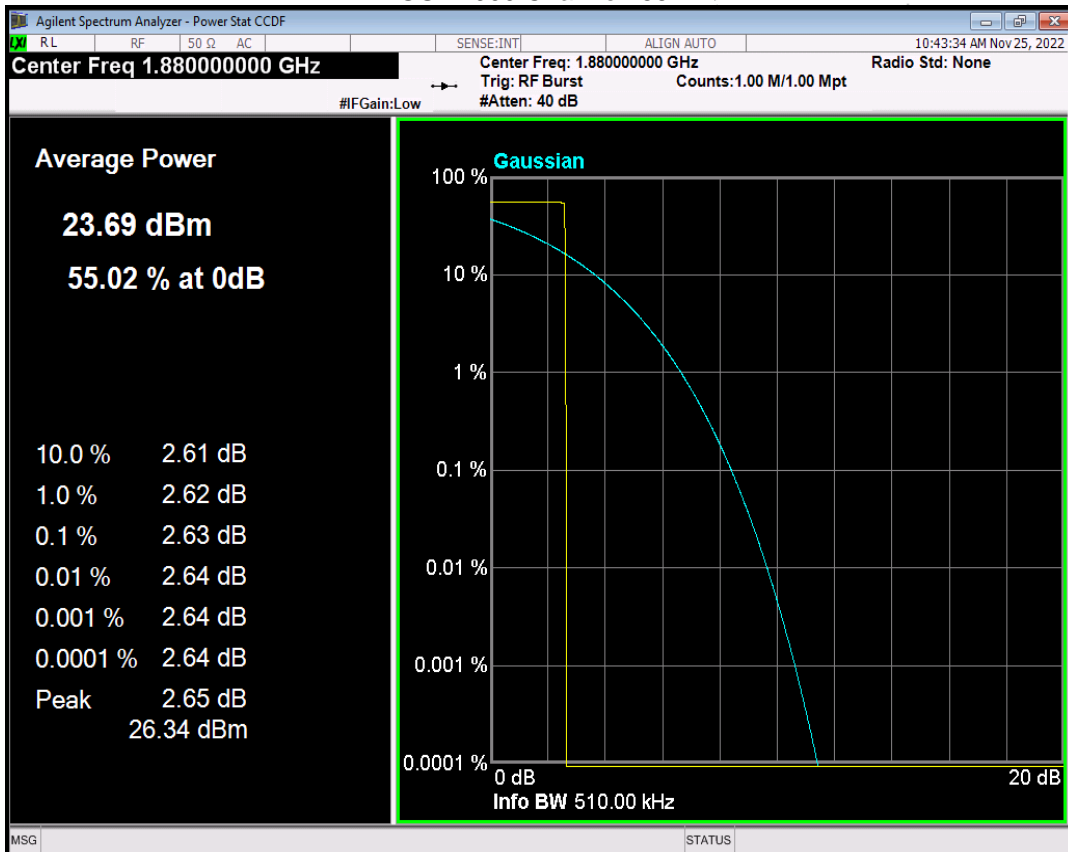

TC
 3C
 PPR
 检测

GSM1900 Channel=810

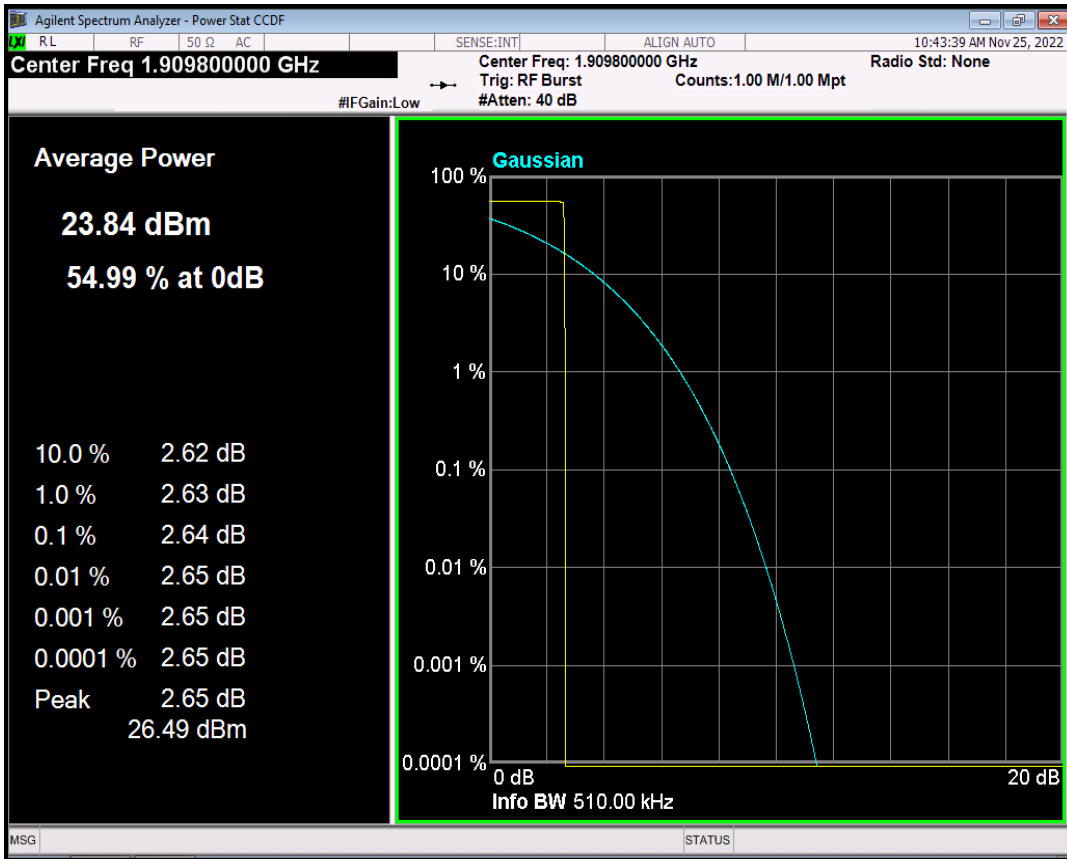

GPRS1900 Channel=512

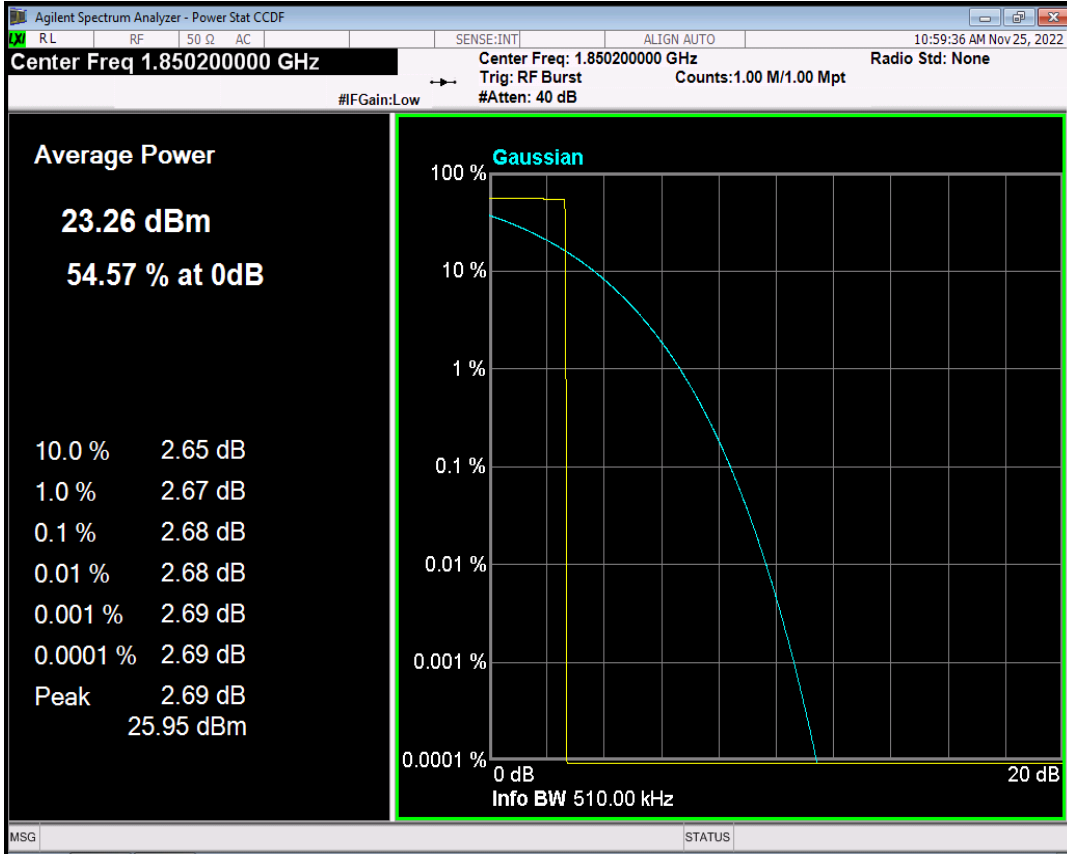

TEC
 TO
 OVE
 检

GPRS1900 Channel=661

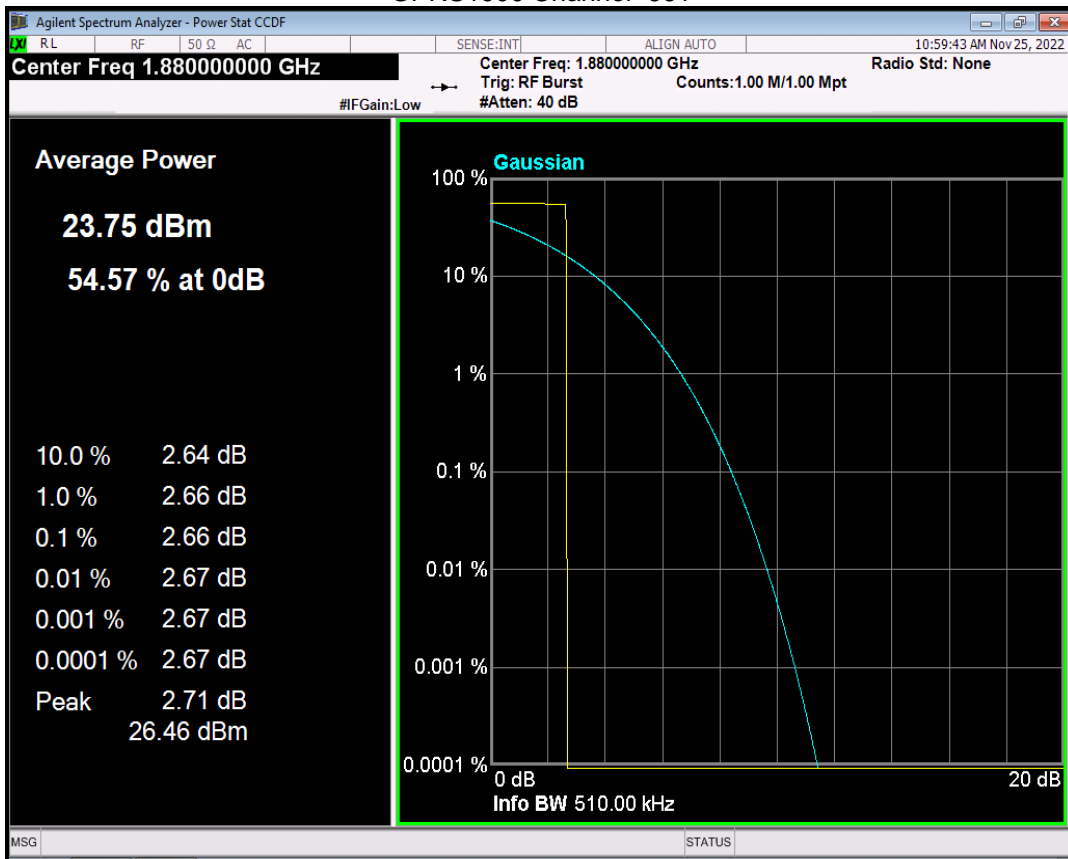

GPRS1900 Channel=810

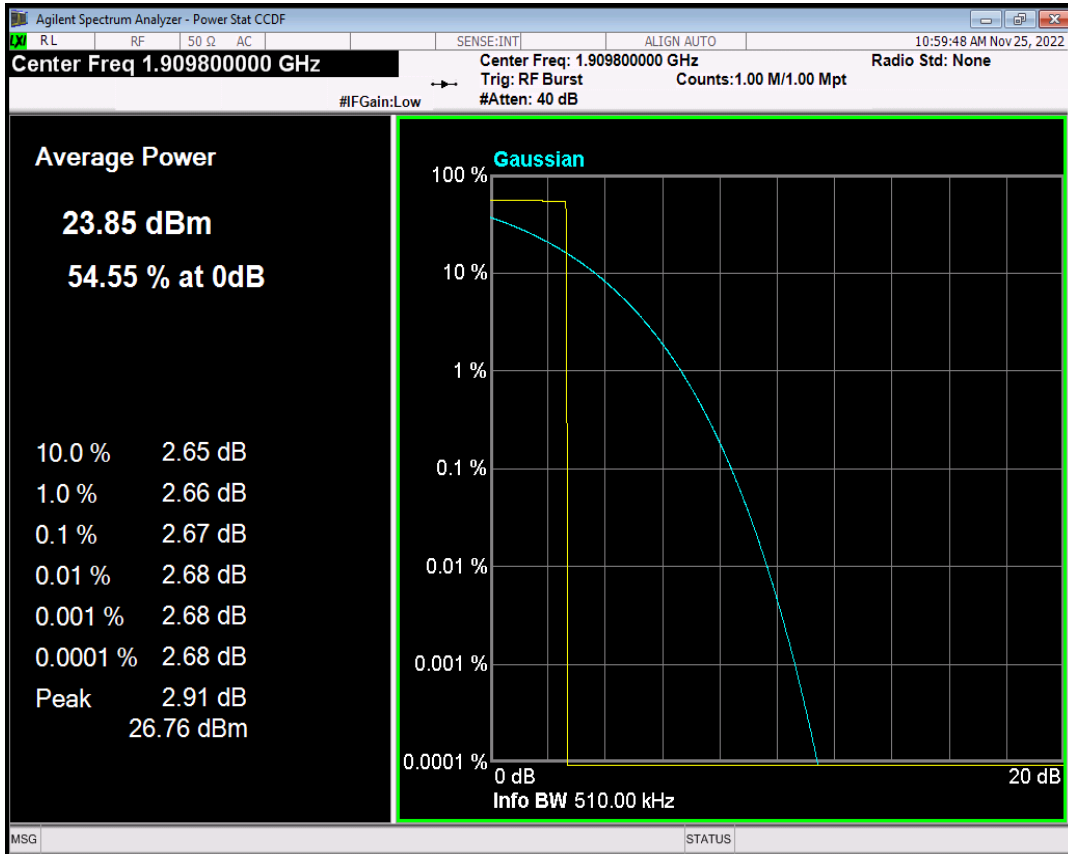

EGPRS1900 Channel=512

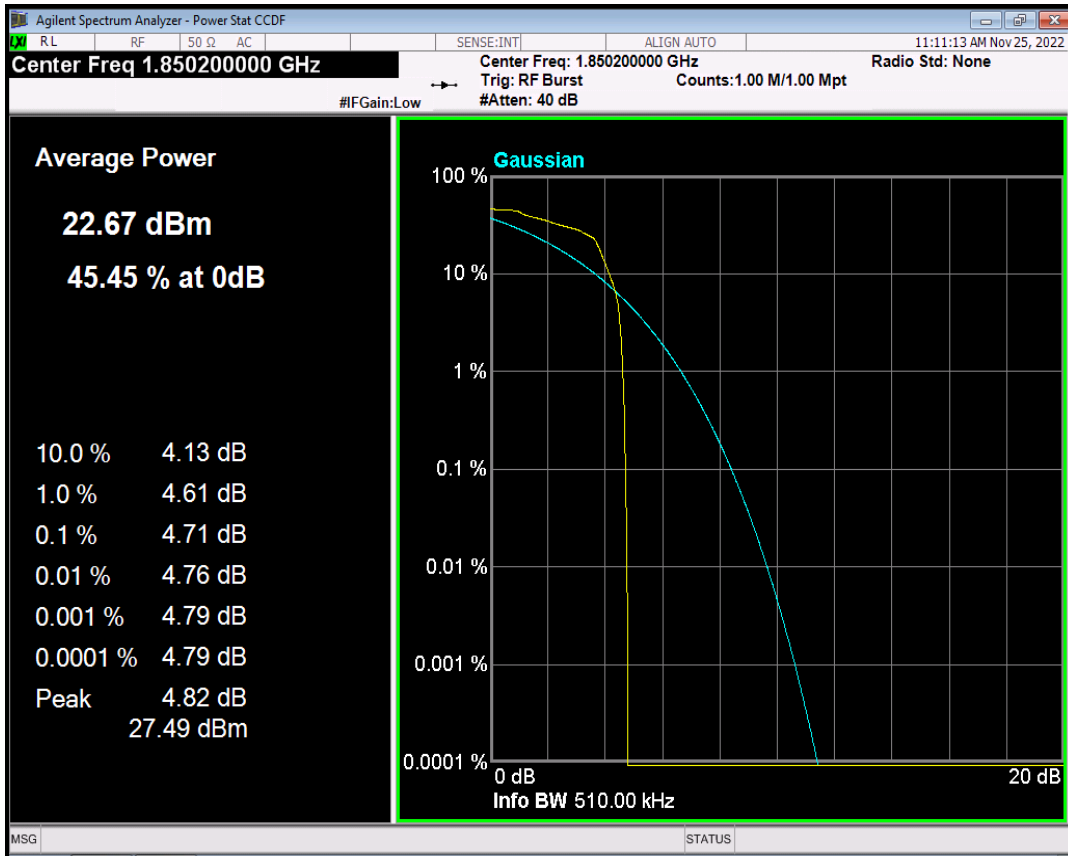

EGPRS1900 Channel=661

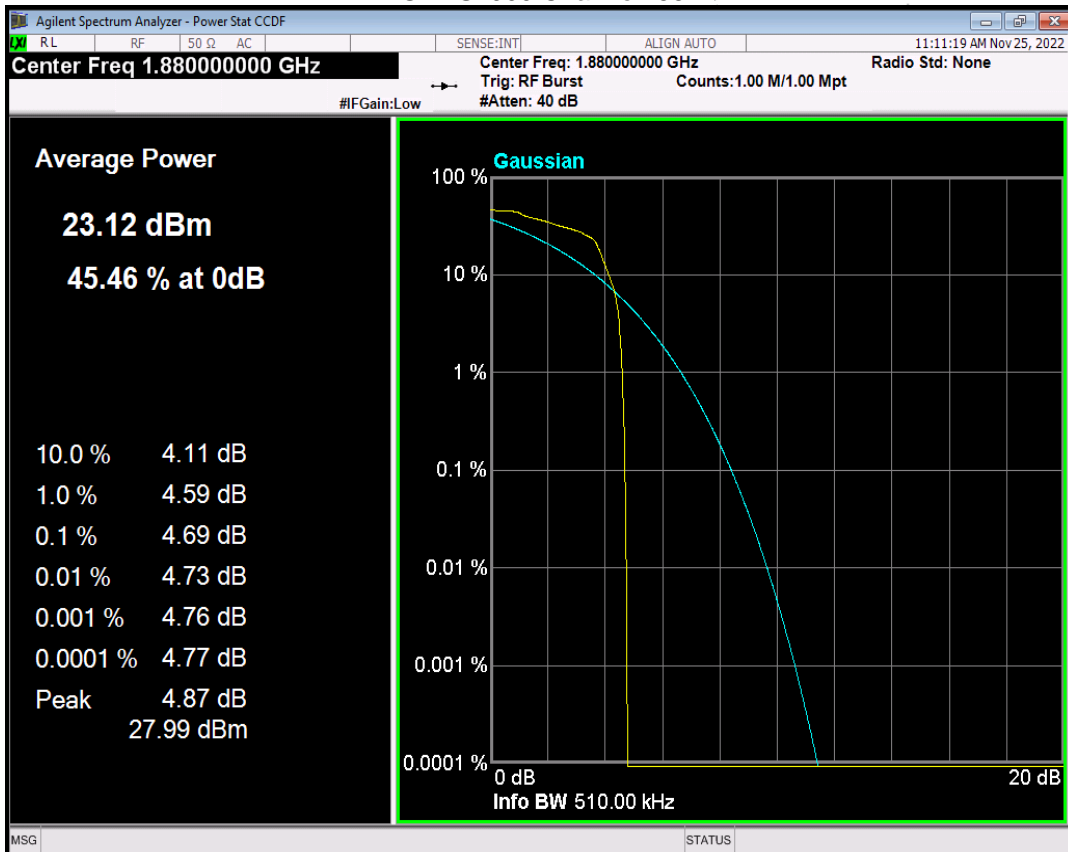

CO., LTD

EGPRS1900 Channel=810

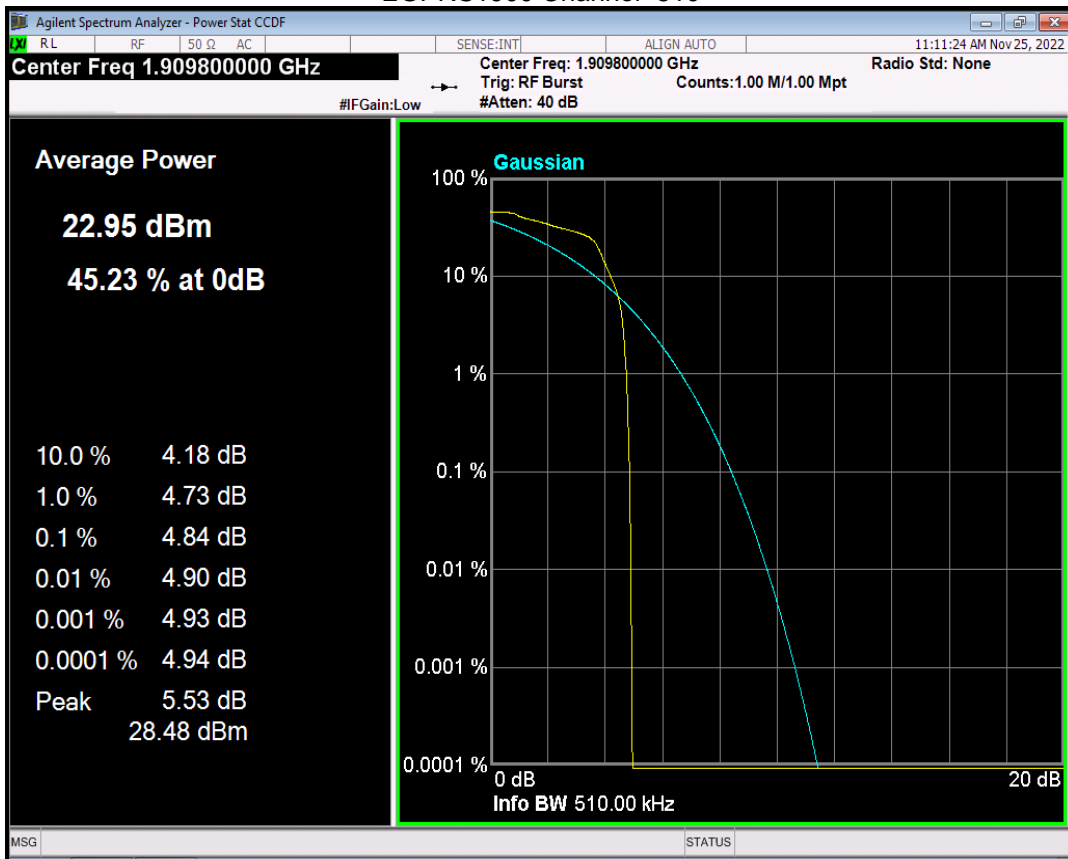

Band	Channel	Frequency (MHz)	Result (dB)	high Limit (dB)	Verdict
WCDMA Band2	9262	1852.4	2.90	13	PASS
WCDMA Band2	9400	1880	2.98	13	PASS
WCDMA Band2	9538	1907.6	2.98	13	PASS
WCDMA Band4	1312	1712.4	2.99	13	PASS
WCDMA Band4	1450	1740	2.74	13	PASS
WCDMA Band4	1513	1752.6	2.98	13	PASS
WCDMA Band5	4132	826.4	2.79	13	PASS
WCDMA Band5	4182	836.4	2.80	13	PASS
WCDMA Band5	4233	846.6	2.67	13	PASS

Note: In WCDMA, RMC, HSDPA and HSUPA all three tests only reflect the worst mode RMC.

SHENZHEN

WCDMA Band2 Channel=9262

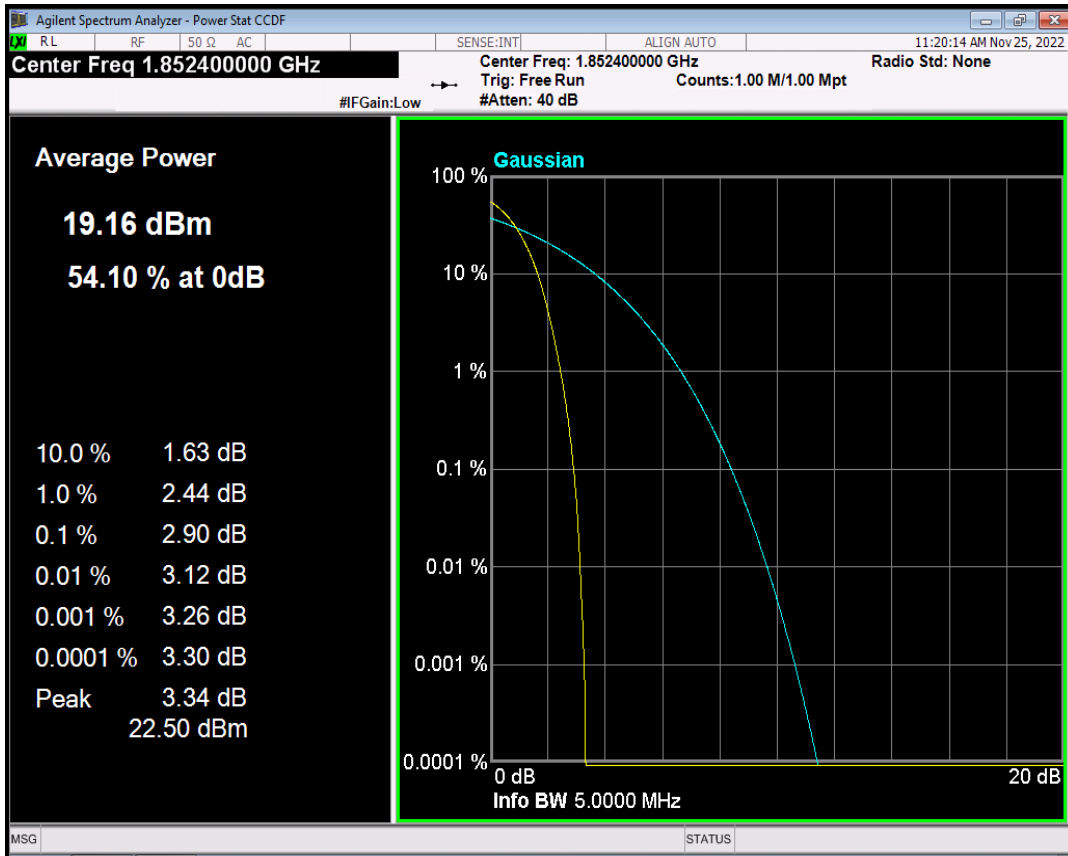

WCDMA Band2 Channel=9400

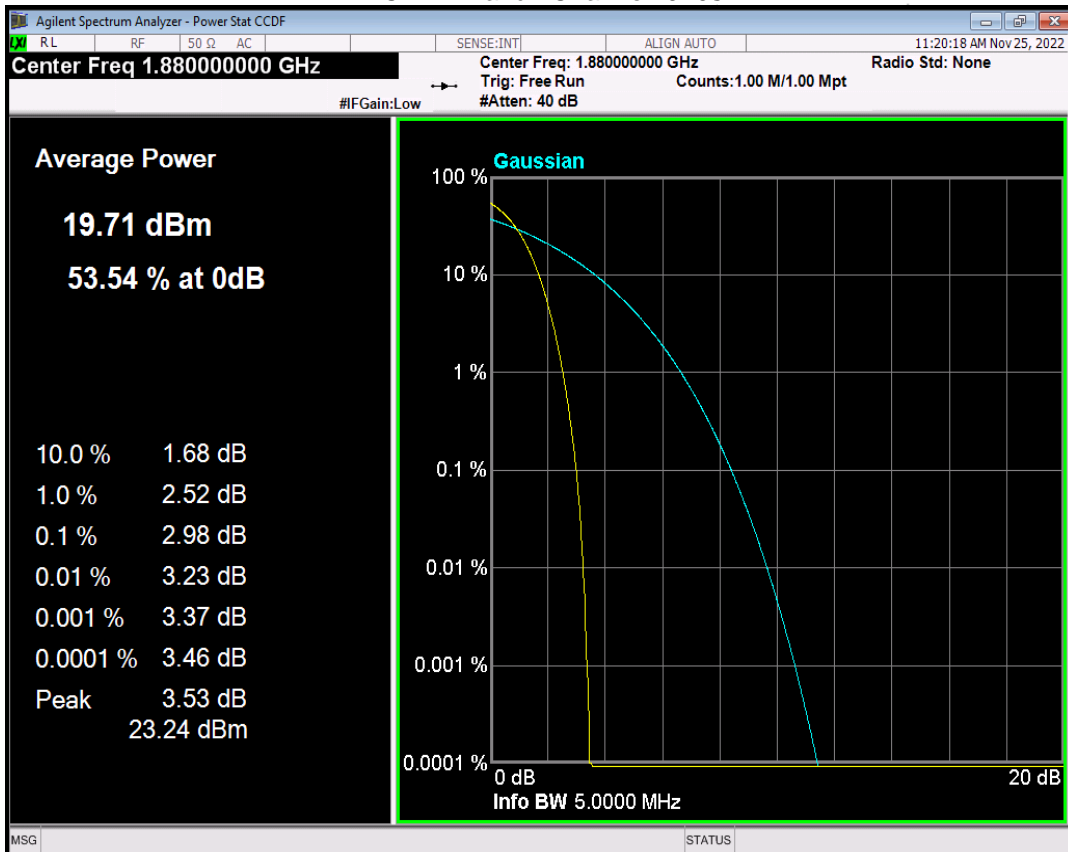

WCDMA Band2 Channel=9538

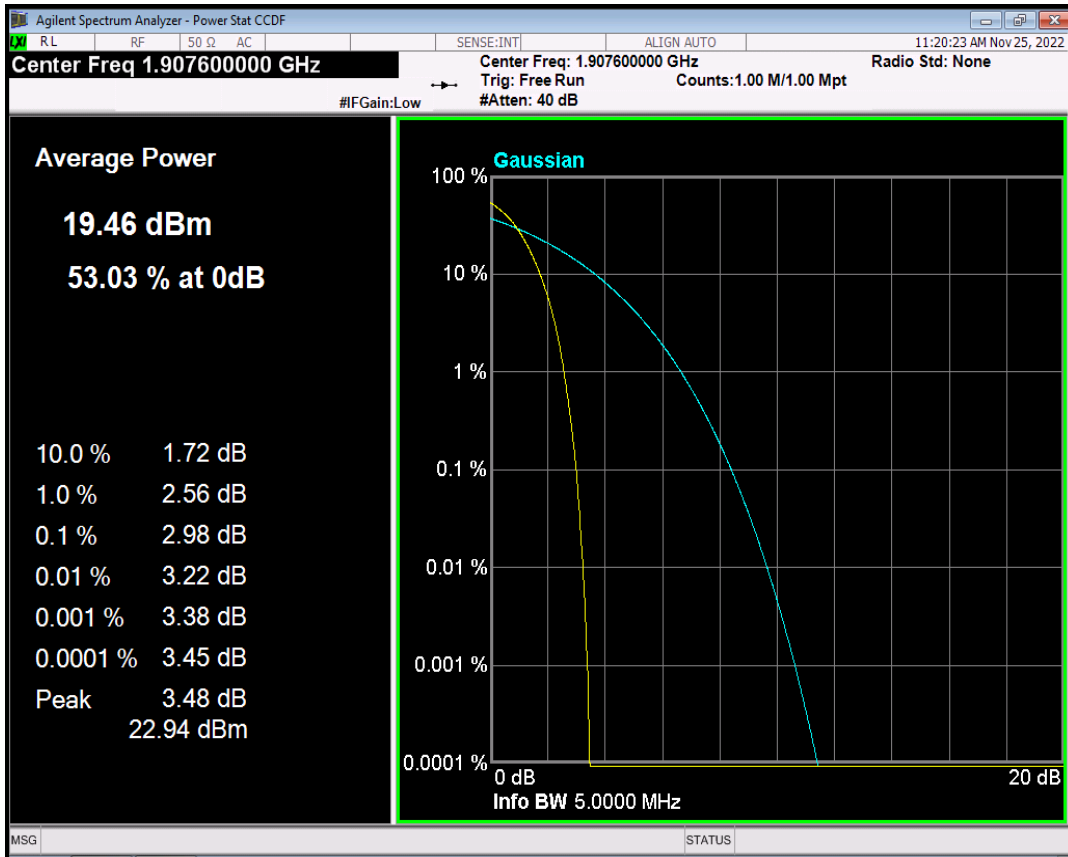

WCDMA Band4 Channel=1312

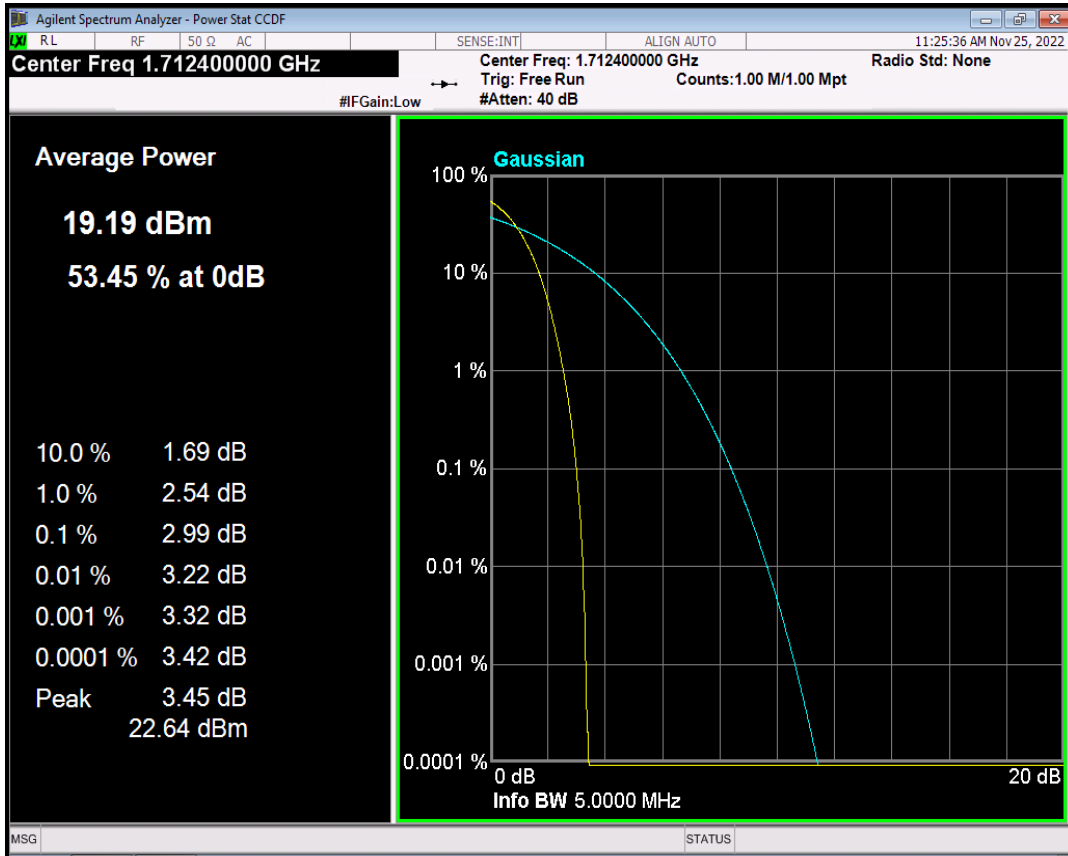

TC
 3C
 PPR
 检测

WCDMA Band4 Channel=1450

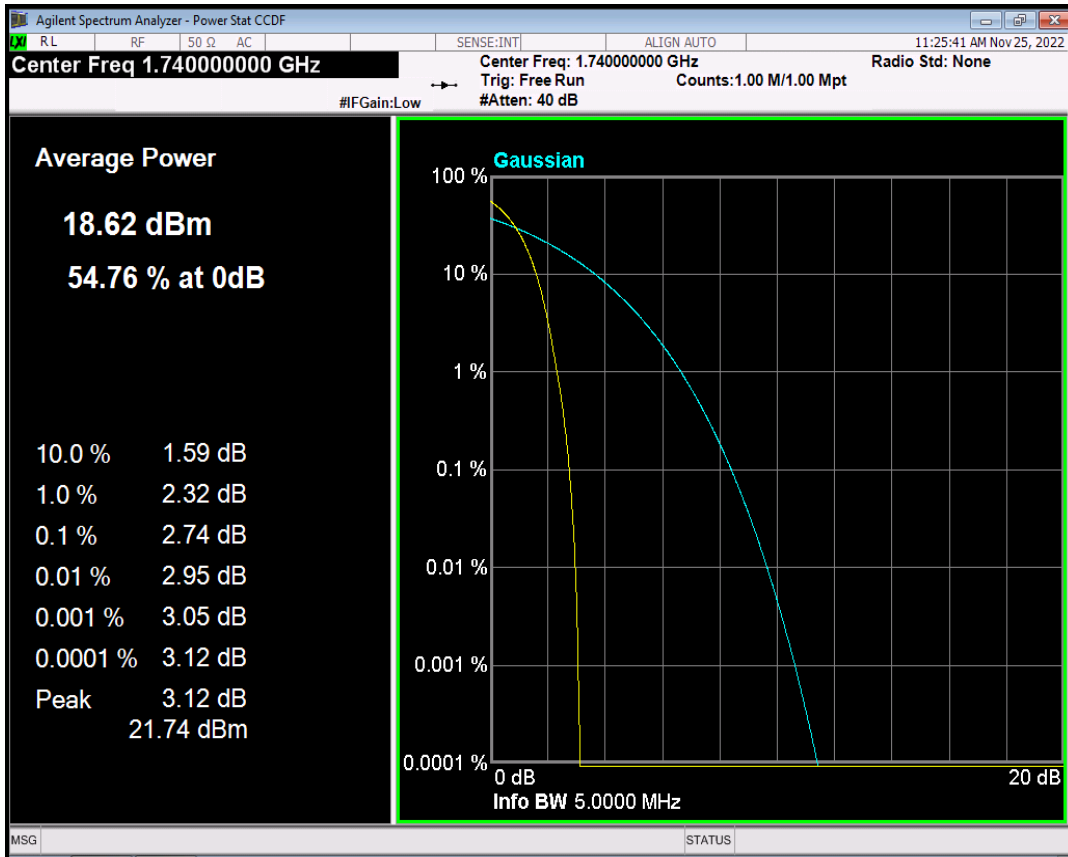

WCDMA Band4 Channel=1513

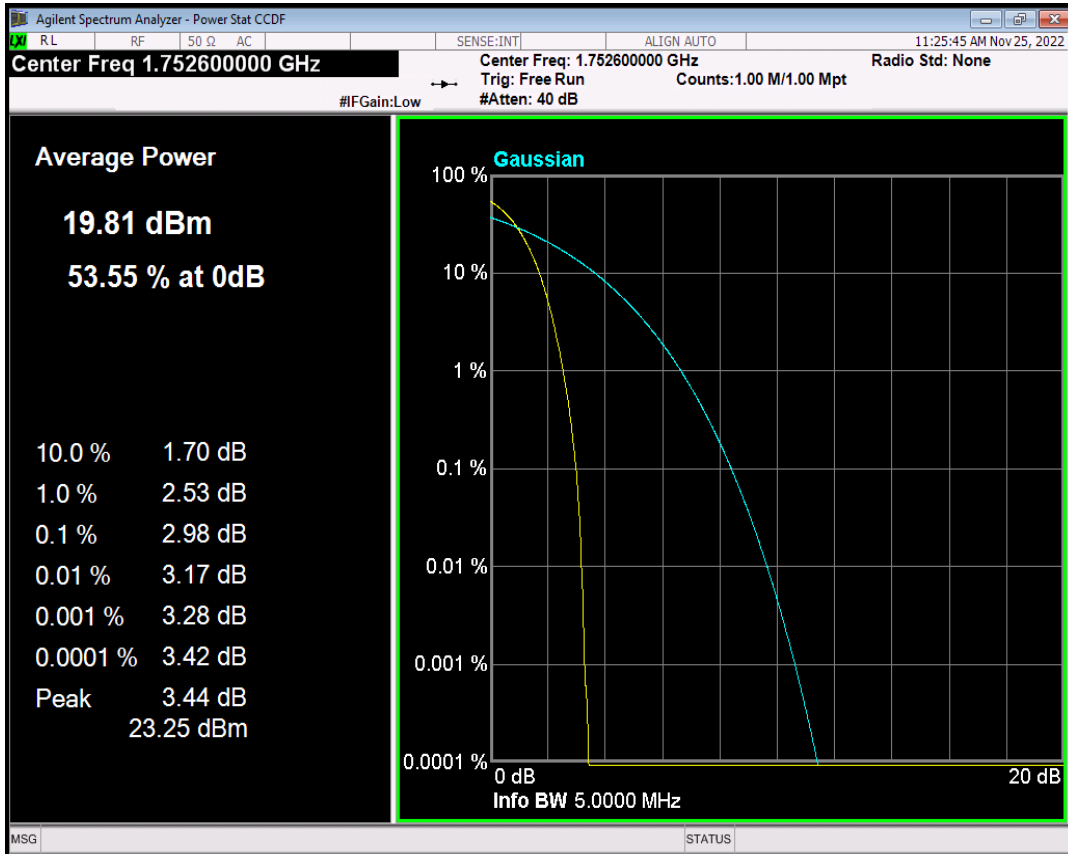

TEC
 TO
 OVE
 检

WCDMA Band5 Channel=4132

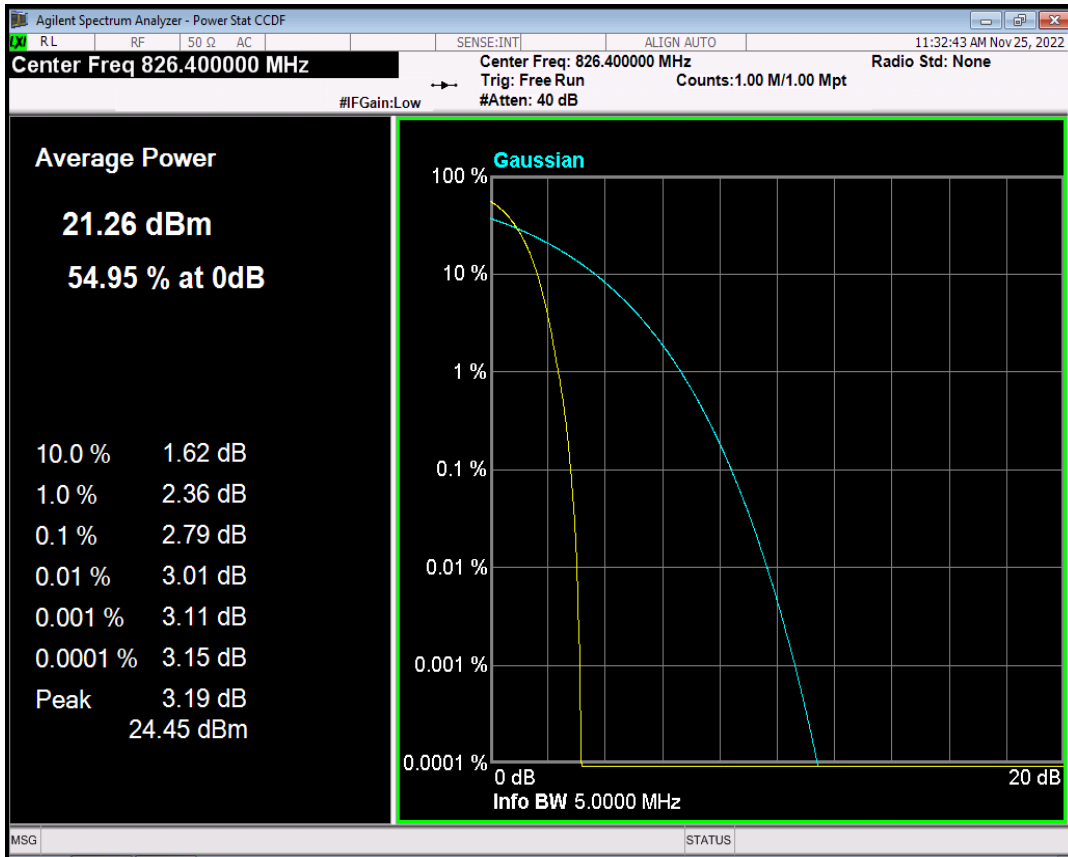

WCDMA Band5 Channel=4182

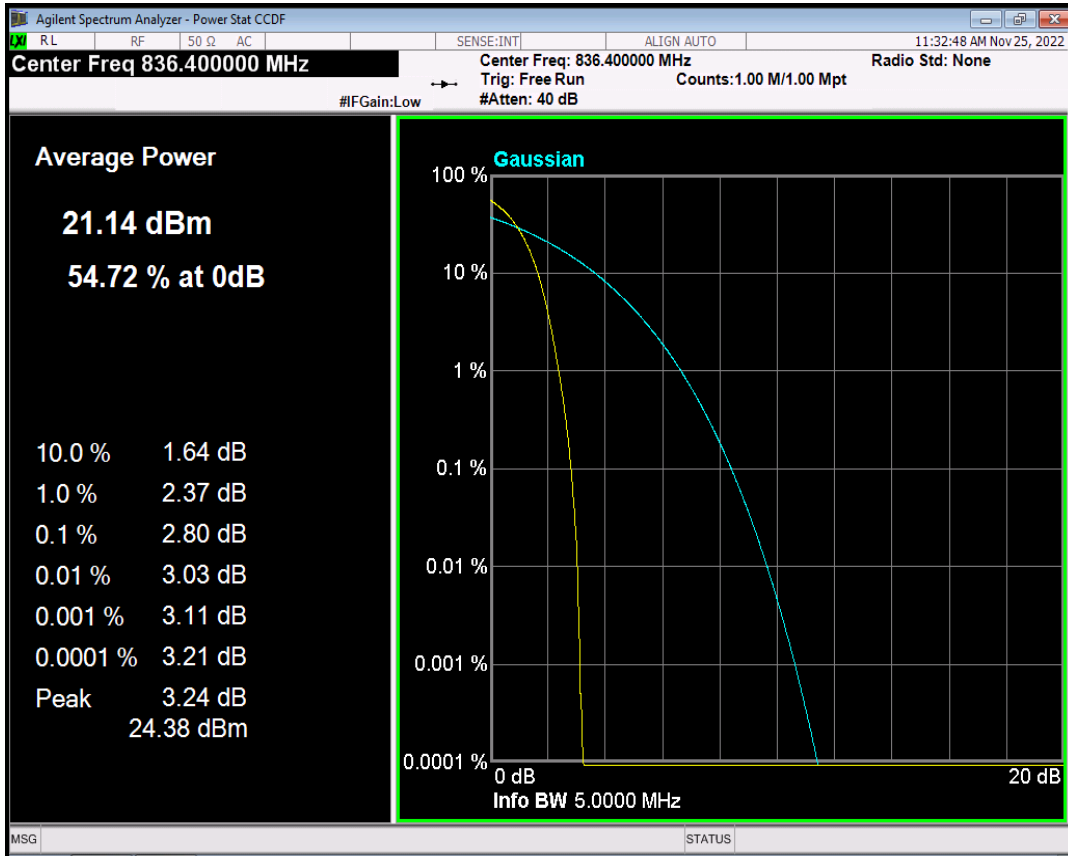

WCDMA Band5 Channel=4233

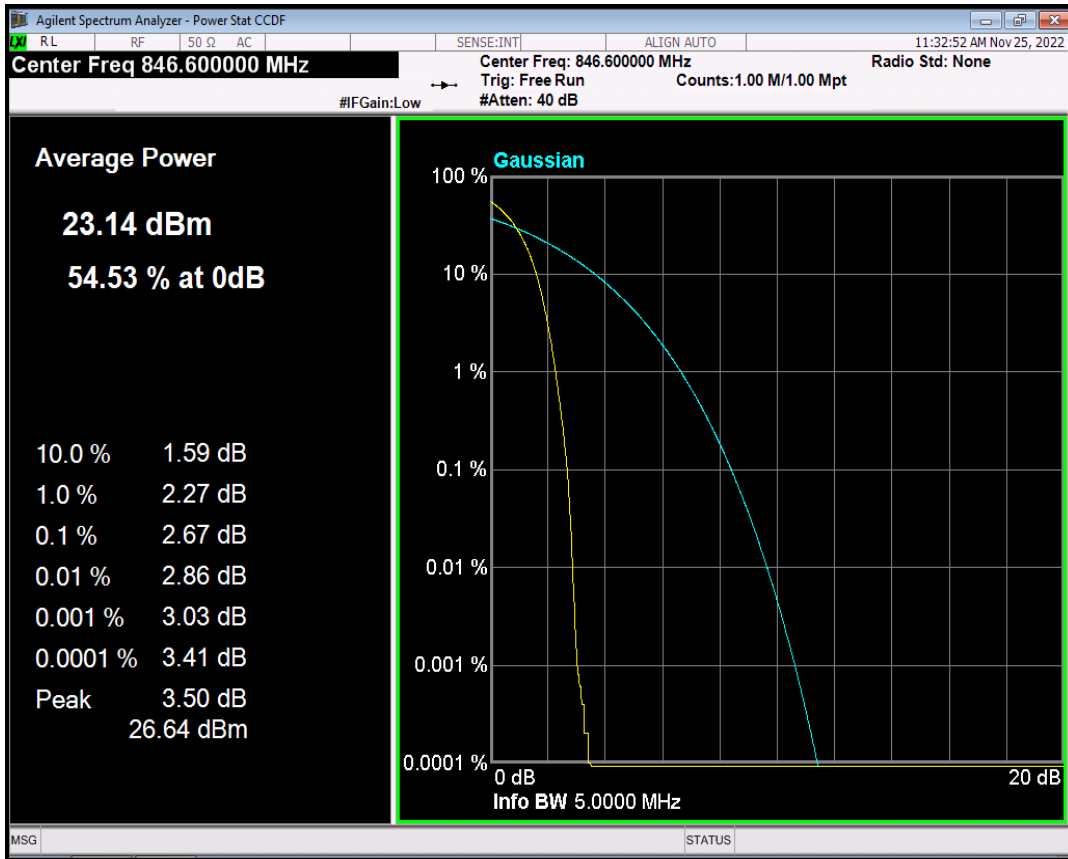

CO., LTD

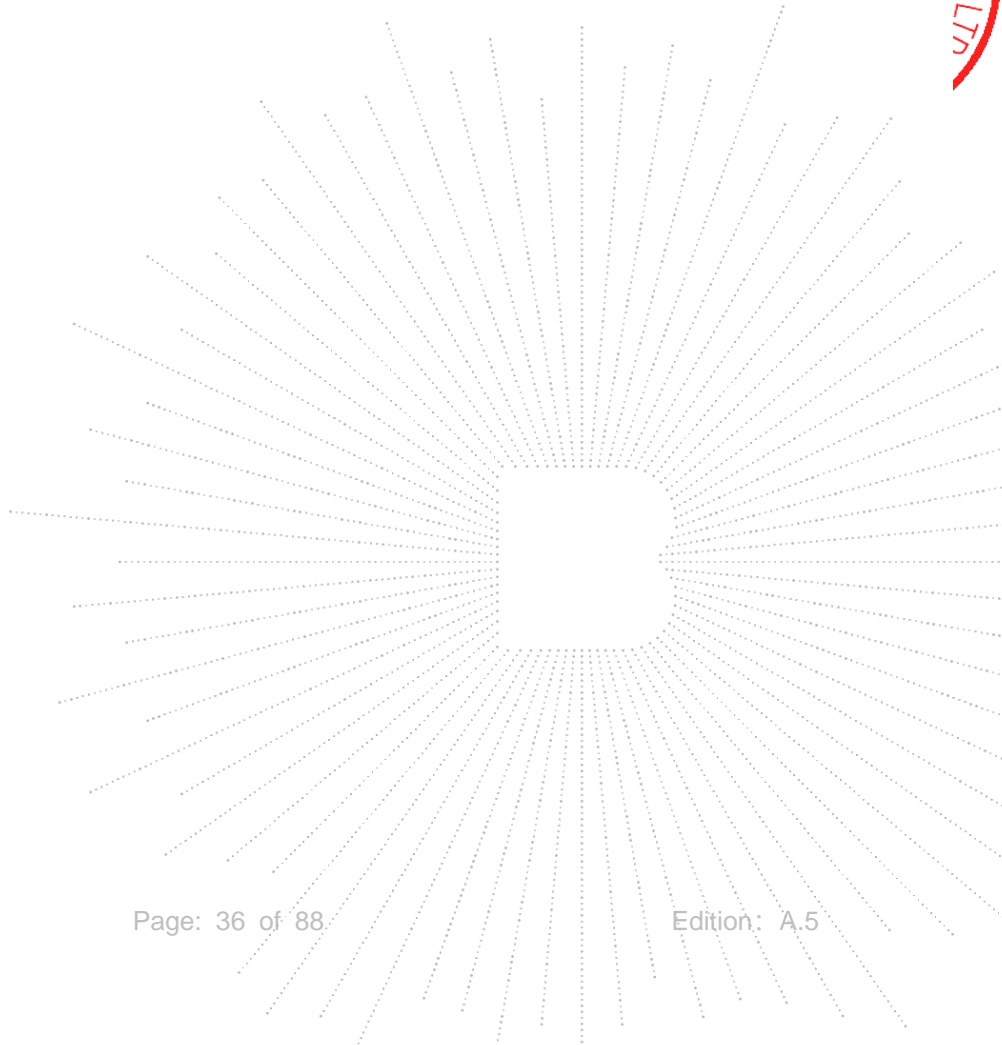

8. Emission Bandwidth

8.1 Block Diagram Of Test Setup

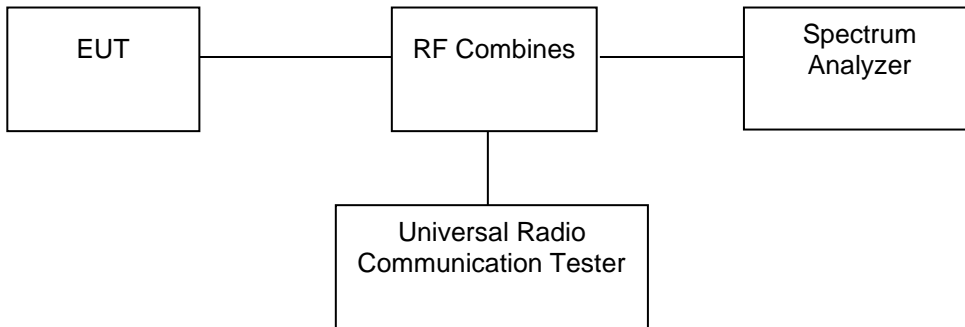

8.2 Limit

According to §22.917(b), The emission bandwidth is defined as the width of the signal between two points, one below the carrier center frequency and one above the carrier center frequency, outside of which all emissions are attenuated at least 26 dB below the transmitter power.

According to §24.238(b), The emission bandwidth is defined as the width of the signal between two points, one below the carrier center frequency and one above the carrier center frequency, outside of which all emissions are attenuated at least 26 dB below the transmitter power.

According to §27.53, The emission bandwidth is defined as the width of the signal between two points, one below the carrier center frequency and one above the carrier center frequency, outside of which all emissions are attenuated at least 26 dB below the transmitter power.

8.3 Test procedure

The RF output terminal of the transmitter was connected to the input of the spectrum analyzer via a suitable attenuation. The RBW of the spectrum analyzer was set to 10kHz for GSM mode and 100kHz for WCDMA mode, VBW shall be at least 3 times the RBW, and the 26dB bandwidth was recorded.

8.4 Test Result

Band	Channel	Frequency (MHz)	99% OBW (kHz)	-26dB EBW (kHz)	Verdict
GSM850	128	824.2	248.340	317.602	PASS
GSM850	190	836.6	244.028	328.630	PASS
GSM850	251	848.8	238.637	316.750	PASS
GPRS850	128	824.2	244.457	317.000	PASS
GPRS850	190	836.6	250.747	313.979	PASS
GPRS850	251	848.8	246.200	312.698	PASS
EGPRS850	128	824.2	249.084	311.803	PASS
EGPRS850	190	836.6	253.455	325.002	PASS
EGPRS850	251	848.8	246.922	306.524	PASS

GSM850 Channel=128

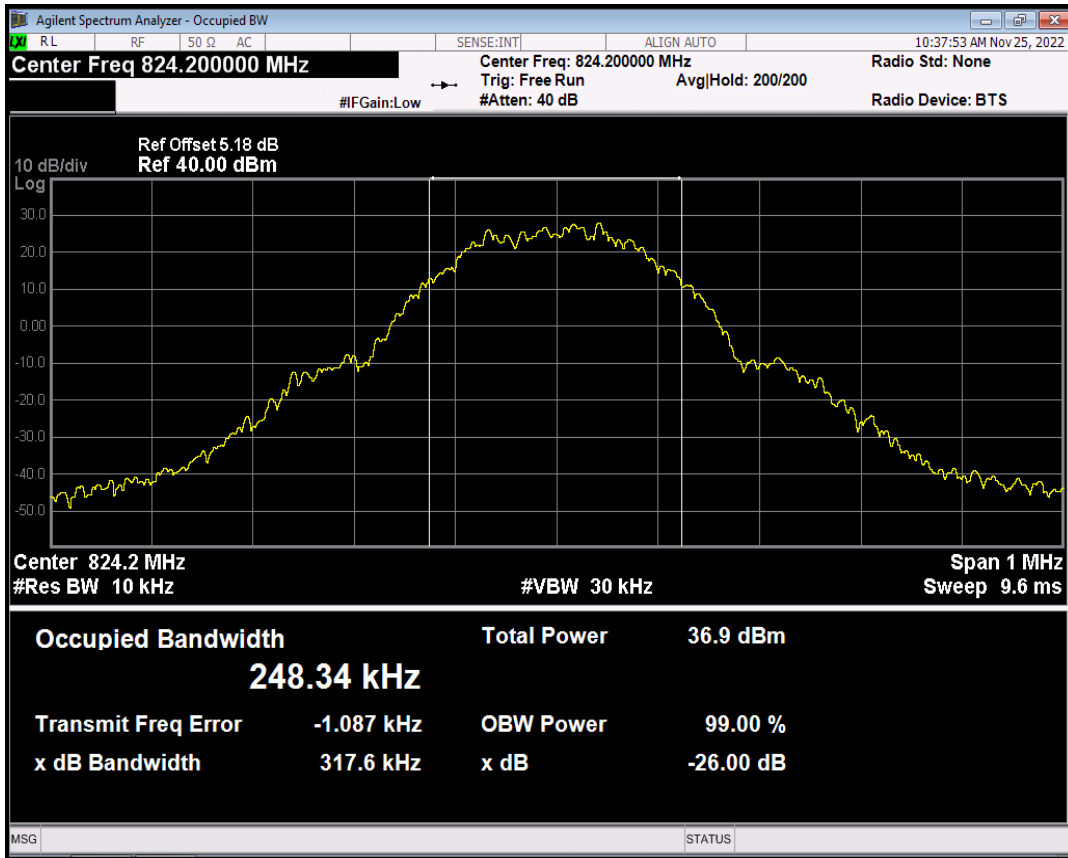

GSM850 Channel=190

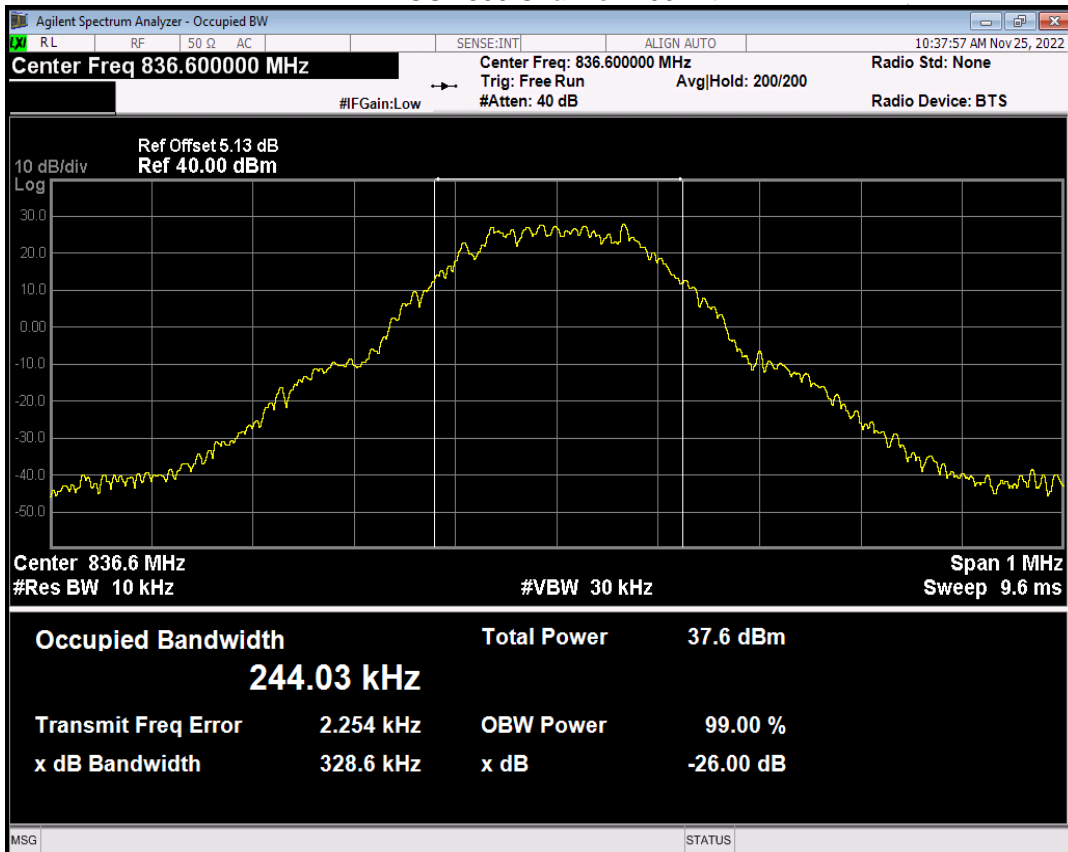

GSM850 Channel=251

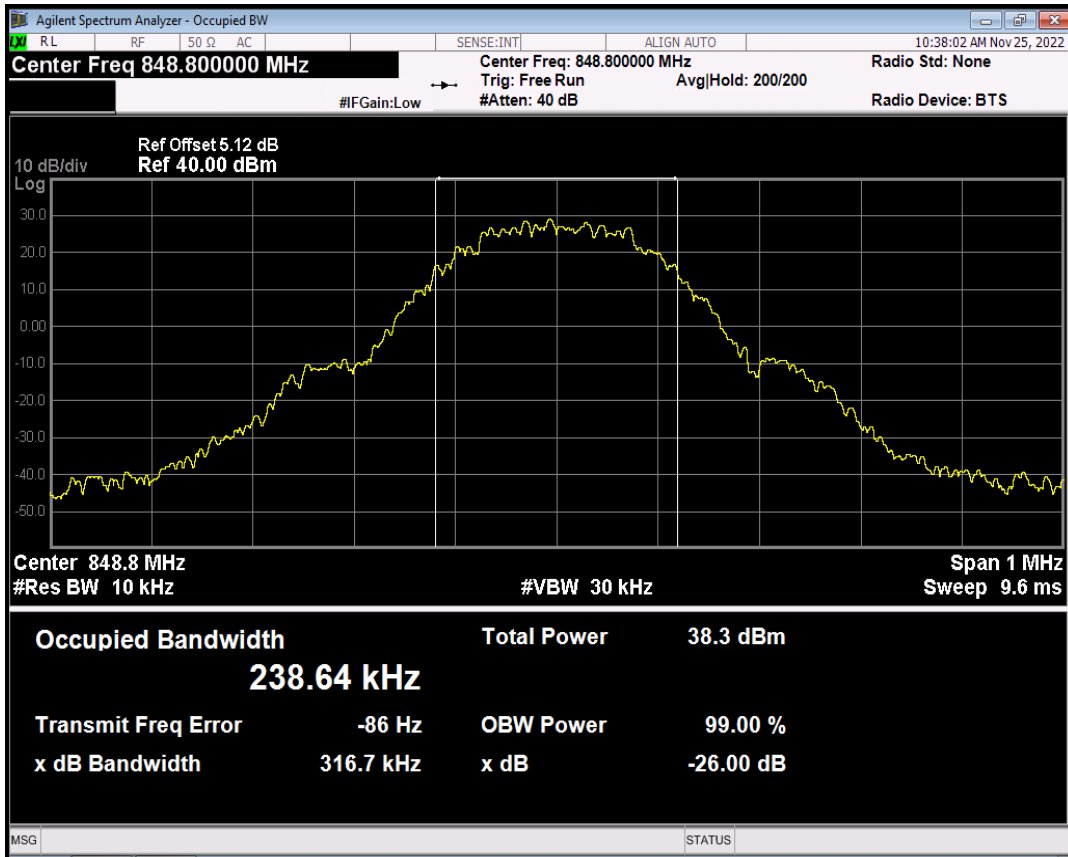

GPRS850 Channel=128

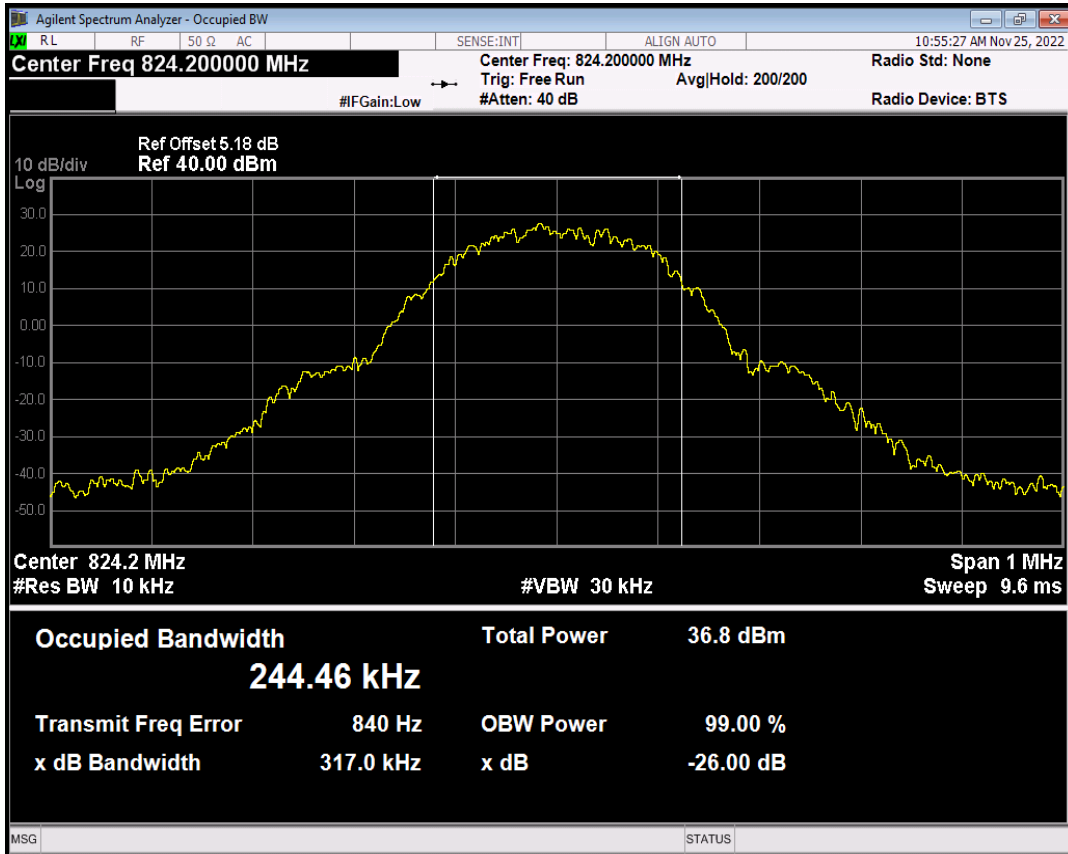
 BCTC
 3C
 PPR
 检测

GPRS850 Channel=190

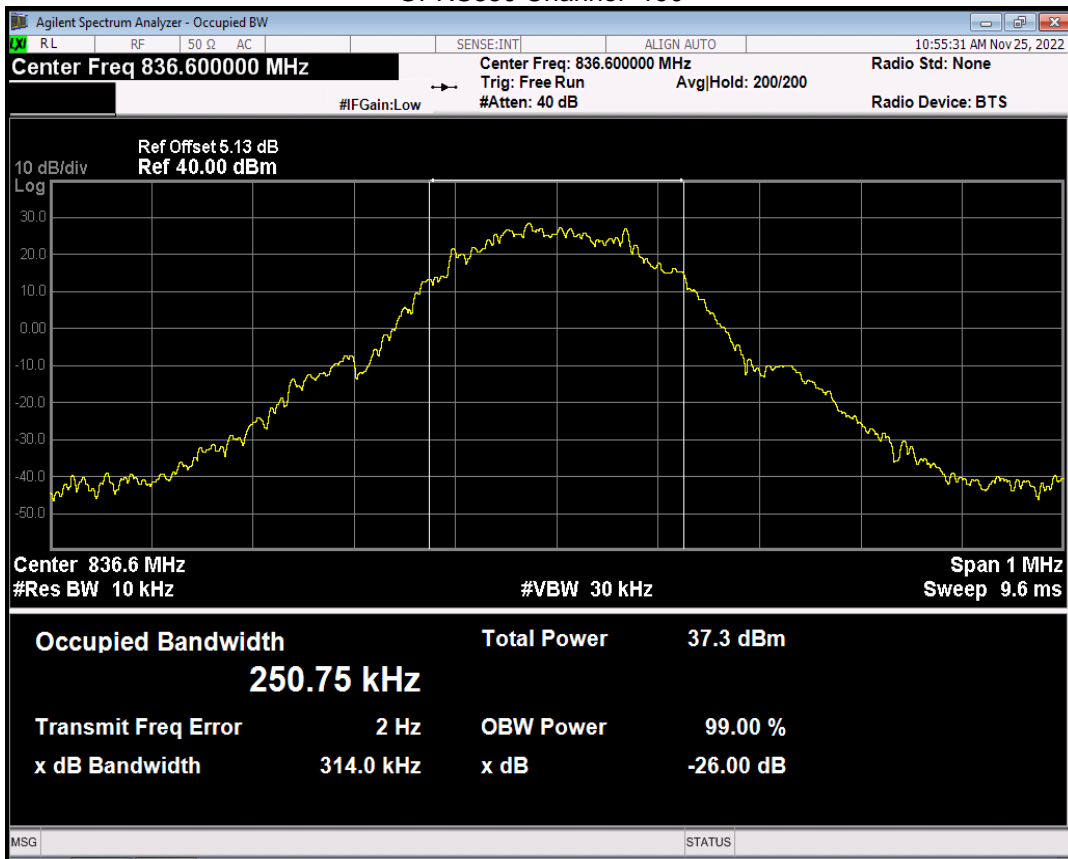

GPRS850 Channel=251

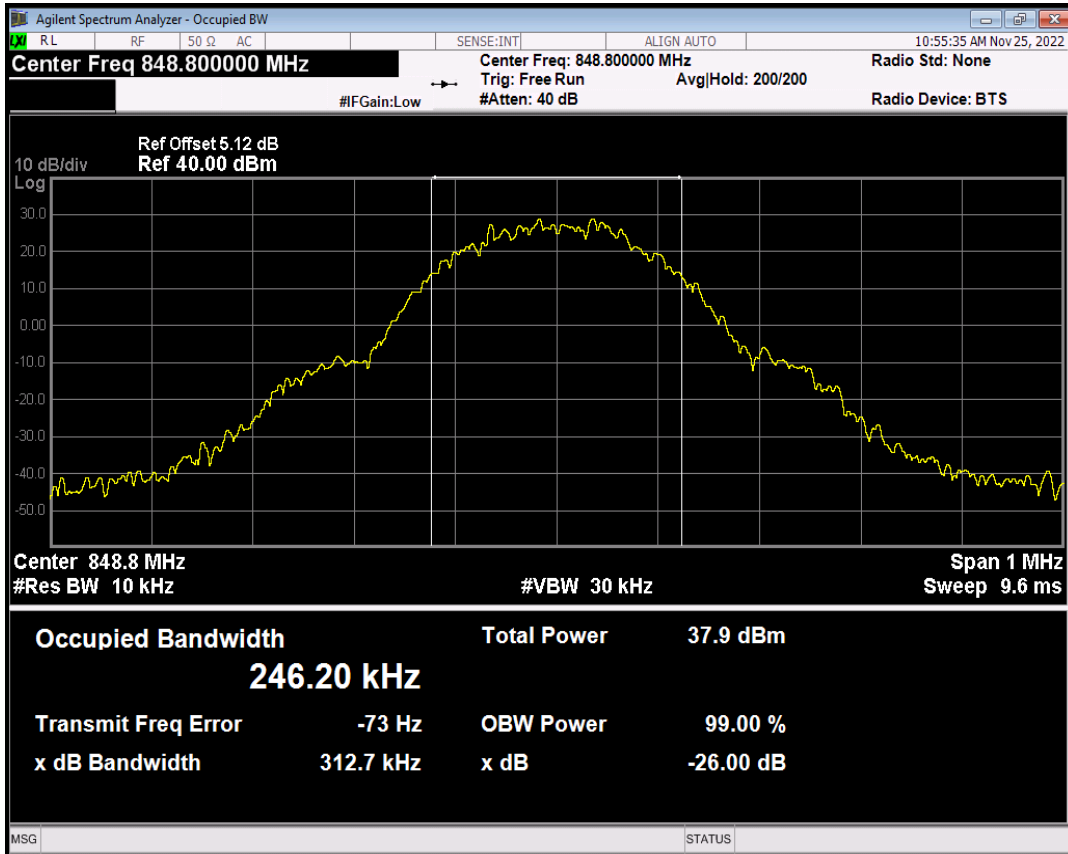
 TE
 TO
 OVE
 检

EGPRS850 Channel=128

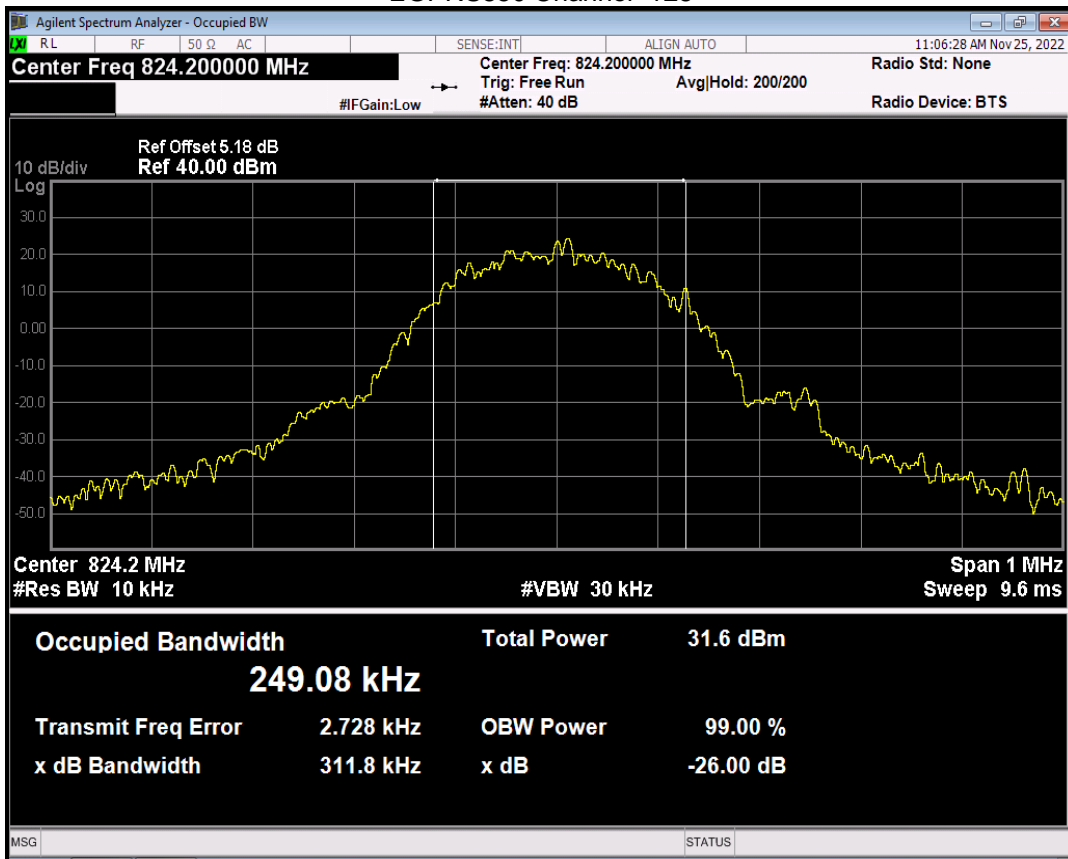

EGPRS850 Channel=190

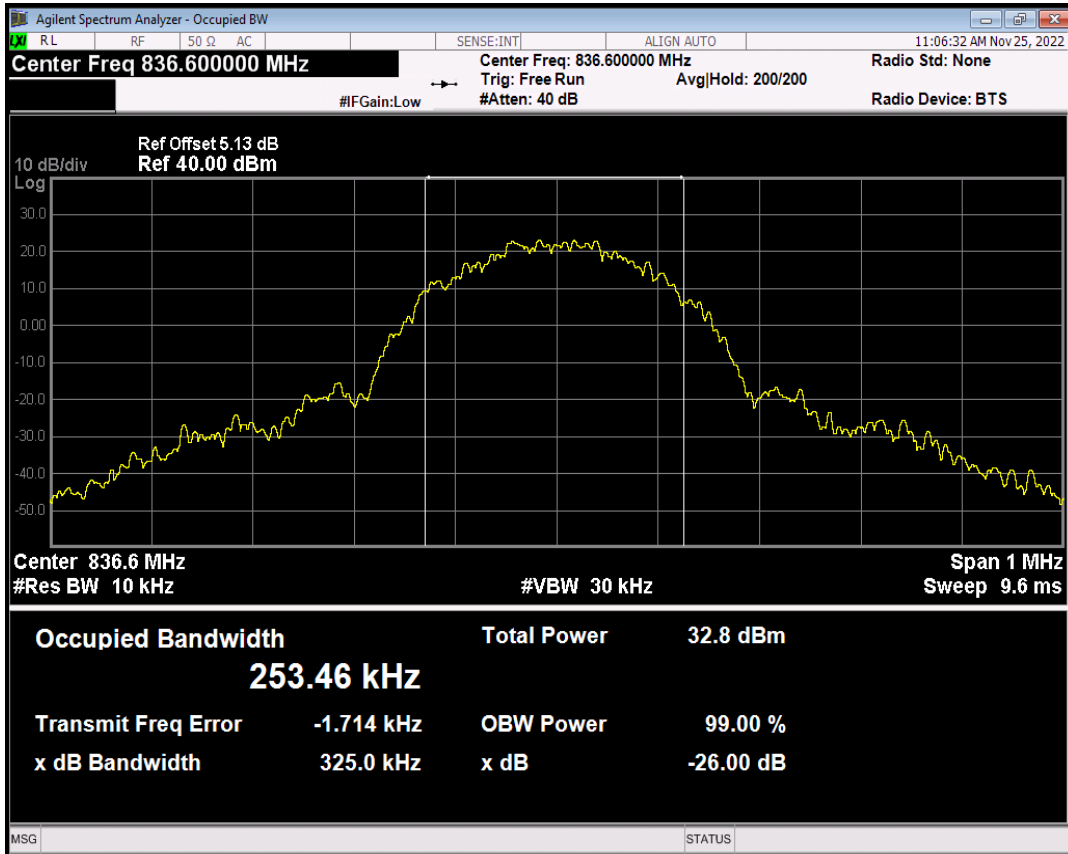

EGPRS850 Channel=251

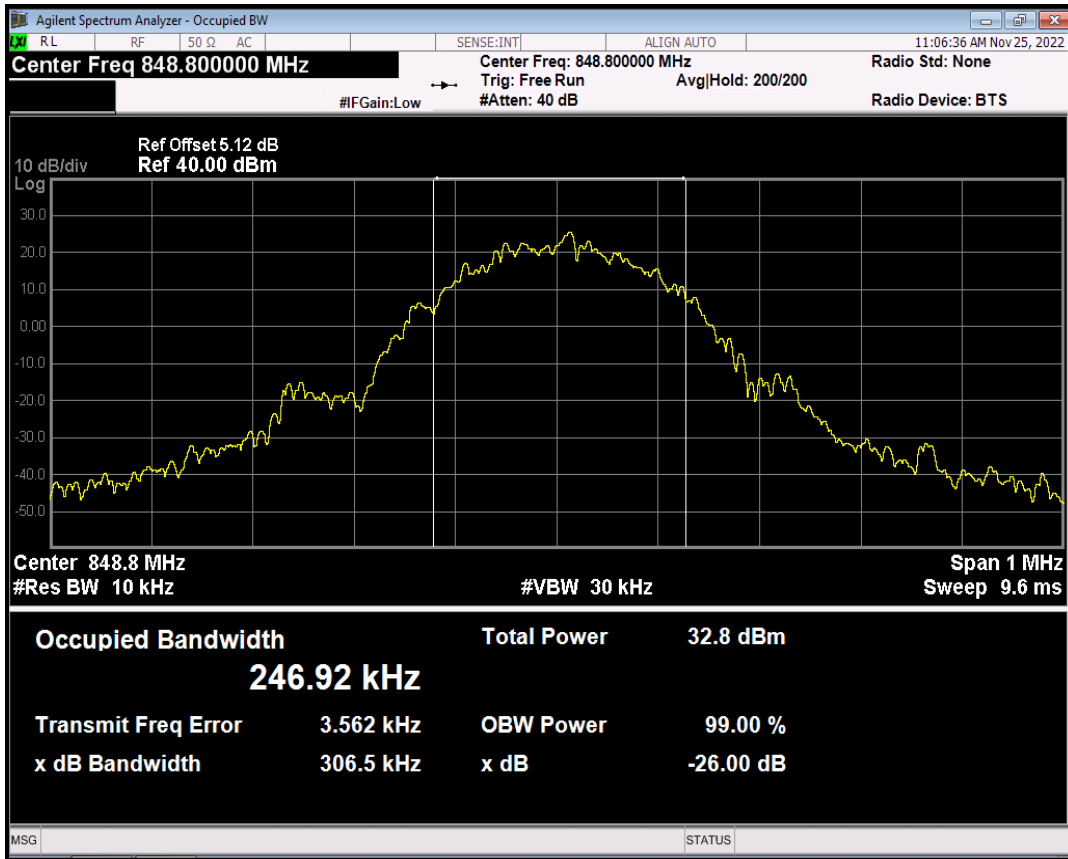

CO.LTD

Band	Channel	Frequency (MHz)	99% OBW (kHz)	-26dB EBW (kHz)	Verdict
GSM1900	512	1850.2	239.294	312.857	PASS
GSM1900	661	1880	247.339	318.210	PASS
GSM1900	810	1909.8	244.855	317.767	PASS
GPRS1900	512	1850.2	247.916	308.829	PASS
GPRS1900	661	1880	248.111	319.415	PASS
GPRS1900	810	1909.8	245.026	311.601	PASS
EGPRS1900	512	1850.2	267.512	340.058	PASS
EGPRS1900	661	1880	263.764	325.523	PASS
EGPRS1900	810	1909.8	262.073	342.024	PASS

GSM1900 Channel=512

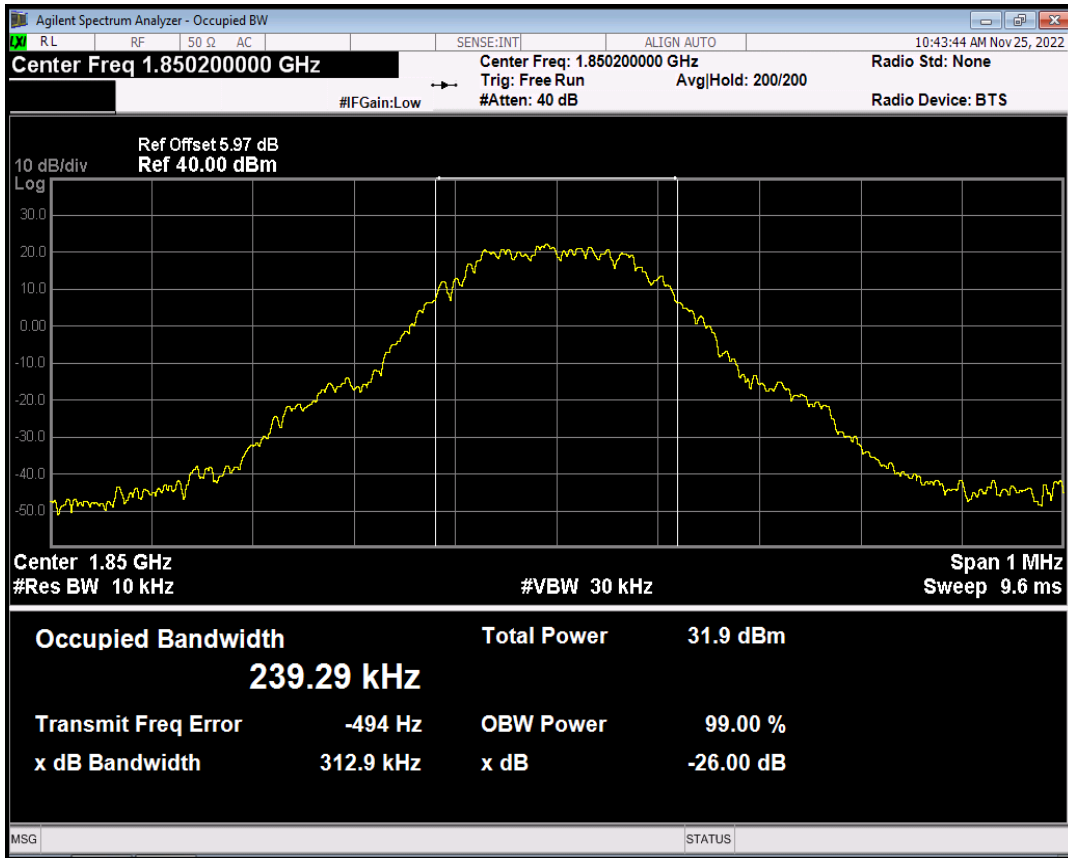

GSM1900 Channel=661

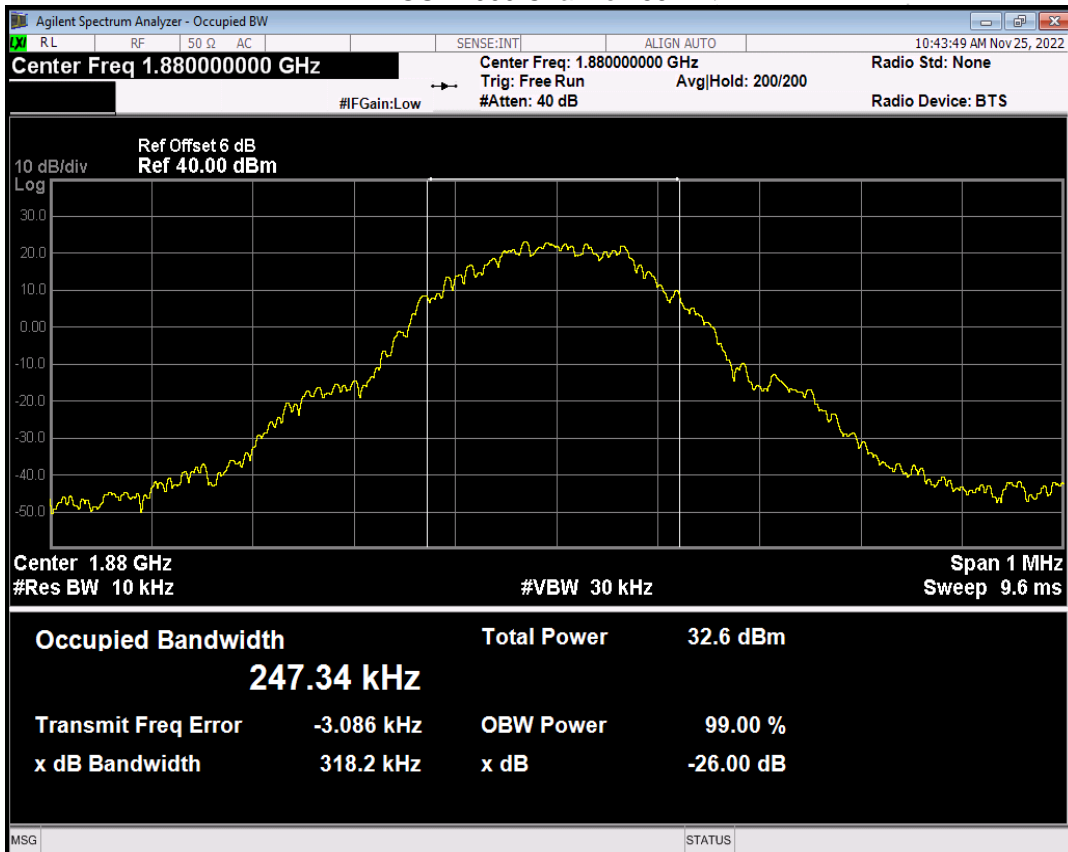

GSM1900 Channel=810

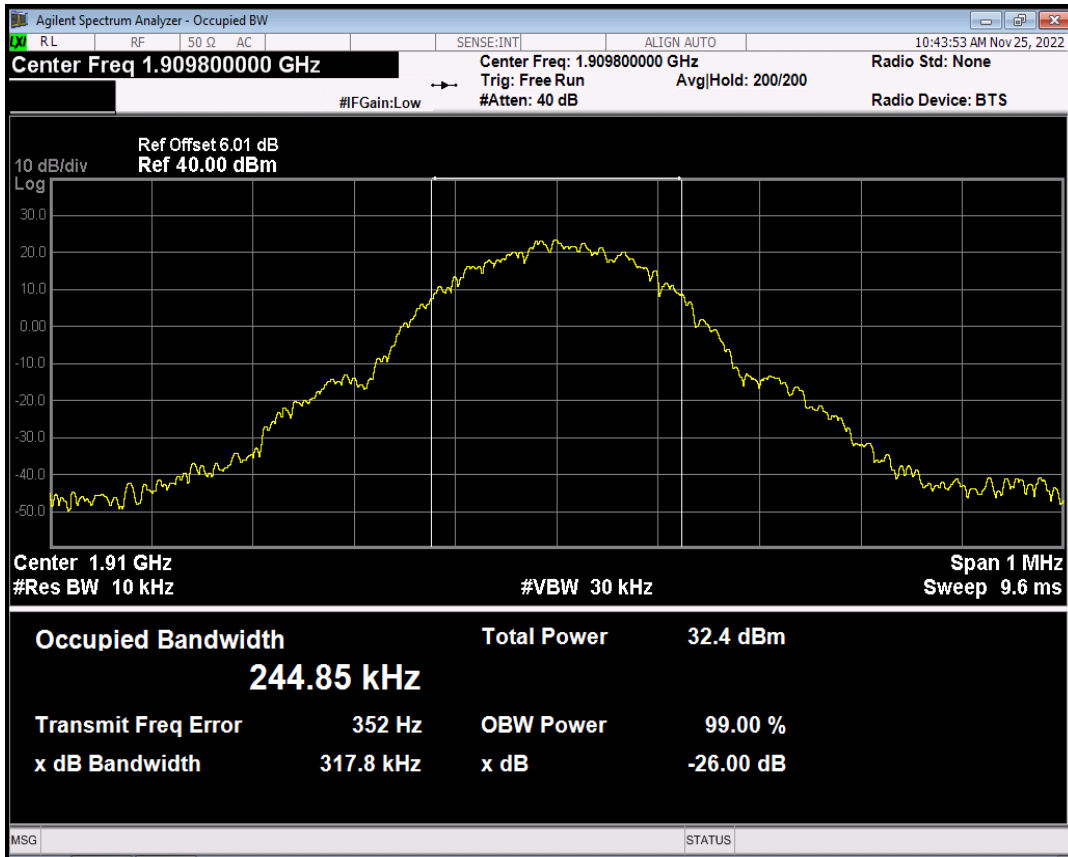

GPRS1900 Channel=512

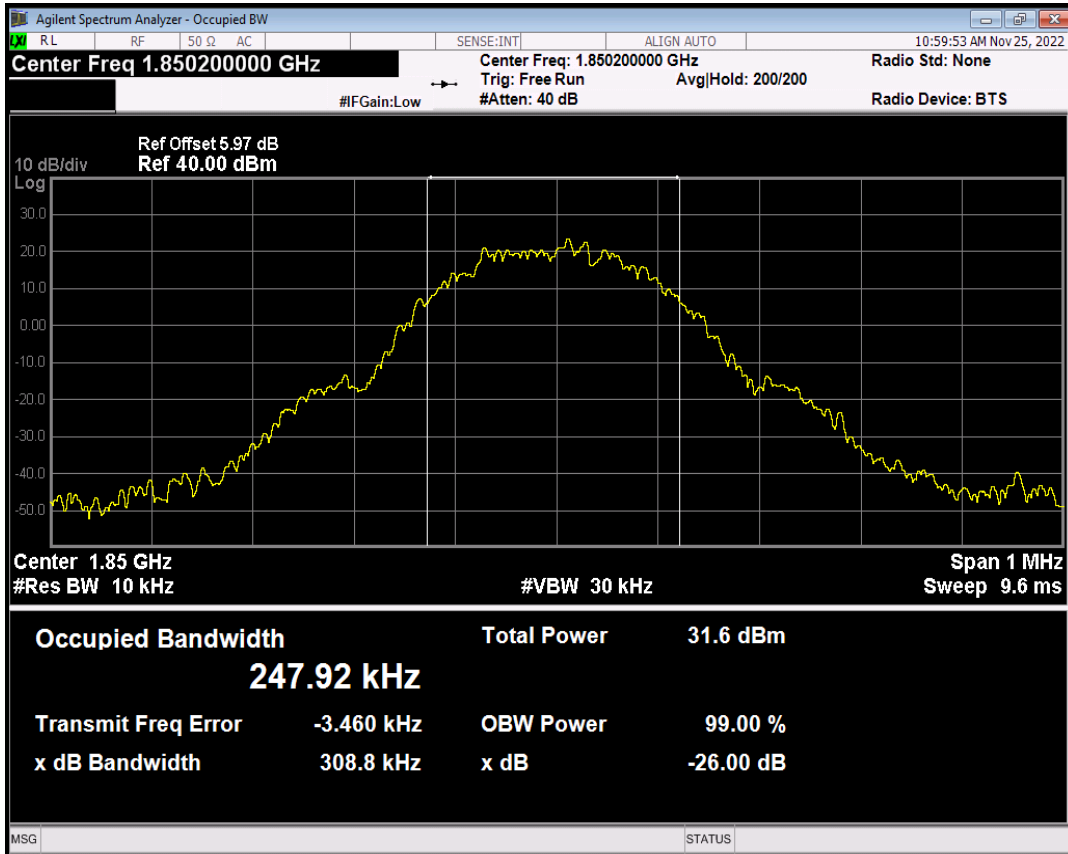

GPRS1900 Channel=661

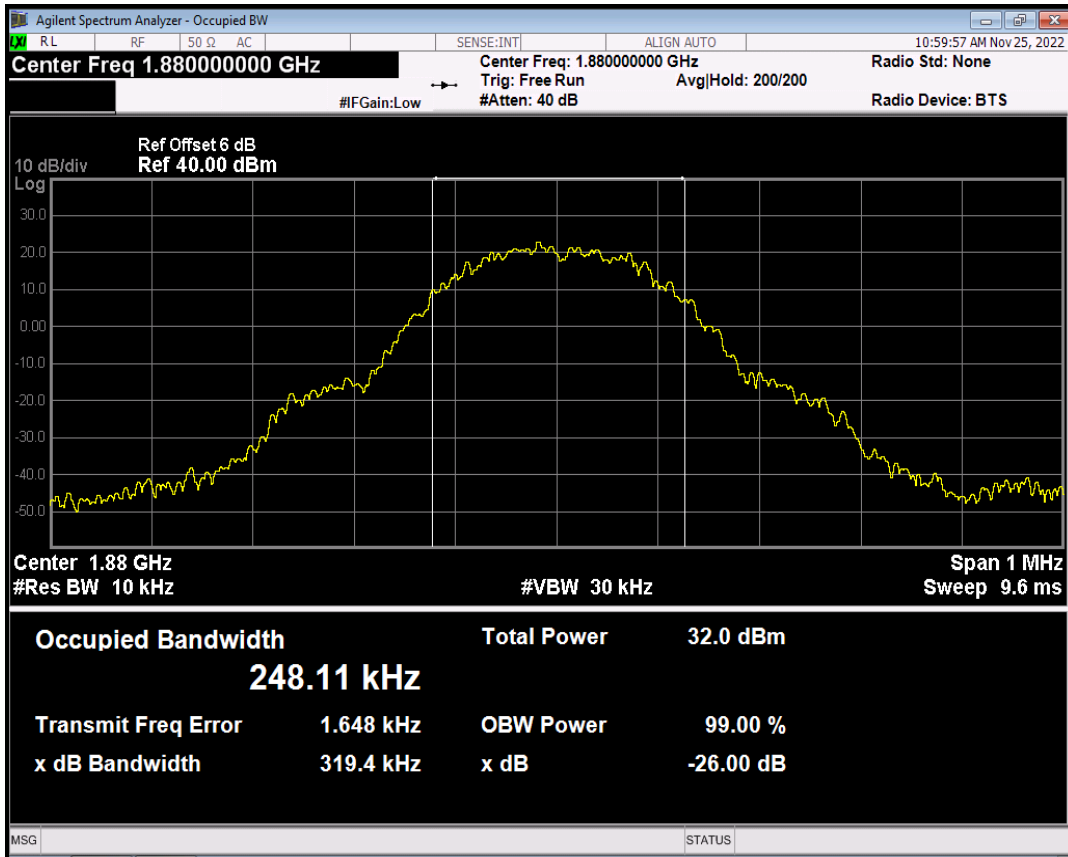

GPRS1900 Channel=810

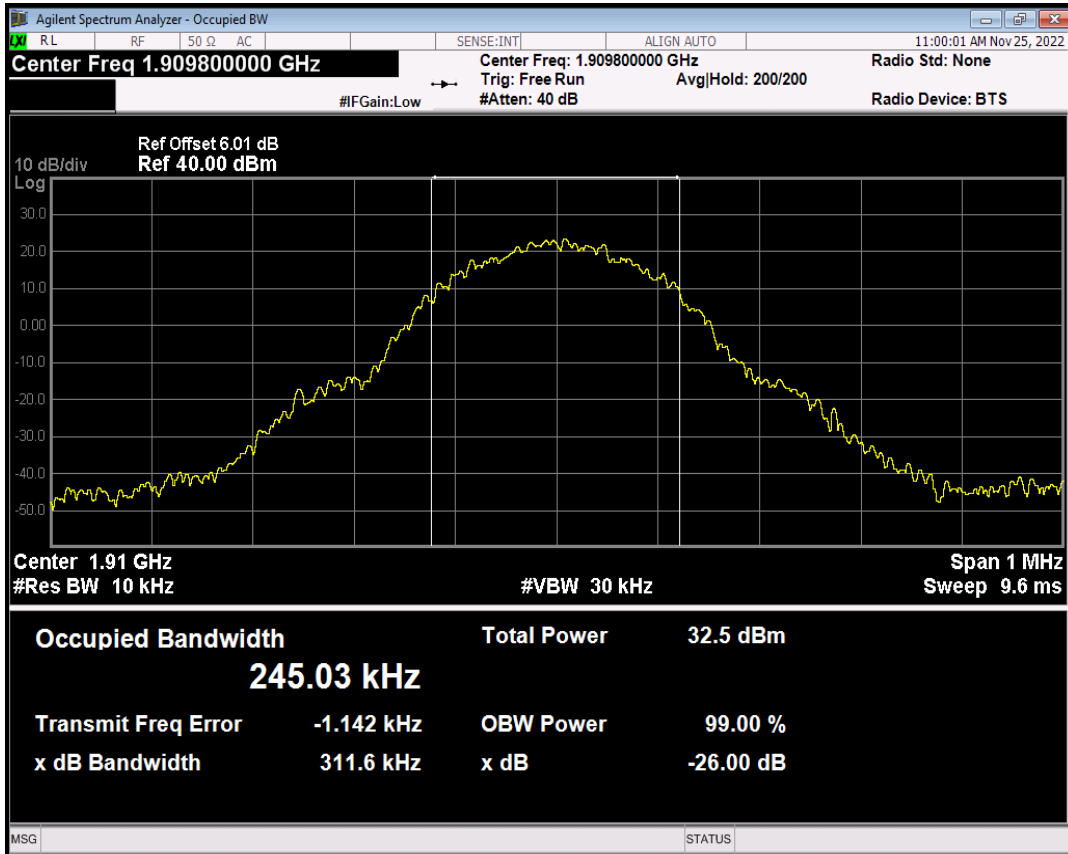

EGPRS1900 Channel=512

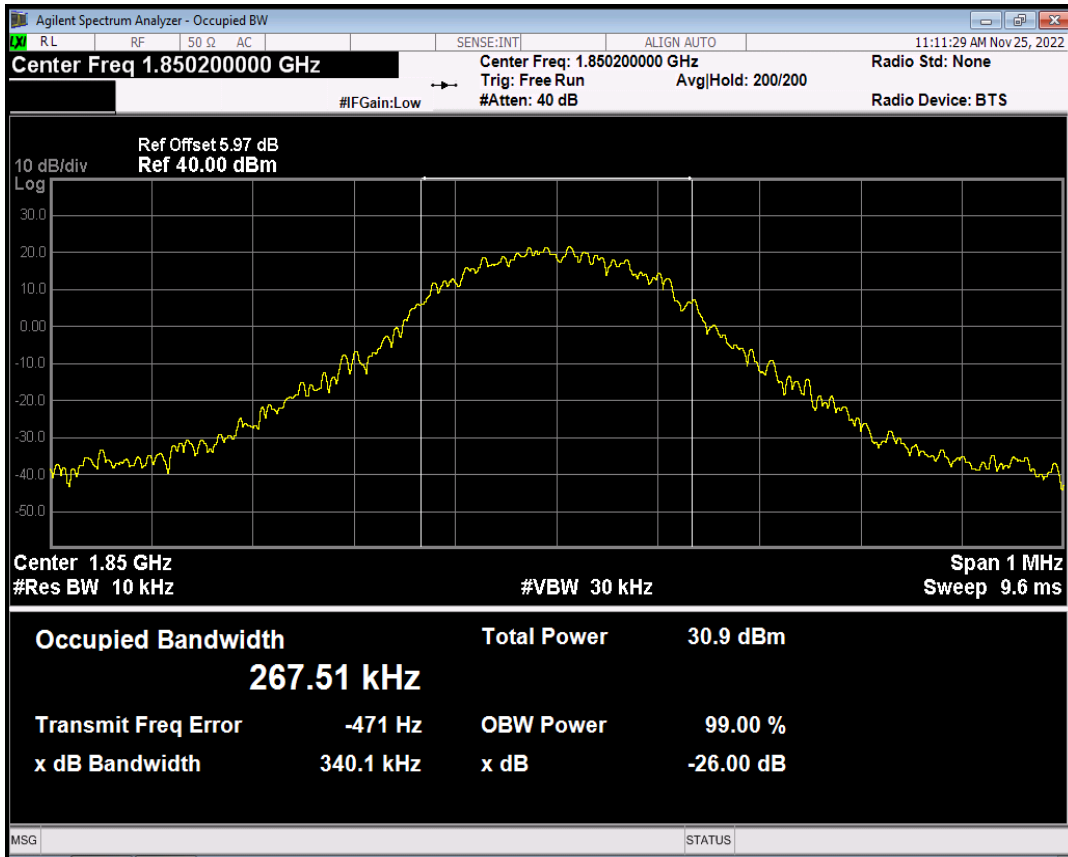

EGPRS1900 Channel=661

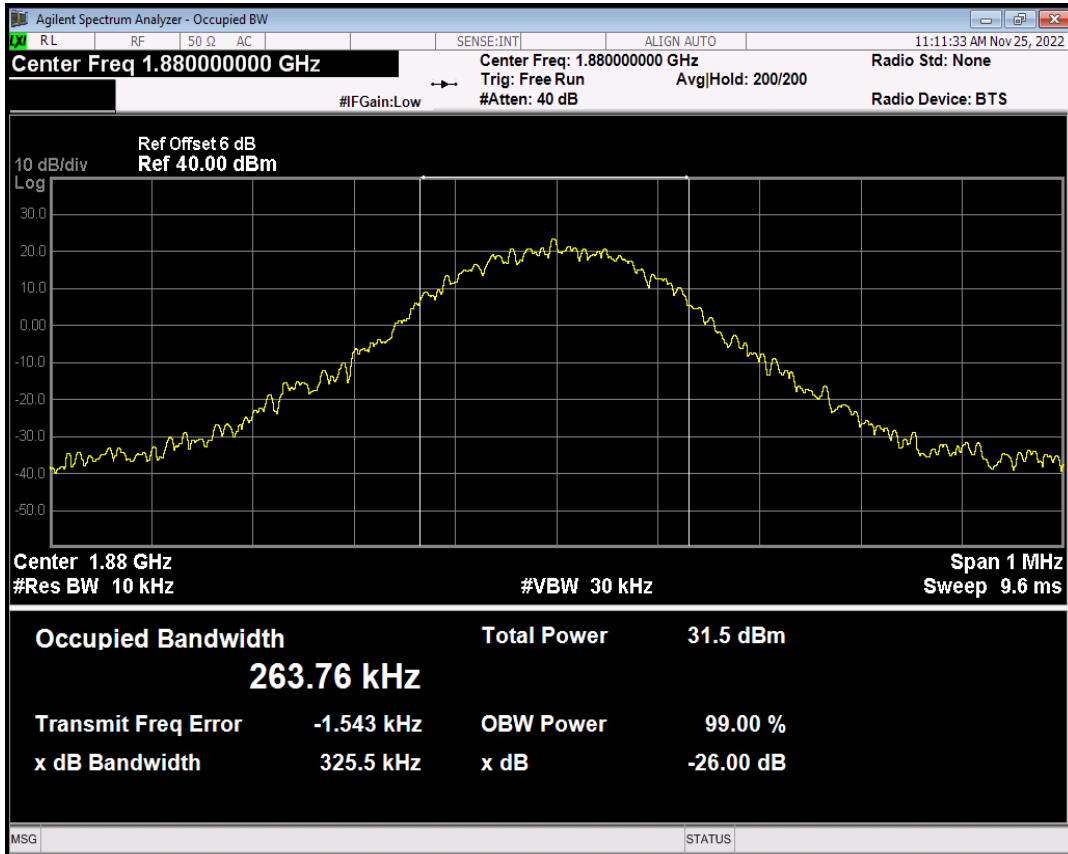
 IC
C
PR
測

EGPRS1900 Channel=810

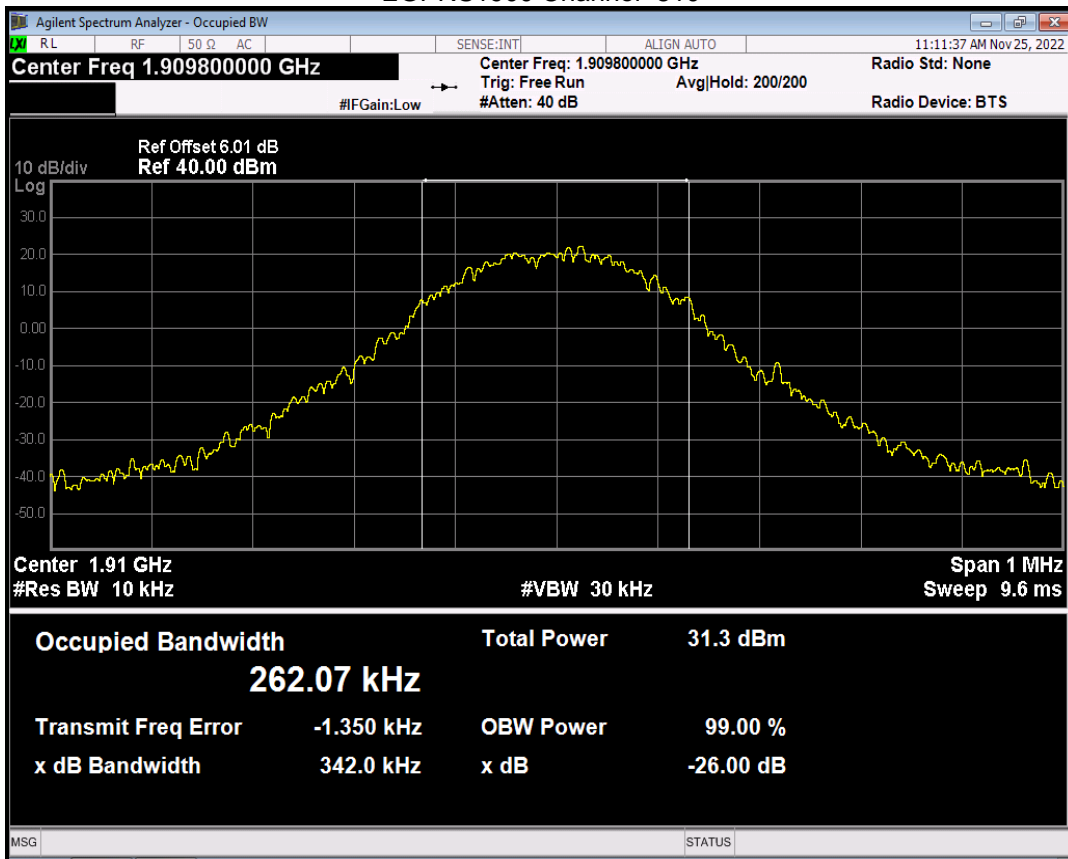

Band	Channel	Frequency (MHz)	99% OBW (kHz)	-26dB EBW (kHz)	Verdict
WCDMA Band2	9262	1852.4	4166.964	4716.207	PASS
WCDMA Band2	9400	1880	4172.278	4698.788	PASS
WCDMA Band2	9538	1907.6	4161.481	4661.655	PASS
WCDMA Band4	1312	1712.4	4156.604	4701.476	PASS
WCDMA Band4	1450	1740	4161.716	4710.708	PASS
WCDMA Band4	1513	1752.6	4146.454	4707.010	PASS
WCDMA Band5	4132	826.4	4176.679	4712.179	PASS
WCDMA Band5	4182	836.4	4177.366	4739.589	PASS
WCDMA Band5	4233	846.6	4176.955	4736.081	PASS

Note: In WCDMA, RMC, HSDPA and HSUPA all three tests only reflect the worst mode RMC.

WCDMA Band2 Channel=9262

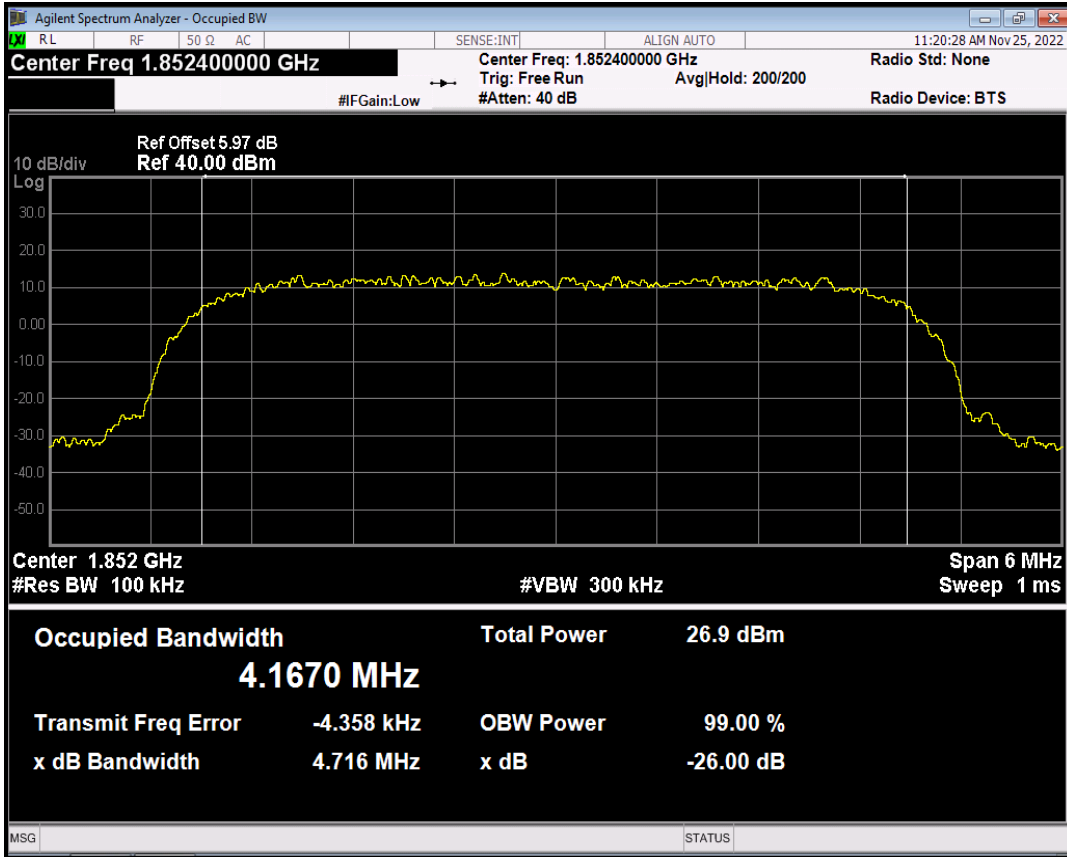

WCDMA Band2 Channel=9400

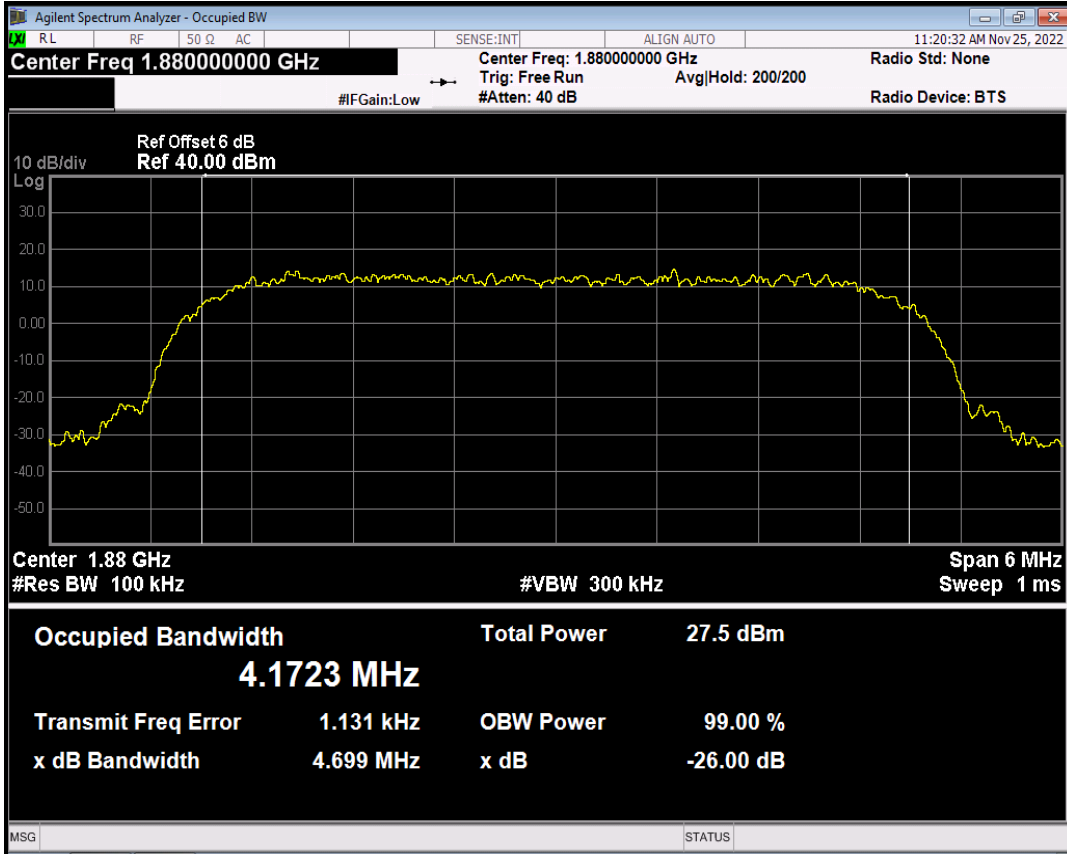

WCDMA Band2 Channel=9538

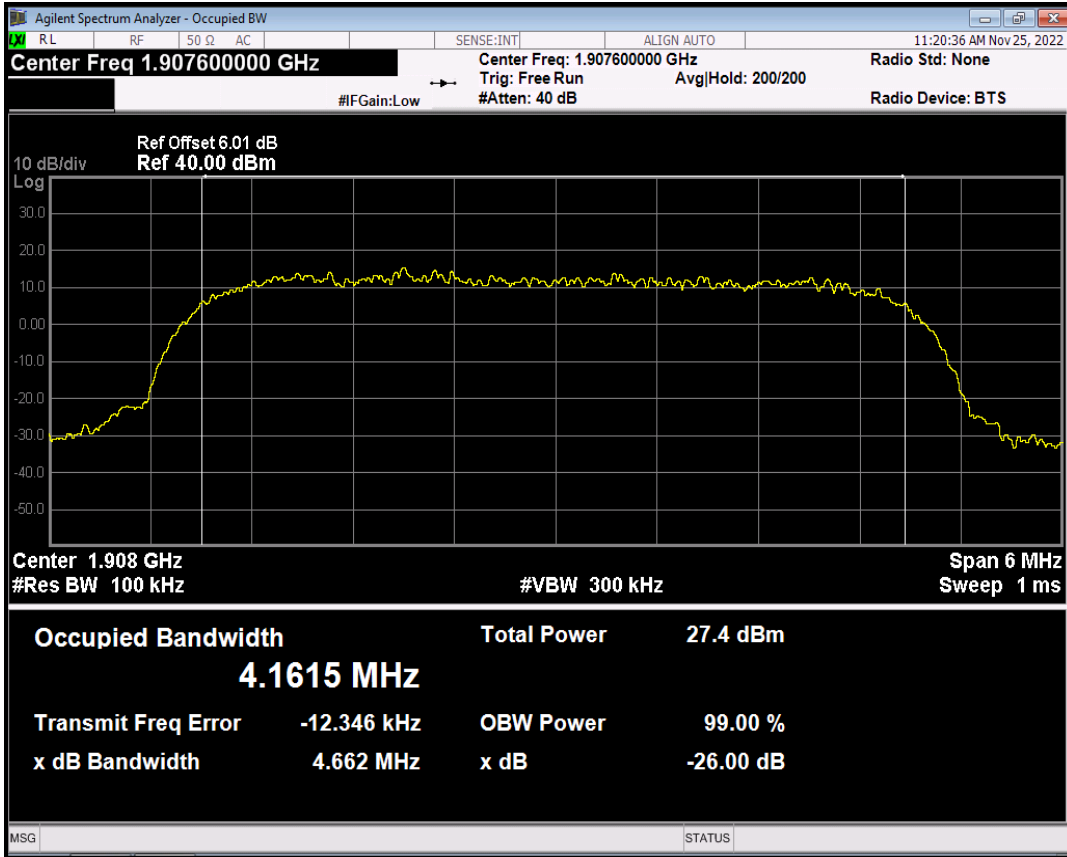

WCDMA Band4 Channel=1312

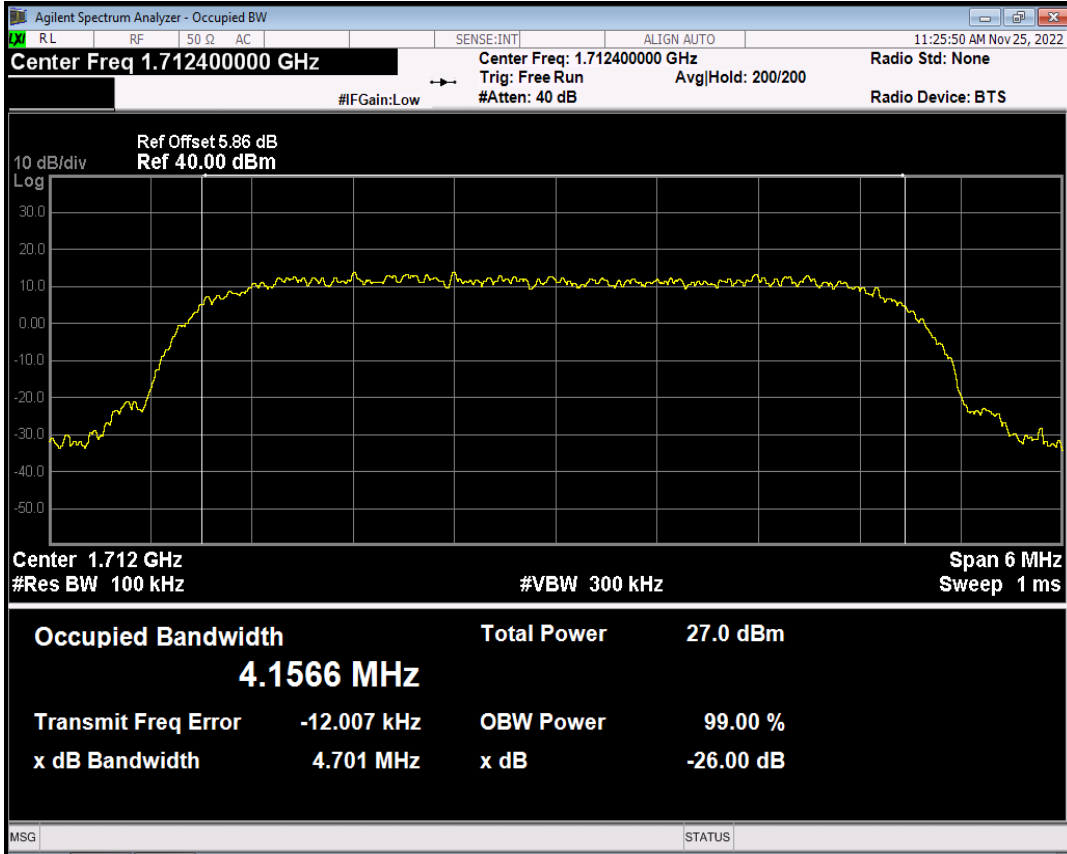

WCDMA Band4 Channel=1450

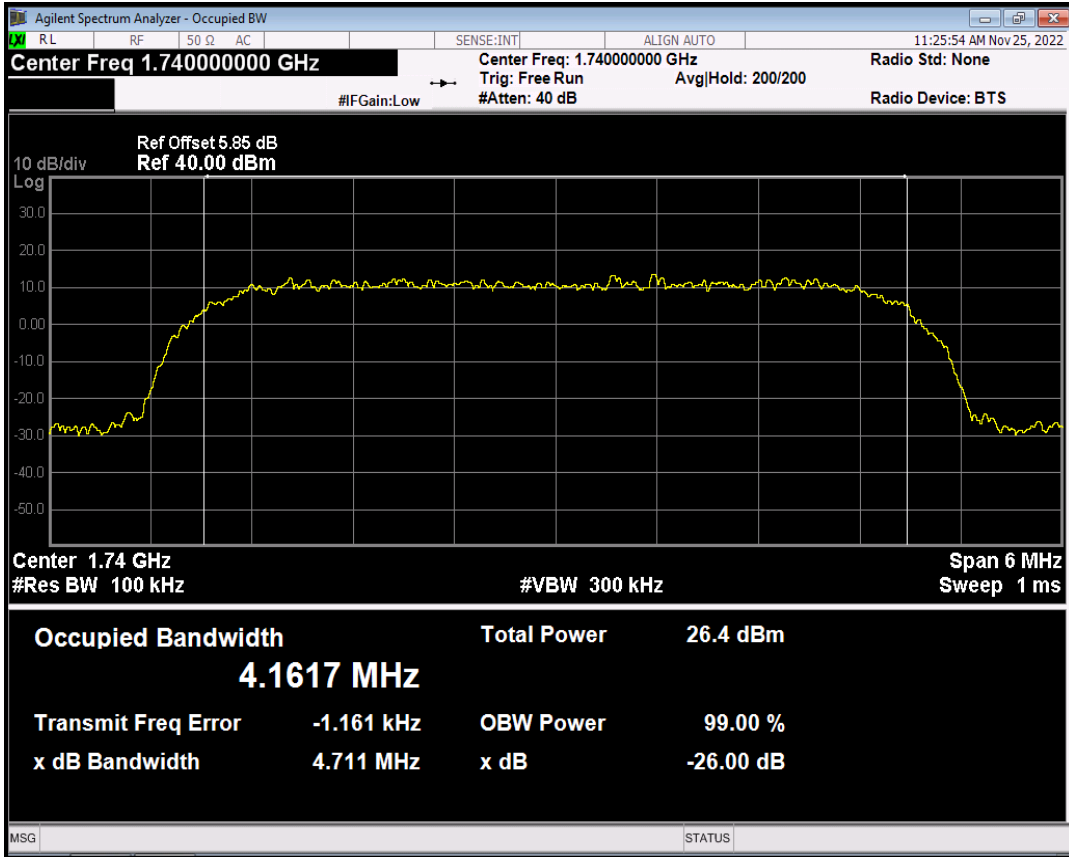

WCDMA Band4 Channel=1513

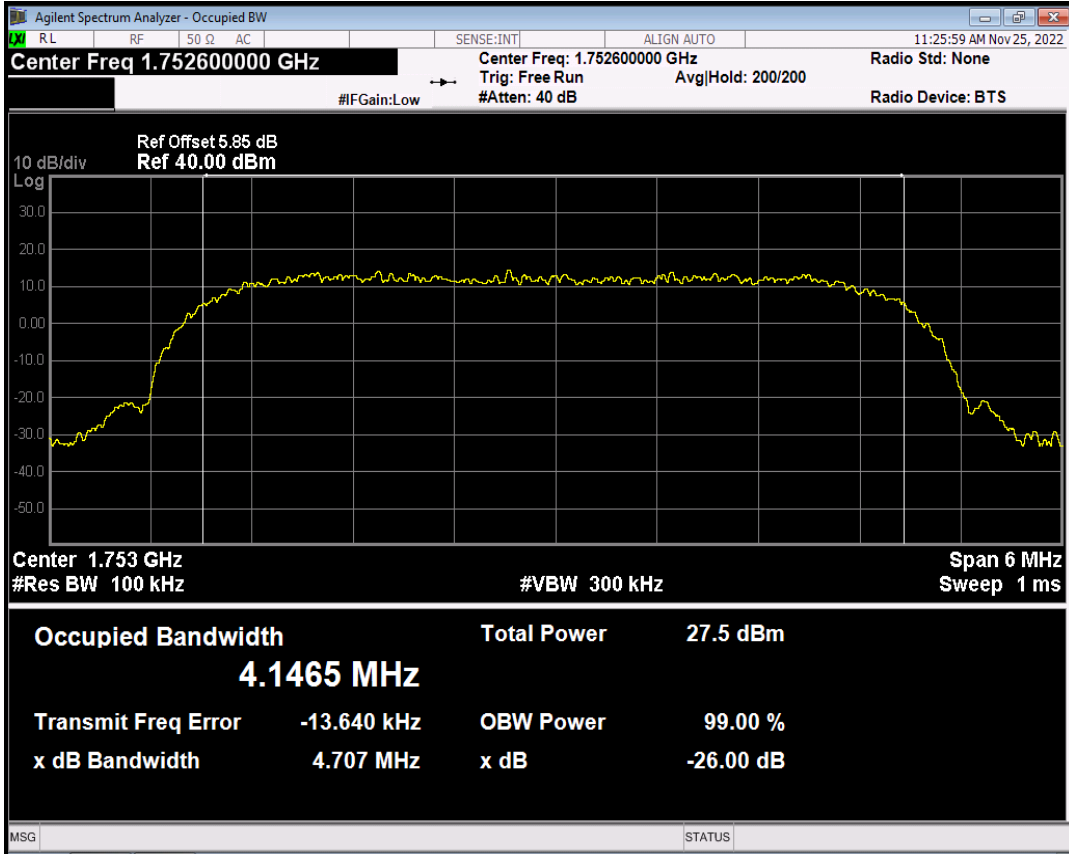

2017