

OUKITEL

# K7 Pro

Thanks for choosing OUKITEL products



## Overview

---

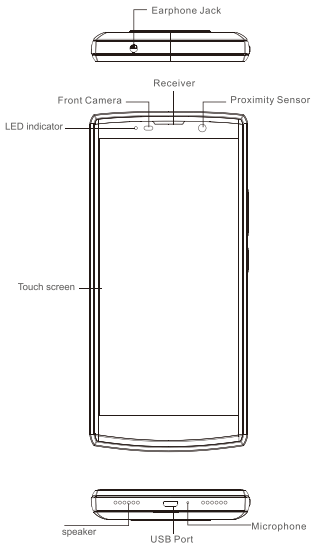

## Overview

---

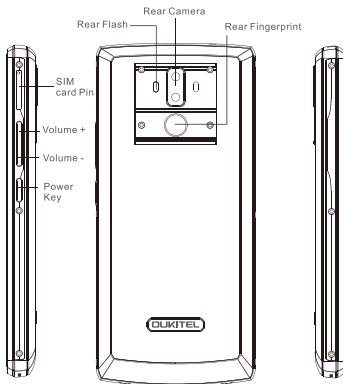

## Accessories

---

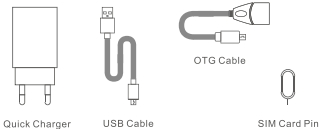

## Battery

---

K7 Pro is included an internal battery.

You can track your battery status with the icon showed on the top right of the screen. As microwave ovens, stoves, or radiators, batteries may explode when overheated.

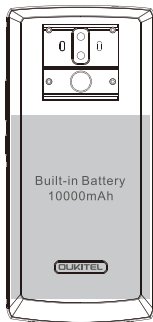

## Warning

- Use only OUKITEL-approved batteries specifically designed for your phone. Incompatible batteries can cause serious injuries or damage to your phone.
- Never place batteries or phones on or in heating devices, such as microwave ovens, stoves, or radiators. Batteries may explode when overheated.

## Overview

---

### Basic parameters

---

Display:	6.0" HD IPS Touchscreen
Color:	Black
Operating system:	Android™ 9 Pie
Processor:	4xCortex-A53 up to 2.0Ghz/4xCortex-A53 up to 1.5Ghz
GPU:	ARM Mali-G71 MP2 Up to 700Mhz
RAM:	4 GB
ROM:	64GB/64GB (Expandable UP to 64GB)
Battery:	10000mAh, 9V/2A quick charge

### Camera

---

#### Rear Camera

13.0MP main camera  
F/2.0  
LED Flash

#### Front Camera

5.0MP, 130 wide angle  
Group Mode

### Connection (I/O)

---

2G: 850/900/1800/1900

3G: 1/2/4/5/8

TDD:38/39/40/41M

FDD :1/2/3/4/5/7/8/19/26/12/17/20

SIM Card Slot: Dual SIM , Nano+Nano (MicroSD Card Uses SIM CardSlot 2)

FM:87.5 MHz -108 MHz

### Other Features

---

Video: AVI, MP4, WMV, MKV, MOV, ASF, FLV

Audio: FLAC, APE, AAC, MKA, MP3, M4A, AMR, ALAC, WAV

Image: JPEG, BMP, GIF, PNG

### Dimensions

---

Height: 168mm

Width: 78mm

Thickness: 14.5mm

Weight: 300g

### Package contents

---

1\*USB Cable

1\*Charger

1\*SIM Card Pin

1\*OTG Cable

1\*Multi-language Manual

1\*Screen Protector

1\*Phone Case

Comes with the Google™ app and Google Chrome™.

Google, Android and Google Chrome are trademarks of Google LLC.

MANUFACTURER NAME: SHENZHEN YUNJI INTELLIGENT TECHNOLOGY CO.,LTD  
MANUFACTURER ADDRESS: A-SIDE A2 BUILDING 2/F ENET NEW INDUSTRIAL PARK,NO.20  
DAFU INDUSTRIAL ZONE, ADBEI COMMUNITY, GUANLAN, LONGHUA NEW  
DISTRICT,SHENZHEN CHINA

## Visão geral

---

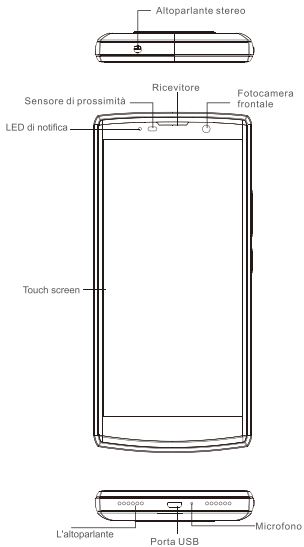

## Visão geral

---

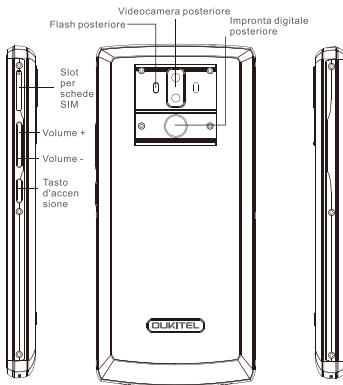

## Accessori

---

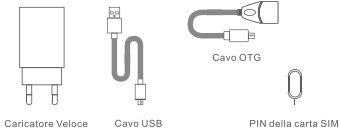



## Batteria

---

K7 Pro è inclusa una batteria interna.

Puoi monitorare lo stato della batteria con l'icona mostrata in alto a destra sullo schermo. Come forni a microonde, stufe o radiatori, le batterie possono esplodere se surriscaldate.

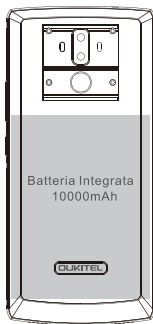

## Avvertimento

- Utilizzare solo batterie approvate da OUKITEL specificamente progettate per il telefono. Le batterie incompatibili possono causare lesioni gravi o danni al telefono.
- Non posizionare mai batterie o telefoni su o in dispositivi di riscaldamento, come forni a microonde, stufe o radiatori. Le batterie possono esplodere se surriscaldate.

## Panoramica

---

### Parametri di Base

---

Monitor:	6.0 "touch screen HD IPS
Colore:	nero
Sistema operativo:	Android™ 9 Pie
Processore:	4xCortex-A53 up to 2.0Ghz/4xCortex-A53 up to 1.5Ghz
GPU:	ARM Mali-G71 MP2 Up to 700Mhz
Memoria:	4 GB
ROM:	64GB/64GB (fino a 64GB)
Batteria:	10000 mAh, carica rapida 9V / 2A

### Telecamera

---

#### Fotocamera posteriore

Fotocamera principale 13.0MP  
F/2.0  
Flash LED

#### Fotocamera frontale

5.0MP, 130 grandangolare

### Connessione (I / O)

---

2G: 850/900/1800/1900

3G: 1/2/4/5/8

TDD:38/39/40/41M

FDD :1/2/3/4/5/7/8/19/26/12/17/20

SIM Card Slot: Dual SIM ,Nano+Nano (MicroSD Card Uses SIM CardSlot 2)

FM:87.5 MHz -108 MHz

### Altre Caratteristiche

---

Video: AVI, MP4, WMV, MKV, MOV, ASF,FLV

Audio: FLAC, APE, AAC, MKA, MP3, M4A, AMR, ALAC, WAV

Immagine: JPEG, BMP, GIF,PNG

### Formato

---

Altezza: 168 mm

Larghezza: 78 mm

Spessore: 14,5 mm

Peso: 300 g

### Imballaggio

---

1 \* Cavo USB

1 \* Manuale multilingue

1 \* Caricabatterie

1 \* Protezione per lo schermo

1 \* PIN della carta SIM

1 \* cassa del telefono

1 \* Cavo OTG

Viene fornito con l'app Google™ e Google Chrome™.

Google, Android e Google Chrome sono marchi di Google LLC.

NOME DEL PRODUTTORE: SHENZHEN YUNJI TECHNOLOGIE INTELLIGENTE CO, LTD

INDIRIZZO DEL PRODUTTORE: A-SIDE A2 BUILDING 2 / F ENET NUOVO PARCO INDUSTRIALE,

NO.20 DAFU INDUSTRIAL ZONE, AOBEI COMMUNITY, GUANLAN, LONGHUA NEW DISTRICT,

SHENZHEN CHINA

## Überblick

---

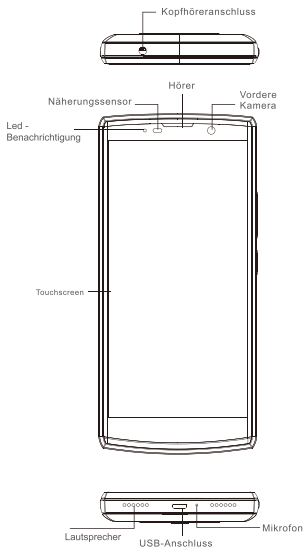

## Überblick

---

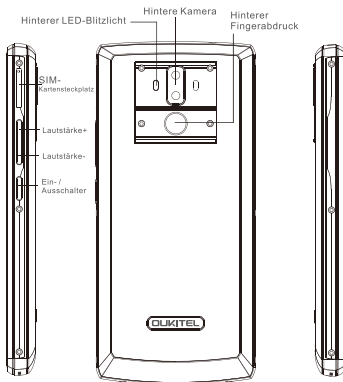

## Zubehör

---

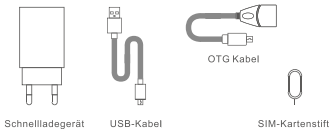

## Akku

---

Das **K7 Pro** enthält einen fest verbauten Akku

Sie können den Ladestatus mit dem Symbol oben rechts auf dem Bildschirm verfolgen. Nicht in der Nähe von Mikrowellen, Öfen oder Heizkörpern aufbewahren, da Akkus bei Überhitzung explodieren können.

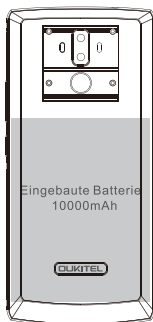

## Warnung

- Verwenden Sie nur durch OUKITEL -zugelassene Akkus, die speziell für Ihr Handy entwickelt wurden. Unverträgliche Akkus können schwere Verletzungen verursachen oder Ihr Telefon beschädigen.
- Legen Sie niemals Akkus oder Telefone auf oder in Heizgeräte, Mikrowellenherde, Öfen oder Heizkörper. Die Akkus können explodieren wenn sie überhitzt werden.

## Überblick

---

### Grundparameter

---

Display:	6.0"HD IPS Touchscreen
Farben:	Schwarz
Betriebssystem:	Android™ 9 Pie
Prozessor:	<b>4xCortex-A53 up to 2.0Ghz/4xCortex-A53 up to 1.5Ghz</b>
GPU:	ARM Mali-G71 MP2 Up to 700Mhz
RAM:	4 GB
ROM:	64GB/64GB (Externer Speicher: TF-Karte bis zu 64GB )
Akku:	10000mAh, 9V/2A Schnellladung

### Kamera

---

#### hintere Kamera

13.0MP Hauptkamera  
F/2.0  
LED-Blitzlicht

#### vordere Kamera

5.0MP,130Weitwinkel  
Gruppen-Modus

### Verbindung

---

2G: 850/900/1800/1900  
3G: 1/2/4/5/8  
TDD:38/39/40/41M  
FDD :1/2/3/4/5/7/8/19/26/12/17/20  
SIM Card Slot: Dual SIM ,Nano+Nano (MicroSD Card Uses SIM CardSlot 2)  
FM:87.5 MHz -108 MHz

### weitere Eigenschaften

---

Video: AVI, MP4, WMV, MKV, MOV, ASF,FLV  
Audio: FLAC, APE, AAC, MKA, MP3, M4A, AMR, ALAC, WAV  
Bild: JPEG, BMP, GIF,PNG

### Abmessungen

---

Länge: 168mm  
Breite: 78mm  
Höhe: 14.5 mm  
Gewicht: 300g

### Packungsinhalt

---

1\*USB-Kabel  
1\*Ladegerät  
1\*SIM-Karten Stift  
1\*OTG Kabel  
1\*mehrsprachiges Handbuch  
1\*Telefonhülle  
1\*Schutzfolie

Kommt mit der Google™ App und Google Chrome™.

Google, Android und Google Chrome sind Marken von Google LLC.

HERSTELLERNAME: SHENZHEN YUNJI INTELLIGENT TECHNOLOGY CO., LTD  
HERSTELLERADRESSE: A-SIDE A2 BUILDING 2 / F ENET NEUER INDUSTRIAL PARK, NO.20 DAFU INDUSTRIAL ZONE, AOBEL COMMUNITY, GUANLAN, LONGHUA NEUES BEZIRK, SHENZHEN CHINA

## Общие сведения

---

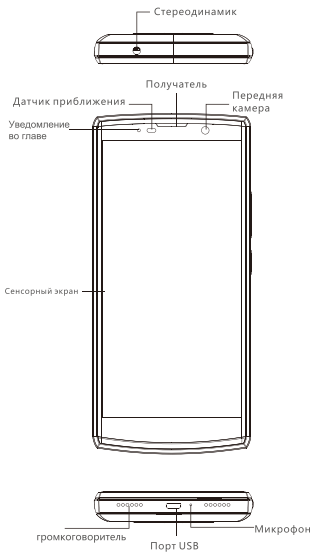

## Общие сведения

---

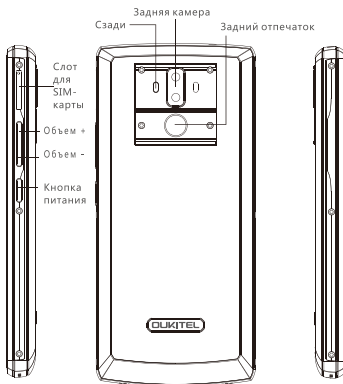

## Аксессуары

---

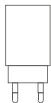

Быстрое зарядное устройство



USB-кабель



Случай телефона



PIN-код SIM-карты



## Батарея

---

В комплект поставки K7 Pro входит литий-ионная аккумуляторная батарея. Вы можете отслеживать состояние батареи с помощью значка, показанного в правом верхнем углу экрана. Вблизи микроволновых печей, кухонных плит или радиаторов, батареи могут взорваться при перегреве.

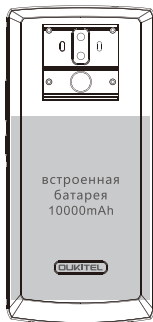

### Предупреждение

- Используйте только одобренные батареи OUKITEL, специально предназначенные для вашего телефона. Несовместимые батареи могут стать причиной серьезных травм или повреждения телефона.
- Никогда не помещайте батареи и телефоны в нагревающие устройства, например, в микроволновые печи, печи или радиаторы. При перегреве батареи могут взорваться.

## Общие сведения

---

### Основные параметры

---

Дисплей:	6.0" Сенсорный экран HD IPS
Цвет:	черный
Операционная система:	Android™ 9 Pie
Процессор:	4xCortex-A53 up to 2.0Ghz/4xCortex-A53 up to 1.5Ghz
GPU:	ARM Mali-G71 MP2 Up to 700Mhz
RAM:	4GB
ROM:	64ГБ (с возможностью расширения до 64 ГБ)
Батарея:	10000mAh , 9V/2A быстрое зарядное устройство

### Камера

---

<b>Задняя камера</b>	<b>Фронтальная камера</b>
13.0MP Основная камера F / 2.2Режим группы СВЕТОДИОДная вспышка	5.0MP 130 широкоугольный

### Связь (Вход/Вывод)

---

2G: 850/900/1800/1900
3G: 1/2/4/5/8
TDD:38/39/40/41M
FDD :1/2/3/4/5/7/8/19/26/12/17/20
Слот для SIM-карт: Две SIM-карты, Nano + Nano (Карта microSD использует слот SIM 2)
FM:87.5 MHz -108 MHz

### Другие особенности

---

Видео:	AVI, MP4, WMV, MKV, MOV, ASF, FLV
Аудио:	FLAC, APE, AAC, MKA, MP3, M4A, AMR, ALAC, WAV
Изображение:	JPEG, BMP, GIF, PNG

### Габаритные размеры

---

Высота:	168мм
Ширина:	78мм
Толщина:	14.5мм
Вес:	300г

### Содержимое пакета

---

1 * USB кабель	1 * Случай телефона
1 * многоязычное руководство	
1 * Зарядное устройство	
1 * Корпус мобильного телефона	
1 * Защитная пленка для экрана	
1 * игла для извлечения SIM карт	

Поставляется с приложением Google™ и Google Chrome™ .  
Google, Android и Google Chrome являются товарными знаками Google LLC.  
Название производителя: ШэньчжэньЮньцзи Интеллектуальные Технологии ООО  
Адрес производителя: A-SIDE A2 BUILDING 2 / F ЕНЕТНОВЫЙ ПРОМЫШЛЕННЫЙ ПАРК, NO.20  
ПРОМЫШЛЕННАЯ ЗОНА DAFU, ОБЩЕСТВО АОВЕИ, ГУАНПАН, НОВЫЙ ОКРУГ ЛОНХУА, ШЭНЬЧЖЭНЬ КИТАЙ

## Descripción

---

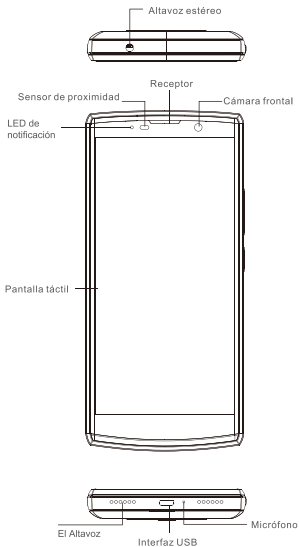

## Descripción

---

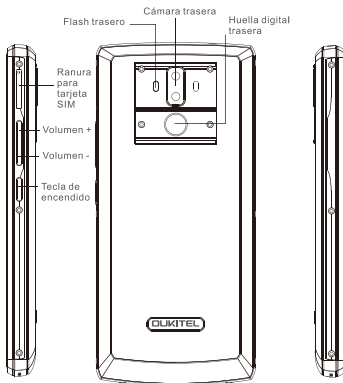

## Accesorios

---

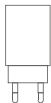

Cargador rápido



Cable USB



Aguja de la tarjeta SIM

## Batería

---

K7 Pro incluye batería interna.

Puede controlar el estado de su batería con el icono que se muestra en la parte superior derecha de la pantalla. Las baterías pueden explotar cuando se sobrecaliente en hornos microondas, estufas o radiadores.

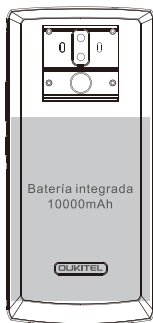

## Advertencia

- Utilice únicamente baterías diseñadas y aprobadas por OUKITEL, si usa baterías incompatibles pueden causar lesiones graves y daños en el teléfono.
- Nunca coloque baterías o teléfonos en o en dispositivos como hornos microondas, estufas o radiadores. Las baterías pueden explotar cuando se sobrecalienta.

## Descripción

---

### Parámetros básicos

---

Pantalla:	Pantalla táctil 6.0 " HD IPS
Color:	negro
Sistema operativo:	Android™9 Pie
Procesador:	4xCortex-A53 up to 2.0Ghz/4xCortex-A53 up to 1.5Ghz
GPU:	ARM Mali-G71 MP2 Up to 700Mhz
Memoria:	4 GB
ROM:	64GB/64GB ( hasta de 64GB)
Batería:	10000mAh, carga rápida 9V / 2A

### Cámara

---

#### Cámara trasera

Cámara principal 13.0MP  
F / 2.0Modo grupal  
Flash LED

#### Cámara frontal

5.0MP,130 gran angular

### Conexión (E / S)

---

2G: 850/900/1800/1900

3G: 1/2/4/5/8

TDD:38/39/40/41M

FDD :1/2/3/4/5/7/8/19/26/12/17/20

Ranura para tarjeta SIM: Dual SIM, Nano + Nano (la tarjeta Micro SD usa en la ranura de tarjeta SIM 2)

FM:87.5 MHz -108 MHz

### Otras características

---

Video: AVI, MP4, WMV, MKV, MOV, ASF, FLV

Audio: FLAC, APE, AAC, MKA, MP3, M4A, AMR, ALAC, WAV

Imagen: JPEG, BMP, GIF, PNG

### Tamaño

---

Longitud: 168 mm

Ancho: 78 mm

Espesor: 14.5mm

Peso: 300 g

### Empaque

---

1 \* Cable USB

1 \* Cargador

1 \* Aguja de la tarjeta SIM

1 \* Cable OTG

1 \* Manual multilingüe

1 \* Protector de pantalla

1 \* Funda del teléfono

Viene con la aplicación de Google™ y Google Chrome™.

Google, Android y Google Chrome son marcas comerciales de Google LLC.

NOMBRE DEL FABRICANTE: SHENZHEN YUNJI INTELLIGENT TECHNOLOGY CO., LTD

DIRECCIÓN DEL FABRICANTE: A-SIDE CONSTRUCCIÓN A2 2 / nuevo parque F ENET INDUSTRIAL, NO.20 Dafu INDUSTRIAL ZONE, Aobei COMUNIDAD, Guanlan, LONGHUA nuevo distrito, SHENZHEN CHINA

## Aperçu

---

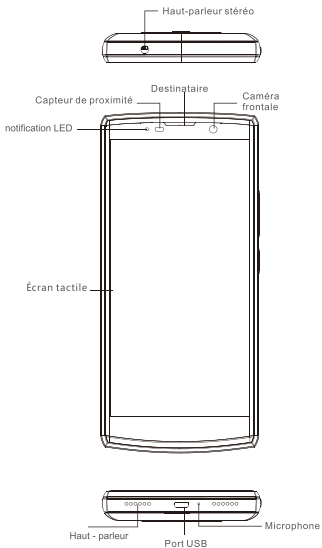

## Aperçu

---

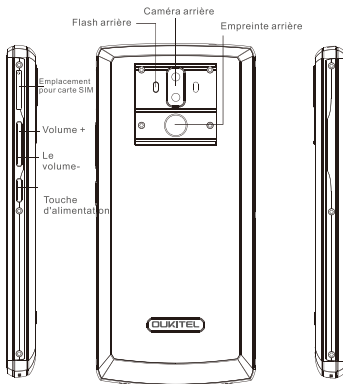

## Accessories

---

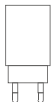

Chargeur Rapide



Câble USB



Câble OTG



PIN de la carte SIM



## Batteries

---

K7 Pro est inclus une batterie interne.

Vous pouvez suivre l'état de votre batterie avec l'icône affichée en haut à droite de l'écran. Comme four à micro-ondes, cuisinières ou radiateurs, les batteries peuvent exploser lorsqu'elles sont surchauffées.

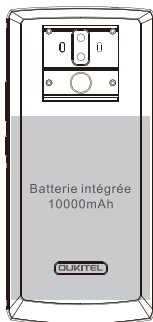

### Attention

- Utilisez uniquement des batteries approuvées par OUKITEL spécialement conçues pour ton téléphone. Les batteries incompatibles peuvent causer des blessures graves ou dommage sur votre téléphone.
- Ne placez jamais les piles ou les téléphones sur ou dans des appareils de chauffage, comme four à micro-ondes, cuisinières ou radiateurs. Les batteries peuvent exploser lorsqu'il est surchauffé.

## Aperçu

---

### Paramètres de base

---

Affichage:	Ecran tactile IPS HD 6.0"
Couleur:	Noir
Système d'exploitation:	Android™ 9 Pie
Processeur:	4xCortex-A53 up to 2.0Ghz/4xCortex-A53 up to 1.5Ghz
GPU:	ARM Mali-G71 MP2 Up to 700Mhz
RAM:	4 GB
ROM:	64GB/64GB (Extension jusqu'à 64GB)
Batterie:	10000mAh, chargeur rapide 9V/2A

### Caméra

---

#### Caméra arrière

Caméra principale 13.0MP  
F/2.0  
Flash LED

#### Caméra frontale

5.0MP, grand angle 130°  
Mode Groupe

### Connexion(I/O)

---

2G: 850/900/1800/1900

3G: 1/2/4/5/8

TDD:38/39/40/41M

FDD :1/2/3/4/5/7/8/19/26/12/17/20

Slot de la Carte SIM: Double SIM ,Nano+Nano (Carte MicroSD Utilise le Slot 2 de Carte SIM)

FM:87.5 MHz -108 MHz

### Autres caractéristiques

---

Vidéo: AVI, MP4, WMV, MKV, MOV, ASF, FLV

Audio: FLAC, APE, AAC, MKA, MP3, M4A, AMR, ALAC, WAV

Image: JPEG, BMP, GIF, PNG

### Dimensions

---

Hauteur: 168mm

Largeur: 78mm

Épaisseur: 14.5mm

Poids: 300g

### Contenu du colis

---

1\*Câble USB

1\*Chargeur

1\*Pin de Carte SIM

1\*Câble OTG

1\*Manuel en multi-langage

1\*Protection d'Écran

1\*Coque de Téléphone

Livré avec l'application Google™ et Google Chrome™.

Google, Android et Google Chrome sont des marques commerciales de Google LLC.

NOM DU FABRICANT: SHENZHEN YUNJI TECHNOLOGIE INTELLIGENTE CO, LTD  
ADRESSE DU FABRICANT: NOUVEAU PARC INDUSTRIEL A2 / F ENET A2, FACE AU ZONE INDUSTRIELLE NO.20, COMMUNAUTÉ AOEI, GUANLAN, NOUVEAU DISTRICT DE LONGHUA, SHENZHEN CHINA

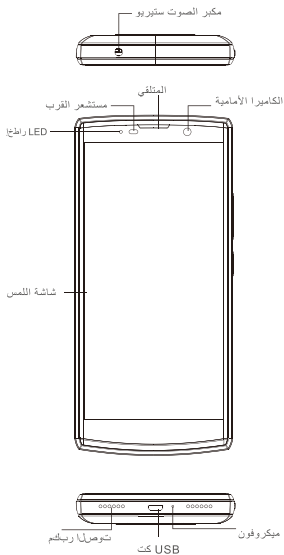

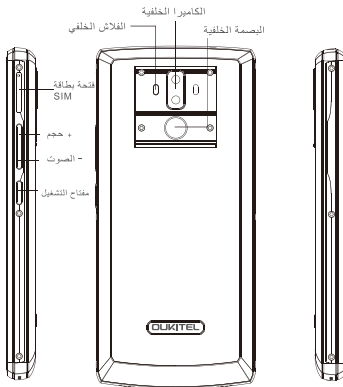

الملحقات

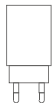

شاحن سريع



نوع USB



كابل نقل السماعة



SIM رقم التعريف الشخصي لبطاقة

## البطارية

Pro K7 يحتوي على بطارية داخلية  
بمكثف فحملة بطاريته من خلال الأيونات المعروضة في الجزء العلوي  
الأمين من الشاشة، كما هو الحال في أفران الميكروويف والمواقد والمشعات،  
يمكن أن تنفجر البطاقة عن زيادة حرارتها.



### تحذير:

- استخدام فقط البطاريات المعتمدة من دوجي المصممة خصيصاً  
هاتفك. يمكن أن تسبب البطاريات غير المتوافقة إصابات خطيرة  
أو ضرراً بهاتفك.
- لا تضع البطاريات أو الهواتف على أجهزة تسخين، مثل  
أفران الميكروويف أو المواقد أو المشعات. يمكن أن تنفجر البطارية  
عند زيادة حرارتها.

## لمحة عامة

### المواصفات الأساسية

الشاشة:	FH IPS touchscreen" 6.0
الألوان:	أسود
نظام التشغيل:	Android™ 9 Pie
المعالج:	4xCortex-A53 up to 2.0Ghz/4xCortex-A53 up to 1.5Ghz
وحدة معالجة الرسومات:	ARM Mali-G71 MP2 Up to 700Mhz
الذاكرة العشوائية:	4 غيغابايت
ذاكرة للقرن:	64 جيجابايت / 64 جيجابايت ROM ( قابلة للتوسيع حتى 64 جيجابايت )
البطارية:	10000mAh 9V/2A شحمة سريعة

### الكاميرا

كاميرا خلفية	كاميرا أمامية
MP13.0 الكاميرا الرئيسية	MP5.0
F/2.0	
فلاش LED	

### التوصيل (I/O)

2G:	850/900/1800/1900 ميغاهرتز
3G:	1/2/4/5/8 ميغاهرتز
TDD:	38/39/40/41M
FDD:	1/2/3/4/5/7/8/19/26/12/17/20
فتحة بطاقة الـsim:	Nano + Nano ، الاتصال بشرايح تنافس
(SIM 2)	بطاقة فتحة تستخدم Micro SD بطاقة)
FM:	87.5 MHz - 108 MHz

### مميزات أخرى

مشغل الفيديو:	AVI, MP4, WMV, MKV, MOV, ASF, FLV
الصوت:	FLAC, APE, AAC, MKA, MP3, M4A, AMR, ALAC, WAV
الصور:	JPEG, BMP, GIF, PNG

### الأبعاد

الارتفاع: 168 ملم	*1 كابل	USB* 1 بدوي متعدد اللغات
العرض: 78 ملم	*1 حالة الهاتف	* 1 بطاقة SIM دبوس
السُمك: 14.5 ملم	*1 كابل وتغ	*1 شاحن
الوزن: 300 غم	*1 اللغات متعدد دليل	

Google™ Chrome و Google™ آي. مع تطبيق

Google LLC. علامات تجارية لشركة Google Chrome و Android و Google تعد

قدودجوليا أي جولدونكتاليا Yunji نشترنش

التكنولوجيا الذكية المحدودة Yunji شتتن

نشرتنش ، ناب ، تانجوع التريوم ، كوراليماريا ولفا الققدم ، المودجلا كوراليماريا دولجك رواب ولفا نوكولوس جوج ، A2 وشحما ، ووا 2/

مجمع سيليكون قالي باور للمواد الصناعية الجديدة ، منطقة دافو الصناعية ، مدينة جوانلان ، باوان ، شنتشن ، A2 ووا ، المسمى 2/

## 概要

---

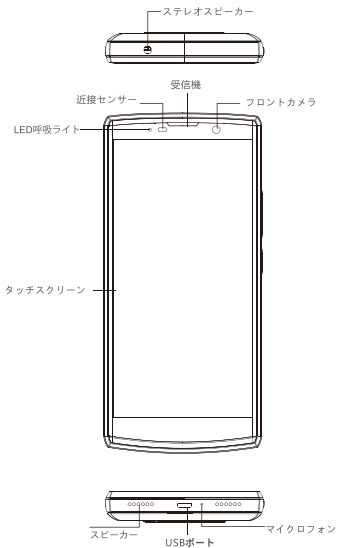

## 概要

---

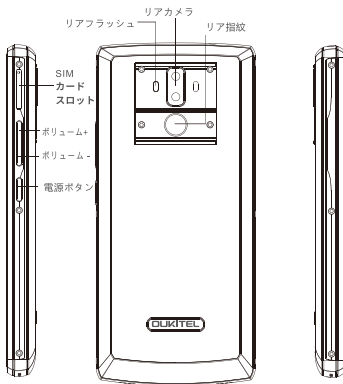

## アクセサリ

---

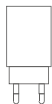

高速充電器



USBケーブル



OTGケーブル



SIMカードPIN



## バッテリー

---

K7 Pro は内蔵バッテリーが付属しています。画面の右上に表示されているアイコンを使ってバッテリーの状態を追跡することができます。電子レンジやストーブなどで電池を加熱すると爆発することがあり危険なのでやめてください。



### 警告

- oukitel 専用バッテリー以外は使用しないでください。熱くなる場所にバッテリーやスマホ本体を決して置かないで下さい。電子レンジやストーブなどで電池を加熱すると爆発することがあり危険なのでやめてください。

## 概要

---

### 基本データ

---

ディスプレイ:	6.0型HD IPSタッチスクリーン
カラー:	ブラック
OS:	Android™ 9 Pie
プロセッサ:	4xCortex-A53 up to 2.0Ghz/4xCortex-A53 up to 1.5Ghz
GPU:	ARM Mali-G71 MP2 Up to 700Mhz
RAM:	4 GB
ROM:	64GB/64GB ( 64GBまで拡張可能)
バッテリー:	10000mAh、9V / 2A高速充電

### カメラ

---

#### リアカメラ

メインカメラ13.0MP  
F/2.0グループモード  
LEDフラッシュ

#### フロントカメラ

5.0MP、130広角

### 接続 (I/O)

---

2G: 850/900/1800/1900

3G: 1/2/4/5/8

TDD:38/39/40/41M

FDD :1/2/3/4/5/7/8/19/26/12/17/20

SIMカードスロット: デュアルSIM、ナノ+ナノ ( マイクロSDカードはSIMカードスロット2を使用 )

FM:87.5 MHz -108 MHz

### その他の機能

---

ビデオ: AVI, MP4, WMV, MKV, MOV, ASF, FLV

オーディオ: FLAC, APE, AAC, MKA, MP3, M4A, AMR, ALAC, WAV

画像: JPEG, BMP, GIF, PNG

### 寸法

---

高さ: 168mm

幅: 78 mm

厚さ: 14.5mm

重量: 300g

### パッケージ内容

---

1\*USBケーブル

1\*充電器

1\*SIMカードのピン

1\*OTGケーブル

1\*多言語マニュアル

1\*スクリーンセーバー

1\*モバイルシエル

Google™ アプリとGoogle™ Chromeが付属しています。

Google Android Google ChromeはGoogle LLCの商標です。

製造業者名: シンセンユンジーインテリジェントテクノロジー株式会社

製造元アドレス: A個A2ビル2/F新工業団地、第二十大府工業地帯、青梅コミュニティ、広東省、龍華新区、深セン中国

Manufacturer's Name: OUKITEL

Smart phone

Model number: K7 Pro

Operating Temperature: -10° C to 40° C

This device was tested for typical body-worn operations. To comply with RF exposure requirements, a minimum separation distance of 0mm must be maintained between the user's body and the handset, including the antenna. Third-party belt-clips, holsters, and similar accessories used by this device should not contain any metallic components. Body-worn accessories that do not meet these requirements may not comply with RF exposure requirements and should be avoided. Use only the supplied or an approved antenna.

This device in compliance with the essential requirements and other relevant provisions of Directive 2014/53/EU. All essential radio test suites have been carried out.

1. Use careful with the earphone maybe possible excessive sound pressure from earphones and headphones can cause hearing loss.

2. CAUTION : RISK OF EXPLOSION IF BATTERY IS REPLACED BY AN INCORRECT TYPE. DISPOSE OF USED BATTERIES ACCORDING TO THE INSTRUCTIONS

3. The product shall only be connected to a USB interface of version USB 2.0

4. Adapter shall be installed near the equipment and shall be easily accessible.

5. The plug considered as disconnect device of adapter

6. The device complies with RF specifications when the device used at 0mm from your body

Add the legal line - Android is a trademark of Google LLC.

**15.19 Labeling requirements.**

This device complies with part 15 of the FCC Rules. Operation is subject to the following two conditions: (1) This device may not cause harmful interference, and (2) this device must accept any interference received, including interference that may cause undesired operation.

**15.21 Information to user.**

Any Changes or modifications not expressly approved by the party responsible for compliance could void the user's authority to operate the equipment.

**15.105 Information to the user.**

Note: This equipment has been tested and found to comply with the limits for a Class B digital device, pursuant to part 15 of the FCC Rules. These limits are designed to provide reasonable protection against harmful interference in a residential installation. This equipment generates uses and can radiate radio frequency energy and, if not installed and used in accordance with the instructions, may cause harmful interference to radio communications. However, there is no guarantee that interference will not occur in a particular installation. If this equipment does cause harmful interference to radio or television reception, which can be determined by turning the equipment off and on, the user is encouraged to try to correct the interference by one or more of the following measures:

- Reorient or relocate the receiving antenna.
- Increase the separation between the equipment and receiver.
- Connect the equipment into an outlet on a circuit different from that to which the receiver is connected.
- Consult the dealer or an experienced radio/TV technician for help.

**Absorption Rate (SAR) information:**

This mobile phone meets the government's requirements for exposure to radio waves. The guidelines are based on standards that were developed by independent scientific organizations through periodic and thorough evaluation of scientific studies. The standards include a substantial safety margin designed to assure the safety of all persons regardless of age or health.

FCC RF Exposure Information and Statement The SAR limit of USA (FCC) is 1.6 W/kg averaged over one gram of tissue. This device was tested for typical body-worn operations with the back of the handset kept 1.0cm from the body. To maintain compliance with FCC RF exposure requirements, use accessories that maintain a 1.0cm separation distance between the user's body and the back of the handset. The use of belt clips, holsters and similar accessories should not contain metallic components in its assembly. The use of accessories that do not satisfy these requirements may not comply with FCC RF exposure requirements, and should be avoided.

**Body-worn Operation**

This device was tested for typical body-worn operations. To comply with RF exposure requirements, a minimum separation distance of 1.0 cm must be maintained between the user's body and the handset, including the antenna. Third-party belt-clips, holsters, and similar accessories used by this device should not contain any metallic components. Body-worn accessories that do not meet these requirements may not comply with RF exposure requirements and should be avoided. Use only the supplied or an approved antenna.

**FCC ID: 2ANMU-K7PRO**



[www.oukitel.com](http://www.oukitel.com)

CE RoHS 