

# FCC SAR EVALUATION REPORT

In accordance with the requirements of  
FCC 47 CFR Part 2(2.1093), ANSI/IEEE C95.1-1992 and  
IEEE Std 1528-2013

**Product Name :** Smart Phone

**Trademark :** OUKITEL

**Model Name :** K13 Pro

**Family Model :** N/A

**Report No. :** S19061203412001

**FCC ID :** 2ANMU-K13PRO

**Prepared for**

SHENZHEN YUNJI INTELLIGENT TECHNOLOGY CO.,LTD  
A-SIDE A2 BUILDING 2/F ENET NEW INDUSTRIAL PARK,NO.20 DAFU  
INDUSTRIAL ZONE, AOBEI COMMUNITY, GUANLAN, LONGHUA NEW  
DISTRICT,SHENZHEN CHINA

**Prepared by**

Shenzhen NTEK Testing Technology Co., Ltd.  
1/F, Building E, Fenda Science Park Sanwei, Xixiang, Bao'an District,  
Shenzhen, Guangdong, China  
Tel.: +86-755-6115 6588 Fax.: +86-755-6115 6599  
Website: <http://www.ntek.org.cn>

## TEST RESULT CERTIFICATION

**Applicant's name**.....: SHENZHEN YUNJI INTELLIGENT TECHNOLOGY CO.,LTD  
A-SIDE A2 BUILDING 2/F ENET NEW INDUSTRIAL PARK,NO.20  
**Address**.....: DAFU INDUSTRIAL ZONE, AOBEI COMMUNITY, GUANLAN,  
LONGHUA NEW DISTRICT,SHENZHEN CHINA

**Manufacturer's Name**.....: SHENZHEN YUNJI INTELLIGENT TECHNOLOGY CO.,LTD  
A-SIDE A2 BUILDING 2/F ENET NEW INDUSTRIAL PARK,NO.20  
**Address**.....: DAFU INDUSTRIAL ZONE, AOBEI COMMUNITY, GUANLAN,  
LONGHUA NEW DISTRICT,SHENZHEN CHINA

**Product description**

**Product name**.....: Smart Phone  
**Trademark** .....: OUKITEL  
**Model Name** .....: K13 Pro  
**Family Model**.....: N/A

**Standards**.....: FCC 47 CFR Part 2(2.1093); ANSI/IEEE C95.1-1992  
IEEE Std 1528-2013; Published RF exposure KDB procedures

This device described above has been tested by Shenzhen NTEK. In accordance with the measurement methods and procedures specified in IEEE Std 1528-2013 and KDB 865664 D01. Testing has shown that this device is capable of compliance with localized specific absorption rate (SAR) specified in FCC 47 CFR Part 2(2.1093) and ANSI/IEEE C95.1-1992. The test results in this report apply only to the tested sample of the stated device/equipment. Other similar device/equipment will not necessarily produce the same results due to production tolerance and measurement uncertainties.

This report shall not be reproduced except in full, without the written approval of Shenzhen NTEK, this document may be altered or revised by Shenzhen NTEK, personal only, and shall be noted in the revision of the document.

**Date of Test**

**Date (s) of performance of tests**.....: Jul. 13, 2019 ~ Jul. 20, 2019  
**Date of Issue** .....: Jul. 29, 2019  
**Test Result** .....: **Pass**

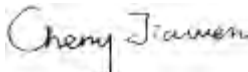
Prepared By :   
(Test Engineer) : \_\_\_\_\_  
(Cheng Jiawen)

Approved By :   
(Lab Manager) : \_\_\_\_\_  
(Sam Chen)

※ ※ Revision History ※ ※

REV.	DESCRIPTION	ISSUED DATE	REMARK
Rev.1.0	Initial Test Report Release	Jul. 29, 2019	Cheng Jiawen

## TABLE OF CONTENTS

1. General Information .....	6
1.1. RF exposure limits.....	6
1.2. Statement of Compliance .....	7
1.3. EUT Description .....	7
1.4. Test specification(s) .....	10
1.5. Ambient Condition.....	10
2. SAR Measurement System .....	11
2.1. SATIMO SAR Measurement Set-up Diagram .....	11
2.2. Robot .....	12
2.3. E-Field Probe.....	13
2.3.1. E-Field Probe Calibration .....	13
2.4. SAM phantoms .....	14
2.4.1. Technical Data .....	15
2.5. Device Holder .....	16
2.6. Test Equipment List .....	17
3. SAR Measurement Procedures .....	19
3.1. Power Reference .....	19
3.2. Area scan & Zoom scan.....	19
3.3. Description of interpolation/extrapolation scheme .....	21
3.4. Volumetric Scan .....	21
3.5. Power Drift .....	21
4. System Verification Procedure .....	22
4.1. Tissue Verification .....	22
4.1.1. Tissue Dielectric Parameter Check Results .....	23
4.2. System Verification Procedure .....	24
4.2.1. System Verification Results .....	25
5. SAR Measurement variability and uncertainty .....	26
5.1. SAR measurement variability .....	26
5.2. SAR measurement uncertainty .....	26
6. RF Exposure Positions .....	27
6.1. Ear and handset reference point .....	27
6.2. Definition of the cheek position .....	27
6.3. Definition of the tilt position .....	29
6.4. Body Worn Accessory .....	29
6.5. Wireless Router Devices .....	30
7. RF Output Power .....	31
7.1. GSM Conducted Power .....	31
7.2. WCDMA Conducted Power .....	31
7.3. LTE Conducted Power .....	33

7.4. WLAN & Bluetooth Output Power .....	45
7.4.1. Output Power Results Of WLAN .....	45
7.4.2. Output Power Results Of Bluetooth.....	45
8. Antenna Location.....	46
9. Stand-alone SAR test exclusion.....	47
10. SAR Results .....	48
10.1. SAR measurement results .....	48
10.1.1. SAR measurement Result of GSM850.....	48
10.1.2. SAR measurement Result of GSM1900.....	48
10.1.3. SAR measurement Result of WCDMA Band V.....	49
10.1.4. SAR measurement Result of WCDMA Band IV.....	50
10.1.5. SAR measurement Result of WCDMA Band II.....	51
10.1.6. SAR measurement Result of LTE Band XII .....	52
10.1.7. SAR measurement Result of LTE Band XVII.....	54
10.1.8. SAR measurement Result of LTE Band V .....	55
10.1.9. SAR measurement Result of LTE Band IV .....	57
10.1.10. SAR measurement Result of LTE Band II .....	60
10.1.11. SAR measurement Result of LTE Band VII.....	62
10.1.12. SAR measurement Result of WLAN 2.4G .....	64
10.2. SAR Summation Scenario.....	64
11. Appendix A. Photo documentation .....	74
12. Appendix B. System Check Plots.....	74
13. Appendix C. Plots of High SAR Measurement.....	99
14. Appendix D. Calibration Certificate .....	148

## 1. General Information

### 1.1. RF exposure limits

(A).Limits for Occupational/Controlled Exposure (W/kg)

Whole-Body	Partial-Body	Hands, Wrists, Feet and Ankles
0.4	8.0	20.0

(B).Limits for General Population/Uncontrolled Exposure (W/kg)

Whole-Body	Partial-Body	Hands, Wrists, Feet and Ankles
0.08	1.6	4.0

NOTE: **Whole-Body SAR** is averaged over the entire body, **partial-body SAR** is averaged over any 1 gram of tissue defined as a tissue volume in the shape of a cube. **SAR for hands, wrists, feet and ankles** is averaged over any 10 grams of tissue defined as a tissue volume in the shape of a cube.

#### **Occupational/Controlled Environments:**

Are defined as locations where there is exposure that may be incurred by people who are aware of the potential for exposure, (i.e. as a result of employment or occupation).

#### **General Population/Uncontrolled Environments:**

Are defined as locations where there is the exposure of individuals who have no knowledge or control of their exposure.

NOTE  
 HEAD AND TRUNK LIMIT  
 1.6 W/kg  
 APPLIED TO THIS EUT

**1.2. Statement of Compliance**

The maximum results of Specific Absorption Rate (SAR) found during testing for K13 Pro are as follows.

Band	Max Reported SAR Value(W/kg)			Max Simultaneous Tx
	1-g Head	1-g Body-Worn (Separation distance of 10mm)	1-g Hotspot (Separation distance of 10mm)	
GSM 850	0.143	0.309	0.309	1.399
GSM 1900	0.114	0.686	0.777	
WCDMA Band V	0.079	0.200	0.200	
WCDMA Band IV	0.228	1.166	1.166	
WCDMA Band II	0.159	0.886	1.176	
LTE Band V	0.063	0.225	0.225	
LTE Band IV	0.194	1.083	1.083	
LTE Band II	0.131	0.845	1.019	
LTE Band VII	0.085	0.591	0.591	
LTE Band XII	0.052	0.090	0.090	
LTE Band XVII	0.063	0.092	0.092	
WLAN 2.4G	0.295	0.233	0.233	

Note: The Max Simultaneous Tx is calculated based on the same configuration and test position. This device is in compliance with Specific Absorption Rate (SAR) for general population/uncontrolled exposure limits (1.6 W/kg) specified in FCC 47 CFR Part 2(2.1093) and ANSI/IEEE C95.1-1992, and had been tested in accordance with the measurement methods and procedures specified in IEEE Std 1528-2013 & KDB 865664 D01.

**1.3. EUT Description**

Device Information	
Product Name	Smart Phone
Trade Name	OUKITEL
Model Name	K13 Pro
Family Model	N/A
FCC ID	2ANMU-K13PRO
Device Phase	Identical Prototype
Exposure Category	General population / Uncontrolled environment
Antenna	FPC Antenna
Battery Information	DC 3.85V, 10100mAh
Device Operating Configurations	
Supporting Mode(s)	GSM 850/1900, WCDMA Band V/IV/II, LTE Band

	V/IV/II/VII/XII/XVII, WLAN 2.4G, Bluetooth, NFC		
Test Modulation	GSM(GMSK/8PSK), WCDMA(QPSK), LTE(QPSK/16QAM), WLAN(DSSSS/OFDM), Bluetooth(GFSK, $\pi/4$ -DQPSK, 8DPSK), NFC(ASK)		
Device Class	B		
Operating Frequency Range(s)	Band	Tx (MHz)	Rx (MHz)
	GSM 850	824-849	869-894
	GSM 1900	1850-1910	1930-1990
	WCDMA Band V	824-849	869-894
	WCDMA Band IV	1710-1755	2110-2155
	WCDMA Band II	1850-1910	1930-1990
	LTE Band V	824-849	869-894
	LTE Band IV	1710-1755	2110-2155
	LTE Band II	1850-1910	1930-1990
	LTE Band VII	2500-2570	2620-2690
	LTE Band XII	699-716	729-746
	LTE Band XVII	777-787	746-756
	WLAN 2.4G	2412-2462	
	Bluetooth	2402-2480	
NFC	13.56		
GPRS Multislot Class(12)	Max Number of Timeslots in Uplink		4
	Max Number of Timeslots in Downlink		4
	Max Total Timeslot		5
EDGE Multislot Class(12)	Max Number of Timeslots in Uplink		4
	Max Number of Timeslots in Downlink		4
	Max Total Timeslot		5
Power Class	4, tested with power level 5(GSM 850)		
	1, tested with power level 0(GSM 1900)		
	3, tested with power control "all 1"(WCDMA Band V)		
	3, tested with power control "all 1"(WCDMA Band IV)		
	3, tested with power control "all 1"(WCDMA Band II)		
	3, tested with power control all Max.(LTE Band V)		
	3, tested with power control all Max.(LTE Band IV)		
	3, tested with power control all Max.(LTE Band II)		
	3, tested with power control all Max.(LTE Band VII)		
	3, tested with power control all Max.(LTE Band XII)		
	3, tested with power control all Max.(LTE Band XVII)		
Test Channels (low-mid-high)	128-189-251(GSM 850)		
	512-661-810(GSM 1900)		
	4132-4182-4233(WCDMA Band V)		



1312-1413-1513(WCDMA Band IV)
9262-9400-9538(WCDMA Band II)
20407-20525-20643(LTE Band V BW=1.4MHz)
20415-20525-20635(LTE Band V BW=3MHz)
20425-20525-20625(LTE Band V BW=5MHz)
20450-20525-20600(LTE Band V BW=10MHz)
19957-20175-20393(LTE Band IV BW=1.4MHz)
19965-20175-20385(LTE Band IV BW=3MHz)
19975-20175-20375(LTE Band IV BW=5MHz)
20000-20175-20350(LTE Band IV BW=10MHz)
20025-20175-20325(LTE Band IV BW=15MHz)
20050-20175-20300(LTE Band IV BW=20MHz)
18607-18900-19193(LTE Band II BW=1.4MHz)
18615-18900-19185(LTE Band II BW=3MHz)
18625-18900-19175(LTE Band II BW=5MHz)
18650-18900-19150(LTE Band II BW=10MHz)
18675-18900-19125(LTE Band II BW=15MHz)
18700-18900-19100(LTE Band II BW=20MHz)
20775-21100-21425(LTE Band VII BW=5MHz)
20800-21100-21400(LTE Band VII BW=10MHz)
20825-21100-21375(LTE Band VII BW=15MHz)
20850-21100-21350(LTE Band VII BW=20MHz)
23017-23095-23173 (LTE Band XII BW=1.4MHz)
23025-23095-23165 (LTE Band XII BW=3MHz)
23035-23095-23155 (LTE Band XII BW=5MHz)
23060-23095-23130 (LTE Band XII BW=10MHz)
23755-23790-23825(LTE Band XVII BW=5MHz)
23780-23790-23800(LTE Band XVII BW=10MHz)
1-3-6-9-11(WLAN 2.4G)

**1.4. Test specification(s)**

FCC 47 CFR Part 2(2.1093)
ANSI/IEEE C95.1-1992
IEEE Std 1528-2013
KDB 865664 D01 SAR measurement 100 MHz to 6 GHz
KDB 865664 D02 RF Exposure Reporting
KDB 447498 D01 General RF Exposure Guidance
KDB 248227 D01 802.11 Wi-Fi SAR
KDB 941225 D01 3G SAR Procedures
KDB 941225 D05 SAR for LTE Devices
KDB 941225 D06 Hotspot SAR
KDB 648474 D04 Handset SAR

**1.5. Ambient Condition**

Ambient temperature	20°C – 24°C
Relative Humidity	30% – 70%

## 2. SAR Measurement System

### 2.1. SATIMO SAR Measurement Set-up Diagram

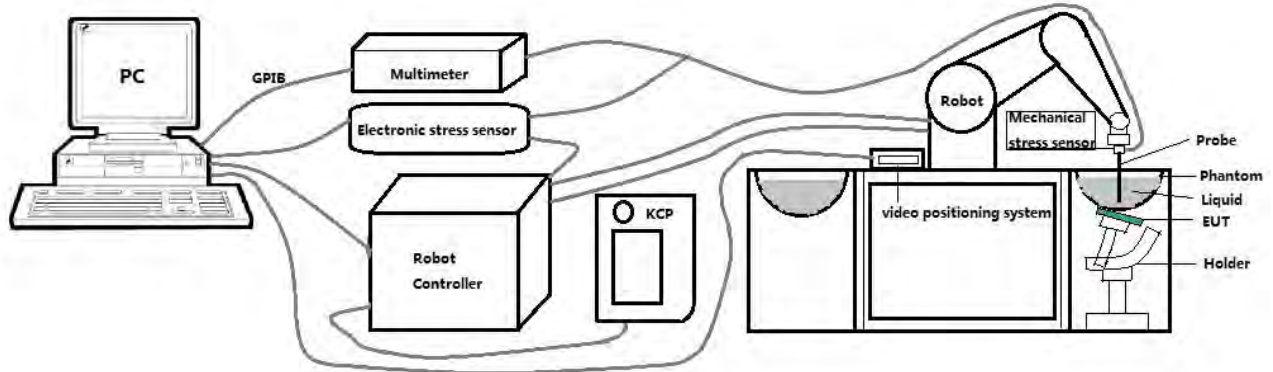

These measurements were performed with the automated near-field scanning system OPENSAR from SATIMO. The system is based on a high precision robot (working range: 901 mm), which positions the probes with a positional repeatability of better than  $\pm 0.03$  mm. The SAR measurements were conducted with dosimetric probe (manufactured by SATIMO), designed in the classical triangular configuration and optimized for dosimetric evaluation.

The first step of the field measurement is the evaluation of the voltages induced on the probe by the device under test. Probe diode detectors are nonlinear. Below the diode compression point, the output voltage is proportional to the square of the applied E-field; above the diode compression point, it is linear to the applied E-field. The compression point depends on the diode, and a calibration procedure is necessary for each sensor of the probe.

The Keithley multimeter reads the voltage of each sensor and send these three values to the PC. The corresponding E field value is calculated using the probe calibration factors, which are stored in the working directory. This evaluation includes linearization of the diode characteristics. The field calculation is done separately for each sensor. Each component of the E field is displayed on the "Dipole Area Scan Interface" and the total E field is displayed on the "3D Interface"

## 2.2. Robot

The SATIMO SAR system uses the high precision robots from KUKA. For the 6-axis controller system, the robot controller version (KUKA) from KUKA is used. The KUKA robot series have many features that are important for our application:



- High precision (repeatability  $\pm 0.03$  mm)
- High reliability (industrial design)
- Jerk-free straight movements
- Low ELF interference (the closed metallic construction shields against motor control fields)

### 2.3. E-Field Probe

This E-field detection probe is composed of three orthogonal dipoles linked to special Schottky diodes with low detection thresholds. The probe allows the measurement of electric fields in liquids such as the one defined in the IEEE and CENELEC standards.

For the measurements the Specific Dosimetric E-Field Probe SN 08/16 EPGO287 with following specifications is used



- Dynamic range: 0.01-100 W/kg
  - Tip Diameter: 2.5 mm
  - Distance between probe tip and sensor center: 1 mm
  - Distance between sensor center and the inner phantom surface: 2 mm (repeatability better than  $\pm 1$  mm).
  - Probe linearity:  $\pm 0.08$  dB
  - Axial isotropy: 0.06 dB
  - Hemispherical Isotropy: 0.08 dB
  - Calibration range: 650MHz to 5900MHz for head & body simulating liquid.
  - Lower detection limit: 7mW/kg
- Angle between probe axis (evaluation axis) and surface normal line: less than  $30^\circ$ .

#### 2.3.1. E-Field Probe Calibration

Each probe needs to be calibrated according to a dosimetric assessment procedure with accuracy better than  $\pm 10\%$ . The spherical isotropy shall be evaluated and within  $\pm 0.25$ dB. The sensitivity parameters (Norm X, Norm Y, and Norm Z), the diode compression parameter (DCP) and the conversion factor (Conv F) of the probe are tested. The calibration data can be referred to appendix D of this report.

## 2.4. SAM phantoms

Photo of SAM phantom SN 16/15 SAM119



The SAM phantom is used to measure the SAR relative to people exposed to electro-magnetic field radiated by mobile phones.

**2.4.1. Technical Data**

Serial Number	Shell thickness	Filling volume	Dimensions	Positionner Material	Permittivity	Loss Tangent
<b>SN 16/15 SAM119</b>	2 mm ±0.2 mm	27 liters	Length:1000 mm Width:500 mm Height:200 mm	Gelcoat with fiberglass	3.4	0.02

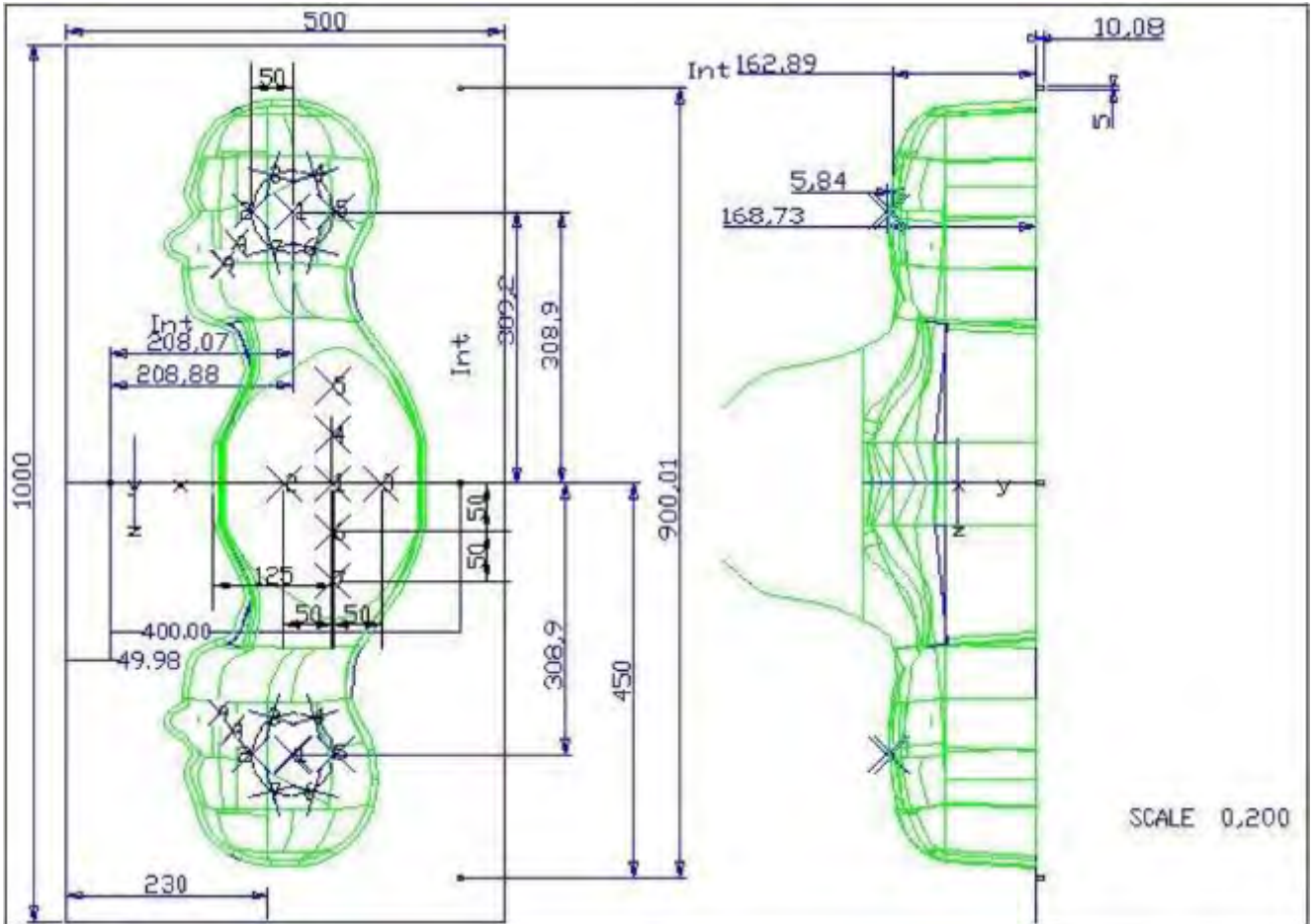

Serial Number	Left Head(mm)		Right Head(mm)		Flat Part(mm)	
	1	2	1	2	1	2
<b>SN 16/15 SAM119</b>	2	2.02	2	2.08	1	2.09
	3	2.05	3	2.06	2	2.06
	4	2.07	4	2.07	3	2.08
	5	2.08	5	2.08	4	2.10
	6	2.05	6	2.07	5	2.10
	7	2.05	7	2.05	6	2.07
	8	2.07	8	2.06	7	2.07
	9	2.08	9	2.06	-	-

The test, based on ultrasonic system, allows measuring the thickness with an accuracy of 10 µm.



### 2.5. Device Holder

The positioning system allows obtaining cheek and tilting position with a very good accuracy. In compliance with CENELEC, the tilt angle uncertainty is lower than 1 degree.

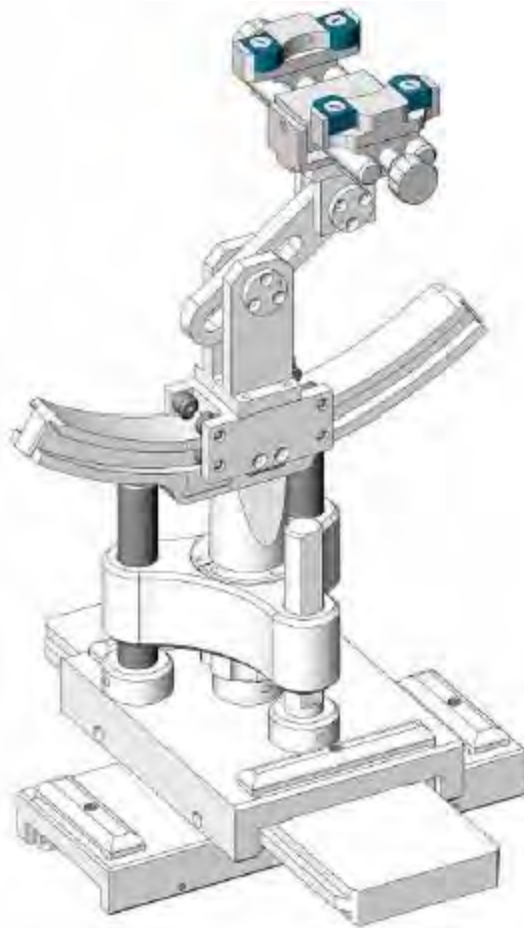

Serial Number	Holder Material	Permittivity	Loss Tangent
SN 16/15 MSH100	Delrin	3.7	0.005



## 2.6. Test Equipment List

This table gives a complete overview of the SAR measurement equipment.

Devices used during the test described are marked

	Manufacturer	Name of Equipment	Type/Model	Serial Number	Calibration	
					Last Cal.	Due Date
<input checked="" type="checkbox"/>	MVG	E FIELD PROBE	SSE2	SN 08/16 EPGO287	Sep. 17, 2018	Sep. 16, 2019
<input checked="" type="checkbox"/>	MVG	750 MHz Dipole	SID750	SN 03/15 DIP 0G750-355	Apr. 19, 2018	Apr. 18, 2021
<input checked="" type="checkbox"/>	MVG	835 MHz Dipole	SID835	SN 03/15 DIP 0G835-347	Apr. 19, 2018	Apr. 18, 2021
<input type="checkbox"/>	MVG	900 MHz Dipole	SID900	SN 03/15 DIP 0G900-348	Apr. 19, 2018	Apr. 18, 2021
<input checked="" type="checkbox"/>	MVG	1800 MHz Dipole	SID1800	SN 03/15 DIP 1G800-349	Apr. 19, 2018	Apr. 18, 2021
<input checked="" type="checkbox"/>	MVG	1900 MHz Dipole	SID1900	SN 03/15 DIP 1G900-350	Apr. 19, 2018	Apr. 18, 2021
<input type="checkbox"/>	MVG	2000 MHz Dipole	SID2000	SN 03/15 DIP 2G000-351	Apr. 19, 2018	Apr. 18, 2021
<input checked="" type="checkbox"/>	MVG	2450 MHz Dipole	SID2450	SN 03/15 DIP 2G450-352	Apr. 19, 2018	Apr. 18, 2021
<input checked="" type="checkbox"/>	MVG	2600 MHz Dipole	SID2600	SN 03/15 DIP 2G600-356	Apr. 19, 2018	Apr. 18, 2021
<input type="checkbox"/>	MVG	5000 MHz Dipole	SWG5500	SN 13/14 WGA 33	Apr. 19, 2018	Apr. 18, 2021
<input checked="" type="checkbox"/>	MVG	Liquid measurement Kit	SCLMP	SN 21/15 OCPG 72	NCR	NCR
<input checked="" type="checkbox"/>	MVG	Power Amplifier	N.A	AMPLISAR_28/14_003	NCR	NCR
<input checked="" type="checkbox"/>	KEITHLEY	Millivoltmeter	2000	4072790	NCR	NCR
<input checked="" type="checkbox"/>	R&S	Universal radio communication tester	CMU200	117858	Aug. 05, 2018	Aug. 04, 2019
<input checked="" type="checkbox"/>	R&S	Wideband radio communication tester	CMW500	103917	Oct. 08, 2018	Oct. 07, 2019
<input checked="" type="checkbox"/>	HP	Network Analyzer	8753D	3410J01136	Aug. 05, 2018	Aug. 04, 2019
<input checked="" type="checkbox"/>	Agilent	PSG Analog Signal Generator	E8257D	MY51110112	Aug. 05, 2018	Aug. 04, 2019

<input checked="" type="checkbox"/>	Agilent	Power meter	E4419B	MY45102538	Aug. 05, 2018	Aug. 04, 2019
<input checked="" type="checkbox"/>	Agilent	Power sensor	E9301A	MY41495644	Aug. 05, 2018	Aug. 04, 2019
<input checked="" type="checkbox"/>	Agilent	Power sensor	E9301A	US39212148	Aug. 05, 2018	Aug. 04, 2019
<input checked="" type="checkbox"/>	MCLI/USA	Directional Coupler	CB11-20	0D2L51502	Aug. 05, 2018	Aug. 04, 2019

### 3. SAR Measurement Procedures

The measurement procedures are as follows:

<Conducted power measurement>

- (a) For WWAN power measurement, use base station simulator to configure EUT WWAN transmission in conducted connection with RF cable, at maximum power in each supported wireless interface and frequency band.
- (b) Read the WWAN RF power level from the base station simulator.
- (c) For WLAN/Bluetooth power measurement, use engineering software to configure EUT WLAN/Bluetooth continuously transmission, at maximum RF power in each supported wireless interface and frequency band.
- (d) Connect EUT RF port through RF cable to the power meter, and measure WLAN/Bluetooth output power.

<SAR measurement>

- (a) Use base station simulator to configure EUT WWAN transmission in radiated connection, and engineering software to configure EUT WLAN/Bluetooth continuously transmission, at maximum RF power, in the highest power channel.
- (b) Place the EUT in the positions as Appendix A demonstrates.
- (c) Set scan area, grid size and other setting on the OPENSAR software.
- (d) Measure SAR results for the highest power channel on each testing position.
- (e) Find out the largest SAR result on these testing positions of each band.
- (f) Measure SAR results for other channels in worst SAR testing position if the reported SAR of highest power channel is larger than 0.8 W/kg.

According to the test standard, the recommended procedure for assessing the peak spatial-average SAR value consists of the following steps:

- (a) Power reference measurement
- (b) Area scan
- (c) Zoom scan
- (d) Power drift measurement

#### 3.1. Power Reference

The Power Reference Measurement and Power Drift Measurements are for monitoring the power drift of the device under test in the batch process. The minimum distance of probe sensors to surface determines the closest measurement point to phantom surface. This distance cannot be smaller than the distance of sensor calibration points to probe tip as defined in the probe properties.

#### 3.2. Area scan & Zoom scan

The area scan is a 2D scan to find the hot spot location on the DUT. The zoom scan is a 3D scan above the hot spot to calculate the 1g and 10g SAR value.

Measurement of the SAR distribution with a grid of 8 to 16 mm \* 8 to 16 mm and a constant distance to the inner surface of the phantom. Since the sensors cannot directly measure at the inner phantom surface, the values between the sensors and the inner phantom surface are extrapolated. With these values the area of the maximum SAR is calculated by an interpolation scheme. Around this point, a cube of 30 \* 30 \* 30 mm or 32 \* 32 \* 32 mm is assessed by measuring 5 or 8 \* 5 or 8 \* 4 or 5 mm. With these data, the peak spatial-average SAR value can be calculated.

From the scanned SAR distribution, identify the position of the maximum SAR value, in addition identify the positions of any local maxima with SAR values within 2 dB of the maximum value that will not be within the zoom scan of other peaks; additional peaks shall be measured only when the primary peak is within 2 dB of the SAR compliance limit (e.g., 1 W/kg for 1,6 W/kg 1 g limit, or 1,26 W/kg for 2 W/kg, 10 g limit).

Area scan & Zoom scan scan parameters extracted from FCC KDB 865664 D01 SAR measurement 100 MHz to 6 GHz.

		≤ 3 GHz	> 3 GHz
Maximum distance from closest measurement point (geometric center of probe sensors) to phantom surface		5 ± 1 mm	½·δ·ln(2) ± 0.5 mm
Maximum probe angle from probe axis to phantom surface normal at the measurement location		30° ± 1°	20° ± 1°
Maximum area scan spatial resolution: Δx <sub>Area</sub> , Δy <sub>Area</sub>		≤ 2 GHz: ≤ 15 mm 2 – 3 GHz: ≤ 12 mm	3 – 4 GHz: ≤ 12 mm 4 – 6 GHz: ≤ 10 mm
		When the x or y dimension of the test device, in the measurement plane orientation, is smaller than the above, the measurement resolution must be ≤ the corresponding x or y dimension of the test device with at least one measurement point on the test device.	
Maximum zoom scan spatial resolution: Δx <sub>Zoom</sub> , Δy <sub>Zoom</sub>		≤ 2 GHz: ≤ 8 mm 2 – 3 GHz: ≤ 5 mm*	3 – 4 GHz: ≤ 5 mm* 4 – 6 GHz: ≤ 4 mm*
Maximum zoom scan spatial resolution, normal to phantom surface	uniform grid: Δz <sub>Zoom</sub> (n)	≤ 5 mm	3 – 4 GHz: ≤ 4 mm 4 – 5 GHz: ≤ 3 mm 5 – 6 GHz: ≤ 2 mm
	graded grid	Δz <sub>Zoom</sub> (1): between 1 <sup>st</sup> two points closest to phantom surface	≤ 4 mm  3 – 4 GHz: ≤ 3 mm 4 – 5 GHz: ≤ 2.5 mm 5 – 6 GHz: ≤ 2 mm
		Δz <sub>Zoom</sub> (n>1): between subsequent points	≤ 1.5·Δz <sub>Zoom</sub> (n-1)
Minimum zoom scan volume	x, y, z	≥ 30 mm	3 – 4 GHz: ≥ 28 mm 4 – 5 GHz: ≥ 25 mm 5 – 6 GHz: ≥ 22 mm

Note: δ is the penetration depth of a plane-wave at normal incidence to the tissue medium; see draft standard IEEE P1528-2011 for details.

\* When zoom scan is required and the *reported* SAR from the *area scan based 1-g SAR estimation* procedures of KDB 447498 is ≤ 1.4 W/kg, ≤ 8 mm, ≤ 7 mm and ≤ 5 mm zoom scan resolution may be applied, respectively, for 2 GHz to 3 GHz, 3 GHz to 4 GHz and 4 GHz to 6 GHz.

### 3.3. Description of interpolation/extrapolation scheme

The local SAR inside the phantom is measured using small dipole sensing elements inside a probe body. The probe tip must not be in contact with the phantom surface in order to minimise measurements errors, but the highest local SAR will occur at the surface of the phantom.

An extrapolation is using to determinate this highest local SAR values. The extrapolation is based on a fourth-order least-square polynomial fit of measured data. The local SAR value is then extrapolated from the liquid surface with a 1 mm step.

The measurements have to be performed over a limited time (due to the duration of the battery) so the step of measurement is high. It could vary between 5 and 8 mm. To obtain an accurate assessment of the maximum SAR averaged over 10 grams and 1 gram requires a very fine resolution in the three dimensional scanned data array.

### 3.4. Volumetric Scan

The volumetric scan consists to a full 3D scan over a specific area. This 3D scan is useful form multi Tx SAR measurement. Indeed, it is possible with OpenSAR to add, point by point, several volumetric scan to calculate the SAR value of the combined measurement as it is define in the standard IEEE1528 and IEC62209.

### 3.5. Power Drift

All SAR testing is under the EUT install full charged battery and transmit maximum output power. In OpenSAR measurement software, the power reference measurement and power drift measurement procedures are used for monitoring the power drift of EUT during SAR test. Both these procedures measure the field at a specified reference position before and after the SAR testing. The software will calculate the field difference in V/m. If the power drifts more than  $\pm 5\%$ , the SAR will be retested.

## 4. System Verification Procedure

### 4.1. Tissue Verification

The following tissue formulations are provided for reference only as some of the parameters have not been thoroughly verified. The composition of ingredients may be modified accordingly to achieve the desired target tissue parameters required for routine SAR evaluation.

Ingredients (% of weight)	Head Tissue									
	750	835	900	1800	1900	2000	2450	2600	5200	5800
Frequency Band (MHz)										
Water	34.40	34.40	34.40	55.36	55.36	57.87	57.87	57.87	65.53	65.53
NaCl	0.79	0.79	0.79	0.35	0.35	0.16	0.16	0.16	0.00	0.00
1,2-Propanediol	64.81	64.81	64.81	0.00	0.00	0.00	0.00	0.00	0.00	0.00
Triton X-100	0.00	0.00	0.00	30.45	30.45	19.97	19.97	19.97	24.24	24.24
DGBE	0.00	0.00	0.00	13.84	13.84	22.00	22.00	22.00	10.23	10.23
Ingredients (% of weight)	Body Tissue									
	750	835	900	1800	1900	2000	2450	2600	5200	5800
Frequency Band (MHz)										
Water	50.30	50.30	50.30	69.91	69.91	71.88	71.88	71.88	79.54	79.54
NaCl	0.60	0.60	0.60	0.13	0.13	0.16	0.16	0.16	0.00	0.00
1,2-Propanediol	49.10	49.10	49.10	0.00	0.00	0.00	0.00	0.00	0.00	0.00
Triton X-100	0.00	0.00	0.00	9.99	9.99	19.97	19.97	19.97	11.24	11.24
DGBE	0.00	0.00	0.00	19.97	19.97	7.99	7.99	7.99	9.22	9.22

For SAR measurement of the field distribution inside the phantom, the phantom must be filled with homogeneous tissue simulating liquid to a depth of at least 15 cm. For head SAR testing, the liquid depth from the ear reference point (ERP) of the phantom to the liquid top surface is larger than 15 cm.

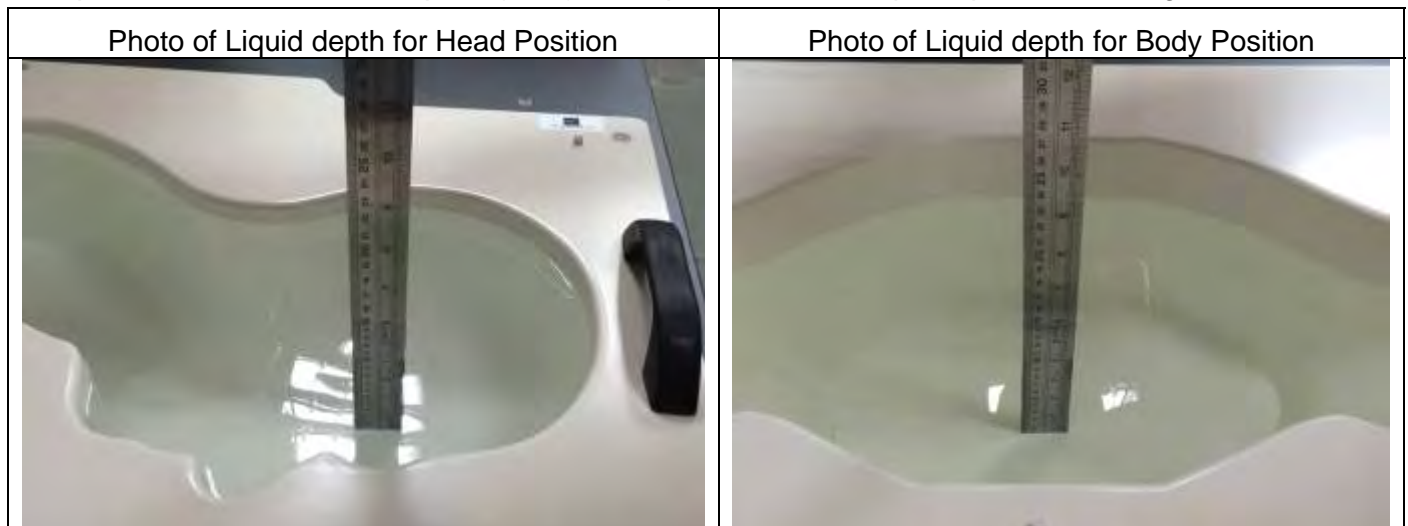

#### 4.1.1. Tissue Dielectric Parameter Check Results

The simulating liquids should be checked at the beginning of a series of SAR measurements to determine if the dielectric parameters are within the tolerances of the specified target values. The measured conductivity and relative permittivity should be within  $\pm 5\%$  of the target values.

Tissue Type	Measured Frequency (MHz)	Target Tissue		Measured Tissue		Liquid Temp.	Test Date
		$\epsilon_r$ ( $\pm 5\%$ )	$\sigma$ (S/m) ( $\pm 5\%$ )	$\epsilon_r$	$\sigma$ (S/m)		
Head 750	750	41.90 (39.81~43.99)	0.89 (0.85~0.93)	41.41	0.92	21.8 °C	Jul. 17, 2019
Body 750	750	55.50 (52.73~58.27)	0.96 (0.91~1.01)	55.42	0.98	21.5 °C	Jul. 19, 2019
Head 850	835	41.50 (39.43~43.57)	0.90 (0.86~0.94)	41.87	0.90	21.3 °C	Jul. 18, 2019
Body 850	835	55.20 (52.44~57.96)	0.97 (0.92~1.01)	54.91	0.97	21.4 °C	Jul. 20, 2019
Head 1800	1800	40.00 (38.00~42.00)	1.40 (1.33~1.47)	39.97	1.42	22.0 °C	Jul. 13, 2019
Body 1800	1800	53.30 (50.64~55.96)	1.52 (1.44~1.59)	54.02	1.52	21.9 °C	Jul. 18, 2019
Head 1900	1900	40.00 (38.00~42.00)	1.40 (1.33~1.47)	38.56	1.44	21.5 °C	Jul. 17, 2019
Body 1900	1900	53.30 (50.64~55.96)	1.52 (1.44~1.59)	53.31	1.54	21.4 °C	Jul. 14, 2019
Head 2450	2450	39.20 (37.24~41.16)	1.80 (1.71~1.89)	39.67	1.83	21.3 °C	Jul. 13, 2019
Body 2450	2450	52.70 (50.07~55.33)	1.95 (1.85~2.04)	52.10	1.96	21.7 °C	Jul. 16, 2019
Head 2600	2600	39.00 (37.05~40.95)	1.96 (1.86~2.05)	38.86	1.98	21.7 °C	Jul. 14, 2019
Body 2600	2600	52.50 (49.88~55.13)	2.16 (2.05~2.27)	53.49	2.17	21.5 °C	Jul. 15, 2019

NOTE: The dielectric parameters of the tissue-equivalent liquid should be measured under similar ambient conditions and within 2 °C of the conditions expected during the SAR evaluation to satisfy protocol requirements.



### 4.2. System Verification Procedure

The system verification is performed for verifying the accuracy of the complete measurement system and performance of the software. The dipole is connected to the signal source consisting of signal generator and amplifier via a directional coupler, N-connector cable and adaption to SMA. It is fed with a power of 100mW (below 5GHz) or 100mW (above 5GHz). To adjust this power a power meter is used. The power sensor is connected to the cable before the system verification to measure the power at this point and do adjustments at the signal generator. At the outputs of the directional coupler both return loss as well as forward power are controlled during the system verification to make sure that emitted power at the dipole is kept constant. This can also be checked by the power drift measurement after the test (result on plot).

The system verification is shown as below picture:

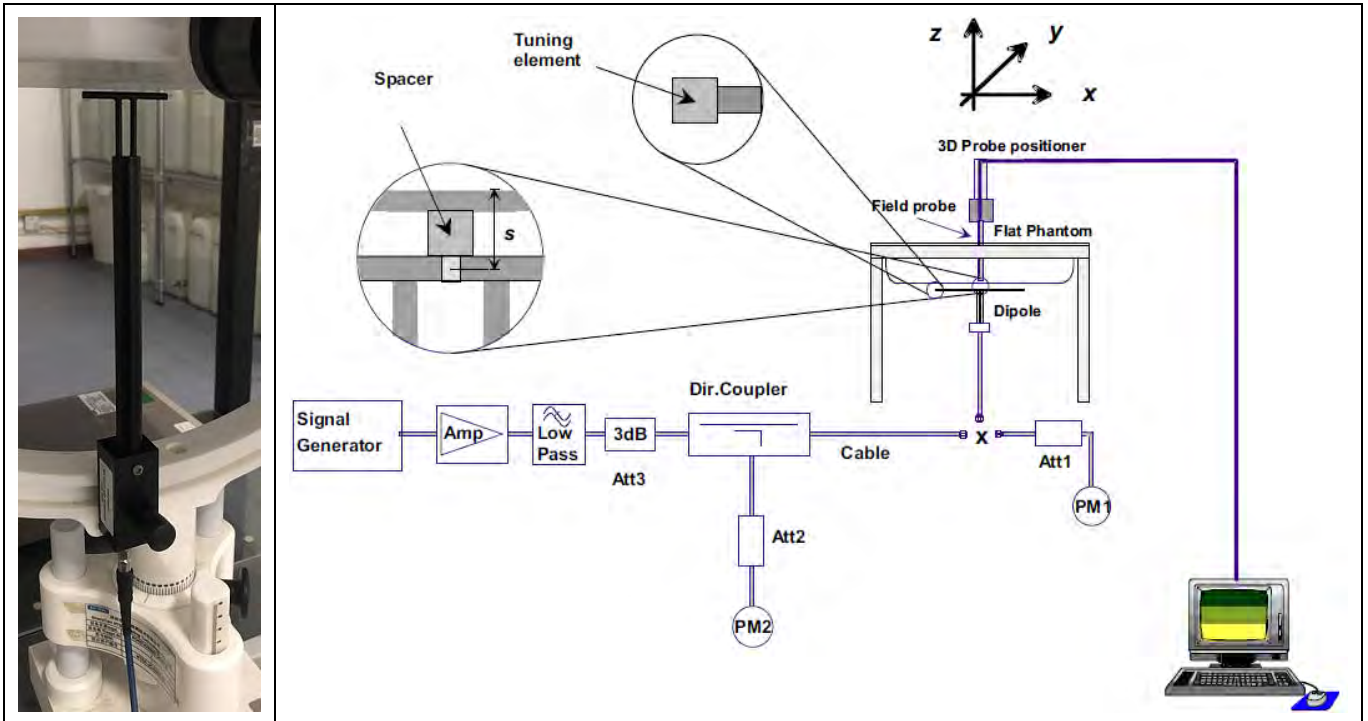



#### 4.2.1. System Verification Results

Comparing to the original SAR value provided by SATIMO, the verification data should be within its specification of  $\pm 10\%$ . Below table shows the target SAR and measured SAR after normalized to 1W input power. The table below indicates the system performance verification can meet the variation criterion and the plots can be referred to Appendix B of this report.

System Verification	Target SAR (1W) ( $\pm 10\%$ )		Measured SAR (Normalized to 1W)		Liquid Temp.	Test Date
	1-g (W/Kg)	10-g (W/Kg)	1-g (W/Kg)	10-g (W/Kg)		
750MHz Head	8.49 (7.64~9.34)	5.55 (4.99~6.11)	8.45	5.37	21.8 °C	Jul. 17, 2019
750MHz Body	8.55 (7.69~9.41)	5.75 (5.17~6.33)	8.77	5.60	21.5 °C	Jul. 19, 2019
835MHz Head	9.56 (8.60~10.51)	6.22 (5.60~6.84)	9.55	6.20	21.3 °C	Jul. 18, 2019
835MHz Body	9.48 (8.53~10.42)	6.29 (5.66~6.91)	9.35	6.06	21.4 °C	Jul. 20, 2019
1800MHz Head	38.40 (34.56~42.24)	20.10 (18.09~22.11)	37.20	19.94	22.0 °C	Jul. 13, 2019
1800MHz Body	37.04 (33.34~40.74)	20.26 (18.23~22.29)	37.24	19.97	21.9 °C	Jul. 18, 2019
1900MHz Head	39.70 (35.73~43.67)	20.50 (18.45~22.55)	40.94	20.83	21.5 °C	Jul. 17, 2019
1900MHz Body	38.43 (34.59~42.27)	20.34 (18.31~22.37)	40.02	20.16	21.4 °C	Jul. 14, 2019
2450MHz Head	52.40 (47.16~57.64)	24.00 (21.60~26.40)	54.31	23.83	21.3 °C	Jul. 13, 2019
2450MHz Body	49.32 (44.39~54.25)	22.89 (20.60~25.17)	51.99	23.01	21.7 °C	Jul. 16, 2019
2600MHz Head	55.30 (49.77~60.83)	24.60 (22.14~27.06)	56.17	26.89	21.7 °C	Jul. 14, 2019
2600MHz Body	52.95 (47.66~58.25)	23.64 (21.28~26.00)	53.50	23.61	21.5 °C	Jul. 15, 2019

## **5. SAR Measurement variability and uncertainty**

### **5.1. SAR measurement variability**

Per KDB865664 D01 SAR measurement 100 MHz to 6 GHz, SAR measurement variability must be assessed for each frequency band, which is determined by the SAR probe calibration point and tissue-equivalent medium used for the device measurements. The additional measurements are repeated after the completion of all measurements requiring the same head or body tissue-equivalent medium in a frequency band. The test device should be returned to ambient conditions (normal room temperature) with the battery fully charged before it is re-mounted on the device holder for the repeated measurement(s) to minimize any unexpected variations in the repeated results.

- 1) Repeated measurement is not required when the original highest measured SAR is  $< 0.80$  W/kg; steps 2) through 4) do not apply.
- 2) When the original highest measured SAR is  $\geq 0.80$  W/kg, repeat that measurement once.
- 3) Perform a second repeated measurement only if the ratio of largest to smallest SAR for the original and first repeated measurements is  $> 1.20$  or when the original or repeated measurement is  $\geq 1.45$  W/kg (~ 10% from the 1-g SAR limit).
- 4) Perform a third repeated measurement only if the original, first or second repeated measurement is  $\geq 1.5$  W/kg and the ratio of largest to smallest SAR for the original, first and second repeated measurements is  $> 1.20$ .

### **5.2. SAR measurement uncertainty**

Per KDB865664 D01 SAR Measurement 100 MHz to 6 GHz, when the highest measured 1-g SAR within a frequency band is  $< 1.5$  W/kg, the extensive SAR measurement uncertainty analysis described in IEEE Std 1528-2013 is not required in SAR reports submitted for equipment approval. The equivalent ratio (1.5/1.6) is applied to extremity and occupational exposure conditions.

## 6. RF Exposure Positions

### 6.1. Ear and handset reference point

Figure 6.1.1 shows the front, back, and side views of the SAM phantom. The center-of-mouth reference point is labeled “M”, the left ear reference point (ERP) is marked “LE”, and the right ERP is marked “RE”.



Fig 6.1.1 Front, back, and side views of SAM phantom

### 6.2. Definition of the cheek position

1. Define two imaginary lines on the handset, the vertical centerline and the horizontal line. The vertical centerline passes through two points on the front side of the handset: the midpoint of the width  $w_t$  of the handset at the level of the acoustic output (point A in Figure 6.2.1 and Figure 6.2.2), and the midpoint of the width  $w_b$  of the bottom of the handset (point B). The horizontal line is perpendicular to the vertical centerline and passes through the center of the acoustic output (see Figure 6.2.1). The two lines intersect at point A. Note that for many handsets, point A coincides with the center of the acoustic output; however, the acoustic output may be located elsewhere on the horizontal line. Also note that the vertical centerline is not necessarily parallel to the front face of the handset (see Figure 6.2.2), especially for clamshell handsets, handsets with flip covers, and other irregularly-shaped handsets.
2. Position the handset close to the surface of the phantom such that point A is on the (virtual) extension of the line passing through points RE and LE on the phantom (see Figure 6.2.3), such that the plane defined by the vertical centerline and the horizontal line of the handset is approximately parallel to the sagittal plane of the phantom.
3. Translate the handset towards the phantom along the line passing through RE and LE until handset point A touches the pinna at the ERP
4. While maintaining the handset in this plane, rotate it around the LE-RE line until the vertical centerline is in the plane normal to the plane containing B-M and N-F lines, i.e., the Reference Plane.
5. Rotate the handset around the vertical centerline until the handset (horizontal line) is parallel to the N-F line.

6. While maintaining the vertical centerline in the Reference Plane, keeping point A on the line passing through RE and LE, and maintaining the handset contact with the pinna, rotate the handset about the N-F line until any point on the handset is in contact with a phantom point below the pinna on the cheek. See Figure 6.2.3. The actual rotation angles should be documented in the test report.

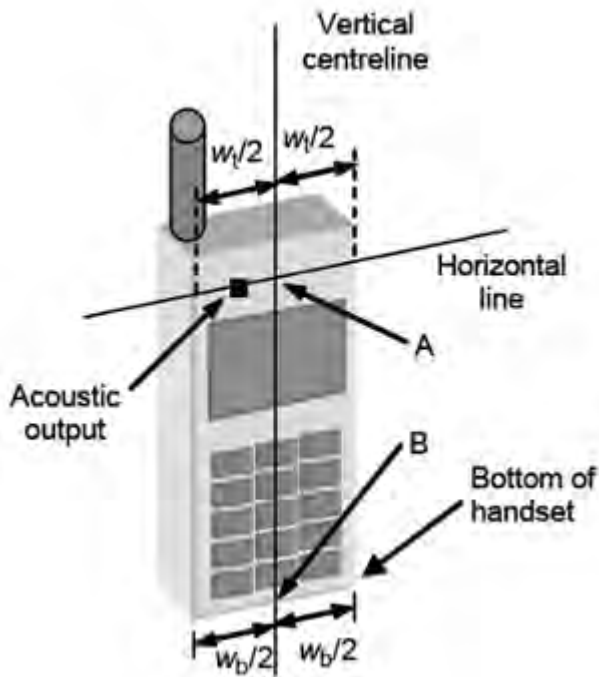

Fig 6.2.1 Handset vertical and horizontal reference lines—"fixed case"

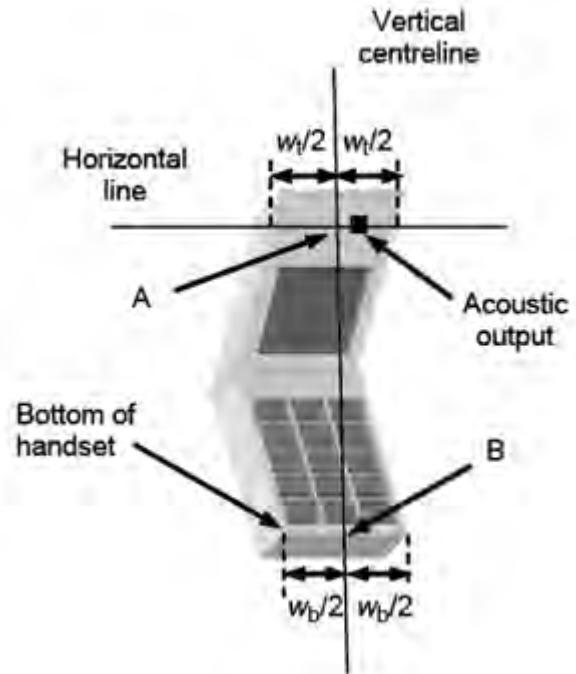

Fig 6.2.2 Handset vertical and horizontal reference lines—"clam-shell case"

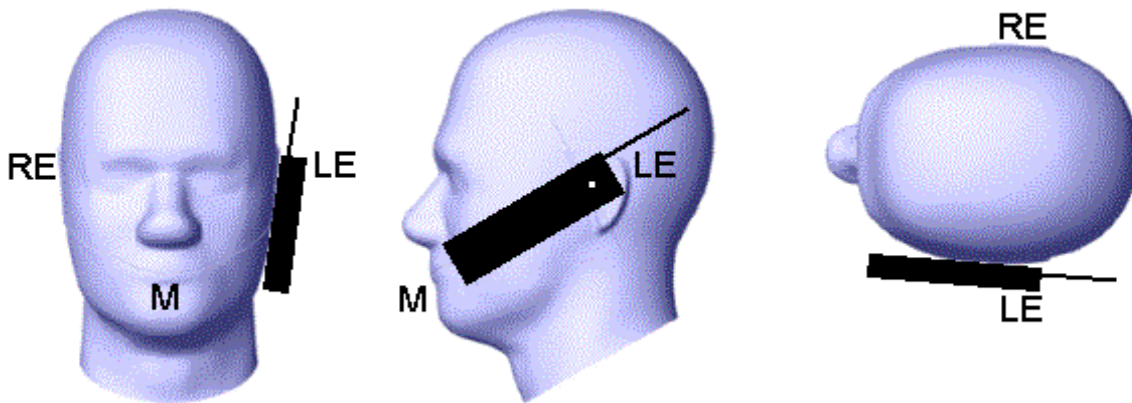

Fig 6.2.3 cheek or touch position. The reference points for the right ear (RE), left ear (LE), and mouth (M), which establish the Reference Plane for handset positioning, are indicated.

### 6.3. Definition of the tilt position

1. While maintaining the orientation of the handset, retract the handset parallel to the reference plane far enough away from the phantom to enable a rotation of the device by 15 degree.
2. Rotate the Handset around the horizontal line by 15 degree (see Figure 6.3.1).
3. While maintaining the orientation of the handset, move the handset towards the phantom on a line passing through RE and LE until any part of the handset touches the ear. The tilt position is obtained when the contact is on the pinna. If the contact is at any location other than the pinna, e.g., the antenna with the back of the phantom head, the angle of the handset shall be reduced. In this case, the tilt position is obtained if any part of the handset is in contact with the pinna as well as a second part of the handset is in contact with the phantom, e.g., the antenna with the back of the head.

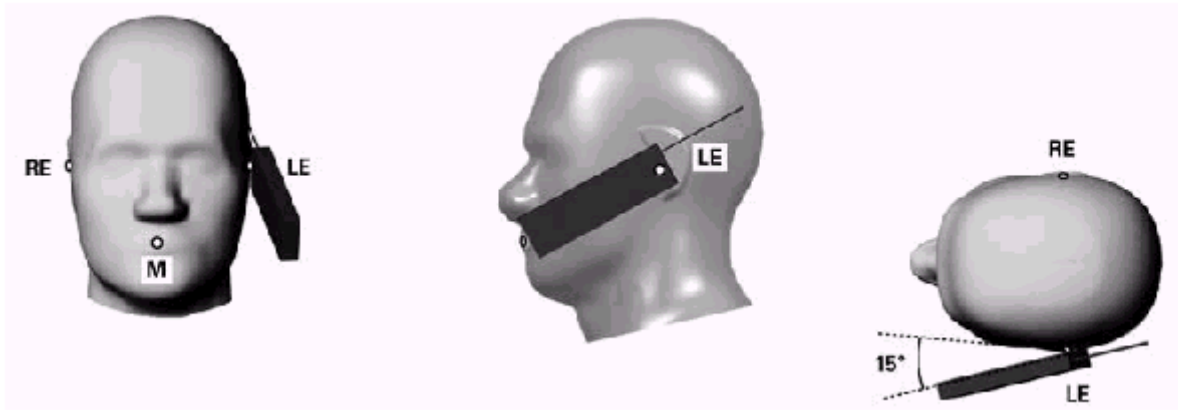

Figure 6.3.1 – Tilt position of the wireless device on the left side of SAM

### 6.4. Body Worn Accessory

1. Body-worn operating configurations are tested with the belt-clips and holsters attached to the device and positioned against a flat phantom in a normal use configuration (see Figure 6.4.1). Per KDB 648474 D04, body-worn accessory exposure is typically related to voice mode operations when handsets are carried in body-worn accessories. The body-worn accessory procedures in FCC KDB 447498 D01 should be used to test for body-worn accessory SAR compliance, without a headset connected to it. This enables the test results for such configuration to be compatible with that required for hotspot mode when the body-worn accessory test separation distance is greater than or equal to that required for hotspot mode, when applicable. When the reported SAR for body-worn accessory, measured without a headset connected to the handset is  $< 1.2 \text{ W/kg}$ , the highest reported SAR configuration for that wireless mode and frequency band should be repeated for that body-worn accessory with a handset attached to the handset.
2. Accessories for body-worn operation configurations are divided into two categories: those that do not contain metallic components and those that do contain metallic components and those that do contain metallic components. When multiple accessories that do not contain metallic components are supplied with the device, the device is tested with only the accessory that dictates the closest



spacing to the body. Then multiple accessories that contain metallic components are test with the device with each accessory. If multiple accessories share an identical metallic component (i.e. the same metallic belt-clip used with different holsters with no other metallic components) only the accessory that dictates the closest spacing to the body is tested.

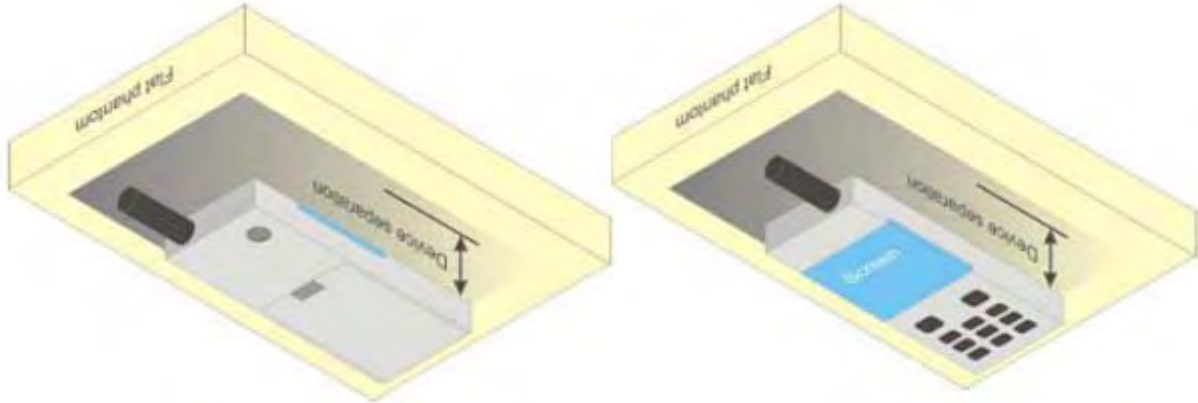

Figure 6.4.1 – Test positions for body-worn devices

### 6.5. Wireless Router Devices

Some battery-operated handsets have the capability to transmit and receive user through simultaneous transmission of WLAN simultaneously with a separate licensed transmitter. The FCC has provided guidance in FCC KDB Publication 941225 D06 where SAR test considerations for handsets ( $L \times W \geq 9 \text{ cm} \times 5 \text{ cm}$ ) are based on a composite test separation distance of 10mm from the front, back and edges of the device containing transmitting antennas within 2.5cm of their edges, determined from general mixed use conditions for this type of devices. Since the hotspot SAR results may overlap with the body-worn accessory SAR requirements, the more conservative configurations can be considered, thus excluding some body-worn accessory SAR tests.

When the user enables the personal wireless router functions for the handset, actual operations include simultaneous transmission of both the WLAN transmitter and another licensed transmitter. Both transmitters often do not transmit at the same transmitting frequency and thus cannot be evaluated for SAR under actual use conditions due to the limitations of the SAR assessment probes. Therefore, SAR must be evaluated for each frequency transmission and mode separately and spatially summed with the WLAN transmitter according to FCC KDB Publication 447498 D01 publication procedures. The “Portable Hotspot” feature on the handset was NOT activated during SAR assessments, to ensure the SAR measurements were evaluated for a single transmission frequency RF signal at a time.

## 7. RF Output Power

### 7.1. GSM Conducted Power

Band GSM850		Burst-Averaged output Power (dBm)			Frame-Averaged output Power (dBm)			
Tx Channel	Tune-up (dBm)	128	189	251	Tune-up (dBm)	128	189	251
Frequency (MHz)		824.2	836.4	848.8		824.2	836.4	848.8
GSM (GMSK)	33.50	33.15	33.09	33.02	24.47	24.12	24.06	23.99
GPRS(GMSK, 1 TS)	33.50	33.15	33.08	33.02	24.47	24.12	24.05	23.99
GPRS(GMSK, 2 TS)	32.50	32.30	32.19	32.13	26.48	26.28	26.17	26.11
GPRS(GMSK, 3 TS)	30.50	30.32	30.21	30.19	26.24	26.06	25.95	25.93
GPRS(GMSK, 4 TS)	29.50	29.14	29.06	29.07	26.49	26.13	26.05	26.06
EDGE(GMSK, 1 TS)	28.50	27.63	27.45	27.68	19.47	18.60	18.42	18.65
EDGE(GMSK, 2 TS)	26.50	26.24	26.47	26.18	20.48	20.22	20.45	20.16
EDGE(GMSK, 3 TS)	24.50	24.49	24.19	24.46	20.24	20.23	19.93	20.20
EDGE(GMSK, 4 TS)	23.50	23.27	23.09	23.27	20.49	20.26	20.08	20.26
Band GSM1900		Burst-Averaged output Power (dBm)			Frame-Averaged output Power (dBm)			
Tx Channel	Tune-up (dBm)	512	661	810	Tune-up (dBm)	512	661	810
Frequency (MHz)		1850.2	1880.0	1909.8		1850.2	1880.0	1909.8
GSM (GMSK)	31.00	29.77	29.90	30.41	21.97	20.74	20.87	21.38
GPRS(GMSK, 1 TS)	31.00	29.77	29.89	30.41	21.97	20.74	20.86	21.38
GPRS(GMSK, 2 TS)	30.00	28.93	29.07	29.69	23.98	22.91	23.05	23.67
GPRS(GMSK, 3 TS)	28.00	27.08	27.19	27.89	23.74	22.82	22.93	23.63
GPRS(GMSK, 4 TS)	27.00	26.03	26.17	26.89	23.99	23.02	23.16	23.88
EDGE(GMSK, 1 TS)	27.00	25.92	26.06	25.53	17.97	16.89	17.03	16.50
EDGE(GMSK, 2 TS)	25.00	24.85	24.93	24.34	18.98	18.83	18.91	18.32
EDGE(GMSK, 3 TS)	23.00	22.81	22.82	22.34	18.74	18.55	18.56	18.08
EDGE(GMSK, 4 TS)	22.00	21.59	21.62	21.06	18.99	18.58	18.61	18.05

Note: The frame-averaged power is linearly scaled the maximum burst averaged power over 8 time slots.

The calculated method are shown as below:

Frame-averaged power = Maximum burst averaged power (1 TS) - 9.03 dB

Frame-averaged power = Maximum burst averaged power (2 TS) - 6.02 dB

Frame-averaged power = Maximum burst averaged power (3 TS) - 4.26 dB

Frame-averaged power = Maximum burst averaged power (4 TS) - 3.01 dB

### 7.2. WCDMA Conducted Power

Band	WCDMA Band V			
Tx Channel	Tune-up	4132	4182	4233
Frequency (MHz)		826.4	836.4	846.6

RMC 12.2Kbps	23.50	23.28	23.17	23.17
HSDPA Subtest-1	22.50	22.35	22.25	22.26
HSDPA Subtest-2	22.50	21.92	21.55	21.21
HSDPA Subtest-3	21.50	20.49	20.85	20.54
HSDPA Subtest-4	21.50	20.84	20.77	20.70
HSUPA Subtest-1	22.50	21.90	21.75	21.81
HSUPA Subtest-2	22.50	22.15	22.10	22.20
HSUPA Subtest-3	21.50	21.23	21.16	21.02
HSUPA Subtest-4	22.50	22.38	22.24	22.26
HSUPA Subtest-5	22.50	21.61	21.54	21.42
Band	WCDMA Band IV			
Tx Channel	Tune-up	1312	1413	1513
Frequency (MHz)		1712.4	1732.6	1752.6
RMC 12.2Kbps	23.50	23.19	23.10	23.07
HSDPA Subtest-1	22.50	22.40	22.25	22.23
HSDPA Subtest-2	22.50	21.74	21.62	21.65
HSDPA Subtest-3	21.50	20.72	20.49	20.73
HSDPA Subtest-4	21.50	20.65	20.79	20.53
HSUPA Subtest-1	22.50	22.05	21.86	21.62
HSUPA Subtest-2	22.50	22.29	22.17	22.19
HSUPA Subtest-3	21.50	21.18	20.78	20.72
HSUPA Subtest-4	22.50	22.39	22.25	22.23
HSUPA Subtest-5	22.50	21.61	21.30	21.27
Band	WCDMA Band II			
Tx Channel	Tune-up	9262	9400	9538
Frequency (MHz)		1852.4	1880	1907.6
RMC 12.2Kbps	24.00	23.44	23.56	23.42
HSDPA Subtest-1	23.00	22.63	22.67	22.54
HSDPA Subtest-2	23.00	21.89	22.08	21.71
HSDPA Subtest-3	22.00	21.19	20.96	20.90
HSDPA Subtest-4	22.00	21.20	20.85	21.02
HSUPA Subtest-1	23.00	22.06	22.25	22.05
HSUPA Subtest-2	23.00	22.48	22.58	22.48
HSUPA Subtest-3	22.00	21.29	21.34	21.33
HSUPA Subtest-4	23.00	22.63	22.70	22.51
HSUPA Subtest-5	22.00	21.55	21.90	21.68



## 7.3. LTE Conducted Power

Band	Band Width	Modulation	RB Configuration		Tune-up	Channel/Frequency(MHz)		
			RB Size	RB Offset		18607/1850.7	18900/1880	19193/1909.3
LTE Band II	1.4MHz	QPSK	1	0	25.00	24.36	24.43	24.08
			1	2	25.00	24.50	24.57	24.24
			1	5	25.00	24.36	24.39	24.10
			3	0	25.00	24.44	24.43	24.22
			3	1	25.00	24.39	24.44	24.26
			3	2	25.00	24.40	24.47	24.29
			6	0	24.00	23.47	23.43	23.15
		16QAM	1	0	24.00	23.23	23.48	23.39
			1	2	24.00	23.35	23.64	23.52
			1	5	24.00	23.21	23.52	23.39
			3	0	24.00	23.61	23.63	23.56
			3	1	24.00	23.59	23.65	23.59
			3	2	24.00	23.61	23.61	23.61
			6	0	23.00	22.61	22.58	22.37
Band	Band Width	Modulation	RB Configuration		Tune-up	Channel/Frequency(MHz)		
			RB Size	RB Offset		18615/1851.5	18900/1880	19185/1908.5
LTE Band II	3MHz	QPSK	1	0	25.00	24.39	24.39	24.14
			1	7	25.00	24.83	24.64	24.45
			1	14	25.00	24.32	24.32	24.13
			8	0	24.00	23.43	23.43	23.24
			8	4	24.00	23.45	23.43	23.22
			8	7	24.00	23.41	23.41	23.18
			15	0	24.00	23.36	23.38	23.22
		16QAM	1	0	24.00	23.27	23.76	23.44
			1	7	24.00	23.47	24.00	23.60
			1	14	24.00	23.20	23.71	23.39
			8	0	23.00	22.36	22.41	22.28
			8	4	23.00	22.40	22.45	22.24
			8	7	23.00	22.36	22.38	22.20
			15	0	23.00	22.43	22.41	22.20
Band	Band Width	Modulation	RB Configuration		Tune-up	Channel/Frequency(MHz)		



II			1	74	25.00	24.25	24.19	23.99			
			36	0	24.00	23.51	23.54	23.30			
			36	18	24.00	23.49	23.48	23.29			
			36	37	24.00	23.43	23.42	23.20			
			75	0	24.00	23.51	23.53	23.27			
		16QAM	1	0	24.00	23.73	23.54	23.29			
			1	37	24.00	23.94	23.77	23.52			
			1	74	24.00	23.67	23.41	23.25			
			36	0	23.00	22.50	22.55	22.29			
			36	18	23.00	22.51	22.50	22.26			
			36	37	23.00	22.48	22.48	22.16			
			75	0	23.00	22.47	22.49	22.29			
			Band	Band Width	Modulation	RB Configuration		Tune-up	Channel/Frequency(MHz)		
						RB Size	RB Offset		18700/1860	18900/1880	19100/1900
LTE Band II	20MHz	QPSK	1	0	25.00	24.27	24.27	24.11			
			1	49	25.00	24.82	24.93	24.79			
			1	99	25.00	24.15	24.10	24.01			
			50	0	24.00	23.40	23.51	23.21			
			50	24	24.00	23.40	23.47	23.32			
			50	49	24.00	23.41	23.35	23.10			
			100	0	24.00	23.39	23.42	23.15			
		16QAM	1	0	24.00	23.59	23.54	23.41			
			1	49	24.00	23.76	23.74	23.59			
			1	99	24.00	23.51	23.45	23.40			
			50	0	23.00	22.41	22.47	22.24			
			50	24	23.00	22.46	22.45	22.32			
			50	49	23.00	22.47	22.32	22.14			
			100	0	23.00	22.40	22.44	22.18			

Band	Band Width	Modulation	RB Configuration		Tune-up	Channel/Frequency(MHz)		
			RB Size	RB Offset		19957/1710.7	20175/1732.5	20393/1754.3
LTE Band IV	1.4MHz	QPSK	1	0	25.00	24.11	24.04	23.91
			1	2	25.00	24.31	24.22	24.03
			1	5	25.00	24.15	24.03	23.91
			3	0	25.00	24.77	24.63	24.51
			3	1	25.00	24.24	24.13	23.98

		16QAM	3	2	25.00	24.23	24.11	24.03
			6	0	24.00	23.22	23.04	22.92
			1	0	24.00	23.08	23.17	23.10
			1	2	24.00	23.25	23.34	23.25
			1	5	24.00	23.11	23.16	23.16
			3	0	24.00	23.44	23.28	23.24
			3	1	24.00	23.43	23.27	23.28
			3	2	24.00	23.47	23.21	23.30
			6	0	23.00	22.37	22.23	22.11
Band	Band Width	Modulation	RB Configuration		Tune-up	Channel/Frequency(MHz)		
			RB Size	RB Offset		19965/1711.5	20175/1732.5	20385/1753.5
LTE Band IV	3MHz	QPSK	1	0	25.00	24.26	24.01	24.02
			1	7	25.00	24.74	24.29	24.20
			1	14	25.00	24.23	24.07	23.98
			8	0	24.00	23.19	23.02	22.94
			8	4	24.00	23.25	23.09	22.95
			8	7	24.00	23.23	23.05	22.93
			15	0	24.00	23.19	23.01	22.95
		16QAM	1	0	24.00	23.66	23.23	22.92
			1	7	24.00	23.96	23.43	23.27
			1	14	24.00	23.64	23.22	22.85
			8	0	23.00	22.23	22.02	21.93
			8	4	23.00	22.26	22.02	21.94
			8	7	23.00	22.22	22.00	21.91
			15	0	23.00	22.25	21.93	21.99
Band	Band Width	Modulation	RB Configuration		Tune-up	Channel/Frequency(MHz)		
			RB Size	RB Offset		19975/1712.5	20175/1732.5	20375/1752.5
LTE Band IV	5MHz	QPSK	1	0	25.00	24.12	24.02	23.91
			1	12	25.00	24.64	24.36	24.27
			1	24	25.00	24.16	23.96	23.83
			12	0	24.00	23.19	23.03	22.96
			12	6	24.00	23.25	23.09	23.03
			12	11	24.00	23.18	23.01	22.89
			25	0	24.00	23.25	23.05	23.04
		16QAM	1	0	24.00	23.69	23.25	23.25
			1	12	24.00	24.00	23.63	23.64

Band	Band Width	Modulation	RB Configuration		Tune-up	Channel/Frequency(MHz)		
			RB Size	RB Offset		20000/1715	20175/1732.5	20350/1750
			1	24	24.00	23.68	23.26	23.24
			12	0	23.00	22.23	21.91	21.98
			12	6	23.00	22.31	22.03	22.06
			12	11	23.00	22.23	21.93	21.96
			25	0	23.00	22.20	22.02	21.96
LTE Band IV	10MHz	QPSK	1	0	25.00	24.20	24.07	24.08
			1	24	25.00	24.36	24.20	24.16
			1	49	25.00	24.19	24.06	23.92
			25	0	24.00	23.31	23.06	23.13
			25	12	24.00	23.24	23.07	23.07
			25	24	24.00	23.26	23.05	23.00
			50	0	24.00	23.29	23.06	23.04
		16QAM	1	0	24.00	23.61	23.22	22.97
			1	24	24.00	23.78	23.33	23.04
			1	49	24.00	23.54	23.19	22.87
			25	0	23.00	22.33	22.04	22.11
			25	12	23.00	22.25	22.02	22.01
			25	24	23.00	22.25	22.05	21.96
			50	0	23.00	22.29	22.04	22.02
Band	Band Width	Modulation	RB Configuration		Tune-up	Channel/Frequency(MHz)		
			RB Size	RB Offset		20025/1717.5	20175/1732.5	20325/1747.5
LTE Band IV	15MHz	QPSK	1	0	25.00	24.23	24.14	23.94
			1	37	25.00	24.41	24.20	24.38
			1	74	25.00	24.08	24.00	23.82
			36	0	24.00	23.27	23.08	23.12
			36	18	24.00	23.20	23.11	23.06
			36	37	24.00	23.14	23.04	22.96
			75	0	24.00	23.19	23.09	23.05
		16QAM	1	0	24.00	23.62	23.29	23.12
			1	37	24.00	23.91	23.46	23.45
			1	74	24.00	23.49	23.18	23.01
			36	0	23.00	22.31	22.13	22.06
			36	18	23.00	22.26	22.18	22.02
			36	37	23.00	22.25	22.08	21.94

Band	Band Width	Modulation	RB Configuration		Tune-up	Channel/Frequency(MHz)		
			RB Size	RB Offset		20050/1720	20175/1732.5	20300/1745
			75	0		23.00	22.22	22.03
LTE Band IV	20MHz	QPSK	1	0	25.00	24.10	23.98	23.96
			1	49	25.00	24.81	24.80	24.79
			1	99	25.00	23.96	23.93	23.87
			50	0	24.00	23.25	23.03	23.16
			50	24	24.00	23.24	23.06	23.07
			50	49	24.00	23.19	22.94	22.96
			100	0	24.00	23.25	23.02	23.11
		16QAM	1	0	24.00	23.44	23.23	23.28
			1	49	24.00	23.55	23.44	23.51
			1	99	24.00	23.26	23.15	23.19
			50	0	23.00	22.20	22.00	22.22
			50	24	23.00	22.19	22.12	22.10
			50	49	23.00	22.21	21.94	21.98
			100	0	23.00	22.22	21.96	22.07

Band	Band Width	Modulation	RB Configuration		Tune-up	Channel/Frequency(MHz)		
			RB Size	RB Offset		20407/824.7	20525/836.5	20643/848.3
			1	0		24.50	24.07	24.05
LTE Band V	1.4MHz	QPSK	1	2	24.50	24.21	24.21	24.07
			1	5	24.50	24.09	24.06	23.95
			3	0	24.50	24.10	24.00	23.91
			3	1	24.50	24.12	24.01	23.94
			3	2	24.50	24.05	23.99	23.89
			6	0	23.50	23.02	23.13	22.97
			16QAM	1	0	23.50	23.09	23.03
		1		2	23.50	23.24	23.15	22.80
		1		5	23.50	23.17	23.05	22.64
		3		0	23.50	23.24	23.10	23.00
		3		1	23.50	23.24	23.13	23.03
		3		2	23.50	23.23	23.12	23.00
		6		0	22.50	22.20	22.12	22.04
		Band	Band Width	Modulation	RB Configuration		Tune-up	Channel/Frequency(MHz)



V			1	49	24.50	24.06	23.98	23.97
			25	0	23.50	23.15	22.93	23.02
			25	12	23.50	23.02	23.02	22.99
			25	24	23.50	23.10	23.02	22.88
			50	0	23.50	23.10	22.97	22.93
		16QAM	1	0	23.50	23.41	23.01	22.68
			1	24	23.50	23.42	23.22	22.87
			1	49	23.50	23.20	23.01	22.65
			25	0	22.50	22.17	21.83	21.96
			25	12	22.50	21.97	21.95	21.97
			25	24	22.50	22.02	21.91	21.85
			50	0	22.50	22.03	21.90	21.87

Band	Band Width	Modulation	RB Configuration		Tune-up	Channel/Frequency(MHz)		
			RB Size	RB Offset		20775/2502.5	21100/2535	21425/2567.5
LTE Band VII	5MHz	QPSK	1	0	25.00	24.78	24.18	24.46
			1	12	25.00	24.97	24.58	24.83
			1	24	25.00	24.52	24.17	24.63
			12	0	24.00	23.73	23.26	23.53
			12	6	24.00	23.74	23.25	23.63
			12	11	24.00	23.62	23.20	23.56
		16QAM	25	0	24.00	23.73	23.23	23.61
			1	0	24.00	23.89	23.63	23.68
			1	12	24.00	24.00	23.93	23.92
			1	24	24.00	23.76	23.57	23.74
			12	0	23.00	22.75	22.29	22.53
			12	6	23.00	22.76	22.28	22.59
			12	11	23.00	22.65	22.24	22.57
25	0	23.00	22.68	22.19	22.59			
Band	Band Width	Modulation	RB Configuration		Tune-up	Channel/Frequency(MHz)		
			RB Size	RB Offset		20800/2505	21100/2535	21400/2565
LTE Band VII	10MHz	QPSK	1	0	25.00	24.84	24.25	24.51
			1	24	25.00	24.71	24.32	24.71
			1	49	25.00	24.53	24.22	24.70
			25	0	24.00	23.72	23.30	23.55
			25	12	24.00	23.63	23.23	23.53



Band	Band Width	Modulation	RB Configuration		Tune-up	Channel/Frequency(MHz)		
			RB Size	RB Offset		20825/2507.5	21100/2535	21375/2562.5
		16QAM	25	24	24.00	23.66	23.28	23.58
			50	0	24.00	23.71	23.32	23.57
			1	0	24.00	24.00	23.37	23.29
			1	24	24.00	24.00	23.46	23.42
			1	49	24.00	23.89	23.37	23.39
			25	0	23.00	22.76	22.30	22.54
			25	12	23.00	22.64	22.28	22.56
			25	24	23.00	22.65	22.28	22.61
			50	0	23.00	22.70	22.30	22.54
Band	Band Width	Modulation	RB Configuration		Tune-up	Channel/Frequency(MHz)		
			RB Size	RB Offset		20825/2507.5	21100/2535	21375/2562.5
LTE Band VII	15MHz	QPSK	1	0	25.00	24.77	24.26	24.32
			1	37	25.00	24.75	24.52	24.78
			1	74	25.00	24.38	24.11	24.54
			36	0	24.00	23.74	23.30	23.54
			36	18	24.00	23.66	23.31	23.63
			36	37	24.00	23.60	23.28	23.67
			75	0	24.00	23.74	23.32	23.64
		16QAM	1	0	24.00	23.98	23.42	23.50
			1	37	24.00	24.00	23.70	23.88
			1	74	24.00	23.71	23.24	23.57
			36	0	23.00	22.70	22.35	22.51
			36	18	23.00	22.68	22.35	22.58
			36	37	23.00	22.61	22.27	22.58
75	0	23.00	22.65	22.29	22.62			
Band	Band Width	Modulation	RB Configuration		Tune-up	Channel/Frequency(MHz)		
			RB Size	RB Offset		20850/2510	21100/2535	21350/2560
LTE Band VII	20MHz	QPSK	1	0	25.00	24.77	24.96	24.88
			1	49	25.00	24.72	24.30	24.67
			1	99	25.00	24.34	24.11	24.60
			50	0	24.00	23.65	23.32	23.50
			50	24	24.00	23.61	23.33	23.60
			50	49	24.00	23.51	23.19	23.51
			100	0	24.00	23.58	23.29	23.55
		16QAM	1	0	24.00	23.90	23.57	23.64
			1	49	24.00	23.96	23.58	23.77

			1	99	24.00	23.52	23.30	23.66
			50	0	23.00	22.66	22.32	22.54
			50	24	23.00	22.69	22.29	22.65
			50	49	23.00	22.58	22.21	22.57
			100	0	23.00	22.61	22.26	22.51

Band	Band Width	Modulation	RB Configuration		Tune-up	Channel/Frequency(MHz)		
			RB Size	RB Offset		23017/699.7	23095/707.5	23173/715.3
LTE Band XII	1.4MHz	QPSK	1	0	24.50	23.92	23.96	23.78
			1	2	24.50	24.12	24.07	23.98
			1	5	24.50	23.98	23.91	23.75
			3	0	24.50	24.00	23.99	23.91
			3	1	24.50	23.99	24.01	23.90
			3	2	24.50	23.95	23.99	23.86
		16QAM	6	0	23.50	23.08	22.99	22.84
			1	0	23.50	22.83	23.09	22.98
			1	2	23.50	23.03	23.23	23.10
			1	5	23.50	22.87	23.10	23.00
			3	0	23.50	23.17	23.15	23.10
			3	1	23.50	23.20	23.21	23.11
			3	2	23.50	23.22	23.17	23.12
			6	0	22.50	22.19	22.13	22.02

Band	Band Width	Modulation	RB Configuration		Tune-up	Channel/Frequency(MHz)		
			RB Size	RB Offset		23025/700.5	23095/707.5	23165/714.5

LTE Band XII	3MHz	QPSK	1	0	24.50	23.98	23.95	23.90
			1	7	24.50	24.33	24.10	24.23
			1	14	24.50	24.00	23.93	23.84
			8	0	23.50	23.03	22.95	22.91
			8	4	23.50	23.04	23.01	22.95
			8	7	23.50	23.00	22.96	22.87
			15	0	23.50	23.01	22.96	22.86
		16QAM	1	0	23.50	23.44	23.19	22.82
			1	7	23.50	23.46	23.46	23.03
			1	14	23.50	23.40	23.16	22.74
			8	0	22.50	22.02	21.97	21.91
			8	4	22.50	22.05	22.01	21.92

Band	Band Width	Modulation	RB Configuration		Tune-up	Channel/Frequency(MHz)		
			RB Size	RB Offset		23035/701.5	23095/707.5	23155/713.5
			8	7	22.50	22.00	21.92	21.88
			15	0	22.50	21.99	21.90	21.96
LTE Band XII	5MHz	QPSK	1	0	24.50	23.96	23.94	23.82
			1	12	24.50	24.27	24.36	24.30
			1	24	24.50	23.95	23.92	23.75
			12	0	23.50	22.99	22.99	22.96
			12	6	23.50	23.07	23.03	22.99
			12	11	23.50	22.99	23.04	22.84
			25	0	23.50	23.03	23.02	22.97
		16QAM	1	0	23.50	23.47	23.26	23.14
			1	12	23.50	23.47	23.42	23.50
			1	24	23.50	23.47	23.27	23.09
			12	0	22.50	22.05	21.89	21.98
			12	6	22.50	22.07	21.96	21.99
			12	11	22.50	22.00	21.96	21.91
			25	0	22.50	21.96	21.98	21.88
Band	Band Width	Modulation	RB Configuration		Tune-up	Channel/Frequency(MHz)		
			RB Size	RB Offset		23060/704	23095/707.5	23130/711
LTE Band XII	10MHz	QPSK	1	0	24.50	24.01	23.93	24.00
			1	24	24.50	24.14	24.09	24.10
			1	49	24.50	24.00	23.93	23.91
			25	0	23.50	23.11	23.04	23.01
			25	12	23.50	23.06	23.04	22.99
			25	24	23.50	23.22	23.11	22.98
			50	0	23.50	23.13	23.07	22.98
		16QAM	1	0	23.50	23.46	23.16	22.87
			1	24	23.50	23.48	23.32	22.96
			1	49	23.50	23.38	23.09	22.74
			25	0	22.50	22.08	22.00	21.94
			25	12	22.50	22.05	22.02	21.98
			25	24	22.50	22.20	22.06	21.94
			50	0	22.50	22.13	22.07	21.88

Band	Band Width	Modulation	RB Configuration		Tune-up	Channel/Frequency(MHz)		
			RB Size	RB Offset		23755/706.5	23790/710	23825/713.5
LTE Band XVII	5MHz	QPSK	1	0	24.50	23.93	23.90	23.85
			1	12	24.50	24.26	24.29	24.28
			1	24	24.50	23.86	23.83	23.81
			12	0	23.50	22.99	22.92	22.95
			12	6	23.50	23.07	22.98	22.93
			12	11	23.50	23.02	22.84	22.87
			25	0	23.50	23.10	23.01	22.89
		16QAM	1	0	24.50	23.28	23.43	23.18
			1	12	24.50	23.64	23.99	23.53
			1	24	24.50	23.26	23.38	23.04
			12	0	22.50	22.04	21.91	21.91
			12	6	22.50	22.11	22.06	21.96
			12	11	22.50	22.10	21.95	21.85
			25	0	22.50	21.97	21.88	21.93
Band	Band Width	Modulation	RB Configuration		Tune-up	Channel/Frequency(MHz)		
			RB Size	RB Offset		23780/709	23790/710	23800/711
LTE Band XVII	10MHz	QPSK	1	0	24.50	23.99	24.03	23.97
			1	24	24.50	24.11	24.07	24.12
			1	49	24.50	23.97	23.89	23.87
			25	0	23.50	22.94	22.94	22.95
			25	12	23.50	23.07	23.03	22.98
			25	24	23.50	22.95	22.93	22.89
			50	0	23.50	22.97	22.96	22.92
		16QAM	1	0	24.50	22.85	23.47	23.12
			1	24	24.50	22.95	23.51	23.25
			1	49	24.50	22.74	23.25	22.99
			25	0	22.50	21.90	21.91	21.91
			25	12	22.50	22.01	22.01	22.03
			25	24	22.50	22.00	21.95	21.90
			50	0	22.50	21.93	21.90	21.91

### 7.4. WLAN & Bluetooth Output Power

#### 7.4.1. Output Power Results Of WLAN

Mode	Channel	Frequency (MHz)	Tune-up	Output Power (dBm)
802.11b	1	2412	15.50	14.99
	6	2437	15.50	15.04
	11	2462	15.50	15.46
802.11g	1	2412	14.50	14.01
	6	2437	14.50	14.40
	11	2462	14.50	14.35
802.11n HT20	1	2412	14.50	13.82
	6	2437	14.50	14.41
	11	2462	14.50	14.55
802.11n HT40	3	2422	14.50	13.48
	6	2437	14.50	13.70
	9	2452	14.50	14.11

NOTE: Power measurement results of WLAN 2.4G.

#### 7.4.2. Output Power Results Of Bluetooth

BR+EDR	Output Power (dBm)				
	Channel	Tune-up	Data Rates		
			1M	2M	3M
	0CH	5.000	4.623	3.482	3.183
	39CH	5.000	4.786	3.536	3.717
	78CH	3.000	2.378	1.372	1.298

BLE	Channel	Tune-up	Output Power (dBm)
	0CH	5.000	4.203
	19CH	5.000	4.435
	39CH	3.000	2.159

### 8. Antenna Location

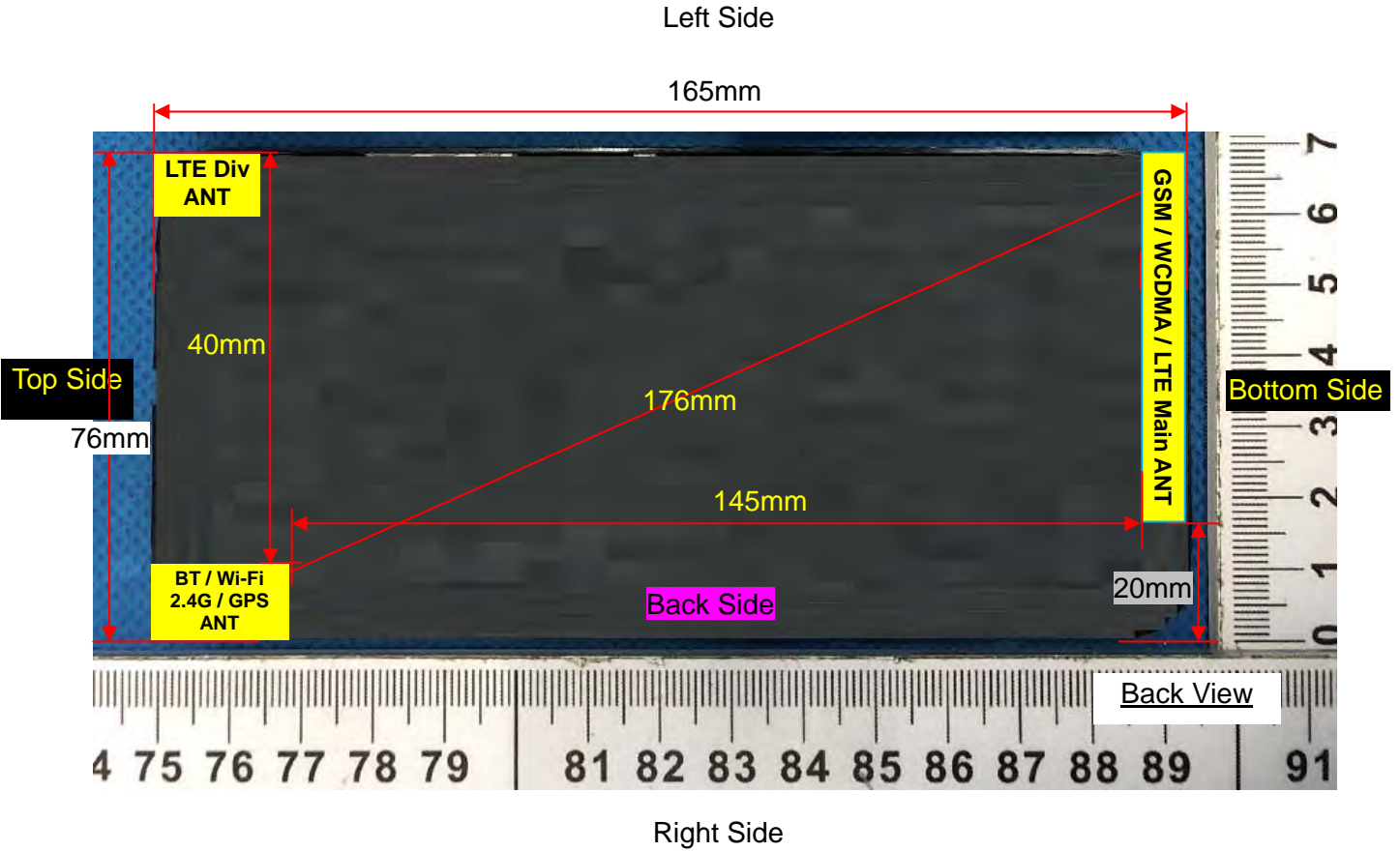

Distance of the Antenna to the EUT surface/edge						
Antennas	Front Side	Back Side	Left Side	Right Side	Top Side	Bottom Side
WWAN Main	≤ 25mm	≤ 25mm	≤ 25mm	≤ 25mm	>25mm	≤ 25mm
WLAN & Bluetooth	≤ 25mm	≤ 25mm	>25mm	≤ 25mm	≤ 25mm	>25mm
Positions for SAR tests						
Antennas	Front Side	Back Side	Left Side	Right Side	Top Side	Bottom Side
WWAN Main	Yes	Yes	Yes	Yes	NO	Yes
WLAN & Bluetooth	Yes	Yes	NO	Yes	Yes	NO

### 9. Stand-alone SAR test exclusion

Refer to FCC KDB 447498D01, the 1-g SAR and 10-g SAR test exclusion thresholds for 100 MHz to 6 GHz at test separation distances  $\leq 50$  mm are determined by:

$[(\text{max. power of channel, including tune-up tolerance, mW})/(\text{min. test separation distance, mm})] \cdot [\sqrt{f_{\text{(GHz)}}}] \leq 3.0$  for 1-g SAR and  $\leq 7.5$  for 10-g extremity SAR, where:

- $f_{\text{(GHz)}}$  is the RF channel transmit frequency in GHz
- Power and distance are rounded to the nearest mW and mm before calculation
- The result is rounded to one decimal place for comparison

When the minimum test separation distance is  $< 5$  mm, a distance of 5 mm is applied to determine SAR test exclusion.

Mode	$P_{\text{max}}$ (dBm)	$P_{\text{max}}$ (mW)	Distance (mm)	f (GHz)	Calculation Result	SAR Exclusion threshold	SAR test exclusion
Bluetooth	5.00	3.16	5	2.480	1.00	3.0	Yes

NOTE: Standalone SAR test exclusion for Bluetooth

When standalone SAR test exclusion applies to an antenna that transmits simultaneously with other antennas, the standalone SAR must be estimated according to following to determine simultaneous transmission SAR test exclusion:

$[(\text{max. power of channel, including tune-up tolerance, mW})/(\text{min. test separation distance, mm})] \cdot [\sqrt{f_{\text{(GHz)}}/x}] \text{ W/kg}$  for test separation distances  $\leq 50$ mm, where  $x = 7.5$  for 1-g SAR and  $x = 18.75$  for 10-g SAR.

When the minimum test separation distance is  $< 5$  mm, a distance of 5 mm is applied to determine SAR test exclusion.

Mode	Position	$P_{\text{max}}$ (dBm)	$P_{\text{max}}$ (mW)	Distance (mm)	f (GHz)	x	Estimated SAR (W/Kg)
Bluetooth	Head	5.00	3.16	5	2.480	7.5	0.133
Bluetooth	Body	5.00	3.16	10	2.480	7.5	0.066
Bluetooth	Hotspot	5.00	3.16	10	2.480	7.5	0.066

NOTE: Estimated SAR calculation for Bluetooth



## 10. SAR Results

### 10.1. SAR measurement results

#### 10.1.1. SAR measurement Result of GSM850

Test Position of Head	Test channel /Freq.	Test Mode	SAR Value (W/kg)		Power Drift (±5%)	Conducted power (dBm)	Tune-up power (dBm)	Scaled SAR 1g (W/Kg)
			1g	10g				
Left Cheek	189/836.4	GPRS(GMSK 4TS)	0.116	0.090	4.54	29.06	29.50	0.128
Left Tilt 15 Degree	189/836.4	GPRS(GMSK 4TS)	0.062	0.041	-1.13	29.06	29.50	0.069
Right Cheek	189/836.4	GPRS(GMSK 4TS)	0.129	0.100	0.51	29.06	29.50	0.143
Right Tilt 15 Degree	189/836.4	GPRS(GMSK 4TS)	0.068	0.042	0.25	29.06	29.50	0.075

NOTE: Head SAR test results of GSM850.

Test Position of Body-Worn with 10mm	Test channel /Freq.	Test Mode	SAR Value (W/kg)		Power Drift (±5%)	Conducted power (dBm)	Tune-up power (dBm)	Scaled SAR 1g (W/Kg)
			1g	10g				
Front Side	189/836.4	GPRS(GMSK 4TS)	0.100	0.065	-1.01	29.06	29.50	0.111
Back Side	189/836.4	GPRS(GMSK 4TS)	0.279	0.156	0.37	29.06	29.50	0.309

NOTE: Body-Worn SAR test results of GSM850

Test Position of Hotspot with 10mm	Test channel /Freq.	Test Mode	SAR Value (W/kg)		Power Drift (±5%)	Conducted power (dBm)	Tune-up power (dBm)	Scaled SAR 1g (W/Kg)
			1g	10g				
Front Side	189/836.4	GPRS(GMSK 4TS)	0.100	0.065	-1.01	29.06	29.50	0.111
Back Side	189/836.4	GPRS(GMSK 4TS)	0.279	0.156	0.37	29.06	29.50	0.309
Left Side	189/836.4	GPRS(GMSK 4TS)	0.049	0.028	-1.13	29.06	29.50	0.054
Right Side	189/836.4	GPRS(GMSK 4TS)	0.052	0.031	0.25	29.06	29.50	0.058
Bottom Side	189/836.4	GPRS(GMSK 4TS)	0.114	0.078	2.31	29.06	29.50	0.126

NOTE: Hotspot SAR test results of GSM850

#### 10.1.2. SAR measurement Result of GSM1900

Test Position of Head	Test channel /Freq.	Test Mode	SAR Value (W/kg)		Power Drift (±5%)	Conducted power (dBm)	Tune-up power (dBm)	Scaled SAR 1g (W/Kg)
			1g	10g				
Left Cheek	661/1880	GPRS(GMSK 4TS)	0.080	0.052	-0.19	26.17	27.00	0.097

Left Tilt 15 Degree	661/1880	GPRS(GMSK 4TS)	0.040	0.025	-1.31	26.17	27.00	0.048
Right Cheek	661/1880	GPRS(GMSK 4TS)	0.094	0.061	0.31	26.17	27.00	0.114
Right Tilt 15 Degree	661/1880	GPRS(GMSK 4TS)	0.051	0.030	0.85	26.17	27.00	0.062

NOTE: Head SAR test results of GSM1900

Test Position of Body-Worn with 10mm	Test channel /Freq.	Test Mode	SAR Value (W/kg)		Power Drift (±5%)	Conducted power (dBm)	Tune-up power (dBm)	Scaled SAR 1g (W/Kg)
			1g	10g				
Front Side	661/1880	GPRS(GMSK 4TS)	0.478	0.255	-0.24	26.17	27.00	0.579
Back Side	661/1880	GPRS(GMSK 4TS)	0.567	0.303	-1.30	26.17	27.00	0.686

NOTE: Body-Worn SAR test results of GSM1900

Test Position of Hotspot with 10mm	Test channel /Freq.	Test Mode	SAR Value (W/kg)		Power Drift (±5%)	Conducted power (dBm)	Tune-up power (dBm)	Scaled SAR 1g (W/Kg)
			1g	10g				
Front Side	661/1880	GPRS(GMSK 4TS)	0.478	0.255	-0.24	26.17	27.00	0.579
Back Side	661/1880	GPRS(GMSK 4TS)	0.567	0.303	-1.30	26.17	27.00	0.686
Left Side	661/1880	GPRS(GMSK 4TS)	0.162	0.094	-2.13	26.17	27.00	0.196
Right Side	661/1880	GPRS(GMSK 4TS)	0.131	0.076	0.25	26.17	27.00	0.159
Bottom Side	661/1880	GPRS(GMSK 4TS)	0.642	0.348	-0.82	26.17	27.00	0.777

NOTE: Hotspot SAR test results of GSM1900

### 10.1.3. SAR measurement Result of WCDMA Band V

Test Position of Head	Test channel /Freq.	Test Mode	SAR Value (W/kg)		Power Drift (±5%)	Conducted power (dBm)	Tune-up power (dBm)	Scaled SAR 1g (W/Kg)
			1g	10g				
Left Cheek	4182/836.4	RMC12.2K	0.069	0.054	0.39	23.17	23.50	0.074
Left Tilt 15 Degree	4182/836.4	RMC12.2K	0.034	0.022	-1.13	23.17	23.50	0.037
Right Cheek	4182/836.4	RMC12.2K	0.073	0.057	4.66	23.17	23.50	0.079
Right Tilt 15 Degree	4182/836.4	RMC12.2K	0.042	0.023	0.52	23.17	23.50	0.045

NOTE: Head SAR test results of WCDMA Band V

Test Position of Body-Worn with 10mm	Test channel /Freq.	Test Mode	SAR Value (W/kg)		Power Drift (±5%)	Conducted power (dBm)	Tune-up power (dBm)	Scaled SAR 1g (W/Kg)
			1g	10g				

Front Side	4182/836.4	RMC12.2K	0.069	0.044	-0.23	23.17	23.50	0.074
Back Side	4182/836.4	RMC12.2K	0.185	0.104	2.17	23.17	23.50	0.200

NOTE: Body-Worn SAR test results of WCDMA Band V

Test Position of Hotspot with 10mm	Test channel /Freq.	Test Mode	SAR Value (W/kg)		Power Drift (±5%)	Conducted power (dBm)	Tune-up power (dBm)	Scaled SAR 1g (W/Kg)
			1g	10g				
Front Side	4182/836.4	RMC12.2K	0.069	0.044	-0.23	23.17	23.50	0.074
Back Side	4182/836.4	RMC12.2K	0.185	0.104	2.17	23.17	23.50	0.200
Left Side	4182/836.4	RMC12.2K	0.051	0.032	-1.53	23.17	23.50	0.055
Right Side	4182/836.4	RMC12.2K	0.038	0.027	0.28	23.17	23.50	0.041
Bottom Side	4182/836.4	RMC12.2K	0.098	0.054	-1.13	23.17	23.50	0.106

NOTE: Hotspot SAR test results of WCDMA Band V

**10.1.4. SAR measurement Result of WCDMA Band IV**

Test Position of Head	Test channel /Freq.	Test Mode	SAR Value (W/kg)		Power Drift (±5%)	Conducted power (dBm)	Tune-up power (dBm)	Scaled SAR 1g (W/Kg)
			1g	10g				
Left Cheek	1413/1732.6	RMC12.2K	0.117	0.068	-2.13	23.10	23.50	0.128
Left Tilt 15 Degree	1413/1732.6	RMC12.2K	0.067	0.040	0.58	23.10	23.50	0.073
Right Cheek	1413/1732.6	RMC12.2K	0.208	0.130	0.49	23.10	23.50	0.228
Right Tilt 15 Degree	1413/1732.6	RMC12.2K	0.086	0.048	-2.26	23.10	23.50	0.094

NOTE: Head SAR test results of WCDMA Band IV

Test Position of Body-Worn with 10mm	Test channel /Freq.	Test Mode	SAR Value (W/kg)		Power Drift (±5%)	Conducted power (dBm)	Tune-up power (dBm)	Scaled SAR 1g (W/Kg)
			1g	10g				
Front Side	1413/1732.6	RMC12.2K	0.651	0.358	-2.13	23.10	23.50	0.714
Back Side	1413/1732.6	RMC12.2K	1.063	0.580	-1.24	23.10	23.50	1.166
Back Side - Repeated	1413/1732.6	RMC12.2K	1.050	0.569	-2.15	23.10	23.50	1.151
Back Side	1312/1712.4	RMC12.2K	1.060	0.582	0.33	23.19	23.50	1.138
Back Side	1513/1752.6	RMC12.2K	0.953	0.516	-0.18	23.07	23.50	1.052

NOTE: Body-Worn SAR test results of WCDMA Band IV

Test Position of Hotspot with 10mm	Test channel /Freq.	Test Mode	SAR Value (W/kg)		Power Drift (±5%)	Conducted power (dBm)	Tune-up power (dBm)	Scaled SAR 1g (W/Kg)
			1g	10g				
Front Side	1413/1732.6	RMC12.2K	0.651	0.358	-2.13	23.10	23.50	0.714

Back Side	1413/1732.6	RMC12.2K	1.063	0.580	-1.24	23.10	23.50	1.166
Back Side - Repeated	1413/1732.6	RMC12.2K	1.050	0.569	-2.15	23.10	23.50	1.151
Left Side	1413/1732.6	RMC12.2K	0.286	0.159	-2.13	23.10	23.50	0.314
Right Side	1413/1732.6	RMC12.2K	0.351	0.186	0.58	23.10	23.50	0.385
Bottom Side	1413/1732.6	RMC12.2K	1.016	0.569	-0.33	23.10	23.50	1.114
Back Side	1312/1712.4	RMC12.2K	1.060	0.582	0.33	23.19	23.50	1.138
Back Side	1513/1752.6	RMC12.2K	0.953	0.516	-0.18	23.07	23.50	1.052
Bottom Side	1312/1712.4	RMC12.2K	0.889	0.502	-1.05	23.19	23.50	0.955
Bottom Side	1513/1752.6	RMC12.2K	1.023	0.538	-2.00	23.07	23.50	1.129

NOTE: Hotspot SAR test results of WCDMA Band IV

**10.1.5. SAR measurement Result of WCDMA Band II**

Test Position of Head	Test channel /Freq.	Test Mode	SAR Value (W/kg)		Power Drift (±5%)	Conducted power (dBm)	Tune-up power (dBm)	Scaled SAR 1g (W/Kg)
			1g	10g				
Left Cheek	9400/1880	RMC12.2K	0.130	0.080	1.12	23.56	24.00	0.144
Left Tilt 15 Degree	9400/1880	RMC12.2K	0.056	0.031	-0.15	23.56	24.00	0.062
Right Cheek	9400/1880	RMC12.2K	0.144	0.087	2.79	23.56	24.00	0.159
Right Tilt 15 Degree	9400/1880	RMC12.2K	0.069	0.040	0.88	23.56	24.00	0.076

NOTE: Head SAR test results of WCDMA Band II

Test Position of Body-Worn with 10mm	Test channel /Freq.	Test Mode	SAR Value (W/kg)		Power Drift (±5%)	Conducted power (dBm)	Tune-up power (dBm)	Scaled SAR 1g (W/Kg)
			1g	10g				
Front Side	9400/1880	RMC12.2K	0.648	0.363	1.38	23.56	24.00	0.717
Back Side	9400/1880	RMC12.2K	0.776	0.421	1.15	23.56	24.00	0.859
Back Side	9262/1852.4	RMC12.2K	0.648	0.363	1.38	23.44	24.00	0.737
Back Side	9538/1907.6	RMC12.2K	0.775	0.421	1.13	23.42	24.00	0.886

NOTE: Body-Worn SAR test results of WCDMA Band II

Test Position of Hotspot with 10mm	Test channel /Freq.	Test Mode	SAR Value (W/kg)		Power Drift (±5%)	Conducted power (dBm)	Tune-up power (dBm)	Scaled SAR 1g (W/Kg)
			1g	10g				
Front Side	9400/1880	RMC12.2K	0.648	0.363	1.38	23.56	24.00	0.717
Back Side	9400/1880	RMC12.2K	0.776	0.421	1.13	23.56	24.00	0.859
Left Side	9400/1880	RMC12.2K	0.320	0.158	-1.13	23.56	24.00	0.354
Right Side	9400/1880	RMC12.2K	0.295	0.156	0.20	23.56	24.00	0.326
Bottom Side	9400/1880	RMC12.2K	0.867	0.470	-0.15	23.56	24.00	0.959

Back Side	9262/1852.4	RMC12.2K	0.648	0.363	1.38	23.44	24.00	0.737
Back Side	9538/1907.6	RMC12.2K	0.775	0.421	1.13	23.42	24.00	0.886
Bottom Side	9262/1852.4	RMC12.2K	0.910	0.505	-2.00	23.44	24.00	1.035
Bottom Side	9538/1907.6	RMC12.2K	1.029	0.555	0.18	23.42	24.00	1.176
Bottom Side - Repeated	9538/1907.6	RMC12.2K	1.020	0.549	0.79	23.42	24.00	1.166

NOTE: Hotspot SAR test results of WCDMA Band II

**10.1.6. SAR measurement Result of LTE Band XII**

Test Position of Head	Test channel /Freq.	Test Mode	SAR Value (W/kg)		Power Drift (±5%)	Conducted power (dBm)	Tune-up power (dBm)	Scaled SAR 1g (W/Kg)
			1g	10g				
<b>1RB</b>								
Left Cheek	23095/707.5	10M QPSK(1,0)	0.049	0.040	0.53	23.48	23.50	0.049
Left Tilt 15 Degree	23095/707.5	10M QPSK(1,0)	0.028	0.020	-1.15	23.48	23.50	0.028
Right Cheek	23095/707.5	10M QPSK(1,0)	0.039	0.024	0.20	23.48	23.50	0.039
Right Tilt 15 Degree	23095/707.5	10M QPSK(1,0)	0.025	0.017	-1.10	23.48	23.50	0.025
<b>50%RB</b>								
Left Cheek	23095/707.5	1.4M QPSK(3,2)	0.048	0.041	4.05	23.15	23.50	0.052
Left Tilt 15 Degree	23095/707.5	1.4M QPSK(3,2)	0.024	0.015	-2.00	23.15	23.50	0.026
Right Cheek	23095/707.5	1.4M QPSK(3,2)	0.029	0.018	0.84	23.15	23.50	0.031
Right Tilt 15 Degree	23095/707.5	1.4M QPSK(3,2)	0.023	0.011	0.07	23.15	23.50	0.025

NOTE: Head SAR test results of LTE Band XII

Test Position of Body-Worn with 10mm	Test channel /Freq.	Test Mode	SAR Value (W/kg)		Power Drift (±5%)	Conducted power (dBm)	Tune-up power (dBm)	Scaled SAR 1g (W/Kg)
			1g	10g				
1RB								
Front Side	23095/707.5	10M QPSK(1,0)	0.042	0.021	0.05	23.48	23.50	0.042
Back Side	23095/707.5	10M QPSK(1,0)	0.090	0.071	3.04	23.48	23.50	0.090
50%RB								
Front Side	23095/707.5	1.4M QPSK(3,2)	0.035	0.022	-0.14	23.15	23.50	0.038
Back Side	23095/707.5	1.4M QPSK(3,2)	0.068	0.054	-0.48	23.15	23.50	0.074

NOTE: Body-Worn SAR test results of LTE Band XII

Test Position of Hotspot with 10mm	Test channel /Freq.	Test Mode	SAR Value (W/kg)		Power Drift (±5%)	Conducted power (dBm)	Tune-up power (dBm)	Scaled SAR 1g (W/Kg)
			1g	10g				
1RB								
Front Side	23095/707.5	10M QPSK(1,0)	0.042	0.021	0.05	23.48	23.50	0.042
Back Side	23095/707.5	10M QPSK(1,0)	0.090	0.071	3.04	23.48	23.50	0.090
Left Side	23095/707.5	10M QPSK(1,0)	0.035	0.022	-1.10	23.48	23.50	0.035
Right Side	23095/707.5	10M QPSK(1,0)	0.031	0.020	0.58	23.48	23.50	0.031
Bottom Side	23095/707.5	10M QPSK(1,0)	0.049	0.030	-2.13	23.48	23.50	0.049
50%RB								
Front Side	23095/707.5	1.4M QPSK(3,2)	0.035	0.022	-0.14	23.15	23.50	0.038
Back Side	23095/707.5	1.4M QPSK(3,2)	0.068	0.054	-0.48	23.15	23.50	0.074
Left Side	23095/707.5	1.4M QPSK(3,2)	0.028	0.015	-2.00	23.15	23.50	0.030
Right Side	23095/707.5	1.4M QPSK(3,2)	0.028	0.013	0.05	23.15	23.50	0.030
Bottom Side	23095/707.5	1.4M QPSK(3,2)	0.035	0.026	0.14	23.15	23.50	0.038

NOTE: Hotspot SAR test results of LTE Band XII



### 10.1.7. SAR measurement Result of LTE Band XVII

Test Position of Head	Test channel /Freq.	Test Mode	SAR Value (W/kg)		Power Drift ( $\pm 5\%$ )	Conducted power (dBm)	Tune-up power (dBm)	Scaled SAR 1g (W/Kg)
			1g	10g				
1RB								
Left Cheek	23790/710	10M QPSK(1,24)	0.051	0.042	4.95	24.07	24.50	0.056
Left Tilt 15 Degree	23790/710	10M QPSK(1,24)	0.025	0.015	-1.13	24.07	24.50	0.028
Right Cheek	23790/710	10M QPSK(1,24)	0.057	0.046	3.97	24.07	24.50	0.063
Right Tilt 15 Degree	23790/710	10M QPSK(1,24)	0.026	0.017	0.25	24.07	24.50	0.029
50%RB								
Left Cheek	23790/710	10M QPSK(25,12)	0.041	0.027	0.21	23.03	23.50	0.046
Left Tilt 15 Degree	23790/710	10M QPSK(25,12)	0.020	0.013	0.05	23.03	23.50	0.022
Right Cheek	23790/710	10M QPSK(25,12)	0.038	0.020	-1.13	23.03	23.50	0.042
Right Tilt 15 Degree	23790/710	10M QPSK(25,12)	0.022	0.015	0.58	23.03	23.50	0.025

NOTE: Head SAR test results of LTE Band XVII

Test Position of Body-Worn with 10mm	Test channel /Freq.	Test Mode	SAR Value (W/kg)		Power Drift ( $\pm 5\%$ )	Conducted power (dBm)	Tune-up power (dBm)	Scaled SAR 1g (W/Kg)
			1g	10g				
1RB								
Front Side	23790/710	10M QPSK(1,24)	0.057	0.046	1.07	24.07	24.50	0.063
Back Side	23790/710	10M QPSK(1,24)	0.083	0.066	1.10	24.07	24.50	0.092
50%RB								
Front Side	23790/710	10M QPSK(25,12)	0.039	0.022	3.12	23.03	23.50	0.043
Back Side	23790/710	10M	0.062	0.050	0.42	23.03	23.50	0.069



QPSK(25,12)

NOTE: Body-Worn SAR test results of LTE Band XVII

Test Position of Hotspot with 10mm	Test channel /Freq.	Test Mode	SAR Value (W/kg)		Power Drift ( $\pm 5\%$ )	Conducted power (dBm)	Tune-up power (dBm)	Scaled SAR 1g (W/Kg)
			1g	10g				
1RB								
Front Side	23790/710	10M QPSK(1,24)	0.057	0.046	1.07	24.07	24.50	0.063
Back Side	23790/710	10M QPSK(1,24)	0.083	0.066	1.10	24.07	24.50	0.092
Left Side	23790/710	10M QPSK(1,24)	0.032	0.020	1.35	24.07	24.50	0.035
Right Side	23790/710	10M QPSK(1,24)	0.035	0.022	2.05	24.07	24.50	0.039
Bottom Side	23790/710	10M QPSK(1,24)	0.048	0.031	-0.10	24.07	24.50	0.053
50%RB								
Front Side	23790/710	10M QPSK(25,12)	0.039	0.022	3.12	23.03	23.50	0.043
Back Side	23790/710	10M QPSK(25,12)	0.062	0.050	0.42	23.03	23.50	0.069
Left Side	23790/710	10M QPSK(25,12)	0.030	0.018	0.58	23.03	23.50	0.033
Right Side	23790/710	10M QPSK(25,12)	0.030	0.017	-1.10	23.03	23.50	0.033
Bottom Side	23790/710	10M QPSK(25,12)	0.042	0.029	0.84	23.03	23.50	0.047

NOTE: Hotspot SAR test results of LTE Band XVII

**10.1.8. SAR measurement Result of LTE Band V**

Test Position of Head	Test channel /Freq.	Test Mode	SAR Value (W/kg)		Power Drift ( $\pm 5\%$ )	Conducted power (dBm)	Tune-up power (dBm)	Scaled SAR 1g (W/Kg)
			1g	10g				
1RB								
Left Cheek	20525/836.5	10M QPSK(1,24)	0.059	0.047	0.68	24.23	24.50	0.063

Left Tilt 15 Degree	20525/836.5	10M QPSK(1,24)	0.028	0.015	-1.13	24.23	24.50	0.030
Right Cheek	20525/836.5	10M QPSK(1,24)	0.040	0.022	0.85	24.23	24.50	0.043
Right Tilt 15 Degree	20525/836.5	10M QPSK(1,24)	0.021	0.013	-0.30	24.23	24.50	0.022
50%RB								
Left Cheek	20525/836.5	1.4M QPSK(3,1)	0.051	0.041	2.31	24.01	24.50	0.057
Left Tilt 15 Degree	20525/836.5	1.4M QPSK(3,1)	0.025	0.013	0.25	24.01	24.50	0.028
Right Cheek	20525/836.5	1.4M QPSK(3,1)	0.035	0.021	-1.13	24.01	24.50	0.039
Right Tilt 15 Degree	20525/836.5	1.4M QPSK(3,1)	0.018	0.011	-2.54	24.01	24.50	0.020

NOTE: Head SAR test results of LTE Band V

Test Position of Body-Worn with 10mm	Test channel /Freq.	Test Mode	SAR Value (W/kg)		Power Drift (±5%)	Conducted power (dBm)	Tune-up power (dBm)	Scaled SAR 1g (W/Kg)
			1g	10g				
1RB								
Front Side	20525/836.5	10M QPSK(1,24)	0.086	0.043	-1.15	24.23	24.50	0.092
Back Side	20525/836.5	10M QPSK(1,24)	0.211	0.119	0.10	24.23	24.50	0.225
50%RB								
Front Side	20525/836.5	1.4M QPSK(3,1)	0.065	0.038	-2.10	24.01	24.50	0.073
Back Side	20525/836.5	1.4M QPSK(3,1)	0.167	0.094	0.66	24.01	24.50	0.187

NOTE: Body-Worn SAR test results of LTE Band V

Test Position of Hotspot with 10mm	Test channel /Freq.	Test Mode	SAR Value (W/kg)		Power Drift (±5%)	Conducted power (dBm)	Tune-up power (dBm)	Scaled SAR 1g (W/Kg)
			1g	10g				

1RB								
Front Side	20525/836.5	10M QPSK(1,24)	0.086	0.043	-1.15	24.23	24.50	0.092
Back Side	20525/836.5	10M QPSK(1,24)	0.211	0.119	0.10	24.23	24.50	0.225
Left Side	20525/836.5	10M QPSK(1,24)	0.053	0.031	-1.13	24.23	24.50	0.056
Right Side	20525/836.5	10M QPSK(1,24)	0.040	0.025	0.58	24.23	24.50	0.043
Bottom Side	20525/836.5	10M QPSK(1,24)	0.067	0.039	-0.89	24.23	24.50	0.071
50%RB								
Front Side	20525/836.5	1.4M QPSK(3,1)	0.065	0.038	-2.10	24.01	24.50	0.073
Back Side	20525/836.5	1.4M QPSK(3,1)	0.167	0.094	0.66	24.01	24.50	0.187
Left Side	20525/836.5	1.4M QPSK(3,1)	0.038	0.022	0.85	24.01	24.50	0.043
Right Side	20525/836.5	1.4M QPSK(3,1)	0.035	0.021	0.01	24.01	24.50	0.039
Bottom Side	20525/836.5	1.4M QPSK(3,1)	0.065	0.032	-1.16	24.01	24.50	0.073

NOTE: Hotspot SAR test results of LTE Band V

#### 10.1.9. SAR measurement Result of LTE Band IV

Test Position of Head	Test channel /Freq.	Test Mode	SAR Value (W/kg)		Power Drift (±5%)	Conducted power (dBm)	Tune-up power (dBm)	Scaled SAR 1g (W/Kg)
			1g	10g				
1RB								
Left Cheek	20175/1732.5	20M QPSK(1,49)	0.185	0.119	3.08	24.80	25.00	0.194
Left Tilt 15 Degree	20175/1732.5	20M QPSK(1,49)	0.067	0.038	-1.13	24.80	25.00	0.070
Right Cheek	20175/1732.5	20M QPSK(1,49)	0.156	0.108	0.84	24.80	25.00	0.163
Right Tilt 15 Degree	20175/1732.5	20M QPSK(1,49)	0.082	0.053	0.52	24.80	25.00	0.086
50%RB								
Left	20175/1732.5	1.4M QPSK(3,0)	0.158	0.101	-2.26	24.63	25.00	0.172

Cheek								
Left Tilt 15 Degree	20175/1732.5	1.4M QPSK(3,0)	0.058	0.031	2.00	24.63	25.00	0.063
Right Cheek	20175/1732.5	1.4M QPSK(3,0)	0.164	0.106	3.20	24.63	25.00	0.179
Right Tilt 15 Degree	20175/1732.5	1.4M QPSK(3,0)	0.076	0.042	0.26	24.63	25.00	0.083

NOTE: Head SAR test results of LTE Band IV

Test Position of Body-Worn with 10mm	Test channel /Freq.	Test Mode	SAR Value (W/kg)		Power Drift (±5%)	Conducted power (dBm)	Tune-up power (dBm)	Scaled SAR 1g (W/Kg)
			1g	10g				
1RB								
Front Side	20175/1732.5	20M QPSK(1,49)	0.462	0.253	-1.10	24.80	25.00	0.484
Back Side	20175/1732.5	20M QPSK(1,49)	0.974	0.532	-0.86	24.80	25.00	1.020
Back Side	20050/1720	20M QPSK(1,49)	1.037	0.569	0.98	24.81	25.00	1.083
Back Side - Repeated	20050/1720	20M QPSK(1,49)	0.964	0.500	-2.10	24.81	25.00	1.007
Back Side	20300/1745	20M QPSK(1,49)	0.969	0.530	-0.25	24.79	25.00	1.017
50%RB								
Front Side	20175/1732.5	1.4M QPSK(3,0)	0.410	0.253	-2.28	24.63	25.00	0.446
Back Side	20175/1732.5	1.4M QPSK(3,0)	0.862	0.463	1.20	24.63	25.00	0.939
Back Side - Repeated	20175/1732.5	1.4M QPSK(3,0)	0.850	0.461	-1.15	24.63	25.00	0.926
Back Side	20050/1720	1.4M QPSK(3,0)	0.734	0.435	-1.13	24.77	25.00	0.774
Back Side	20300/1745	1.4M QPSK(3,0)	0.759	0.417	0.58	24.51	25.00	0.850
100%RB								
Back Side	20175/1732.5	20M QPSK(100,0)	0.620	0.371	-1.16	23.02	24.00	0.777

NOTE: Body-Worn SAR test results of LTE Band IV

Test Position of Hotspot with 10mm	Test channel /Freq.	Test Mode	SAR Value (W/kg)		Power Drift (±5%)	Conducted power (dBm)	Tune-up power (dBm)	Scaled SAR 1g (W/Kg)
			1g	10g				

1RB								
Front Side	20175/1732. 5	20M QPSK(1,49)	0.462	0.253	-1.10	24.80	25.00	0.484
Back Side	20175/1732. 5	20M QPSK(1,49)	0.974	0.532	-0.86	24.80	25.00	1.020
Left Side	20175/1732. 5	20M QPSK(1,49)	0.286	0.157	-2.13	24.80	25.00	0.299
Right Side	20175/1732. 5	20M QPSK(1,49)	0.313	0.182	0.25	24.80	25.00	0.328
Bottom Side	20175/1732. 5	20M QPSK(1,49)	0.983	0.550	0.17	24.80	25.00	1.029
Back Side	20050/1720	20M QPSK(1,49)	1.037	0.569	0.98	24.81	25.00	1.083
Back Side - Repeated	20050/1720	20M QPSK(1,49)	0.964	0.500	-2.10	24.81	25.00	1.007
Back Side	20300/1745	20M QPSK(1,49)	0.969	0.530	-0.25	24.79	25.00	1.017
Bottom Side	20050/1720	20M QPSK(1,49)	0.931	0.528	-1.13	24.81	25.00	0.973
Bottom Side	20300/1745	20M QPSK(1,49)	0.965	0.560	0.50	24.79	25.00	1.013
50%RB								
Front Side	20175/1732. 5	1.4M QPSK(3,0)	0.410	0.253	-2.28	24.63	25.00	0.446
Back Side	20175/1732. 5	1.4M QPSK(3,0)	0.862	0.463	1.20	24.63	25.00	0.939
Back Side - Repeated	20175/1732. 5	1.4M QPSK(3,0)	0.850	0.461	-1.15	24.63	25.00	0.926
Left Side	20175/1732. 5	1.4M QPSK(3,0)	0.285	0.167	-1.54	24.63	25.00	0.310
Right Side	20175/1732. 5	1.4M QPSK(3,0)	0.256	0.159	0.11	24.63	25.00	0.279
Bottom Side	20175/1732. 5	1.4M QPSK(3,0)	0.779	0.436	-0.72	24.63	25.00	0.848
Back Side	20050/1720	1.4M QPSK(3,0)	0.734	0.435	-1.13	24.77	25.00	0.774
Back Side	20300/1745	1.4M QPSK(3,0)	0.759	0.417	0.58	24.51	25.00	0.850
Bottom Side	20050/1720	1.4M QPSK(3,0)	0.775	0.437	-0.30	24.77	25.00	0.817
Bottom Side	20300/1745	1.4M QPSK(3,0)	0.755	0.422	-0.10	24.51	25.00	0.845

100%RB								
Back Side	20175/1732. 5	20M QPSK(100,0)	0.620	0.371	-1.16	23.02	24.00	0.777
Bottom Side	20175/1732. 5	20M QPSK(100,0)	0.587	0.359	0.13	23.02	24.00	0.736

NOTE: Hotspot SAR test results of LTE Band IV

**10.1.10. SAR measurement Result of LTE Band II**

Test Position of Head	Test channel /Freq.	Test Mode	SAR Value (W/kg)		Power Drift (±5%)	Conducted power (dBm)	Tune-up power (dBm)	Scaled SAR 1g (W/Kg)
			1g	10g				
1RB								
Left Cheek	18900/1880	20M QPSK(1,49)	0.123	0.076	1.47	24.93	25.00	0.125
Left Tilt 15 Degree	18900/1880	20M QPSK(1,49)	0.064	0.038	-1.13	24.93	25.00	0.065
Right Cheek	18900/1880	20M QPSK(1,49)	0.129	0.080	1.44	24.93	25.00	0.131
Right Tilt 15 Degree	18900/1880	20M QPSK(1,49)	0.068	0.037	-2.28	24.93	25.00	0.069
50%RB								
Left Cheek	18900/1880	1.4M QPSK(3,2)	0.100	0.058	0.02	24.47	25.00	0.113
Left Tilt 15 Degree	18900/1880	1.4M QPSK(3,2)	0.051	0.034	0.47	24.47	25.00	0.058
Right Cheek	18900/1880	1.4M QPSK(3,2)	0.099	0.063	-1.26	24.47	25.00	0.112
Right Tilt 15 Degree	18900/1880	1.4M QPSK(3,2)	0.046	0.031	0.13	24.47	25.00	0.052

NOTE: Head SAR test results of LTE Band II

Test Position of Body-Worn with 10mm	Test channel /Freq.	Test Mode	SAR Value (W/kg)		Power Drift (±5%)	Conducted power (dBm)	Tune-up power (dBm)	Scaled SAR 1g (W/Kg)
			1g	10g				

1RB								
Front Side	18900/1880	20M QPSK(1,49)	0.670	0.377	-0.07	24.93	25.00	0.681
Back Side	18900/1880	20M QPSK(1,49)	0.831	0.446	0.41	24.93	25.00	0.845
Back Side - Repeated	18900/1880	20M QPSK(1,49)	0.813	0.441	-1.00	24.93	25.00	0.826
Back Side	18700/1860	20M QPSK(1,49)	0.811	0.418	-1.05	24.82	24.50	0.753
Back Side	19100/1900	20M QPSK(1,49)	0.765	0.386	0.65	24.79	24.50	0.716
50%RB								
Front Side	18900/1880	1.4M QPSK(3,2)	0.331	0.168	-2.00	24.47	25.00	0.374
Back Side	18900/1880	1.4M QPSK(3,2)	0.653	0.348	-0.54	24.47	25.00	0.738
100%RB								
Back Side	18900/1880	20M QPSK(100,0)	0.631	0.346	0.14	23.42	24.00	0.721

NOTE: Body-Worn SAR test results of LTE Band II

Test Position of Hotspot with 10mm	Test channel /Freq.	Test Mode	SAR Value (W/kg)		Power Drift (±5%)	Conducted power (dBm)	Tune-up power (dBm)	Scaled SAR 1g (W/Kg)
			1g	10g				
1RB								
Front Side	18900/1880	20M QPSK(1,49)	0.670	0.377	-0.07	24.93	25.00	0.681
Back Side	18900/1880	20M QPSK(1,49)	0.831	0.446	0.41	24.93	25.00	0.845
Left Side	18900/1880	20M QPSK(1,49)	0.320	0.201	-1.13	24.93	25.00	0.325
Right Side	18900/1880	20M QPSK(1,49)	0.289	0.184	0.58	24.93	25.00	0.294
Bottom Side	18900/1880	20M QPSK(1,49)	1.003	0.544	-0.46	24.93	25.00	1.019
Bottom Side - Repeated	18900/1880	20M QPSK(1,49)	0.998	0.536	-2.40	24.93	25.00	1.014
Back Side	18700/1860	20M QPSK(1,49)	0.811	0.418	-1.05	24.82	24.50	0.753
Back Side	19100/1900	20M QPSK(1,49)	0.765	0.386	0.65	24.79	24.50	0.716
Bottom Side	18700/1860	20M QPSK(1,49)	0.925	0.506	-0.73	24.82	24.50	0.859
Bottom Side	19100/1900	20M QPSK(1,49)	0.884	0.476	-1.99	24.79	24.50	0.827



50%RB								
Front Side	18900/1880	1.4M QPSK(3,2)	0.331	0.168	-2.00	24.47	25.00	0.374
Back Side	18900/1880	1.4M QPSK(3,2)	0.653	0.348	-0.54	24.47	25.00	0.738
Left Side	18900/1880	1.4M QPSK(3,2)	0.241	0.159	0.21	24.47	25.00	0.272
Right Side	18900/1880	1.4M QPSK(3,2)	0.225	0.126	1.13	24.47	25.00	0.254
Bottom Side	18900/1880	1.4M QPSK(3,2)	0.688	0.408	-0.92	24.47	25.00	0.777
100%RB								
Back Side	18900/1880	20M QPSK(100,0)	0.631	0.346	0.14	23.42	24.00	0.721
Bottom Side	18900/1880	20M QPSK(100,0)	0.576	0.323	0.58	23.42	24.00	0.658

NOTE: Hotspot SAR test results of LTE Band II

#### 10.1.11. SAR measurement Result of LTE Band VII

Test Position of Head	Test channel /Freq.	Test Mode	SAR Value (W/kg)		Power Drift (±5%)	Conducted power (dBm)	Tune-up power (dBm)	Scaled SAR 1g (W/Kg)
			1g	10g				
1RB								
Left Cheek	21100/2535	20M QPSK(1,0)	0.084	0.049	-1.52	24.96	25.00	0.085
Left Tilt 15 Degree	21100/2535	20M QPSK(1,0)	0.035	0.022	-1.00	24.96	25.00	0.035
Right Cheek	21100/2535	20M QPSK(1,0)	0.067	0.041	-1.97	24.96	25.00	0.068
Right Tilt 15 Degree	21100/2535	20M QPSK(1,0)	0.032	0.020	0.54	24.96	25.00	0.032
50%RB								
Left Cheek	21100/2535	20M QPSK(50,0)	0.062	0.035	-1.06	23.32	24.00	0.073
Left Tilt 15 Degree	21100/2535	20M QPSK(50,0)	0.030	0.018	-3.00	23.32	24.00	0.035
Right Cheek	21100/2535	20M QPSK(50,0)	0.053	0.021	0.58	23.32	24.00	0.062
Right Tilt 15	21100/2535	20M QPSK(50,0)	0.026	0.015	0.15	23.32	24.00	0.030

Degree								
--------	--	--	--	--	--	--	--	--

NOTE: Head SAR test results of LTE Band VII

Test Position of Body-Worn with 10mm	Test channel /Freq.	Test Mode	SAR Value (W/kg)		Power Drift ( $\pm 5\%$ )	Conducted power (dBm)	Tune-up power (dBm)	Scaled SAR 1g (W/Kg)
			1g	10g				
1RB								
Front Side	21100/2535	20M QPSK(1,0)	0.396	0.201	-3.00	24.96	25.00	0.400
Back Side	21100/2535	20M QPSK(1,0)	0.586	0.270	-0.47	24.96	25.00	0.591
50%RB								
Front Side	21100/2535	20M QPSK(50,0)	0.286	0.156	-2.10	23.32	24.00	0.334
Back Side	21100/2535	20M QPSK(50,0)	0.463	0.243	0.57	23.32	24.00	0.541

NOTE: Body-Worn SAR test results of LTE Band VII

Test Position of Hotspot with 10mm	Test channel /Freq.	Test Mode	SAR Value (W/kg)		Power Drift ( $\pm 5\%$ )	Conducted power (dBm)	Tune-up power (dBm)	Scaled SAR 1g (W/Kg)
			1g	10g				
1RB								
Front Side	21100/2535	20M QPSK(1,0)	0.396	0.201	-3.00	24.96	25.00	0.400
Back Side	21100/2535	20M QPSK(1,0)	0.586	0.270	-0.47	24.96	25.00	0.591
Left Side	21100/2535	20M QPSK(1,0)	0.118	0.059	-2.00	24.96	25.00	0.119
Right Side	21100/2535	20M QPSK(1,0)	0.153	0.062	0.87	24.96	25.00	0.154
Bottom Side	21100/2535	20M QPSK(1,0)	0.660	0.337	-0.53	24.96	25.00	0.666
50%RB								
Front Side	21100/2535	20M QPSK(50,0)	0.286	0.156	-2.10	23.32	24.00	0.334
Back Side	21100/2535	20M QPSK(50,0)	0.463	0.243	0.57	23.32	24.00	0.541
Left Side	21100/2535	20M QPSK(50,0)	0.098	0.059	0.26	23.32	24.00	0.115
Right Side	21100/2535	20M QPSK(50,0)	0.112	0.062	2.13	23.32	24.00	0.131
Bottom Side	21100/2535	20M QPSK(50,0)	0.580	0.295	1.62	23.32	24.00	0.678

NOTE: Hotspot SAR test results of LTE Band VII

**10.1.12. SAR measurement Result of WLAN 2.4G**

Test Position of Head	Test channel /Freq.	Test Mode	SAR Value (W/kg)		Power Drift (±5%)	Conducted power (dBm)	Tune-up power (dBm)	Scaled SAR 1g (W/Kg)
			1g	10g				
Left Cheek	6/2437	802.11 b	0.265	0.143	0.98	15.04	15.50	0.295
Left Tilt 15 Degree	6/2437	802.11 b	0.220	0.131	0.84	15.04	15.50	0.245
Right Cheek	6/2437	802.11 b	0.169	0.100	-1.10	15.04	15.50	0.188
Right Tilt 15 Degree	6/2437	802.11 b	0.151	0.098	0.98	15.04	15.50	0.168

NOTE: Head SAR test results of WLAN 2.4G

Test Position of Body-Worn with 10mm	Test channel /Freq.	Test Mode	SAR Value (W/kg)		Power Drift (±5%)	Conducted power (dBm)	Tune-up power (dBm)	Scaled SAR 1g (W/Kg)
			1g	10g				
Front Side	6/2437	802.11 b	0.108	0.062	-1.00	15.04	15.50	0.120
Back Side	6/2437	802.11 b	0.210	0.112	-4.68	15.04	15.50	0.233

NOTE: Body-Worn SAR test results of WLAN 2.4G

Test Position of Hotspot with 10mm	Test channel /Freq.	Test Mode	SAR Value (W/kg)		Power Drift (±5%)	Conducted power (dBm)	Tune-up power (dBm)	Scaled SAR 1g (W/Kg)
			1g	10g				
Front Side	6/2437	802.11 b	0.108	0.062	-1.00	15.04	15.50	0.120
Back Side	6/2437	802.11 b	0.210	0.112	-4.68	15.04	15.50	0.233
Right Side	6/2437	802.11 b	0.059	0.033	-1.54	15.04	15.50	0.066
Top Side	6/2437	802.11 b	0.035	0.022	-2.08	15.04	15.50	0.039

NOTE: Hotspot SAR test results of WLAN 2.4G

**10.2. SAR Summation Scenario**

Per KDB 447498 D01, simultaneous transmission SAR is compliant if,

- 1) Scalar SAR summation < 1.6W/kg.
- 2)  $SPLSR = (SAR_1 + SAR_2)^{1.5} / (\text{min. separation distance, mm})$ , and the peak separation distance is determined from the square root of  $[(x_1-x_2)^2 + (y_1-y_2)^2 + (z_1-z_2)^2]$ , where  $(x_1, y_1, z_1)$  and  $(x_2, y_2, z_2)$  are the coordinates of the extrapolated peak SAR locations in the zoom scan. If  $SPLSR \leq 0.04$ , simultaneously transmission SAR measurement is not necessary.

Test Position	Scaled SAR <sub>MAX</sub>	∑ 1-g SAR	SPLSR	Remark
---------------	---------------------------	-----------	-------	--------

		GSM 850	WLAN 2.4G	(W/Kg)		
Head	Left Cheek	0.128	0.295	0.423	N/A	N/A
	Left Tilt 15 Degree	0.069	0.245	0.313	N/A	N/A
	Right Cheek	0.143	0.188	0.331	N/A	N/A
	Right Tilt 15 Degree	0.075	0.168	0.243	N/A	N/A
Body-Worn	Front Side	0.111	0.120	0.231	N/A	N/A
	Back Side	0.309	0.233	0.542	N/A	N/A
Hotspot	Front Side	0.111	0.120	0.231	N/A	N/A
	Back Side	0.309	0.233	0.542	N/A	N/A
	Left Side	0.054	N/A	0.054	N/A	N/A
	Right Side	0.058	0.066	0.123	N/A	N/A
	Top Side	N/A	0.039	0.039	N/A	N/A
	Bottom Side	0.126	N/A	0.126	N/A	N/A

NOTE: 1-g SAR Simultaneous Tx Combination of GSM850 and WLAN 2.4G.

Test Position		Scaled SAR <sub>MAX</sub>		Σ 1-g SAR (W/Kg)	SPLSR	Remark
		GSM 1900	WLAN 2.4G			
Head	Left Cheek	0.097	0.295	0.391	N/A	N/A
	Left Tilt 15 Degree	0.048	0.245	0.293	N/A	N/A
	Right Cheek	0.114	0.188	0.302	N/A	N/A
	Right Tilt 15 Degree	0.062	0.168	0.230	N/A	N/A
Body-Worn	Front Side	0.579	0.120	0.699	N/A	N/A
	Back Side	0.686	0.233	0.920	N/A	N/A
Hotspot	Front Side	0.579	0.120	0.699	N/A	N/A
	Back Side	0.686	0.233	0.920	N/A	N/A
	Left Side	0.196	N/A	0.196	N/A	N/A
	Right Side	0.159	0.066	0.224	N/A	N/A
	Top Side	N/A	0.039	0.039	N/A	N/A
	Bottom Side	0.777	N/A	0.777	N/A	N/A

NOTE: 1-g SAR Simultaneous Tx Combination of GSM1900 and WLAN 2.4G.

Test Position		Scaled SAR <sub>MAX</sub>		Σ 1-g SAR (W/Kg)	SPLSR	Remark
		WCDMA Band V	WLAN 2.4G			
Head	Left Cheek	0.074	0.295	0.369	N/A	N/A
	Left Tilt 15 Degree	0.037	0.245	0.281	N/A	N/A
	Right Cheek	0.079	0.188	0.267	N/A	N/A
	Right Tilt 15 Degree	0.045	0.168	0.213	N/A	N/A
Body-Worn	Front Side	0.074	0.120	0.195	N/A	N/A

	Back Side	0.200	0.233	0.433	N/A	N/A
Hotspot	Front Side	0.074	0.120	0.195	N/A	N/A
	Back Side	0.200	0.233	0.433	N/A	N/A
	Left Side	0.055	N/A	0.055	N/A	N/A
	Right Side	0.041	0.066	0.107	N/A	N/A
	Top Side	N/A	0.039	0.039	N/A	N/A
	Bottom Side	0.106	N/A	0.106	N/A	N/A

NOTE: 1-g SAR Simultaneous Tx Combination of WCDMA Band V and WLAN 2.4G.

Test Position		Scaled SAR <sub>MAX</sub>		Σ 1-g SAR (W/Kg)	SPLSR	Remark
		WCDMA Band IV	WLAN 2.4G			
Head	Left Cheek	0.128	0.295	0.423	N/A	N/A
	Left Tilt 15 Degree	0.073	0.245	0.318	N/A	N/A
	Right Cheek	0.228	0.188	0.416	N/A	N/A
	Right Tilt 15 Degree	0.094	0.168	0.262	N/A	N/A
Body-Worn	Front Side	0.714	0.120	0.834	N/A	N/A
	Back Side	1.166	0.233	1.399	N/A	N/A
Hotspot	Front Side	0.714	0.120	0.834	N/A	N/A
	Back Side	1.166	0.233	1.399	N/A	N/A
	Left Side	0.314	N/A	0.314	N/A	N/A
	Right Side	0.385	0.066	0.450	N/A	N/A
	Top Side	N/A	0.039	0.039	N/A	N/A
	Bottom Side	1.129	N/A	1.129	N/A	N/A

NOTE: 1-g SAR Simultaneous Tx Combination of WCDMA Band IV and WLAN 2.4G.

Test Position		Scaled SAR <sub>MAX</sub>		Σ 1-g SAR (W/Kg)	SPLSR	Remark
		WCDMA Band II	WLAN 2.4G			
Head	Left Cheek	0.144	0.295	0.438	N/A	N/A
	Left Tilt 15 Degree	0.062	0.245	0.307	N/A	N/A
	Right Cheek	0.159	0.188	0.347	N/A	N/A
	Right Tilt 15 Degree	0.076	0.168	0.244	N/A	N/A
Body-Worn	Front Side	0.717	0.120	0.837	N/A	N/A
	Back Side	0.886	0.233	1.119	N/A	N/A
Hotspot	Front Side	0.717	0.120	0.837	N/A	N/A
	Back Side	0.886	0.233	1.119	N/A	N/A
	Left Side	0.354	N/A	0.354	N/A	N/A
	Right Side	0.326	0.066	0.392	N/A	N/A
	Top Side	N/A	0.039	0.039	N/A	N/A

	Bottom Side	1.176	N/A	1.176	N/A	N/A
--	-------------	-------	-----	-------	-----	-----

NOTE: 1-g SAR Simultaneous Tx Combination of WCDMA Band II and WLAN 2.4G.

Test Position		Scaled SAR <sub>MAX</sub>		Σ 1-g SAR (W/Kg)	SPLSR	Remark
		LTE Band V	WLAN 2.4G			
Head	Left Cheek	0.063	0.295	0.357	N/A	N/A
	Left Tilt 15 Degree	0.030	0.245	0.274	N/A	N/A
	Right Cheek	0.043	0.188	0.230	N/A	N/A
	Right Tilt 15 Degree	0.022	0.168	0.190	N/A	N/A
Body-Worn	Front Side	0.092	0.120	0.212	N/A	N/A
	Back Side	0.225	0.233	0.458	N/A	N/A
Hotspot	Front Side	0.092	0.120	0.212	N/A	N/A
	Back Side	0.225	0.233	0.458	N/A	N/A
	Left Side	0.056	N/A	0.056	N/A	N/A
	Right Side	0.043	0.066	0.108	N/A	N/A
	Top Side	N/A	0.039	0.039	N/A	N/A
	Bottom Side	0.073	N/A	0.073	N/A	N/A

NOTE: 1-g SAR Simultaneous Tx Combination of LTE Band V and WLAN 2.4G.

Test Position		Scaled SAR <sub>MAX</sub>		Σ 1-g SAR (W/Kg)	SPLSR	Remark
		LTE Band IV	WLAN 2.4G			
Head	Left Cheek	0.194	0.295	0.488	N/A	N/A
	Left Tilt 15 Degree	0.070	0.245	0.315	N/A	N/A
	Right Cheek	0.179	0.188	0.367	N/A	N/A
	Right Tilt 15 Degree	0.086	0.168	0.254	N/A	N/A
Body-Worn	Front Side	0.484	0.120	0.604	N/A	N/A
	Back Side	1.083	0.233	1.317	N/A	N/A
Hotspot	Front Side	0.484	0.120	0.604	N/A	N/A
	Back Side	1.083	0.233	1.317	N/A	N/A
	Left Side	0.310	N/A	0.310	N/A	N/A
	Right Side	0.328	0.066	0.393	N/A	N/A
	Top Side	N/A	0.039	0.039	N/A	N/A
	Bottom Side	1.029	N/A	1.029	N/A	N/A

NOTE: 1-g SAR Simultaneous Tx Combination of LTE Band IV and WLAN 2.4G.

Test Position		Scaled SAR <sub>MAX</sub>		Σ 1-g SAR (W/Kg)	SPLSR	Remark
		LTE Band II	WLAN 2.4G			
Head	Left Cheek	0.125	0.295	0.420	N/A	N/A
	Left Tilt 15 Degree	0.065	0.245	0.310	N/A	N/A

	Right Cheek	0.131	0.188	0.319	N/A	N/A
	Right Tilt 15 Degree	0.069	0.168	0.237	N/A	N/A
Body-Worn	Front Side	0.681	0.120	0.801	N/A	N/A
	Back Side	0.845	0.233	1.078	N/A	N/A
Hotspot	Front Side	0.681	0.120	0.801	N/A	N/A
	Back Side	0.845	0.233	1.078	N/A	N/A
	Left Side	0.325	N/A	0.325	N/A	N/A
	Right Side	0.294	0.066	0.359	N/A	N/A
	Top Side	N/A	0.039	0.039	N/A	N/A
	Bottom Side	1.019	N/A	1.019	N/A	N/A

NOTE: 1-g SAR Simultaneous Tx Combination of LTE Band II and WLAN 2.4G.

Test Position		Scaled SAR <sub>MAX</sub>		Σ 1-g SAR (W/Kg)	SPLSR	Remark
		LTE Band VII	WLAN 2.4G			
Head	Left Cheek	0.085	0.295	0.379	N/A	N/A
	Left Tilt 15 Degree	0.035	0.245	0.280	N/A	N/A
	Right Cheek	0.068	0.188	0.256	N/A	N/A
	Right Tilt 15 Degree	0.032	0.168	0.200	N/A	N/A
Body-Worn	Front Side	0.400	0.120	0.520	N/A	N/A
	Back Side	0.591	0.233	0.825	N/A	N/A
Hotspot	Front Side	0.400	0.120	0.520	N/A	N/A
	Back Side	0.591	0.233	0.825	N/A	N/A
	Left Side	0.119	N/A	0.119	N/A	N/A
	Right Side	0.154	0.066	0.220	N/A	N/A
	Top Side	N/A	0.039	0.039	N/A	N/A
	Bottom Side	0.678	N/A	0.678	N/A	N/A

NOTE: 1-g SAR Simultaneous Tx Combination of LTE Band VII and WLAN 2.4G.

Test Position		Scaled SAR <sub>MAX</sub>		Σ 1-g SAR (W/Kg)	SPLSR	Remark
		LTE Band XII	WLAN 2.4G			
Head	Left Cheek	0.052	0.295	0.347	N/A	N/A
	Left Tilt 15 Degree	0.028	0.245	0.273	N/A	N/A
	Right Cheek	0.039	0.188	0.227	N/A	N/A
	Right Tilt 15 Degree	0.025	0.168	0.193	N/A	N/A
Body-Worn	Front Side	0.042	0.120	0.162	N/A	N/A
	Back Side	0.090	0.233	0.324	N/A	N/A
Hotspot	Front Side	0.042	0.120	0.162	N/A	N/A



	Back Side	0.090	0.233	0.324	N/A	N/A
	Left Side	0.035	N/A	0.035	N/A	N/A
	Right Side	0.031	0.066	0.097	N/A	N/A
	Top Side	N/A	0.039	0.039	N/A	N/A
	Bottom Side	0.049	N/A	0.049	N/A	N/A

NOTE: 1-g SAR Simultaneous Tx Combination of LTE Band XII and WLAN 2.4G.

Test Position		Scaled SAR <sub>MAX</sub>		Σ 1-g SAR (W/Kg)	SPLSR	Remark
		LTE Band XVII	WLAN 2.4G			
Head	Left Cheek	0.056	0.295	0.351	N/A	N/A
	Left Tilt 15 Degree	0.028	0.245	0.272	N/A	N/A
	Right Cheek	0.063	0.188	0.251	N/A	N/A
	Right Tilt 15 Degree	0.029	0.168	0.197	N/A	N/A
Body-Worn	Front Side	0.063	0.120	0.183	N/A	N/A
	Back Side	0.092	0.233	0.325	N/A	N/A
Hotspot	Front Side	0.063	0.120	0.183	N/A	N/A
	Back Side	0.092	0.233	0.325	N/A	N/A
	Left Side	0.035	N/A	0.035	N/A	N/A
	Right Side	0.039	0.066	0.104	N/A	N/A
	Top Side	N/A	0.039	0.039	N/A	N/A
	Bottom Side	0.053	N/A	0.053	N/A	N/A

NOTE: 1-g SAR Simultaneous Tx Combination of LTE Band XVII and WLAN 2.4G.

Test Position		Scaled SAR <sub>MAX</sub>		Σ 1-g SAR (W/Kg)	SPLSR	Remark
		GSM 850	Bluetooth			
Head	Left Cheek	0.128	0.133	0.261	N/A	N/A
	Left Tilt 15 Degree	0.069	0.133	0.201	N/A	N/A
	Right Cheek	0.143	0.133	0.276	N/A	N/A
	Right Tilt 15 Degree	0.075	0.133	0.208	N/A	N/A
Body-Worn	Front Side	0.111	0.066	0.177	N/A	N/A
	Back Side	0.309	0.066	0.375	N/A	N/A
Hotspot	Front Side	0.111	0.066	0.177	N/A	N/A
	Back Side	0.309	0.066	0.375	N/A	N/A
	Left Side	0.054	N/A	0.054	N/A	N/A
	Right Side	0.058	0.066	0.124	N/A	N/A
	Top Side	N/A	0.066	0.066	N/A	N/A
	Bottom Side	0.126	N/A	0.126	N/A	N/A

NOTE: 1-g SAR Simultaneous Tx Combination of GSM850 and Bluetooth.

Test Position		Scaled SAR <sub>MAX</sub>		Σ 1-g SAR (W/Kg)	SPLSR	Remark
		GSM 1900	Bluetooth			
Head	Left Cheek	0.097	0.133	0.230	N/A	N/A
	Left Tilt 15 Degree	0.048	0.133	0.181	N/A	N/A
	Right Cheek	0.114	0.133	0.247	N/A	N/A
	Right Tilt 15 Degree	0.062	0.133	0.195	N/A	N/A
Body-Worn	Front Side	0.579	0.066	0.645	N/A	N/A
	Back Side	0.686	0.066	0.753	N/A	N/A
Hotspot	Front Side	0.579	0.066	0.645	N/A	N/A
	Back Side	0.686	0.066	0.753	N/A	N/A
	Left Side	0.196	N/A	0.196	N/A	N/A
	Right Side	0.159	0.066	0.225	N/A	N/A
	Top Side	N/A	0.066	0.066	N/A	N/A
	Bottom Side	0.777	N/A	0.777	N/A	N/A

NOTE: 1-g SAR Simultaneous Tx Combination of GSM1900 and Bluetooth.

Test Position		Scaled SAR <sub>MAX</sub>		Σ 1-g SAR (W/Kg)	SPLSR	Remark
		WCDMA Band V	Bluetooth			
Head	Left Cheek	0.074	0.133	0.207	N/A	N/A
	Left Tilt 15 Degree	0.037	0.133	0.169	N/A	N/A
	Right Cheek	0.079	0.133	0.212	N/A	N/A
	Right Tilt 15 Degree	0.045	0.133	0.178	N/A	N/A
Body-Worn	Front Side	0.074	0.066	0.141	N/A	N/A
	Back Side	0.200	0.066	0.266	N/A	N/A
Hotspot	Front Side	0.074	0.066	0.141	N/A	N/A
	Back Side	0.200	0.066	0.266	N/A	N/A
	Left Side	0.055	N/A	0.055	N/A	N/A
	Right Side	0.041	0.066	0.107	N/A	N/A
	Top Side	N/A	0.066	0.066	N/A	N/A
	Bottom Side	0.106	N/A	0.106	N/A	N/A

NOTE: 1-g SAR Simultaneous Tx Combination of WCDMA Band V and Bluetooth.

Test Position		Scaled SAR <sub>MAX</sub>		Σ 1-g SAR (W/Kg)	SPLSR	Remark
		WCDMA Band IV	Bluetooth			
Head	Left Cheek	0.128	0.133	0.261	N/A	N/A
	Left Tilt 15 Degree	0.073	0.133	0.206	N/A	N/A
	Right Cheek	0.228	0.133	0.361	N/A	N/A
	Right Tilt 15 Degree	0.094	0.133	0.227	N/A	N/A
Body-Worn	Front Side	0.714	0.066	0.780	N/A	N/A
	Back Side	1.166	0.066	1.232	N/A	N/A
Hotspot	Front Side	0.714	0.066	0.780	N/A	N/A
	Back Side	1.166	0.066	1.232	N/A	N/A
	Left Side	0.314	N/A	0.314	N/A	N/A
	Right Side	0.385	0.066	0.451	N/A	N/A
	Top Side	N/A	0.066	0.066	N/A	N/A
	Bottom Side	1.129	N/A	1.129	N/A	N/A

NOTE: 1-g SAR Simultaneous Tx Combination of WCDMA Band IV and Bluetooth.

Test Position		Scaled SAR <sub>MAX</sub>		Σ 1-g SAR (W/Kg)	SPLSR	Remark
		WCDMA Band II	Bluetooth			
Head	Left Cheek	0.144	0.133	0.277	N/A	N/A
	Left Tilt 15 Degree	0.062	0.133	0.195	N/A	N/A
	Right Cheek	0.159	0.133	0.292	N/A	N/A
	Right Tilt 15 Degree	0.076	0.133	0.209	N/A	N/A
Body-Worn	Front Side	0.717	0.066	0.783	N/A	N/A
	Back Side	0.886	0.066	0.952	N/A	N/A
Hotspot	Front Side	0.717	0.066	0.783	N/A	N/A
	Back Side	0.886	0.066	0.952	N/A	N/A
	Left Side	0.354	N/A	0.354	N/A	N/A
	Right Side	0.326	0.066	0.393	N/A	N/A
	Top Side	N/A	0.066	0.066	N/A	N/A
	Bottom Side	1.176	N/A	1.176	N/A	N/A

NOTE: 1-g SAR Simultaneous Tx Combination of WCDMA Band II and Bluetooth.

Test Position		Scaled SAR <sub>MAX</sub>		Σ 1-g SAR (W/Kg)	SPLSR	Remark
		LTE Band V	Bluetooth			
Head	Left Cheek	0.063	0.133	0.196	N/A	N/A
	Left Tilt 15 Degree	0.030	0.133	0.163	N/A	N/A

	Right Cheek	0.043	0.133	0.175	N/A	N/A
	Right Tilt 15 Degree	0.022	0.133	0.155	N/A	N/A
Body-Worn	Front Side	0.092	0.066	0.158	N/A	N/A
	Back Side	0.225	0.066	0.291	N/A	N/A
Hotspot	Front Side	0.092	0.066	0.158	N/A	N/A
	Back Side	0.225	0.066	0.291	N/A	N/A
	Left Side	0.056	N/A	0.056	N/A	N/A
	Right Side	0.043	0.066	0.109	N/A	N/A
	Top Side	N/A	0.066	0.066	N/A	N/A
	Bottom Side	0.073	N/A	0.073	N/A	N/A

NOTE: 1-g SAR Simultaneous Tx Combination of LTE Band V and Bluetooth.

Test Position		Scaled SAR <sub>MAX</sub>		Σ 1-g SAR (W/Kg)	SPLSR	Remark
		LTE Band IV	Bluetooth			
Head	Left Cheek	0.194	0.133	0.327	N/A	N/A
	Left Tilt 15 Degree	0.070	0.133	0.203	N/A	N/A
	Right Cheek	0.179	0.133	0.312	N/A	N/A
	Right Tilt 15 Degree	0.086	0.133	0.219	N/A	N/A
Body-Worn	Front Side	0.484	0.066	0.550	N/A	N/A
	Back Side	1.083	0.066	1.150	N/A	N/A
Hotspot	Front Side	0.484	0.066	0.550	N/A	N/A
	Back Side	1.083	0.066	1.150	N/A	N/A
	Left Side	0.310	N/A	0.310	N/A	N/A
	Right Side	0.328	0.066	0.394	N/A	N/A
	Top Side	N/A	0.066	0.066	N/A	N/A
	Bottom Side	1.029	N/A	1.029	N/A	N/A

NOTE: 1-g SAR Simultaneous Tx Combination of LTE Band IV and Bluetooth.

Test Position		Scaled SAR <sub>MAX</sub>		Σ 1-g SAR (W/Kg)	SPLSR	Remark
		LTE Band II	Bluetooth			
Head	Left Cheek	0.125	0.133	0.258	N/A	N/A
	Left Tilt 15 Degree	0.065	0.133	0.198	N/A	N/A
	Right Cheek	0.131	0.133	0.264	N/A	N/A
	Right Tilt 15 Degree	0.069	0.133	0.202	N/A	N/A
Body-Worn	Front Side	0.681	0.066	0.747	N/A	N/A
	Back Side	0.845	0.066	0.911	N/A	N/A
Hotspot	Front Side	0.681	0.066	0.747	N/A	N/A
	Back Side	0.845	0.066	0.911	N/A	N/A
	Left Side	0.325	N/A	0.325	N/A	N/A

	Right Side	0.294	0.066	0.360	N/A	N/A
	Top Side	N/A	0.066	0.066	N/A	N/A
	Bottom Side	1.019	N/A	1.019	N/A	N/A

NOTE: 1-g SAR Simultaneous Tx Combination of LTE Band II and Bluetooth.

Test Position		Scaled SAR <sub>MAX</sub>		Σ 1-g SAR (W/Kg)	SPLSR	Remark
		LTE Band VII	Bluetooth			
Head	Left Cheek	0.085	0.133	0.218	N/A	N/A
	Left Tilt 15 Degree	0.035	0.133	0.168	N/A	N/A
	Right Cheek	0.068	0.133	0.200	N/A	N/A
	Right Tilt 15 Degree	0.032	0.133	0.165	N/A	N/A
Body-Worn	Front Side	0.400	0.066	0.466	N/A	N/A
	Back Side	0.591	0.066	0.658	N/A	N/A
Hotspot	Front Side	0.400	0.066	0.466	N/A	N/A
	Back Side	0.591	0.066	0.658	N/A	N/A
	Left Side	0.119	N/A	0.119	N/A	N/A
	Right Side	0.154	0.066	0.221	N/A	N/A
	Top Side	N/A	0.066	0.066	N/A	N/A
	Bottom Side	0.678	N/A	0.678	N/A	N/A

NOTE: 1-g SAR Simultaneous Tx Combination of LTE Band VII and Bluetooth.

Test Position		Scaled SAR <sub>MAX</sub>		Σ 1-g SAR (W/Kg)	SPLSR	Remark
		LTE Band XII	Bluetooth			
Head	Left Cheek	0.052	0.133	0.185	N/A	N/A
	Left Tilt 15 Degree	0.028	0.133	0.161	N/A	N/A
	Right Cheek	0.039	0.133	0.172	N/A	N/A
	Right Tilt 15 Degree	0.025	0.133	0.158	N/A	N/A
Body-Worn	Front Side	0.042	0.066	0.109	N/A	N/A
	Back Side	0.090	0.066	0.157	N/A	N/A
Hotspot	Front Side	0.042	0.066	0.109	N/A	N/A
	Back Side	0.090	0.066	0.157	N/A	N/A
	Left Side	0.035	N/A	0.035	N/A	N/A
	Right Side	0.031	0.066	0.098	N/A	N/A
	Top Side	N/A	0.066	0.066	N/A	N/A
	Bottom Side	0.049	N/A	0.049	N/A	N/A

NOTE: 1-g SAR Simultaneous Tx Combination of LTE Band XII and Bluetooth.

Test Position	Scaled SAR <sub>MAX</sub>		Σ 1-g SAR	SPLSR	Remark
---------------	---------------------------	--	-----------	-------	--------

		LTE Band XVII	Bluetooth	(W/Kg)		
Head	Left Cheek	0.056	0.133	0.189	N/A	N/A
	Left Tilt 15 Degree	0.028	0.133	0.160	N/A	N/A
	Right Cheek	0.063	0.133	0.196	N/A	N/A
	Right Tilt 15 Degree	0.029	0.133	0.162	N/A	N/A
Body-Worn	Front Side	0.063	0.066	0.129	N/A	N/A
	Back Side	0.092	0.066	0.158	N/A	N/A
Hotspot	Front Side	0.063	0.066	0.129	N/A	N/A
	Back Side	0.092	0.066	0.158	N/A	N/A
	Left Side	0.035	N/A	0.035	N/A	N/A
	Right Side	0.039	0.066	0.105	N/A	N/A
	Top Side	N/A	0.066	0.066	N/A	N/A
	Bottom Side	0.053	N/A	0.053	N/A	N/A

NOTE: 1-g SAR Simultaneous Tx Combination of LTE Band XVII and Bluetooth.

### 11. Appendix A. Photo documentation

Refer to appendix Test Setup photo---SAR

### 12. Appendix B. System Check Plots

Table of contents
<b>MEASUREMENT 1 System Performance Check - SID750 - Head</b>
<b>MEASUREMENT 2 System Performance Check - SID750 - Body</b>
<b>MEASUREMENT 3 System Performance Check - SID835 - Head</b>
<b>MEASUREMENT 4 System Performance Check - SID835 - Body</b>
<b>MEASUREMENT 5 System Performance Check - SID1800 - Head</b>
<b>MEASUREMENT 6 System Performance Check - SID1800 - Body</b>
<b>MEASUREMENT 7 System Performance Check - SID1900 - Head</b>
<b>MEASUREMENT 8 System Performance Check - SID1900 - Body</b>
<b>MEASUREMENT 9 System Performance Check - SID2450 - Head</b>
<b>MEASUREMENT 10 System Performance Check - SID2450 - Body</b>
<b>MEASUREMENT 11 System Performance Check - SID2600 - Head</b>
<b>MEASUREMENT 12 System Performance Check - SID2600 - Body</b>

# MEASUREMENT 1

## A. Experimental conditions.

<b>Area Scan</b>	<u>dx=15mm dy=15mm, h= 5.00 mm</u>
<b>ZoomScan</b>	<u>5x5x7, dx=8mm dy=8mm dz=5mm</u>
<b>Phantom</b>	<u>Validation plane</u>
<b>Device Position</b>	<u>Dipole</u>
<b>Band</b>	<u>CW750</u>
<b>Channels</b>	<u>Middle</u>
<b>Signal</b>	<u>CW (Crest factor: 1.0)</u>

## B. SAR Measurement Results

<b>Frequency (MHz)</b>	750.000000
<b>Relative permittivity (real part)</b>	41.410899
<b>Relative permittivity (imaginary part)</b>	22.053779
<b>Conductivity (S/m)</b>	0.923335
<b>Variation (%)</b>	-0.640000

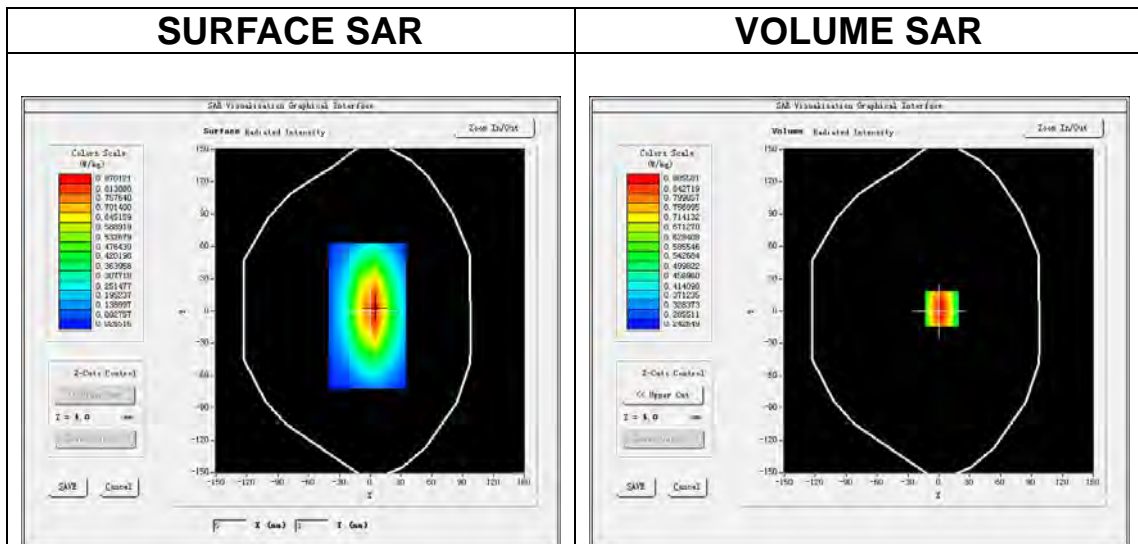

**Maximum location: X=3.00, Y=2.00**

**SAR Peak: 1.04 W/kg**

<b>SAR 10g (W/Kg)</b>	0.537268
<b>SAR 1g (W/Kg)</b>	0.844722



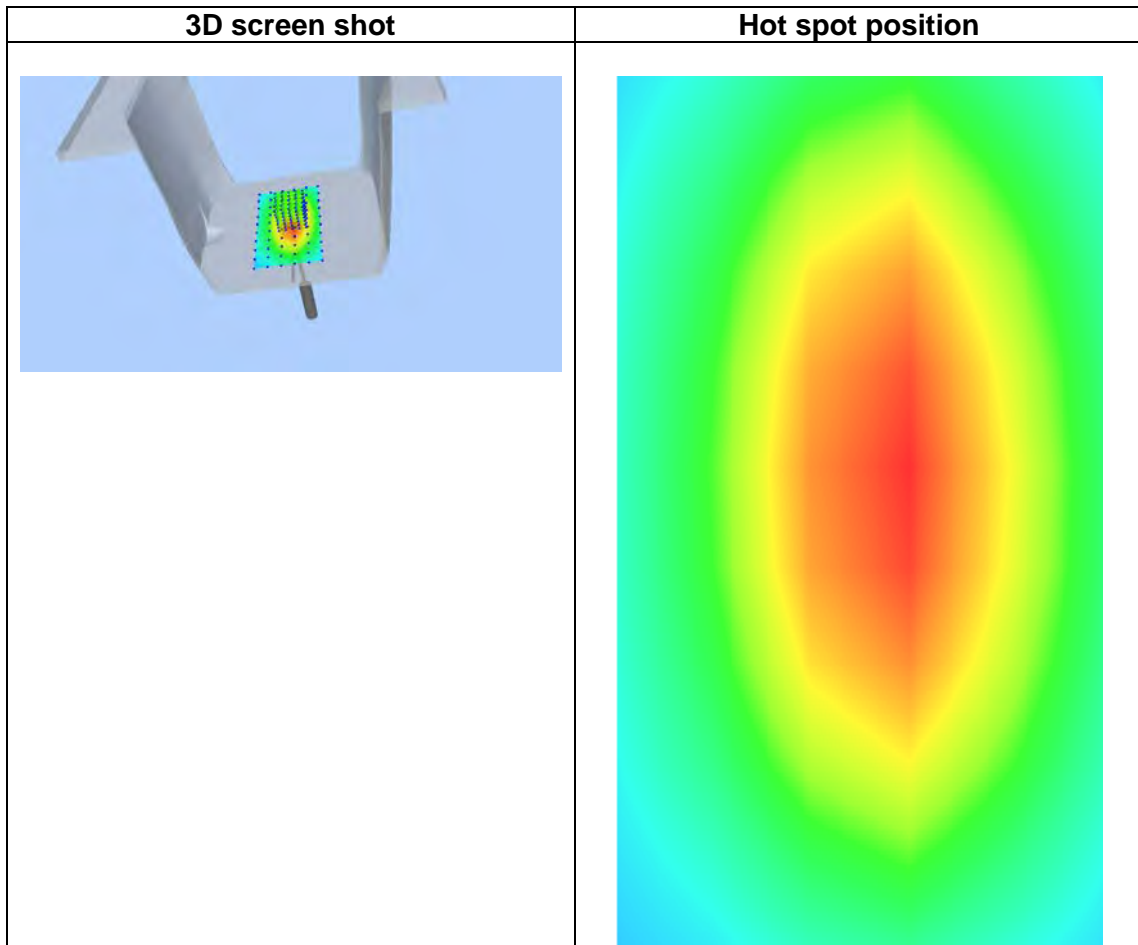
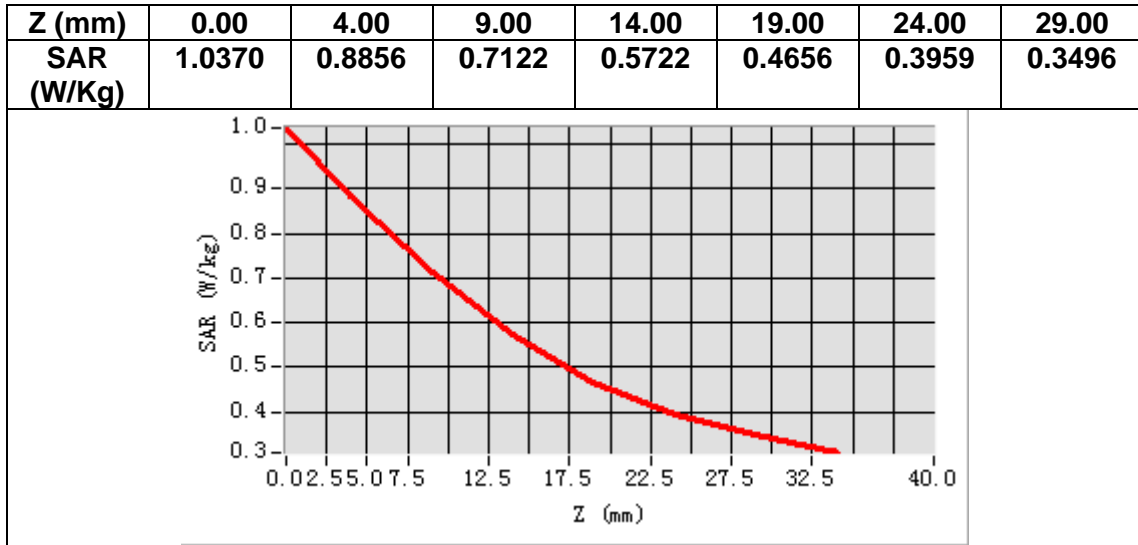

## MEASUREMENT 2

### A. Experimental conditions.

<b>Area Scan</b>	<u>dx=15mm dy=15mm, h= 5.00 mm</u>
<b>ZoomScan</b>	<u>5x5x7, dx=8mm dy=8mm dz=5mm</u>
<b>Phantom</b>	<u>Validation plane</u>
<b>Device Position</b>	<u>Dipole</u>
<b>Band</b>	<u>CW750</u>
<b>Channels</b>	<u>Middle</u>
<b>Signal</b>	<u>CW (Crest factor: 1.0)</u>

### B. SAR Measurement Results

<b>Frequency (MHz)</b>	750.000000
<b>Relative permittivity (real part)</b>	55.420899
<b>Relative permittivity (imaginary part)</b>	23.469000
<b>Conductivity (S/m)</b>	0.983335
<b>Variation (%)</b>	-0.200000

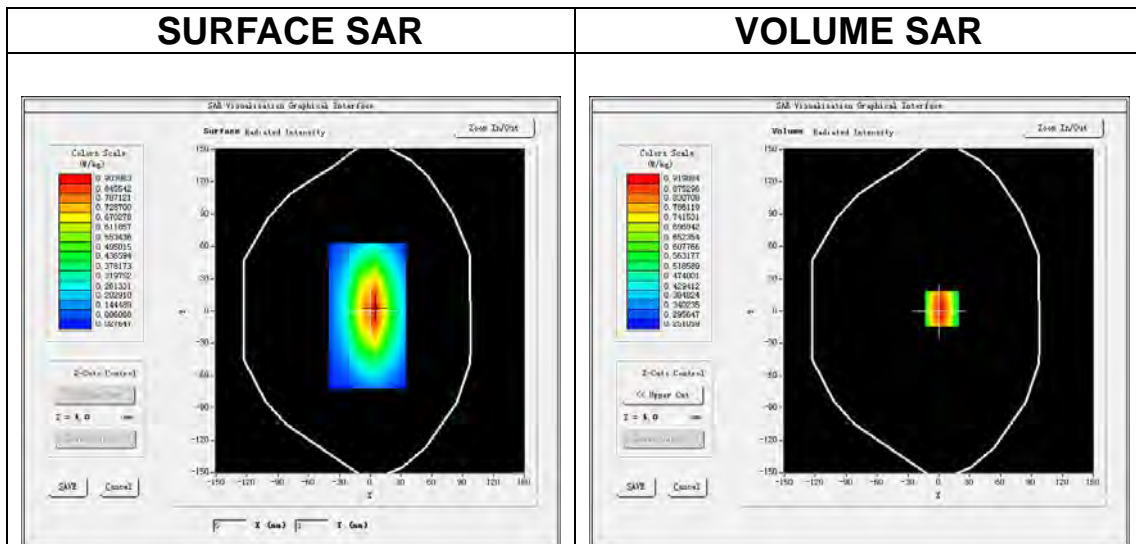

**Maximum location: X=3.00, Y=2.00**

**SAR Peak: 1.09 W/kg**

<b>SAR 10g (W/Kg)</b>	0.560840
<b>SAR 1g (W/Kg)</b>	0.877060

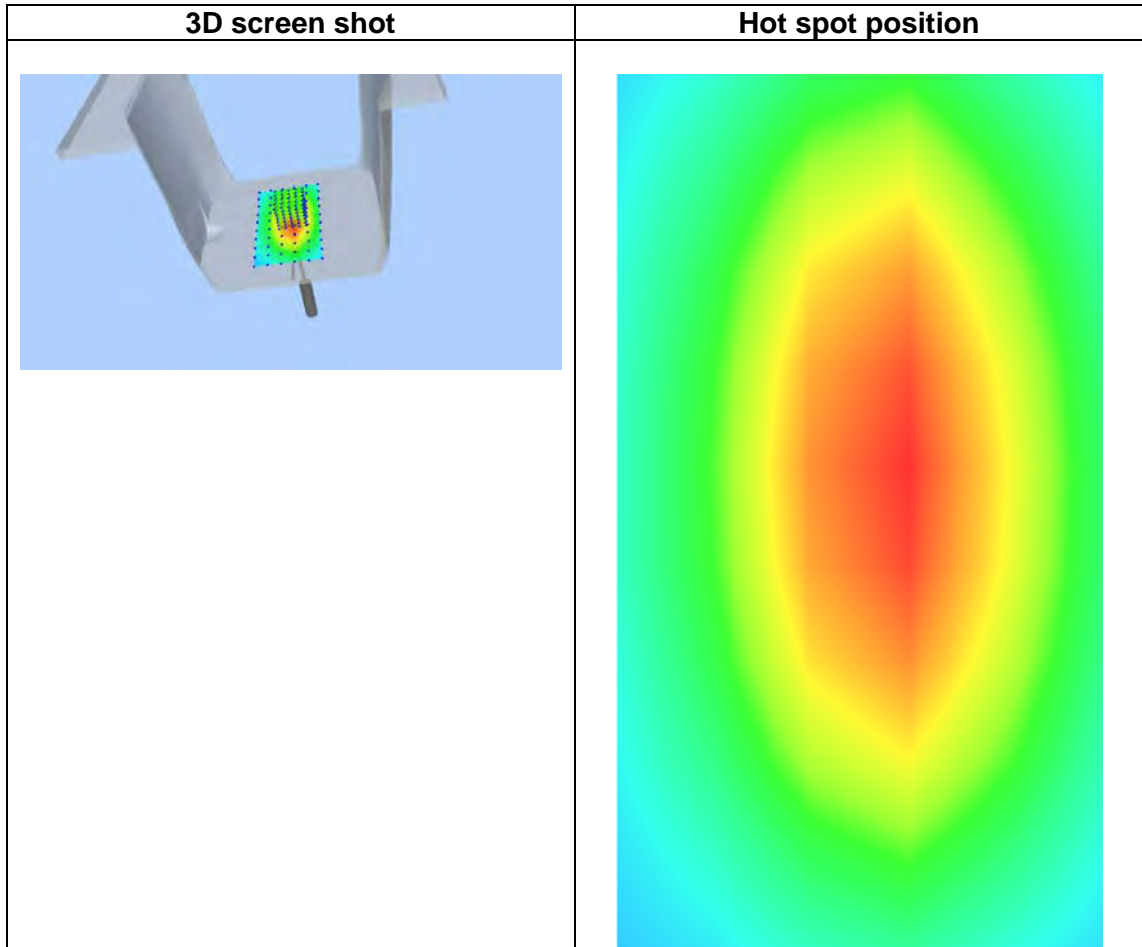
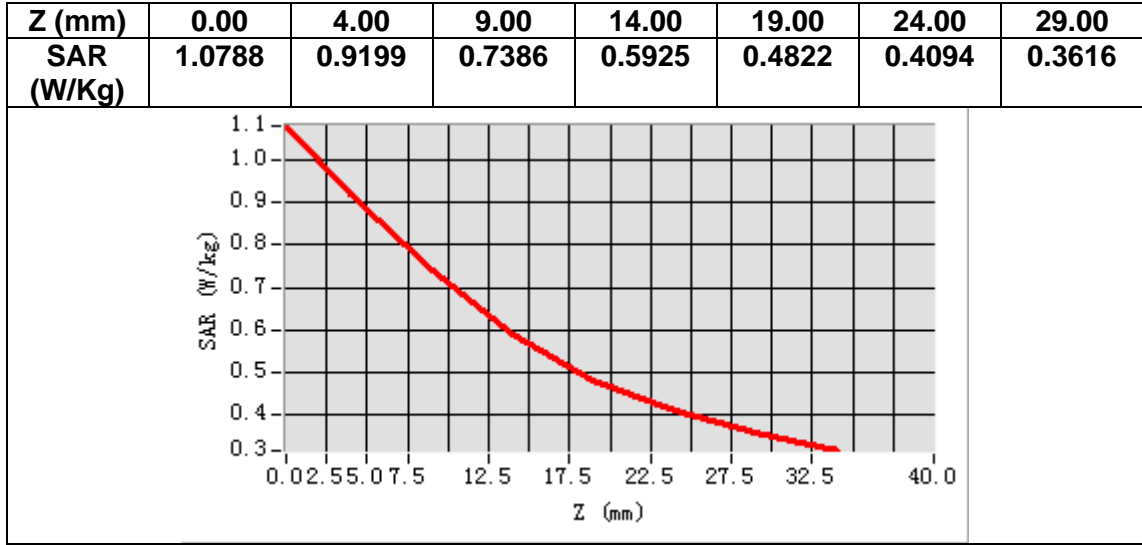

# MEASUREMENT 3

## A. Experimental conditions.

<b>Area Scan</b>	<u>dx=15mm dy=15mm, h= 5.00 mm</u>
<b>ZoomScan</b>	<u>5x5x7, dx=8mm dy=8mm dz=5mm</u>
<b>Phantom</b>	<u>Validation plane</u>
<b>Device Position</b>	<u>Dipole</u>
<b>Band</b>	<u>CW835</u>
<b>Channels</b>	<u>Middle</u>
<b>Signal</b>	<u>CW (Crest factor: 1.0)</u>

## B. SAR Measurement Results

<b>Frequency (MHz)</b>	835.000000
<b>Relative permittivity (real part)</b>	41.869426
<b>Relative permittivity (imaginary part)</b>	19.485400
<b>Conductivity (S/m)</b>	0.903594
<b>Variation (%)</b>	0.200000

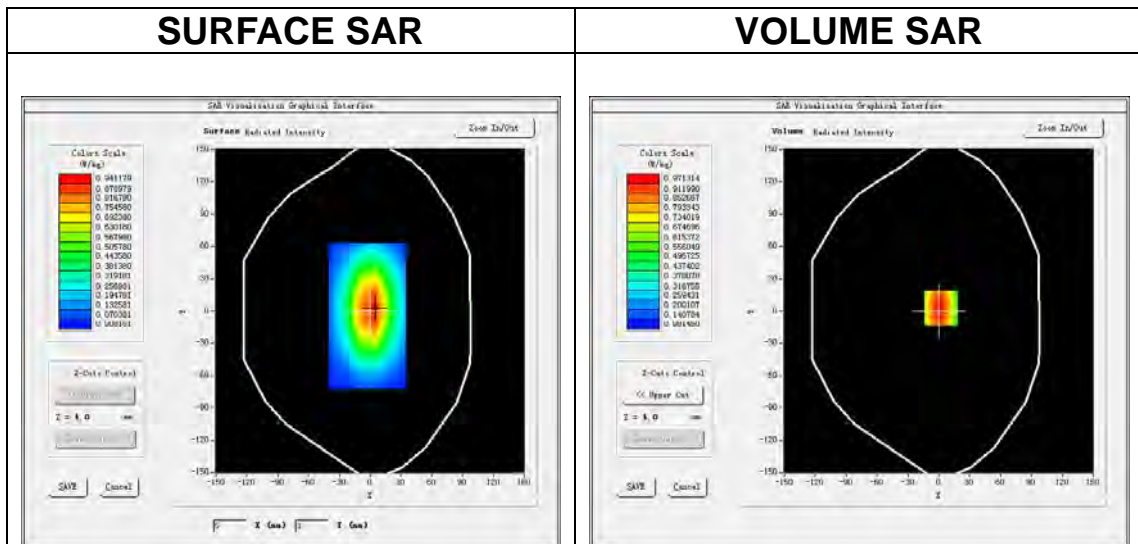

**Maximum location: X=2.00, Y=3.00**

**SAR Peak: 1.34 W/kg**

<b>SAR 10g (W/Kg)</b>	0.619872
<b>SAR 1g (W/Kg)</b>	0.954770

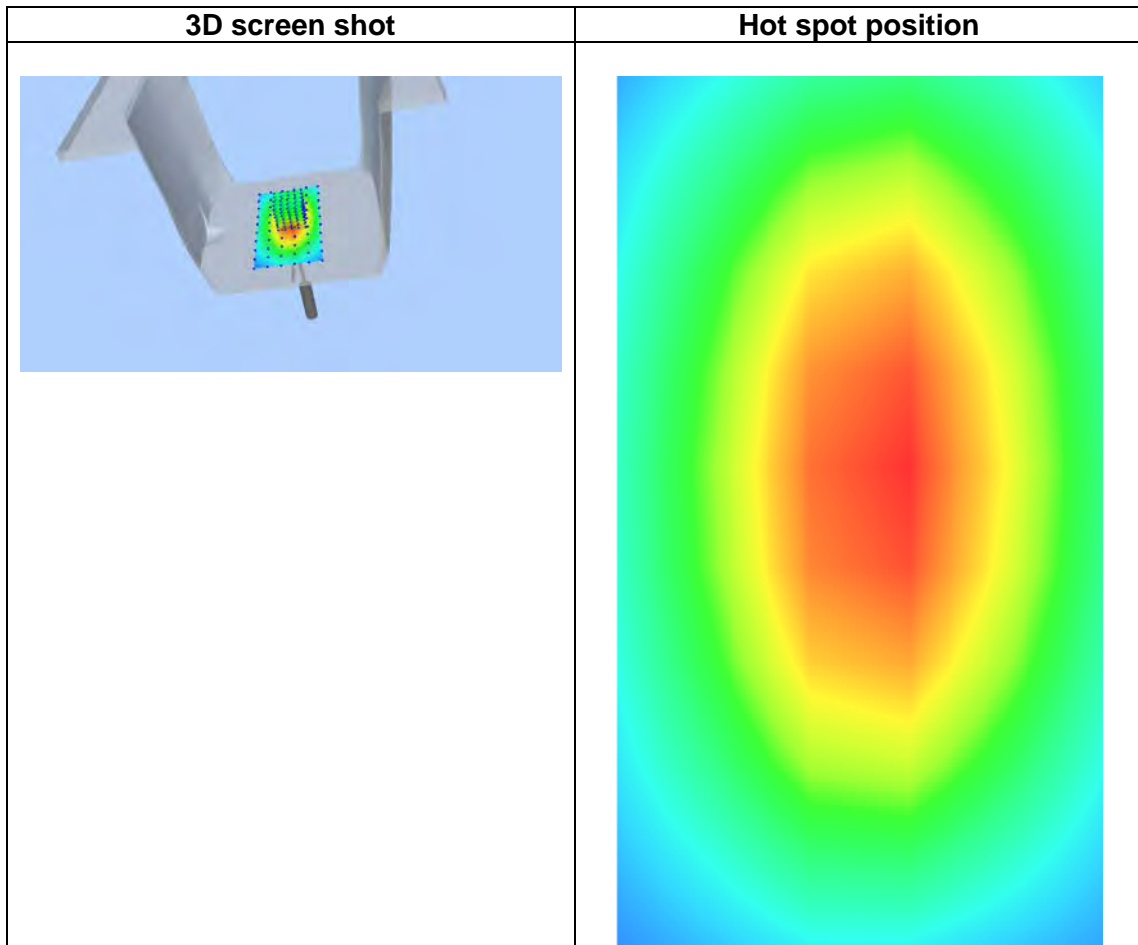
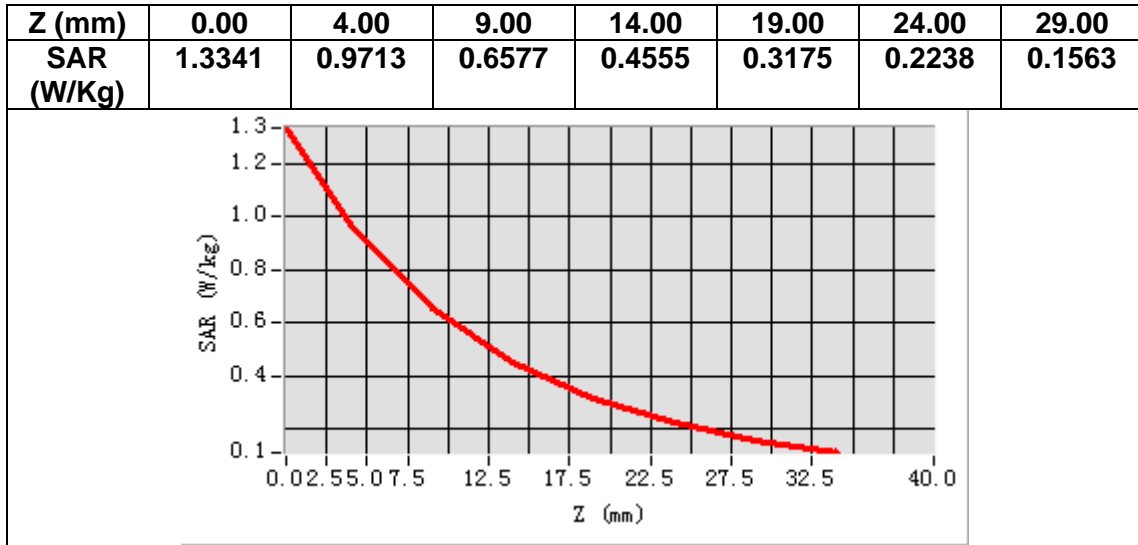

# MEASUREMENT 4

## A. Experimental conditions.

<b>Area Scan</b>	<u>dx=15mm dy=15mm, h= 5.00 mm</u>
<b>ZoomScan</b>	<u>5x5x7, dx=8mm dy=8mm dz=5mm</u>
<b>Phantom</b>	<u>Validation plane</u>
<b>Device Position</b>	<u>Dipole</u>
<b>Band</b>	<u>CW835</u>
<b>Channels</b>	<u>Middle</u>
<b>Signal</b>	<u>CW (Crest factor: 1.0)</u>

## B. SAR Measurement Results

<b>Frequency (MHz)</b>	835.000000
<b>Relative permittivity (real part)</b>	54.910700
<b>Relative permittivity (imaginary part)</b>	20.949100
<b>Conductivity (S/m)</b>	0.966554
<b>Variation (%)</b>	-0.180000

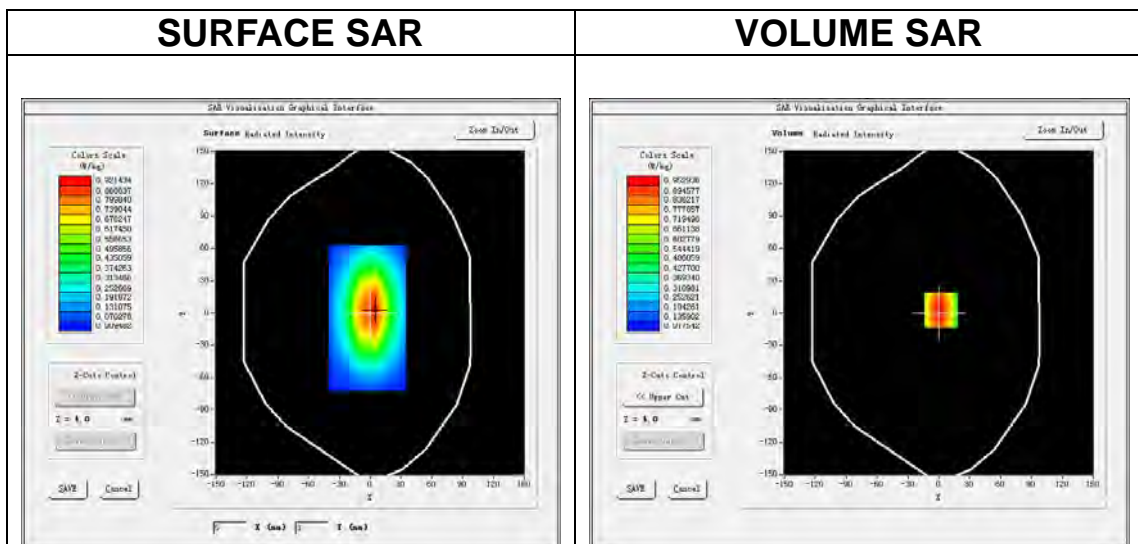

**Maximum location: X=2.00, Y=3.00**

**SAR Peak: 1.31 W/kg**

<b>SAR 10g (W/Kg)</b>	0.605724
<b>SAR 1g (W/Kg)</b>	0.935290

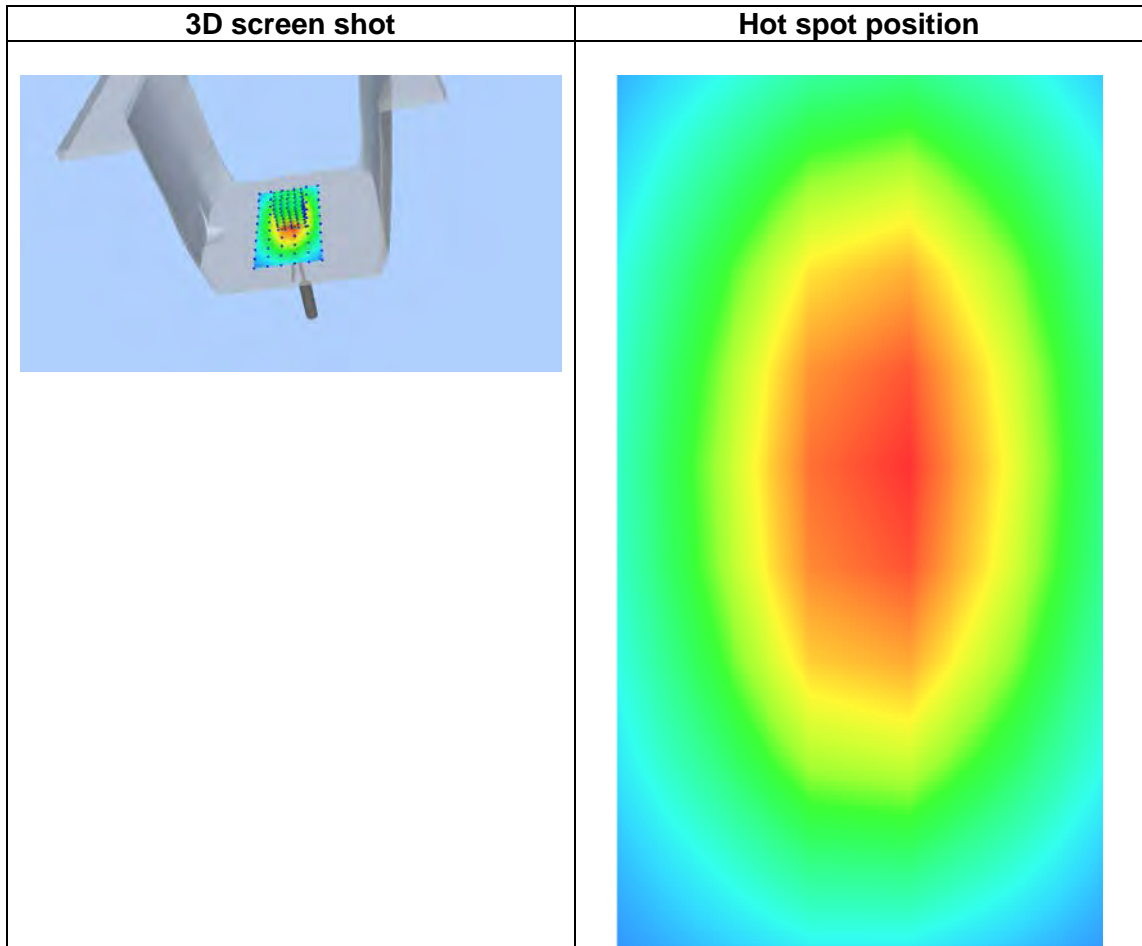
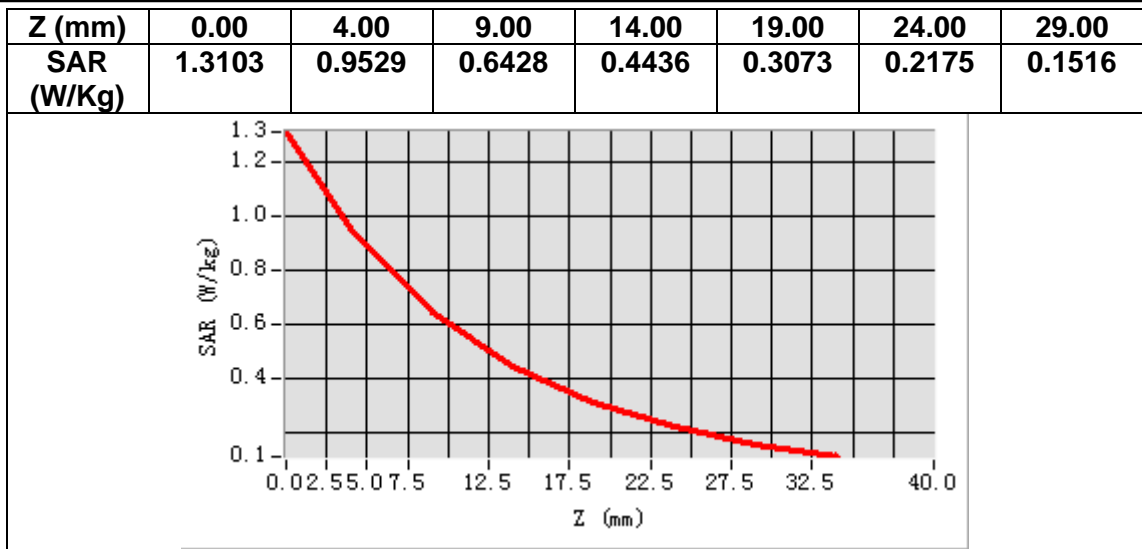



# MEASUREMENT 5

## A. Experimental conditions.

<b>Area Scan</b>	<u>dx=15mm dy=15mm, h= 5.00 mm</u>
<b>ZoomScan</b>	<u>5x5x7, dx=8mm dy=8mm dz=5mm</u>
<b>Phantom</b>	<u>Validation plane</u>
<b>Device Position</b>	<u>Dipole</u>
<b>Band</b>	<u>CW1800</u>
<b>Channels</b>	<u>Middle</u>
<b>Signal</b>	<u>CW (Crest factor: 1.0)</u>

## B. SAR Measurement Results

<b>Frequency (MHz)</b>	1800.000000
<b>Relative permittivity (real part)</b>	39.970254
<b>Relative permittivity (imaginary part)</b>	14.243042
<b>Conductivity (S/m)</b>	1.420573
<b>Variation (%)</b>	-0.410000

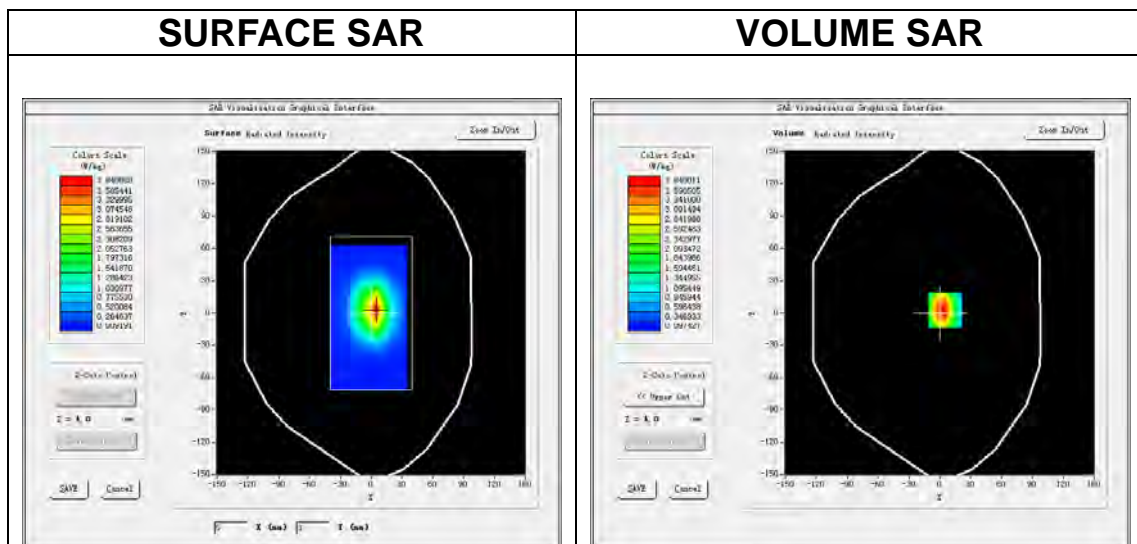

**Maximum location: X=5.00, Y=3.00**

**SAR Peak: 6.00 W/kg**

<b>SAR 10g (W/Kg)</b>	1.994030
<b>SAR 1g (W/Kg)</b>	3.720422

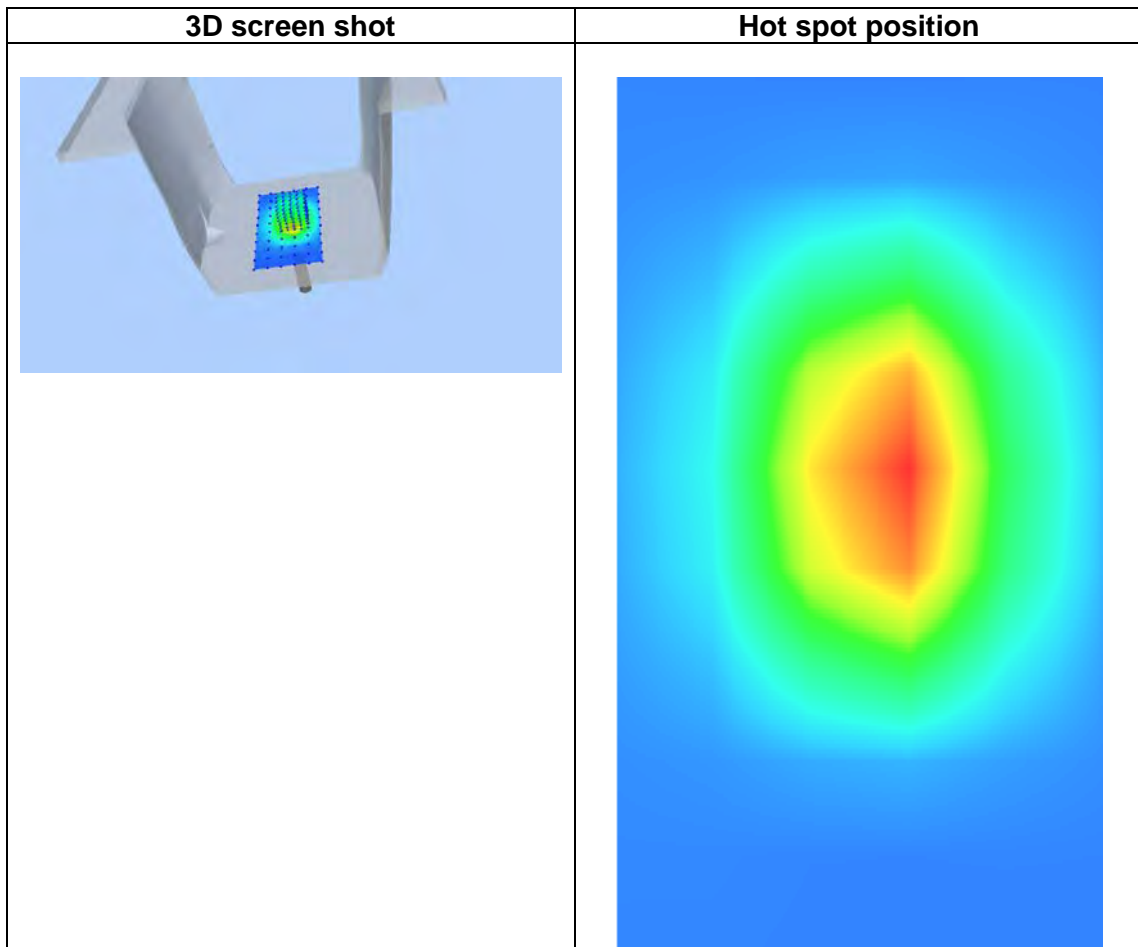
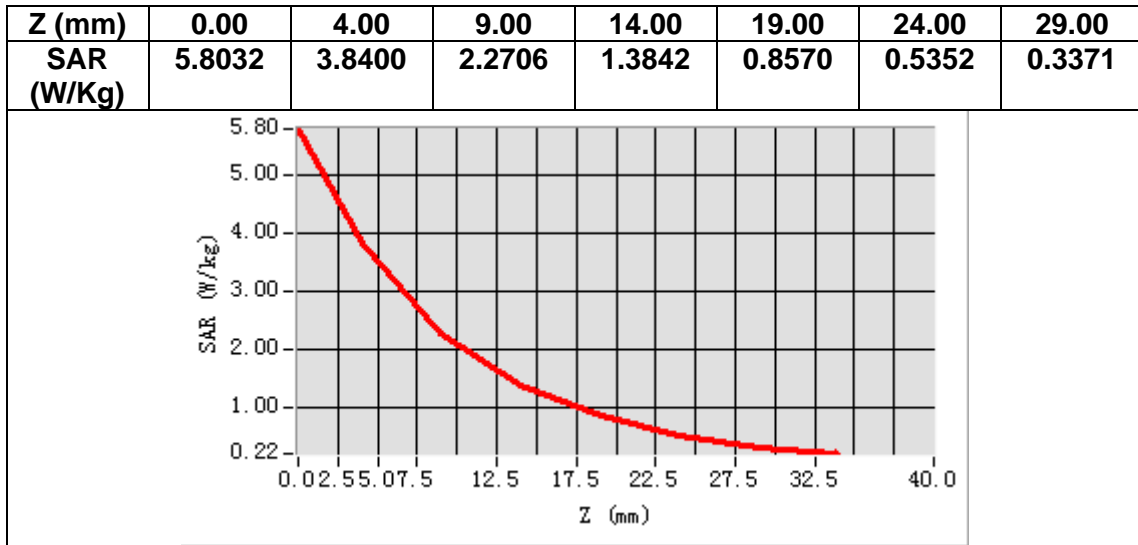

# MEASUREMENT 6

## A. Experimental conditions.

<b>Area Scan</b>	<u>dx=15mm dy=15mm, h= 5.00 mm</u>
<b>ZoomScan</b>	<u>5x5x7,dx=8mm dy=8mm dz=5mm</u>
<b>Phantom</b>	<u>Validation plane</u>
<b>Device Position</b>	<u>Dipole</u>
<b>Band</b>	<u>CW1800</u>
<b>Channels</b>	<u>Middle</u>
<b>Signal</b>	<u>CW (Crest factor: 1.0)</u>

## B. SAR Measurement Results

<b>Frequency (MHz)</b>	1800.000000
<b>Relative permittivity (real part)</b>	54.021342
<b>Relative permittivity (imaginary part)</b>	15.151470
<b>Conductivity (S/m)</b>	1.520674
<b>Variation (%)</b>	-0.240000

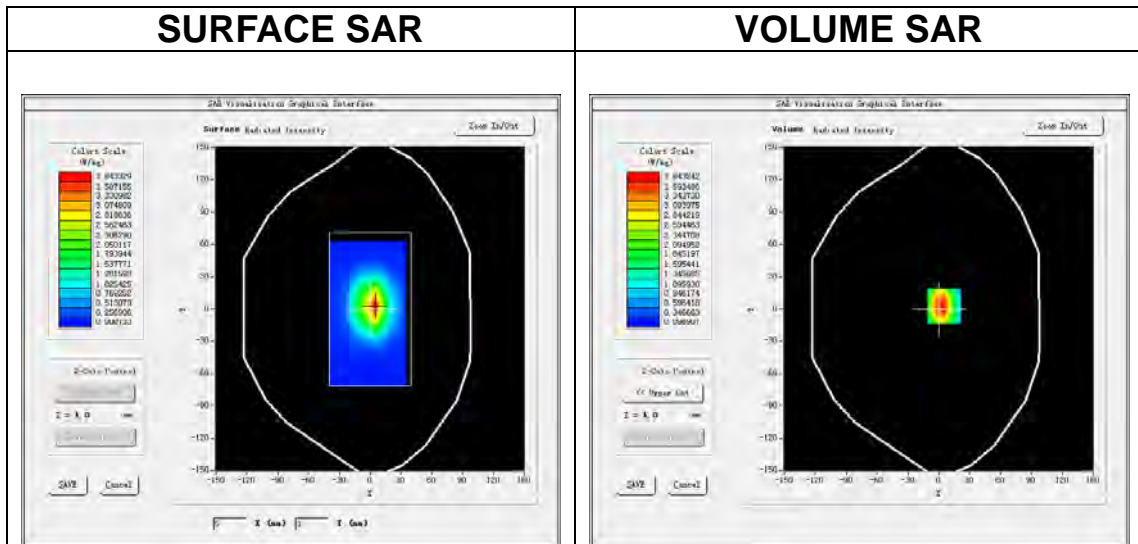

**Maximum location: X=5.00, Y=3.00**

**SAR Peak: 5.99 W/kg**

<b>SAR 10g (W/Kg)</b>	1.997197
<b>SAR 1g (W/Kg)</b>	3.724353

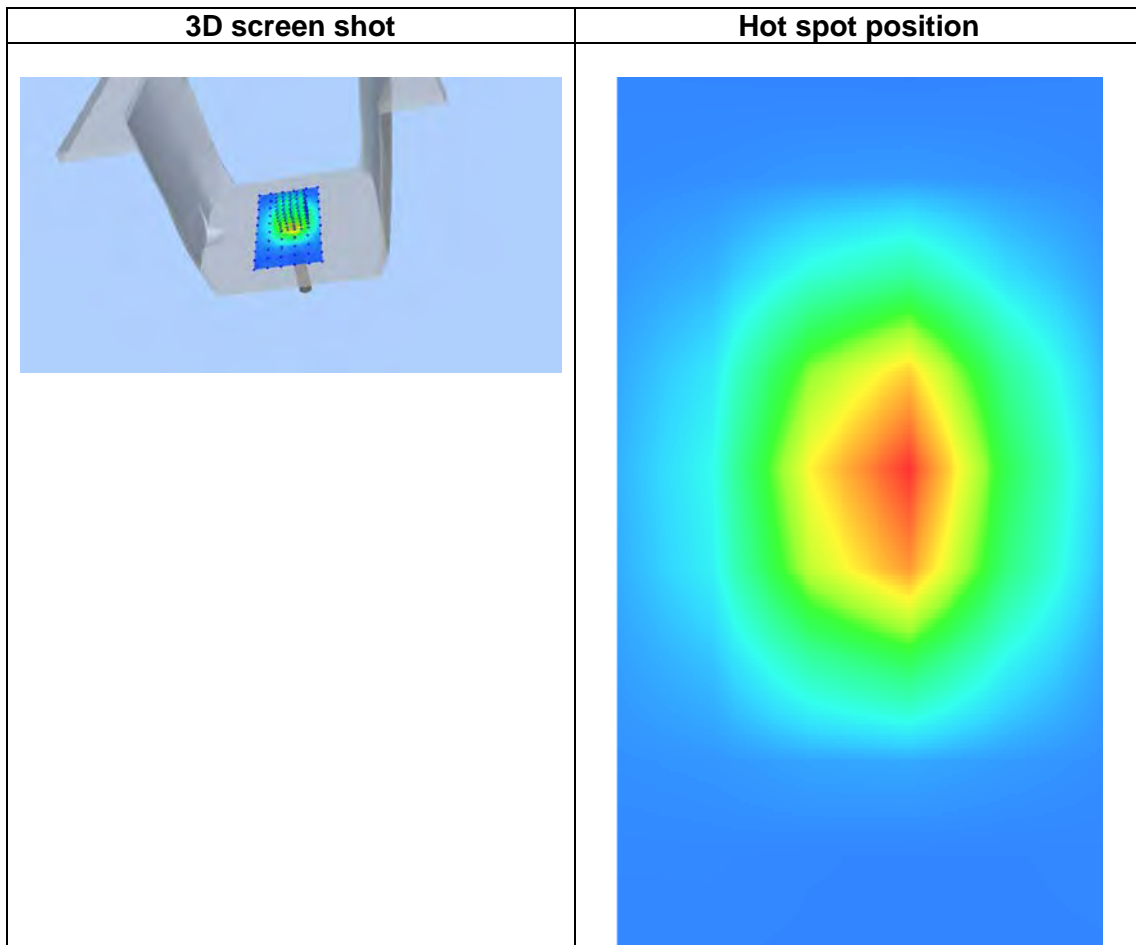
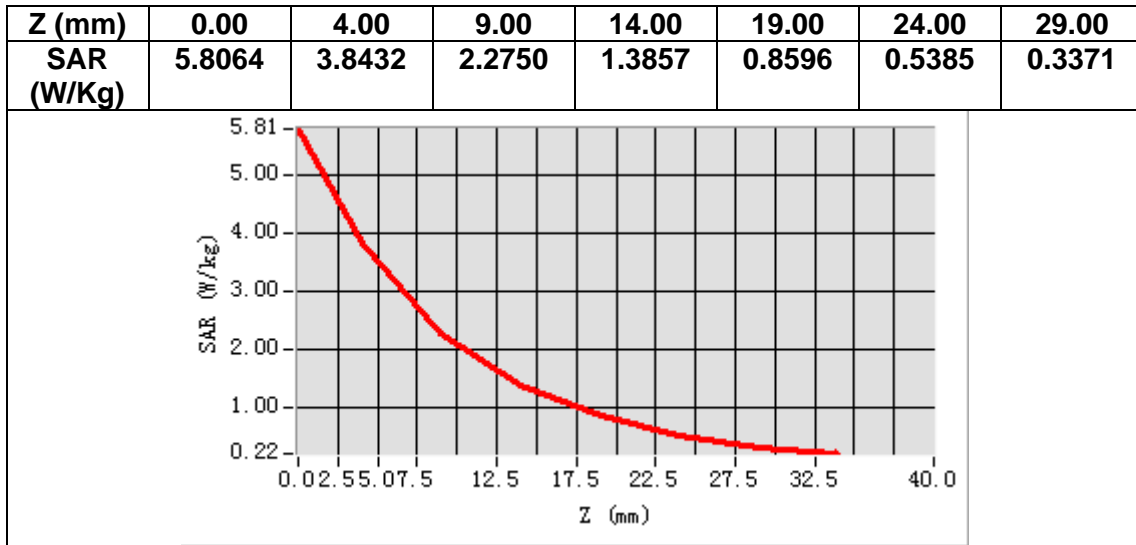

# MEASUREMENT 7

## A. Experimental conditions.

<b>Area Scan</b>	<u>dx=15mm dy=15mm, h= 5.00 mm</u>
<b>ZoomScan</b>	<u>5x5x7, dx=8mm dy=8mm dz=5mm</u>
<b>Phantom</b>	<u>Validation plane</u>
<b>Device Position</b>	<u>Dipole</u>
<b>Band</b>	<u>CW1900</u>
<b>Channels</b>	<u>Middle</u>
<b>Signal</b>	<u>CW (Crest factor: 1.0)</u>

## B. SAR Measurement Results

<b>Frequency (MHz)</b>	1900.000000
<b>Relative permittivity (real part)</b>	38.564700
<b>Relative permittivity (imaginary part)</b>	13.652600
<b>Conductivity (S/m)</b>	1.435587
<b>Variation (%)</b>	-0.330000

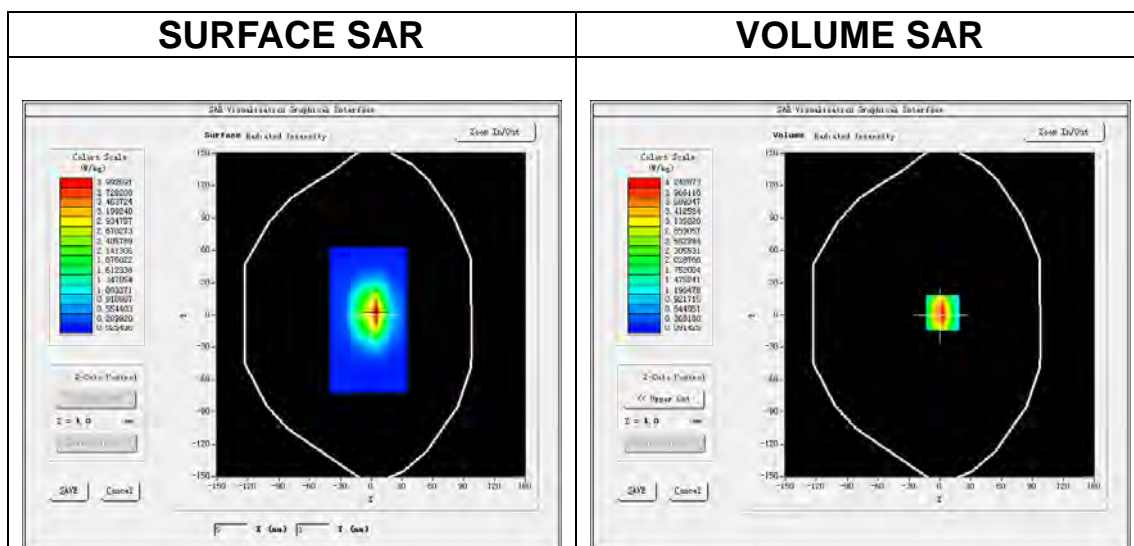

**Maximum location: X=3.00, Y=2.00**

**SAR Peak: 6.74 W/kg**

<b>SAR 10g (W/Kg)</b>	2.083406
<b>SAR 1g (W/Kg)</b>	4.093585

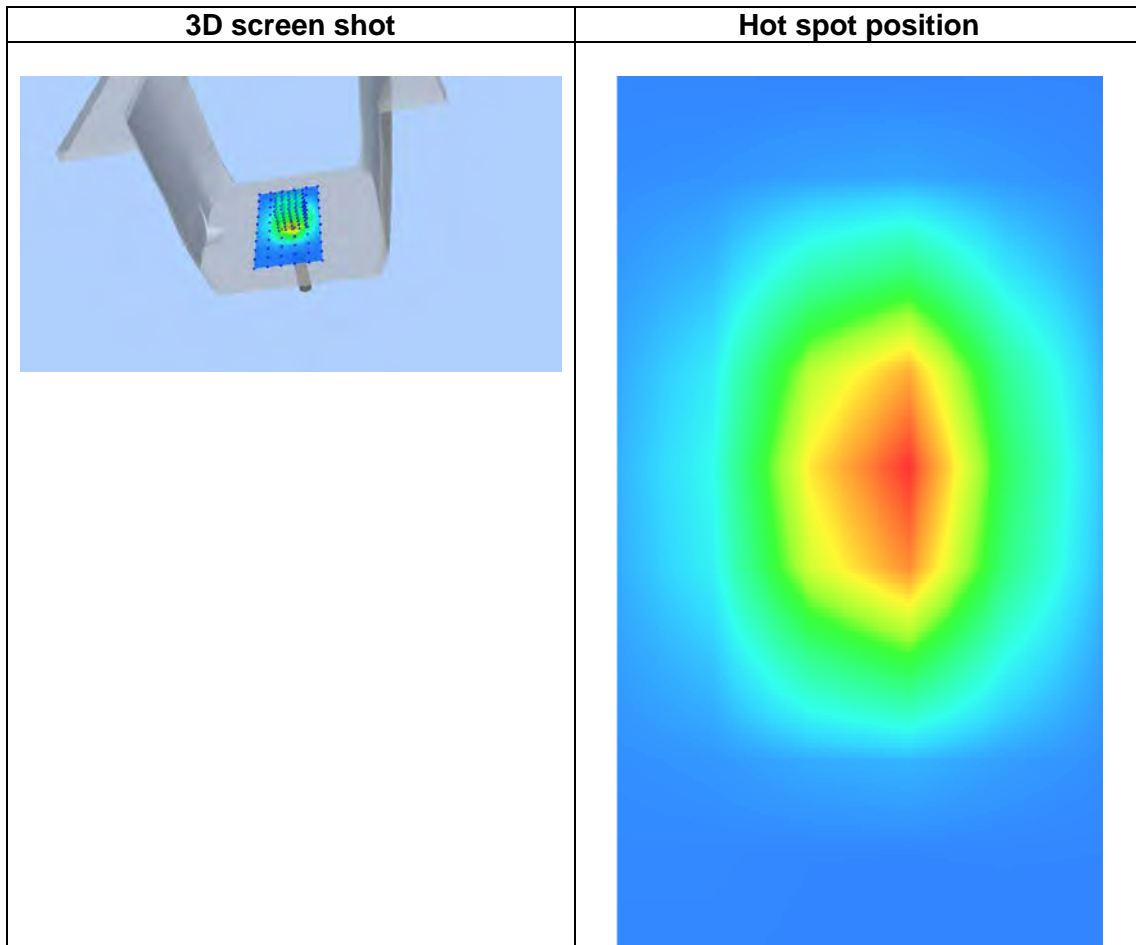
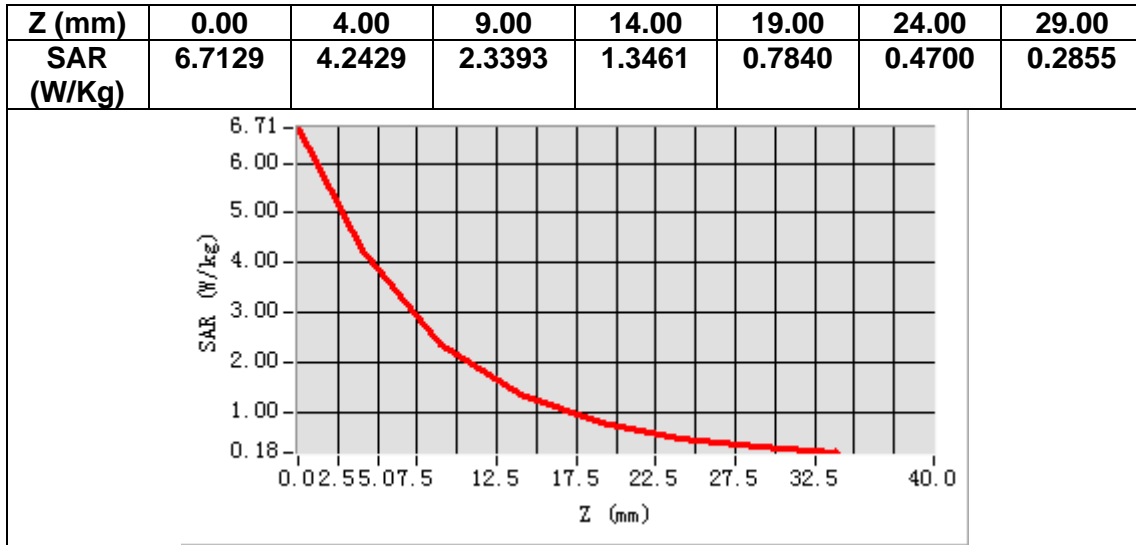

# MEASUREMENT 8

## A. Experimental conditions.

<b>Area Scan</b>	<u>dx=15mm dy=15mm, h= 5.00 mm</u>
<b>ZoomScan</b>	<u>5x5x7, dx=8mm dy=8mm dz=5mm</u>
<b>Phantom</b>	<u>Validation plane</u>
<b>Device Position</b>	<u>Dipole</u>
<b>Band</b>	<u>CW1900</u>
<b>Channels</b>	<u>Middle</u>
<b>Signal</b>	<u>CW (Crest factor: 1.0)</u>

## B. SAR Measurement Results

<b>Frequency (MHz)</b>	1900.000000
<b>Relative permittivity (real part)</b>	53.305800
<b>Relative permittivity (imaginary part)</b>	14.565500
<b>Conductivity (S/m)</b>	1.535587
<b>Variation (%)</b>	-0.110000

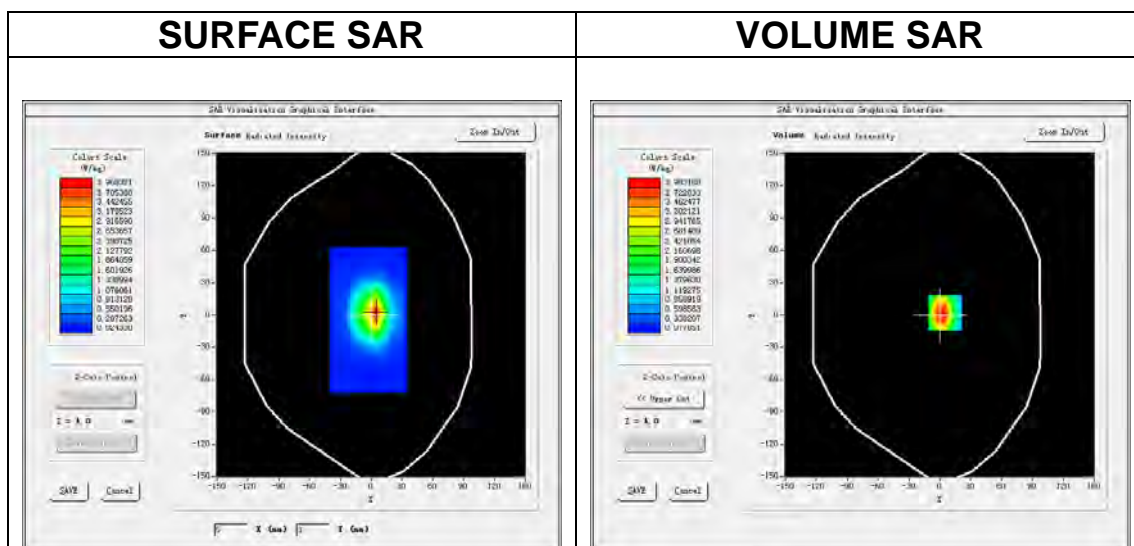

**Maximum location: X=5.00, Y=2.00**

**SAR Peak: 6.61 W/kg**

<b>SAR 10g (W/Kg)</b>	2.015601
<b>SAR 1g (W/Kg)</b>	4.002032



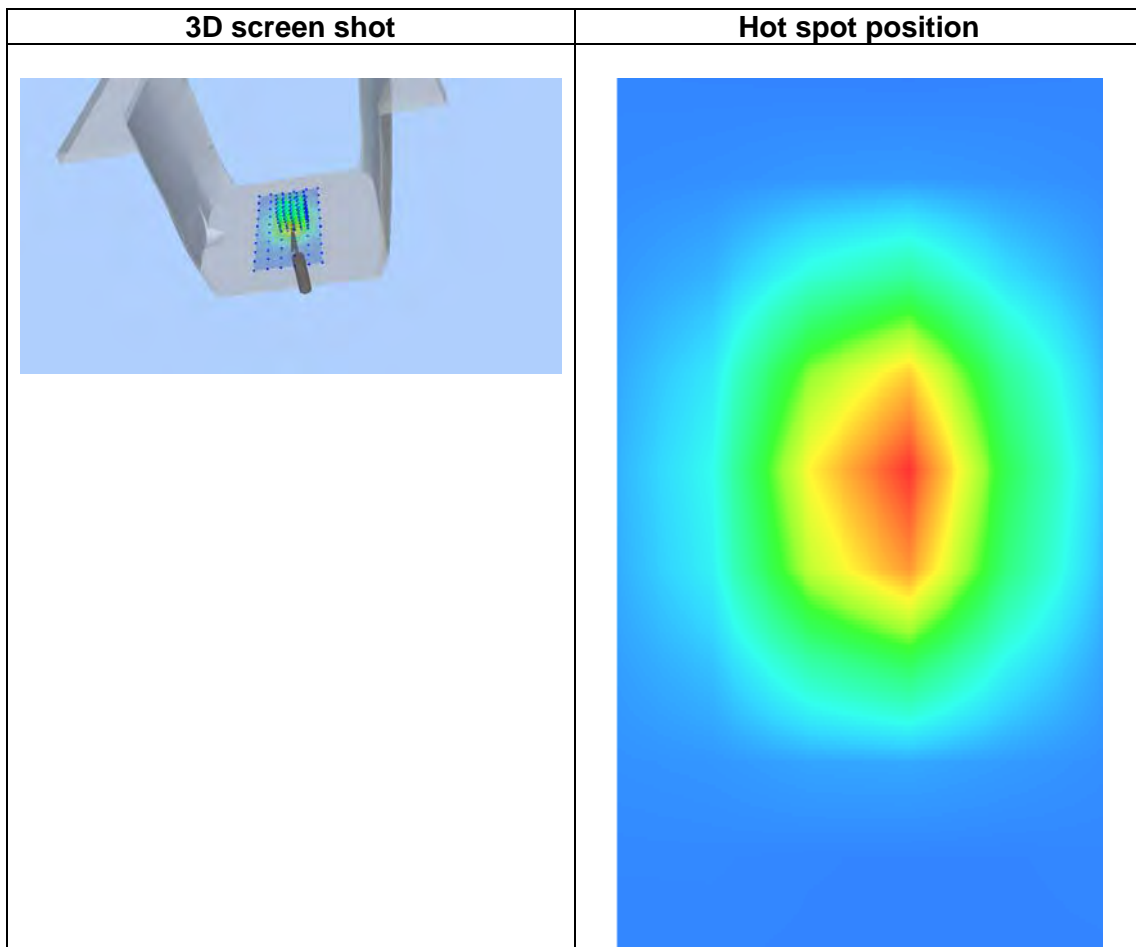
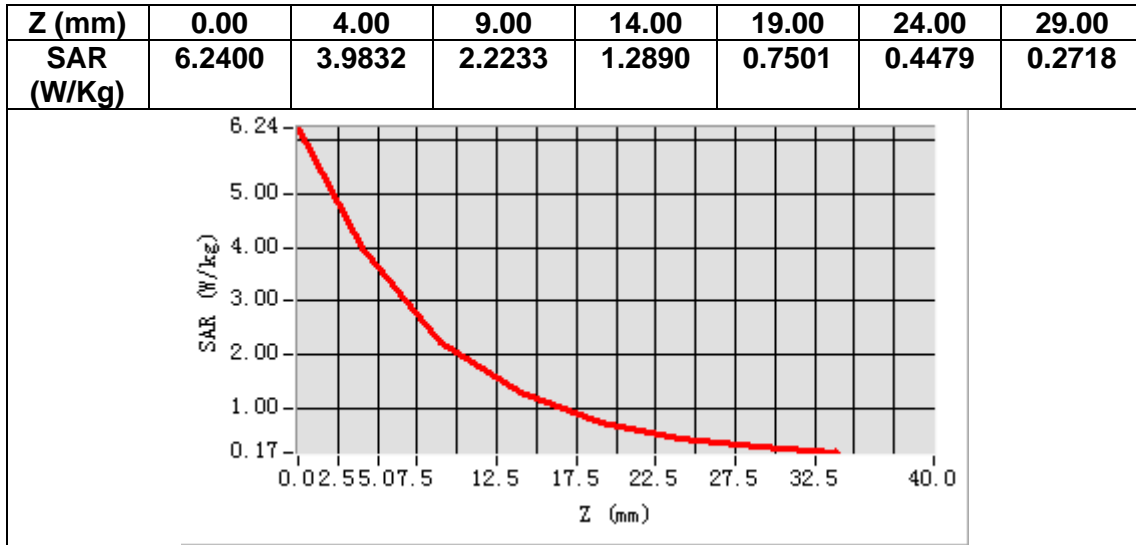

# MEASUREMENT 9

## A. Experimental conditions.

<b>Area Scan</b>	<u>dx=12mm dy=12mm, h= 5.00 mm</u>
<b>ZoomScan</b>	<u>7x7x7, dx=5mm dy=5mm dz=5mm</u>
<b>Phantom</b>	<u>Validation plane</u>
<b>Device Position</b>	<u>Dipole</u>
<b>Band</b>	<u>CW2450</u>
<b>Channels</b>	<u>Middle</u>
<b>Signal</b>	<u>CW (Crest factor: 1.0)</u>

## B. SAR Measurement Results

<b>Frequency (MHz)</b>	2450.000000
<b>Relative permittivity (real part)</b>	39.674097
<b>Relative permittivity (imaginary part)</b>	13.461200
<b>Conductivity (S/m)</b>	1.826738
<b>Variation (%)</b>	0.080000

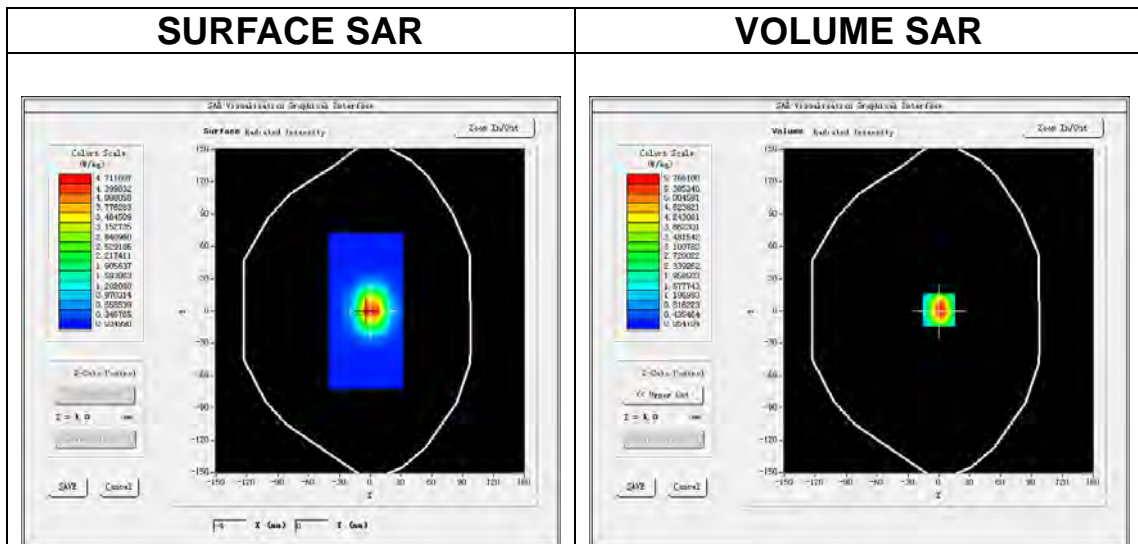

**Maximum location: X=0.00, Y=1.00**

**SAR Peak: 10.26 W/kg**

<b>SAR 10g (W/Kg)</b>	2.383467
<b>SAR 1g (W/Kg)</b>	5.430825

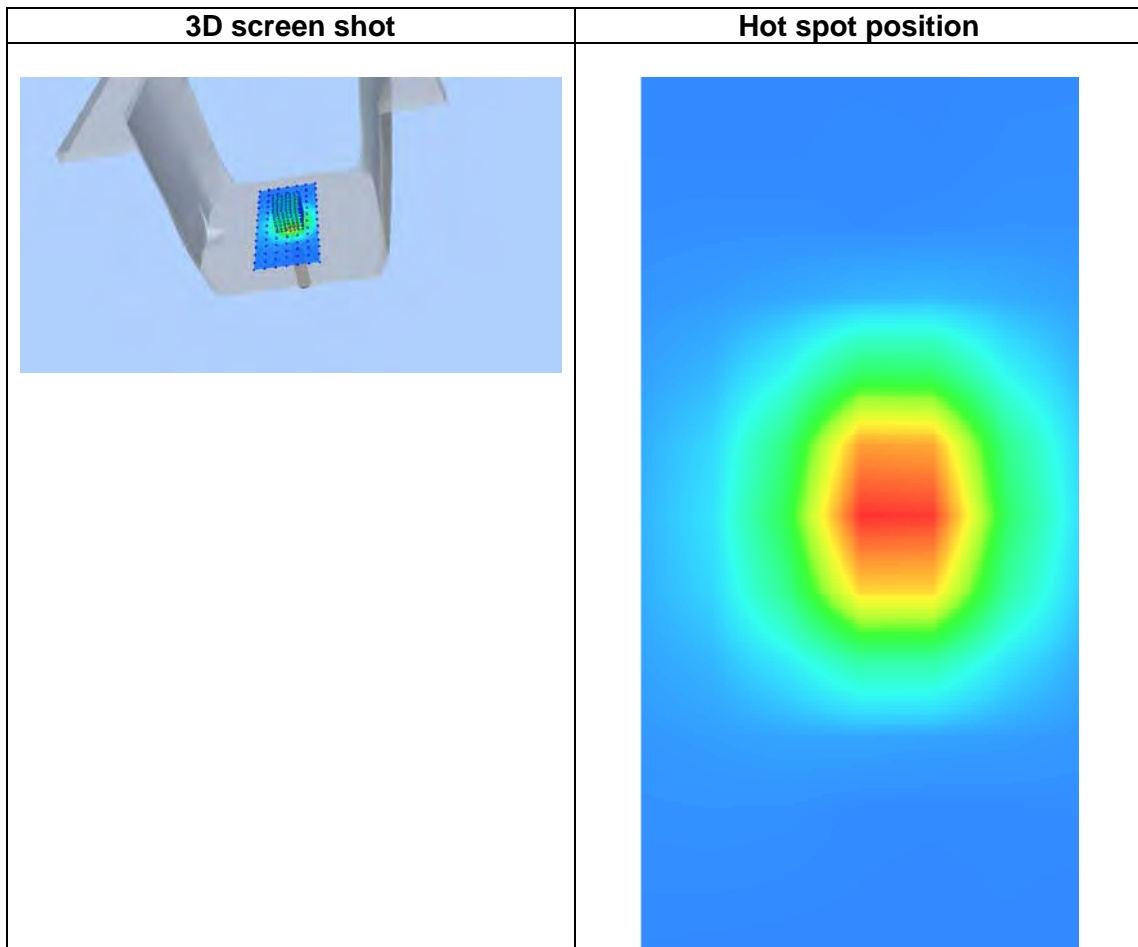
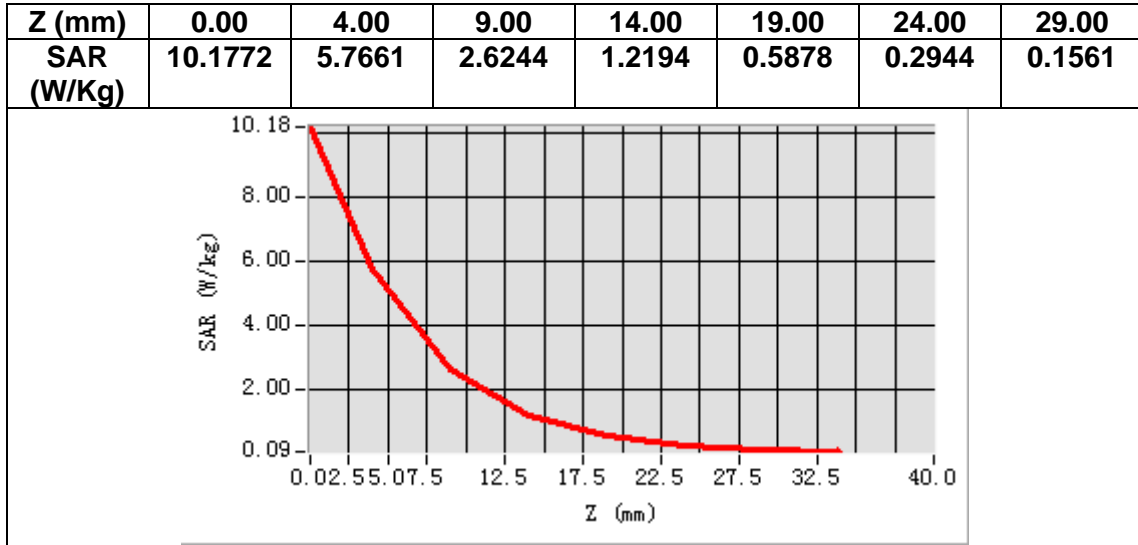

# MEASUREMENT 10

## A. Experimental conditions.

<b>Area Scan</b>	<u>dx=12mm dy=12mm, h= 5.00 mm</u>
<b>ZoomScan</b>	<u>7x7x7, dx=5mm dy=5mm dz=5mm</u>
<b>Phantom</b>	<u>Validation plane</u>
<b>Device Position</b>	<u>Dipole</u>
<b>Band</b>	<u>CW2450</u>
<b>Channels</b>	<u>Middle</u>
<b>Signal</b>	<u>CW (Crest factor: 1.0)</u>

## B. SAR Measurement Results

<b>Frequency (MHz)</b>	2450.000000
<b>Relative permittivity (real part)</b>	52.104097
<b>Relative permittivity (imaginary part)</b>	14.41352
<b>Conductivity (S/m)</b>	1.956738
<b>Variation (%)</b>	-0.300000

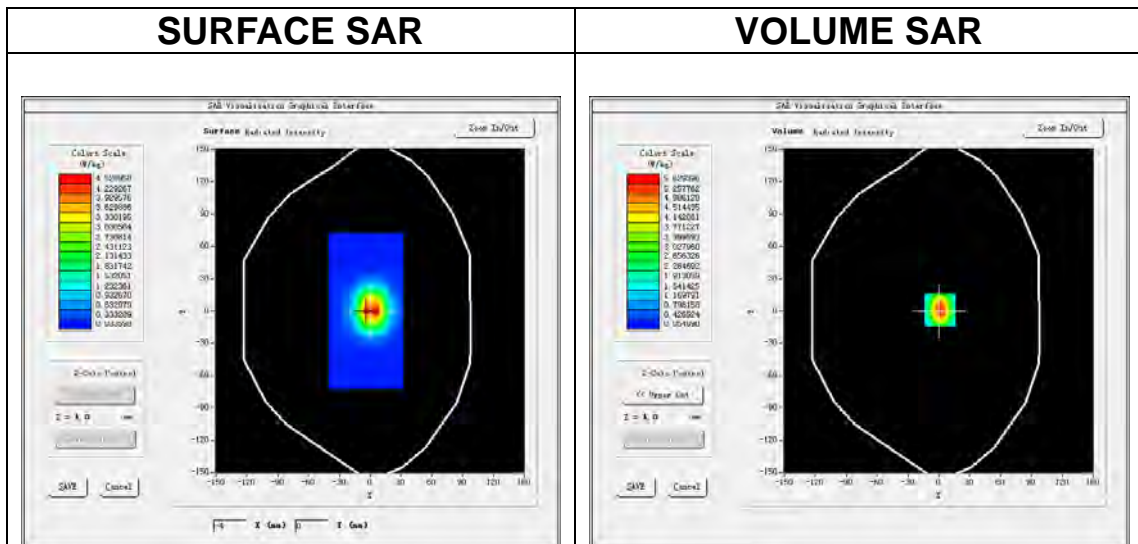

**Maximum location: X=1.00, Y=1.00**

**SAR Peak: 9.81 W/kg**

<b>SAR 10g (W/Kg)</b>	2.300919
<b>SAR 1g (W/Kg)</b>	5.198616

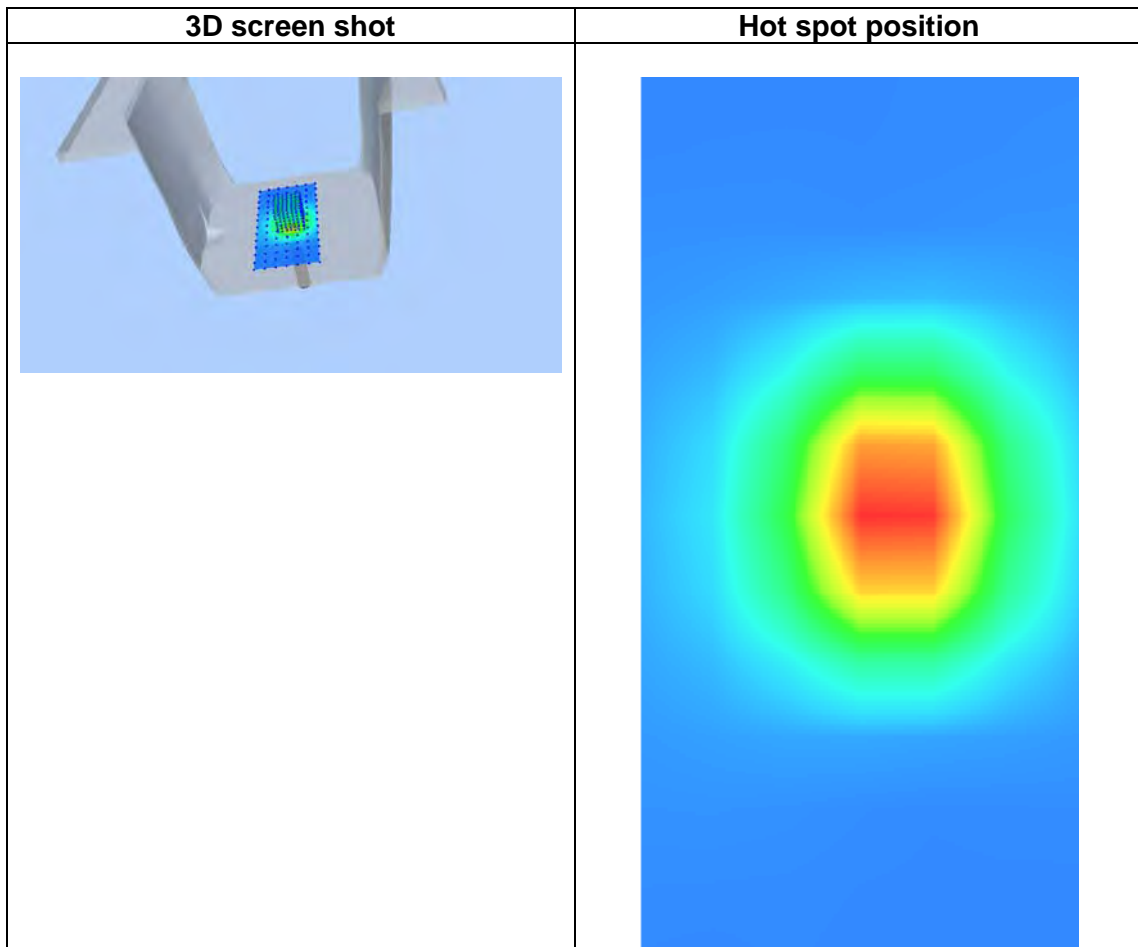
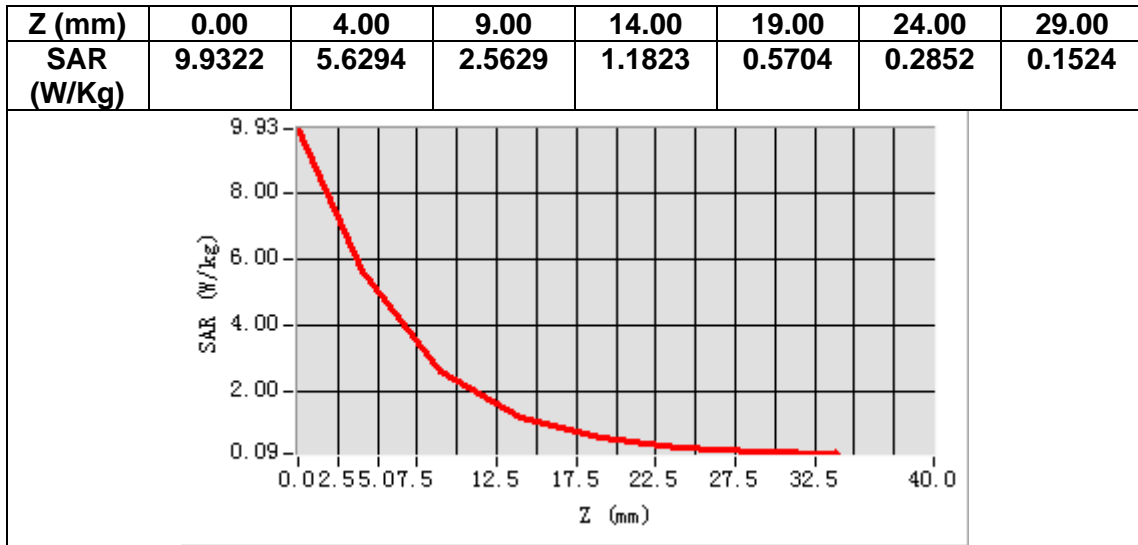

# MEASUREMENT 11

## A. Experimental conditions.

<b>Area Scan</b>	<u>dx=12mm dy=12mm, h= 5.00 mm</u>
<b>ZoomScan</b>	<u>7x7x7, dx=5mm dy=5mm dz=5mm</u>
<b>Phantom</b>	<u>Validation plane</u>
<b>Device Position</b>	<u>Dipole</u>
<b>Band</b>	<u>CW2600</u>
<b>Channels</b>	<u>Middle</u>
<b>Signal</b>	<u>CW (Crest factor: 1.0)</u>

## B. SAR Measurement Results

<b>Frequency (MHz)</b>	2600.000000
<b>Relative permittivity (real part)</b>	38.862343
<b>Relative permittivity (imaginary part)</b>	13.739260
<b>Conductivity (S/m)</b>	1.980111
<b>Variation (%)</b>	-0.200000

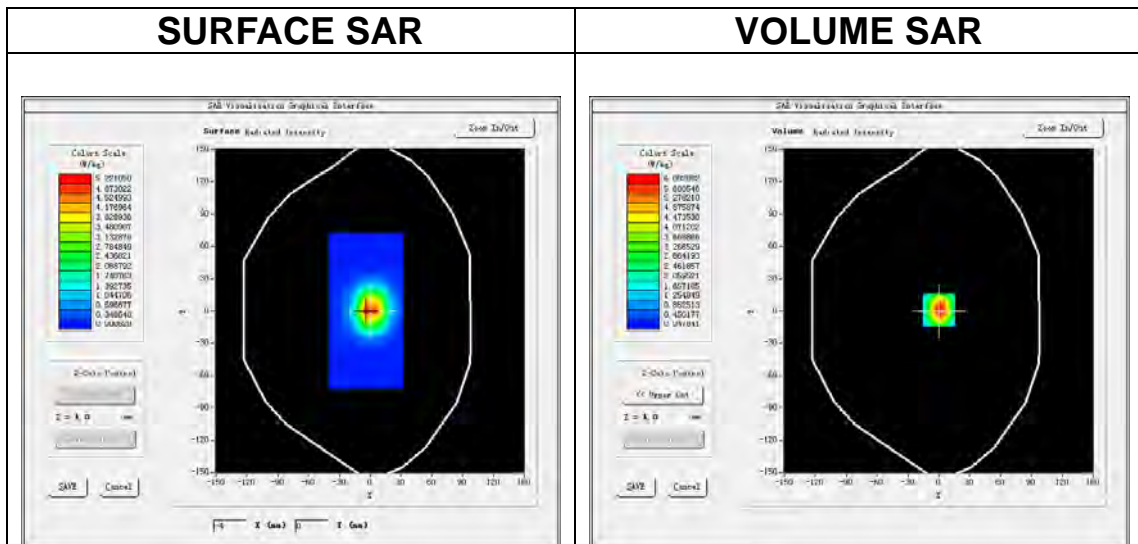

**Maximum location: X=0.00, Y=1.00**

**SAR Peak: 9.96 W/kg**

<b>SAR 10g (W/Kg)</b>	2.688761
<b>SAR 1g (W/Kg)</b>	5.617330

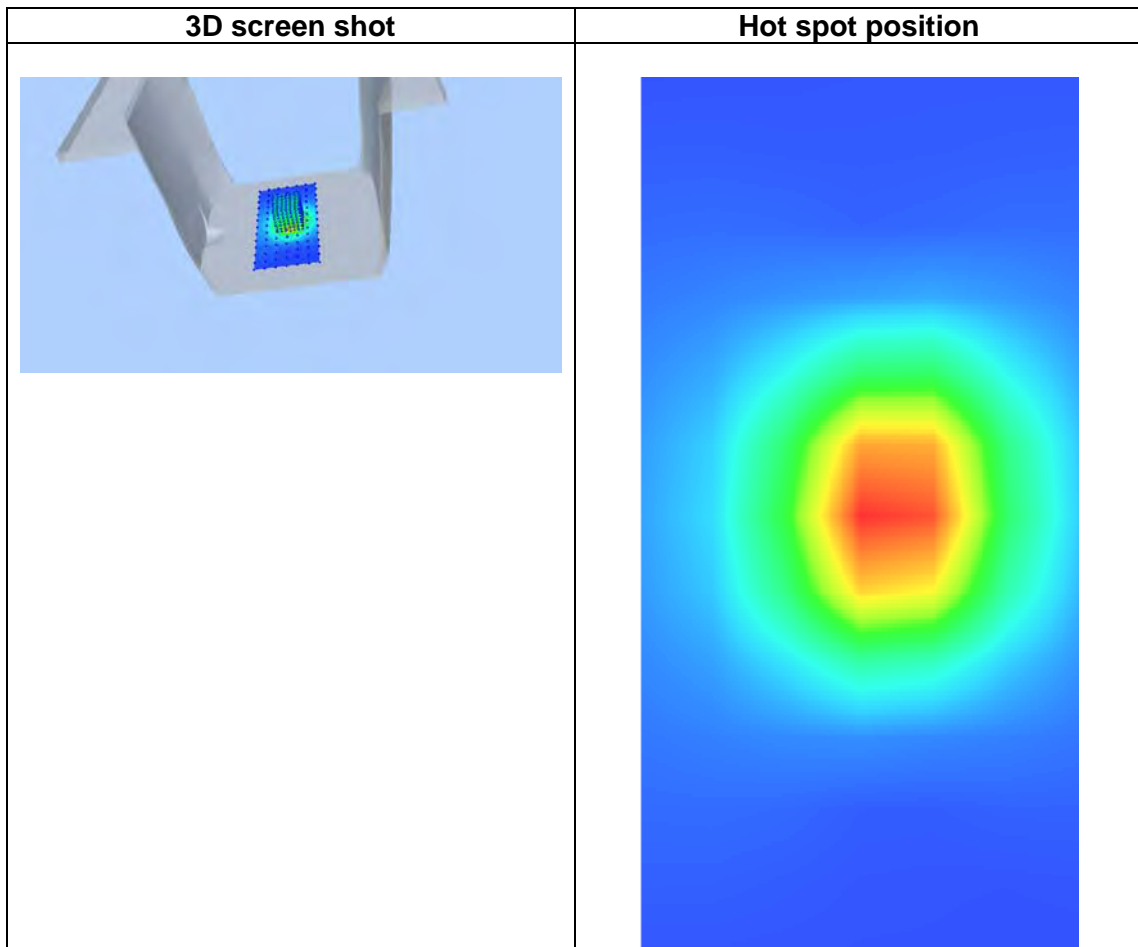
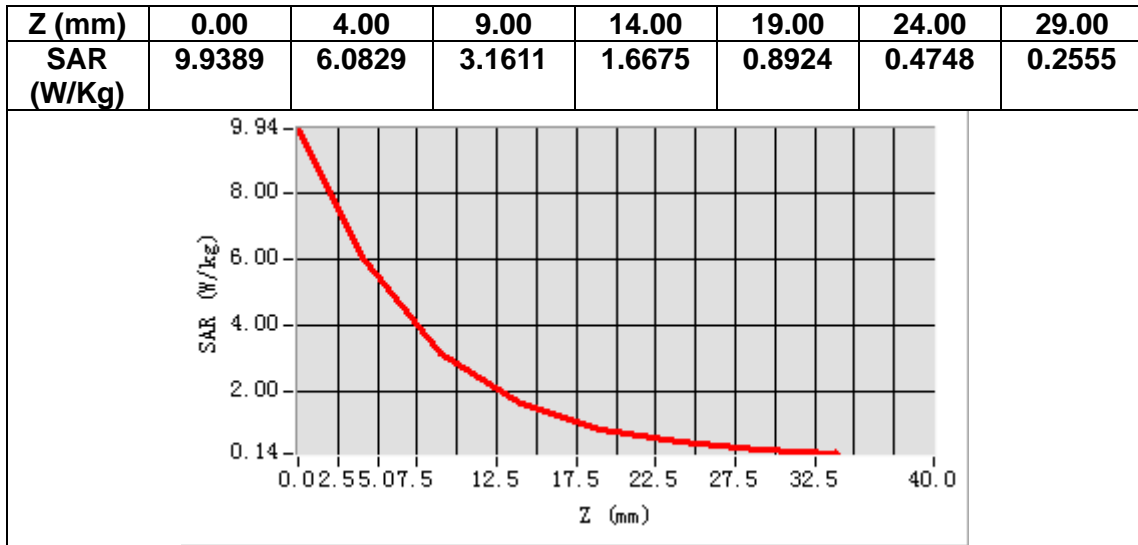



# MEASUREMENT 12

## A. Experimental conditions.

<u>Area Scan</u>	<u>dx=12mm dy=12mm, h= 5.00 mm</u>
<u>ZoomScan</u>	<u>7x7x7,dx=5mm dy=5mm dz=5mm</u>
<u>Phantom</u>	<u>Validation plane</u>
<u>Device Position</u>	<u>Dipole</u>
<u>Band</u>	<u>CW2600</u>
<u>Channels</u>	<u>Middle</u>
<u>Signal</u>	<u>CW (Crest factor: 1.0)</u>

## B. SAR Measurement Results

<b>Frequency (MHz)</b>	2600.000000
<b>Relative permittivity (real part)</b>	53.490143
<b>Relative permittivity (imaginary part)</b>	13.054940
<b>Conductivity (S/m)</b>	2.170111
<b>Variation (%)</b>	-0.100000

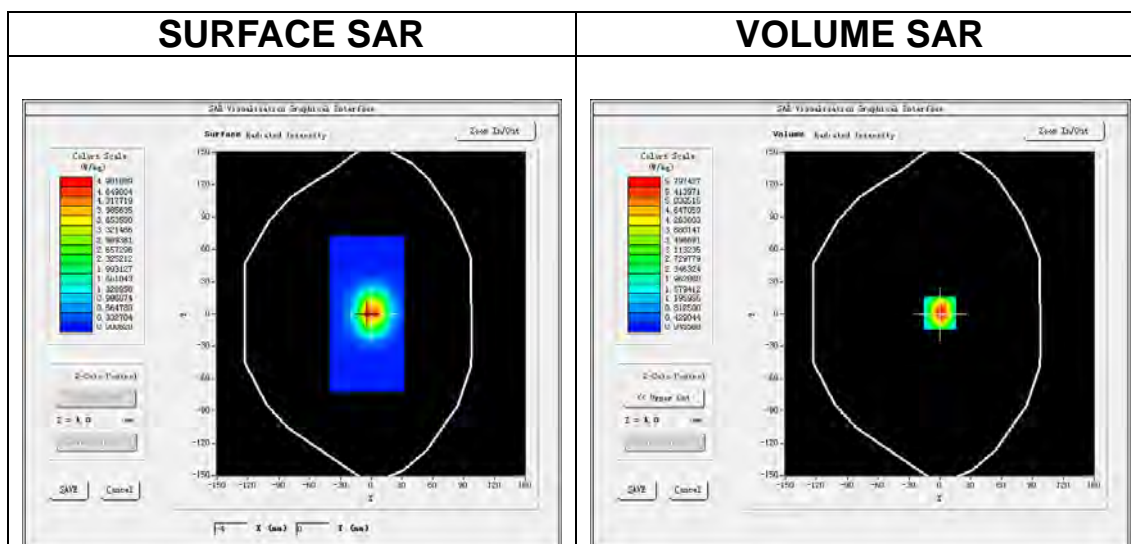

**Maximum location: X=0.00, Y=1.00**

**SAR Peak: 9.48 W/kg**

<b>SAR 10g (W/Kg)</b>	2.360897
<b>SAR 1g (W/Kg)</b>	5.350207

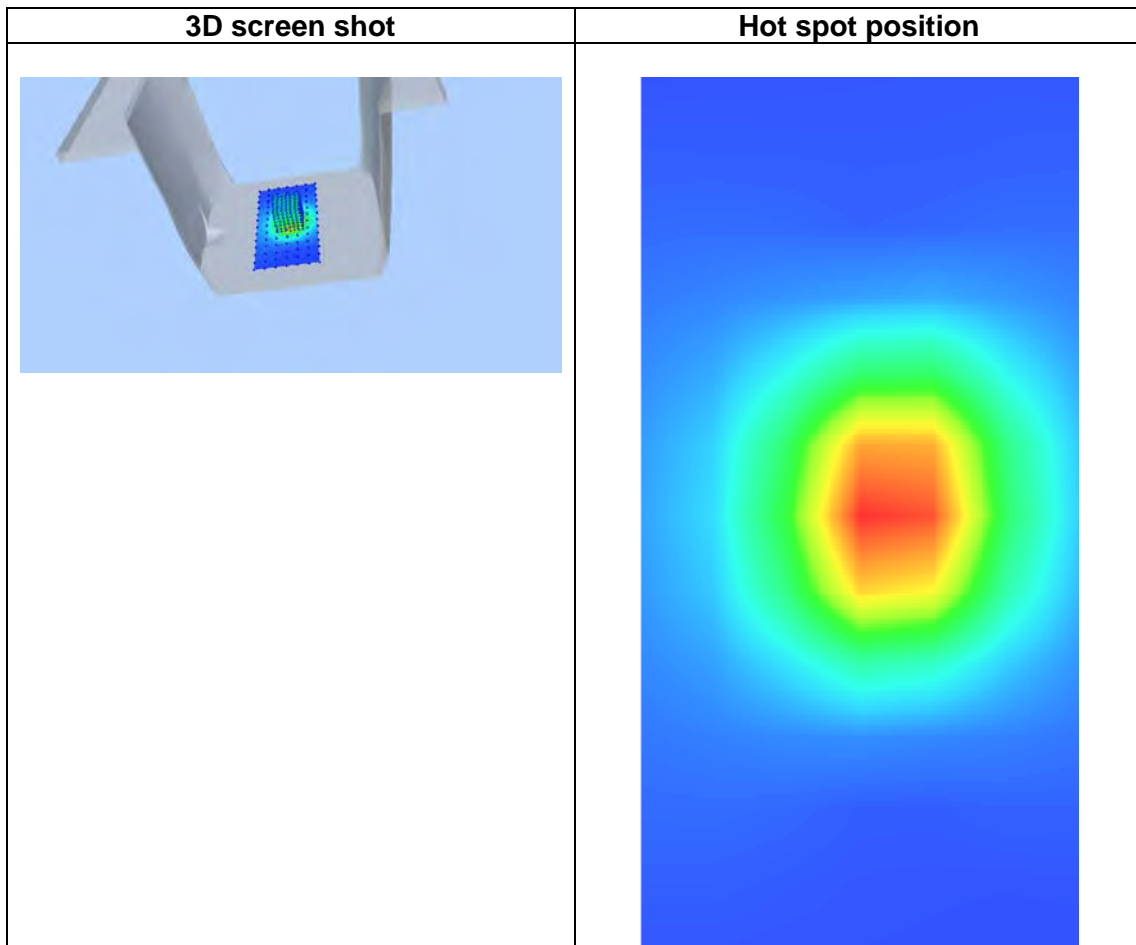
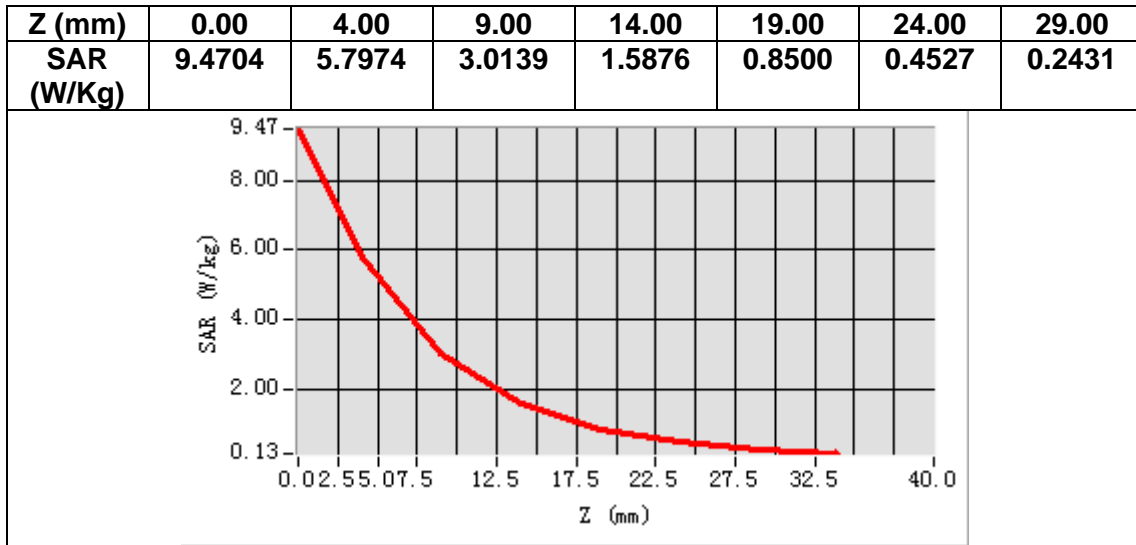

### 13. Appendix C. Plots of High SAR Measurement

<b>Table of contents</b>
<b>MEASUREMENT 1 GSM 850 Head</b>
<b>MEASUREMENT 2 GSM 850 Body</b>
<b>MEASUREMENT 3 GSM 1900 Head</b>
<b>MEASUREMENT 4 GSM 1900 Body</b>
<b>MEASUREMENT 5 WCDMA Band II Head</b>
<b>MEASUREMENT 6 WCDMA Band II Body</b>
<b>MEASUREMENT 7 WCDMA Band IV Head</b>
<b>MEASUREMENT 8 WCDMA Band IV Body</b>
<b>MEASUREMENT 9 WCDMA Band V Head</b>
<b>MEASUREMENT 10 WCDMA Band V Body</b>
<b>MEASUREMENT 11 WLAN 2.4G Head</b>
<b>MEASUREMENT 12 WLAN 2.4G Body</b>
<b>MEASUREMENT 13 LTE Band II Head</b>
<b>MEASUREMENT 14 LTE Band II Body</b>
<b>MEASUREMENT 15 LTE Band IV Head</b>
<b>MEASUREMENT 16 LTE Band IV Body</b>
<b>MEASUREMENT 17 LTE Band V Head</b>
<b>MEASUREMENT 18 LTE Band V Body</b>
<b>MEASUREMENT 19 LTE Band VII Head</b>
<b>MEASUREMENT 20 LTE Band VII Body</b>
<b>MEASUREMENT 21 LTE Band XII Head</b>
<b>MEASUREMENT 22 LTE Band XII Body</b>
<b>MEASUREMENT 23 LTE Band XVII Head</b>
<b>MEASUREMENT 24 LTE Band XVII Body</b>

# MEASUREMENT 1

## A. Experimental conditions.

<b>Area Scan</b>	<u>dx=15mm dy=15mm, h= 5.00 mm</u>
<b>ZoomScan</b>	<u>5x5x7,dx=8mm dy=8mm dz=5mm</u>
<b>Phantom</b>	<u>Right head</u>
<b>Device Position</b>	<u>Cheek</u>
<b>Band</b>	<u>GSM850</u>
<b>Channels</b>	<u>Middle</u>
<b>Signal</b>	<u>TDMA (Crest factor: 2.0)</u>

## B. SAR Measurement Results

<b>Frequency (MHz)</b>	836.400024
<b>Relative permittivity (real part)</b>	55.117443
<b>Relative permittivity (imaginary part)</b>	21.228060
<b>Conductivity (S/m)</b>	0.986397
<b>Variation (%)</b>	0.510000

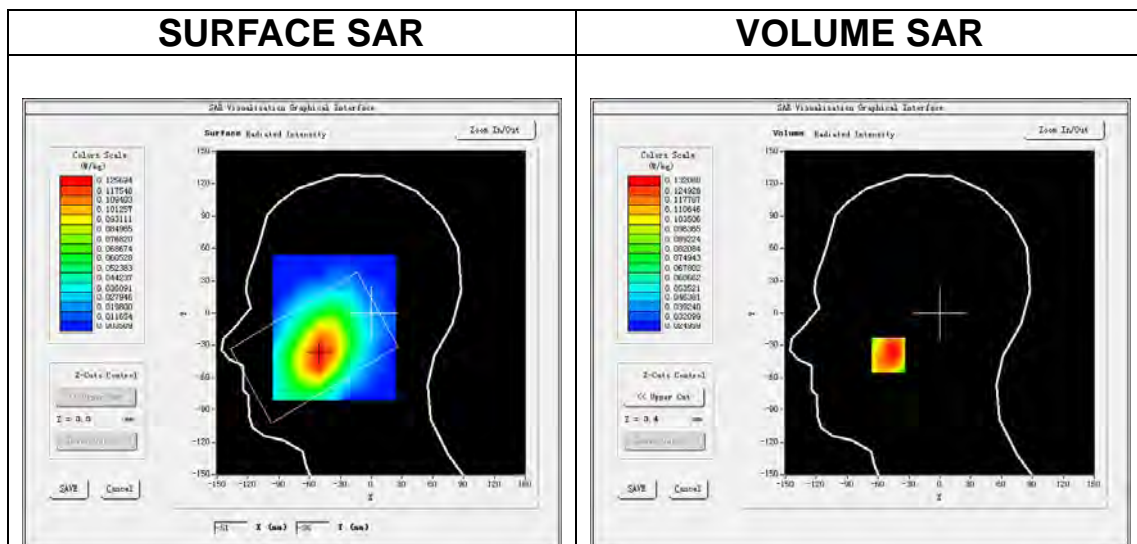

**Maximum location: X=-50.00, Y=-39.00**

**SAR Peak: 0.17 W/kg**

<b>SAR 10g (W/Kg)</b>	0.099536
<b>SAR 1g (W/Kg)</b>	0.129268

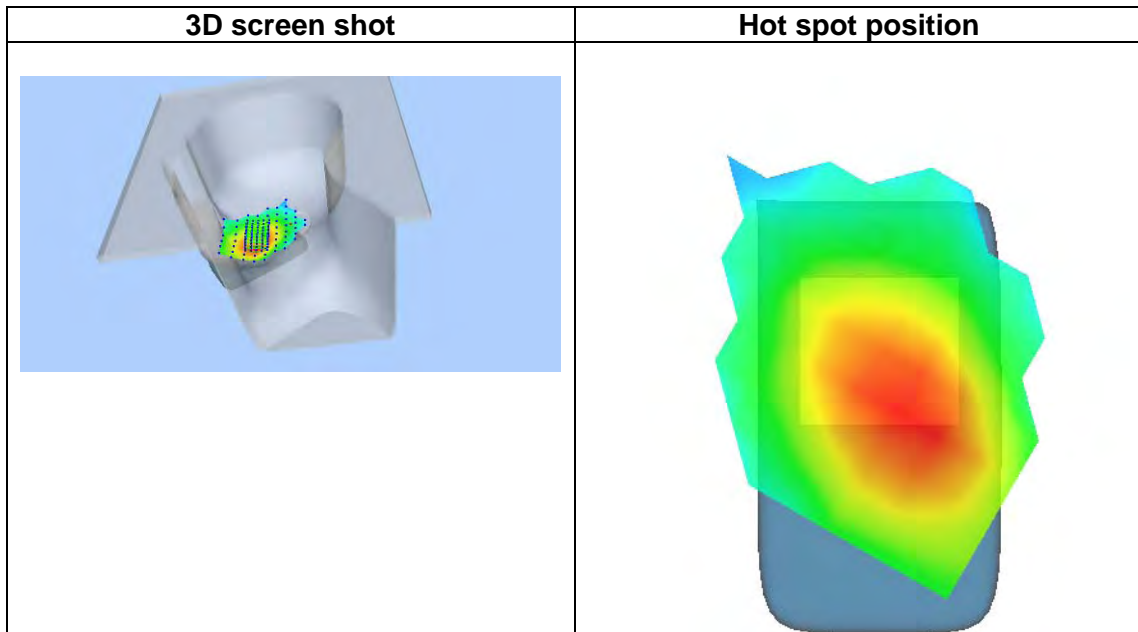
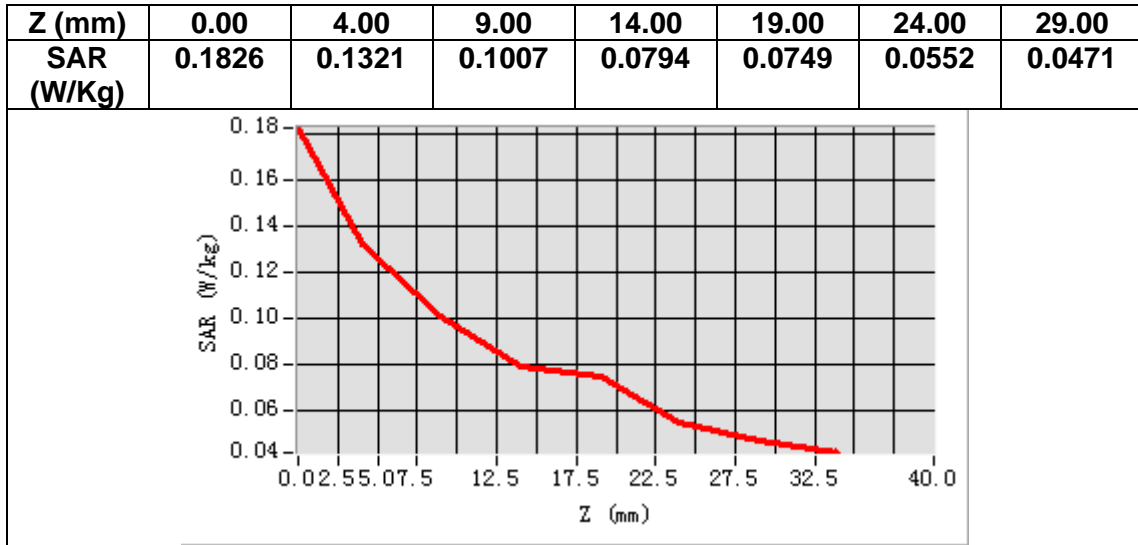

## MEASUREMENT 2

### A. Experimental conditions.

<b>Area Scan</b>	<u>dx=15mm dy=15mm, h= 5.00 mm</u>
<b>ZoomScan</b>	<u>5x5x7, dx=8mm dy=8mm dz=5mm</u>
<b>Phantom</b>	<u>Validation plane</u>
<b>Device Position</b>	<u>Body</u>
<b>Band</b>	<u>GSM850</u>
<b>Channels</b>	<u>Middle</u>
<b>Signal</b>	<u>TDMA (Crest factor: 2.0)</u>

### B. SAR Measurement Results

<b>Frequency (MHz)</b>	836.400024
<b>Relative permittivity (real part)</b>	54.924580
<b>Relative permittivity (imaginary part)</b>	20.936741
<b>Conductivity (S/m)</b>	0.972861
<b>Variation (%)</b>	0.370000

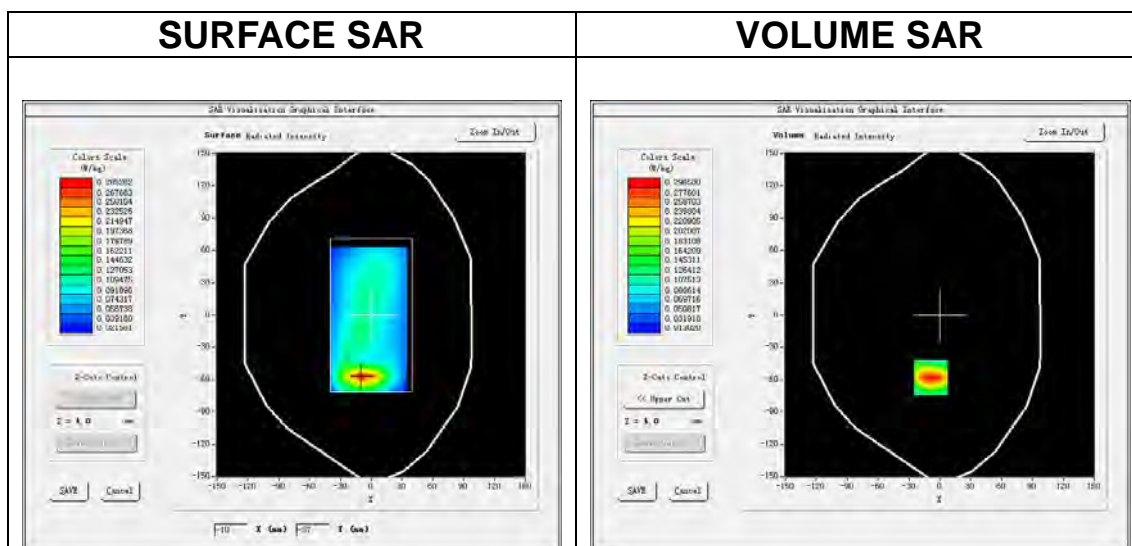

**Maximum location: X=-9.00, Y=-58.00**

**SAR Peak: 0.45 W/kg**

<b>SAR 10g (W/Kg)</b>	0.156223
<b>SAR 1g (W/Kg)</b>	0.279477

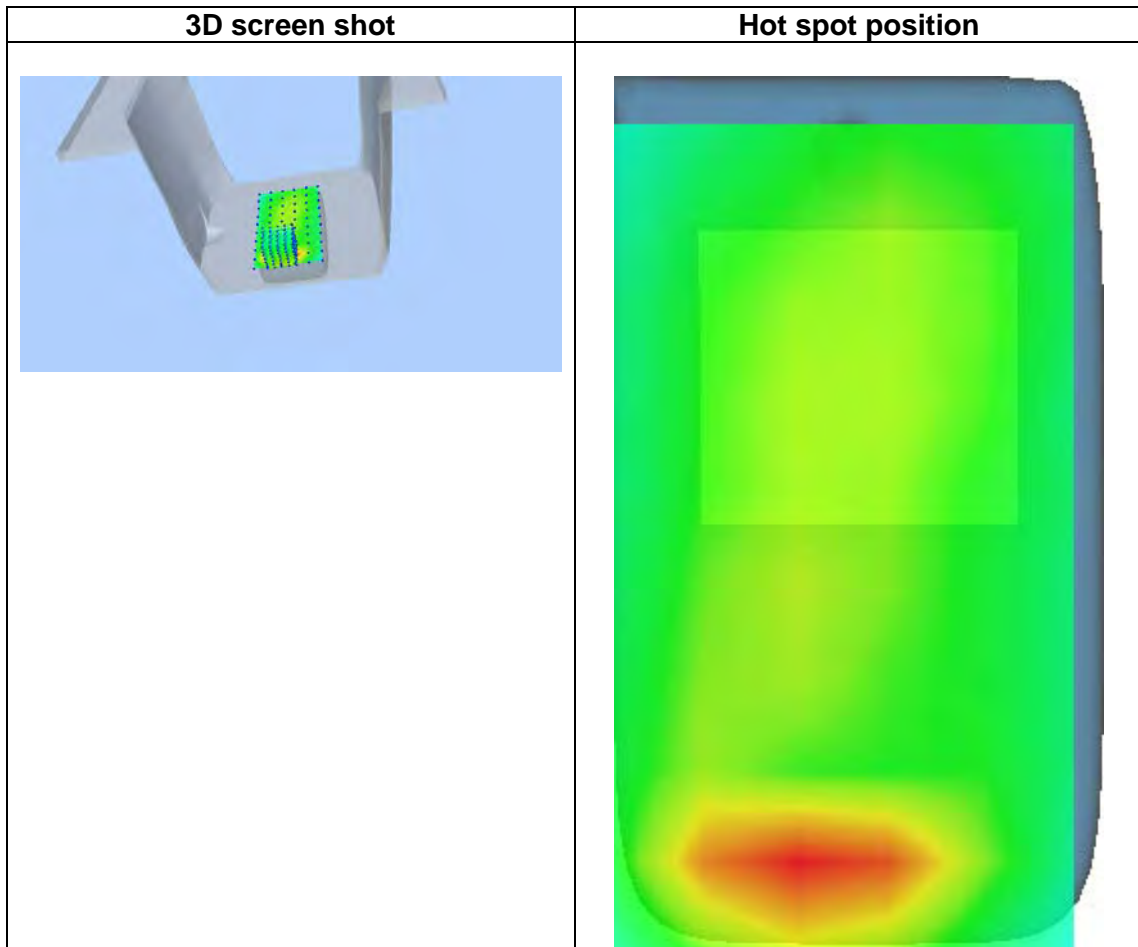
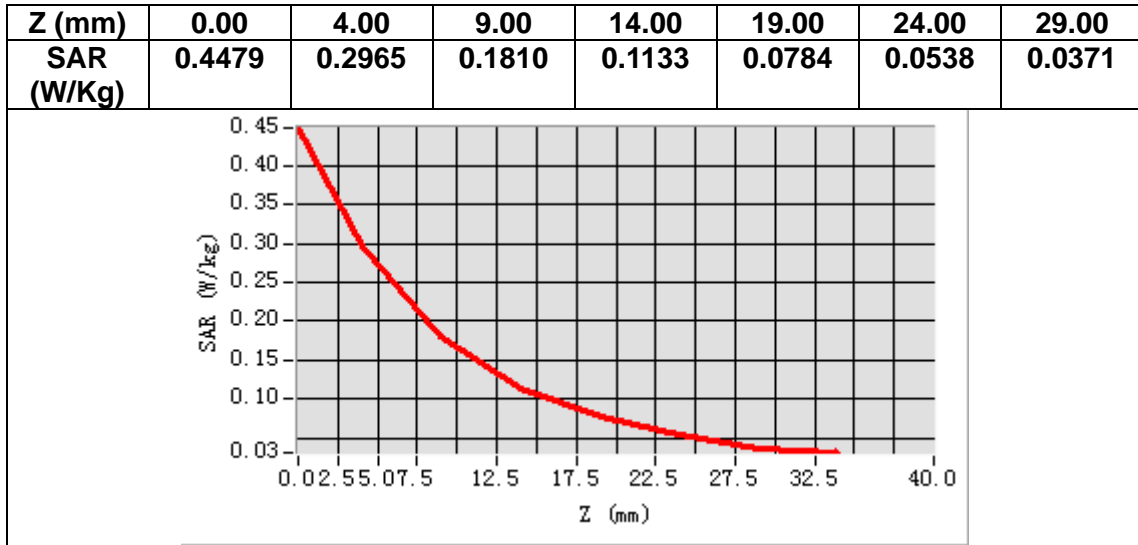



# MEASUREMENT 3

## A. Experimental conditions.

<b>Area Scan</b>	<u>dx=15mm dy=15mm, h= 5.00 mm</u>
<b>ZoomScan</b>	<u>5x5x7,dx=8mm dy=8mm dz=5mm</u>
<b>Phantom</b>	<u>Right head</u>
<b>Device Position</b>	<u>Cheek</u>
<b>Band</b>	<u>GSM1900</u>
<b>Channels</b>	<u>Middle</u>
<b>Signal</b>	<u>TDMA (Crest factor: 2.0)</u>

## B. SAR Measurement Results

<b>Frequency (MHz)</b>	1880.000000
<b>Relative permittivity (real part)</b>	38.937000
<b>Relative permittivity (imaginary part)</b>	13.300200
<b>Conductivity (S/m)</b>	1.389132
<b>Variation (%)</b>	0.310000

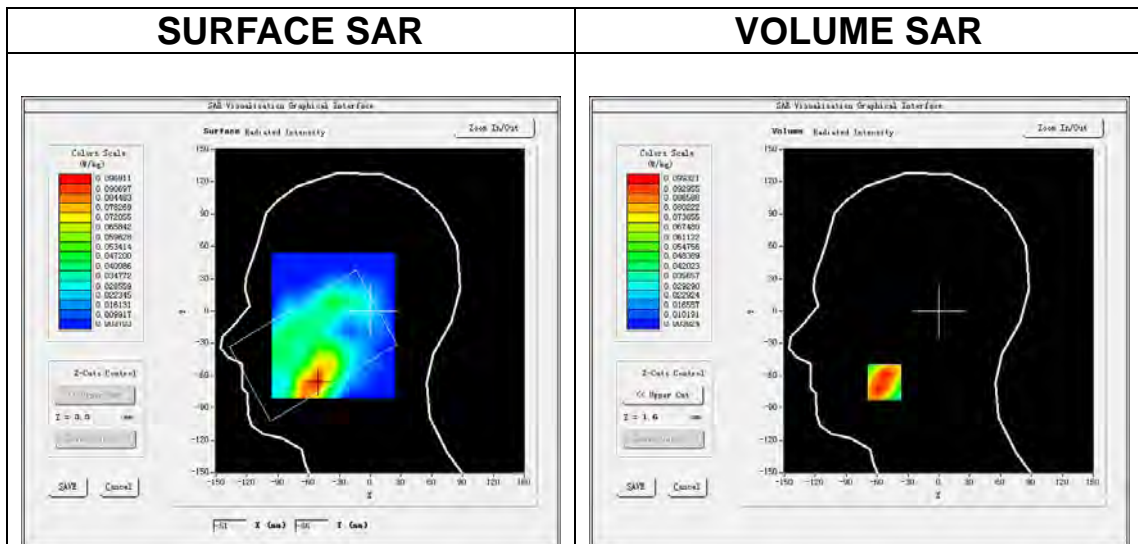

**Maximum location: X=-53.00, Y=-66.00**

**SAR Peak: 0.15 W/kg**

<b>SAR 10g (W/Kg)</b>	0.060997
<b>SAR 1g (W/Kg)</b>	0.093995

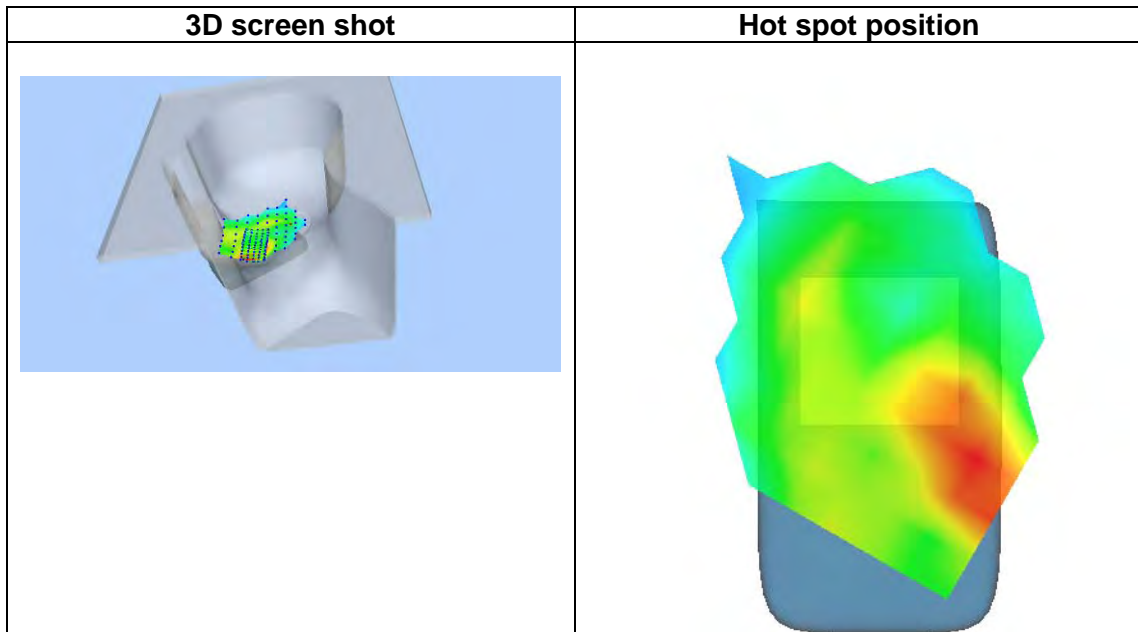
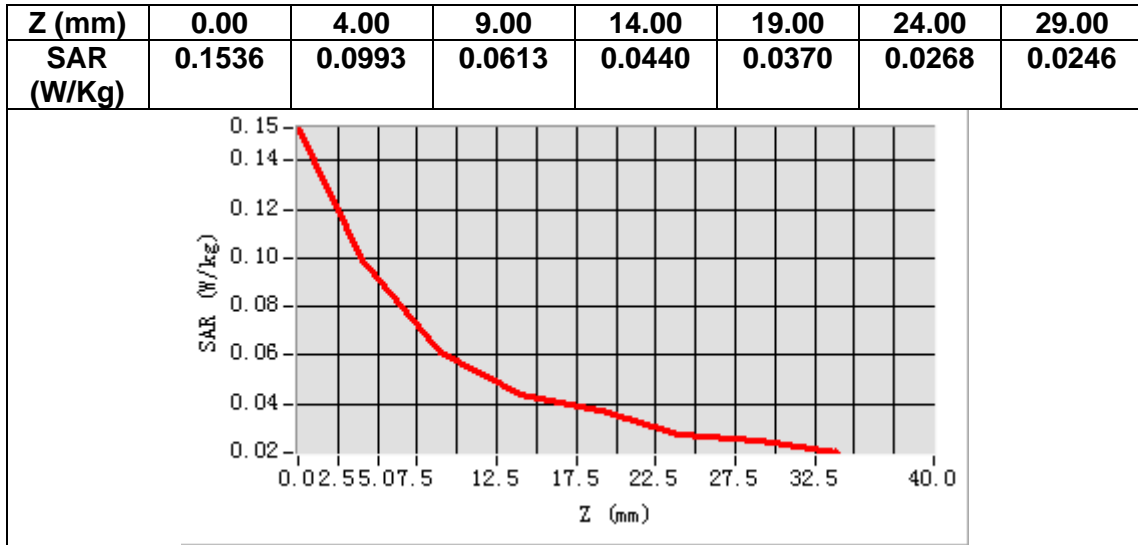

# MEASUREMENT 4

## A. Experimental conditions.

<b>Area Scan</b>	<u>dx=15mm dy=15mm, h= 5.00 mm</u>
<b>ZoomScan</b>	<u>5x5x7, dx=8mm dy=8mm dz=5mm</u>
<b>Phantom</b>	<u>Validation plane</u>
<b>Device Position</b>	<u>Body</u>
<b>Band</b>	<u>GSM1900</u>
<b>Channels</b>	<u>Middle</u>
<b>Signal</b>	<u>TDMA (Crest factor: 2.0)</u>

## B. SAR Measurement Results

<b>Frequency (MHz)</b>	1880.000000
<b>Relative permittivity (real part)</b>	53.381901
<b>Relative permittivity (imaginary part)</b>	14.653700
<b>Conductivity (S/m)</b>	1.530498
<b>Variation (%)</b>	-0.820000

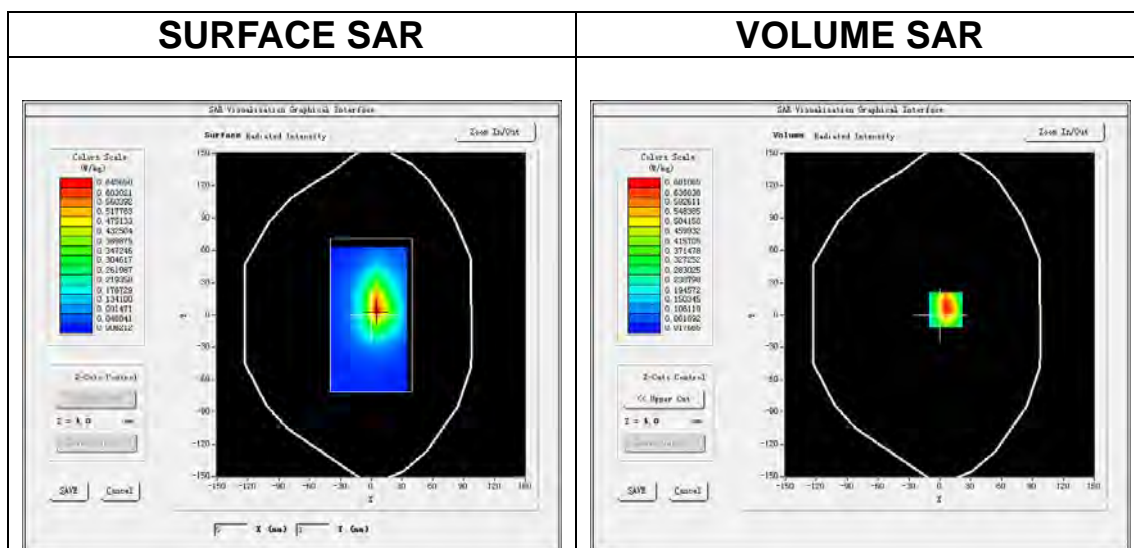

**Maximum location: X=6.00, Y=5.00**

**SAR Peak: 1.02 W/kg**

<b>SAR 10g (W/Kg)</b>	0.348190
<b>SAR 1g (W/Kg)</b>	0.641636

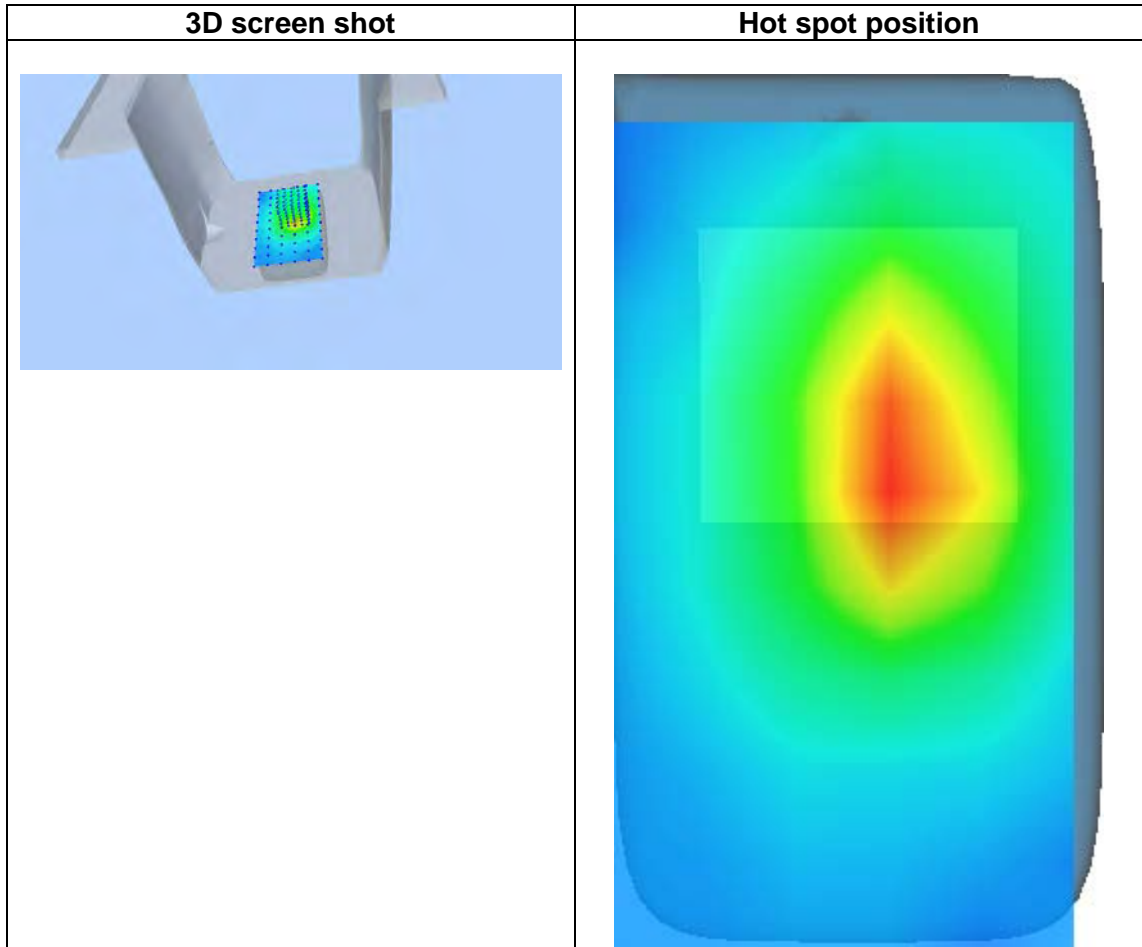
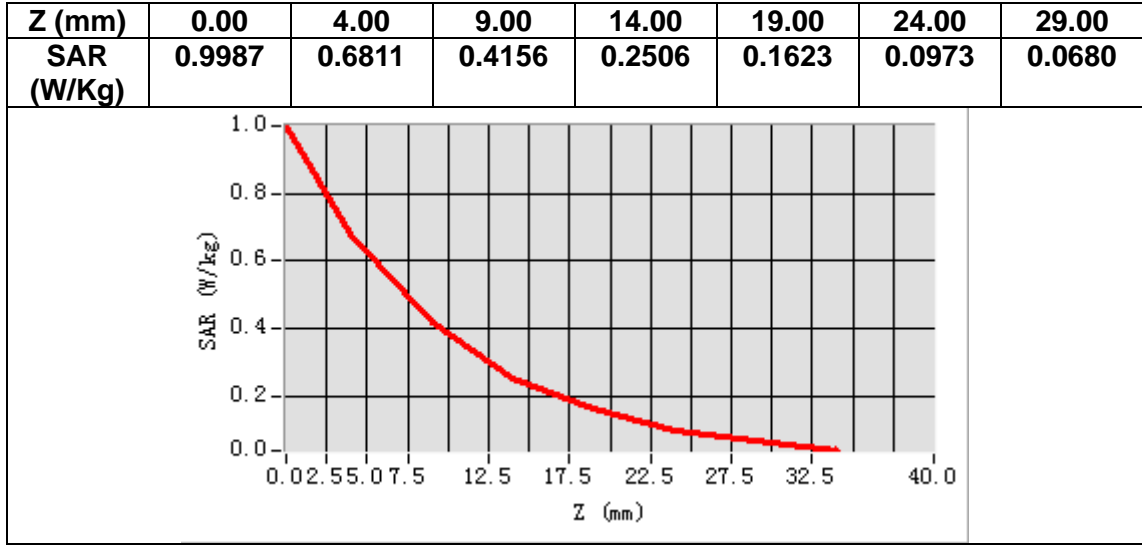

# MEASUREMENT 5

## A. Experimental conditions.

<b>Area Scan</b>	<u>dx=15mm dy=15mm, h= 5.00 mm</u>
<b>ZoomScan</b>	<u>5x5x7,dx=8mm dy=8mm dz=5mm</u>
<b>Phantom</b>	<u>Right head</u>
<b>Device Position</b>	<u>Cheek</u>
<b>Band</b>	<u>Band2_WCDMA1900</u>
<b>Channels</b>	<u>Middle</u>
<b>Signal</b>	<u>WCDMA (Crest factor: 1.0)</u>

## B. SAR Measurement Results

<b>Frequency (MHz)</b>	1880.000000
<b>Relative permittivity (real part)</b>	38.937000
<b>Relative permittivity (imaginary part)</b>	13.300200
<b>Conductivity (S/m)</b>	1.389132
<b>Variation (%)</b>	2.790000

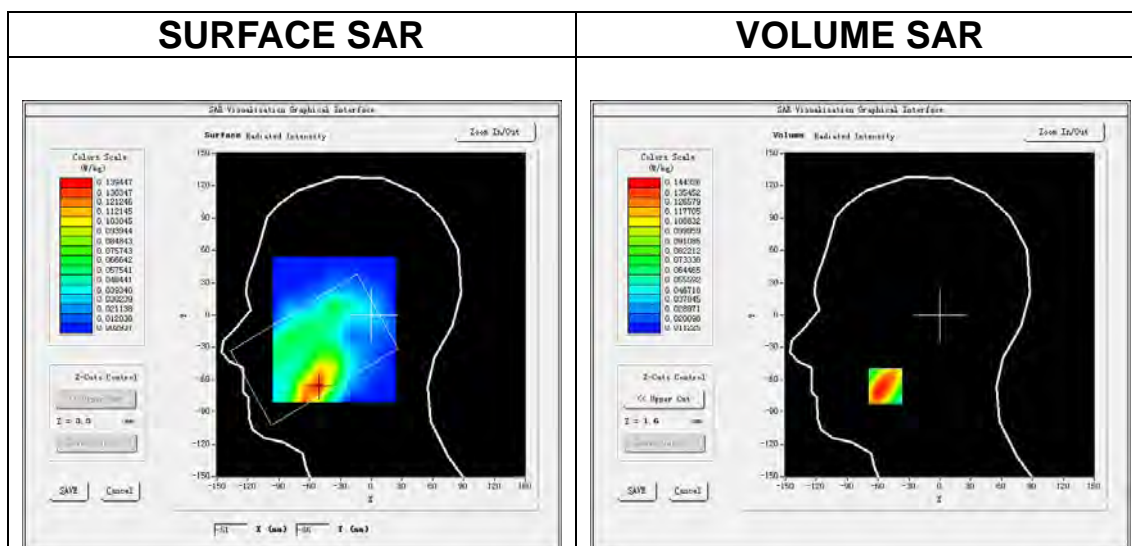

**Maximum location: X=-53.00, Y=-66.00**

**SAR Peak: 0.22 W/kg**

<b>SAR 10g (W/Kg)</b>	0.086680
<b>SAR 1g (W/Kg)</b>	0.143670

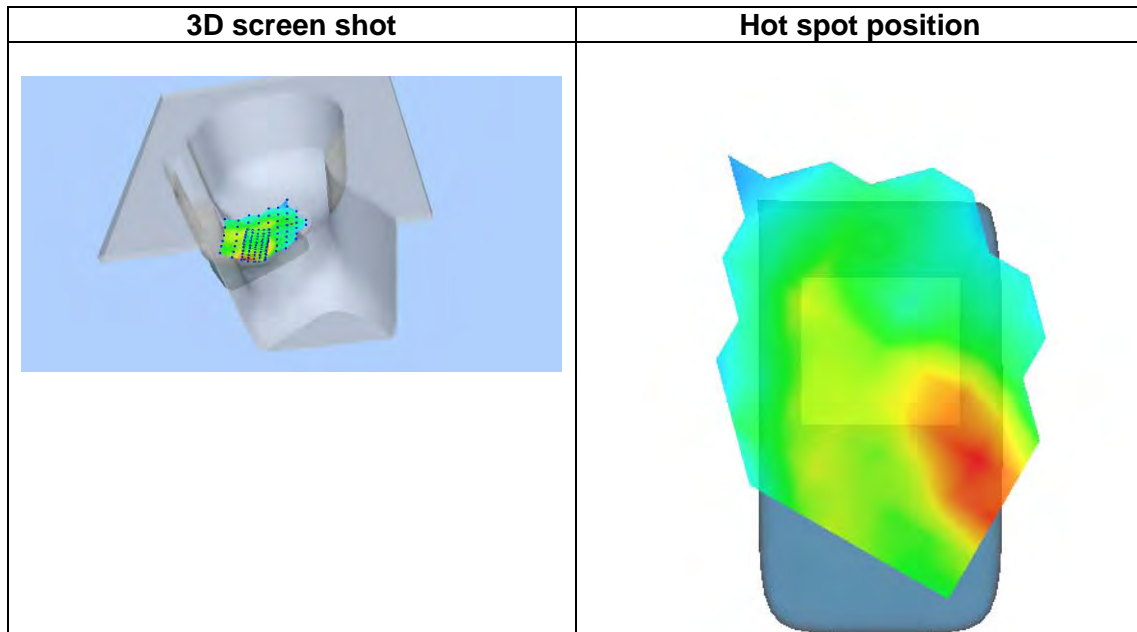
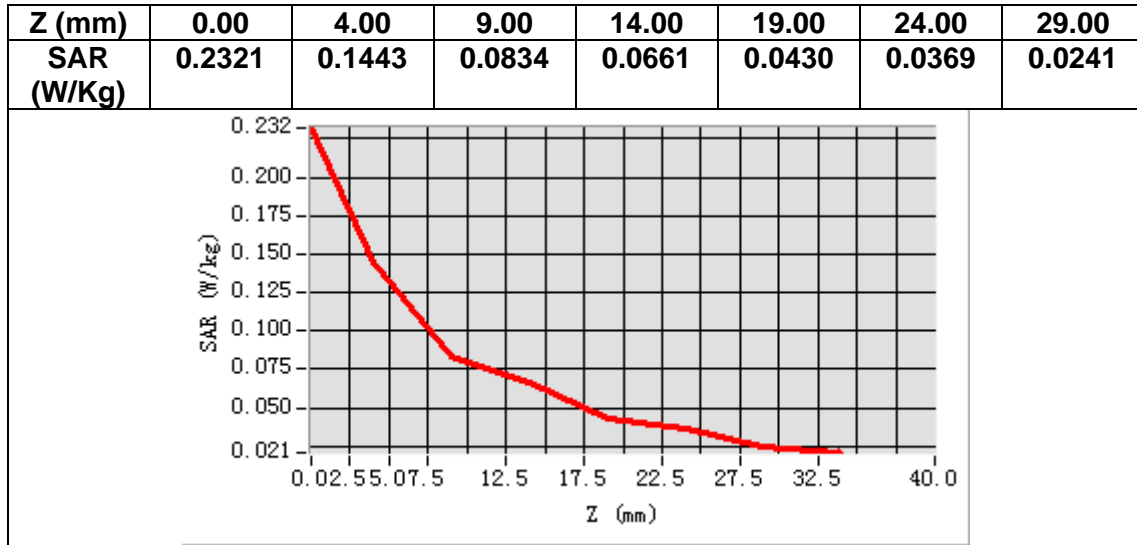

# MEASUREMENT 6

## A. Experimental conditions.

<b>Area Scan</b>	<u>dx=15mm dy=15mm, h= 5.00 mm</u>
<b>ZoomScan</b>	<u>5x5x7, dx=8mm dy=8mm dz=5mm</u>
<b>Phantom</b>	<u>Validation plane</u>
<b>Device Position</b>	<u>Body</u>
<b>Band</b>	<u>Band2_WCDMA1900</u>
<b>Channels</b>	<u>High</u>
<b>Signal</b>	<u>WCDMA (Crest factor: 1.0)</u>

## B. SAR Measurement Results

<b>Frequency (MHz)</b>	1907.600000
<b>Relative permittivity (real part)</b>	53.299599
<b>Relative permittivity (imaginary part)</b>	14.584460
<b>Conductivity (S/m)</b>	1.545629
<b>Variation (%)</b>	0.180000

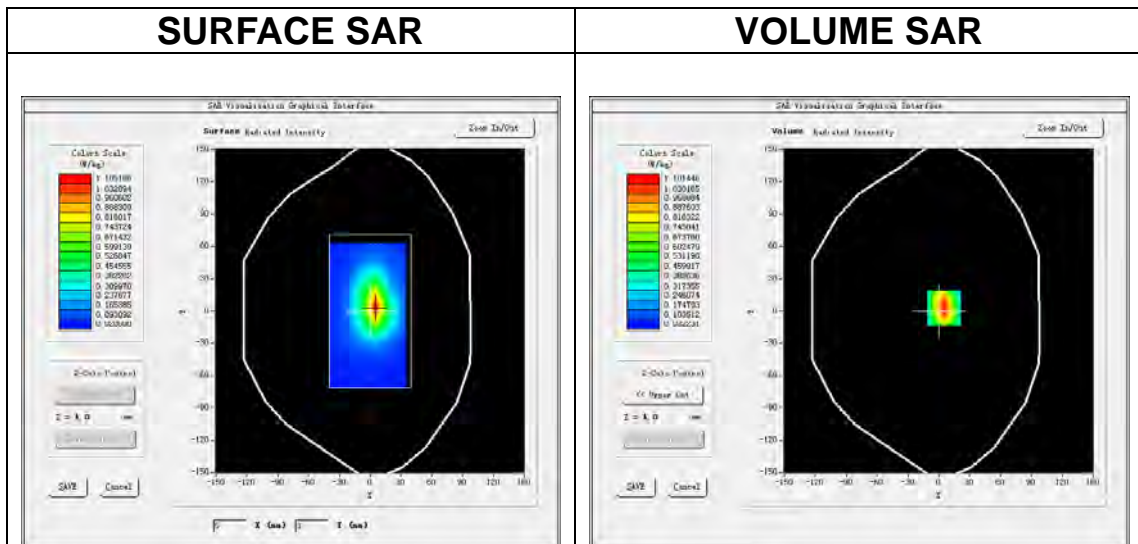

**Maximum location: X=5.00, Y=3.00**

**SAR Peak: 1.63 W/kg**

<b>SAR 10g (W/Kg)</b>	0.554947
<b>SAR 1g (W/Kg)</b>	1.029377



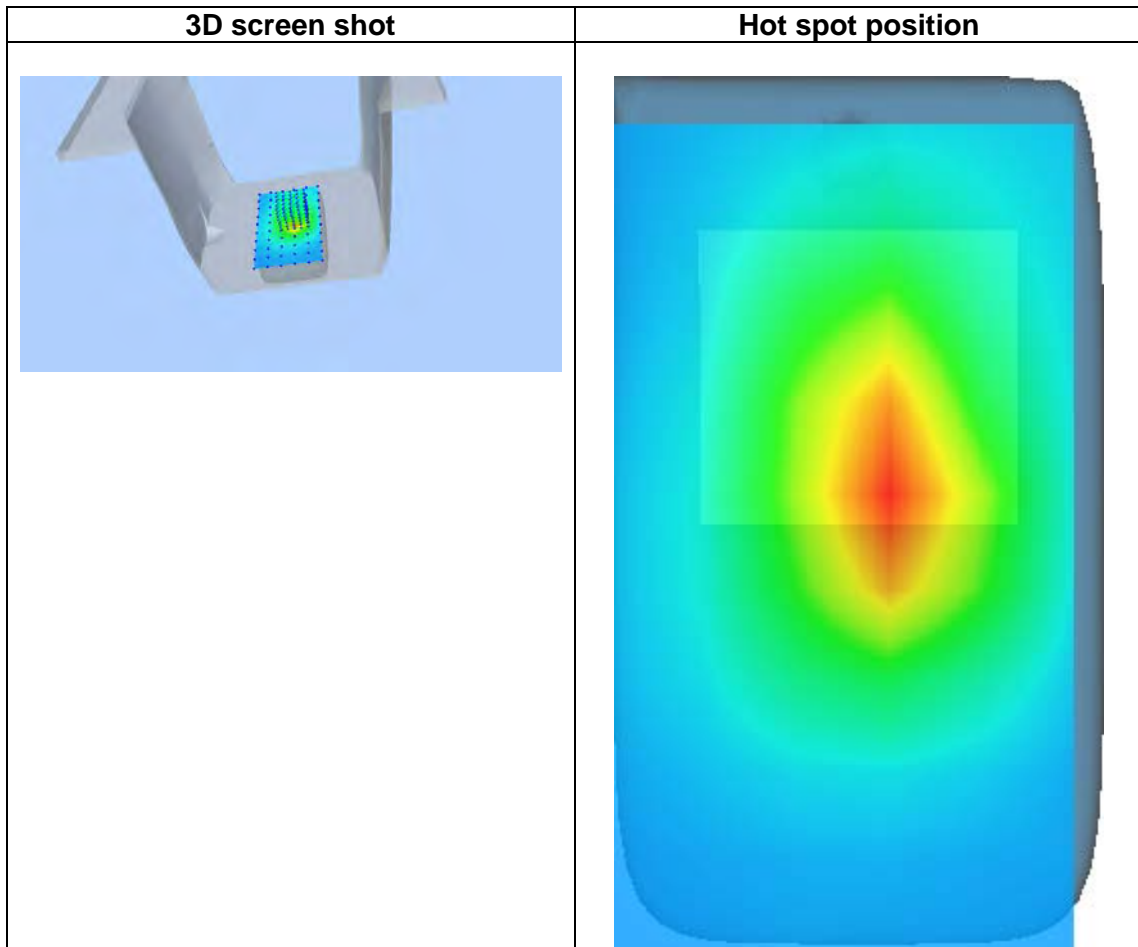
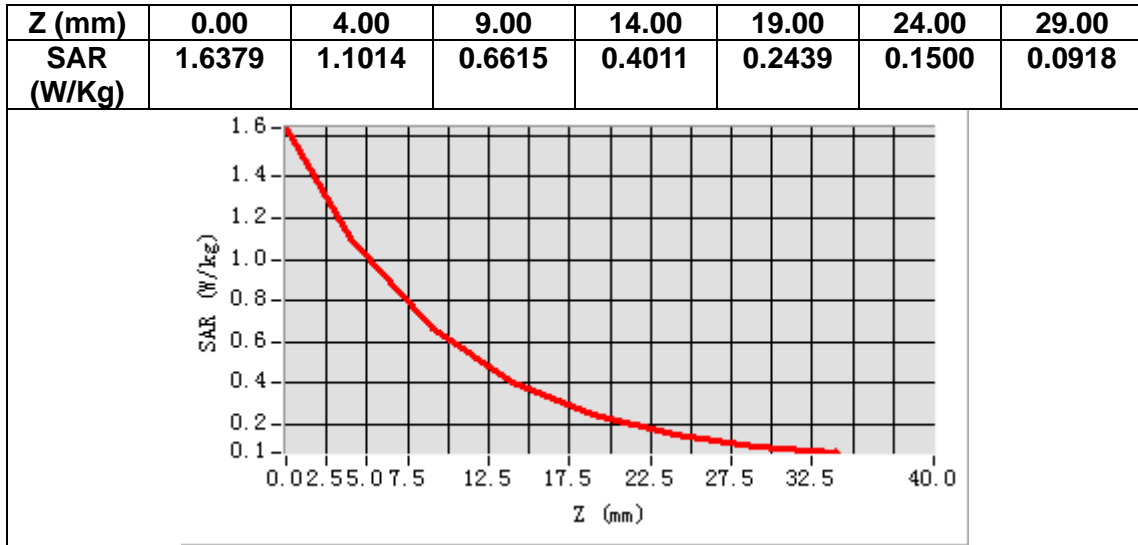

# MEASUREMENT 7

## A. Experimental conditions.

<b>Area Scan</b>	<u>dx=15mm dy=15mm, h= 5.00 mm</u>
<b>ZoomScan</b>	<u>5x5x7,dx=8mm dy=8mm dz=5mm</u>
<b>Phantom</b>	<u>Right head</u>
<b>Device Position</b>	<u>Cheek</u>
<b>Band</b>	<u>Band4_WCDMA1700</u>
<b>Channels</b>	<u>Middle</u>
<b>Signal</b>	<u>WCDMA (Crest factor: 1.0)</u>

## B. SAR Measurement Results

<b>Frequency (MHz)</b>	1732.600000
<b>Relative permittivity (real part)</b>	40.170399
<b>Relative permittivity (imaginary part)</b>	13.680200
<b>Conductivity (S/m)</b>	1.316339
<b>Variation (%)</b>	0.490000

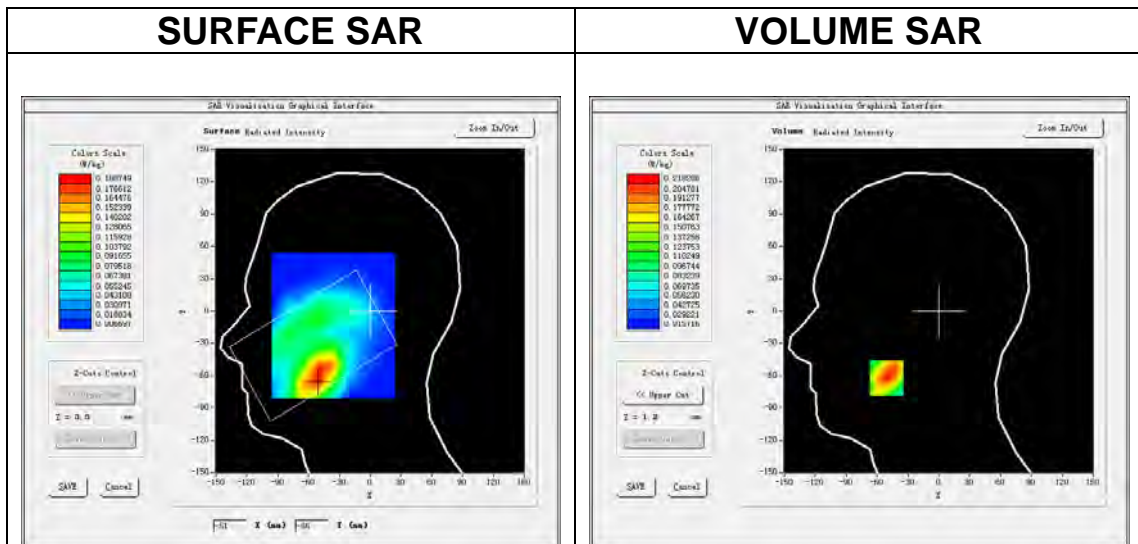

**Maximum location: X=-51.00, Y=-62.00**

**SAR Peak: 0.31 W/kg**

<b>SAR 10g (W/Kg)</b>	0.130247
<b>SAR 1g (W/Kg)</b>	0.207586

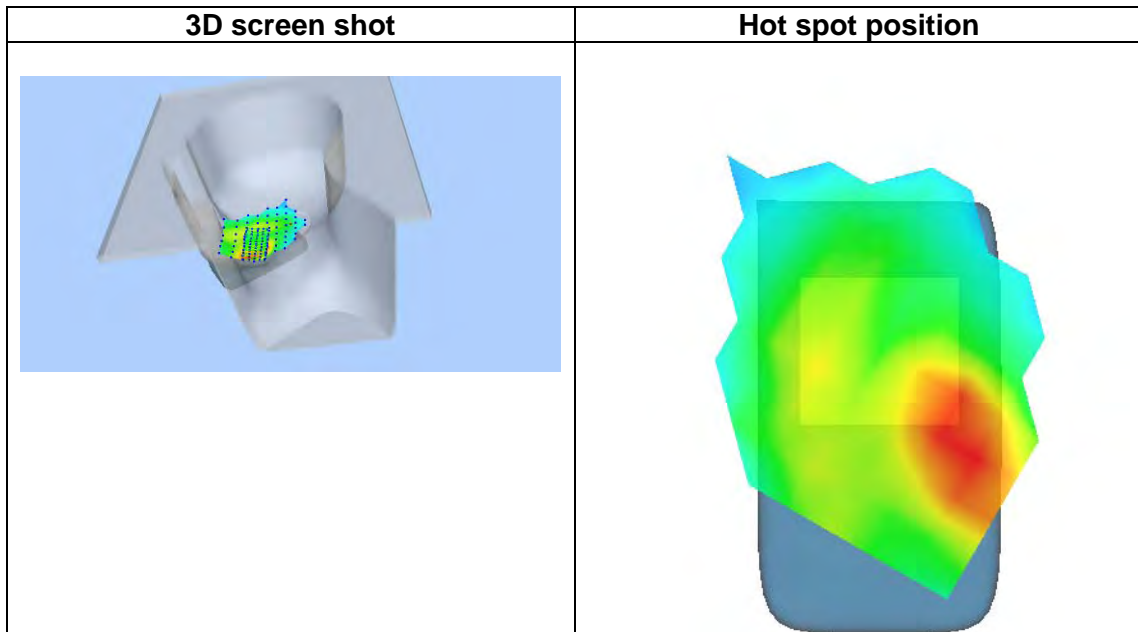
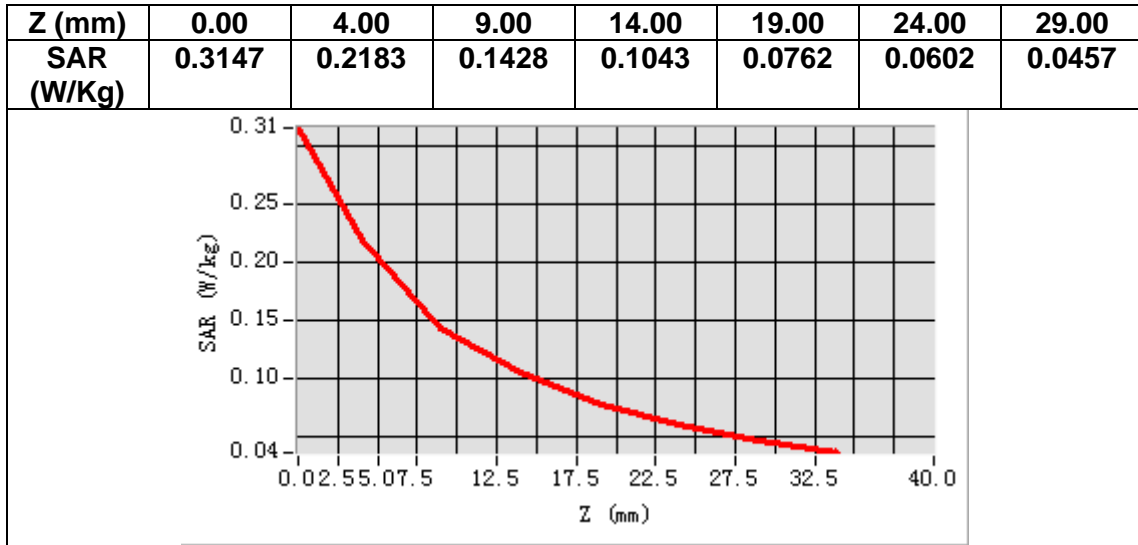

# MEASUREMENT 8

## A. Experimental conditions.

<b>Area Scan</b>	<u>dx=15mm dy=15mm, h= 5.00 mm</u>
<b>ZoomScan</b>	<u>5x5x7, dx=8mm dy=8mm dz=5mm</u>
<b>Phantom</b>	<u>Validation plane</u>
<b>Device Position</b>	<u>Body</u>
<b>Band</b>	<u>Band4_WCDMA1700</u>
<b>Channels</b>	<u>Middle</u>
<b>Signal</b>	<u>WCDMA (Crest factor: 1.0)</u>

## B. SAR Measurement Results

<b>Frequency (MHz)</b>	1732.600000
<b>Relative permittivity (real part)</b>	54.421165
<b>Relative permittivity (imaginary part)</b>	15.196370
<b>Conductivity (S/m)</b>	1.462228
<b>Variation (%)</b>	-1.240000

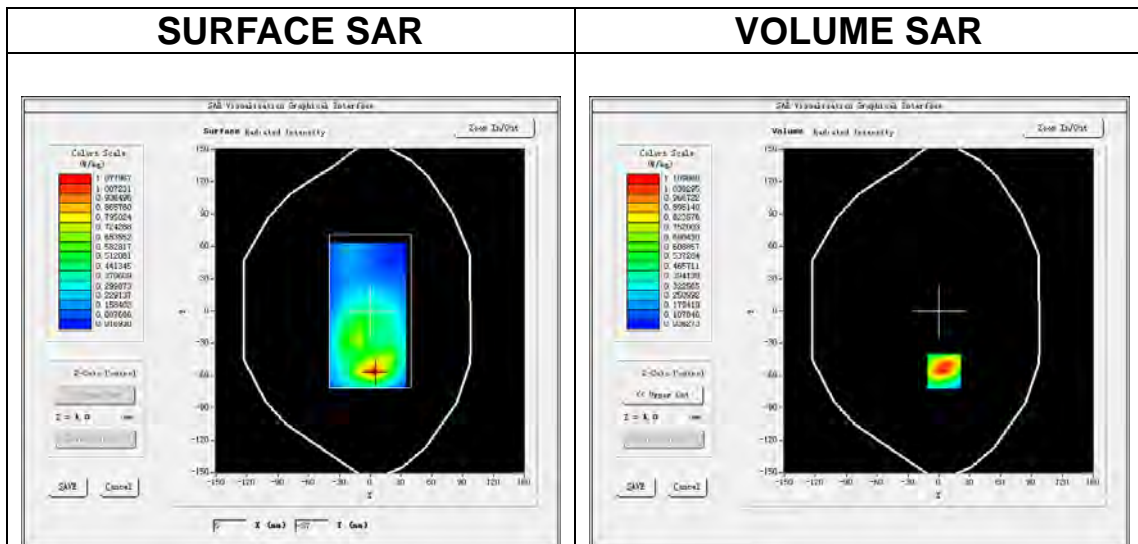

**Maximum location: X=5.00, Y=-56.00**

**SAR Peak: 1.71 W/kg**

<b>SAR 10g (W/Kg)</b>	0.579736
<b>SAR 1g (W/Kg)</b>	1.063106

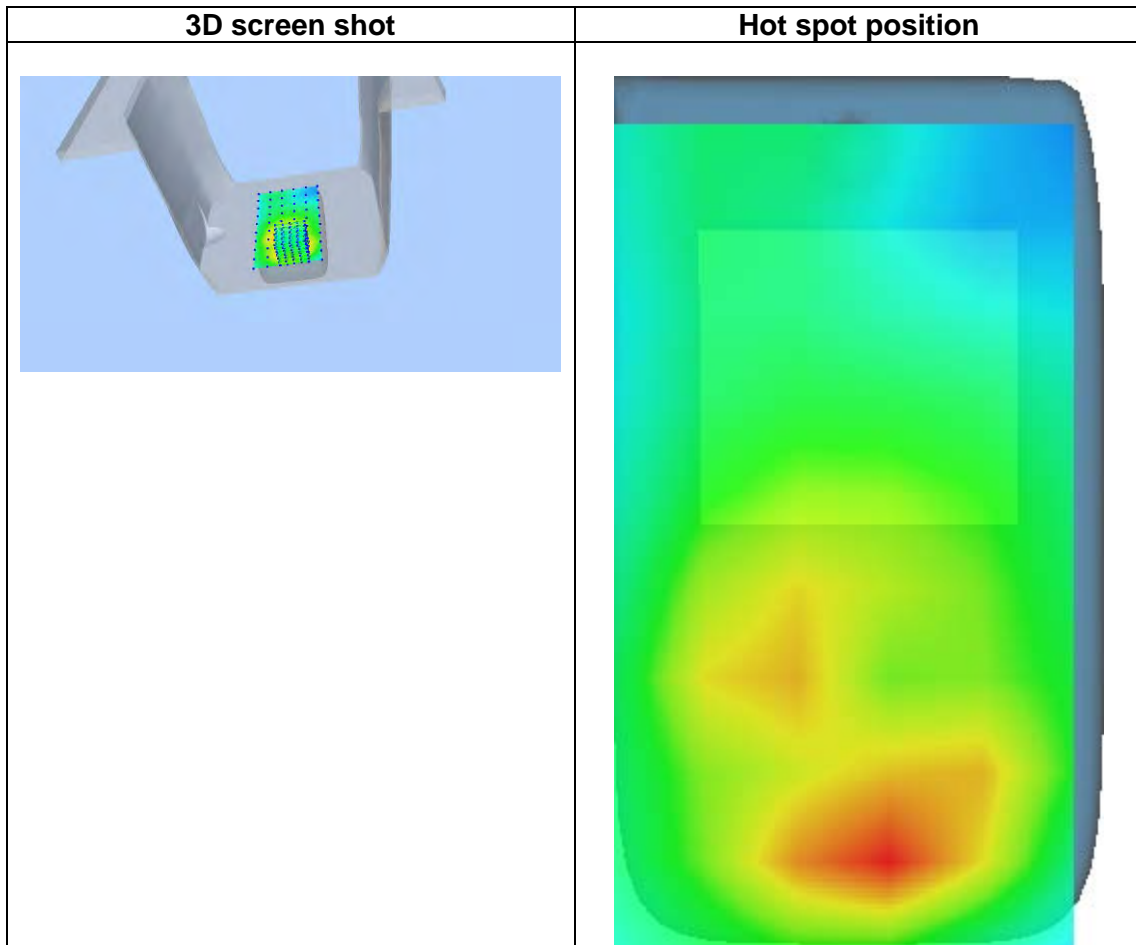
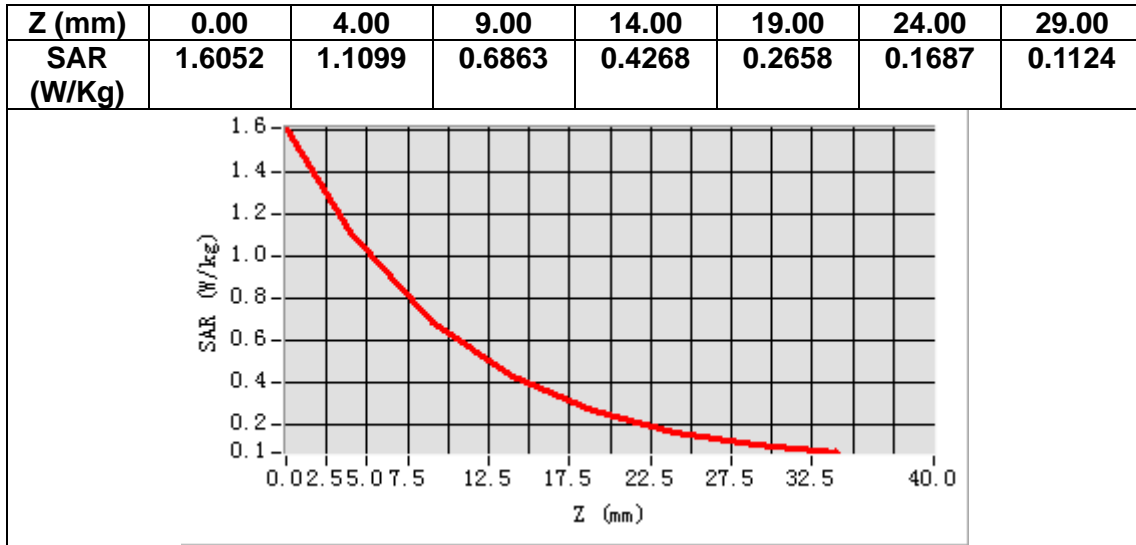

# MEASUREMENT 9

## A. Experimental conditions.

<b>Area Scan</b>	<u>dx=15mm dy=15mm, h= 5.00 mm</u>
<b>ZoomScan</b>	<u>5x5x7,dx=8mm dy=8mm dz=5mm</u>
<b>Phantom</b>	<u>Right head</u>
<b>Device Position</b>	<u>Cheek</u>
<b>Band</b>	<u>Band5_WCDMA850</u>
<b>Channels</b>	<u>Middle</u>
<b>Signal</b>	<u>WCDMA (Crest factor: 1.0)</u>

## B. SAR Measurement Results

<b>Frequency (MHz)</b>	836.400000
<b>Relative permittivity (real part)</b>	41.788960
<b>Relative permittivity (imaginary part)</b>	19.511240
<b>Conductivity (S/m)</b>	0.906622
<b>Variation (%)</b>	4.660000

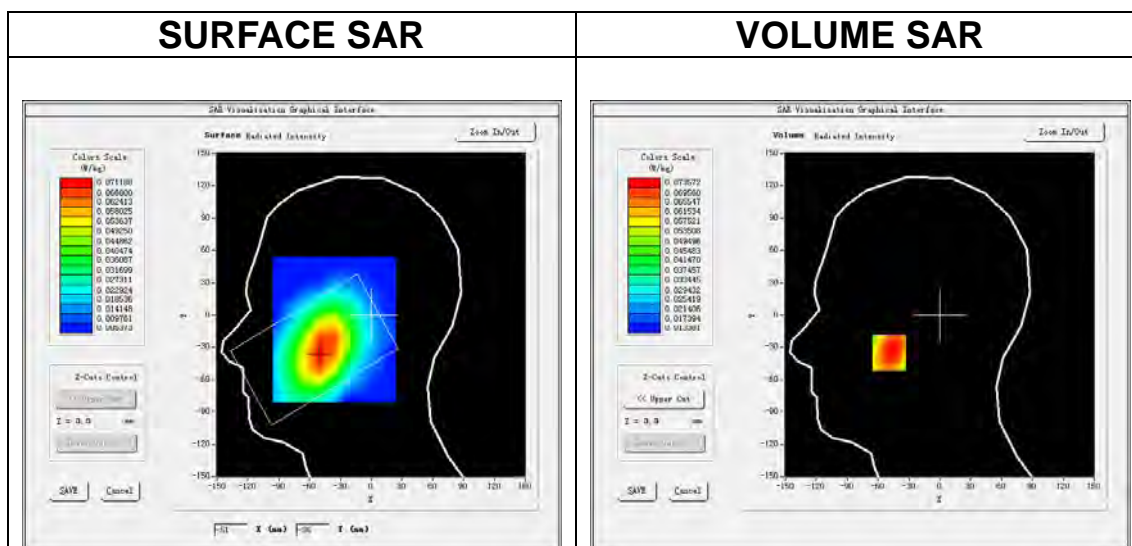

**Maximum location: X=-49.00, Y=-35.00**

**SAR Peak: 0.10 W/kg**

<b>SAR 10g (W/Kg)</b>	0.056811
<b>SAR 1g (W/Kg)</b>	0.073410

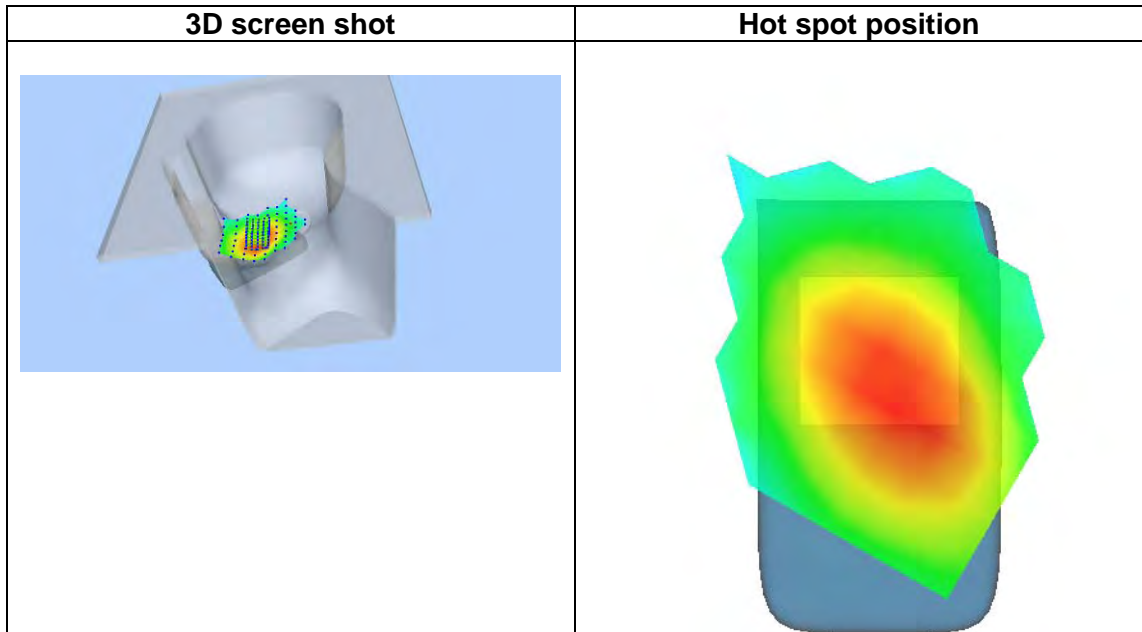
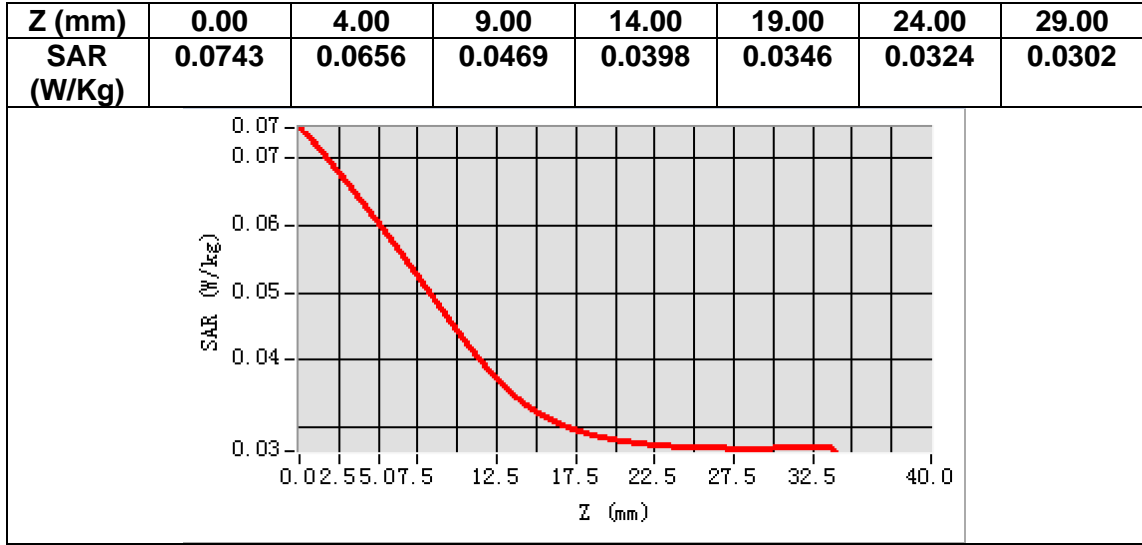



# MEASUREMENT 10

## A. Experimental conditions.

<b>Area Scan</b>	<u>dx=15mm dy=15mm, h= 5.00 mm</u>
<b>ZoomScan</b>	<u>5x5x7,dx=8mm dy=8mm dz=5mm</u>
<b>Phantom</b>	<u>Validation plane</u>
<b>Device Position</b>	<u>Body</u>
<b>Band</b>	<u>Band5_WCDMA850</u>
<b>Channels</b>	<u>Middle</u>
<b>Signal</b>	<u>WCDMA (Crest factor: 1.0)</u>

## B. SAR Measurement Results

<b>Frequency (MHz)</b>	836.400000
<b>Relative permittivity (real part)</b>	54.924580
<b>Relative permittivity (imaginary part)</b>	20.936741
<b>Conductivity (S/m)</b>	0.972861
<b>Variation (%)</b>	2.170000

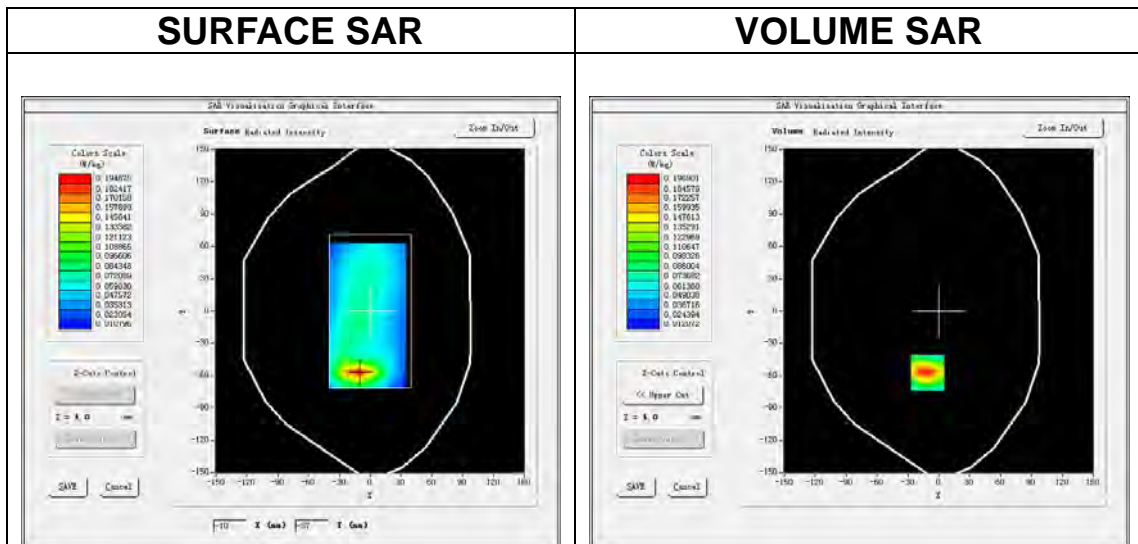

**Maximum location: X=-11.00, Y=-57.00**

**SAR Peak: 0.29 W/kg**

<b>SAR 10g (W/Kg)</b>	0.103833
<b>SAR 1g (W/Kg)</b>	0.184965

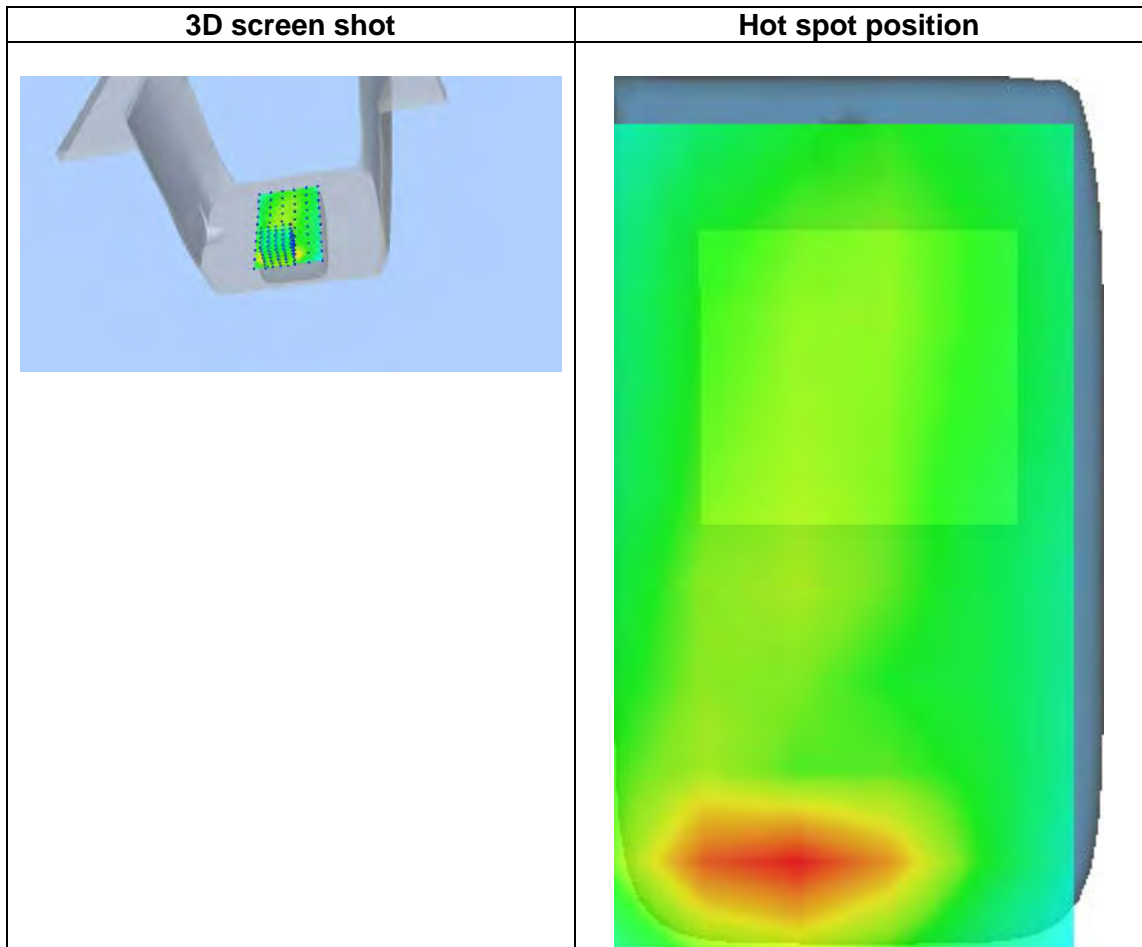
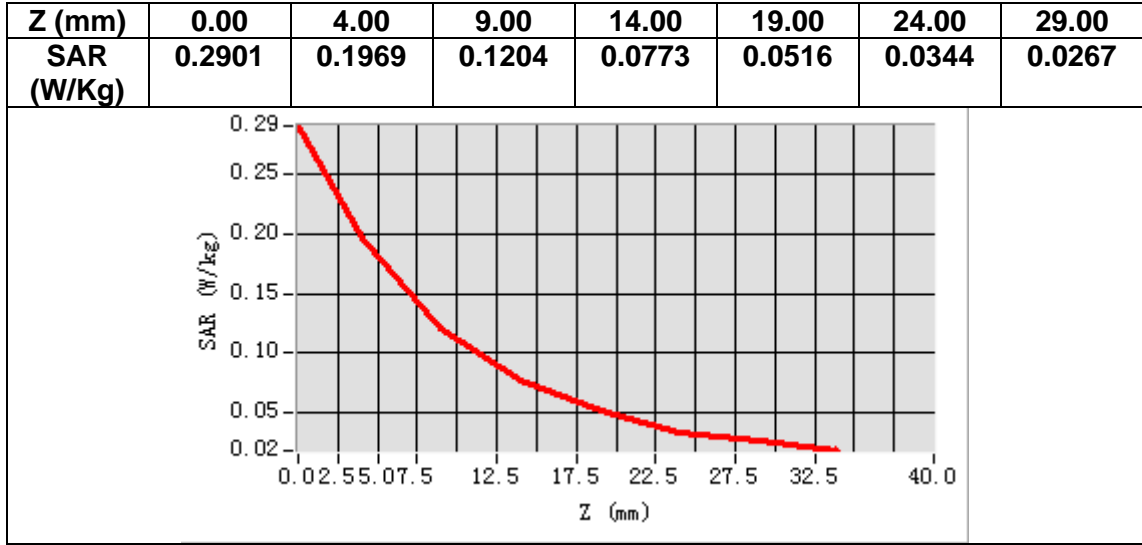

# MEASUREMENT 11

## A. Experimental conditions.

<b>Area Scan</b>	<u>dx=12mm dy=12mm, h= 5.00 mm</u>
<b>ZoomScan</b>	<u>7x7x7,dx=5mm dy=5mm dz=5mm</u>
<b>Phantom</b>	<u>Left head</u>
<b>Device Position</b>	<u>Cheek</u>
<b>Band</b>	<u>IEEE 802.11b ISM</u>
<b>Channels</b>	<u>Middle</u>
<b>Signal</b>	<u>IEEE802.11b (Crest factor: 1.0)</u>

## B. SAR Measurement Results

<b>Frequency (MHz)</b>	2437.000000
<b>Relative permittivity (real part)</b>	39.688900
<b>Relative permittivity (imaginary part)</b>	13.468200
<b>Conductivity (S/m)</b>	1.827186
<b>Variation (%)</b>	0.980000

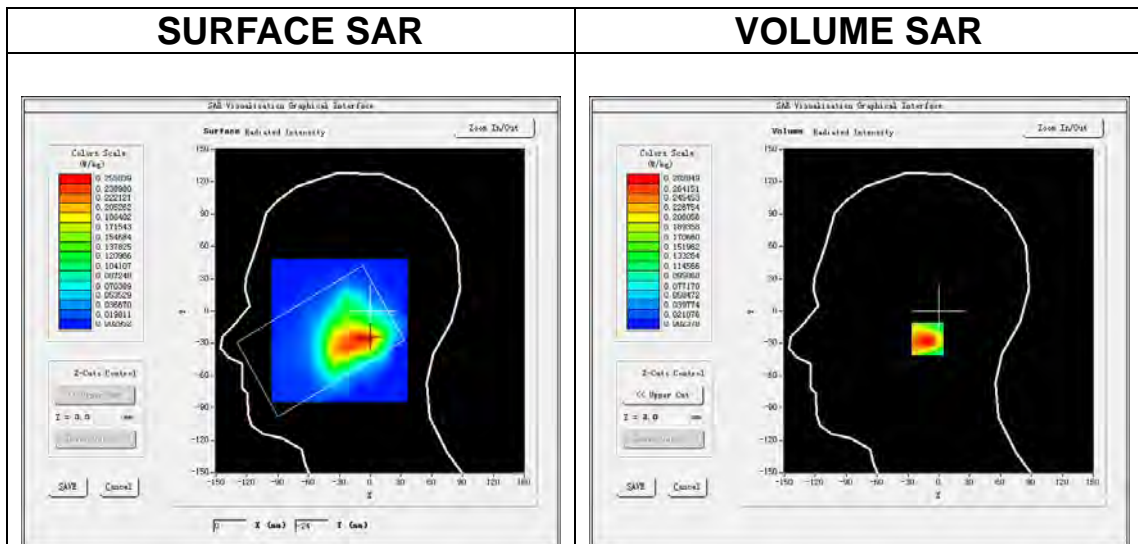

**Maximum location: X=-5.00, Y=-26.00**

**SAR Peak: 0.48 W/kg**

<b>SAR 10g (W/Kg)</b>	0.142750
<b>SAR 1g (W/Kg)</b>	0.265245

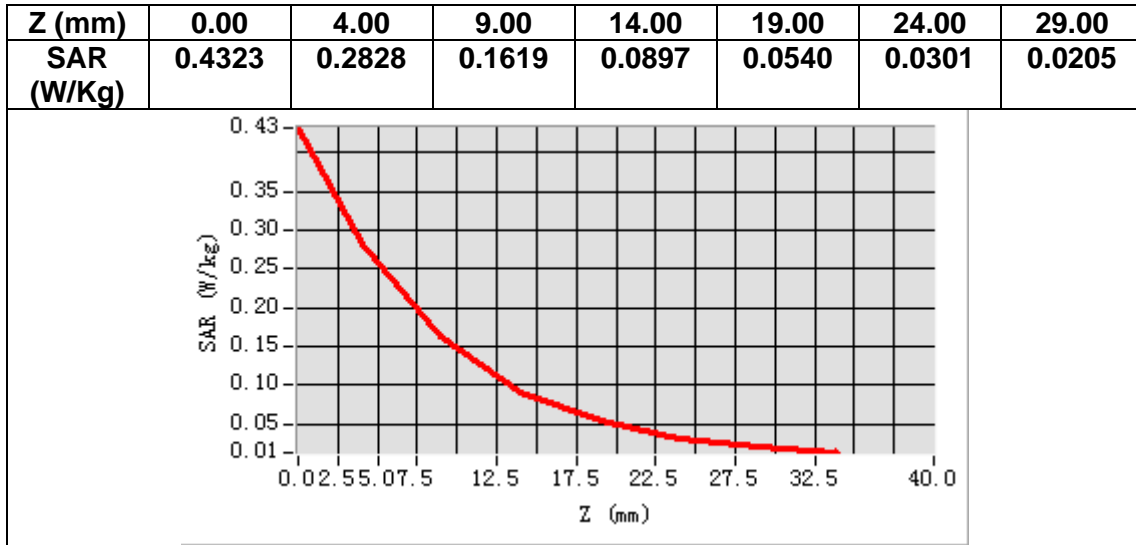

# MEASUREMENT 12

## A. Experimental conditions.

<b>Area Scan</b>	<u>dx=12mm dy=12mm, h= 5.00 mm</u>
<b>ZoomScan</b>	<u>7x7x7, dx=5mm dy=5mm dz=5mm</u>
<b>Phantom</b>	<u>Validation plane</u>
<b>Device Position</b>	<u>Body</u>
<b>Band</b>	<u>IEEE 802.11b ISM</u>
<b>Channels</b>	<u>Middle</u>
<b>Signal</b>	<u>IEEE802.11b (Crest factor: 1.0)</u>

## B. SAR Measurement Results

<b>Frequency (MHz)</b>	2437.000000
<b>Relative permittivity (real part)</b>	52.104099
<b>Relative permittivity (imaginary part)</b>	14.307920
<b>Conductivity (S/m)</b>	1.941108
<b>Variation (%)</b>	-4.680000

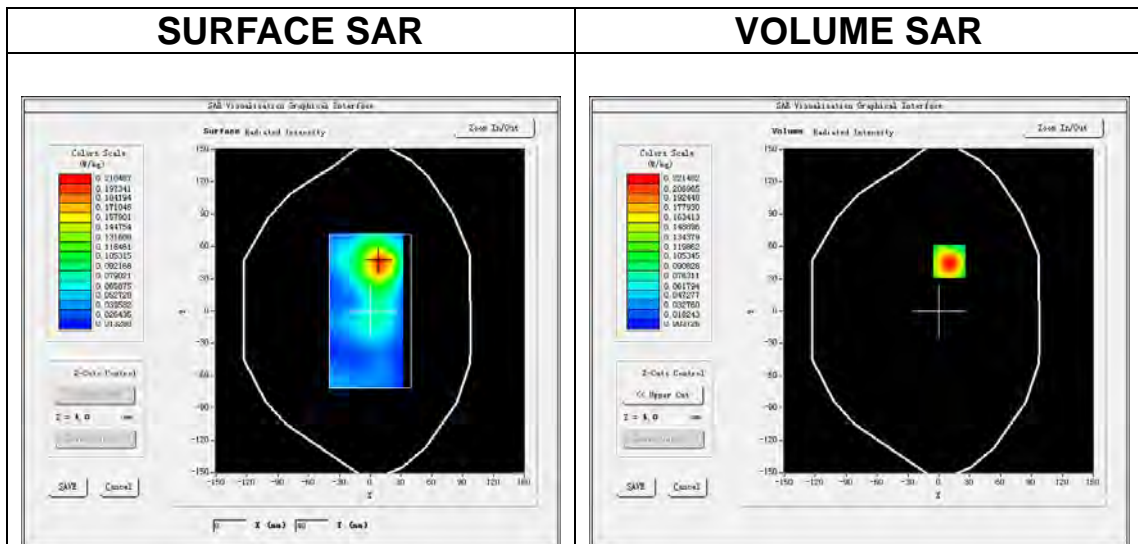

**Maximum location: X=10.00, Y=46.00**

**SAR Peak: 0.36 W/kg**

<b>SAR 10g (W/Kg)</b>	0.112213
<b>SAR 1g (W/Kg)</b>	0.209780

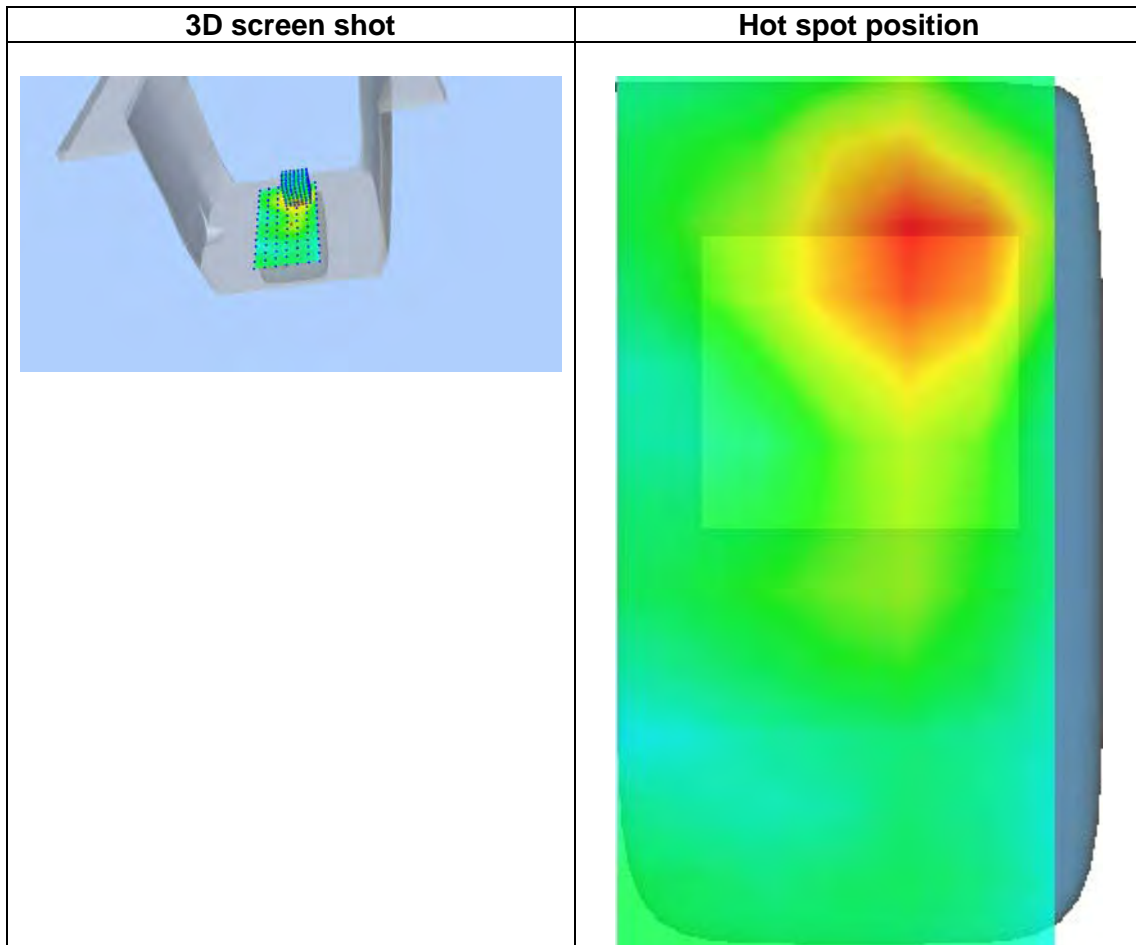
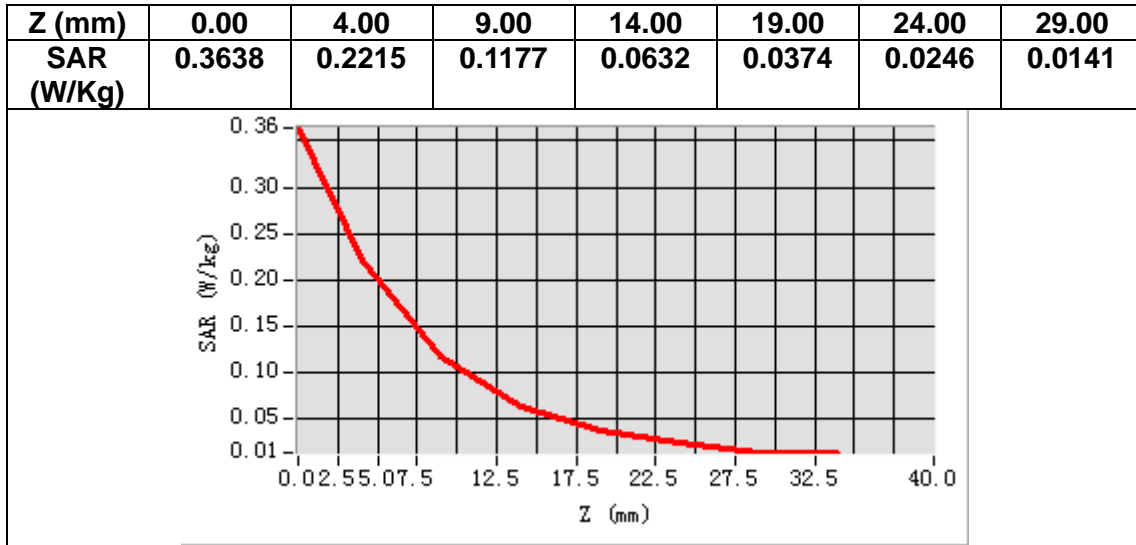

# MEASUREMENT 13

## A. Experimental conditions.

<b>Area Scan</b>	<u>dx=15mm dy=15mm, h= 5.00 mm</u>
<b>ZoomScan</b>	<u>5x5x7,dx=8mm dy=8mm dz=5mm</u>
<b>Phantom</b>	<u>Right head</u>
<b>Device Position</b>	<u>Cheek</u>
<b>Band</b>	<u>LTE band 2</u>
<b>Channels</b>	<u>Middle</u>
<b>Signal</b>	<u>LTE (Crest factor: 1.0)</u>

## B. SAR Measurement Results

<b>Frequency (MHz)</b>	1880.000000
<b>Relative permittivity (real part)</b>	38.937099
<b>Relative permittivity (imaginary part)</b>	13.309800
<b>Conductivity (S/m)</b>	1.389765
<b>Variation (%)</b>	1.440000

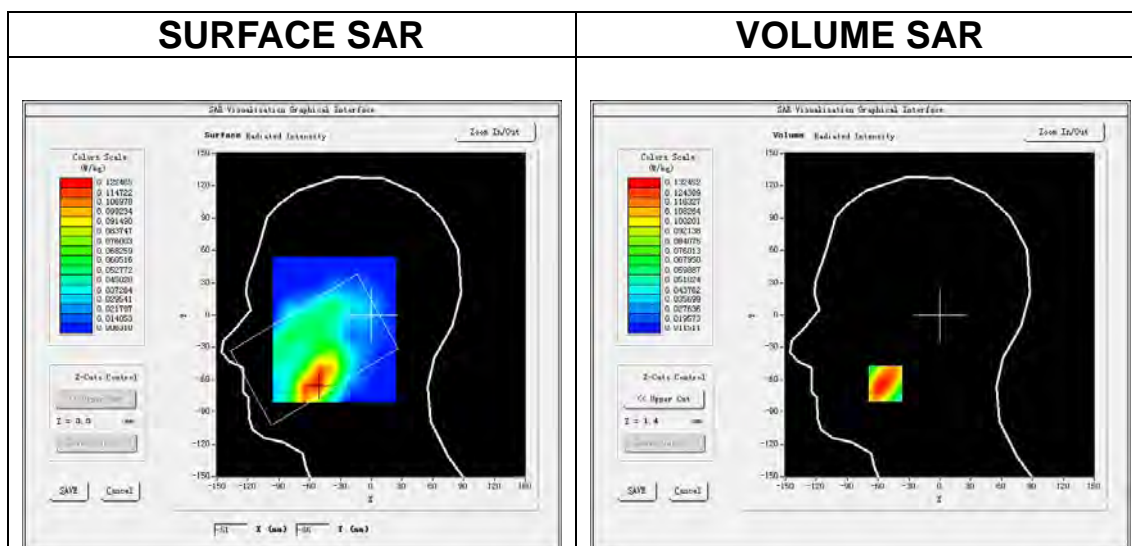

**Maximum location: X=-53.00, Y=-64.00**  
**SAR Peak: 0.20 W/kg**

<b>SAR 10g (W/Kg)</b>	0.079954
<b>SAR 1g (W/Kg)</b>	0.129498



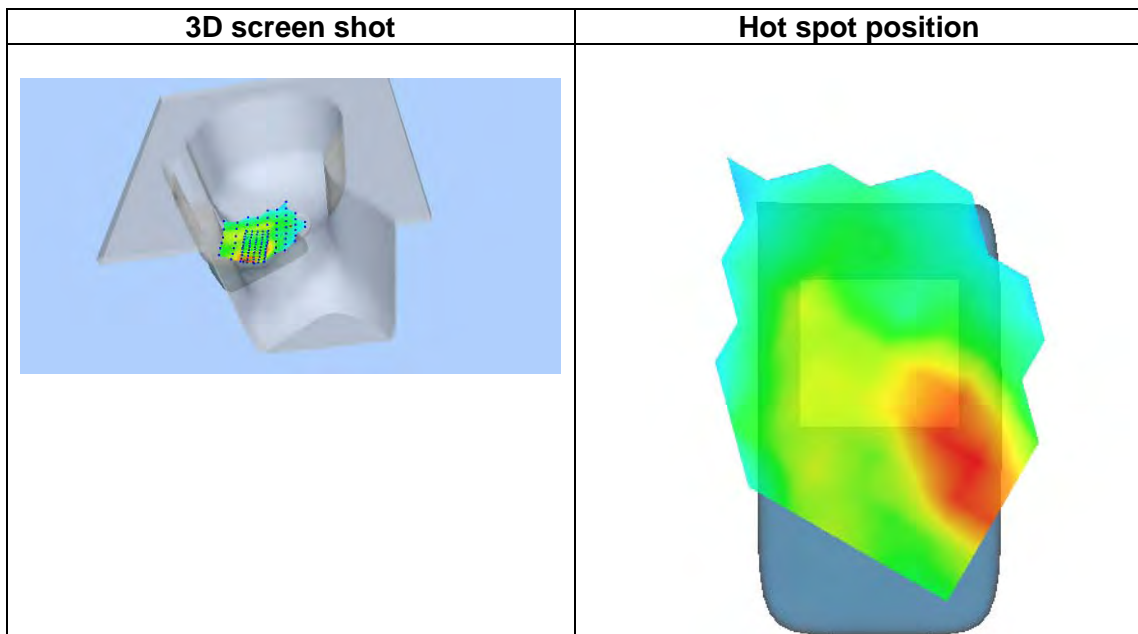
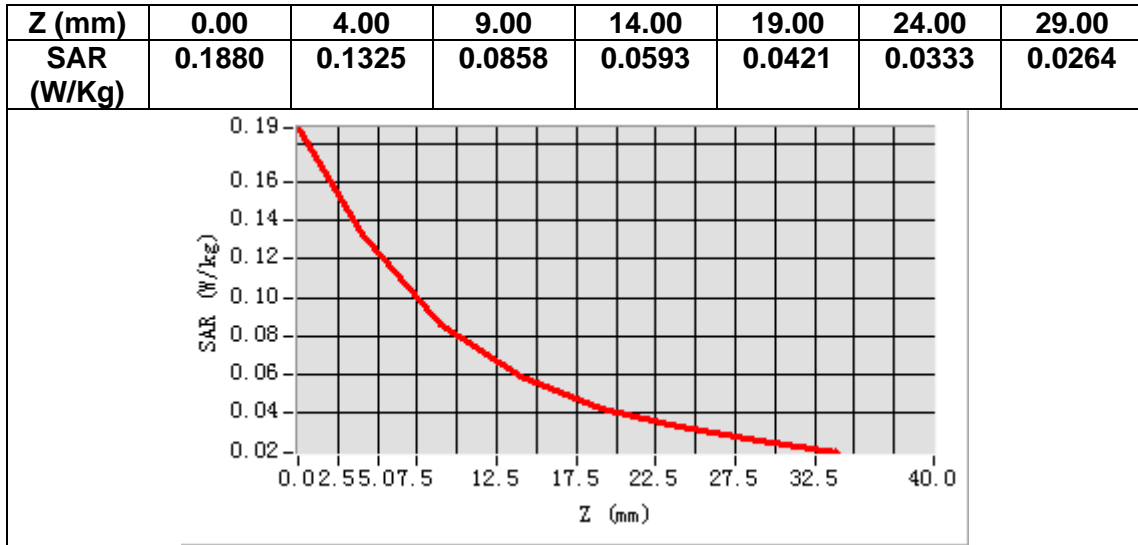

# MEASUREMENT 14

## A. Experimental conditions.

<b>Area Scan</b>	<u>dx=15mm dy=15mm, h= 5.00 mm</u>
<b>ZoomScan</b>	<u>5x5x7, dx=8mm dy=8mm dz=5mm</u>
<b>Phantom</b>	<u>Validation plane</u>
<b>Device Position</b>	<u>Body</u>
<b>Band</b>	<u>LTE band 2</u>
<b>Channels</b>	<u>Middle</u>
<b>Signal</b>	<u>LTE (Crest factor: 1.0)</u>

## B. SAR Measurement Results

<b>Frequency (MHz)</b>	1880.000000
<b>Relative permittivity (real part)</b>	53.388950
<b>Relative permittivity (imaginary part)</b>	14.662150
<b>Conductivity (S/m)</b>	1.530973
<b>Variation (%)</b>	-0.460000

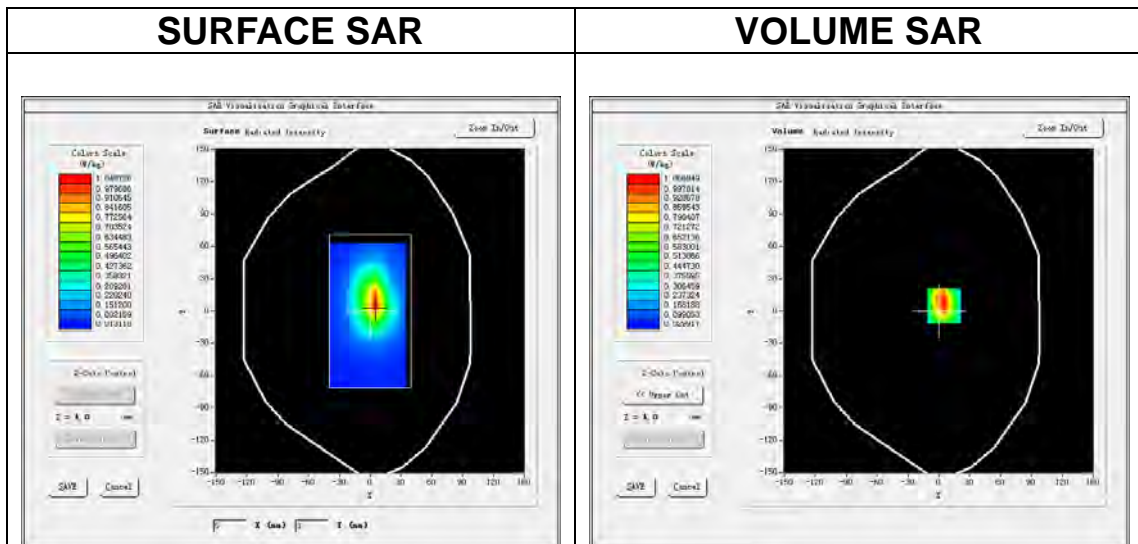

**Maximum location: X=5.00, Y=5.00**

**SAR Peak: 1.58 W/kg**

<b>SAR 10g (W/Kg)</b>	0.544210
<b>SAR 1g (W/Kg)</b>	1.002667

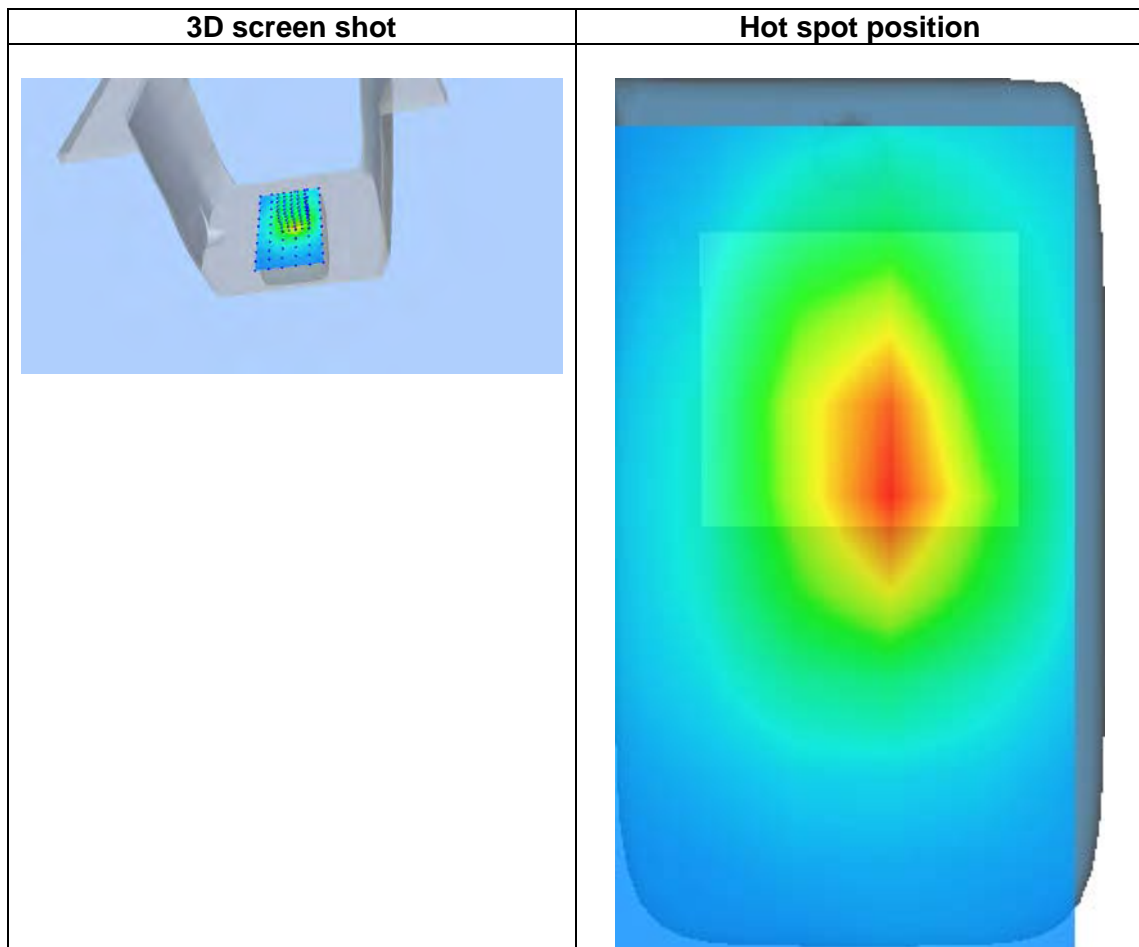
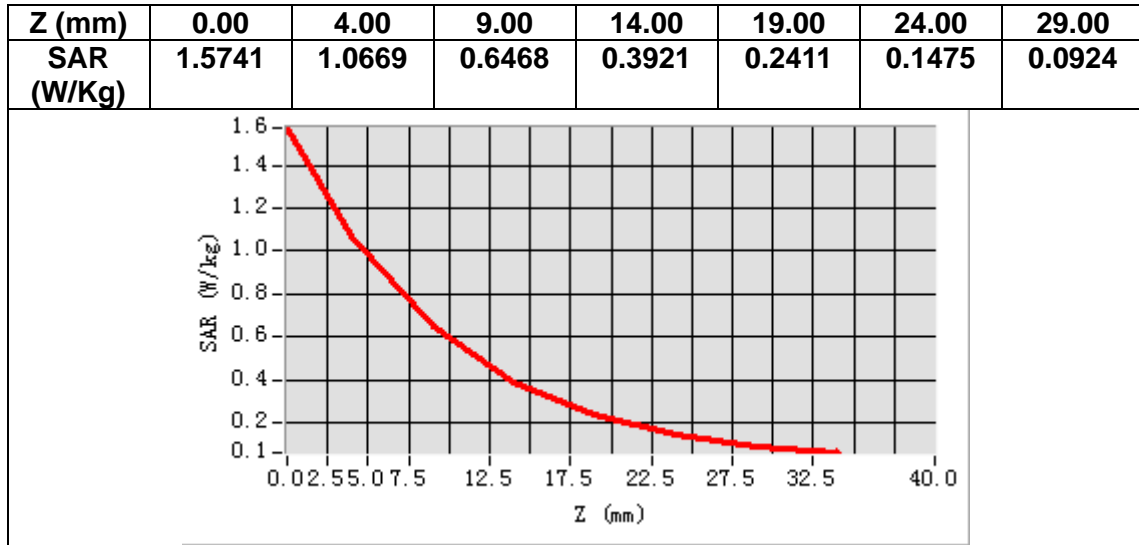

# MEASUREMENT 15

## A. Experimental conditions.

<b>Area Scan</b>	<u>dx=15mm dy=15mm, h= 5.00 mm</u>
<b>ZoomScan</b>	<u>5x5x7,dx=8mm dy=8mm dz=5mm</u>
<b>Phantom</b>	<u>Left head</u>
<b>Device Position</b>	<u>Cheek</u>
<b>Band</b>	<u>LTE band 4</u>
<b>Channels</b>	<u>Middle</u>
<b>Signal</b>	<u>LTE (Crest factor: 1.0)</u>

## B. SAR Measurement Results

<b>Frequency (MHz)</b>	1732.500000
<b>Relative permittivity (real part)</b>	40.433689
<b>Relative permittivity (imaginary part)</b>	14.180192
<b>Conductivity (S/m)</b>	1.364843
<b>Variation (%)</b>	3.080000

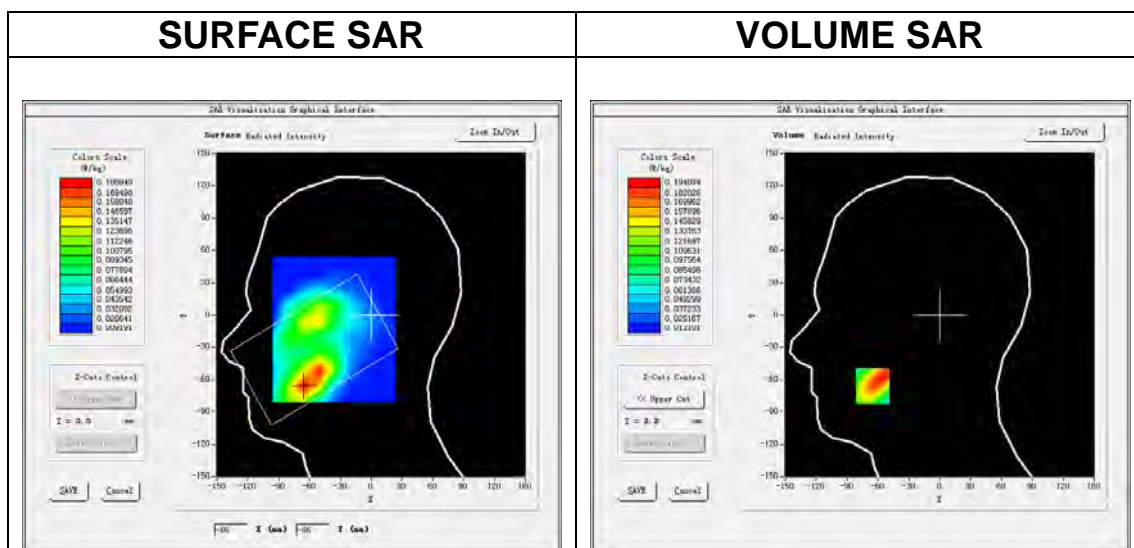

**Maximum location: X=-65.00, Y=-66.00**

**SAR Peak: 0.27 W/kg**

<b>SAR 10g (W/Kg)</b>	0.118895
<b>SAR 1g (W/Kg)</b>	0.184802

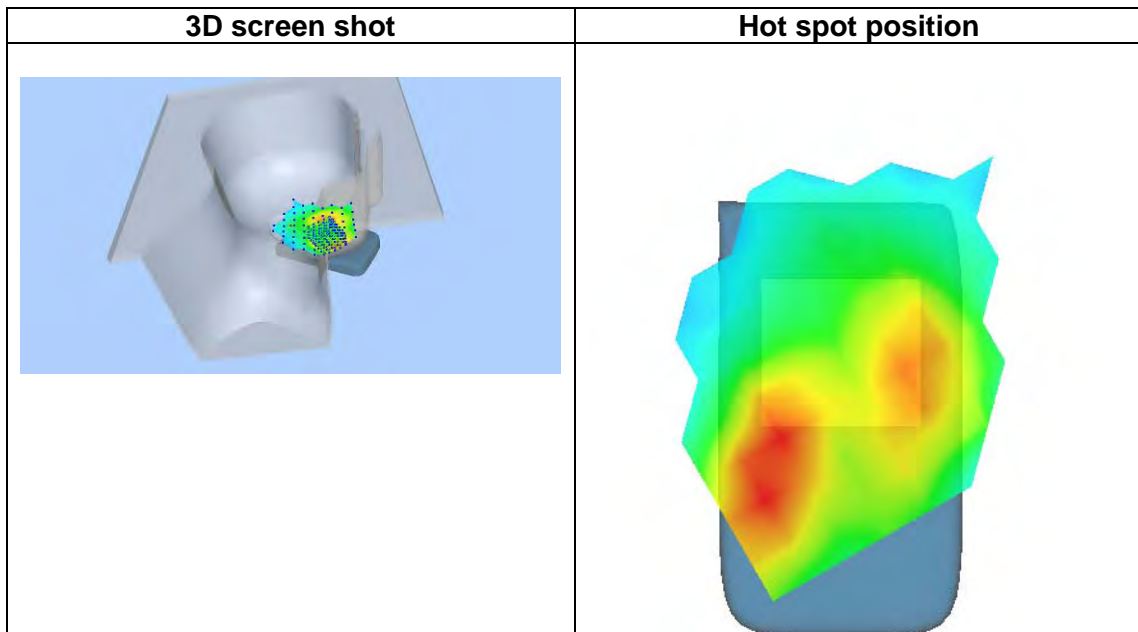
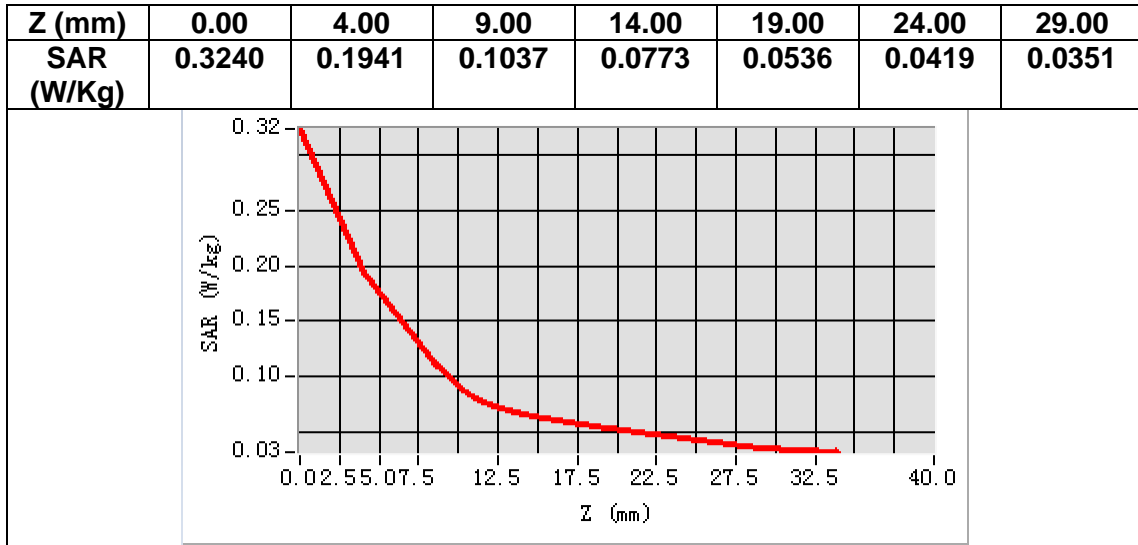

# MEASUREMENT 16

## A. Experimental conditions.

<u>Area Scan</u>	<u>dx=15mm dy=15mm, h= 5.00 mm</u>
<u>ZoomScan</u>	<u>5x5x7, dx=8mm dy=8mm dz=5mm</u>
<u>Phantom</u>	<u>Validation plane</u>
<u>Device Position</u>	<u>Body</u>
<u>Band</u>	<u>LTE band 4</u>
<u>Channels</u>	<u>Low</u>
<u>Signal</u>	<u>LTE (Crest factor: 1.0)</u>

## B. SAR Measurement Results

Frequency (MHz)	1720.000000
Relative permittivity (real part)	54.552067
Relative permittivity (imaginary part)	15.159520
Conductivity (S/m)	1.443944
Variation (%)	0.980000

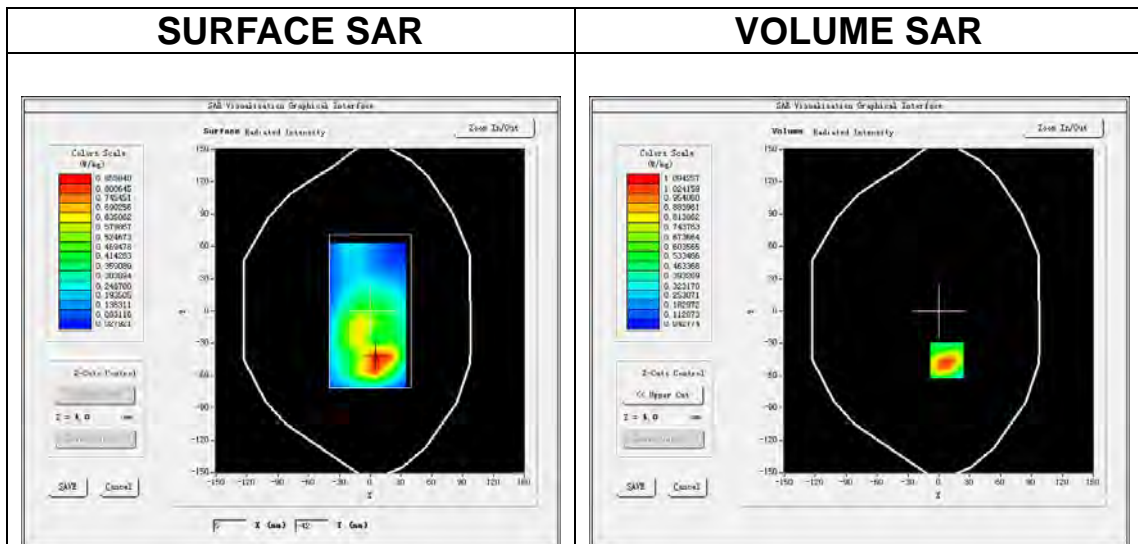

**Maximum location: X=8.00, Y=-46.00**

**SAR Peak: 1.65 W/kg**

<b>SAR 10g (W/Kg)</b>	0.568999
<b>SAR 1g (W/Kg)</b>	1.036797

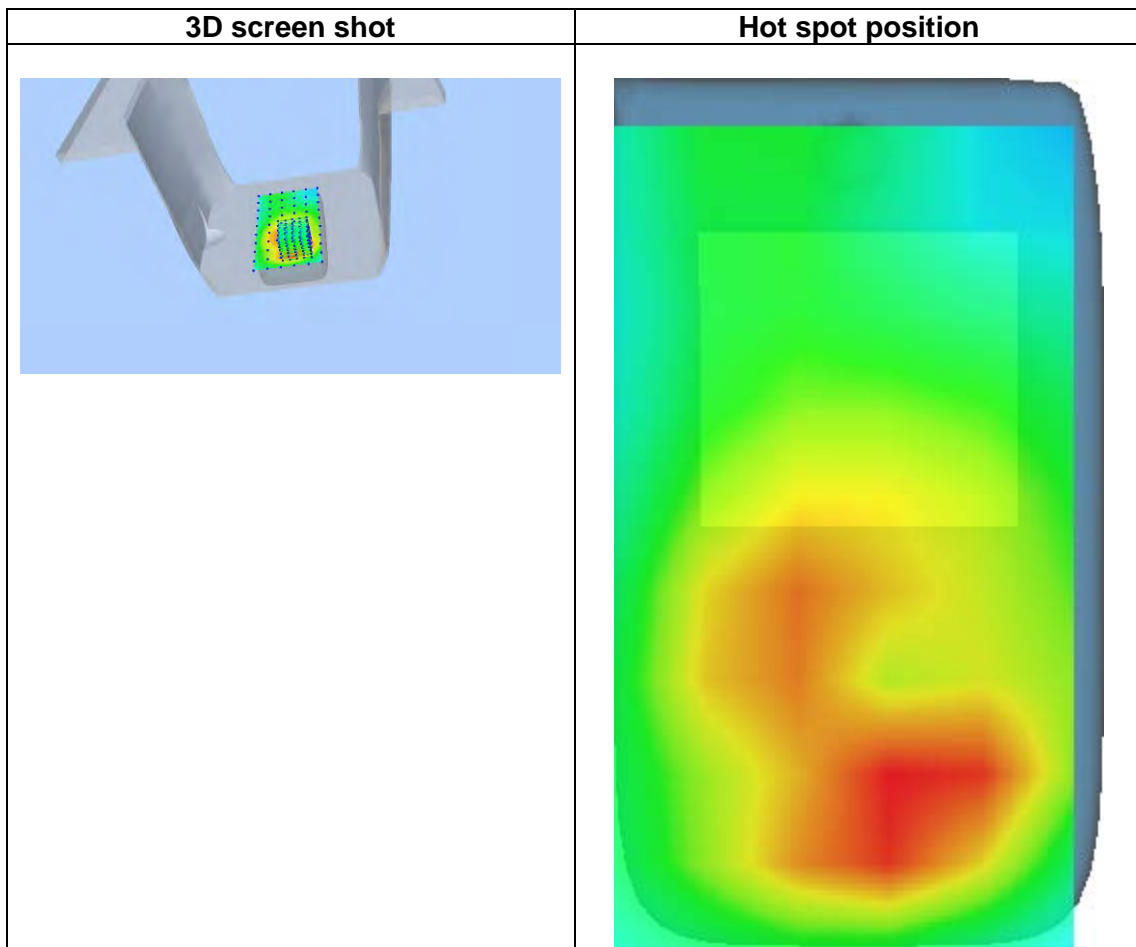
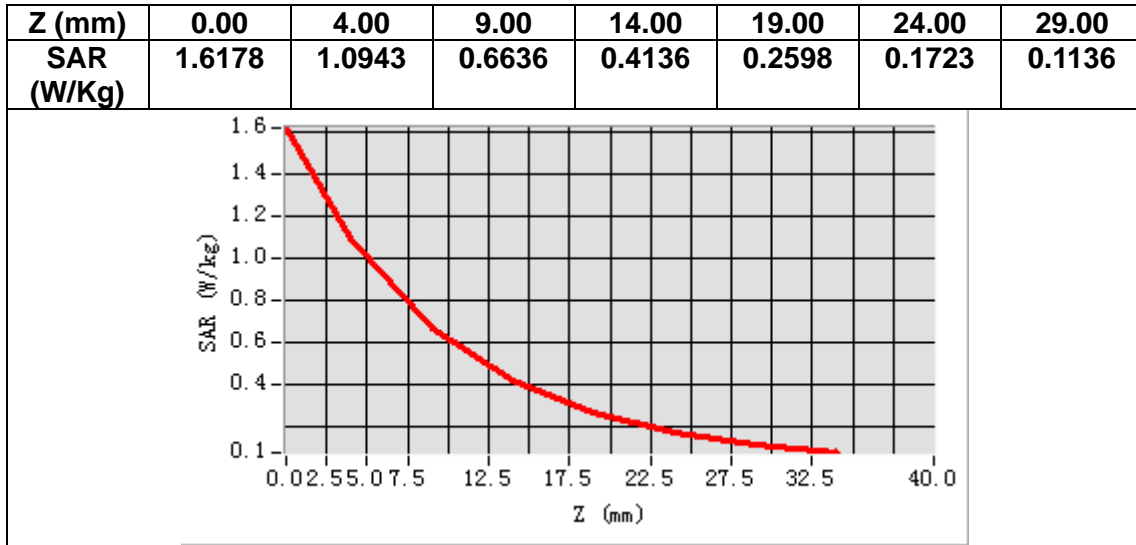



# MEASUREMENT 17

## A. Experimental conditions.

<b>Area Scan</b>	<u>dx=15mm dy=15mm, h= 5.00 mm</u>
<b>ZoomScan</b>	<u>5x5x7,dx=8mm dy=8mm dz=5mm</u>
<b>Phantom</b>	<u>Left head</u>
<b>Device Position</b>	<u>Cheek</u>
<b>Band</b>	<u>LTE band 5</u>
<b>Channels</b>	<u>Middle</u>
<b>Signal</b>	<u>LTE (Crest factor: 1.0)</u>

## B. SAR Measurement Results

<b>Frequency (MHz)</b>	836.500000
<b>Relative permittivity (real part)</b>	41.791550
<b>Relative permittivity (imaginary part)</b>	19.509899
<b>Conductivity (S/m)</b>	0.906668
<b>Variation (%)</b>	0.680000

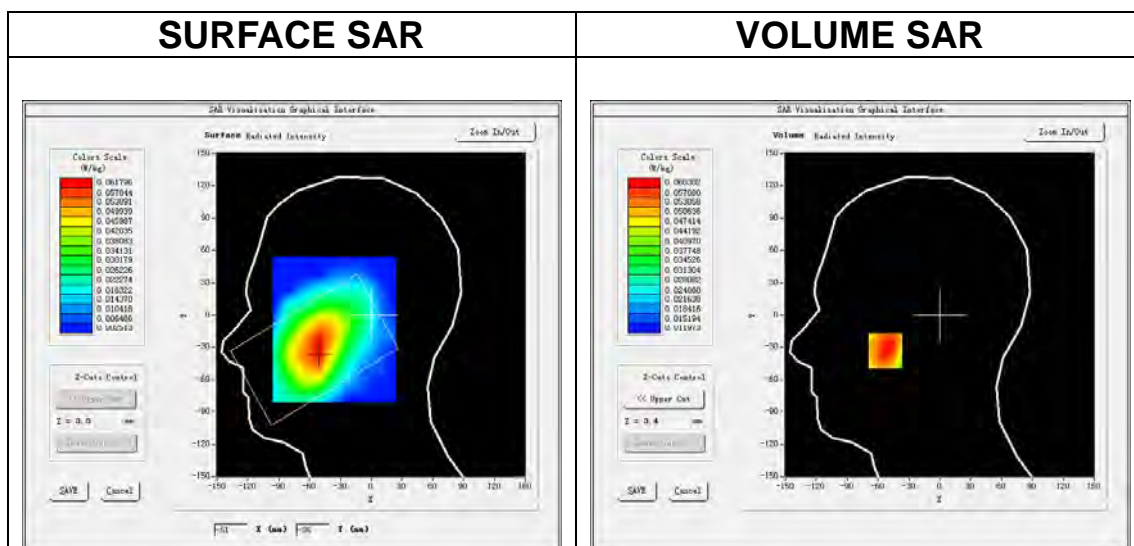

**Maximum location: X=-53.00, Y=-33.00**

**SAR Peak: 0.07 W/kg**

<b>SAR 10g (W/Kg)</b>	0.046674
<b>SAR 1g (W/Kg)</b>	0.059024

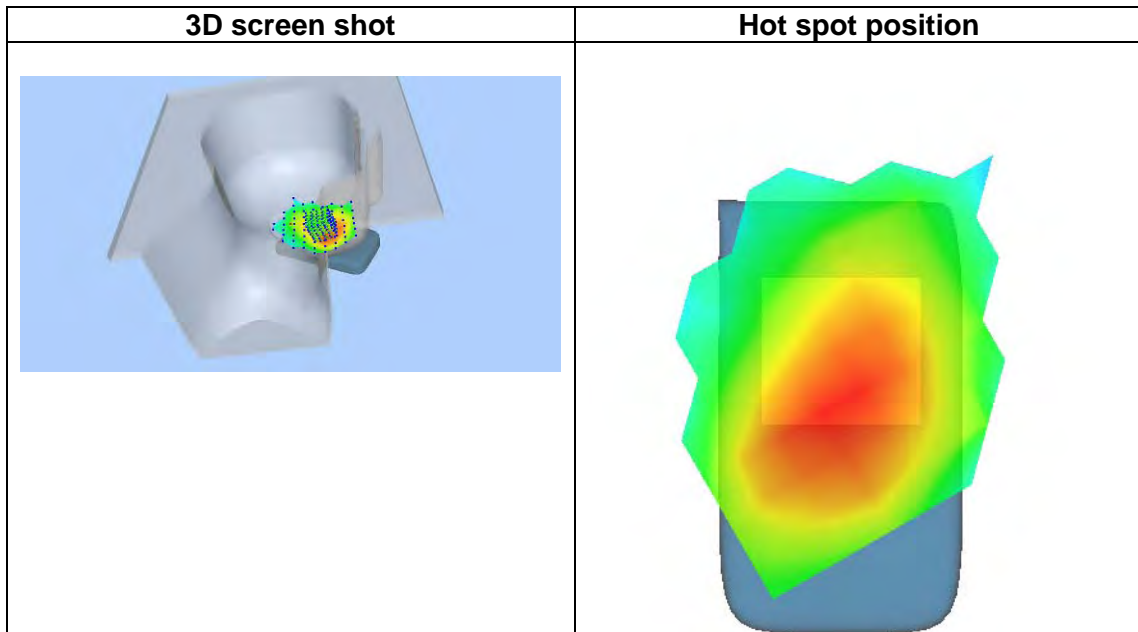
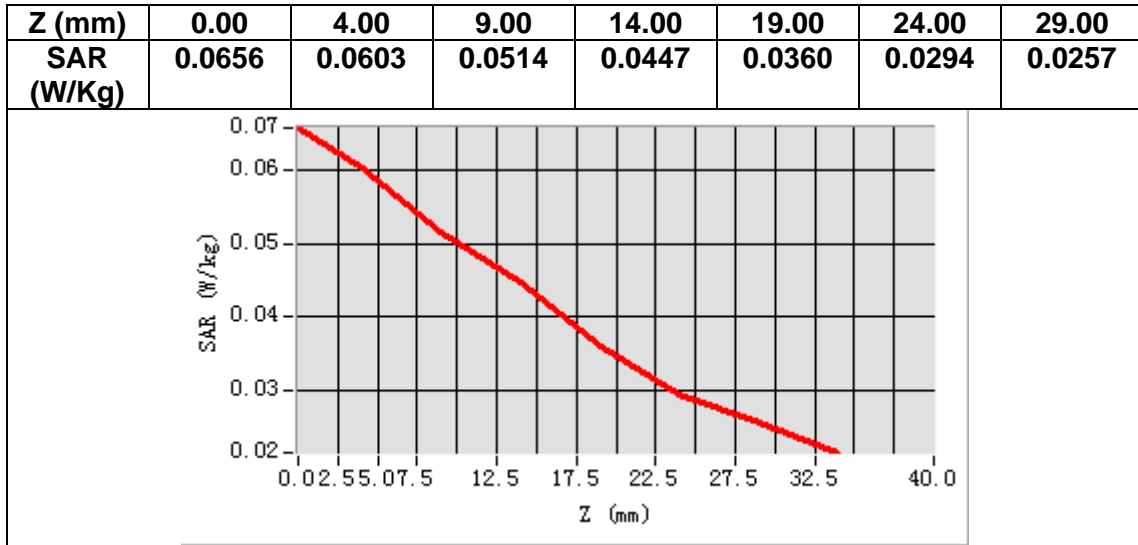

# MEASUREMENT 18

## A. Experimental conditions.

<b>Area Scan</b>	<u>dx=15mm dy=15mm, h= 5.00 mm</u>
<b>ZoomScan</b>	<u>5x5x7, dx=8mm dy=8mm dz=5mm</u>
<b>Phantom</b>	<u>Validation plane</u>
<b>Device Position</b>	<u>Body</u>
<b>Band</b>	<u>LTE band 5</u>
<b>Channels</b>	<u>Middle</u>
<b>Signal</b>	<u>LTE (Crest factor: 1.0)</u>

## B. SAR Measurement Results

<b>Frequency (MHz)</b>	836.500000
<b>Relative permittivity (real part)</b>	54.928501
<b>Relative permittivity (imaginary part)</b>	20.931000
<b>Conductivity (S/m)</b>	0.972710
<b>Variation (%)</b>	0.100000

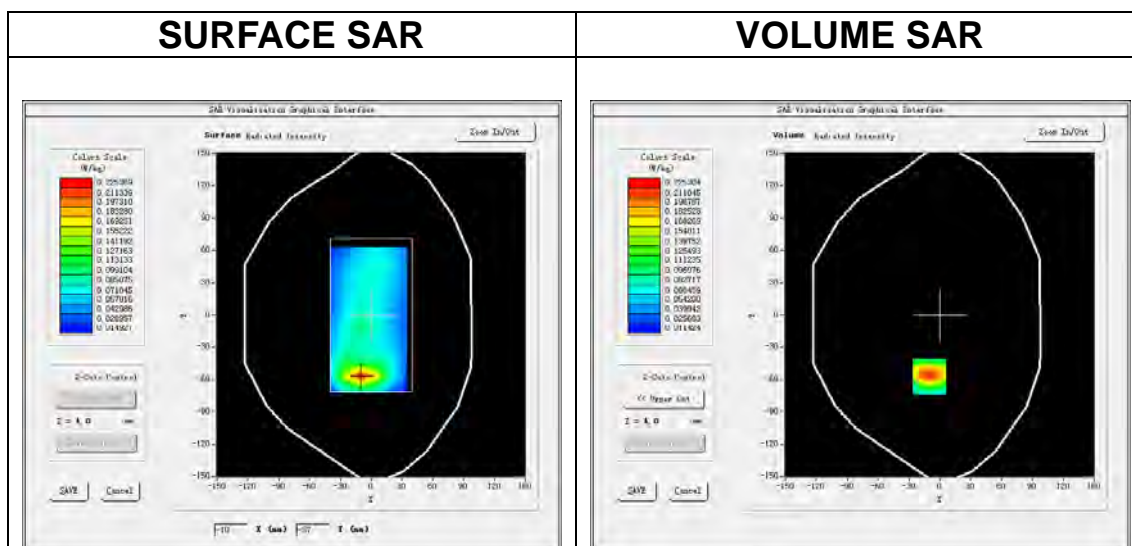

**Maximum location: X=-10.00, Y=-57.00**

**SAR Peak: 0.33 W/kg**

<b>SAR 10g (W/Kg)</b>	0.118762
<b>SAR 1g (W/Kg)</b>	0.210798

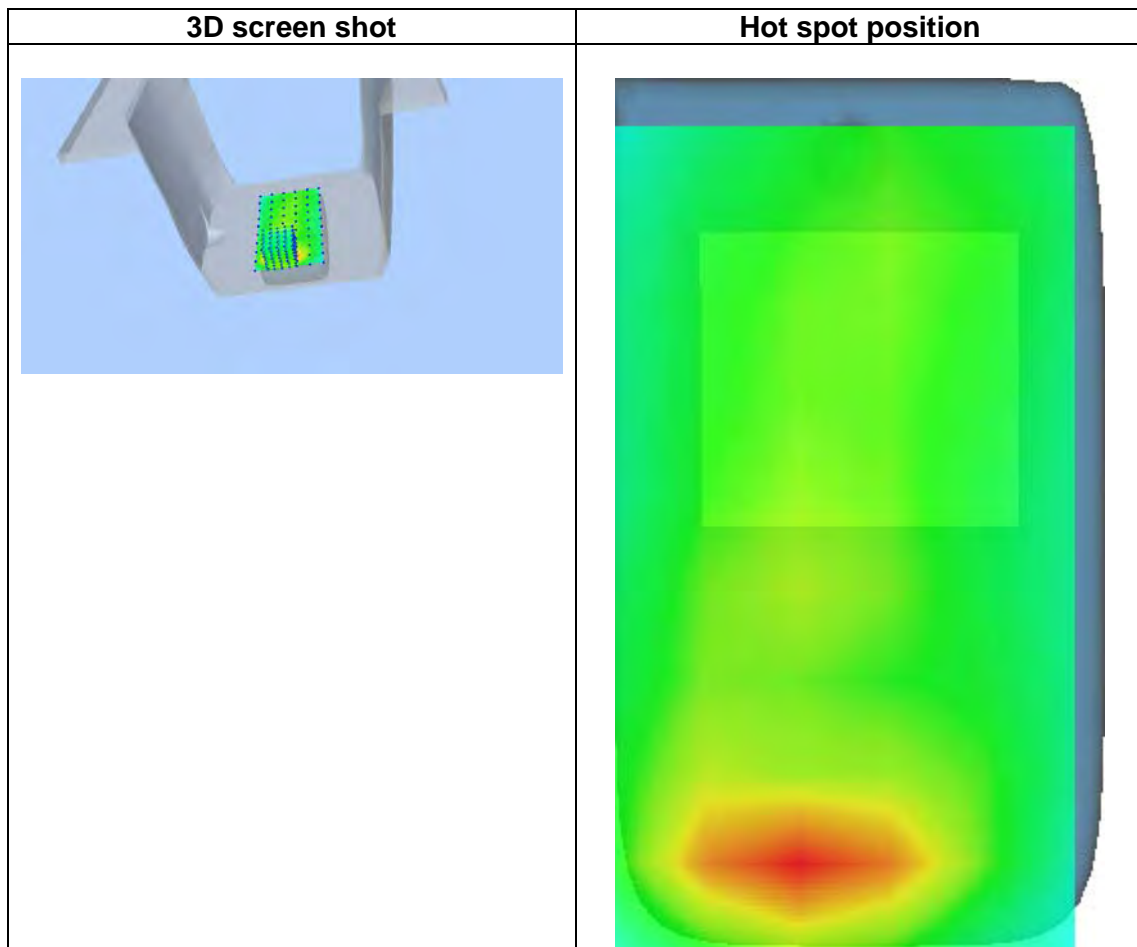
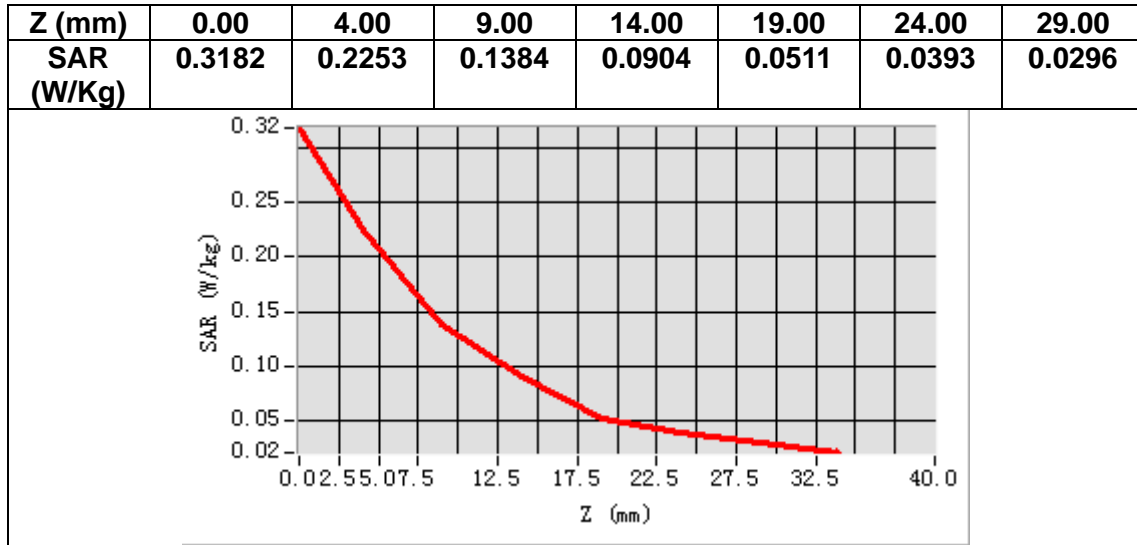

# MEASUREMENT 19

## A. Experimental conditions.

<b>Area Scan</b>	<u>dx=12mm dy=12mm, h= 5.00 mm</u>
<b>ZoomScan</b>	<u>7x7x7,dx=5mm dy=5mm dz=5mm</u>
<b>Phantom</b>	<u>Left head</u>
<b>Device Position</b>	<u>Cheek</u>
<b>Band</b>	<u>LTE band 7</u>
<b>Channels</b>	<u>Middle</u>
<b>Signal</b>	<u>LTE (Crest factor: 1.0)</u>

## B. SAR Measurement Results

<b>Frequency (MHz)</b>	2535.000000
<b>Relative permittivity (real part)</b>	39.197487
<b>Relative permittivity (imaginary part)</b>	13.607160
<b>Conductivity (S/m)</b>	1.916342
<b>Variation (%)</b>	-1.520000

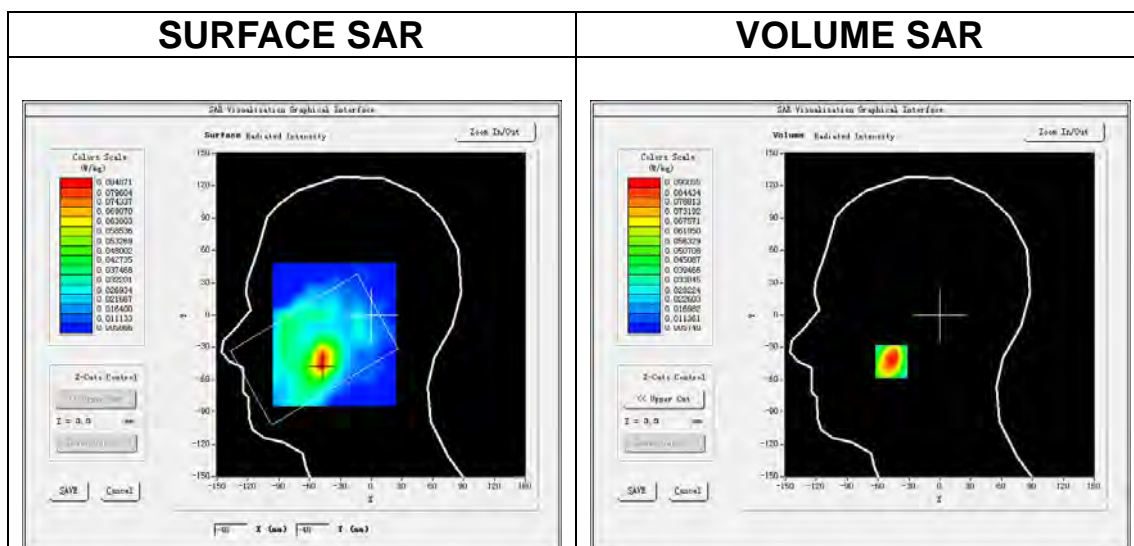

**Maximum location: X=-47.00, Y=-43.00**

**SAR Peak: 0.13 W/kg**

<b>SAR 10g (W/Kg)</b>	0.049193
<b>SAR 1g (W/Kg)</b>	0.084106

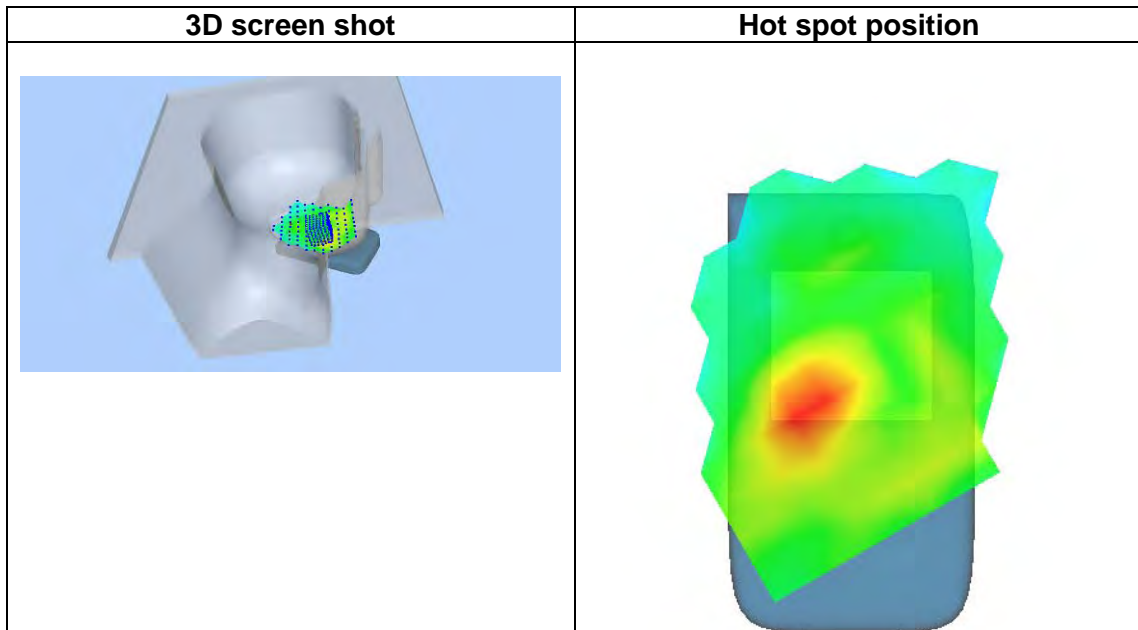
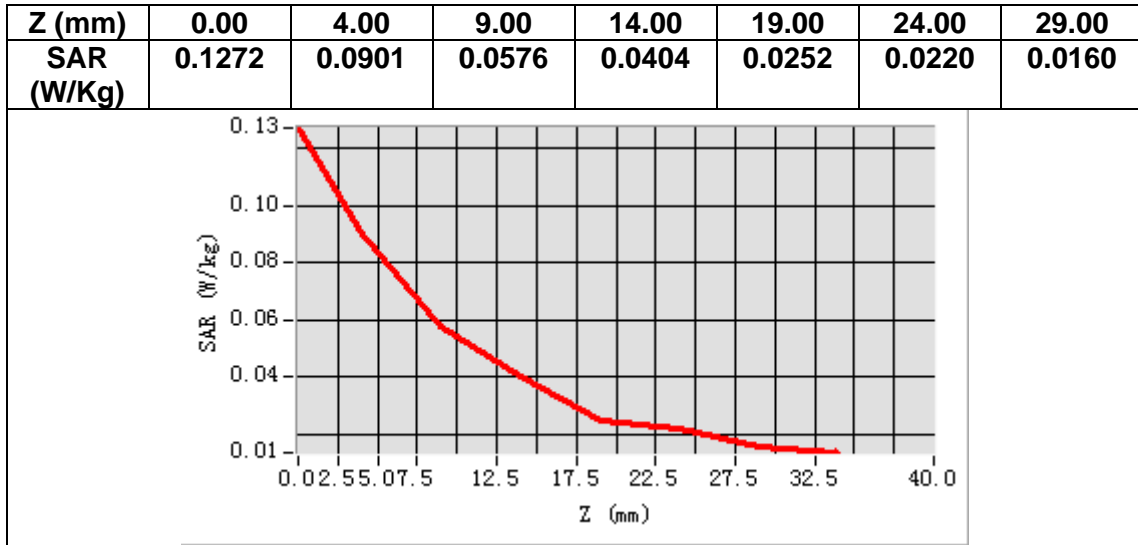

# MEASUREMENT 20

## A. Experimental conditions.

<b>Area Scan</b>	<u>dx=12mm dy=12mm, h= 5.00 mm</u>
<b>ZoomScan</b>	<u>7x7x7, dx=5mm dy=5mm dz=5mm</u>
<b>Phantom</b>	<u>Validation plane</u>
<b>Device Position</b>	<u>Body</u>
<b>Band</b>	<u>LTE band 7</u>
<b>Channels</b>	<u>Middle</u>
<b>Signal</b>	<u>LTE (Crest factor: 1.0)</u>

## B. SAR Measurement Results

<b>Frequency (MHz)</b>	2535.000000
<b>Relative permittivity (real part)</b>	53.826946
<b>Relative permittivity (imaginary part)</b>	14.922840
<b>Conductivity (S/m)</b>	2.101633
<b>Variation (%)</b>	-0.530000

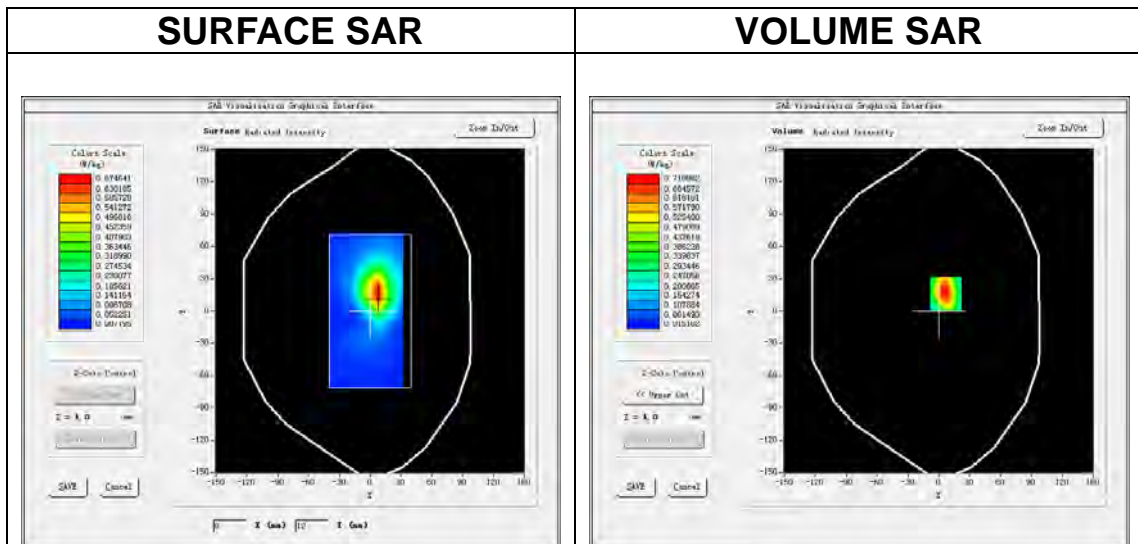

**Maximum location: X=7.00, Y=16.00**

**SAR Peak: 1.13 W/kg**

<b>SAR 10g (W/Kg)</b>	0.336873
<b>SAR 1g (W/Kg)</b>	0.660127



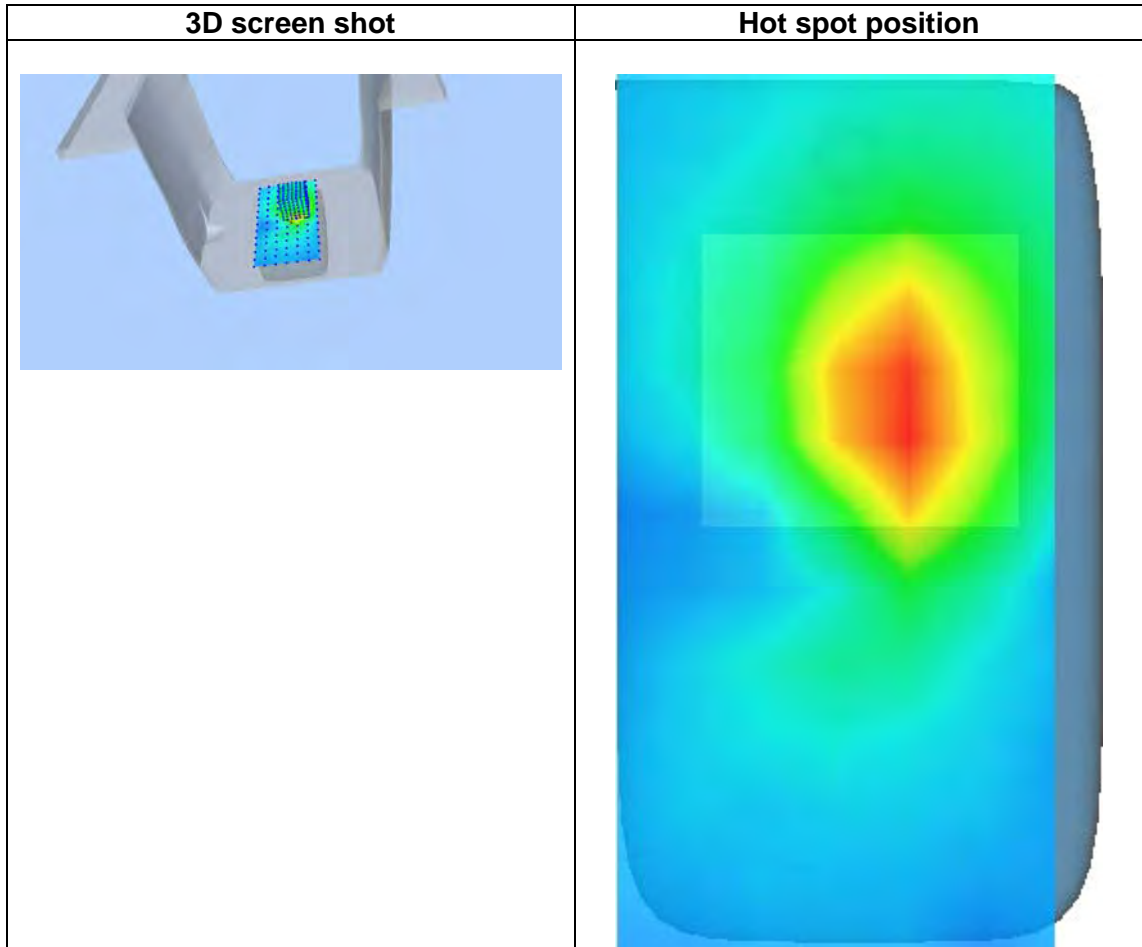
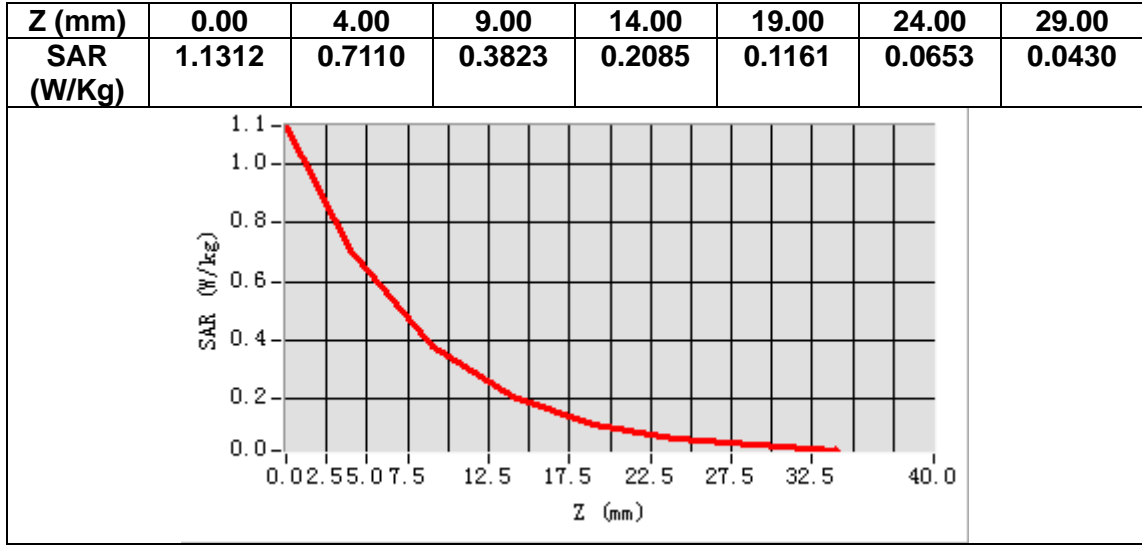

# MEASUREMENT 21

## A. Experimental conditions.

<b>Area Scan</b>	<u>dx=15mm dy=15mm, h= 5.00 mm</u>
<b>ZoomScan</b>	<u>5x5x7, dx=8mm dy=8mm dz=5mm</u>
<b>Phantom</b>	<u>Left head</u>
<b>Device Position</b>	<u>Cheek</u>
<b>Band</b>	<u>LTE band 12</u>
<b>Channels</b>	<u>Middle</u>
<b>Signal</b>	<u>LTE (Crest factor: 1.0)</u>

## B. SAR Measurement Results

<b>Frequency (MHz)</b>	707.500000
<b>Relative permittivity (real part)</b>	41.921959
<b>Relative permittivity (imaginary part)</b>	21.857779
<b>Conductivity (S/m)</b>	0.859132
<b>Variation (%)</b>	0.530001

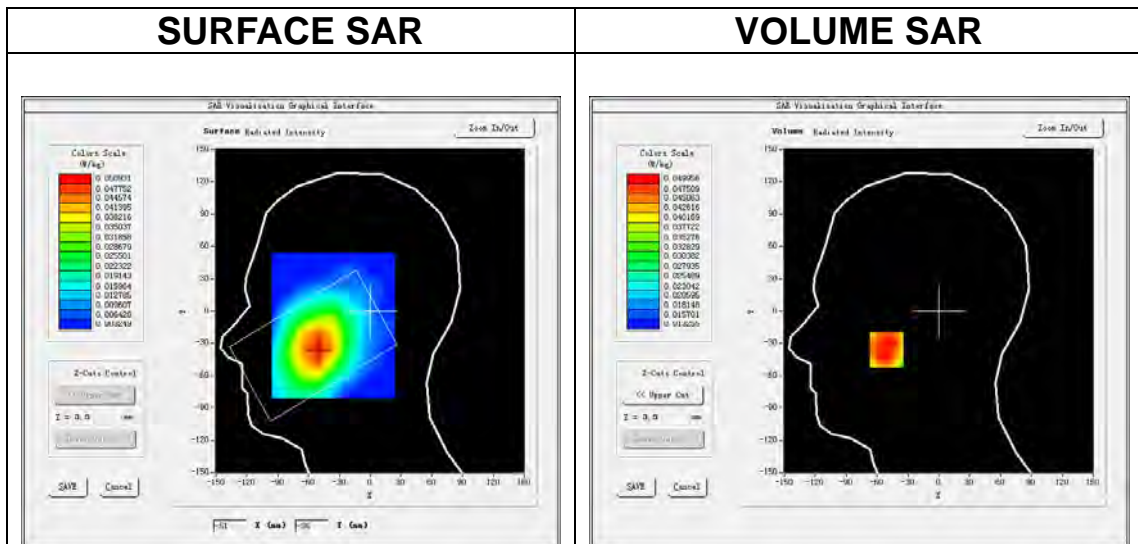

**Maximum location: X=-51.00, Y=-36.00**

**SAR Peak: 0.06 W/kg**

<b>SAR 10g (W/Kg)</b>	0.040486
<b>SAR 1g (W/Kg)</b>	0.048841

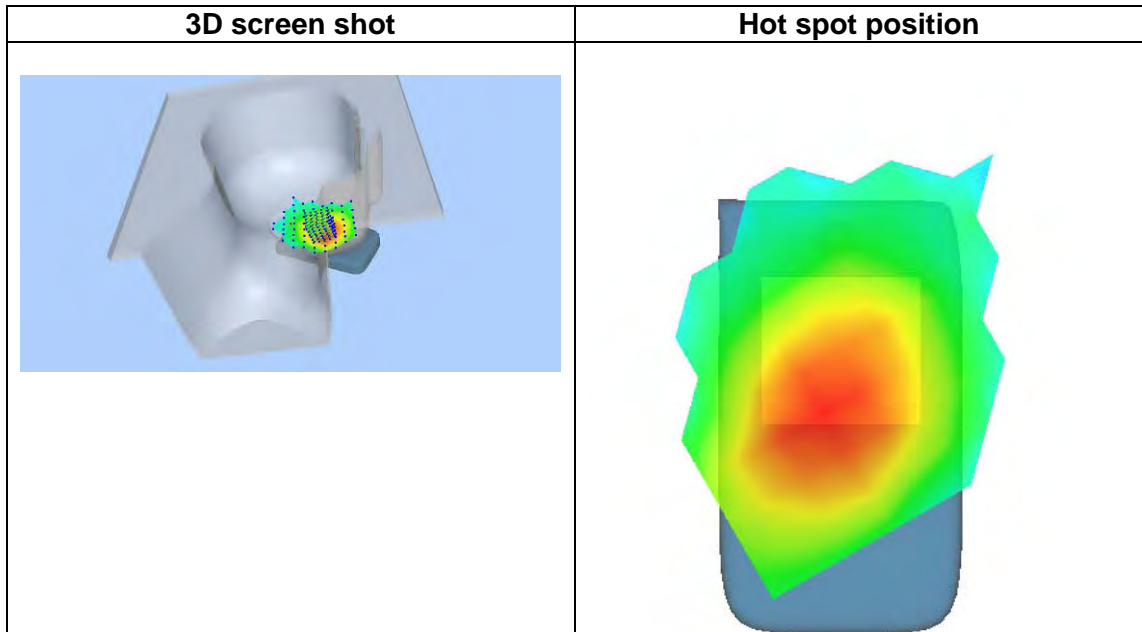
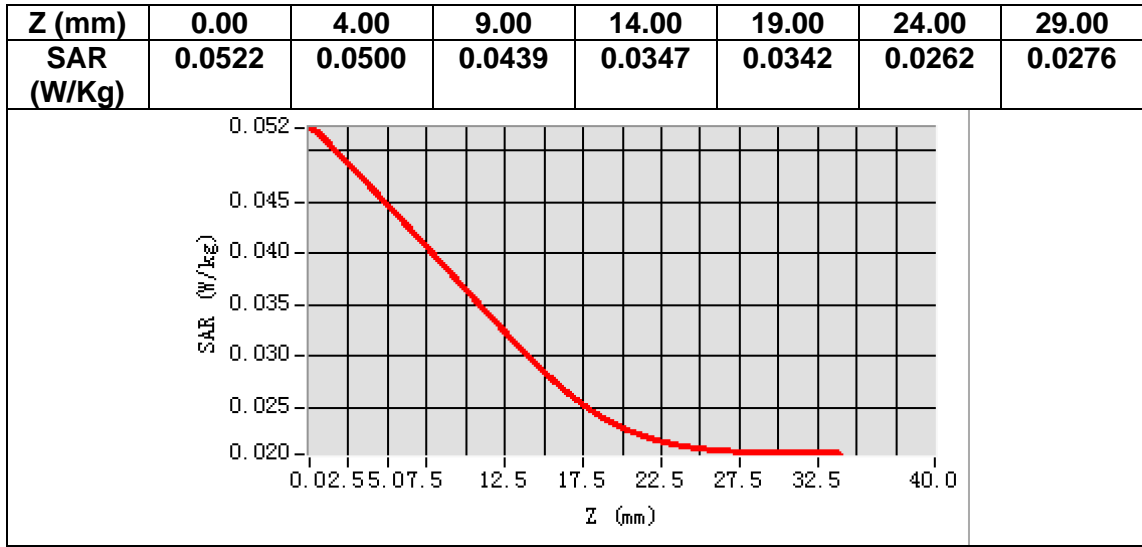

# MEASUREMENT 22

## A. Experimental conditions.

<b>Area Scan</b>	<u>dx=15mm dy=15mm, h= 5.00 mm</u>
<b>ZoomScan</b>	<u>5x5x7, dx=8mm dy=8mm dz=5mm</u>
<b>Phantom</b>	<u>Validation plane</u>
<b>Device Position</b>	<u>Body</u>
<b>Band</b>	<u>LTE band 12</u>
<b>Channels</b>	<u>Middle</u>
<b>Signal</b>	<u>LTE (Crest factor: 1.0)</u>

## B. SAR Measurement Results

<b>Frequency (MHz)</b>	707.500000
<b>Relative permittivity (real part)</b>	55.576660
<b>Relative permittivity (imaginary part)</b>	23.598850
<b>Conductivity (S/m)</b>	0.927566
<b>Variation (%)</b>	3.040000

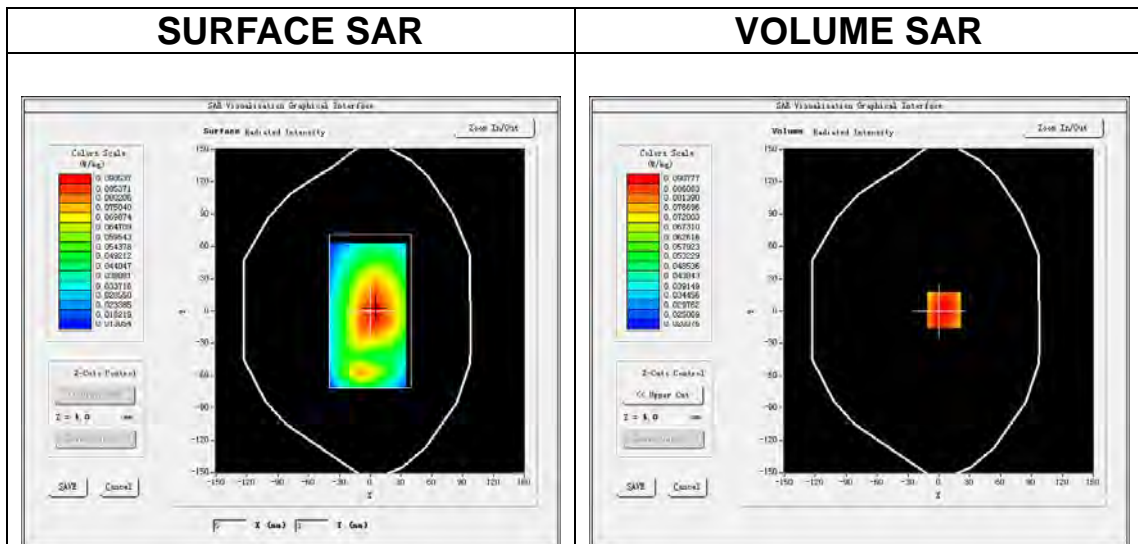

**Maximum location: X=5.00, Y=1.00**

**SAR Peak: 0.11 W/kg**

<b>SAR 10g (W/Kg)</b>	0.070845
<b>SAR 1g (W/Kg)</b>	0.089731

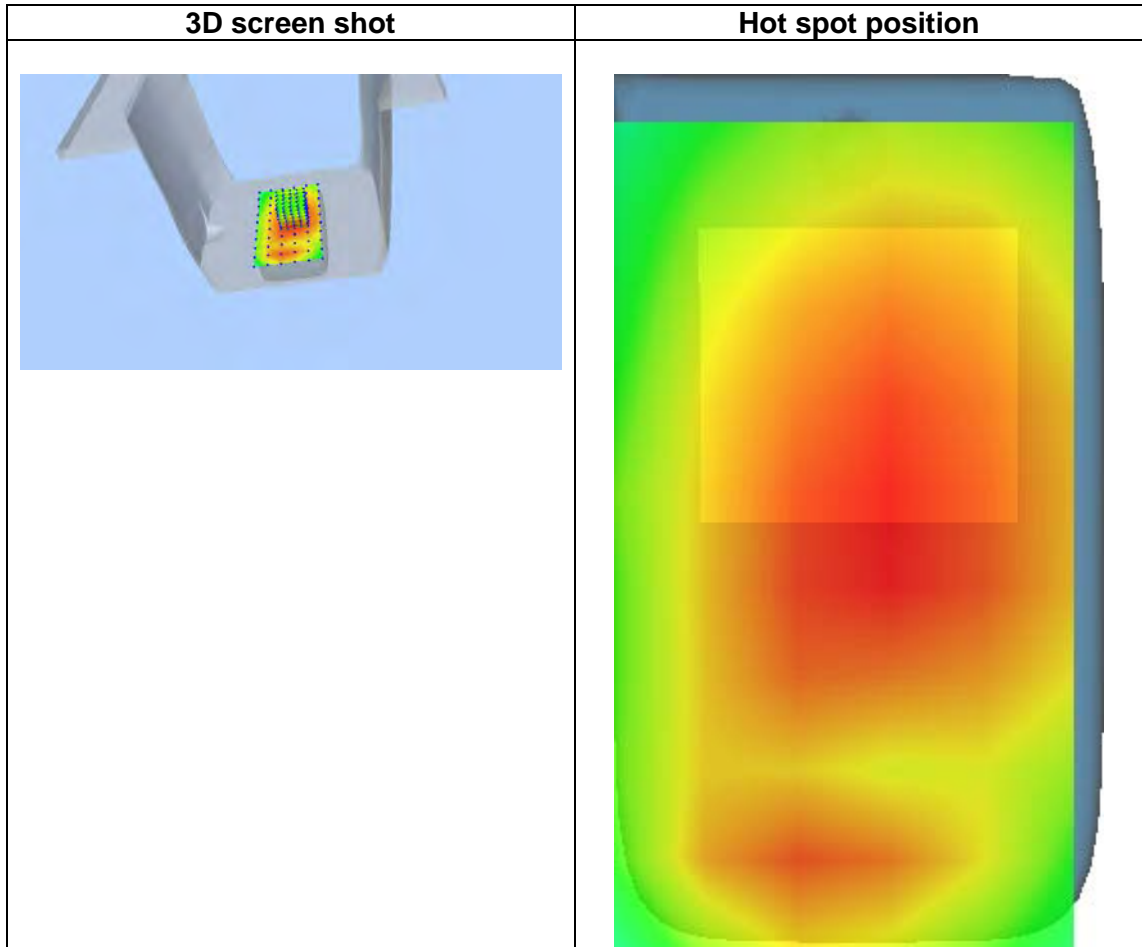
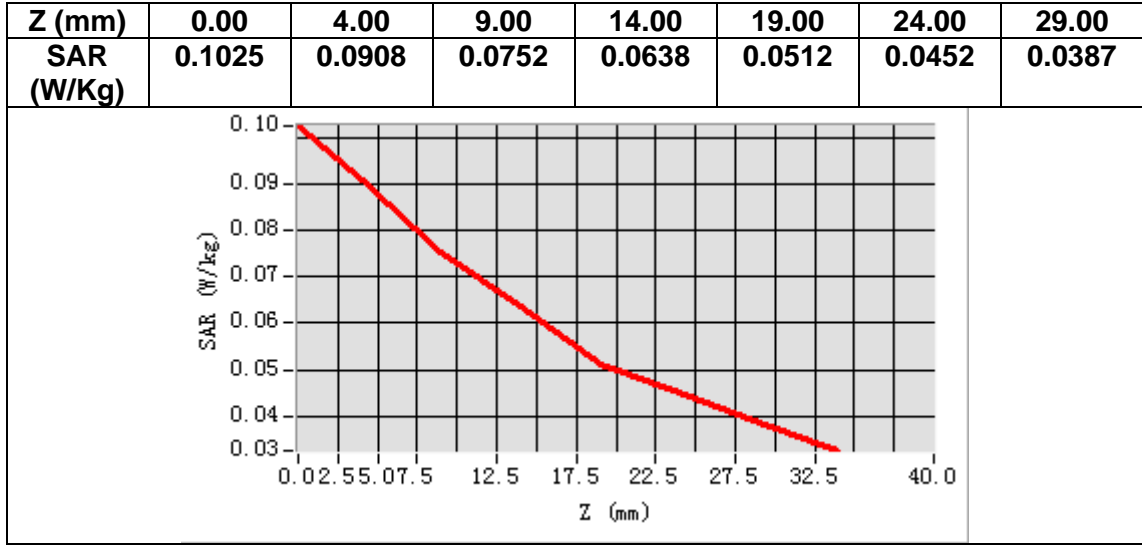

# MEASUREMENT 23

## A. Experimental conditions.

<b>Area Scan</b>	<u>dx=15mm dy=15mm, h= 5.00 mm</u>
<b>ZoomScan</b>	<u>5x5x7, dx=8mm dy=8mm dz=5mm</u>
<b>Phantom</b>	<u>Right head</u>
<b>Device Position</b>	<u>Cheek</u>
<b>Band</b>	<u>LTE band 17</u>
<b>Channels</b>	<u>Middle</u>
<b>Signal</b>	<u>LTE (Crest factor: 1.0)</u>

## B. SAR Measurement Results

<b>Frequency (MHz)</b>	710.000000
<b>Relative permittivity (real part)</b>	41.900711
<b>Relative permittivity (imaginary part)</b>	21.886179
<b>Conductivity (S/m)</b>	0.863288
<b>Variation (%)</b>	3.970000

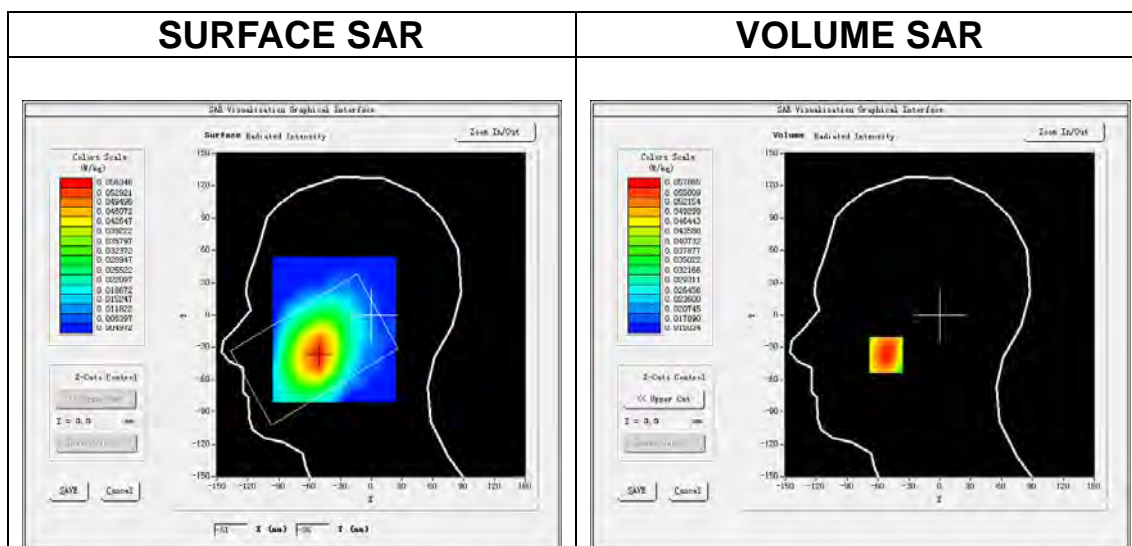

**Maximum location: X=-52.00, Y=-37.00**

**SAR Peak: 0.07 W/kg**

<b>SAR 10g (W/Kg)</b>	0.045678
<b>SAR 1g (W/Kg)</b>	0.057408

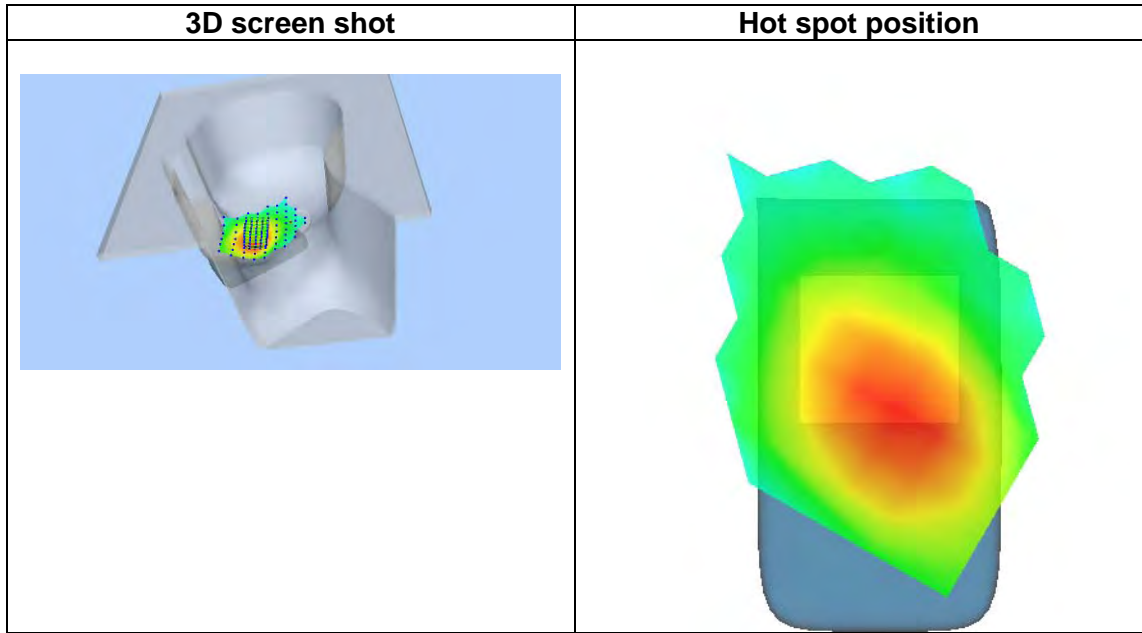
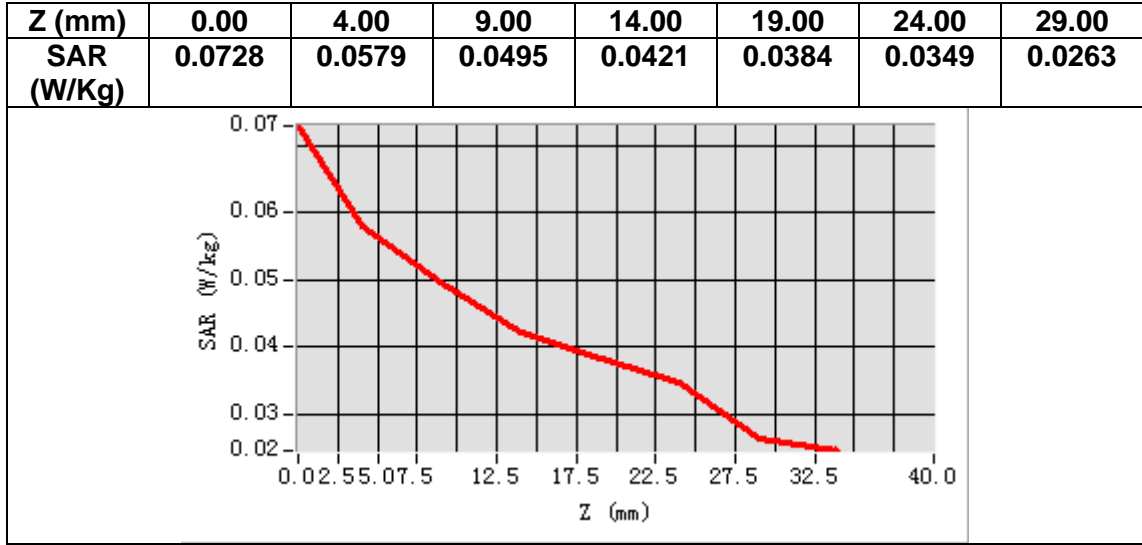



# MEASUREMENT 24

## A. Experimental conditions.

<b>Area Scan</b>	<u>dx=15mm dy=15mm, h= 5.00 mm</u>
<b>ZoomScan</b>	<u>5x5x7, dx=8mm dy=8mm dz=5mm</u>
<b>Phantom</b>	<u>Validation plane</u>
<b>Device Position</b>	<u>Body</u>
<b>Band</b>	<u>LTE band 17</u>
<b>Channels</b>	<u>Middle</u>
<b>Signal</b>	<u>LTE (Crest factor: 1.0)</u>

## B. SAR Measurement Results

<b>Frequency (MHz)</b>	710.000000
<b>Relative permittivity (real part)</b>	41.900711
<b>Relative permittivity (imaginary part)</b>	21.886179
<b>Conductivity (S/m)</b>	0.863288
<b>Variation (%)</b>	1.100000

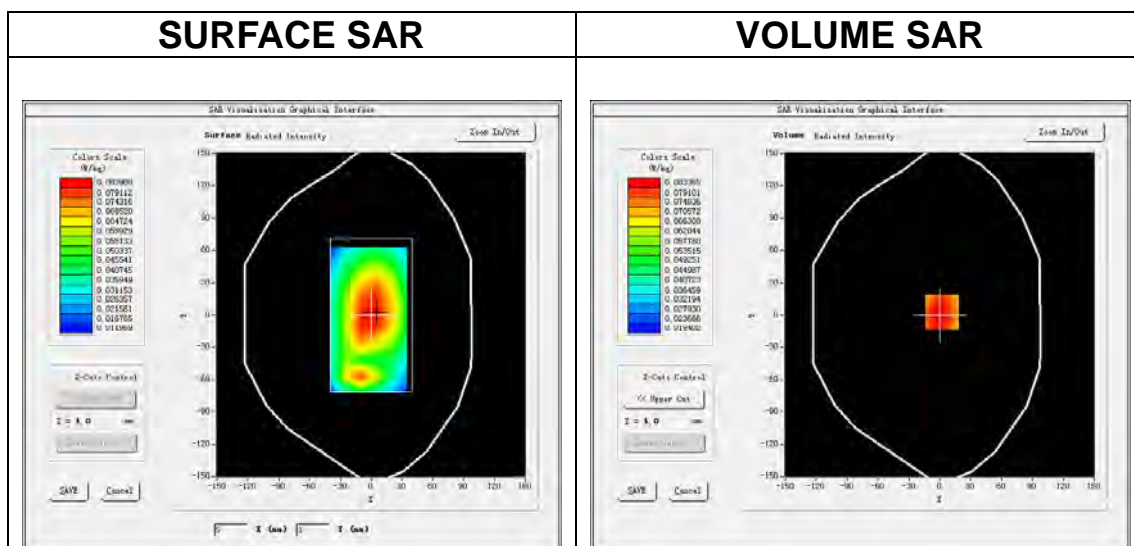

**Maximum location: X=2.00, Y=3.00**

**SAR Peak: 0.11 W/kg**

<b>SAR 10g (W/Kg)</b>	0.066493
<b>SAR 1g (W/Kg)</b>	0.083472

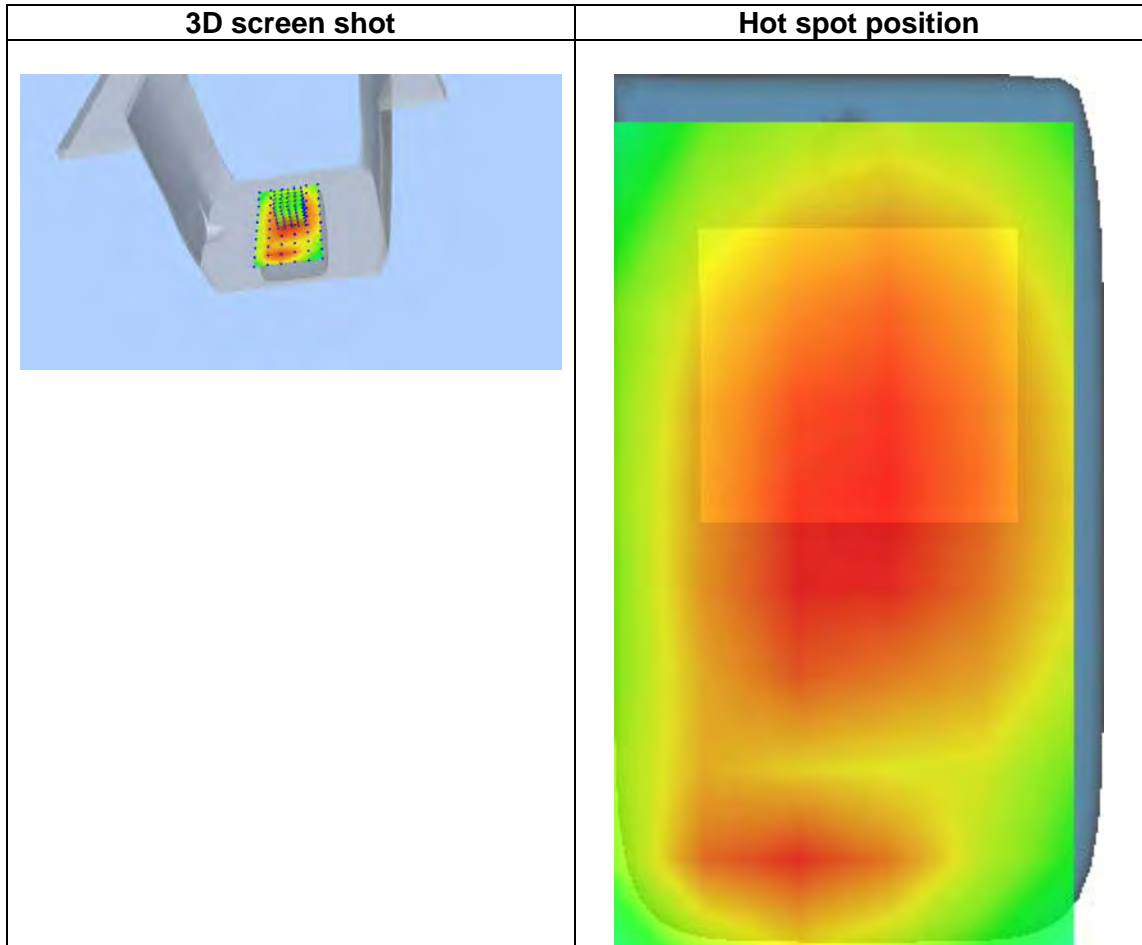
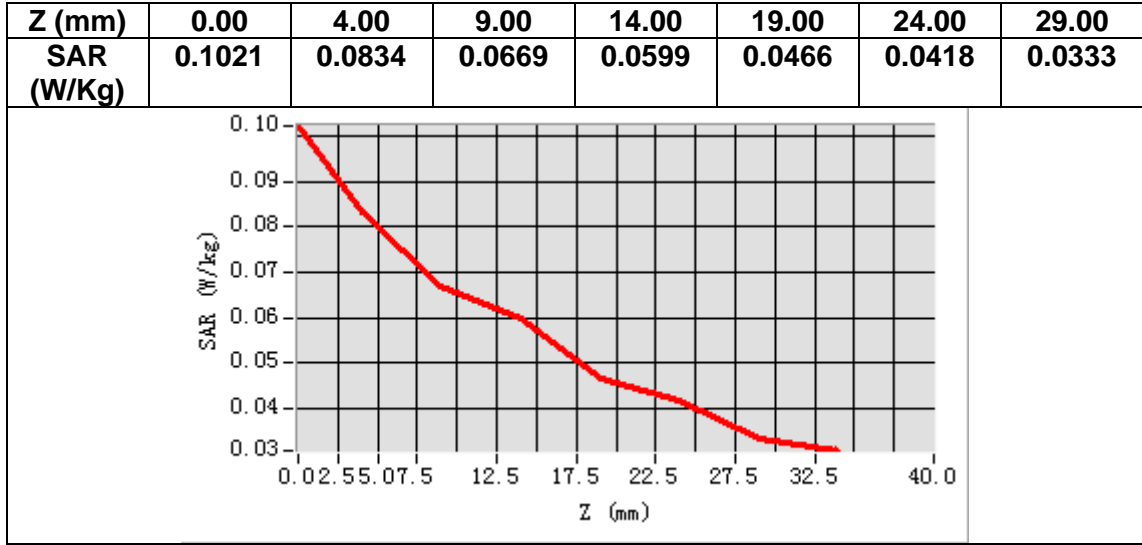

## 14. Appendix D. Calibration Certificate

<b>Table of contents</b>
E Field Probe - SN 08/16 EPGO287
750 MHz Dipole - SN 03/15 DIP 0G750-355
835 MHz Dipole - SN 03/15 DIP 0G835-347
1800 MHz Dipole - SN 03/15 DIP 1G800-349
1900 MHz Dipole - SN 03/15 DIP 1G900-350
2450 MHz Dipole - SN 03/15 DIP 2G450-352
2600 MHz Dipole - SN 03/15 DIP 2G600-356



## COMOSAR E-Field Probe Calibration Report

Ref : ACR.260.1.18.SATU.A

### SHENZHEN NTEK TESTING TECHNOLOGY CO., LTD.

BUILDING E, FENDA SCIENCE PARK, SANWEI  
COMMUNITY, XIXIANG STREET,  
BAO'AN DISTRICT, SHENZHEN GUANGDONG, CHINA  
MVG COMOSAR DOSIMETRIC E-FIELD PROBE  
SERIAL NO.: SN 08/16 EPGO287

Calibrated at MVG US  
2105 Barrett Park Dr. - Kennesaw, GA 30144



Calibration Date: 09/17/2018



#### Summary:

This document presents the method and results from an accredited COMOSAR Dosimetric E-Field Probe calibration performed in MVG USA using the CALISAR / CALIBAIR test bench, for use with a COMOSAR system only. All calibration results are traceable to national metrology institutions.



COMOSAR E-FIELD PROBE CALIBRATION REPORT

Ref: ACR.260.1.18.SATU.A

	<i>Name</i>	<i>Function</i>	<i>Date</i>	<i>Signature</i>
<i>Prepared by :</i>	Jérôme LUC	Product Manager	9/17/2018	
<i>Checked by :</i>	Jérôme LUC	Product Manager	9/17/2018	
<i>Approved by :</i>	Kim RUTKOWSKI	Quality Manager	9/17/2018	

	<i>Customer Name</i>
<i>Distribution :</i>	SHENZHEN NTEK TESTING TECHNOLOGY CO., LTD.

<i>Issue</i>	<i>Date</i>	<i>Modifications</i>
A	9/17/2018	Initial release



COMOSAR E-FIELD PROBE CALIBRATION REPORT

Ref: ACR.260.1.18.SATU.A

TABLE OF CONTENTS

1 Device Under Test ..... 4

2 Product Description ..... 4

    2.1 General Information ..... 4

3 Measurement Method ..... 4

    3.1 Linearity ..... 4

    3.2 Sensitivity ..... 5

    3.3 Lower Detection Limit ..... 5

    3.4 Isotropy ..... 5

    3.5 Boundary Effect ..... 5

4 Measurement Uncertainty ..... 5

5 Calibration Measurement Results ..... 6

    5.1 Sensitivity in air ..... 6

    5.2 Linearity ..... 7

    5.3 Sensitivity in liquid ..... 7

    5.4 Isotropy ..... 8

6 List of Equipment ..... 10





COMOSAR E-FIELD PROBE CALIBRATION REPORT

Ref: ACR.260.1.18.SATU.A

**1 DEVICE UNDER TEST**

Device Under Test	
Device Type	COMOSAR DOSIMETRIC E FIELD PROBE
Manufacturer	MVG
Model	SSE2
Serial Number	SN 08/16 EPGO287
Product Condition (new / used)	Used
Frequency Range of Probe	0.15 GHz-6GHz
Resistance of Three Dipoles at Connector	Dipole 1: R1=0.209 MΩ Dipole 2: R2=0.196 MΩ Dipole 3: R3=0.197 MΩ

A yearly calibration interval is recommended.

**2 PRODUCT DESCRIPTION**

2.1 GENERAL INFORMATION

MVG's COMOSAR E field Probes are built in accordance to the IEEE 1528, OET 65 Bulletin C and CEI/IEC 62209 standards.



**Figure 1 – MVG COMOSAR Dosimetric E field Dipole**

Probe Length	330 mm
Length of Individual Dipoles	2 mm
Maximum external diameter	8 mm
Probe Tip External Diameter	2.5 mm
Distance between dipoles / probe extremity	1 mm

**3 MEASUREMENT METHOD**

The IEEE 1528, OET 65 Bulletin C, CENELEC EN50361 and CEI/IEC 62209 standards provide recommended practices for the probe calibrations, including the performance characteristics of interest and methods by which to assess their affect. All calibrations / measurements performed meet the fore mentioned standards.

3.1 LINEARITY

The evaluation of the linearity was done in free space using the waveguide, performing a power sweep to cover the SAR range 0.01W/kg to 100W/kg.





COMOSAR E-FIELD PROBE CALIBRATION REPORT

Ref: ACR.260.1.18.SATU.A

3.2 SENSITIVITY

The sensitivity factors of the three dipoles were determined using a two step calibration method (air and tissue simulating liquid) using waveguides as outlined in the standards.

3.3 LOWER DETECTION LIMIT

The lower detection limit was assessed using the same measurement set up as used for the linearity measurement. The required lower detection limit is 10 mW/kg.

3.4 ISOTROPY

The axial isotropy was evaluated by exposing the probe to a reference wave from a standard dipole with the dipole mounted under the flat phantom in the test configuration suggested for system validations and checks. The probe was rotated along its main axis from 0 - 360 degrees in 15 degree steps. The hemispherical isotropy is determined by inserting the probe in a thin plastic box filled with tissue-equivalent liquid, with the plastic box illuminated with the fields from a half wave dipole. The dipole is rotated about its axis (0°–180°) in 15° increments. At each step the probe is rotated about its axis (0°–360°).

3.5 BOUNDARY EFFECT

The boundary effect is defined as the deviation between the SAR measured data and the expected exponential decay in the liquid when the probe is oriented normal to the interface. To evaluate this effect, the liquid filled flat phantom is exposed to fields from either a reference dipole or waveguide. With the probe normal to the phantom surface, the peak spatial average SAR is measured and compared to the analytical value at the surface.

4 MEASUREMENT UNCERTAINTY

The guidelines outlined in the IEEE 1528, OET 65 Bulletin C, CENELEC EN50361 and CEI/IEC 62209 standards were followed to generate the measurement uncertainty associated with an E-field probe calibration using the waveguide technique. All uncertainties listed below represent an expanded uncertainty expressed at approximately the 95% confidence level using a coverage factor of k=2, traceable to the Internationally Accepted Guides to Measurement Uncertainty.

Uncertainty analysis of the probe calibration in waveguide					
ERROR SOURCES	Uncertainty value (%)	Probability Distribution	Divisor	ci	Standard Uncertainty (%)
Incident or forward power	3.00%	Rectangular	$\sqrt{3}$	1	1.732%
Reflected power	3.00%	Rectangular	$\sqrt{3}$	1	1.732%
Liquid conductivity	5.00%	Rectangular	$\sqrt{3}$	1	2.887%
Liquid permittivity	4.00%	Rectangular	$\sqrt{3}$	1	2.309%
Field homogeneity	3.00%	Rectangular	$\sqrt{3}$	1	1.732%
Field probe positioning	5.00%	Rectangular	$\sqrt{3}$	1	2.887%
Field probe linearity	3.00%	Rectangular	$\sqrt{3}$	1	1.732%
<b>Combined standard uncertainty</b>					5.831%
<b>Expanded uncertainty</b> 95 % confidence level k = 2					12.0%



COMOSAR E-FIELD PROBE CALIBRATION REPORT

Ref: ACR.260.1.18.SATU.A

5 CALIBRATION MEASUREMENT RESULTS

Calibration Parameters	
Liquid Temperature	21 °C
Lab Temperature	21 °C
Lab Humidity	45 %

5.1 SENSITIVITY IN AIR

Normx dipole 1 ( $\mu\text{V}/(\text{V}/\text{m})^2$ )	Normy dipole 2 ( $\mu\text{V}/(\text{V}/\text{m})^2$ )	Normz dipole 3 ( $\mu\text{V}/(\text{V}/\text{m})^2$ )
0.66	0.75	0.58

DCP dipole 1 (mV)	DCP dipole 2 (mV)	DCP dipole 3 (mV)
93	93	98

Calibration curves  $e_i=f(V)$  ( $i=1,2,3$ ) allow to obtain H-field value using the formula:

$$E = \sqrt{E_1^2 + E_2^2 + E_3^2}$$

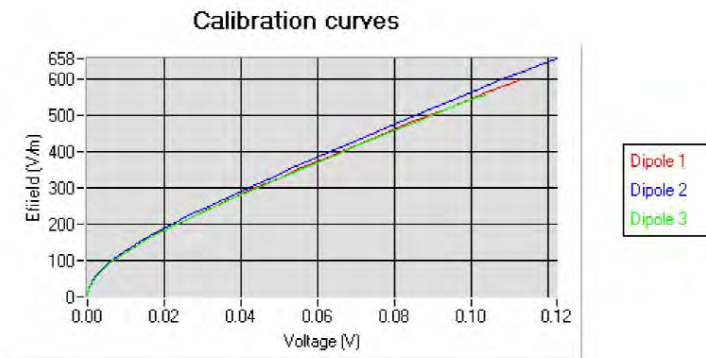



COMOSAR E-FIELD PROBE CALIBRATION REPORT

Ref: ACR.260.1.18.SATU.A

5.2 LINEARITY

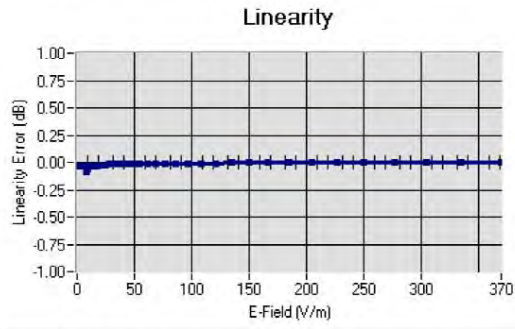

Linearity:  $\pm 1.89\%$  ( $\pm 0.08\text{dB}$ )

5.3 SENSITIVITY IN LIQUID

Liquid	Frequency (MHz $\pm$ 100MHz)	Permittivity	Epsilon (S/m)	ConvF
HL750	750	40.03	0.93	1.45
BL750	750	56.83	1.00	1.49
HL850	835	42.19	0.90	1.50
BL850	835	54.67	1.01	1.56
HL900	900	42.08	1.01	1.51
HL1800	1800	41.68	1.46	1.71
BL1800	1800	53.86	1.46	1.77
HL1900	1900	38.45	1.45	2.03
BL1900	1900	53.32	1.56	2.07
HL2000	2000	38.26	1.38	1.76
HL2450	2450	37.50	1.80	2.00
BL2450	2450	53.22	1.89	2.08
HL2600	2600	39.80	1.99	2.12
BL2600	2600	52.52	2.23	2.19
HL5200	5200	35.64	4.67	2.55
BL5200	5200	48.64	5.51	2.62
HL5400	5400	36.44	4.87	2.53
BL5400	5400	46.52	5.77	2.59
HL5600	5600	36.66	5.17	2.64
BL5600	5600	46.79	5.77	2.73
HL5800	5800	35.31	5.31	2.72
BL5800	5800	47.04	6.10	2.81

LOWER DETECTION LIMIT: 7mW/kg





COMOSAR E-FIELD PROBE CALIBRATION REPORT

Ref: ACR.260.1.18.SATU.A

5.4 ISOTROPY

**HL900 MHz**

- Axial isotropy: 0.04 dB
- Hemispherical isotropy: 0.07 dB

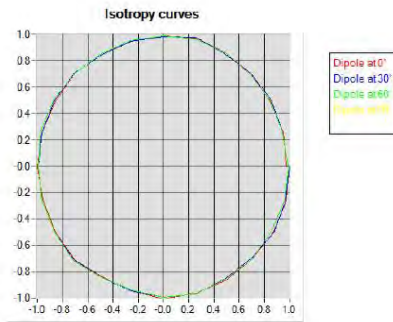

**HL1800 MHz**

- Axial isotropy: 0.06 dB
- Hemispherical isotropy: 0.08 dB

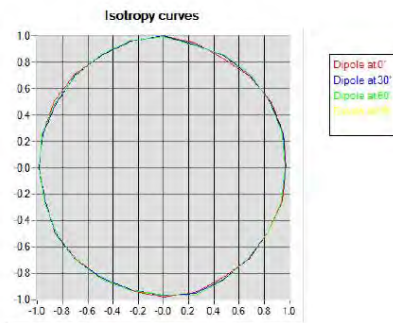



COMOSAR E-FIELD PROBE CALIBRATION REPORT

Ref: ACR.260.1.18.SATU.A

**HL5600 MHz**

- Axial isotropy: 0.06 dB
- Hemispherical isotropy: 0.08 dB

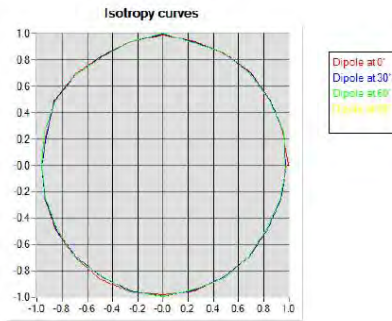



COMOSAR E-FIELD PROBE CALIBRATION REPORT

Ref: ACR.260.1.18.SATU.A

6 LIST OF EQUIPMENT

Equipment Summary Sheet				
Equipment Description	Manufacturer / Model	Identification No.	Current Calibration Date	Next Calibration Date
Flat Phantom	MVG	SN-20/09-SAM71	Validated. No cal required.	Validated. No cal required.
COMOSAR Test Bench	Version 3	NA	Validated. No cal required.	Validated. No cal required.
Network Analyzer	Rhode & Schwarz ZVA	SN100132	02/2016	02/2019
Reference Probe	MVG	EP 94 SN 37/08	10/2017	10/2018
Multimeter	Keithley 2000	1188656	01/2017	01/2020
Signal Generator	Agilent E4438C	MY49070581	01/2017	01/2020
Amplifier	Aethercomm	SN 046	Characterized prior to test. No cal required.	Characterized prior to test. No cal required.
Power Meter	HP E4418A	US38261498	01/2017	01/2020
Power Sensor	HP ECP-E26A	US37181460	01/2017	01/2020
Directional Coupler	Narda 4216-20	01386	Characterized prior to test. No cal required.	Characterized prior to test. No cal required.
Waveguide	Mega Industries	069Y7-158-13-712	Validated. No cal required.	Validated. No cal required.
Waveguide Transition	Mega Industries	069Y7-158-13-701	Validated. No cal required.	Validated. No cal required.
Waveguide Termination	Mega Industries	069Y7-158-13-701	Validated. No cal required.	Validated. No cal required.
Temperature / Humidity Sensor	Control Company	150798832	11/2017	11/2020



## SAR Reference Dipole Calibration Report

Ref : ACR.109.1.18.SATU.A

**SHENZHEN NTEK TESTING TECHNOLOGY  
CO., LTD.**

**BUILDING E, FENDA SCIENCE PARK, SANWEI  
COMMUNITY, XIXIANG STREET,  
BAO'AN DISTRICT, SHENZHEN GUANGDONG, CHINA  
MVG COMOSAR REFERENCE DIPOLE**

**FREQUENCY: 750 MHZ**

**SERIAL NO.: SN 03/15 DIP 0G750-355**

**Calibrated at MVG US**

**2105 Barrett Park Dr. - Kennesaw, GA 30144**



**Calibration Date: 04/19/2018**

*Summary:*

This document presents the method and results from an accredited SAR reference dipole calibration performed in MVG USA using the COMOSAR test bench. All calibration results are traceable to national metrology institutions.





SAR REFERENCE DIPOLE CALIBRATION REPORT

Ref: ACR.109.1.18.SATU.A

	<i>Name</i>	<i>Function</i>	<i>Date</i>	<i>Signature</i>
<i>Prepared by :</i>	Jérôme LUC	Product Manager	4/19/2018	<i>JS</i>
<i>Checked by :</i>	Jérôme LUC	Product Manager	4/19/2018	<i>JS</i>
<i>Approved by :</i>	Kim RUTKOWSKI	Quality Manager	4/19/2018	<i>Kim Rutkowski</i>

	<i>Customer Name</i>
<i>Distribution :</i>	SHENZHEN NTEK TESTING TECHNOLOGY CO., LTD.

<i>Issue</i>	<i>Date</i>	<i>Modifications</i>
A	4/19/2018	Initial release



**SAR REFERENCE DIPOLE CALIBRATION REPORT**

Ref: ACR.109.1.18.SATU.A

**TABLE OF CONTENTS**

1	Introduction .....	4
2	Device Under Test .....	4
3	Product Description .....	4
3.1	General Information .....	4
4	Measurement Method .....	5
4.1	Return Loss Requirements .....	5
4.2	Mechanical Requirements .....	5
5	Measurement Uncertainty .....	5
5.1	Return Loss .....	5
5.2	Dimension Measurement .....	5
5.3	Validation Measurement .....	5
6	Calibration Measurement Results .....	6
6.1	Return Loss and Impedance In Head Liquid .....	6
6.2	Return Loss and Impedance In Body Liquid .....	6
6.3	Mechanical Dimensions .....	6
7	Validation measurement .....	7
7.1	Head Liquid Measurement .....	7
7.2	SAR Measurement Result With Head Liquid .....	8
7.3	Body Liquid Measurement .....	9
7.4	SAR Measurement Result With Body Liquid .....	10
8	List of Equipment .....	11



**SAR REFERENCE DIPOLE CALIBRATION REPORT**

Ref: ACR.109.1.18.SATU.A

**1 INTRODUCTION**

This document contains a summary of the requirements set forth by the IEEE 1528, FCC KDBs and CEI/IEC 62209 standards for reference dipoles used for SAR measurement system validations and the measurements that were performed to verify that the product complies with the fore mentioned standards.

**2 DEVICE UNDER TEST**

Device Under Test	
Device Type	COMOSAR 750 MHz REFERENCE DIPOLE
Manufacturer	MVG
Model	SID750
Serial Number	SN 03/15 DIP 0G750-355
Product Condition (new / used)	Used

A yearly calibration interval is recommended.

**3 PRODUCT DESCRIPTION**

**3.1 GENERAL INFORMATION**

MVG’s COMOSAR Validation Dipoles are built in accordance to the IEEE 1528, FCC KDBs and CEI/IEC 62209 standards. The product is designed for use with the COMOSAR test bench only.



**Figure 1 – MVG COMOSAR Validation Dipole**





**SAR REFERENCE DIPOLE CALIBRATION REPORT**

Ref: ACR.109.1.18.SATU.A

**4 MEASUREMENT METHOD**

The IEEE 1528, FCC KDBs and CEI/IEC 62209 standards provide requirements for reference dipoles used for system validation measurements. The following measurements were performed to verify that the product complies with the fore mentioned standards.

**4.1 RETURN LOSS REQUIREMENTS**

The dipole used for SAR system validation measurements and checks must have a return loss of -20 dB or better. The return loss measurement shall be performed against a liquid filled flat phantom, with the phantom constructed as outlined in the fore mentioned standards.

**4.2 MECHANICAL REQUIREMENTS**

The IEEE Std. 1528 and CEI/IEC 62209 standards specify the mechanical components and dimensions of the validation dipoles, with the dimensions frequency and phantom shell thickness dependent. The COMOSAR test bench employs a 2 mm phantom shell thickness therefore the dipoles sold for use with the COMOSAR test bench comply with the requirements set forth for a 2 mm phantom shell thickness.

**5 MEASUREMENT UNCERTAINTY**

All uncertainties listed below represent an expanded uncertainty expressed at approximately the 95% confidence level using a coverage factor of k=2, traceable to the Internationally Accepted Guides to Measurement Uncertainty.

**5.1 RETURN LOSS**

The following uncertainties apply to the return loss measurement:

Frequency band	Expanded Uncertainty on Return Loss
400-6000MHz	0.1 dB

**5.2 DIMENSION MEASUREMENT**

The following uncertainties apply to the dimension measurements:

Length (mm)	Expanded Uncertainty on Length
3 - 300	0.05 mm

**5.3 VALIDATION MEASUREMENT**

The guidelines outlined in the IEEE 1528, FCC KDBs, CENELEC EN50361 and CEI/IEC 62209 standards were followed to generate the measurement uncertainty for validation measurements.

Scan Volume	Expanded Uncertainty
1 g	20.3 %



SAR REFERENCE DIPOLE CALIBRATION REPORT

Ref: ACR.109.1.18.SATU.A

10 g	20.1 %
------	--------

6 CALIBRATION MEASUREMENT RESULTS

6.1 RETURN LOSS AND IMPEDANCE IN HEAD LIQUID

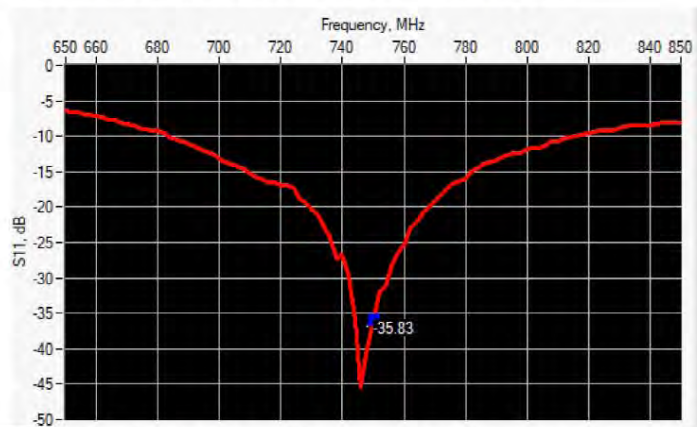

Frequency (MHz)	Return Loss (dB)	Requirement (dB)	Impedance
750	-35.83	-20	51.3 Ω - 1.2 jΩ

6.2 RETURN LOSS AND IMPEDANCE IN BODY LIQUID

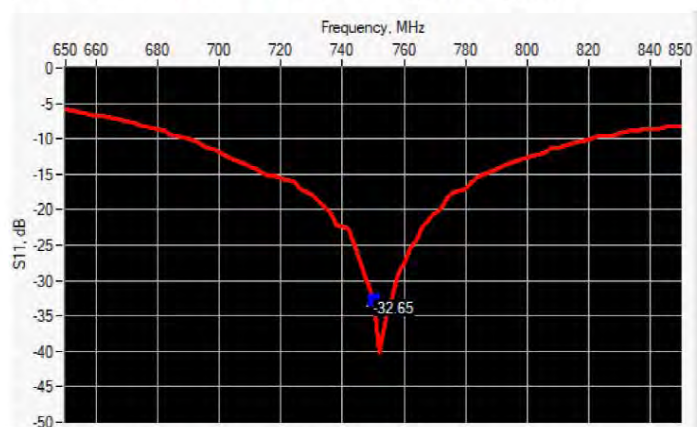

Frequency (MHz)	Return Loss (dB)	Requirement (dB)	Impedance
750	-32.65	-20	50.8 Ω + 2.3 jΩ

6.3 MECHANICAL DIMENSIONS

Frequency MHz	L mm		h mm		d mm	
	required	measured	required	measured	required	measured
300	420.0 ±1 %		250.0 ±1 %		6.35 ±1 %	





SAR REFERENCE DIPOLE CALIBRATION REPORT

Ref: ACR.109.1.18.SATU.A

450	290.0 ±1 %.		166.7 ±1 %.		6.35 ±1 %.	
750	176.0 ±1 %.	PASS	100.0 ±1 %.	PASS	6.35 ±1 %.	PASS
835	161.0 ±1 %.		89.8 ±1 %.		3.6 ±1 %.	
900	149.0 ±1 %.		83.3 ±1 %.		3.6 ±1 %.	
1450	89.1 ±1 %.		51.7 ±1 %.		3.6 ±1 %.	
1500	80.5 ±1 %.		50.0 ±1 %.		3.6 ±1 %.	
1640	79.0 ±1 %.		45.7 ±1 %.		3.6 ±1 %.	
1750	75.2 ±1 %.		42.9 ±1 %.		3.6 ±1 %.	
1800	72.0 ±1 %.		41.7 ±1 %.		3.6 ±1 %.	
1900	68.0 ±1 %.		39.5 ±1 %.		3.6 ±1 %.	
1950	66.3 ±1 %.		38.5 ±1 %.		3.6 ±1 %.	
2000	64.5 ±1 %.		37.5 ±1 %.		3.6 ±1 %.	
2100	61.0 ±1 %.		35.7 ±1 %.		3.6 ±1 %.	
2300	55.5 ±1 %.		32.6 ±1 %.		3.6 ±1 %.	
2450	51.5 ±1 %.		30.4 ±1 %.		3.6 ±1 %.	
2600	48.5 ±1 %.		28.8 ±1 %.		3.6 ±1 %.	
3000	41.5 ±1 %.		25.0 ±1 %.		3.6 ±1 %.	
3500	37.0 ±1 %.		26.4 ±1 %.		3.6 ±1 %.	
3700	34.7 ±1 %.		26.4 ±1 %.		3.6 ±1 %.	

7 VALIDATION MEASUREMENT

The IEEE Std. 1528, FCC KDBs and CEI/IEC 62209 standards state that the system validation measurements must be performed using a reference dipole meeting the fore mentioned return loss and mechanical dimension requirements. The validation measurement must be performed against a liquid filled flat phantom, with the phantom constructed as outlined in the fore mentioned standards. Per the standards, the dipole shall be positioned below the bottom of the phantom, with the dipole length centered and parallel to the longest dimension of the flat phantom, with the top surface of the dipole at the described distance from the bottom surface of the phantom.

7.1 HEAD LIQUID MEASUREMENT

Frequency MHz	Relative permittivity ( $\epsilon_r'$ )		Conductivity ( $\sigma$ ) S/m	
	required	measured	required	measured
300	45.3 ±5 %		0.87 ±5 %	
450	43.5 ±5 %		0.87 ±5 %	
750	41.9 ±5 %	PASS	0.89 ±5 %	PASS
835	41.5 ±5 %		0.90 ±5 %	
900	41.5 ±5 %		0.97 ±5 %	
1450	40.5 ±5 %		1.20 ±5 %	
1500	40.4 ±5 %		1.23 ±5 %	
1640	40.2 ±5 %		1.31 ±5 %	
1750	40.1 ±5 %		1.37 ±5 %	

Page: 7/11

*This document shall not be reproduced, except in full or in part, without the written approval of MVG.  
The information contained herein is to be used only for the purpose for which it is submitted and is not to be released in whole or part without written approval of MVG.*



**SAR REFERENCE DIPOLE CALIBRATION REPORT**

Ref: ACR.109.1.18.SATU.A

1800	40.0 ±5 %		1.40 ±5 %	
1900	40.0 ±5 %		1.40 ±5 %	
1950	40.0 ±5 %		1.40 ±5 %	
2000	40.0 ±5 %		1.40 ±5 %	
2100	39.8 ±5 %		1.49 ±5 %	
2300	39.5 ±5 %		1.67 ±5 %	
2450	39.2 ±5 %		1.80 ±5 %	
2600	39.0 ±5 %		1.96 ±5 %	
3000	38.5 ±5 %		2.40 ±5 %	
3500	37.9 ±5 %		2.91 ±5 %	

**7.2 SAR MEASUREMENT RESULT WITH HEAD LIQUID**

The IEEE Std. 1528 and CEI/IEC 62209 standards state that the system validation measurements should produce the SAR values shown below (for phantom thickness of 2 mm), within the uncertainty for the system validation. All SAR values are normalized to 1 W forward power. In bracket, the measured SAR is given with the used input power.

Software	OPENSAR V4
Phantom	SN 20/09 SAM71
Probe	SN 18/11 EPG122
Liquid	Head Liquid Values: eps' : 40.0 sigma : 0.93
Distance between dipole center and liquid	15.0 mm
Area scan resolution	dx=8mm/dy=8mm
Zoon Scan Resolution	dx=8mm/dy=8mm/dz=5mm
Frequency	750 MHz
Input power	20 dBm
Liquid Temperature	21 °C
Lab Temperature	21 °C
Lab Humidity	45 %

Frequency MHz	1 g SAR (W/kg/W)		10 g SAR (W/kg/W)	
	required	measured	required	measured
300	2.85		1.94	
450	4.58		3.06	
750	8.49	8.56 (0.86)	5.55	5.61 (0.56)
835	9.56		6.22	
900	10.9		6.99	
1450	29		16	
1500	30.5		16.8	
1640	34.2		18.4	
1750	36.4		19.3	
1800	38.4		20.1	





SAR REFERENCE DIPOLE CALIBRATION REPORT

Ref: ACR.109.1.18.SATU.A

1900	39.7		20.5	
1950	40.5		20.9	
2000	41.1		21.1	
2100	43.6		21.9	
2300	48.7		23.3	
2450	52.4		24	
2600	55.3		24.6	
3000	63.8		25.7	
3500	67.1		25	
3700	67.4		24.2	

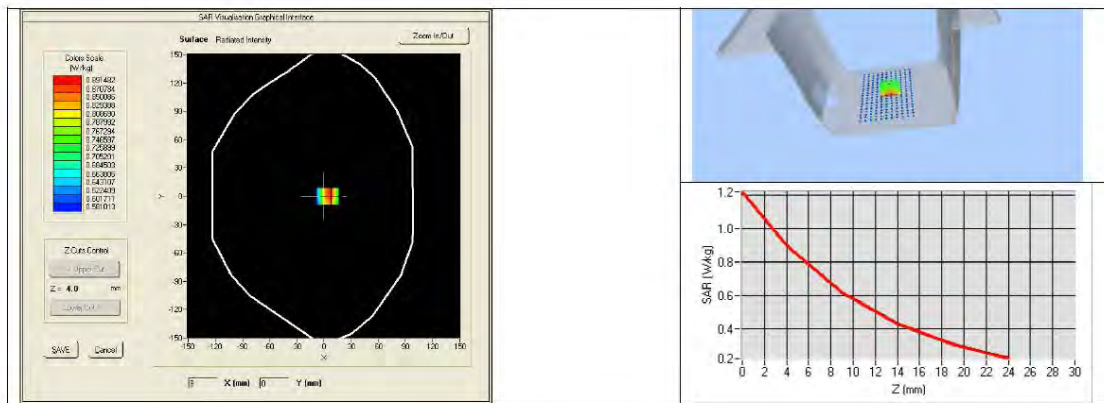

7.3 BODY LIQUID MEASUREMENT

Frequency MHz	Relative permittivity ( $\epsilon_r'$ )		Conductivity ( $\sigma$ ) S/m	
	required	measured	required	measured
150	61.9 ±5 %		0.80 ±5 %	
300	58.2 ±5 %		0.92 ±5 %	
450	56.7 ±5 %		0.94 ±5 %	
750	55.5 ±5 %	PASS	0.96 ±5 %	PASS
835	55.2 ±5 %		0.97 ±5 %	
900	55.0 ±5 %		1.05 ±5 %	
915	55.0 ±5 %		1.06 ±5 %	
1450	54.0 ±5 %		1.30 ±5 %	
1610	53.8 ±5 %		1.40 ±5 %	
1800	53.3 ±5 %		1.52 ±5 %	
1900	53.3 ±5 %		1.52 ±5 %	
2000	53.3 ±5 %		1.52 ±5 %	
2100	53.2 ±5 %		1.62 ±5 %	



**SAR REFERENCE DIPOLE CALIBRATION REPORT**

Ref: ACR.109.1.18.SATU.A

2300	52.9 ±5 %		1.81 ±5 %	
2450	52.7 ±5 %		1.95 ±5 %	
2600	52.5 ±5 %		2.16 ±5 %	
3000	52.0 ±5 %		2.73 ±5 %	
3500	51.3 ±5 %		3.31 ±5 %	
3700	51.0 ±5 %		3.55 ±5 %	
5200	49.0 ±10 %		5.30 ±10 %	
5300	48.9 ±10 %		5.42 ±10 %	
5400	48.7 ±10 %		5.53 ±10 %	
5500	48.6 ±10 %		5.65 ±10 %	
5600	48.5 ±10 %		5.77 ±10 %	
5800	48.2 ±10 %		6.00 ±10 %	

**7.4 SAR MEASUREMENT RESULT WITH BODY LIQUID**

Software	OPENSAR V4
Phantom	SN 20/09 SAM71
Probe	SN 18/11 EPG122
Liquid	Body Liquid Values: eps' : 56.8 sigma : 1.00
Distance between dipole center and liquid	15.0 mm
Area scan resolution	dx=8mm/dy=8mm
Zoon Scan Resolution	dx=8mm/dy=8mm/dz=5mm
Frequency	750 MHz
Input power	20 dBm
Liquid Temperature	21 °C
Lab Temperature	21 °C
Lab Humidity	45 %

Frequency MHz	1 g SAR (W/kg/W)	10 g SAR (W/kg/W)
	measured	measured
750	8.85 (0.89)	5.91 (0.59)

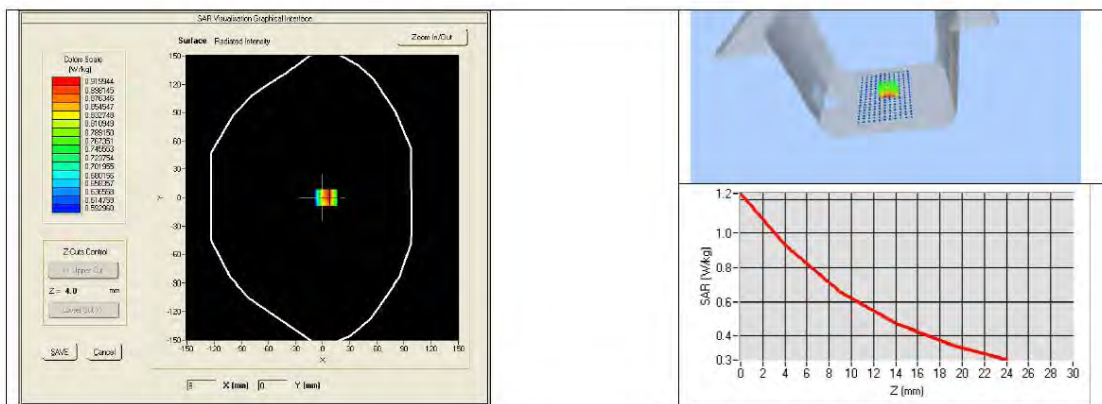



SAR REFERENCE DIPOLE CALIBRATION REPORT

Ref: ACR.109.1.18.SATU.A

**8 LIST OF EQUIPMENT**

Equipment Summary Sheet				
Equipment Description	Manufacturer / Model	Identification No.	Current Calibration Date	Next Calibration Date
SAM Phantom	MVG	SN-20/09-SAM71	Validated. No cal required.	Validated. No cal required.
COMOSAR Test Bench	Version 3	NA	Validated. No cal required.	Validated. No cal required.
Network Analyzer	Rhode & Schwarz ZVA	SN100132	02/2016	02/2019
Calipers	Carrera	CALIPER-01	01/2017	01/2020
Reference Probe	MVG	EPG122 SN 18/11	10/2017	10/2018
Multimeter	Keithley 2000	1188656	01/2017	01/2020
Signal Generator	Agilent E4438C	MY49070581	01/2017	01/2020
Amplifier	Aethercomm	SN 046	Characterized prior to test. No cal required.	Characterized prior to test. No cal required.
Power Meter	HP E4418A	US38261498	01/2017	01/2020
Power Sensor	HP ECP-E26A	US37181460	01/2017	01/2020
Directional Coupler	Narda 4216-20	01386	Characterized prior to test. No cal required.	Characterized prior to test. No cal required.
Temperature and Humidity Sensor	Control Company	150798832	11/2017	11/2020





## SAR Reference Dipole Calibration Report

Ref : ACR.109.2.18.SATU.A

**SHENZHEN NTEK TESTING TECHNOLOGY  
CO., LTD.**

**BUILDING E, FENDA SCIENCE PARK, SANWEI  
COMMUNITY, XIXIANG STREET,  
BAO'AN DISTRICT, SHENZHEN GUANGDONG, CHINA**

**MVG COMOSAR REFERENCE DIPOLE**

**FREQUENCY: 835 MHZ**

**SERIAL NO.: SN 03/15 DIP 0G835-347**

**Calibrated at MVG US**

**2105 Barrett Park Dr. - Kennesaw, GA 30144**



**Calibration Date: 04/19/2018**

*Summary:*

This document presents the method and results from an accredited SAR reference dipole calibration performed in MVG USA using the COMOSAR test bench. All calibration results are traceable to national metrology institutions.



SAR REFERENCE DIPOLE CALIBRATION REPORT

Ref: ACR.109.2.18.SATU.A

	<i>Name</i>	<i>Function</i>	<i>Date</i>	<i>Signature</i>
<i>Prepared by :</i>	Jérôme LUC	Product Manager	4/19/2018	<i>JL</i>
<i>Checked by :</i>	Jérôme LUC	Product Manager	4/19/2018	<i>JL</i>
<i>Approved by :</i>	Kim RUTKOWSKI	Quality Manager	4/19/2018	<i>Kim Rutkowski</i>

	<i>Customer Name</i>
<i>Distribution :</i>	SHENZHEN NTEK TESTING TECHNOLOGY CO., LTD.

<i>Issue</i>	<i>Date</i>	<i>Modifications</i>
A	4/19/2018	Initial release



**SAR REFERENCE DIPOLE CALIBRATION REPORT**

Ref: ACR.109.2.18.SATU.A

**TABLE OF CONTENTS**

1	Introduction.....	4
2	Device Under Test .....	4
3	Product Description .....	4
3.1	General Information .....	4
4	Measurement Method .....	5
4.1	Return Loss Requirements .....	5
4.2	Mechanical Requirements .....	5
5	Measurement Uncertainty.....	5
5.1	Return Loss .....	5
5.2	Dimension Measurement .....	5
5.3	Validation Measurement .....	5
6	Calibration Measurement Results.....	6
6.1	Return Loss and Impedance In Head Liquid .....	6
6.2	Return Loss and Impedance In Body Liquid .....	6
6.3	Mechanical Dimensions .....	6
7	Validation measurement .....	7
7.1	Head Liquid Measurement .....	7
7.2	SAR Measurement Result With Head Liquid .....	8
7.3	Body Liquid Measurement .....	9
7.4	SAR Measurement Result With Body Liquid .....	10
8	List of Equipment .....	11





**SAR REFERENCE DIPOLE CALIBRATION REPORT**

Ref: ACR.109.2.18.SATU.A

**1 INTRODUCTION**

This document contains a summary of the requirements set forth by the IEEE 1528, FCC KDBs and CEI/IEC 62209 standards for reference dipoles used for SAR measurement system validations and the measurements that were performed to verify that the product complies with the fore mentioned standards.

**2 DEVICE UNDER TEST**

Device Under Test	
Device Type	COMOSAR 835 MHz REFERENCE DIPOLE
Manufacturer	MVG
Model	SID835
Serial Number	SN 03/15 DIP 0G835-347
Product Condition (new / used)	Used

A yearly calibration interval is recommended.

**3 PRODUCT DESCRIPTION**

**3.1 GENERAL INFORMATION**

MVG’s COMOSAR Validation Dipoles are built in accordance to the IEEE 1528, FCC KDBs and CEI/IEC 62209 standards. The product is designed for use with the COMOSAR test bench only.



**Figure 1 – MVG COMOSAR Validation Dipole**



**SAR REFERENCE DIPOLE CALIBRATION REPORT**

Ref: ACR.109.2.18.SATU.A

**4 MEASUREMENT METHOD**

The IEEE 1528, FCC KDBs and CEI/IEC 62209 standards provide requirements for reference dipoles used for system validation measurements. The following measurements were performed to verify that the product complies with the fore mentioned standards.

**4.1 RETURN LOSS REQUIREMENTS**

The dipole used for SAR system validation measurements and checks must have a return loss of -20 dB or better. The return loss measurement shall be performed against a liquid filled flat phantom, with the phantom constructed as outlined in the fore mentioned standards.

**4.2 MECHANICAL REQUIREMENTS**

The IEEE Std. 1528 and CEI/IEC 62209 standards specify the mechanical components and dimensions of the validation dipoles, with the dimensions frequency and phantom shell thickness dependent. The COMOSAR test bench employs a 2 mm phantom shell thickness therefore the dipoles sold for use with the COMOSAR test bench comply with the requirements set forth for a 2 mm phantom shell thickness.

**5 MEASUREMENT UNCERTAINTY**

All uncertainties listed below represent an expanded uncertainty expressed at approximately the 95% confidence level using a coverage factor of k=2, traceable to the Internationally Accepted Guides to Measurement Uncertainty.

**5.1 RETURN LOSS**

The following uncertainties apply to the return loss measurement:

Frequency band	Expanded Uncertainty on Return Loss
400-6000MHz	0.1 dB

**5.2 DIMENSION MEASUREMENT**

The following uncertainties apply to the dimension measurements:

Length (mm)	Expanded Uncertainty on Length
3 - 300	0.05 mm

**5.3 VALIDATION MEASUREMENT**

The guidelines outlined in the IEEE 1528, FCC KDBs, CENELEC EN50361 and CEI/IEC 62209 standards were followed to generate the measurement uncertainty for validation measurements.

Scan Volume	Expanded Uncertainty
1 g	20.3 %



SAR REFERENCE DIPOLE CALIBRATION REPORT

Ref: ACR.109.2.18.SATU.A

10 g	20.1 %
------	--------

**6 CALIBRATION MEASUREMENT RESULTS**

**6.1 RETURN LOSS AND IMPEDANCE IN HEAD LIQUID**

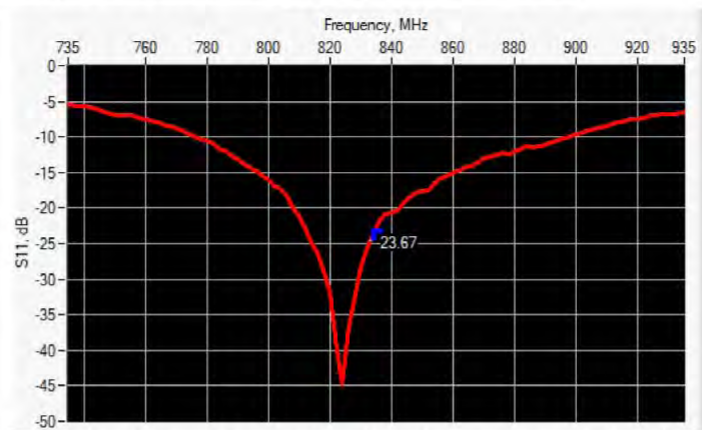

Frequency (MHz)	Return Loss (dB)	Requirement (dB)	Impedance
835	-23.67	-20	56.8 Ω - 1.5 jΩ

**6.2 RETURN LOSS AND IMPEDANCE IN BODY LIQUID**

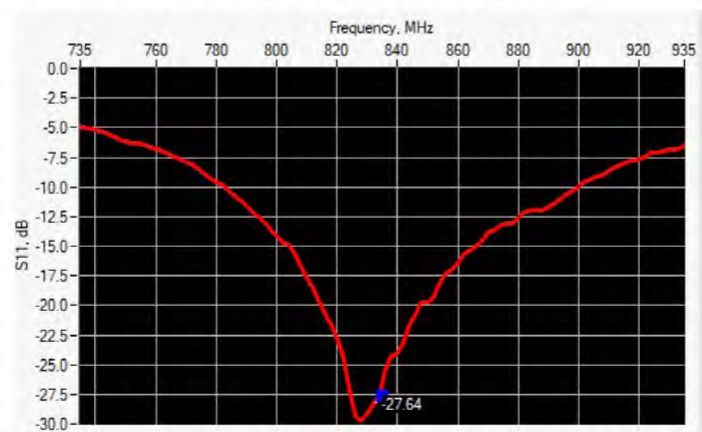

Frequency (MHz)	Return Loss (dB)	Requirement (dB)	Impedance
835	-27.64	-20	53.5 Ω + 2.3 jΩ

**6.3 MECHANICAL DIMENSIONS**

Frequency MHz	L mm		h mm		d mm	
	required	measured	required	measured	required	measured
300	420.0 ±1 %.		250.0 ±1 %.		6.35 ±1 %.	





**SAR REFERENCE DIPOLE CALIBRATION REPORT**

Ref: ACR.109.2.18.SATU.A

450	290.0 ±1 %.		166.7 ±1 %.		6.35 ±1 %.	
750	176.0 ±1 %.		100.0 ±1 %.		6.35 ±1 %.	
835	161.0 ±1 %.	PASS	89.8 ±1 %.	PASS	3.6 ±1 %.	PASS
900	149.0 ±1 %.		83.3 ±1 %.		3.6 ±1 %.	
1450	89.1 ±1 %.		51.7 ±1 %.		3.6 ±1 %.	
1500	80.5 ±1 %.		50.0 ±1 %.		3.6 ±1 %.	
1640	79.0 ±1 %.		45.7 ±1 %.		3.6 ±1 %.	
1750	75.2 ±1 %.		42.9 ±1 %.		3.6 ±1 %.	
1800	72.0 ±1 %.		41.7 ±1 %.		3.6 ±1 %.	
1900	68.0 ±1 %.		39.5 ±1 %.		3.6 ±1 %.	
1950	66.3 ±1 %.		38.5 ±1 %.		3.6 ±1 %.	
2000	64.5 ±1 %.		37.5 ±1 %.		3.6 ±1 %.	
2100	61.0 ±1 %.		35.7 ±1 %.		3.6 ±1 %.	
2300	55.5 ±1 %.		32.6 ±1 %.		3.6 ±1 %.	
2450	51.5 ±1 %.		30.4 ±1 %.		3.6 ±1 %.	
2600	48.5 ±1 %.		28.8 ±1 %.		3.6 ±1 %.	
3000	41.5 ±1 %.		25.0 ±1 %.		3.6 ±1 %.	
3500	37.0 ±1 %.		26.4 ±1 %.		3.6 ±1 %.	
3700	34.7 ±1 %.		26.4 ±1 %.		3.6 ±1 %.	

**7 VALIDATION MEASUREMENT**

The IEEE Std. 1528, FCC KDBs and CEI/IEC 62209 standards state that the system validation measurements must be performed using a reference dipole meeting the fore mentioned return loss and mechanical dimension requirements. The validation measurement must be performed against a liquid filled flat phantom, with the phantom constructed as outlined in the fore mentioned standards. Per the standards, the dipole shall be positioned below the bottom of the phantom, with the dipole length centered and parallel to the longest dimension of the flat phantom, with the top surface of the dipole at the described distance from the bottom surface of the phantom.

**7.1 HEAD LIQUID MEASUREMENT**

Frequency MHz	Relative permittivity (ε <sub>r</sub> )		Conductivity (σ) S/m	
	required	measured	required	measured
300	45.3 ±5 %		0.87 ±5 %	
450	43.5 ±5 %		0.87 ±5 %	
750	41.9 ±5 %		0.89 ±5 %	
835	41.5 ±5 %	PASS	0.90 ±5 %	PASS
900	41.5 ±5 %		0.97 ±5 %	
1450	40.5 ±5 %		1.20 ±5 %	
1500	40.4 ±5 %		1.23 ±5 %	
1640	40.2 ±5 %		1.31 ±5 %	
1750	40.1 ±5 %		1.37 ±5 %	

Page: 7/11

*This document shall not be reproduced, except in full or in part, without the written approval of MVG. The information contained herein is to be used only for the purpose for which it is submitted and is not to be released in whole or part without written approval of MVG.*



SAR REFERENCE DIPOLE CALIBRATION REPORT

Ref: ACR.109.2.18.SATU.A

1800	40.0 ±5 %		1.40 ±5 %	
1900	40.0 ±5 %		1.40 ±5 %	
1950	40.0 ±5 %		1.40 ±5 %	
2000	40.0 ±5 %		1.40 ±5 %	
2100	39.8 ±5 %		1.49 ±5 %	
2300	39.5 ±5 %		1.67 ±5 %	
2450	39.2 ±5 %		1.80 ±5 %	
2600	39.0 ±5 %		1.96 ±5 %	
3000	38.5 ±5 %		2.40 ±5 %	
3500	37.9 ±5 %		2.91 ±5 %	

7.2 SAR MEASUREMENT RESULT WITH HEAD LIQUID

The IEEE Std. 1528 and CEI/IEC 62209 standards state that the system validation measurements should produce the SAR values shown below (for phantom thickness of 2 mm), within the uncertainty for the system validation. All SAR values are normalized to 1 W forward power. In bracket, the measured SAR is given with the used input power.

Software	OPENSAR V4
Phantom	SN 20/09 SAM71
Probe	SN 18/11 EPG122
Liquid	Head Liquid Values: eps' : 40.0 sigma : 0.90
Distance between dipole center and liquid	15.0 mm
Area scan resolution	dx=8mm/dy=8mm
Zoon Scan Resolution	dx=8mm/dy=8mm/dz=5mm
Frequency	835 MHz
Input power	20 dBm
Liquid Temperature	21 °C
Lab Temperature	21 °C
Lab Humidity	45 %

Frequency MHz	1 g SAR (W/kg/W)		10 g SAR (W/kg/W)	
	required	measured	required	measured
300	2.85		1.94	
450	4.58		3.06	
750	8.49		5.55	
835	9.56	9.55 (0.95)	6.22	6.10 (0.61)
900	10.9		6.99	
1450	29		16	
1500	30.5		16.8	
1640	34.2		18.4	
1750	36.4		19.3	
1800	38.4		20.1	



SAR REFERENCE DIPOLE CALIBRATION REPORT

Ref: ACR.109.2.18.SATU.A

1900	39.7		20.5	
1950	40.5		20.9	
2000	41.1		21.1	
2100	43.6		21.9	
2300	48.7		23.3	
2450	52.4		24	
2600	55.3		24.6	
3000	63.8		25.7	
3500	67.1		25	
3700	67.4		24.2	

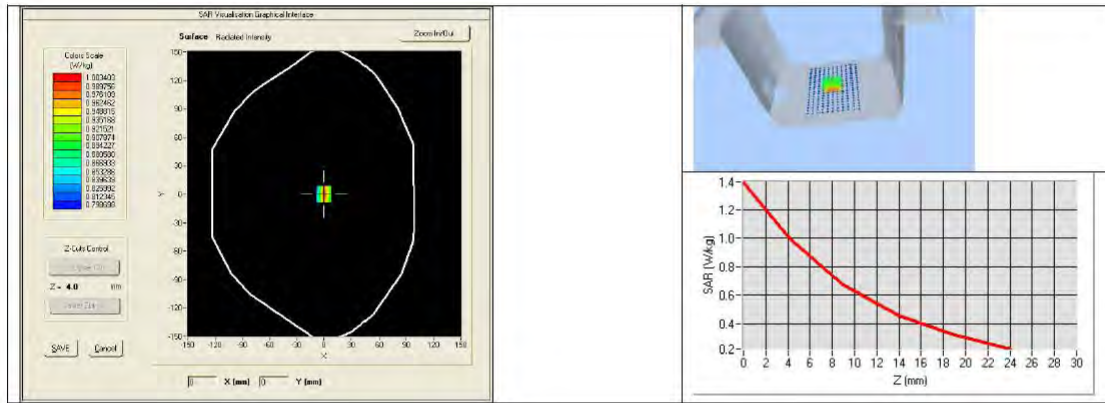

7.3 BODY LIQUID MEASUREMENT

Frequency MHz	Relative permittivity ( $\epsilon_r'$ )		Conductivity ( $\sigma$ ) S/m	
	required	measured	required	measured
150	61.9 ± 5 %		0.80 ± 5 %	
300	58.2 ± 5 %		0.92 ± 5 %	
450	56.7 ± 5 %		0.94 ± 5 %	
750	55.5 ± 5 %		0.96 ± 5 %	
835	55.2 ± 5 %	PASS	0.97 ± 5 %	PASS
900	55.0 ± 5 %		1.05 ± 5 %	
915	55.0 ± 5 %		1.06 ± 5 %	
1450	54.0 ± 5 %		1.30 ± 5 %	
1610	53.8 ± 5 %		1.40 ± 5 %	
1800	53.3 ± 5 %		1.52 ± 5 %	
1900	53.3 ± 5 %		1.52 ± 5 %	
2000	53.3 ± 5 %		1.52 ± 5 %	
2100	53.2 ± 5 %		1.62 ± 5 %	

*This document shall not be reproduced, except in full or in part, without the written approval of MVG. The information contained herein is to be used only for the purpose for which it is submitted and is not to be released in whole or part without written approval of MVG.*





**SAR REFERENCE DIPOLE CALIBRATION REPORT**

Ref: ACR.109.2.18.SATU.A

2300	52.9 ±5 %		1.81 ±5 %
2450	52.7 ±5 %		1.95 ±5 %
2600	52.5 ±5 %		2.16 ±5 %
3000	52.0 ±5 %		2.73 ±5 %
3500	51.3 ±5 %		3.31 ±5 %
3700	51.0 ±5 %		3.55 ±5 %
5200	49.0 ±10 %		5.30 ±10 %
5300	48.9 ±10 %		5.42 ±10 %
5400	48.7 ±10 %		5.53 ±10 %
5500	48.6 ±10 %		5.65 ±10 %
5600	48.5 ±10 %		5.77 ±10 %
5800	48.2 ±10 %		6.00 ±10 %

**7.4 SAR MEASUREMENT RESULT WITH BODY LIQUID**

Software	OPENSAR V4
Phantom	SN 20/09 SAM71
Probe	SN 18/11 EPG122
Liquid	Body Liquid Values: eps' : 57.5 sigma : 0.96
Distance between dipole center and liquid	15.0 mm
Area scan resolution	dx=8mm/dy=8mm
Zoon Scan Resolution	dx=8mm/dy=8mm/dz=5mm
Frequency	835 MHz
Input power	20 dBm
Liquid Temperature	21 °C
Lab Temperature	21 °C
Lab Humidity	45 %

Frequency MHz	1 g SAR (W/kg/W)	10 g SAR (W/kg/W)
	measured	measured
835	9.83 (0.98)	6.45 (0.64)

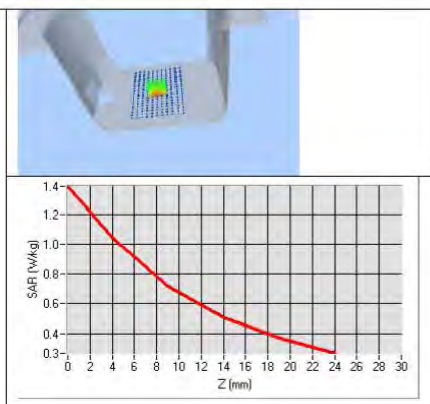
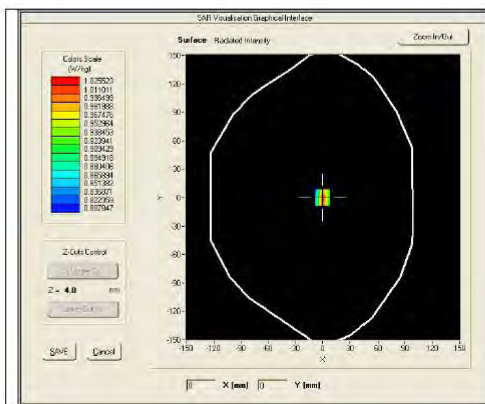



SAR REFERENCE DIPOLE CALIBRATION REPORT

Ref: ACR.109.2.18.SATU.A

**8 LIST OF EQUIPMENT**

Equipment Summary Sheet				
Equipment Description	Manufacturer / Model	Identification No.	Current Calibration Date	Next Calibration Date
SAM Phantom	MVG	SN-20/09-SAM71	Validated. No cal required.	Validated. No cal required.
COMOSAR Test Bench	Version 3	NA	Validated. No cal required.	Validated. No cal required.
Network Analyzer	Rhode & Schwarz ZVA	SN100132	02/2016	02/2019
Calipers	Carrera	CALIPER-01	01/2017	01/2020
Reference Probe	MVG	EPG122 SN 18/11	10/2017	10/2018
Multimeter	Keithley 2000	1188656	01/2017	01/2020
Signal Generator	Agilent E4438C	MY49070581	01/2017	01/2020
Amplifier	Aethercomm	SN 046	Characterized prior to test. No cal required.	Characterized prior to test. No cal required.
Power Meter	HP E4418A	US38261498	01/2017	01/2020
Power Sensor	HP ECP-E26A	US37181460	01/2017	01/2020
Directional Coupler	Narda 4216-20	01386	Characterized prior to test. No cal required.	Characterized prior to test. No cal required.
Temperature and Humidity Sensor	Control Company	150798832	11/2017	11/2020