

FCC RADIO TEST REPORT

FCC ID: 2ANMU-K13PRO

Product: Smart Phone

Trade Mark: OUKITEL

Model No.: K13 Pro

Family Model: N/A

Report No.: S19061203412005

Issue Date: 24 Jul. 2019

Prepared for

SHENZHEN YUNJI INTELLIGENT TECHNOLOGY CO.,LTD
A2 2F BUILDING ENET NEW INDUSTRIAL PARK, DAFU INDUSTRIAL
ZONE, GUANLAN, LONGHUA SHENZHEN, 518XXX China

Prepared by

Shenzhen NTEK Testing Technology Co., Ltd.
1/F, Building E, Fenda Science Park, Sanwei Community,
Xixiang Street Bao'an District, Shenzhen P.R. China
Tel.: +86-755-6115 6588
Fax.: +86-755-6115 6599
Website:<http://www.ntek.org.cn>

TABLE OF CONTENTS

1	TEST RESULT CERTIFICATION	3
2	SUMMARY OF TEST RESULTS.....	4
3	FACILITIES AND ACCREDITATIONS	5
3.1	FACILITIES.....	5
3.2	LABORATORY ACCREDITATIONS AND LISTINGS	5
3.3	MEASUREMENT UNCERTAINTY	5
4	GENERAL DESCRIPTION OF EUT	6
5	DESCRIPTION OF TEST MODES	8
6	SETUP OF EQUIPMENT UNDER TEST	9
6.1	BLOCK DIAGRAM CONFIGURATION OF TEST SYSTEM.....	9
6.2	SUPPORT EQUIPMENT.....	10
6.3	EQUIPMENTS LIST FOR ALL TEST ITEMS.....	11
7	TEST REQUIREMENTS	12
7.1	FIELD STRENGTH OF SPURIOUS RADIATION	12
7.2	EFFECTIVE RADIATED POWER AND EFFECTIVE ISOTROPIC RADIATED POWER.....	24
7.3	CONDUCTED OUTPUT POWER.....	30
7.4	FREQUENCY STABILITY	32
7.5	PEAK-TO-AVERAGE RATIO	39
7.6	26DB BANDWIDTH AND 99% OCCUPIED BANDWIDTH	40
7.7	CONDUCTED BAND EDGE	42
7.8	CONDUCTED SPURIOUS EMISSION AT ANTENNA TERMINAL	43
8	TEST RESULTS	44
8.1	CONDUCTED OUTPUT POWER.....	44
8.2	PEAK-TO-AVERAGE RATIO	47
8.3	OCCUPIED BANDWIDTH	62
8.4	BAND EDGE.....	77
8.5	OUT-OF-BAND EMISSIONS	87

1 TEST RESULT CERTIFICATION

Applicant's name	SHENZHEN YUNJI INTELLIGENT TECHNOLOGY CO.,LTD
Address	A2 2F BUILDING ENET NEW INDUSTRIAL PARK, DAFU INDUSTRIAL ZONE, GUANLAN, LONGHUA SHENZHEN, 518XXX China
Manufacturer's Name	SHENZHEN YUNJI INTELLIGENT TECHNOLOGY CO.,LTD
Address	A2 2F BUILDING ENET NEW INDUSTRIAL PARK, DAFU INDUSTRIAL ZONE, GUANLAN, LONGHUA SHENZHEN, 518XXX China
Product description	
Product name	Smart Phone
Model and/or type reference	K13 Pro
Family Model	N/A

Measurement Procedure Used:

APPLICABLE STANDARDS	
APPLICABLE STANDARD/ TEST PROCEDURE	TEST RESULT
47 CFR Part 2, Part 22H, Part 24E, Part 27L ANSI/TIA-603-E-2016 FCC KDB 971168 D01 Power Meas License Digital Systems v03r01 ANSI C63.26:2015	Complied

This device described above has been tested by Shenzhen NTEK Testing Technology Co., Ltd., and the test results show that the equipment under test (EUT) is in compliance with the FCC requirements. And it is applicable only to the tested sample identified in the report.

This report shall not be reproduced except in full, without the written approval of Shenzhen NTEK Testing Technology Co., Ltd., this document may be altered or revised by Shenzhen NTEK Testing Technology Co., Ltd., personnel only, and shall be noted in the revision of the document.

The test results of this report relate only to the tested sample identified in this report.

Date of Test : Jun. 13, 2019 ~ Jul. 23, 2019

Testing Engineer : *Allen Liu*
(Allen Liu)

Technical Manager : *Jason Chen*
(Jason Chen)

Authorized Signatory : *Sam. Chen*
(Sam Chen)

2 SUMMARY OF TEST RESULTS

FCC Part22, Subpart H/ FCC Part24, Subpart E, FCC Part27, Subpart L, KDB 971168 D01 Power Meas License Digital Systems v03r01			
FCC Rule	Test Item	Verdict	Remark
2.1046	Conducted Output Power	PASS	
24.232(d) KDB 971168 D01 Clause 5.7	Peak-to-Average Ratio	PASS	
2.1049 22.917(b) 24.238(b) KDB 971168 D01 Clause 4.2	Occupied Bandwidth	PASS	
2.1051 22.917(a) 24.238(a) KDB 971168 D01 Clause 6	Band Edge	PASS	
22.913(a)(2) KDB 971168 D01 Clause 5.6	Effective Radiated Power	PASS	
24.232(c) KDB 971168 D01 Clause 5.6	Equivalent Isotropic Radiated Power	PASS	
2.1053 22.917(a) 24.238(a) KDB 971168 D01 Clause 7	Field Strength of Spurious Radiation	PASS	
2.1055 22.355 24.235 KDB 971168 D01 Clause 9	Frequency Stability for Temperature & Voltage	PASS	
2.1051 22.917(a) 24.238(a) KDB 971168 D01 Clause 6	Conducted Emission	PASS	

Remark:

1. "N/A" denotes test is not applicable in this Test Report.
2. All test items were verified and recorded according to the standards and without any deviation during the test.
3. No modifications are made to the EUT during all test items.

3 FACILITIES AND ACCREDITATIONS

3.1 FACILITIES

All measurement facilities used to collect the measurement data are located at 1/F, Building E, Fenda Science Park, Sanwei Community, Xixiang Street, Bao'an District, Shenzhen 518126 P.R. China.

The sites are constructed in conformance with the requirements of ANSI C63.7, ANSI C63.10 and CISPR Publication 22.

3.2 LABORATORY ACCREDITATIONS AND LISTINGS

Site Description

CNAS-Lab. : The Laboratory has been assessed and proved to be in compliance with CNAS-CL01:2006 (identical to ISO/IEC 17025:2005)
The Certificate Registration Number is L5516.

IC-Registration : The Certificate Registration Number is 9270A.
CAB identifier:CN0074

FCC- Accredited : Test Firm Registration Number: 463705.
Designation Number: CN1184

A2LA-Lab. : The Certificate Registration Number is 4298.01
This laboratory is accredited in accordance with the recognized International Standard ISO/IEC 17025:2005 General requirements for the competence of testing and calibration laboratories.
This accreditation demonstrates technical competence for a defined scope and the operation of a laboratory quality management system (refer to joint ISO-ILAC-IAF Communiqué dated 8 January 2009).

Name of Firm : Shenzhen NTEK Testing Technology Co., Ltd.

Site Location : 1/F, Building E, Fenda Science Park, Sanwei Community, Xixiang Street, Bao'an District, Shenzhen 518126 P.R. China.

3.3 MEASUREMENT UNCERTAINTY

The reported uncertainty of measurement, where expanded uncertainty U is based on a standard uncertainty multiplied by a coverage factor of k=2, providing a level of confidence of approximately 95 %.

No.	Item	Uncertainty
1	Measuring Uncertainty for a Level of Confidence of 95% (U = 2Uc(y))	2.5dB

4 GENERAL DESCRIPTION OF EUT

Product Feature and Specification	
Equipment	Smart Phone
Trade Mark	OUKITEL
FCC ID	2ANMU-K13PRO
Model No.	K13 Pro
Family Model	N/A
Model Difference	N/A
Operating Frequency	<input checked="" type="checkbox"/> GSM850: TX824.2MHz~848.8MHz /RX869.2MHz~893.8MHz; <input checked="" type="checkbox"/> UMTS FDD Band V: TX826.4MHz~846.6MHz /RX871.4MHz~891.6MHz; <input checked="" type="checkbox"/> PCS1900: TX1850.2MHz~1909.8MHz /RX1930.2MHz~1989.8MHz; <input checked="" type="checkbox"/> UMTS FDD Band II: TX1852.4MHz~1907.6MHz /RX1932.4MHz~1987.6MHz; <input checked="" type="checkbox"/> UMTS-FDD Band IV:TX1710MHz~1755MHz /RX2110MHz~2155MHz
Modulation	<input checked="" type="checkbox"/> GMSK for GSM/GPRS; <input checked="" type="checkbox"/> 8PSK for EGPRS; <input checked="" type="checkbox"/> QPSK for UMTS bands;
GPRS Class	<input checked="" type="checkbox"/> Multi-Class12 <input checked="" type="checkbox"/> Only 4 timeslots are used for GPRS
SIM CARD	SIM 1 and SIM 2 is a chipset unit and tested as a single chipset. The SIM 1 is chosen for test.
Antenna Type	FPC Antenna
Antenna Gain	1.5dBi
Power supply	<input checked="" type="checkbox"/> DC supply: DC 3.85V/10100mAh from battery or DC 5V from USB port.
	<input checked="" type="checkbox"/> Adapter supply: Model: HJ-050600K9-US Input: 100-240V~50/60Hz 0.8A Output: 5V---6.0A
HW Version	HCT-M861MB-B1
SW Version	OUKITEL_K13_Pro_EEA_V09_20190614

Note: Based on the application, features, or specification exhibited in User's Manual, the EUT is considered as an ITE/Computing Device. More details of EUT technical specification, please refer to the User's Manual. The High Voltage 4.4V and Low Voltage 3.4V was declared by manufacturer, The EUT couldn't be operate normally with higher or lower voltage.

Revision History

Report No.	Version	Description	Issued Date
S19061203412005	Rev.01	Initial issue of report	Jul 24, 2019

5 DESCRIPTION OF TEST MODES

During the testing, the EUT was controlled via Rhode & Schwarz Digital Radio Communication Tester(CMU 200) to ensure max power transmission and proper modulation. Three channels (The low channel, the middle channel and the high channel) were chosen for testing on all frequency band.

Note: GSM/GPRS/EGPRS 850, GSM/GPRS/EGPRS 1900, HSDPA band II, HSUPA band II, HSDPA band V, HSUPA band V, HSDPA band IV, HSUPA band IV modes have been tested during the test. the worst condition (GSM850, GSM1900, RMC 12.2k) be recorded in the test report if no other modes test data.

Antenna port conducted and radiated test items were performed according to KDB 971168 D01 Power Meas. License Digital Systems v03r01 with maximum output power.

Radiated measurements were performed with rotating EUT in different three orthogonal test planes to find the maximum emission.

Radiated emissions were investigated as following frequency range:

1. 30 MHz to 10th harmonic for GSM850/UMTS FDD Band V/ UMTS FDD Band IV .
2. 30 MHz to 10th harmonic for GSM1900/UMTS FDD Band II.

All modes and data rates and positions were investigated.

Test modes are chosen to be reported as the worst case configuration below:

Test Modes		
Band	For Conducted Test Cases	For Radiated Test Cases
GSM 850	GSM Link	GSM Link
GSM 1900	GSM Link	GSM Link
UMTS Band II	RMC 12.2Kbps Link	RMC 12.2Kbps Link
UMTS Band V	RMC 12.2Kbps Link	RMC 12.2Kbps Link
UMTS Band IV	RMC 12.2Kbps Link	RMC 12.2Kbps Link

Test Frequency and Channels:

Frequency Band	<input checked="" type="checkbox"/> GSM 850		<input checked="" type="checkbox"/> GSM 1900		<input checked="" type="checkbox"/> UMTS Band II		<input checked="" type="checkbox"/> UMTS Band V	
	Channel	Frequency (MHz)	Channel	Frequency (MHz)	Channel	Frequency (MHz)	Channel	Frequency (MHz)
CH_H	251	848.8	810	1909.8	9538	1907.6	4233	846.6
CH_M	190	836.6	661	1880.0	9400	1880.0	4183	836.6
CH_L	128	824.2	512	1850.2	9262	1852.4	4132	826.4

Frequency Band	<input checked="" type="checkbox"/> UMTS Band IV	
	Channel	Frequency (MHz)
CH_H	1513	1752.6
CH_M	1412	1732.6
CH_L	1312	1712.4

6 SETUP OF EQUIPMENT UNDER TEST

6.1 BLOCK DIAGRAM CONFIGURATION OF TEST SYSTEM

For Radiated Test Cases



For Conducted Output Power

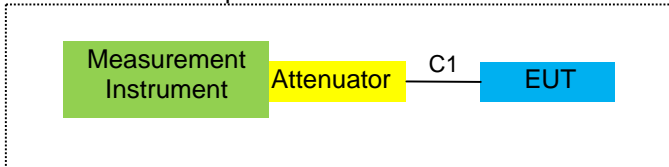

For Peak-to Average Ratio, Occupied Bandwidth, Conducted Band edge and Conducted Spurious Emission

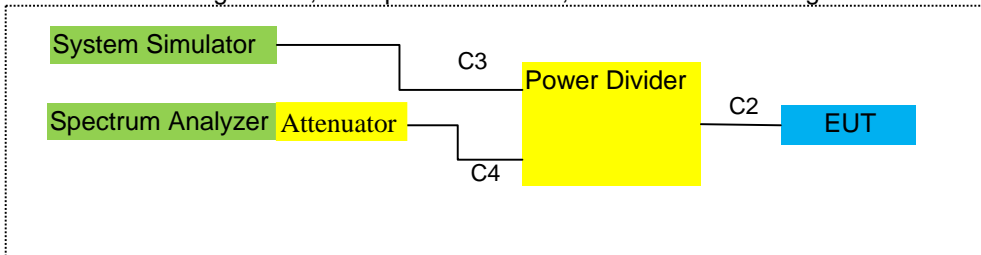

For Frequency Stability

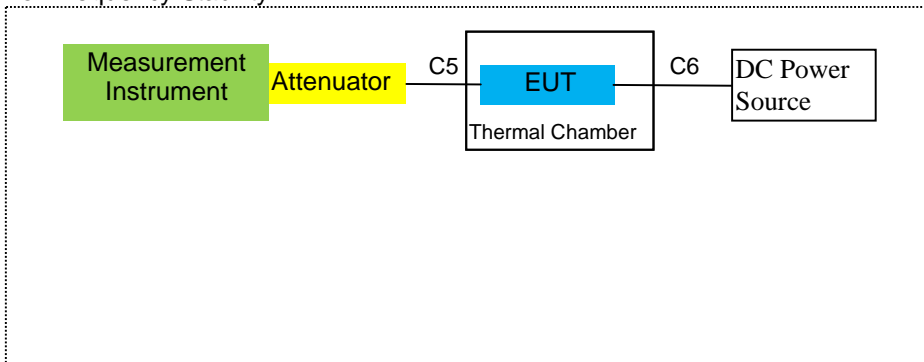

6.2 SUPPORT EQUIPMENT

The EUT has been tested as an independent unit together with other necessary accessories or support units. The following support units or accessories were used to form a representative test configuration during the tests.

Item	Equipment	Mfr/Brand	Model/Type No.	Series No.	Note

Item	Cable Type	Shielded Type	Ferrite Core	Length
C-1	RF Cable	YES	NO	0.1m
C-2	RF Cable	YES	NO	0.1m
C-3	RF Cable	YES	NO	0.1m
C-4	RF Cable	YES	NO	0.2m
C-5	RF Cable	YES	NO	0.2m
C-6	DC Cable	NO	NO	1.0m

Notes:

- (1) The support equipment was authorized by Declaration of Confirmation.
- (2) For detachable type I/O cable should be specified the length in cm in 『Length』 column.
- (3) “YES” is means “shielded” “with core”; “NO” is means “unshielded” “without core”.

6.3 EQUIPMENTS LIST FOR ALL TEST ITEMS

Item	Kind of Equipment	Manufacturer	Type No.	Serial No.	Last calibration	Calibrated until	Calibration period
1	MXA Signal Analyzer	Agilent	N9020A	MY49100060	2018.10.08	2019.10.07	1 year
2	Test Receiver	R&S	ESPI	101318	2019.05.13	2020.05.12	1 year
3	Bilog Antenna	TESEQ	CBL6111D	31216	2019.04.15	2020.04.14	1 year
4	50Ω Coaxial Switch	Anritsu	MP59B	6200983705	2018.05.19	2020.05.18	2 year
5	Horn Antenna	EM	EM-AH-1018 0	2011071402	2019.05.13	2020.05.12	1 year
6	Horn Ant	Schwarzbeck	BBHA 9170	9170-181	2019.04.15	2020.04.14	1 year
7	Amplifier	EM	EM-30180	060538	2018.08.05	2019.08.04	1 year
8	Loop Antenna	ARA	PLA-1030/B	1029	2019.05.13	2020.05.12	1 year
9	Power Meter	R&S	NRVS	100696	2018.08.05	2019.08.04	1 year
10	Power Sensor	R&S	URV5-Z4	0395.1619.0 5	2019.05.13	2020.05.12	1 year
11	Test Cable	N/A	R-01	N/A	2017.04.21	2020.04.20	3 year
12	Test Cable	N/A	R-02	N/A	2017.04.21	2020.04.20	3 year
13	Test Cable	N/A	R-03	N/A	2017.04.21	2020.04.20	3 year
14	Test Receiver	R&S	ESCI	101160	2019.05.13	2020.05.12	1 year
15	LISN	R&S	ENV216	101313	2019.04.15	2020.04.14	1 year
16	LISN	EMCO	3816/2	00042990	2019.05.13	2020.05.12	1 year
17	50Ω Coaxial Switch	Anritsu	MP59B	6200264417	2019.05.13	2020.05.12	1 year
18	Passive Voltage Probe	R&S	ESH2-Z3	100196	2017.04.21	2020.04.20	3 year
19	Test Cable	N/A	C01	N/A	2017.04.21	2020.04.20	3 year
20	Test Cable	N/A	C02	N/A	2017.04.21	2020.04.20	3 year
21	Test Cable	N/A	C03	N/A	2019.04.15	2020.04.14	1 year
22	Attenuator	MCE	24-10-34	BN9258	2019.04.15	2020.04.14	1 year
23	Spectrum Analyzer	agilent	e4440a	us44300399	2019.05.13	2020.05.12	1 year
24	test receiver	R&S	ESCI	a0304218	2019.05.13	2020.05.12	1 year
25	Communication Tester	R&S	CMU200	A0304247	2018.08.05	2019.08.04	1 year
26	Thermal Chamber	Ten Billion	TTC-B3C	TBN-960502	2019.05.13	2020.05.12	1 year
27	DC Power Source	N/A	PS-6005D	2017040292 3	2017.06.06	2020.06.05	3 year

Note: Each piece of equipment is scheduled for calibration once a year except the Test Cable& DC Power Source which is scheduled for calibration every 3 years.

7 TEST REQUIREMENTS

7.1 FIELD STRENGTH OF SPURIOUS RADIATION

7.1.1 Applicable Standard

According to FCC KDB 971168 D01 v03r01 Section 5.8 and ANSI/TIA-603-E-2016 Section 2.2.12

7.1.2 Conformance Limit

The power of any emission outside of the authorized operating frequency ranges must be attenuated below the transmitter power (P) by a factor of at least $43 + 10 \log (P)$ dB. The spectrum is scanned from 30 MHz up to a frequency including its 10th harmonic.

7.1.3 Measuring Instruments

The Measuring equipment is listed in the section 6.3 of this test report.

7.1.4 Test Configuration

According to the ANSI/TIA-603-E-2016 test method, The Receiver or Spectrum was scanned from 9 KHz to the 10th harmonic of the highest frequency generated within the equipment, which is the transmitted carrier that can be as high as 1910 MHz The resolution bandwidth is set as outlined in Part 24.238, Part 22.917. The spectrum is scanned with the mobile station transmitting at carrier frequencies that pertain to low, mid and high channels of WCDMA Band II / WCDMA Band V / WCDMA Band IV / GSM 850/ GSM 1900.

TEST CONFIGURATION

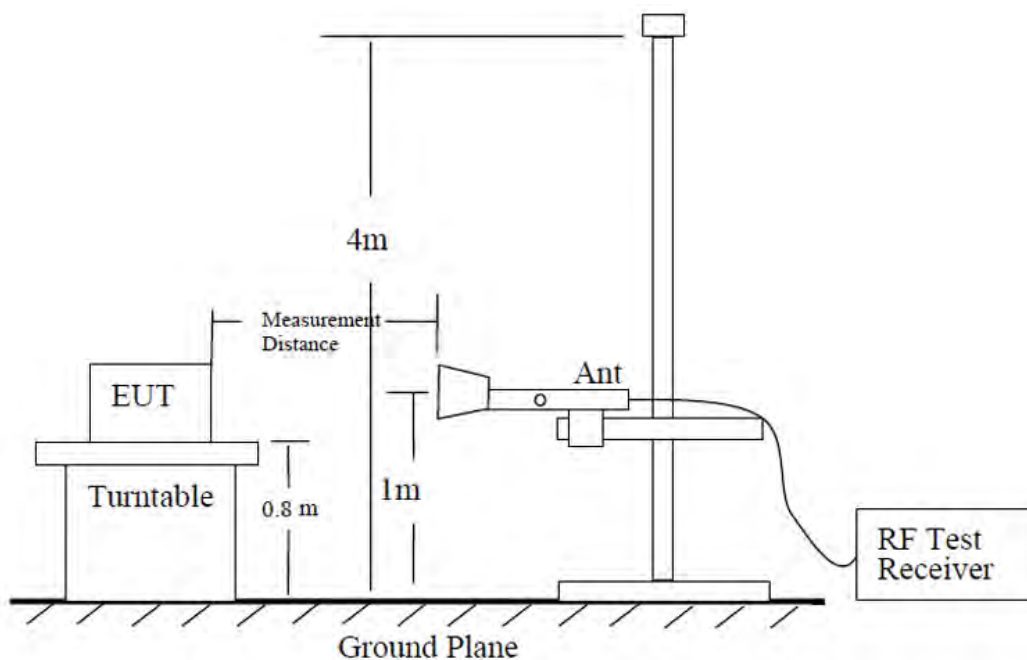

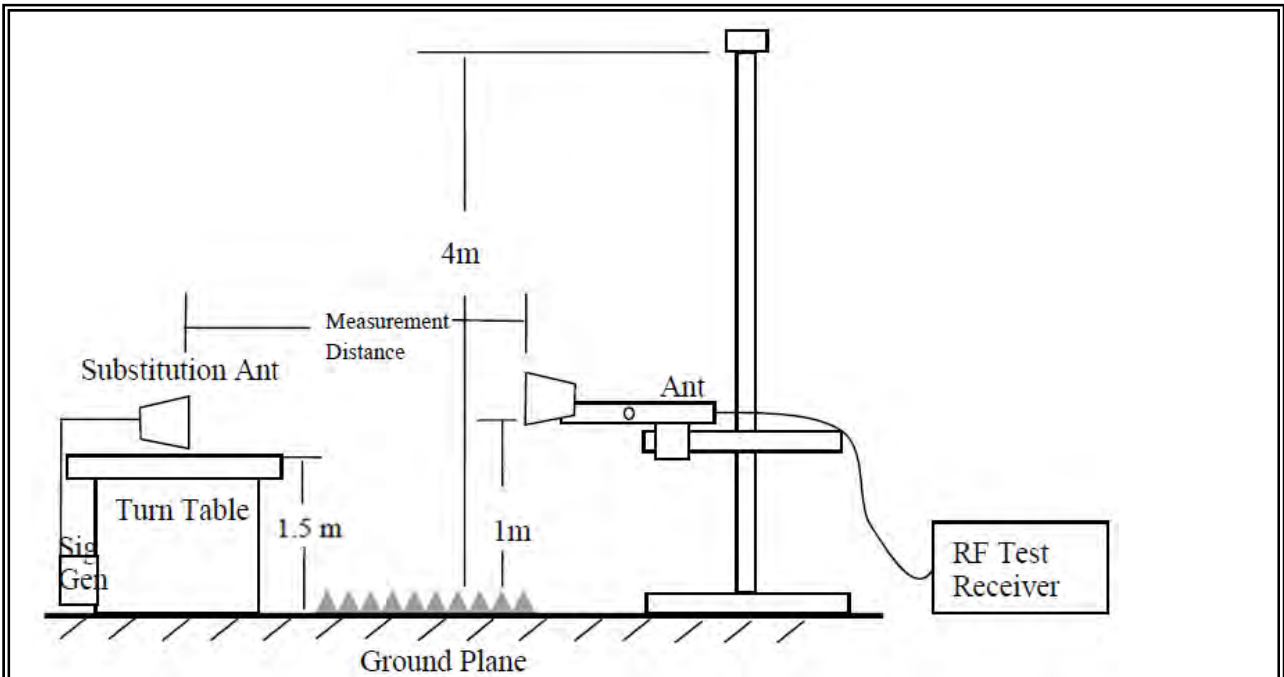

7.1.5 Test Procedure

1. EUT was placed on a 0.8 meter (For frequency above 1G, EUT should be placed on 1.5m) high non-conductive stand at a 3 meter test distance from the receive antenna. A receiving antenna was placed on the antenna mast 3 meters from the EUT for emission measurements. The height of receiving antenna is 1.50 meter. Detected emissions were maximized at each frequency by rotating the EUT through 360° and adjusting the receiving antenna polarization. The radiated emission measurements of all transmit frequencies in three channels (High, Middle, Low) were measured with peak detector.
2. A log-periodic antenna or double-ridged waveguide horn antenna shall be substituted in place of the EUT. The log-periodic antenna will be driven by a signal generator and the level will be adjusted till the same power value on the spectrum analyzer or receiver. The level of the spurious emissions can be calculated through the level of the signal generator, cable loss, the gain of the substitution antenna and the reading of the spectrum analyzer or receiver.
3. The EUT is then put into continuously transmitting mode at its maximum power level during the test. Set Test Receiver or Spectrum RBW=1MHz, VBW=3MHz, And the maximum value of the receiver should be recorded as (P_r).
4. The EUT shall be replaced by a substitution antenna. In the chamber, an substitution antenna for the frequency band of interest is placed at the reference point of the chamber. An RF Signal source for the frequency band of interest is connected to the substitution antenna with a cable that has been constructed to not interfere with the radiation pattern of the antenna. A power (SG Level) is applied to the input of the substitution antenna, and adjust the level of the signal generator output until the value of the receiver reach the previously recorded (P_r). The power of signal source (SG Level) is recorded. The test should be performed by rotating the test item and adjusting the receiving antenna polarization.
5. A amplifier should be connected to the Signal Source output port. And the cable should be connect between the Amplifier and the Substitution Antenna. The cable loss (Cable Loss), the Substitution Antenna Gain should be recorded after test.
The measurement results are obtained as described below:
Power(EIRP)= SG Level- Cable Loss+ Antenna Gain
6. This value is EIRP since the measurement is calibrated using an antenna of known gain (2.15 dBi) and known input power.
7. ERP can be calculated from EIRP by subtracting the gain of the dipole, ERP = EIRP -2.15dBi.

7.1.6 Test Results

EUT:	Smart Phone	Model No.:	K13 Pro
Temperature:	20 °C	Relative Humidity:	48%
Test Mode:	GSM/GPRS/EGPRS 850/ GSM/GPRS/EGPRS 1900 UMTS band II/ UMTS band V/ UMTS band IV	Test By:	Allen Liu

■ Radiated Spurious Emission

Below 1GHz:

GSM 850							
Frequency	SG Level	Cable Loss	Antenna Gain	Absolute Level	Limit	Over Limit	Polarity
(MHz)	(dBm)	(dB)	(dB)	(dBm)	(dBm)	(dBm)	
Test Results for Channel 128/824.2 MHz							
41.87	-61.31	1.81	18.11	-45.01	-13	-32.01	Vertical
98.81	-71.78	1.81	19.20	-54.39	-13	-41.39	Vertical
216.84	-74.41	1.82	19.31	-56.92	-13	-43.92	Vertical
35.05	-73.57	1.81	18.11	-57.27	-13	-44.27	Horizontal
114.35	-64.08	1.82	19.22	-46.68	-13	-33.68	Horizontal
218.55	-70.43	1.82	19.22	-53.03	-13	-40.03	Horizontal
Test Results for Channel 190/836.6 MHz							
38.15	-60.45	1.81	18.11	-44.15	-13	-31.15	Vertical
103.33	-70.35	1.81	19.20	-52.96	-13	-39.96	Vertical
177.20	-67.28	1.82	19.22	-49.88	-13	-36.88	Vertical
46.44	-61.06	1.81	18.11	-44.76	-13	-31.76	Horizontal
98.95	-73.05	1.81	19.20	-55.66	-13	-42.66	Horizontal
207.22	-71.93	1.81	19.24	-54.50	-13	-41.50	Horizontal
Test Results for Channel 251/848.8 MHz							
38.70	-59.57	1.81	18.11	-43.27	-13	-30.27	Vertical
151.67	-64.08	1.82	19.22	-46.68	-13	-33.68	Horizontal
464.26	-80.43	1.83	19.25	-63.01	-13	-50.01	Vertical
42.75	-62.53	1.81	18.11	-46.23	-13	-33.23	Horizontal
169.69	-73.65	1.82	19.22	-56.25	-13	-43.25	Vertical
551.29	-75.62	1.83	19.25	-58.20	-13	-45.20	Horizontal

Note:

1. Pre-test tests all modes, only the worst mode data is recorded in the report
2. All other emissions more than 20dB below the limit.

■ Radiated Spurious Emission
Above 1G:

GSM 850							
Frequency	SG Level	Cable Loss	Antenna Gain	Absolute Level	Limit	Over Limit	Polarity
(MHz)	(dBm)	(dB)	(dB)	(dBm)	(dBm)	(dBm)	
Test Results for Channel 128/824.2 MHz							
1648.4	-49.07	2.80	27.50	-24.37	-13	-11.37	Vertical
1648.4	-45.92	2.80	27.50	-21.22	-13	-8.22	Horizontal
2472.6	-46.58	2.91	27.80	-21.69	-13	-8.69	Vertical
2472.6	-49.29	2.91	27.80	-24.40	-13	-11.40	Horizontal
3296.8	-46.58	4.02	29.87	-20.73	-13	-7.73	Vertical
3296.8	-48.78	4.02	29.87	-22.93	-13	-9.93	Horizontal
Test Results for Channel 190/836.6 MHz							
1673.2	-44.76	2.80	27.48	-20.08	-13	-7.08	Vertical
1673.2	-44.73	2.80	27.48	-20.05	-13	-7.05	Horizontal
2509.8	-51.11	2.91	27.70	-26.32	-13	-13.32	Vertical
2509.8	-49.08	2.91	27.70	-24.29	-13	-11.29	Horizontal
3346.4	-46.21	4.02	29.82	-20.41	-13	-7.41	Vertical
3346.4	-49.97	4.02	29.82	-24.17	-13	-11.17	Horizontal
Test Results for Channel 251/848.8 MHz							
1697.6	-47.42	2.80	27.42	-22.80	-13	-9.80	Vertical
1697.6	-47.93	2.80	27.42	-23.31	-13	-10.31	Horizontal
2546.4	-50.15	2.91	27.68	-25.38	-13	-12.38	Vertical
2546.4	-43.71	2.91	27.68	-18.94	-13	-5.94	Horizontal
3395.2	-44.13	4.02	29.80	-18.35	-13	-5.35	Vertical
3395.2	-47.17	4.02	29.80	-21.39	-13	-8.39	Horizontal

Remark:

1. We were tested all Configuration refer 3GPP TS134 121.
2. Absolute Level = SG Level- Cable Loss+ Antenna Gain
3. Over Limit= Absolute Level (dBm)-Limit(dBm)

GPRS 850							
Frequency	SG Level	Cable Loss	Antenna Gain	Absolute Level	Limit	Over Limit	Polarity
(MHz)	(dBm)	(dB)	(dB)	(dBm)	(dBm)	(dBm)	
Test Results for Channel 128/824.2 MHz							
1648.4	-43.70	2.80	27.50	-19.00	-13	-6.00	Vertical
1648.4	-42.08	2.80	27.50	-17.38	-13	-4.38	Horizontal
2472.6	-50.89	2.91	27.80	-26.00	-13	-13.00	Vertical
2472.6	-47.29	2.91	27.80	-22.40	-13	-9.40	Horizontal
3296.8	-50.35	4.02	29.87	-24.50	-13	-11.50	Vertical
3296.8	-44.48	4.02	29.87	-18.63	-13	-5.63	Horizontal
Test Results for Channel 190/836.6 MHz							
1673.2	-52.53	2.80	27.48	-27.85	-13	-14.85	Vertical
1673.2	-45.04	2.80	27.48	-20.36	-13	-7.36	Horizontal
2509.8	-52.43	2.91	27.70	-27.64	-13	-14.64	Vertical
2509.8	-46.42	2.91	27.70	-21.63	-13	-8.63	Horizontal
3346.4	-43.41	4.02	29.82	-17.61	-13	-4.61	Vertical
3346.4	-51.30	4.02	29.82	-25.50	-13	-12.50	Horizontal
Test Results for Channel 251/848.8 MHz							
1697.6	-49.74	2.80	27.42	-25.12	-13	-12.12	Vertical
1697.6	-46.39	2.80	27.42	-21.77	-13	-8.77	Horizontal
2546.4	-42.37	2.91	27.68	-17.60	-13	-4.60	Vertical
2546.4	-48.78	2.91	27.68	-24.01	-13	-11.01	Horizontal
3395.2	-47.74	4.02	29.80	-21.96	-13	-8.96	Vertical
3395.2	-50.55	4.02	29.80	-24.77	-13	-11.77	Horizontal

Remark:

1. We were tested all Configuration refer 3GPP TS134 121.
2. Absolute Level = SG Level- Cable Loss+ Antenna Gain
3. Over Limit= Absolute Level (dBm)-Limit(dBm)

EGPRS 850							
Frequency	SG Level	Cable Loss	Antenna Gain	Absolute Level	Limit	Over Limit	Polarity
(MHz)	(dBm)	(dB)	(dB)	(dBm)	(dBm)	(dBm)	
Test Results for Channel 128/824.2 MHz							
1648.4	-50.70	2.80	27.50	-26.00	-13	-13.00	Vertical
1648.4	-46.75	2.80	27.50	-22.05	-13	-9.05	Horizontal
2472.6	-53.87	2.91	27.80	-28.98	-13	-15.98	Vertical
2472.6	-48.01	2.91	27.80	-23.12	-13	-10.12	Horizontal
3296.8	-50.84	4.02	29.87	-24.99	-13	-11.99	Vertical
3296.8	-44.95	4.02	29.87	-19.10	-13	-6.10	Horizontal
Test Results for Channel 190/836.6 MHz							
1673.2	-50.09	2.80	27.48	-25.41	-13	-12.41	Vertical
1673.2	-49.41	2.80	27.48	-24.73	-13	-11.73	Horizontal
2509.8	-51.60	2.91	27.70	-26.81	-13	-13.81	Vertical
2509.8	-48.66	2.91	27.70	-23.87	-13	-10.87	Horizontal
3346.4	-48.76	4.02	29.82	-22.96	-13	-9.96	Vertical
3346.4	-45.73	4.02	29.82	-19.93	-13	-6.93	Horizontal
Test Results for Channel 251/848.8 MHz							
1697.6	-46.37	2.80	27.42	-21.75	-13	-8.75	Vertical
1697.6	-43.94	2.80	27.42	-19.32	-13	-6.32	Horizontal
2546.4	-52.42	2.91	27.68	-27.65	-13	-14.65	Vertical
2546.4	-47.45	2.91	27.68	-22.68	-13	-9.68	Horizontal
3395.2	-46.63	4.02	29.80	-20.85	-13	-7.85	Vertical
3395.2	-45.48	4.02	29.80	-19.70	-13	-6.70	Horizontal

Remark:

1. We were tested all Configuration refer 3GPP TS134 121.
2. Absolute Level = SG Level- Cable Loss+ Antenna Gain
3. Over Limit= Absolute Level (dBm)-Limit(dBm)

GSM 1900							
Frequency	SG Level	Cable Loss	Antenna Factor	Absolute Level	Limit	Over Limit	Polarity
(MHz)	(dBm)	(dB)	(dB)	(dBm)	(dBm)	(dBm)	
Test Results for Channel 512/1850.2MHz							
3700.4	-47.65	4.04	33.51	-18.18	-13	-5.18	Vertical
3700.4	-54.45	4.04	33.51	-24.98	-13	-11.98	Horizontal
5550.6	-56.11	5.24	35.84	-25.51	-13	-12.51	Vertical
5550.6	-52.90	5.24	35.84	-22.30	-13	-9.30	Horizontal
Test Results for Channel 661/1880.0MHz							
3760	-52.15	4.04	33.56	-22.63	-13	-9.63	Vertical
3760	-46.32	4.04	33.56	-16.80	-13	-3.80	Horizontal
5640	-56.69	5.24	35.91	-26.02	-13	-13.02	Vertical
5640	-54.50	5.24	35.91	-23.83	-13	-10.83	Horizontal
Test Results for Channel 810/1909.8MHz							
3819.6	-53.50	4.04	34.00	-23.54	-13	-10.54	Vertical
3819.6	-56.53	4.04	34.00	-26.57	-13	-13.57	Horizontal
5729.4	-52.48	5.24	36.04	-21.68	-13	-8.68	Vertical
5729.4	-54.55	5.24	36.04	-23.75	-13	-10.75	Horizontal

Remark:

1. We were tested all Configuration refer 3GPP TS134 121.
2. Absolute Level = SG Level- Cable Loss+ Antenna Gain
3. Over Limit= Absolute Level (dBm)-Limit(dBm)

GPRS 1900							
Frequency	SG Level	Cable Loss	Antenna Factor	Absolute Level	Limit	Over Limit	Polarity
(MHz)	(dBm)	(dB)	(dB)	(dBm)	(dBm)	(dBm)	
Test Results for Channel 512/1850.2MHz							
3700.4	-55.65	4.04	33.51	-26.18	-13	-13.18	Vertical
3700.4	-56.42	4.04	33.51	-26.95	-13	-13.95	Horizontal
5550.6	-48.42	5.24	35.84	-17.82	-13	-4.82	Vertical
5550.6	-53.58	5.24	35.84	-22.98	-13	-9.98	Horizontal
Test Results for Channel 661/1880.0MHz							
3760	-47.07	4.04	33.56	-17.55	-13	-4.55	Vertical
3760	-50.61	4.04	33.56	-21.09	-13	-8.09	Horizontal
5640	-56.28	5.24	35.91	-25.61	-13	-12.61	Vertical
5640	-50.23	5.24	35.91	-19.56	-13	-6.56	Horizontal
Test Results for Channel 810/1909.8MHz							
3819.6	-50.75	4.04	34.00	-20.79	-13	-7.79	Vertical
3819.6	-48.38	4.04	34.00	-18.42	-13	-5.42	Horizontal
5729.4	-48.85	5.24	36.04	-18.05	-13	-5.05	Vertical
5729.4	-49.45	5.24	36.04	-18.65	-13	-5.65	Horizontal

Remark:

1. We were tested all Configuration refer 3GPP TS134 121.
2. Absolute Level = SG Level- Cable Loss+ Antenna Gain
3. Over Limit= Absolute Level (dBm)-Limit(dBm)

EGPRS 1900							
Frequency	SG Level	Cable Loss	Antenna Factor	Absolute Level	Limit	Over Limit	Polarity
(MHz)	(dBm)	(dB)	(dB)	(dBm)	(dBm)	(dBm)	
Test Results for Channel 512/1850.2MHz							
3700.4	-45.31	4.04	33.51	-15.84	-13	-2.84	Vertical
3700.4	-48.50	4.04	33.51	-19.03	-13	-6.03	Horizontal
5550.6	-47.82	5.24	35.84	-17.22	-13	-4.22	Vertical
5550.6	-47.62	5.24	35.84	-17.02	-13	-4.02	Horizontal
Test Results for Channel 661/1880.0MHz							
3760	-47.61	4.04	33.56	-18.09	-13	-5.09	Vertical
3760	-48.88	4.04	33.56	-19.36	-13	-6.36	Horizontal
5640	-47.76	5.24	35.91	-17.09	-13	-4.09	Vertical
5640	-47.58	5.24	35.91	-16.91	-13	-3.91	Horizontal
Test Results for Channel 810/1909.8MHz							
3819.6	-52.52	4.04	34.00	-22.56	-13	-9.56	Vertical
3819.6	-48.92	4.04	34.00	-18.96	-13	-5.96	Horizontal
5729.4	-54.95	5.24	36.04	-24.15	-13	-11.15	Vertical
5729.4	-49.21	5.24	36.04	-18.41	-13	-5.41	Horizontal

Remark:

1. We were tested all Configuration refer 3GPP TS134 121.
2. Absolute Level = SG Level- Cable Loss+ Antenna Gain
3. Over Limit= Absolute Level (dBm)-Limit(dBm)

WCDMA Band II							
Frequency	SG Level	Cable Loss	Antenna Factor	Absolute Level	Limit	Over Limit	Polarity
(MHz)	(dBm)	(dB)	(dB)	(dBm)	(dBm)	(dBm)	
Test Results for Channel 9262/1852.4MHz							
3704.8	-56.78	4.04	33.51	-27.31	-13	-14.31	Vertical
3704.8	-49.21	4.04	33.51	-19.74	-13	-6.74	Horizontal
5557.2	-53.34	5.24	35.84	-22.74	-13	-9.74	Vertical
5557.2	-47.22	5.24	35.84	-16.62	-13	-3.62	Horizontal
Test Results for Channel 9400/1880MHz							
3760	-49.12	4.04	33.56	-19.60	-13	-6.60	Vertical
3760	-56.65	4.04	33.56	-27.13	-13	-14.13	Horizontal
5640	-51.64	5.24	35.91	-20.97	-13	-7.97	Vertical
5640	-51.42	5.24	35.91	-20.75	-13	-7.75	Horizontal
Test Results for Channel 9538/1907.6MHz							
3815.2	-47.34	4.04	34.00	-17.38	-13	-4.38	Vertical
3815.2	-48.62	4.04	34.00	-18.66	-13	-5.66	Horizontal
5722.8	-56.15	5.24	36.04	-25.35	-13	-12.35	Vertical
5722.8	-56.23	5.24	36.04	-25.43	-13	-12.43	Horizontal

Remark:

1. We were tested all Configuration refer 3GPP TS134 121.
2. Absolute Level = SG Level- Cable Loss+ Antenna Gain
3. Over Limit= Absolute Level (dBm)-Limit(dBm)

WCDMA Band V							
Frequency	SG Level	Cable Loss	Antenna Gain	Absolute Level	Limit	Over Limit	Polarity
(MHz)	(dBm)	(dB)	(dB)	(dBm)	(dBm)	(dBm)	
Test Results for Channel 4233/846.6MHz							
1693.2	-46.87	2.80	27.50	-22.17	-13	-9.17	Vertical
1693.2	-50.64	2.80	27.50	-25.94	-13	-12.94	Horizontal
2539.8	-46.75	2.91	27.80	-21.86	-13	-8.86	Vertical
2539.8	-42.43	2.91	27.80	-17.54	-13	-4.54	Horizontal
3386.4	-48.56	4.02	29.87	-22.71	-13	-9.71	Vertical
3386.4	-48.57	4.02	29.87	-22.72	-13	-9.72	Horizontal
Test Results for Channel 4182/836.4MHz							
1672.8	-44.20	2.80	27.48	-19.52	-13	-6.52	Vertical
1672.8	-41.27	2.80	27.48	-16.59	-13	-3.59	Horizontal
2509.2	-48.95	2.91	27.70	-24.16	-13	-11.16	Vertical
2509.2	-41.96	2.91	27.70	-17.17	-13	-4.17	Horizontal
3345.6	-46.66	4.02	29.82	-20.86	-13	-7.86	Vertical
3345.6	-48.99	4.02	29.82	-23.19	-13	-10.19	Horizontal
Test Results for Channel 4132/826.4MHz							
1652.8	-44.11	2.80	27.42	-19.49	-13	-6.49	Vertical
1652.8	-44.79	2.80	27.42	-20.17	-13	-7.17	Horizontal
2479.2	-48.92	2.91	27.68	-24.15	-13	-11.15	Vertical
2479.2	-43.90	2.91	27.68	-19.13	-13	-6.13	Horizontal
3305.6	-47.59	4.02	29.80	-21.81	-13	-8.81	Vertical
3305.6	-49.79	4.02	29.80	-24.01	-13	-11.01	Horizontal

Remark:

1. We were tested all Configuration refer 3GPP TS134 121.
2. Absolute Level = SG Level- Cable Loss+ Antenna Gain
3. Over Limit= Absolute Level (dBm)-Limit(dBm)

WCDMA Band IV							
Frequency	SG Level	Cable Loss	Antenna Factor	Absolute Level	Limit	Over Limit	Polarity
(MHz)	(dBm)	(dB)	(dB)	(dBm)	(dBm)	(dBm)	
Test Results for Channel 1312/1712.4MHz							
3424.8	-51.22	4.02	29.80	-25.44	-13	-12.44	Vertical
3424.8	-48.78	4.02	29.80	-23.00	-13	-10.00	Horizontal
5137.2	-49.46	5.24	35.84	-18.86	-13	-5.86	Vertical
5137.2	-47.15	5.24	35.84	-16.55	-13	-3.55	Horizontal
Test Results for Channel 1412/1732.4MHz							
3464.8	-41.58	4.03	30.00	-15.61	-13	-2.61	Vertical
3464.8	-46.86	4.03	30.00	-20.89	-13	-7.89	Horizontal
5197.2	-47.07	5.25	35.86	-16.46	-13	-3.46	Vertical
5197.2	-47.41	5.25	35.86	-16.80	-13	-3.80	Horizontal
Test Results for Channel 1513/1752.6MHz							
3505.2	-50.68	2.91	27.68	-25.91	-13	-12.91	Vertical
3505.2	-46.89	2.91	27.68	-22.12	-13	-9.12	Horizontal
5257.8	-49.53	5.26	35.86	-18.93	-13	-5.93	Vertical
5257.8	-52.88	5.26	35.86	-22.28	-13	-9.28	Horizontal

Remark:

1. We were tested all Configuration refer 3GPP TS134 121.
2. Absolute Level = SG Level- Cable Loss+ Antenna Gain
3. Over Limit= Absolute Level (dBm)-Limit(dBm)

7.2 EFFECTIVE RADIATED POWER AND EFFECTIVE ISOTROPIC RADIATED POWER

7.2.1 Applicable Standard

According to FCC KDB 971168 D01 v03r01 Section 5.2.1/ Section 5.2.2.2 and ANSI/TIA-603-E-2016 Section 2.2.17

7.2.2 Conformance Limit

The substitution method, in ANSI/TIA-603-E-2016, was used for ERP/EIRP measurement, and the spectrum analyzer configuration follows KDB 971168 D01 Power Meas. License Digital Systems v03r01. The ERP of mobile transmitters must not exceed 7 Watts (Cellular Band) and the EIRP of mobile transmitters are limited to 2 Watts (PCS Band).

7.2.3 Measuring Instruments

The Measuring equipment is listed in the section 6.3 of this test report.

7.2.4 Test Configuration

(a) For E.R.P and E.I.R.P Measurements

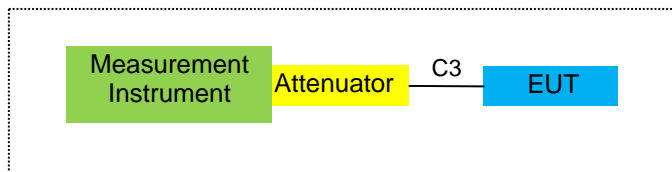

7.2.5 Test Procedure

The measurements procedures specified in ANSI/TIA-603-E-2016 were applied. In an anechoic antenna test chamber, a half-wave dipole antenna for the frequency band of interest is placed at the reference centre of the chamber. An RF Signal source for the frequency band of interest is connected to the dipole with a cable that has been constructed to not interfere with the radiation pattern of the antenna. A known (measured) power (Pin) is applied to the input of the dipole, and the power received (Pr) at the chamber's probe antenna is recorded.

The relevant equation for determining the ERP or EIRP from the conducted RF output power measured using the guidance provided above is:

$$ERP/EIRP = SGLevel - Pcl + Ga$$

where:

ERP/EIRP = effective or equivalent radiated power, respectively (expressed in the same units as SGLevel, typically dBW or dBm);

SGLevel = Signal generator output power or PSD, in dBm or dBW;

Ga = gain of the transmitting antenna, in dBd (ERP) or dBi (EIRP);

Pcl = signal attenuation in the connecting cable between the transmitter and antenna, in dB.²

The EUT is substituted for the dipole at the reference centre of the chamber and a scan is performed to obtain the radiation pattern.

From the radiation pattern, the co-ordinates where the maximum antenna gain occurs are identified.

The EUT is then put into continuously transmitting mode at its maximum power level.

Power mode measurements are performed with the receiving antenna placed at the coordinates determined in Step 3 to determine the output power as defined in Rule 24.232 (b) and (c). The "reference path loss" from Step1 is added to this result.

This value is EIRP since the measurement is calibrated using a half-wave dipole antenna of known gain (2.15 dBi) and known input power (Pin).

ERP can be calculated from EIRP by subtracting the gain of the dipole, $ERP = EIRP - 2.15dBi$.

Both horizontal and vertical antenna polarities were tested and performed pretest to three orthogonal axis. The worst case emissions were reported.

Substitution antenna and Receiving Antenna:

Item	Kind of Equipment	Manufacturer	Type No.	Serial No.	Character	Note
1	Bilog Antenna	TESEQ	CBL6111D	31216	30MHz~2GHz	Receiving Antenna
2	Horn Antenna	EM	EM-AH-10180	2011071402	1GHz~18GHz	Receiving Antenna
3	Bilog Antenna	TESEQ	CBL6111D	31216	30MHz~2GHz	Substitution antenna
4	Horn Antenna	EM	EM-AH-10180	2011071402	1GHz~18GHz	Substitution antenna

Use the following spectrum analyzer settings:

	GSM/GPRS/EGPRS	UMTS band
Span	500KHz	10MHz
RBW	10KHz	300KHz
VBW	30KHz	1MHz
Detector	RMS	RMS
Trace	Average	Average
Average Type	Power	Power
Sweep Count	100	100

7.2.6 Test Results

EUT:	Smart Phone	Model No.:	K13 Pro
Temperature:	20 °C	Relative Humidity:	48%
Test Mode:	GSM/GPRS/EGPRS 850/ GSM/GPRS/EGPRS 1900 UMTS band II/ UMTS band V/ UMTS band IV	Test By:	Allen Liu

■ Effective Radiated Power

Radiated Power (ERP) for GSM850							
Frequency	Polarization	SG	Pcl	Ga	Correction	ERP	ERP
(MHz)		Level	(dB)	Antenna		(dBm)	(W)
		(dBm)	(dB)	Gain	(dB)	(dBm)	(W)
824.2	H	12.55	2.11	23.84	2.15	32.13	1.633052
836.6	H	13.19	2.13	23.15	2.15	32.06	1.606941
848.8	H	13.38	2.13	23.06	2.15	32.16	1.644372
824.2	V	12.67	2.11	23.11	2.15	31.52	1.419058
836.6	V	12.83	2.13	23.07	2.15	31.62	1.452112
848.8	V	12.41	2.13	23.25	2.15	31.38	1.374042

Radiated Power (ERP) for GPRS850							
Frequency	Polarization	SG	Pcl	Ga	Correction	ERP	ERP
(MHz)		Level	(dB)	Antenna		(dBm)	(W)
		(dBm)	(dB)	Gain	(dB)	(dBm)	(W)
824.2	H	12.48	2.11	23.84	2.15	32.06	1.606941
836.6	H	13.10	2.13	23.15	2.15	31.97	1.573983
848.8	H	13.30	2.13	23.06	2.15	32.08	1.614359
824.2	V	12.27	2.11	23.11	2.15	31.12	1.294196
836.6	V	12.38	2.13	23.07	2.15	31.17	1.309182
848.8	V	12.01	2.13	23.25	2.15	30.98	1.253141

Radiated Power (ERP) for EGPRS850							
Frequency	Polarization	SG	Pcl	Ga	Correction	ERP	ERP
(MHz)		Level	(dB)	Antenna		(dBm)	(W)
		(dBm)	(dB)	Gain	(dB)	(dBm)	(W)
824.2	H	6.68	2.11	23.84	2.15	26.26	0.422669
836.6	H	7.54	2.13	23.15	2.15	26.41	0.437522
848.8	H	7.37	2.13	23.06	2.15	26.15	0.412098
824.2	V	6.49	2.11	23.11	2.15	25.34	0.341979
836.6	V	6.46	2.13	23.07	2.15	25.25	0.334965
848.8	V	6.26	2.13	23.25	2.15	25.23	0.333426

Radiated Power (ERP) for UMTS band V							
Frequency	Polarization	SG	Pcl	Ga	Correction	ERP	ERP
(MHz)		Level	(dB)	Antenna Gain		(dBm)	(W)
		(dBm)	(dB)	(dB)	(dB)	(dBm)	(W)
826.4	H	3.06	2.11	23.84	2.15	22.64	0.183654
835	H	3.56	2.13	23.15	2.15	22.43	0.174985
846.6	H	3.77	2.13	23.06	2.15	22.55	0.179887
826.4	V	2.51	2.11	23.11	2.15	21.36	0.136773
835	V	2.71	2.13	23.07	2.15	21.50	0.141254
846.6	V	2.09	2.13	23.25	2.15	21.06	0.127644

Note:

SG Level= Signal generator output

Pcl= cable loss

Ga= Antenna Gain

Peak EIRP(dBm)= SGLevel -Pcl +Ga

ERP(dBm)=EIRP-2.15

■ Effective Isotropic Radiated Power

Radiated Power (E.I.R.P) for GSM1900						
Frequency	Polarization	SG	Pcl	Ga	EIRP	EIRP
(MHz)		Level	(dB)	Antenna	(dBm)	(W)
		(dBm)		Gain		
1850.2	H	4.19	3.76	28.24	28.67	0.736207
1880	H	4.15	3.91	28.22	28.46	0.701455
1909.8	H	4.06	3.93	28.20	28.33	0.680769
1850.2	V	3.50	3.76	27.32	27.06	0.508159
1880	V	3.73	3.91	27.33	27.15	0.518800
1909.8	V	3.98	3.93	27.31	27.36	0.544503

Radiated Power (E.I.R.P) for GPRS1900						
Frequency	Polarization	SG	Pcl	Ga	EIRP	EIRP
(MHz)		Level	(dB)	Antenna	(dBm)	(W)
		(dBm)		Gain		
1850.2	H	5.20	3.76	28.24	29.68	0.928966
1880	H	4.91	3.91	28.22	29.22	0.835603
1909.8	H	5.04	3.93	28.20	29.31	0.853100
1850.2	V	5.09	3.76	27.32	28.65	0.732825
1880	V	4.73	3.91	27.33	28.15	0.653131
1909.8	V	4.84	3.93	27.31	28.22	0.663743

Radiated Power (E.I.R.P) for EGPRS1900						
Frequency	Polarization	SG	Pcl	Ga	EIRP	EIRP
(MHz)		Level	(dB)	Antenna	(dBm)	(W)
		(dBm)		Gain		
1850.2	H	1.21	3.76	28.24	25.69	0.370681
1880	H	1.42	3.91	28.22	25.73	0.374111
1909.8	H	0.89	3.93	28.20	25.16	0.328095
1850.2	V	0.53	3.76	27.32	24.09	0.256448
1880	V	0.73	3.91	27.33	24.15	0.260016
1909.8	V	0.95	3.93	27.31	24.33	0.271019

Radiated Power (E.I.R.P) for UMTS band II						
Frequency	Polarization	SG Level	Pcl	Ga Antenna Gain	EIRP	EIRP
(MHz)		(dBm)	(dB)	(dB)	(dBm)	(W)
1852.4	H	-2.35	3.76	28.24	22.13	0.163305
1880	H	-2.25	3.91	28.22	22.06	0.160694
1907.6	H	-2.13	3.93	28.20	22.14	0.163682
1852.4	V	-2.55	3.76	27.32	21.01	0.126183
1880	V	-2.31	3.91	27.33	21.11	0.129122
1907.6	V	-2.30	3.93	27.31	21.08	0.128233

Radiated Power (E.I.R.P) for UMTS band IV						
Frequency	Polarization	SG Level	Pcl	Ga Antenna Gain	EIRP	EIRP
(MHz)		(dBm)	(dB)	(dB)	(dBm)	(W)
1712.4	H	-1.88	3.13	27.63	22.62	0.182810
1732.4	H	-1.78	3.27	27.61	22.56	0.180302
1752.6	H	-1.96	3.30	27.60	22.34	0.171396
1712.4	V	-2.82	3.13	27.63	21.68	0.147231
1732.4	V	-2.79	3.27	27.61	21.55	0.142889
1752.6	V	-2.94	3.30	27.60	21.36	0.136773

Note:
 SG Level= Signal generator output
 Pcl= cable loss
 Ga= Antenna Gain
 Peak EIRP(dBm)= SGLevel -Pcl+Ga.

7.3 CONDUCTED OUTPUT POWER

7.3.1 Applicable Standard

According to FCC Part 2.1046 and FCC Part 22.913(a)(2) and FCC Part 24.232(c) and FCC KDB 971168 D01 v03r01 Section 5.2

7.3.2 Conformance Limit

Extend coverage on a secondary basis into cellular unserved areas, as those areas are defined in §22.949, the ERP of base transmitters and cellular repeaters of such systems must not exceed 1000 Watts. The ERP of mobile transmitters and auxiliary test transmitters must not exceed 7 Watts(38.5dBm).

Mobile and portable stations are limited to 2 watts (33dBm)EIRP and the equipment must employ a means for limiting power to the minimum necessary for successful communications..

7.3.3 Measuring Instruments

The Measuring equipment is listed in the section 6.3 of this test report.

7.3.4 Test Setup

Please refer to Section 6.1 of this test report.

7.3.5 Test Procedure

Connect the EUT to Universal Radio Communication Tester CMU200 or CMU500 via the antenna connector. A call is set up by the SS according to the generic call set up procedure on a channel with ARFCN in the ARFCN range, power control level set to Max power. The frequency band is set as selected frequency, The RF output of the transmitter was connected to base station simulator.

Set EUT at maximum average power by base station simulator.

Set RBW = 1-5% of the OBW, not to exceed 1 MHz.

Set VBW $\geq 3 \times$ RBW.

Number of points in sweep $\geq 2 \times$ span / RBW. (This gives bin-to-bin spacing \leq RBW/2, so that narrowband signals are not lost between frequency bins.)

Sweep time = auto.

Detector = RMS (power averaging).

Set sweep trigger to "free run".

Trace average at least 100 traces in power averaging (i.e., RMS) mode; however, the number of traces to be averaged shall be increased above 100 as needed such that the average accurately represents the true average over the on and off periods of the transmitter.

Compute power by integrating the spectrum across the OBW of the signal using the instrument's band power measurement function with band limits set equal to the OBW band edges. If the instrument does not have a band power function, sum the spectrum levels (in power units) at intervals equal to the RBW extending across the entire OBW of the spectrum.

Add $10 \log(1/x)$, where x is the duty cycle, to the measured power in order to compute the average power during the actual transmission times (because the measurement represents an average over both the on and off times of the transmission). For example, add $10 \log(1/0.25) = 6$ dB if the duty cycle is a constant 25%.

Measure lowest, middle, and highest channels for each bandwidth and different modulation.

Measure and record the results in the test report.

7.3.6 Test Results

EUT:	Smart Phone	Model No.:	K13 Pro
Temperature:	20 °C	Relative Humidity:	48%
Test Mode:	GSM/GPRS/EGPRS 850/ GSM/GPRS/EGPRS 1900 UMTS band II/ UMTS band V/ UMTS band IV	Test By:	Allen Liu

Test data reference attachment

7.4 FREQUENCY STABILITY

7.4.1 Applicable Standard

According to FCC Part 2.1055 and FCC Part 22.355 and FCC Part 24.235 and FCC KDB 971168 D01 Section 9.0

7.4.2 Conformance Limit

The frequency stability shall be measured by variation of ambient temperature and variation of primary supply voltage to ensure that the fundamental emission stays within the authorized frequency block. The frequency stability of the transmitter shall be maintained within $\pm 0.00025\%$ ($\pm 2.5\text{ppm}$) of the center frequency.

7.4.3 Measuring Instruments

The Measuring equipment is listed in the section 6.3 of this test report.

7.4.4 Test Setup

Please refer to Section 6.1 of this test report.

7.4.5 Test Procedure

Connect the EUT to Universal Radio Communication Tester CMU200 or CMU500 via the antenna connector. A call is set up by the SS according to the generic call set up procedure on a channel with ARFCN in the ARFCN range, power control level set to Max power. MS TXPWR_MAX_CCH is set to the maximum value supported by the Power Class of the Mobile under test.

EUT was placed at temperature chamber and connected to an external power supply.

Temperature and voltage condition shall be tested to confirm frequency stability.

For Temperature Variation

1. The testing follows FCC KDB 971168 D01 v03r01 Section 9.0.
2. The EUT was set up in the thermal chamber and connected with the system simulator.
3. With power OFF, the temperature was decreased to -30°C and the EUT was stabilized before testing. Power was applied and the maximum change in frequency was recorded within one minute.
4. With power OFF, the temperature was raised in 10°C steps up to 50°C . The EUT was stabilized at each step for at least half an hour. Power was applied and the maximum frequency change was recorded within one minute.

For Voltage Variation

1. The testing follows FCC KDB 971168 D01 v03r01 Section 9.0.
2. The EUT was placed in a temperature chamber at $25\pm 5^{\circ}\text{C}$ and connected with the system simulator.
3. The power supply voltage to the EUT was varied from 85% to 115% of the nominal value measured at the input to the EUT.
4. The variation in frequency was measured for the worst case.

7.4.6 Test Results

EUT:	Smart Phone	Model No.:	K13 Pro
Temperature:	20 °C	Relative Humidity:	48%
Test Mode:	GSM/GPRS/EGPRS 850/ GSM/GPRS/EGPRS 1900 UMTS band II/ UMTS band V/ UMTS band IV	Test By:	Allen Liu
Results: PASS			

Frequency Error Against Voltage for GSM 850 band		
Voltage (V)	Frequency Error (Hz)	Frequency Error (ppm)
3.4	-14.75	-0.0176
3.85	-19.11	-0.0228
4.4	-18.21	-0.0218

Frequency Error Against Temperature for GSM 850 band		
Temperature (°C)	Frequency Error (Hz)	Frequency Error (ppm)
-30	-16.85	-0.0201
-20	-22.35	-0.0267
-10	-18.97	-0.0227
0	-16.63	-0.0199
10	-23.55	-0.0281
20	-14.77	-0.0177
30	-20.90	-0.0250
40	-17.82	-0.0213
50	-21.19	-0.0253

Frequency Error Against Voltage for GPRS850 band		
Voltage (V)	Frequency Error (Hz)	Frequency Error (ppm)
3.4	-16.75	-0.0200
3.85	-20.11	-0.0240
4.4	-18.21	-0.0218

Frequency Error Against Temperature for GPRS850 band		
Temperature (°C)	Frequency Error (Hz)	Frequency Error (ppm)
-30	-21.35	-0.0255
-20	-22.97	-0.0275
-10	-20.63	-0.0247
0	-19.55	-0.0234
10	-24.77	-0.0296
20	-22.90	-0.0274
30	-27.82	-0.0333
40	-25.19	-0.0301
50	-21.83	-0.0261

Frequency Error Against Voltage for EGPRS850 band		
Voltage (V)	Frequency Error (Hz)	Frequency Error (ppm)
3.4	-22.75	-0.0272
3.85	-26.11	-0.0312
4.4	-27.21	-0.0325

Frequency Error Against Temperature for EGPRS850 band		
Temperature (°C)	Frequency Error (Hz)	Frequency Error (ppm)
-30	-22.85	-0.0273
-20	-28.35	-0.0339
-10	-25.97	-0.0310
0	-23.63	-0.0282
10	-24.55	-0.0293
20	-24.77	-0.0296
30	-26.90	-0.0322
40	-28.82	-0.0345
50	-28.19	-0.0337

Note:

1. Normal Voltage = 3.85V; Battery End Point (BEP) = 3.4V; Maximum Voltage = 4.4V
2. The frequency fundamental emissions stay within the authorized frequency block based on the frequency deviation measured is small.

Frequency Error Against Voltage for PCS 1900 band		
Voltage (V)	Frequency Error (Hz)	Frequency Error (ppm)
3.4	-20.04	-0.0107
3.85	-21.78	-0.0116
4.4	-27.66	-0.0147

Frequency Error Against Temperature for PCS 1900 band		
Temperature (°C)	Frequency Error (Hz)	Frequency Error (ppm)
-30	-26.96	-0.0143
-20	-23.89	-0.0127
-10	-22.40	-0.0119
0	-28.74	-0.0153
10	-26.77	-0.0142
20	-30.98	-0.0165
30	-30.52	-0.0162
40	-23.45	-0.0125
50	-24.93	-0.0133

Frequency Error Against Voltage for GPRS1900 band		
Voltage (V)	Frequency Error (Hz)	Frequency Error (ppm)
3.4	-20.04	-0.0107
3.85	-26.78	-0.0142
4.4	-29.66	-0.0158

Frequency Error Against Temperature for GPRS1900 band		
Temperature (°C)	Frequency Error (Hz)	Frequency Error (ppm)
-30	-21.96	-0.0117
-20	-24.89	-0.0132
-10	-28.40	-0.0151
0	-23.74	-0.0126
10	-22.77	-0.0121
20	-26.98	-0.0144
30	-25.52	-0.0136
40	-30.45	-0.0162
50	-23.93	-0.0127

Frequency Error Against Voltage for EGPRS1900 band		
Voltage (V)	Frequency Error (Hz)	Frequency Error (ppm)
3.4	-28.04	-0.0149
3.85	-23.78	-0.0126
4.4	-26.66	-0.0142

Frequency Error Against Temperature for EGPRS1900 band		
Temperature (°C)	Frequency Error (Hz)	Frequency Error (ppm)
-30	-21.96	-0.0117
-20	-18.89	-0.0100
-10	-24.40	-0.0130
0	-29.74	-0.0158
10	-25.77	-0.0137
20	-24.98	-0.0133
30	-32.52	-0.0173
40	-31.45	-0.0167
50	-23.93	-0.0127

Note:

1. Normal Voltage = 3.85V; Battery End Point (BEP) = 3.4V; Maximum Voltage = 4.4V
2. The frequency fundamental emissions stay within the authorized frequency block based on the frequency deviation measured is small.

Frequency Error Against Voltage for UMTS band II		
Voltage (V)	Frequency Error (Hz)	Frequency Error (ppm)
3.4	-14.99	-0.0080
3.85	-18.04	-0.0096
4.4	-16.22	-0.0086

Frequency Error Against Temperature for UMTS band II		
Temperature (°C)	Frequency Error (Hz)	Frequency Error (ppm)
-30	-21.46	-0.0114
-20	-20.06	-0.0107
-10	-23.84	-0.0127
0	-24.72	-0.0131
10	-26.68	-0.0142
20	-25.87	-0.0138
30	-22.03	-0.0117
40	-24.10	-0.0128
50	-26.84	-0.0143

Frequency Error Against Voltage for UMTS band V		
Voltage (V)	Frequency Error (Hz)	Frequency Error (ppm)
3.4	-22.85	-0.0273
3.85	-19.02	-0.0227
4.4	-26.55	-0.0317

Frequency Error Against Temperature for UMTS band V		
Temperature (°C)	Frequency Error (Hz)	Frequency Error (ppm)
-30	-20.05	-0.0240
-20	-24.09	-0.0288
-10	-22.34	-0.0267
0	-27.69	-0.0331
10	-30.43	-0.0364
20	-29.34	-0.0351
30	-23.54	-0.0281
40	-21.61	-0.0258
50	-19.08	-0.0228

Frequency Error Against Voltage for UMTS band IV		
Voltage (V)	Frequency Error (Hz)	Frequency Error (ppm)
3.4	-21.43	-0.0124
3.85	-22.76	-0.0131
4.4	-26.90	-0.0155

Frequency Error Against Temperature for UMTS band IV		
Temperature (°C)	Frequency Error (Hz)	Frequency Error (ppm)
-30	-20.38	-0.0118
-20	-25.15	-0.0145
-10	-24.64	-0.0142
0	-21.14	-0.0122
10	-22.32	-0.0129
20	-21.10	-0.0122
30	-18.26	-0.0105
40	-22.20	-0.0128
50	-23.35	-0.0135

Note:

1. Normal Voltage = 3.85V; Battery End Point (BEP) = 3.4V; Maximum Voltage = 4.4V
2. The frequency fundamental emissions stay within the authorized frequency block based on the frequency deviation measured is small.

7.5 PEAK-TO-AVERAGE RATIO

7.5.1 Applicable Standard

According to FCC 22.913 and FCC 24.232(d) and FCC KDB 971168 D01 Section 5.7.1

7.5.2 Conformance Limit

The peak-to-average power ratio (PAPR) of the transmitter output power must not exceed 13 dB. The PAPR measurements should be made using either an instrument with complementary cumulative distribution function (CCDF) capabilities to determine that PAPR will not exceed 13 dB for more than 0.1 percent of the time or other Commission approved procedure. The measurement must be performed using a signal corresponding to the highest PAPR expected during periods of continuous transmission.

7.5.3 Measuring Instruments

The Measuring equipment is listed in the section 6.3 of this test report.

7.5.4 Test Setup

Please refer to Section 6.1 of this test report.

7.5.5 Test Procedure

The EUT was connected to Spectrum Analyzer and Base Station via power divider. The RF output of EUT was connected to the spectrum analyzer by RF cable and attenuator. The path loss was compensated to the results for each measurement. Set the number of counts to a value that stabilizes the measured CCDF curve. Set the measurement interval to 1 ms. Record the maximum PAPR level associated with a probability of 0.1%.
 a) Refer to instrument’s analyzer instruction manual for details on how to use the power statistics/CCDF function;
 b) Set resolution/measurement bandwidth \geq signal’s occupied bandwidth;
 c) Set the number of counts to a value that stabilizes the measured CCDF curve;
 d) Set the measurement interval as follows:
 1) for continuous transmissions, set to 1 ms,
 2) for burst transmissions, employ an external trigger that is synchronized with the EUT burst timing sequence, or use the internal burst trigger with a trigger level that allows the burst to stabilize and set the measurement interval to a time that is less than or equal to the burst duration.
 e) Record the maximum PAPR level associated with a probability of 0.1%.

7.5.6 Test Results

EUT:	Smart Phone	Model No.:	K13 Pro
Temperature:	20 °C	Relative Humidity:	48%
Test Mode:	GSM/GPRS/EGPRS 850/ GSM/GPRS/EGPRS 1900 /UMTS band II/ UMTS band V/ UMTS band IV	Test By:	Allen Liu
Results: PASS			

Test data reference attachment

7.6 26DB BANDWIDTH AND 99% OCCUPIED BANDWIDTH

7.6.1 Applicable Standard

According to FCC Part 2.1049 and FCC Part 22H and FCC Part 24E and FCC KDB 971168 D01 Section 4.0

7.6.2 Conformance Limit

The occupied bandwidth is the width of a frequency band such that, below the lower and above the upper frequency limits, the mean powers emitted are each equal to a specified percentage 0.5% of the total mean transmitted power.

The 26 dB emission bandwidth is defined as the frequency range between two points, one above and one below the carrier frequency, at which the spectral density of the emission is attenuated 26 dB below the maximum in-band spectral density of the modulated signal. Spectral density (power per unit bandwidth) is to be measured with a detector of resolution bandwidth equal to approximately 1.0% of the emission bandwidth.

7.6.3 Measuring Instruments

The Measuring equipment is listed in the section 6.3 of this test report.

7.6.4 Test Setup

Please refer to Section 6.1 of this test report.

7.6.5 Test Procedure

The testing follows FCC KDB 971168 v03r01 Section 4.0.

The EUT was connected to Spectrum Analyzer and Base Station via power divider.

The RF output of EUT was connected to the spectrum analyzer by RF cable and attenuator. The path loss was compensated to the results for each measurement.

The spectrum analyzer center frequency is set to the nominal EUT channel center frequency. The span range for the spectrum analyzer shall be between two and five times the anticipated OBW.

The nominal resolution bandwidth (RBW) shall be in the range of 1 to 5 % of the anticipated OBW, and the VBW shall be at least 3 times the RBW.

Set the detection mode to peak, and the trace mode to max hold.

Determine the reference value: Set the EUT to transmit a modulated signal. Allow the trace to stabilize. Set the spectrum analyzer marker to the highest level of the displayed trace.

(this is the reference value)

Determine the “-26 dB down amplitude” as equal to (Reference Value – X).

Place two markers, one at the lowest and the other at the highest frequency of the envelope of the spectral display such that each marker is at or slightly below the “-X dB down amplitude” determined in step 6. If a marker is below this “-X dB down amplitude” value it shall be placed as close as possible to this value. The OBW is the positive frequency difference between the two markers.

Use the 99 % power bandwidth function of the spectrum analyzer and report the measured bandwidth.

7.6.6 Test Results

EUT:	Smart Phone	Model No.:	K13 Pro
Temperature:	20 °C	Relative Humidity:	48%
Test Mode:	GSM/GPRS/EGPRS 850/ GSM/GPRS/EGPRS 1900 /UMTS band II/ UMTS band V/ UMTS band IV	Test By:	Allen Liu
Results: PASS			

Test data reference attachment

7.7 CONDUCTED BAND EDGE

7.7.1 Applicable Standard

According to FCC Part 2.1051 and FCC Part 22.917(a) and 24.238(a) and FCC KDB 971168 D01 Section 6.0

7.7.2 Conformance Limit

The power of any emission outside of the authorized operating frequency ranges must be lower than the transmitter power (P) by a factor of at least $43 + 10 \log(P)$ dB.

7.7.3 Measuring Instruments

The Measuring equipment is listed in the section 6.3 of this test report.

7.7.4 Test Setup

Please refer to Section 6.1 of this test report.

7.7.5 Test Procedure

The testing follows FCC KDB 971168 v03r01 Section 6.0.

The EUT was connected to Spectrum Analyzer and Base Station via power divider.

The RF output of EUT was connected to the spectrum analyzer by RF cable and attenuator.

The path loss was compensated to the results for each measurement.

The band edges of low and high channels for the highest RF powers were measured.

The RF fundamental frequency should be excluded against the limit line in the operating frequency band.

The limit line is derived from $43 + 10\log(P)$ dB below the transmitter power P(Watts)

$$= P(W) - [43 + 10\log(P)] \text{ (dB)}$$

$$= [30 + 10\log(P)] \text{ (dBm)} - [43 + 10\log(P)] \text{ (dB)}$$

$$= -13\text{dBm.}$$

7.7.6 Test Results

EUT:	Smart Phone	Model No.:	K13 Pro
Temperature:	20 °C	Relative Humidity:	48%
Test Mode:	GSM/GPRS/EGPRS 850/ GSM/GPRS/EGPRS 1900/ UMTS band II/ UMTS band V/ UMTS band IV	Test By:	Allen Liu
Results: PASS			

Test data reference attachment

7.8 CONDUCTED SPURIOUS EMISSION AT ANTENNA TERMINAL

7.8.1 Applicable Standard

According to FCC Part 2.1051 and FCC Part 22.917(a) and Part 24.238(a) and FCC KDB 971168 D01 Section6.0

7.8.2 Conformance Limit

The power of any emission outside of the authorized operating frequency ranges must be lower than the transmitter power (P) by a factor of at least $43 + 10 \log (P)$ dB.
It is measured by means of a calibrated spectrum analyzer and scanned from 30 MHz up to a frequency including its 10th harmonic.

7.8.3 Measuring Instruments

The Measuring equipment is listed in the section 6.3 of this test report.

7.8.4 Test Setup

Please refer to Section 6.1 of this test report.

7.8.5 Test Procedure

The testing follows FCC KDB 971168 v03r01 Section 6.0.
The EUT was connected to Spectrum Analyzer and Base Station via power divider.
The RF output of EUT was connected to the spectrum analyzer by RF cable and attenuator.
The path loss was compensated to the results for each measurement.
The middle channel for the highest RF power within the transmitting frequency was measured.
The conducted spurious emission for the whole frequency range was taken.
The RF fundamental frequency should be excluded against the limit line in the operating frequency band.
The limit line is derived from $43 + 10\log(P)$ dB below the transmitter power P(Watts)
 $= P(W) - [43 + 10\log(P)]$ (dB)
 $= [30 + 10\log(P)]$ (dBm) - $[43 + 10\log(P)]$ (dB)
 $= -13\text{dBm}$.

7.8.6 Test Results

EUT:	Smart Phone	Model No.:	K13 Pro
Temperature:	20 °C	Relative Humidity:	48%
Test Mode:	GSM/GPRS/EGPRS 850/ GSM/GPRS/EGPRS 1900/ UMTS band II/ UMTS band V/ UMTS Band IV	Test By:	Allen Liu
Results: PASS			

Test data reference attachment

8 TEST RESULTS

8.1 CONDUCTED OUTPUT POWER

Band	Channel	Frequency (MHz)	Power (dBm)	high Limit (dBm)	Verdict
GSM850	128	824.2	33.15	37	PASS
GSM850	189	836.4	33.09	37	PASS
GSM850	251	848.8	33.02	37	PASS
GSM1900	512	1850.2	29.77	37	PASS
GSM1900	661	1880	29.90	37	PASS
GSM1900	810	1909.8	30.41	37	PASS
GPRS850 1 Slot	128	824.2	33.15	37	PASS
GPRS850 1 Slot	189	836.4	33.08	37	PASS
GPRS850 1 Slot	251	848.8	33.02	37	PASS
GPRS850 2 Slot	128	824.2	32.30	37	PASS
GPRS850 2 Slot	189	836.4	32.19	37	PASS
GPRS850 2 Slot	251	848.8	32.13	37	PASS
GPRS850 3 Slot	128	824.2	30.32	37	PASS
GPRS850 3 Slot	189	836.4	30.21	37	PASS
GPRS850 3 Slot	251	848.8	30.19	37	PASS
GPRS850 4 Slot	128	824.2	29.14	37	PASS
GPRS850 4 Slot	189	836.4	29.06	37	PASS
GPRS850 4 Slot	251	848.8	29.07	37	PASS
GPRS1900 1 Slot	512	1850.2	29.77	37	PASS
GPRS1900 1 Slot	661	1880	29.89	37	PASS
GPRS1900 1 Slot	810	1909.8	30.41	37	PASS
GPRS1900 2 Slot	512	1850.2	28.93	37	PASS
GPRS1900 2 Slot	661	1880	29.07	37	PASS
GPRS1900 2 Slot	810	1909.8	29.69	37	PASS
GPRS1900 3 Slot	512	1850.2	27.08	37	PASS
GPRS1900 3 Slot	661	1880	27.19	37	PASS
GPRS1900 3 Slot	810	1909.8	27.89	37	PASS
GPRS1900 4 Slot	512	1850.2	26.03	37	PASS
GPRS1900 4 Slot	661	1880	26.17	37	PASS
GPRS1900 4 Slot	810	1909.8	26.89	37	PASS
EGPRS850 1 Slot	128	824.2	27.63	37	PASS
EGPRS850 1 Slot	189	836.4	27.45	37	PASS
EGPRS850 1 Slot	251	848.8	27.68	37	PASS
EGPRS850 2 Slot	128	824.2	26.24	37	PASS
EGPRS850 2 Slot	189	836.4	26.47	37	PASS
EGPRS850 2 Slot	251	848.8	26.18	37	PASS
EGPRS850 3 Slot	128	824.2	24.49	37	PASS
EGPRS850 3 Slot	189	836.4	24.19	37	PASS
EGPRS850 3 Slot	251	848.8	24.46	37	PASS
EGPRS850 4 Slot	128	824.2	23.27	37	PASS
EGPRS850 4 Slot	189	836.4	23.09	37	PASS
EGPRS850 4 Slot	251	848.8	23.27	37	PASS
EGPRS1900 1 Slot	512	1850.2	25.92	37	PASS
EGPRS1900 1 Slot	661	1880	26.06	37	PASS
EGPRS1900 1 Slot	810	1909.8	25.53	37	PASS
EGPRS1900 2 Slot	512	1850.2	24.85	37	PASS
EGPRS1900 2 Slot	661	1880	24.93	37	PASS
EGPRS1900 2 Slot	810	1909.8	24.34	37	PASS
EGPRS1900 3 Slot	512	1850.2	22.81	37	PASS

EGPRS1900 3 Slot	661	1880	22.82	37	PASS
EGPRS1900 3 Slot	810	1909.8	22.34	37	PASS
EGPRS1900 4 Slot	512	1850.2	21.59	37	PASS
EGPRS1900 4 Slot	661	1880	21.62	37	PASS
EGPRS1900 4 Slot	810	1909.8	21.06	37	PASS
WCDMA Band2	9262	1852.4	23.44	37	PASS
WCDMA Band2	9400	1880	23.56	37	PASS
WCDMA Band2	9538	1907.6	23.42	37	PASS
WCDMA Band2 Subtest1	9262	1852.4	22.63	37	PASS
WCDMA Band2 Subtest1	9400	1880	22.67	37	PASS
WCDMA Band2 Subtest1	9538	1907.6	22.54	37	PASS
WCDMA Band2 Subtest2	9262	1852.4	21.89	37	PASS
WCDMA Band2 Subtest2	9400	1880	22.08	37	PASS
WCDMA Band2 Subtest2	9538	1907.6	21.71	37	PASS
WCDMA Band2 Subtest3	9262	1852.4	21.19	37	PASS
WCDMA Band2 Subtest3	9400	1880	20.96	37	PASS
WCDMA Band2 Subtest3	9538	1907.6	20.90	37	PASS
WCDMA Band2 Subtest4	9262	1852.4	21.20	37	PASS
WCDMA Band2 Subtest4	9400	1880	20.85	37	PASS
WCDMA Band2 Subtest4	9538	1907.6	21.02	37	PASS
WCDMA Band2 Subtest1	9262	1852.4	22.06	37	PASS
WCDMA Band2 Subtest1	9400	1880	22.25	37	PASS
WCDMA Band2 Subtest1	9538	1907.6	22.05	37	PASS
WCDMA Band2 Subtest2	9262	1852.4	22.48	37	PASS
WCDMA Band2 Subtest2	9400	1880	22.58	37	PASS
WCDMA Band2 Subtest2	9538	1907.6	22.48	37	PASS
WCDMA Band2 Subtest3	9262	1852.4	21.29	37	PASS
WCDMA Band2 Subtest3	9400	1880	21.34	37	PASS
WCDMA Band2 Subtest3	9538	1907.6	21.33	37	PASS
WCDMA Band2 Subtest4	9262	1852.4	22.63	37	PASS
WCDMA Band2 Subtest4	9400	1880	22.70	37	PASS
WCDMA Band2 Subtest4	9538	1907.6	22.51	37	PASS
WCDMA Band2 Subtest5	9262	1852.4	21.55	37	PASS
WCDMA Band2 Subtest5	9400	1880	21.90	37	PASS
WCDMA Band2 Subtest5	9538	1907.6	21.68	37	PASS
WCDMA Band4	1312	1712.4	23.19	37	PASS
WCDMA Band4	1412	1732.4	23.10	37	PASS
WCDMA Band4	1513	1752.6	23.07	37	PASS
WCDMA Band4 Subtest1	1312	1712.4	22.40	37	PASS
WCDMA Band4 Subtest1	1412	1732.4	22.25	37	PASS
WCDMA Band4 Subtest1	1513	1752.6	22.23	37	PASS
WCDMA Band4 Subtest2	1312	1712.4	21.74	37	PASS
WCDMA Band4 Subtest2	1412	1732.4	21.62	37	PASS
WCDMA Band4 Subtest2	1513	1752.6	21.65	37	PASS
WCDMA Band4 Subtest3	1312	1712.4	20.72	37	PASS
WCDMA Band4 Subtest3	1412	1732.4	20.49	37	PASS
WCDMA Band4 Subtest3	1513	1752.6	20.73	37	PASS
WCDMA Band4 Subtest4	1312	1712.4	20.65	37	PASS
WCDMA Band4 Subtest4	1412	1732.4	20.79	37	PASS
WCDMA Band4 Subtest4	1513	1752.6	20.53	37	PASS
WCDMA Band4 Subtest1	1312	1712.4	22.05	37	PASS
WCDMA Band4 Subtest1	1412	1732.4	21.86	37	PASS
WCDMA Band4 Subtest1	1513	1752.6	21.62	37	PASS
WCDMA Band4 Subtest2	1312	1712.4	22.29	37	PASS

WCDMA Band4 Subtest2	1412	1732.4	22.17	37	PASS
WCDMA Band4 Subtest2	1513	1752.6	22.19	37	PASS
WCDMA Band4 Subtest3	1312	1712.4	21.18	37	PASS
WCDMA Band4 Subtest3	1412	1732.4	20.78	37	PASS
WCDMA Band4 Subtest3	1513	1752.6	20.72	37	PASS
WCDMA Band4 Subtest4	1312	1712.4	22.39	37	PASS
WCDMA Band4 Subtest4	1412	1732.4	22.25	37	PASS
WCDMA Band4 Subtest4	1513	1752.6	22.23	37	PASS
WCDMA Band4 Subtest5	1312	1712.4	21.61	37	PASS
WCDMA Band4 Subtest5	1412	1732.4	21.30	37	PASS
WCDMA Band4 Subtest5	1513	1752.6	21.27	37	PASS
WCDMA Band5	4132	826.4	23.28	37	PASS
WCDMA Band5	4182	836.4	23.17	37	PASS
WCDMA Band5	4233	846.6	23.17	37	PASS
WCDMA Band5 Subtest1	4132	826.4	22.35	37	PASS
WCDMA Band5 Subtest1	4182	836.4	22.25	37	PASS
WCDMA Band5 Subtest1	4233	846.6	22.26	37	PASS
WCDMA Band5 Subtest2	4132	826.4	21.92	37	PASS
WCDMA Band5 Subtest2	4182	836.4	21.55	37	PASS
WCDMA Band5 Subtest2	4233	846.6	21.21	37	PASS
WCDMA Band5 Subtest3	4132	826.4	20.49	37	PASS
WCDMA Band5 Subtest3	4182	836.4	20.85	37	PASS
WCDMA Band5 Subtest3	4233	846.6	20.54	37	PASS
WCDMA Band5 Subtest4	4132	826.4	20.84	37	PASS
WCDMA Band5 Subtest4	4182	836.4	20.77	37	PASS
WCDMA Band5 Subtest4	4233	846.6	20.70	37	PASS
WCDMA Band5 Subtest1	4132	826.4	21.90	37	PASS
WCDMA Band5 Subtest1	4182	836.4	21.75	37	PASS
WCDMA Band5 Subtest1	4233	846.6	21.81	37	PASS
WCDMA Band5 Subtest2	4132	826.4	22.15	37	PASS
WCDMA Band5 Subtest2	4182	836.4	22.10	37	PASS
WCDMA Band5 Subtest2	4233	846.6	22.20	37	PASS
WCDMA Band5 Subtest3	4132	826.4	21.23	37	PASS
WCDMA Band5 Subtest3	4182	836.4	21.16	37	PASS
WCDMA Band5 Subtest3	4233	846.6	21.02	37	PASS
WCDMA Band5 Subtest4	4132	826.4	22.38	37	PASS
WCDMA Band5 Subtest4	4182	836.4	22.24	37	PASS
WCDMA Band5 Subtest4	4233	846.6	22.26	37	PASS
WCDMA Band5 Subtest5	4132	826.4	21.61	37	PASS
WCDMA Band5 Subtest5	4182	836.4	21.54	37	PASS
WCDMA Band5 Subtest5	4233	846.6	21.42	37	PASS

8.2 PEAK-TO-AVERAGE RATIO

Band	Channel	Frequency (MHz)	Result (dB)	high Limit (dB)	Verdict
GSM850	128	824.2	2.65	13	PASS
GSM850	189	836.4	2.65	13	PASS
GSM850	251	848.8	2.65	13	PASS
GSM1900	512	1850.2	2.66	13	PASS
GSM1900	661	1880	2.66	13	PASS
GSM1900	810	1909.8	2.66	13	PASS
GPRS850	128	824.2	2.67	13	PASS
GPRS850	189	836.4	2.66	13	PASS
GPRS850	251	848.8	2.65	13	PASS
GPRS1900	512	1850.2	2.66	13	PASS
GPRS1900	661	1880	2.66	13	PASS
GPRS1900	810	1909.8	2.66	13	PASS
EGPRS850	128	824.2	8.28	13	PASS
EGPRS850	189	836.4	8.16	13	PASS
EGPRS850	251	848.8	8.29	13	PASS
EGPRS1900	512	1850.2	6.60	13	PASS
EGPRS1900	661	1880	6.52	13	PASS
EGPRS1900	810	1909.8	7.35	13	PASS
WCDMA Band2	9262	1852.4	2.92	13	PASS
WCDMA Band2	9400	1880	2.95	13	PASS
WCDMA Band2	9538	1907.6	3.22	13	PASS
WCDMA Band4	1312	1712.4	3.07	13	PASS
WCDMA Band4	1412	1732.4	2.96	13	PASS
WCDMA Band4	1513	1752.6	3.10	13	PASS
WCDMA Band5	4132	826.4	2.97	13	PASS
WCDMA Band5	4182	836.4	2.50	13	PASS
WCDMA Band5	4233	846.6	2.82	13	PASS

GSM850 Channel=128

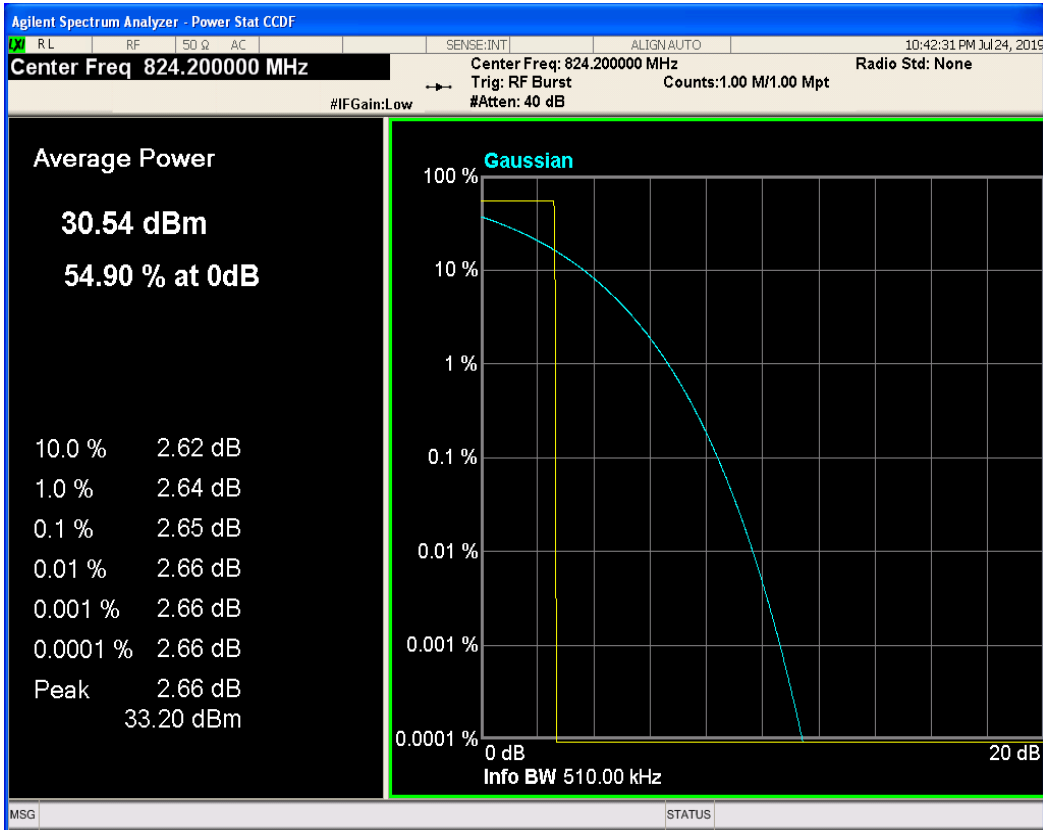

GSM850 Channel=189

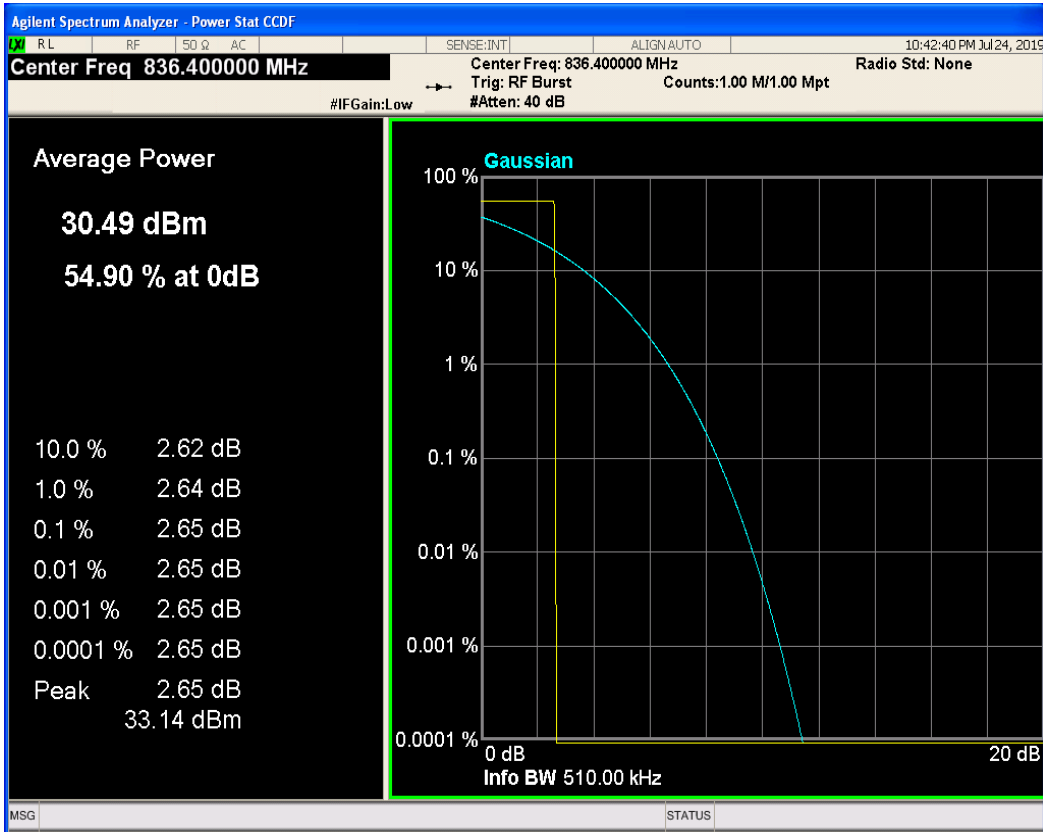

GSM850 Channel=251

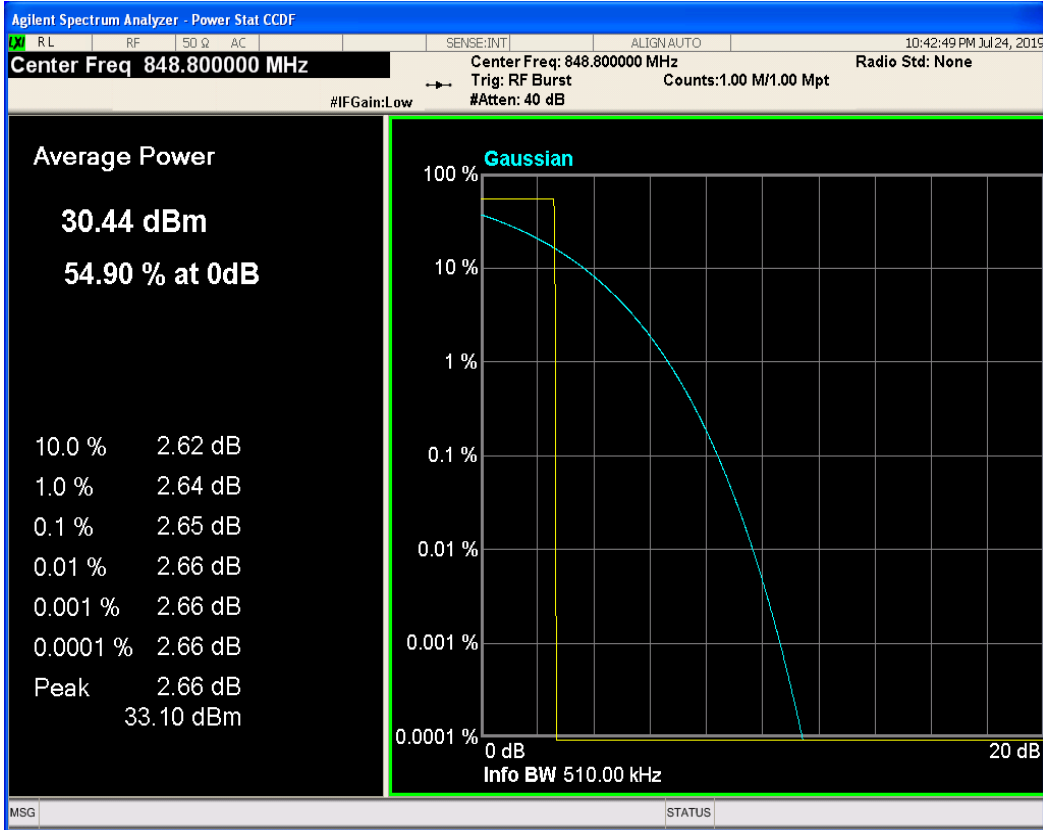

GSM1900 Channel=512

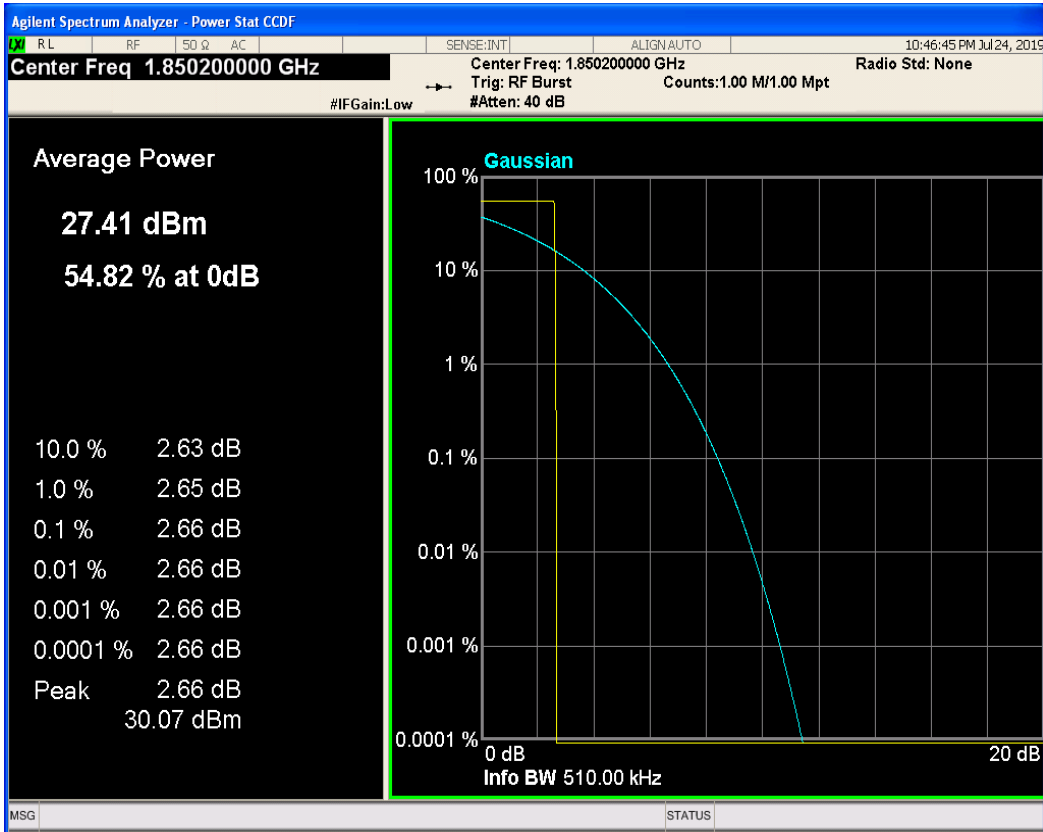

GSM1900 Channel=661

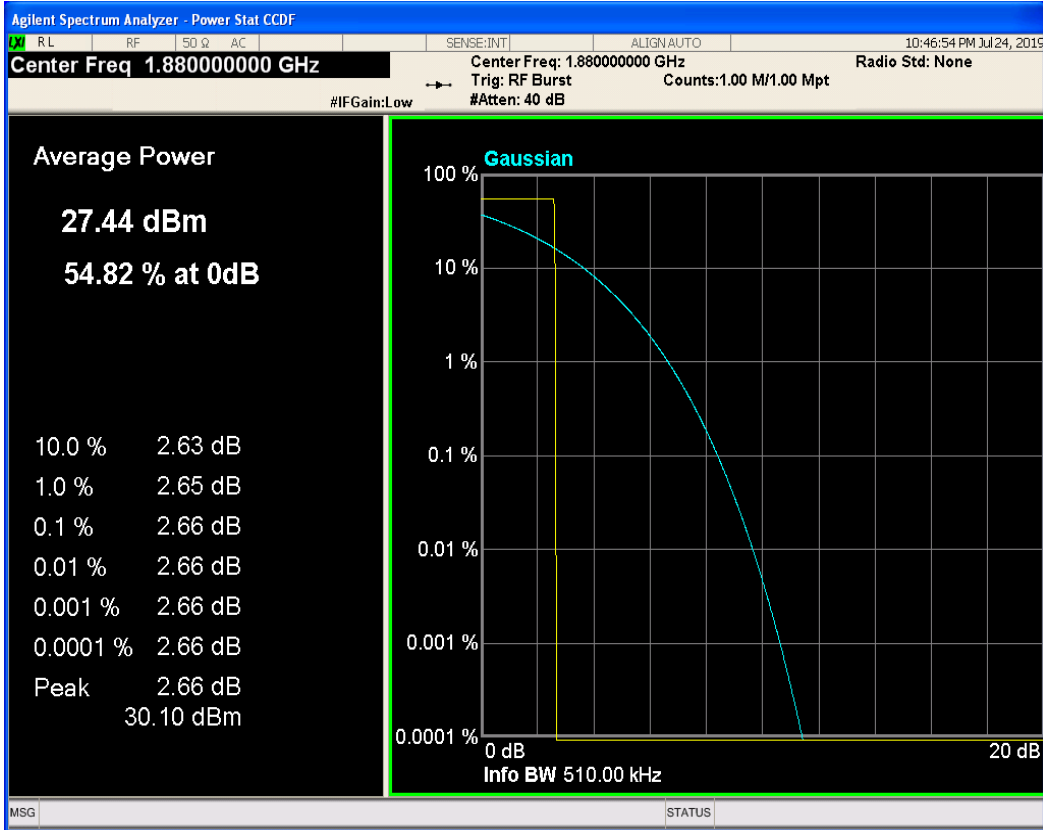

GSM1900 Channel=810

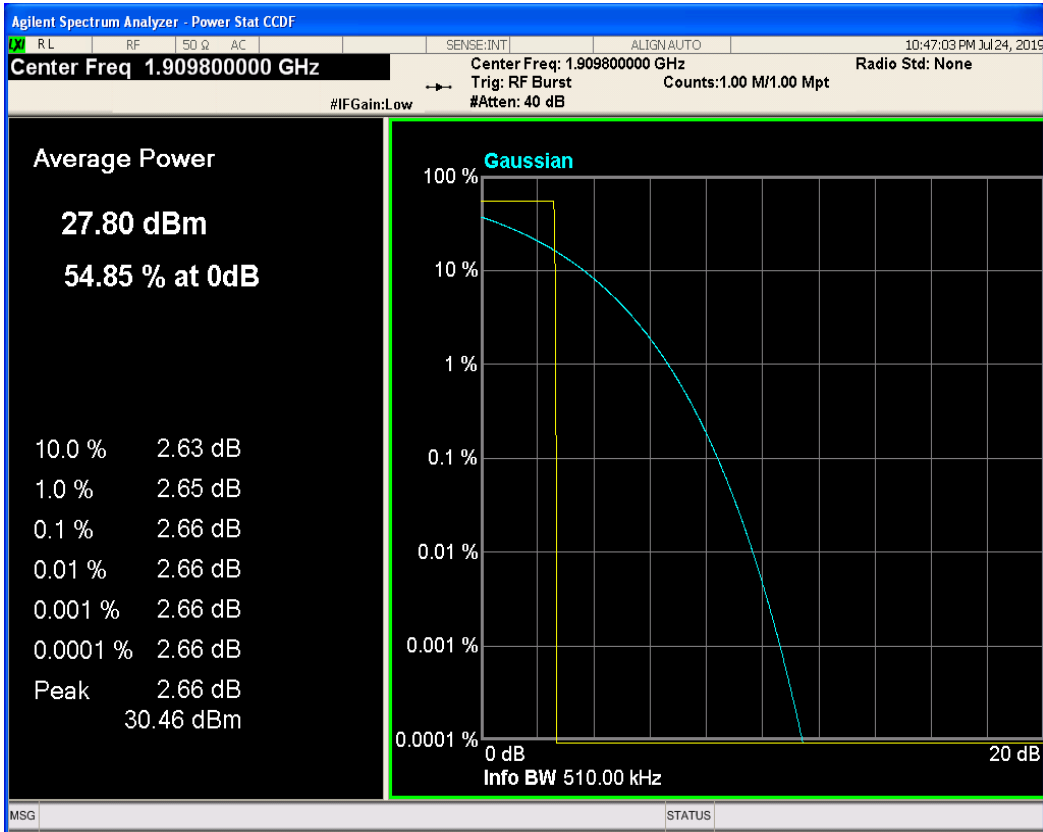

GPRS850 Channel=128

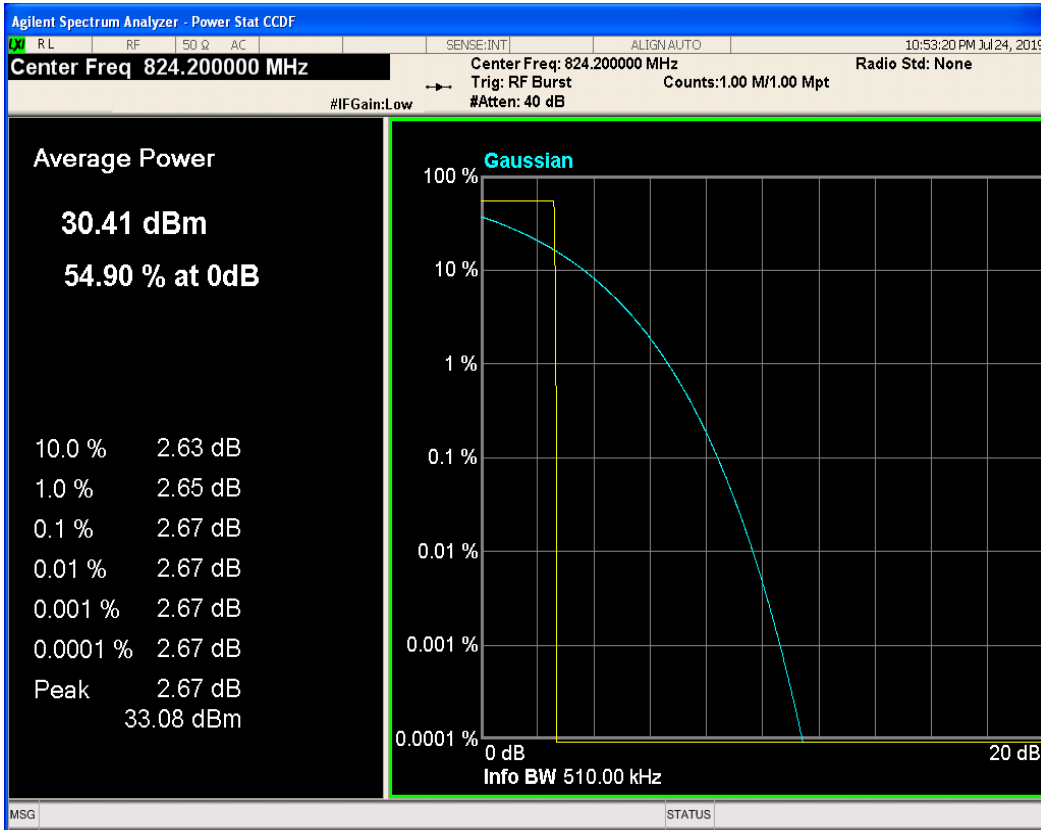

GPRS850 Channel=189

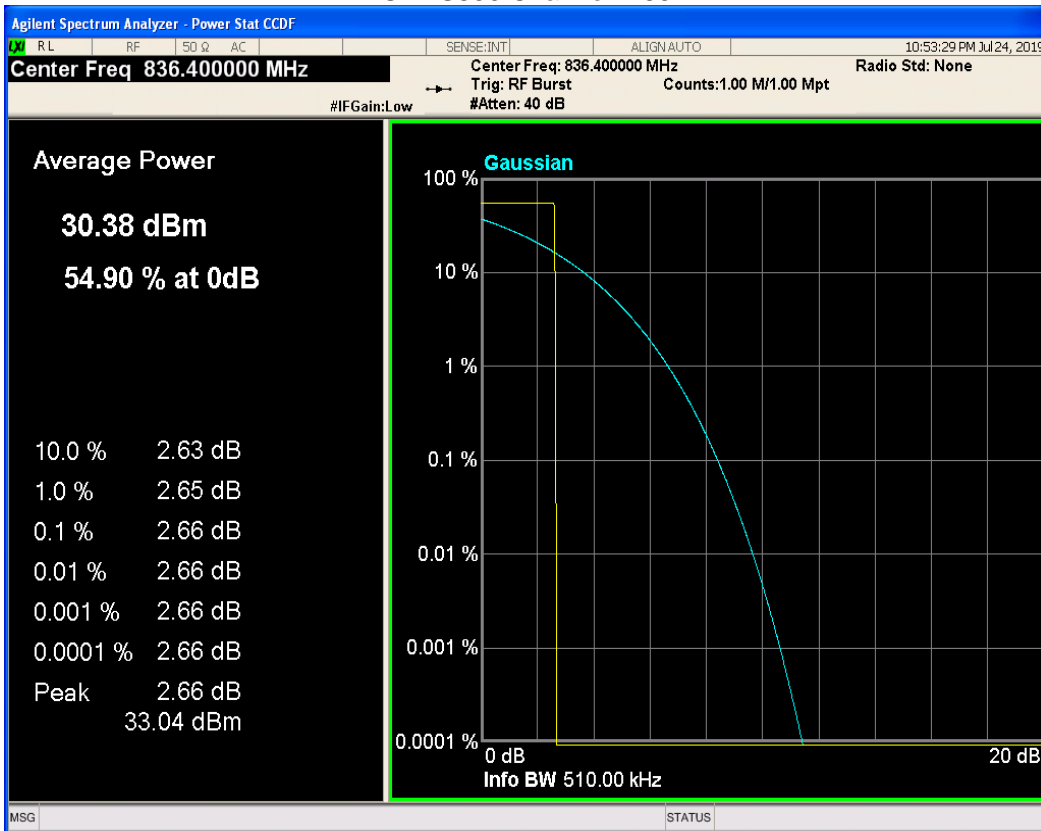

GPRS850 Channel=251

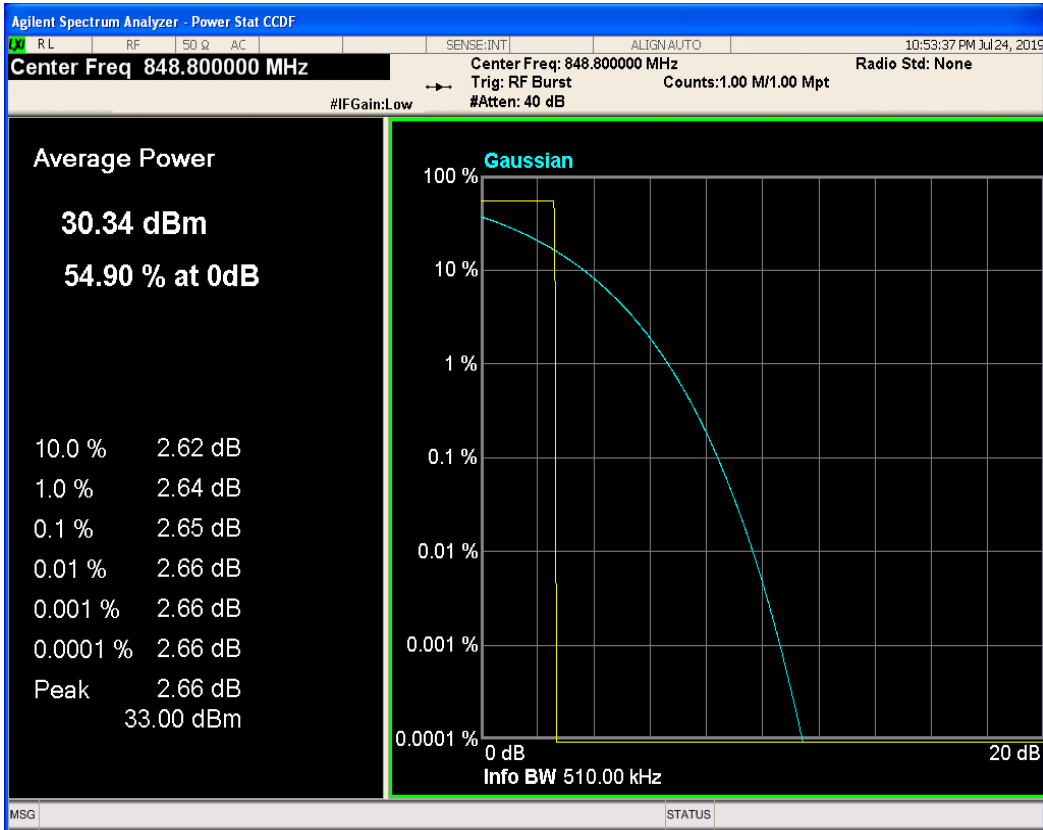

GPRS1900 Channel=512

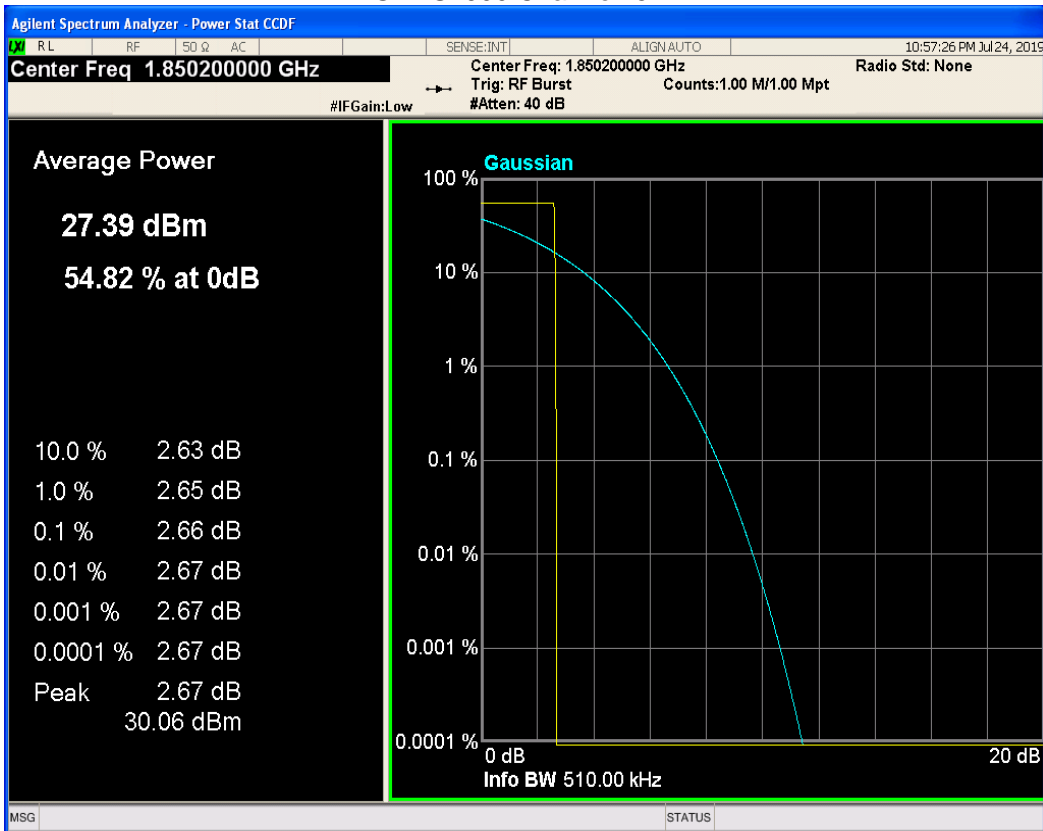

GPRS1900 Channel=661

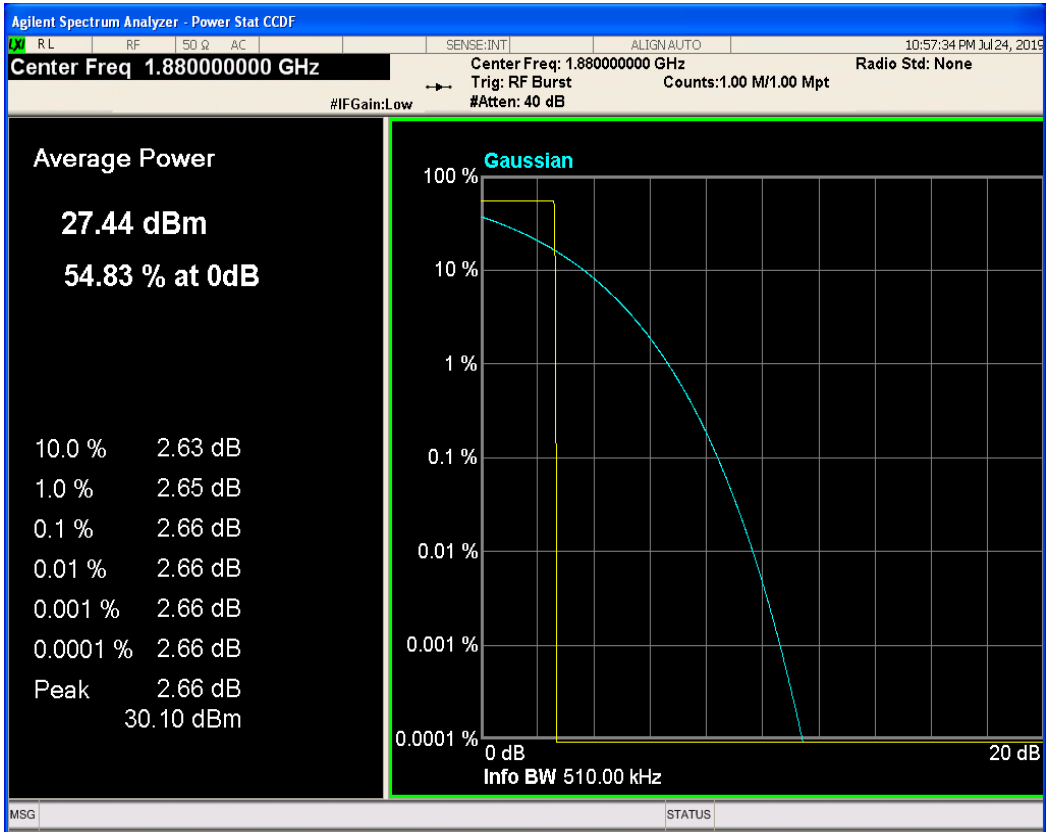

GPRS1900 Channel=810

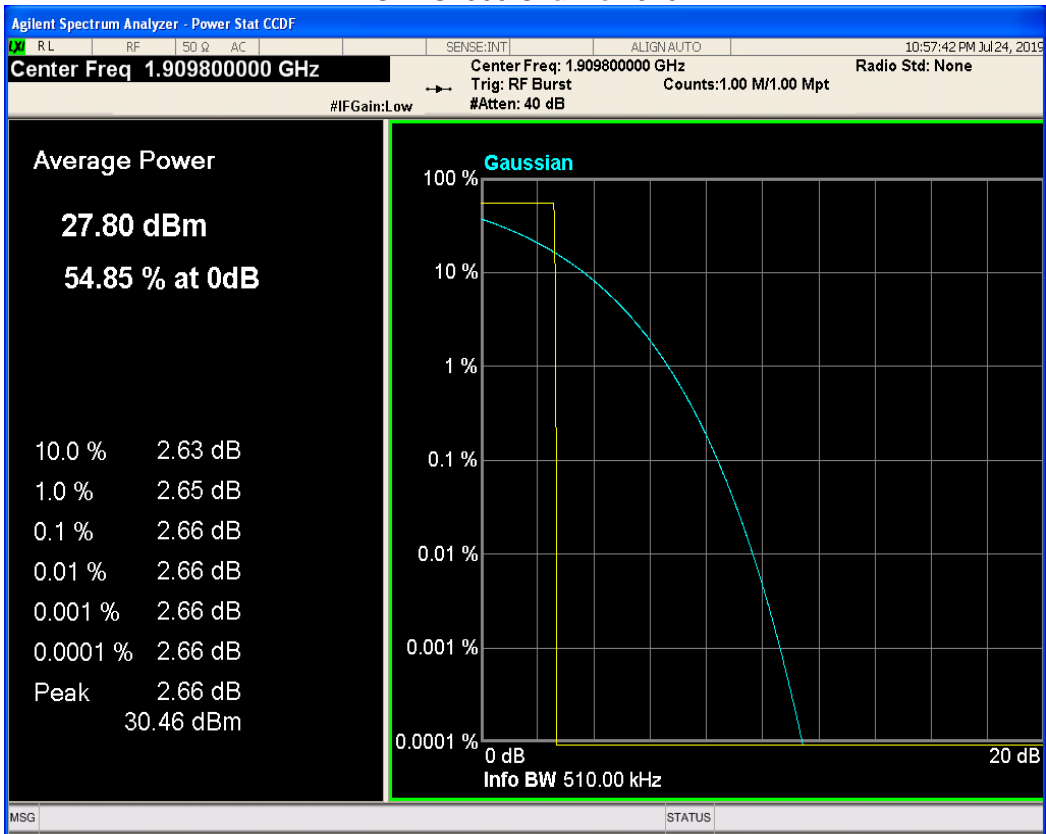

EGPRS850 Channel=128

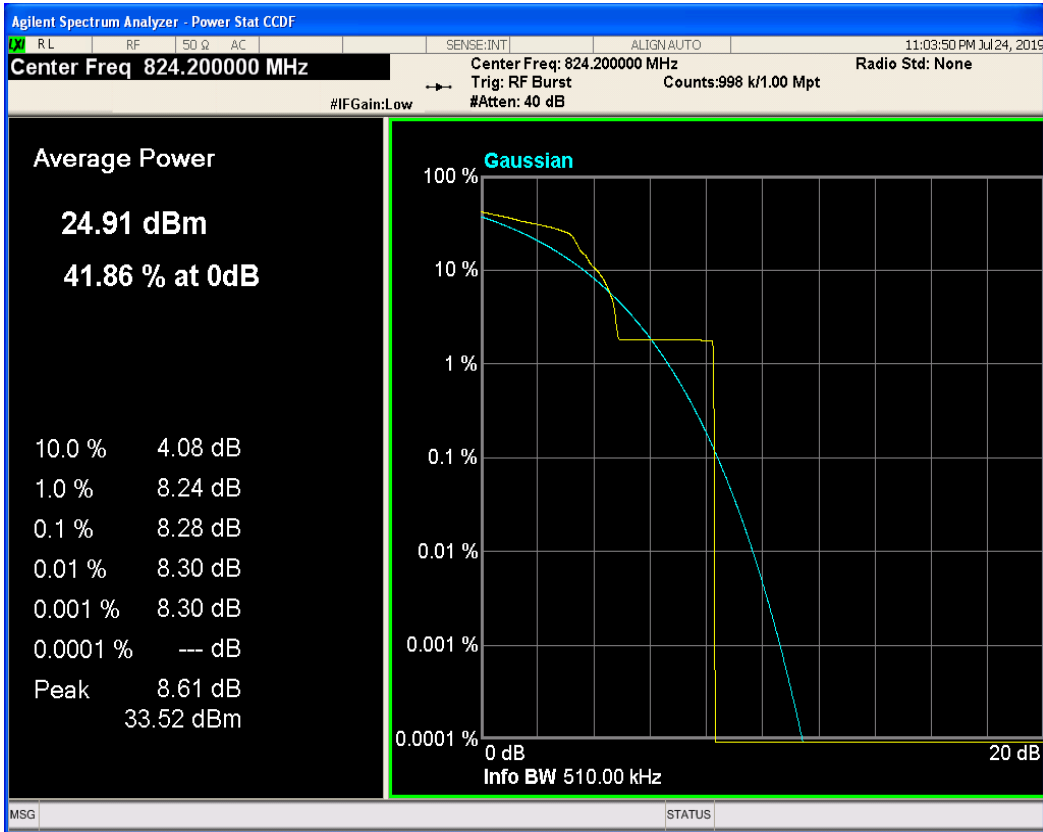

EGPRS850 Channel=189

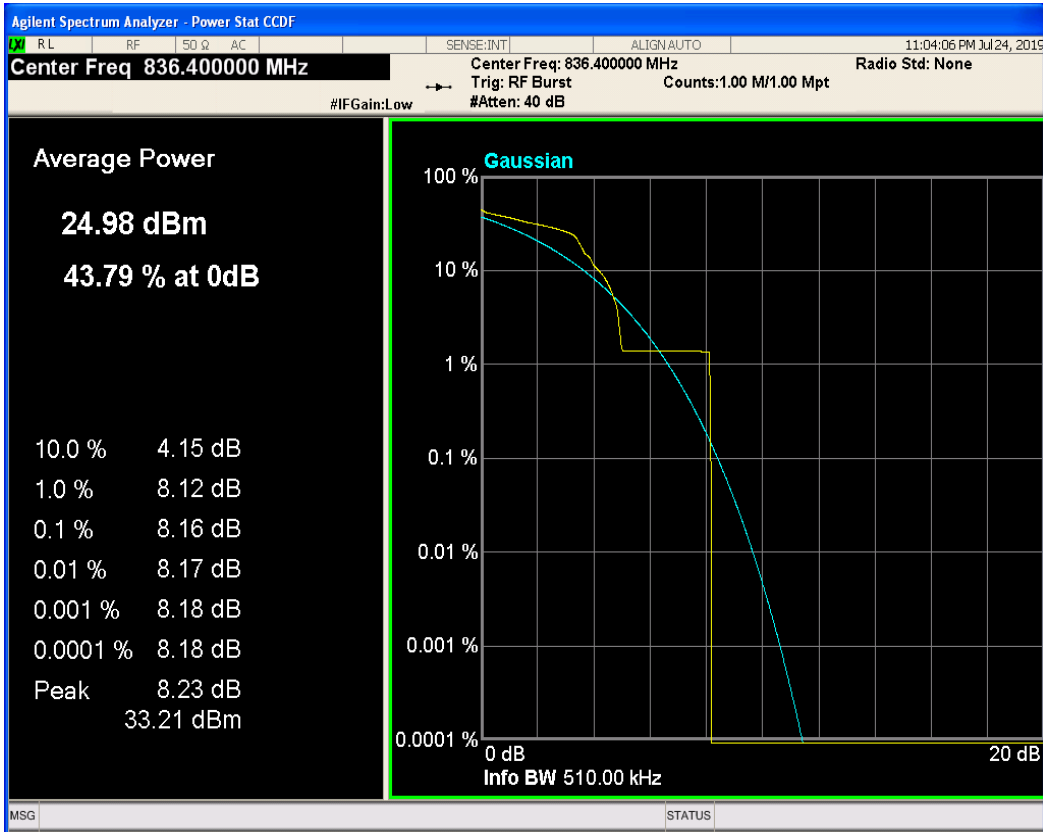

EGPRS850 Channel=251

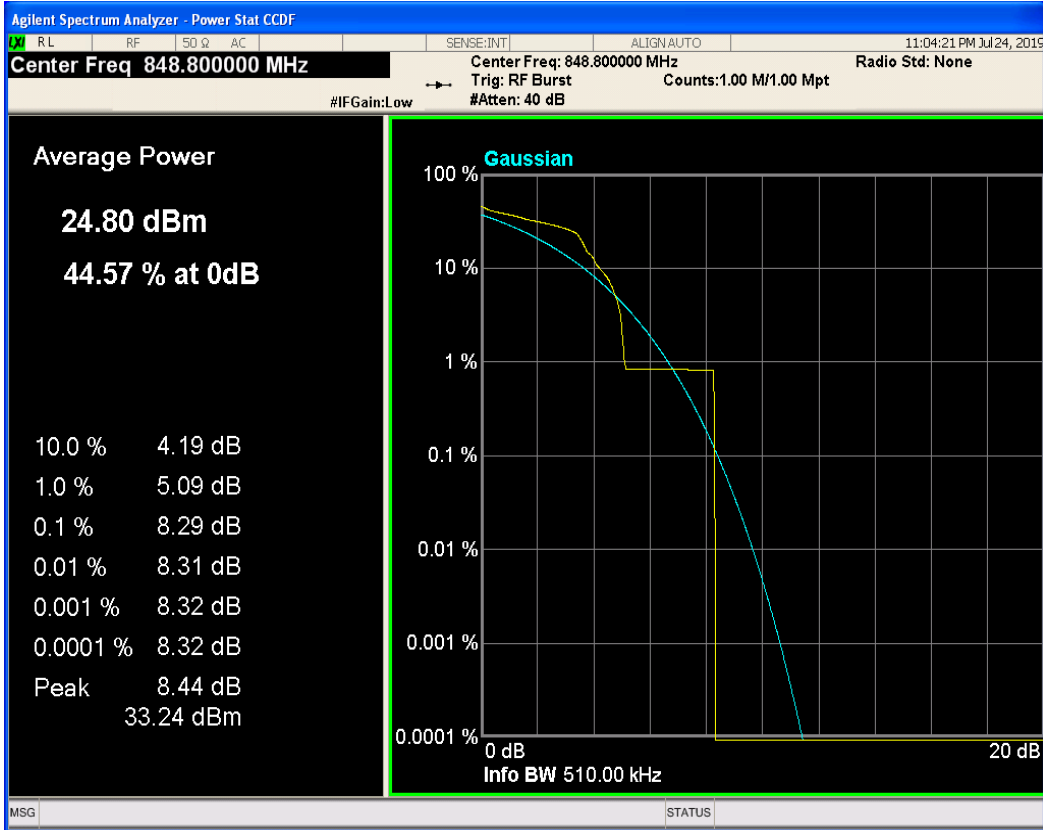

EGPRS1900 Channel=512

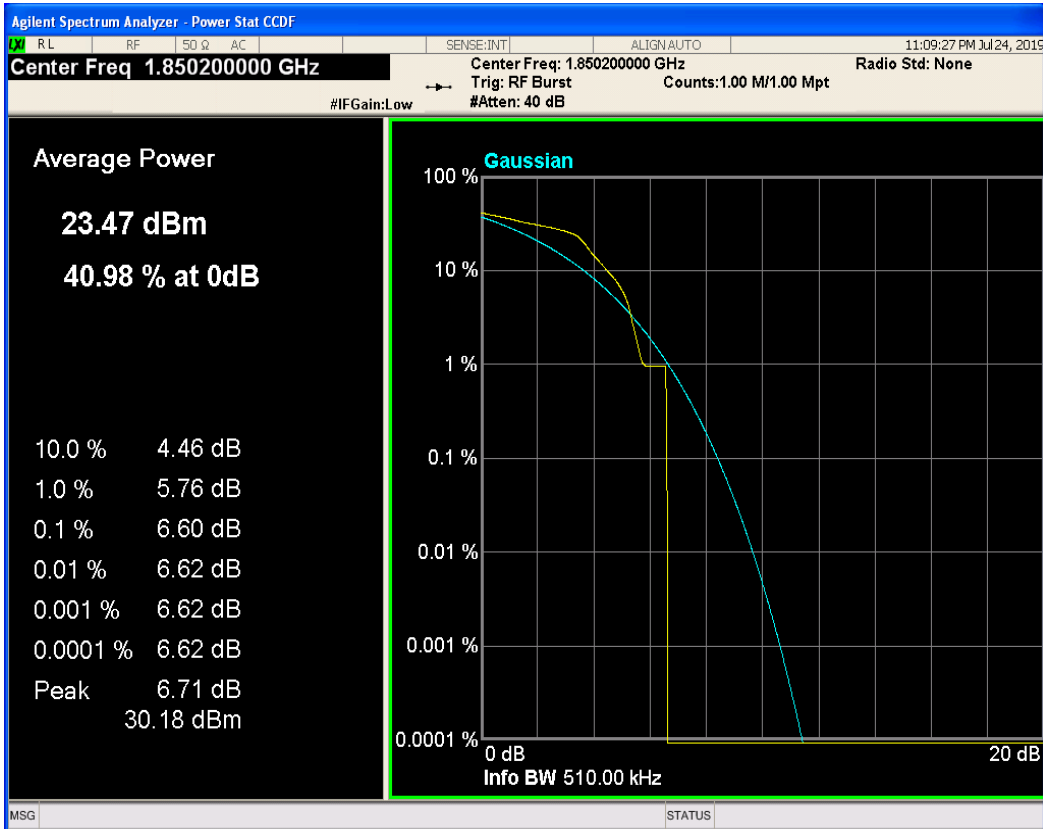

EGPRS1900 Channel=661



EGPRS1900 Channel=810

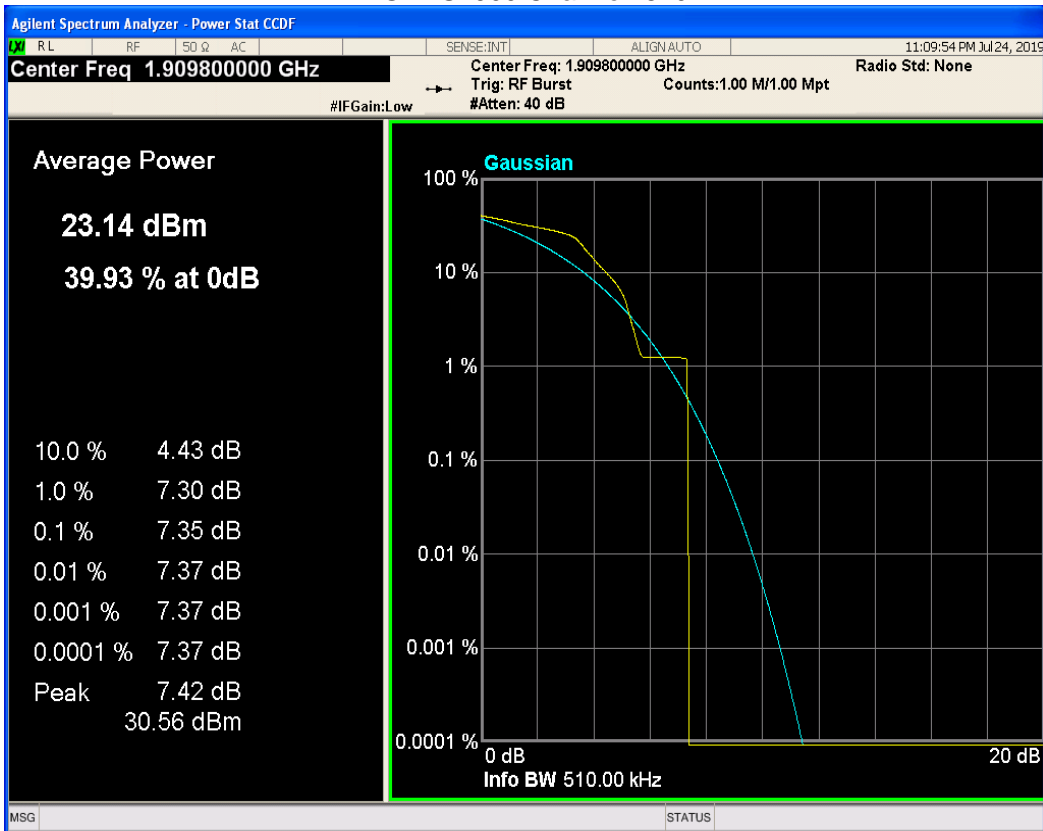

WCDMA Band2 Channel=9262

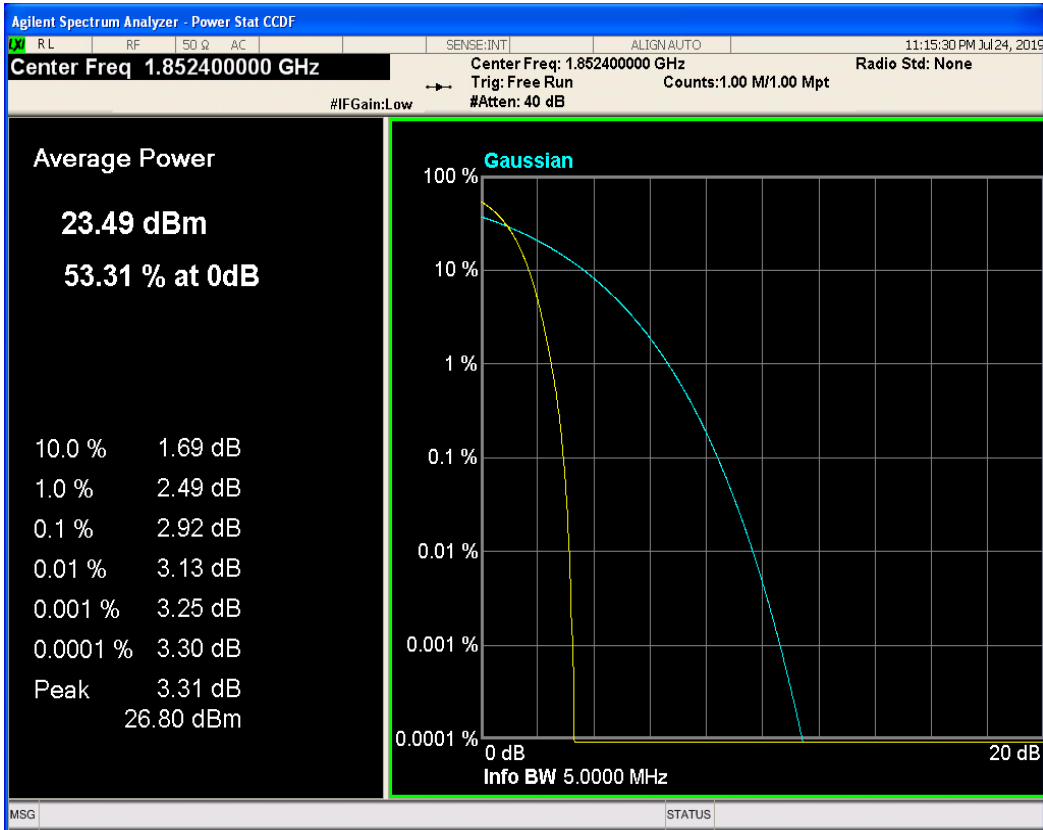

WCDMA Band2 Channel=9400

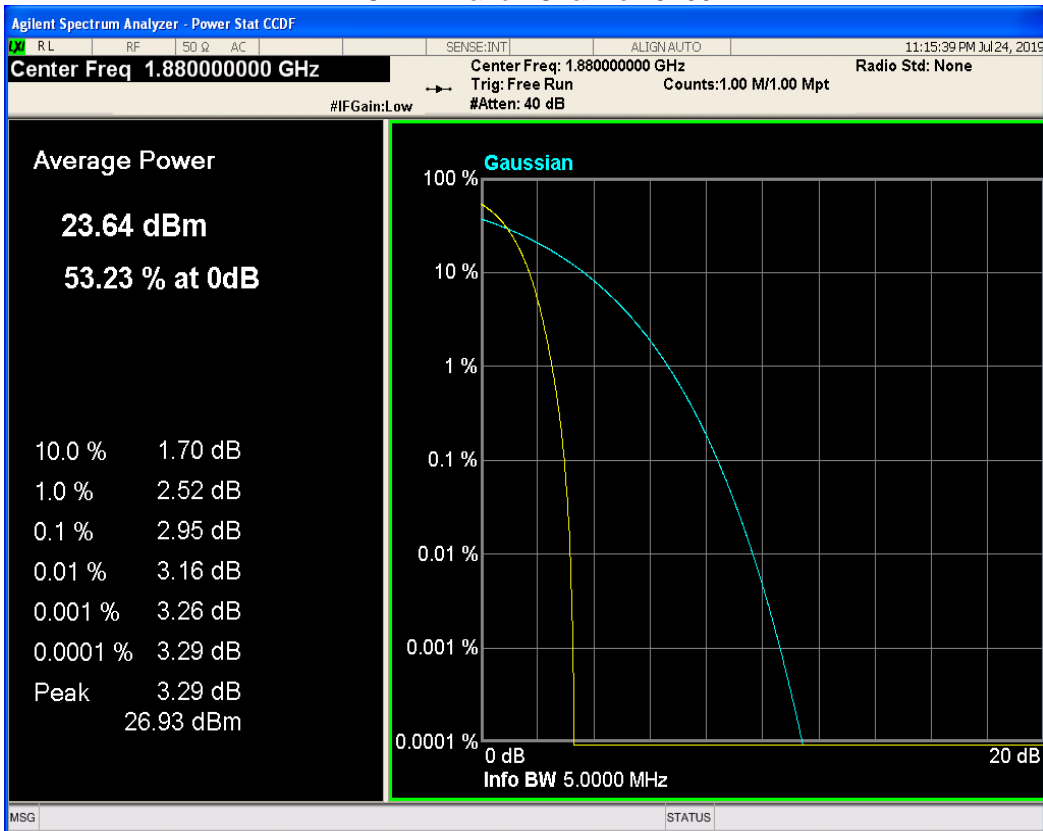

WCDMA Band2 Channel=9538

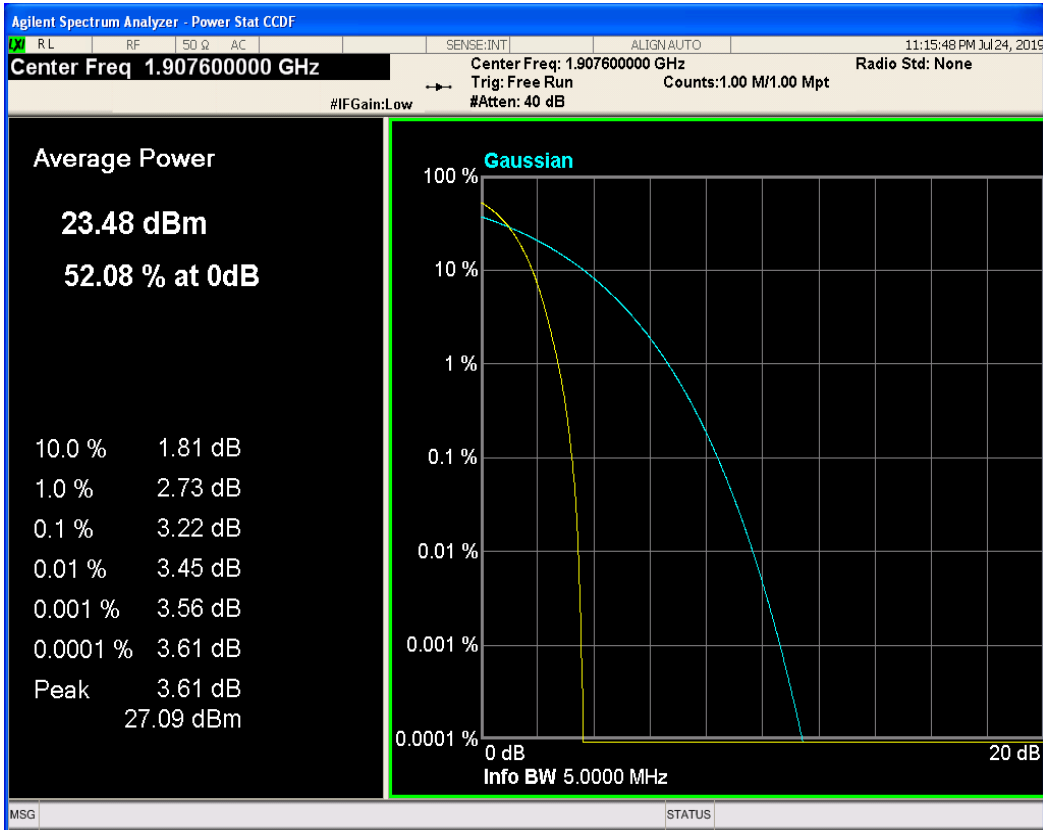

WCDMA Band4 Channel=1513

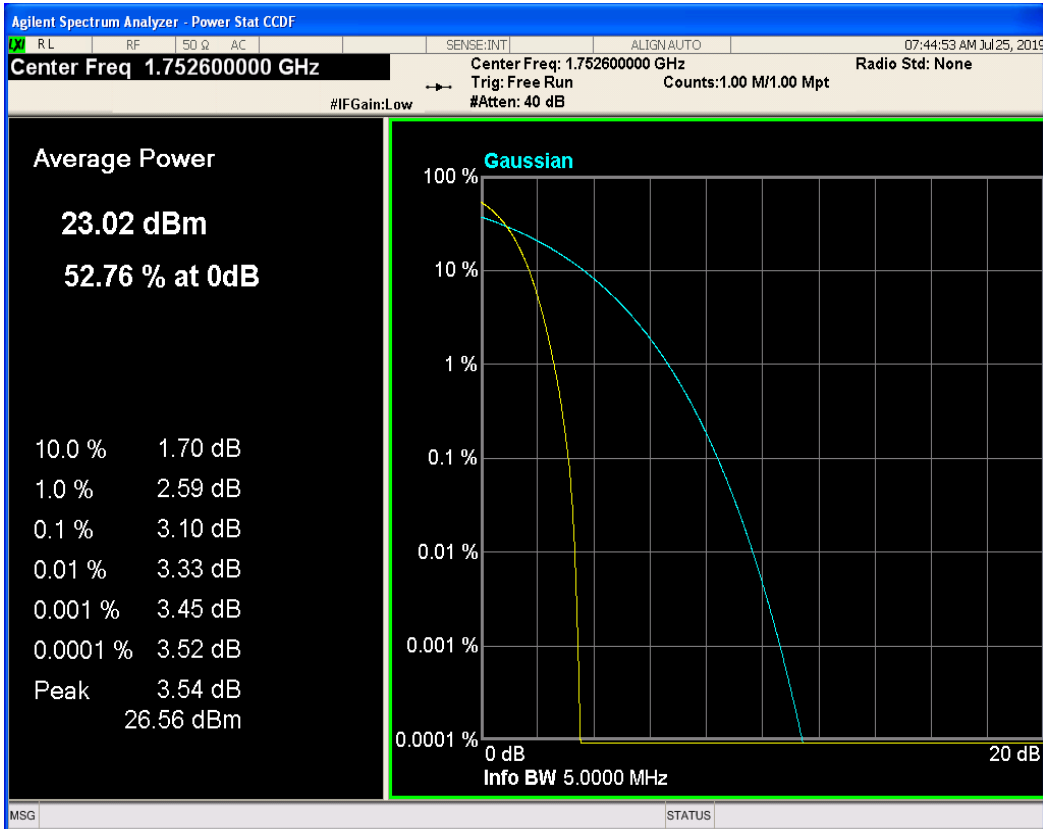

WCDMA Band4 Channel=1412

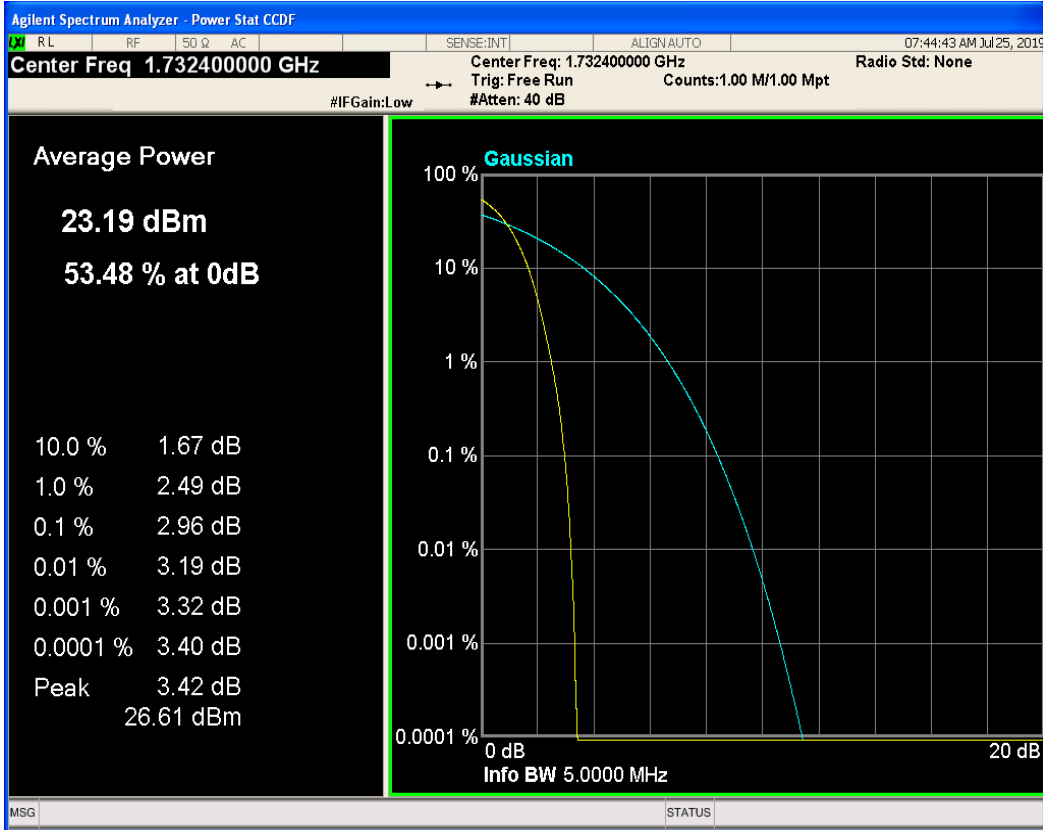

WCDMA Band4 Channel=1312

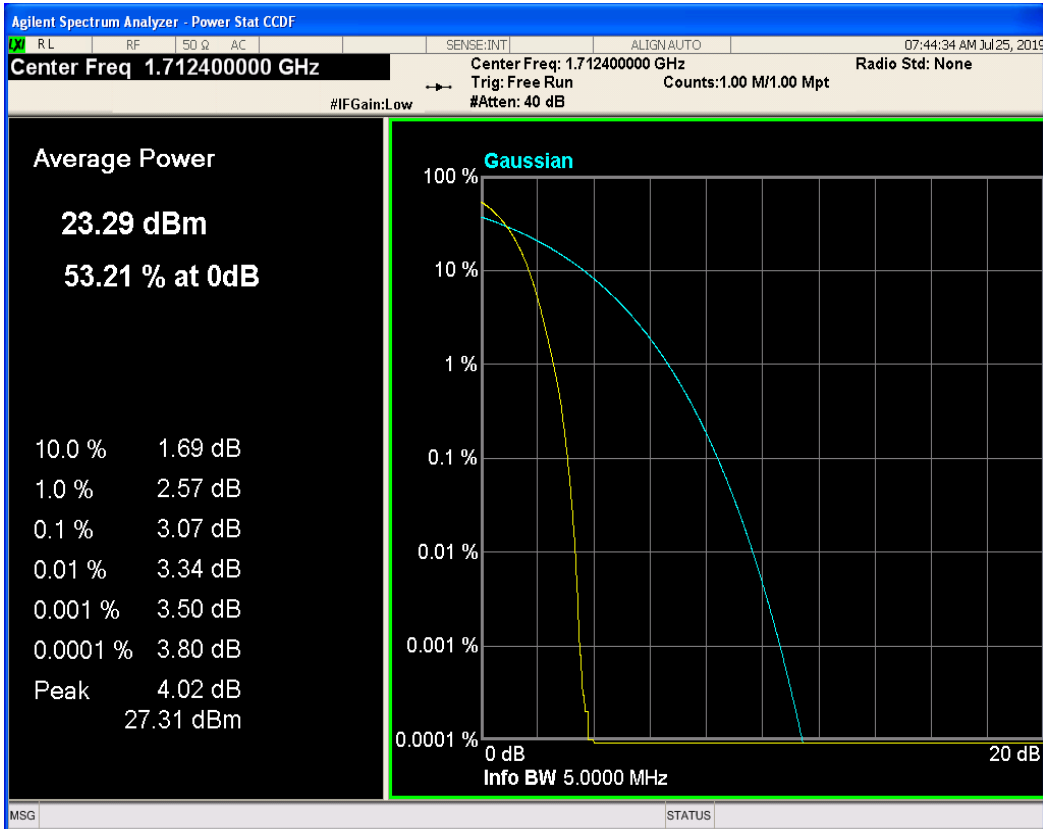

WCDMA Band5 Channel=4132

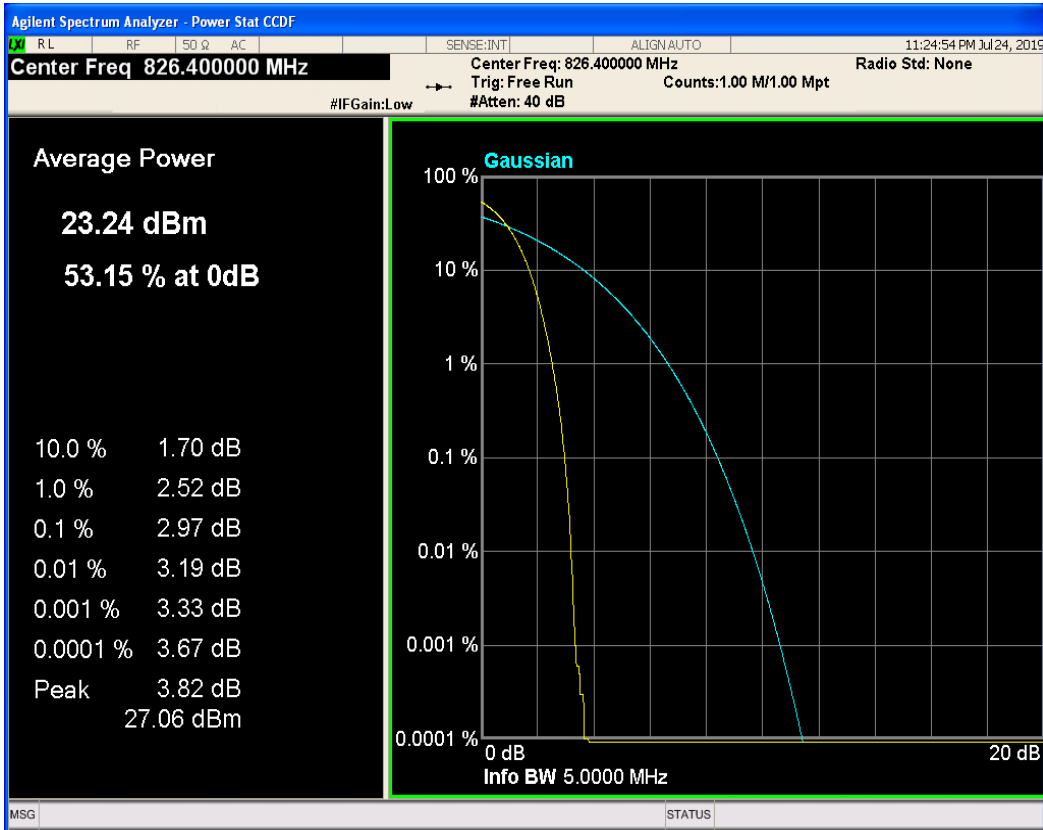

WCDMA Band5 Channel=4182

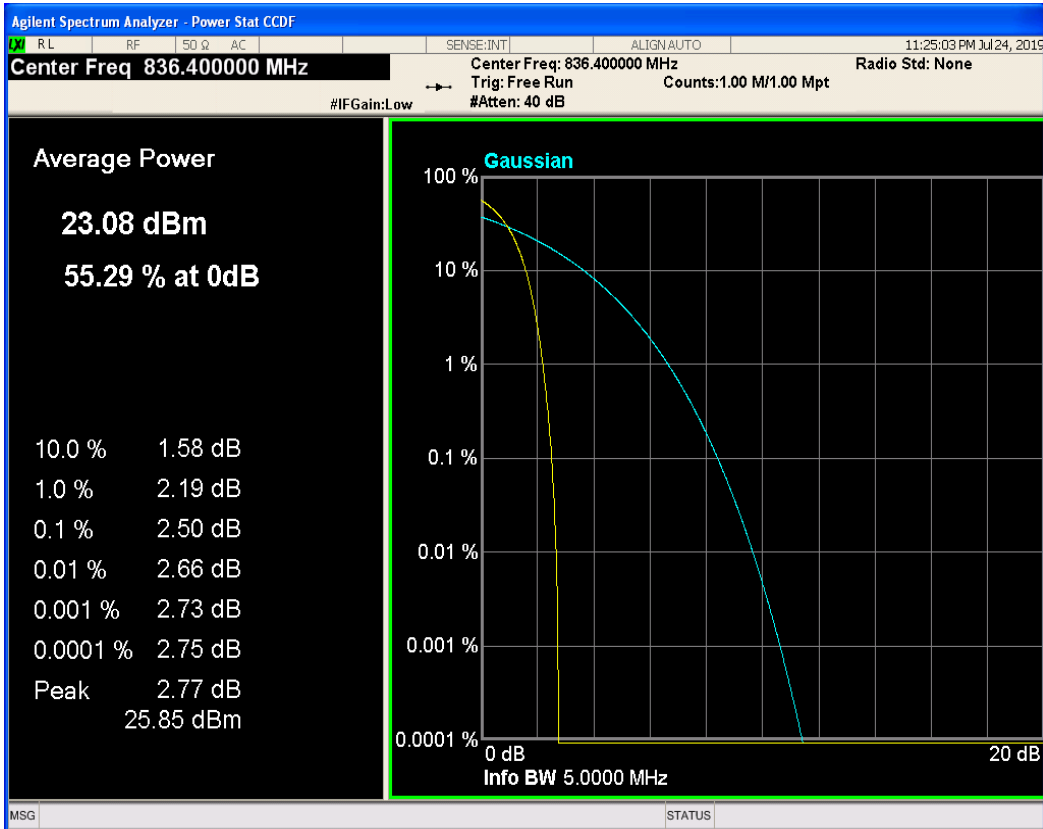

WCDMA Band5 Channel=4233

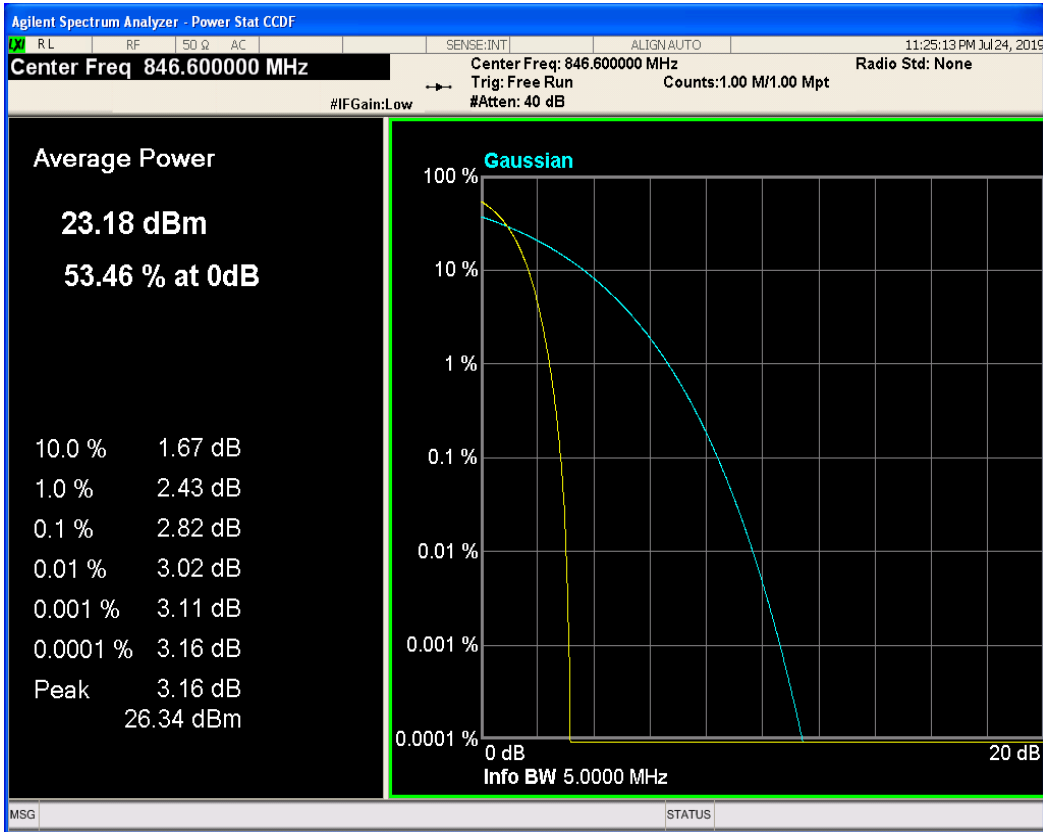

8.3 OCCUPIED BANDWIDTH

Band	Channel	Frequency (MHz)	99% OBW (kHz)	-26dB EBW (kHz)	Verdict
GSM850	128	824.2	245.115	311.637	PASS
GSM850	189	836.4	244.034	319.386	PASS
GSM850	251	848.8	244.458	309.645	PASS
GSM1900	512	1850.2	245.327	311.468	PASS
GSM1900	661	1880	242.511	319.260	PASS
GSM1900	810	1909.8	250.458	312.081	PASS
GPRS850	128	824.2	245.285	308.583	PASS
GPRS850	189	836.4	249.532	320.906	PASS
GPRS850	251	848.8	249.152	311.978	PASS
GPRS1900	512	1850.2	243.629	317.071	PASS
GPRS1900	661	1880	245.222	312.878	PASS
GPRS1900	810	1909.8	247.218	315.925	PASS
EGPRS850	128	824.2	249.249	324.091	PASS
EGPRS850	189	836.4	246.677	298.275	PASS
EGPRS850	251	848.8	237.977	289.571	PASS
EGPRS1900	512	1850.2	238.504	298.340	PASS
EGPRS1900	661	1880	249.212	319.569	PASS
EGPRS1900	810	1909.8	239.481	305.392	PASS
WCDMA Band2	9262	1852.4	4179.044	4683.103	PASS
WCDMA Band2	9400	1880	4170.991	4729.093	PASS
WCDMA Band2	9538	1907.6	4177.234	4720.507	PASS
WCDMA Band4	1312	1712.4	4174.547	4696.831	PASS
WCDMA Band4	1412	1732.4	4180.126	4704.555	PASS
WCDMA Band4	1513	1752.6	4183.440	4703.682	PASS
WCDMA Band5	4132	826.4	4161.560	4678.213	PASS
WCDMA Band5	4182	836.4	4168.150	4718.969	PASS
WCDMA Band5	4233	846.6	4176.406	4691.189	PASS

GSM850 Channel=189

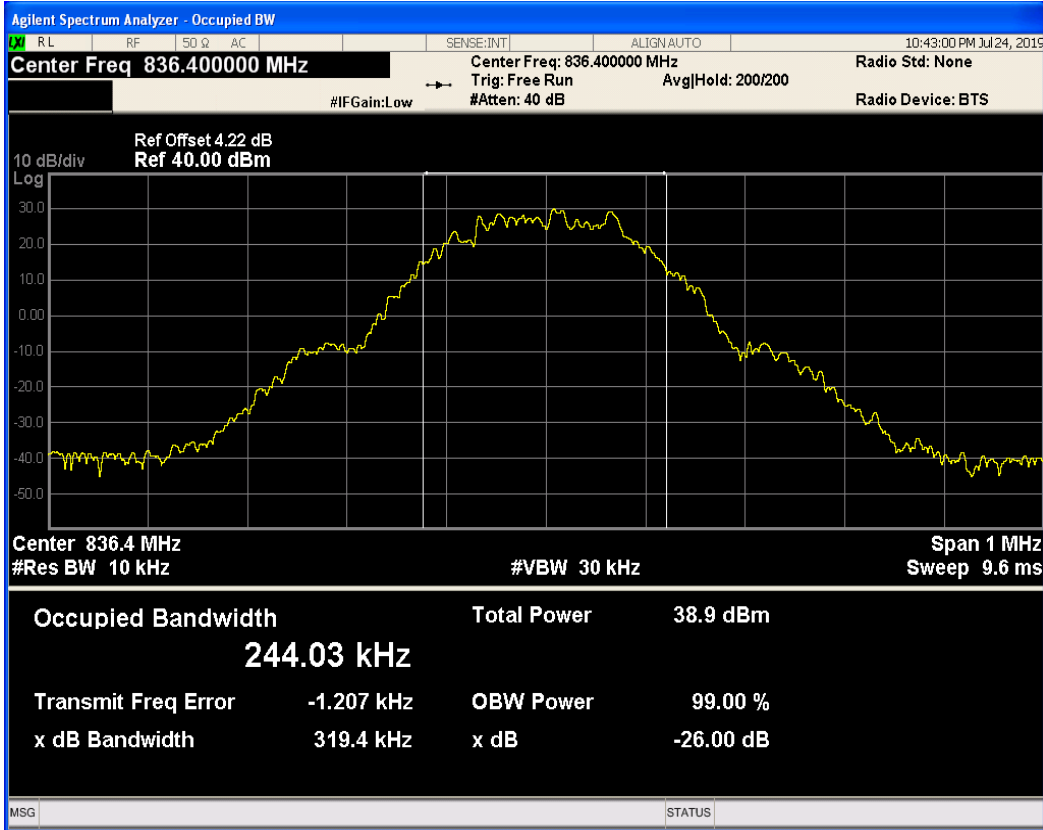

GSM850 Channel=128

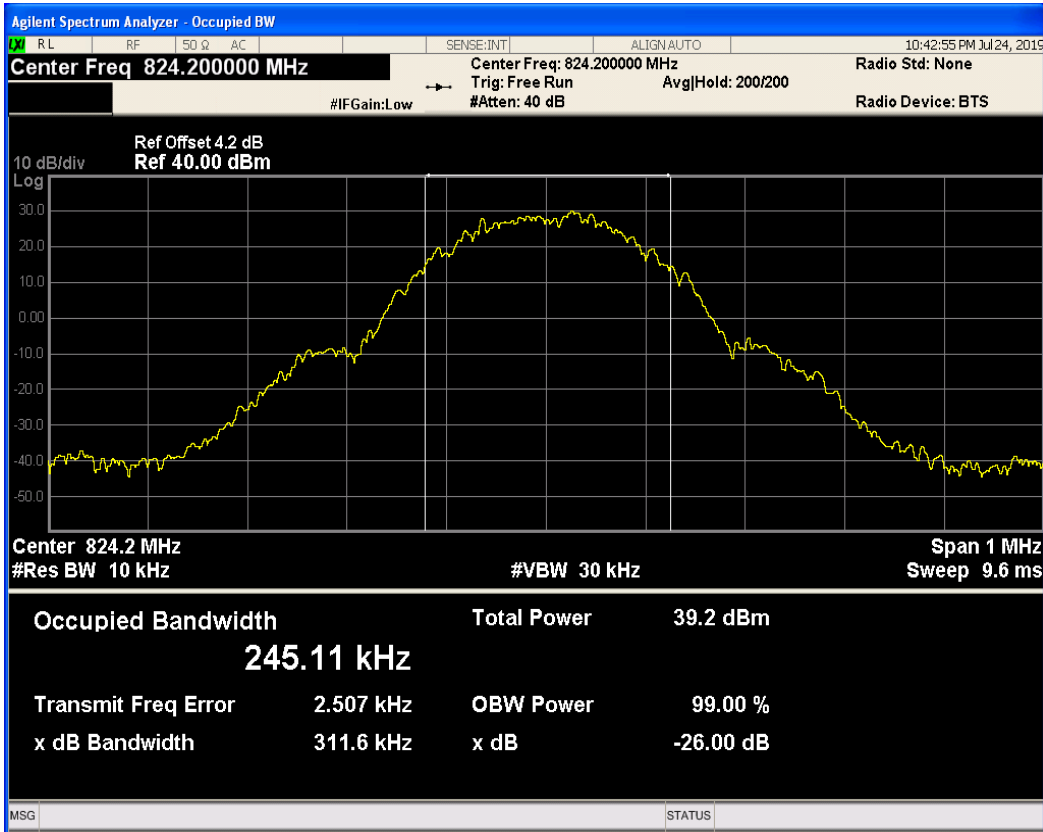

GSM850 Channel=251

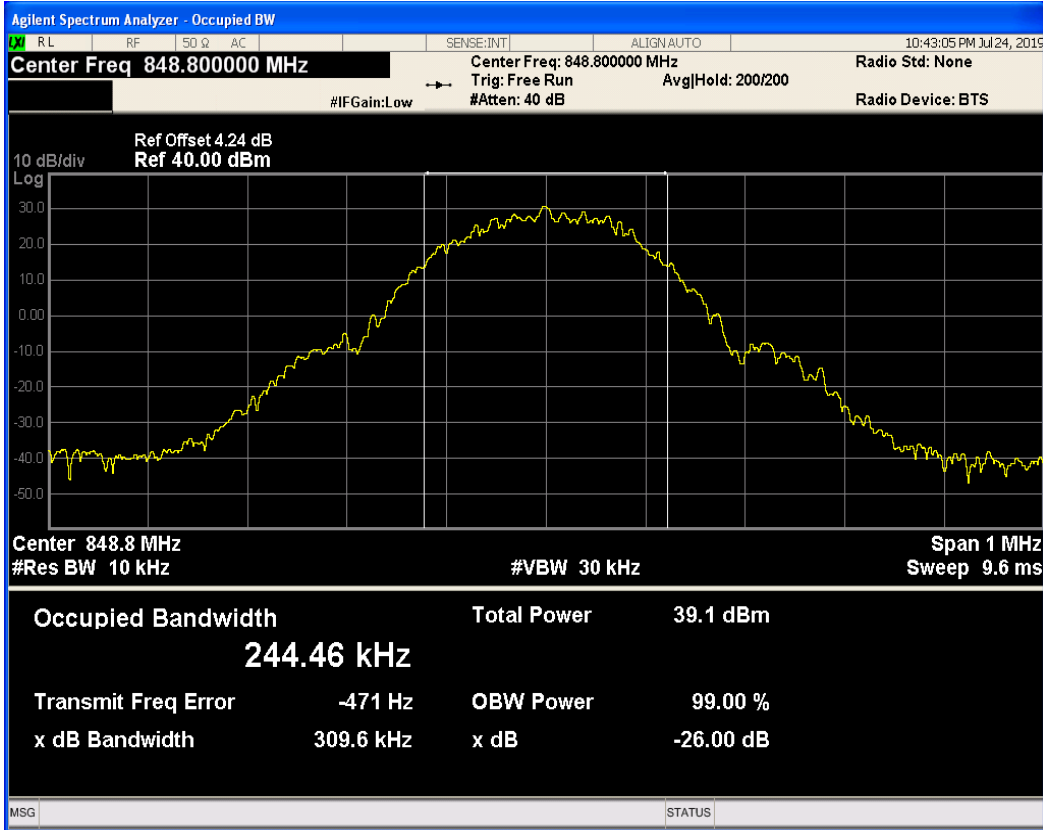

GSM1900 Channel=661

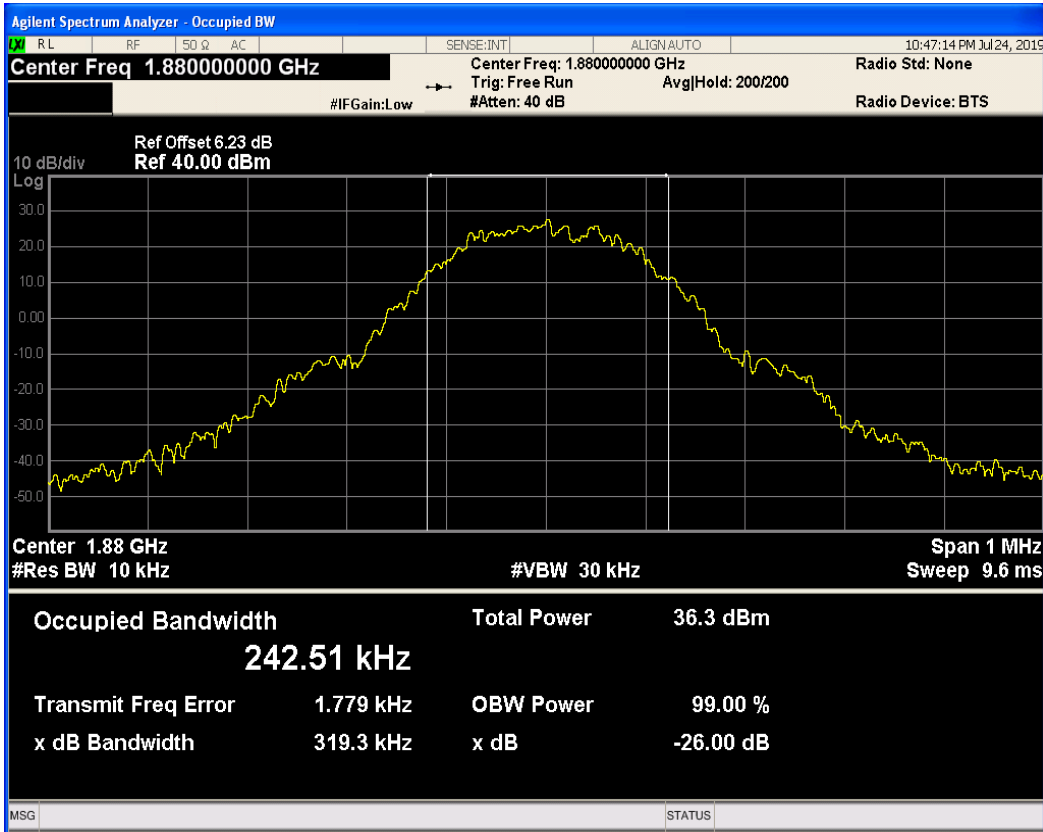

GSM1900 Channel=512

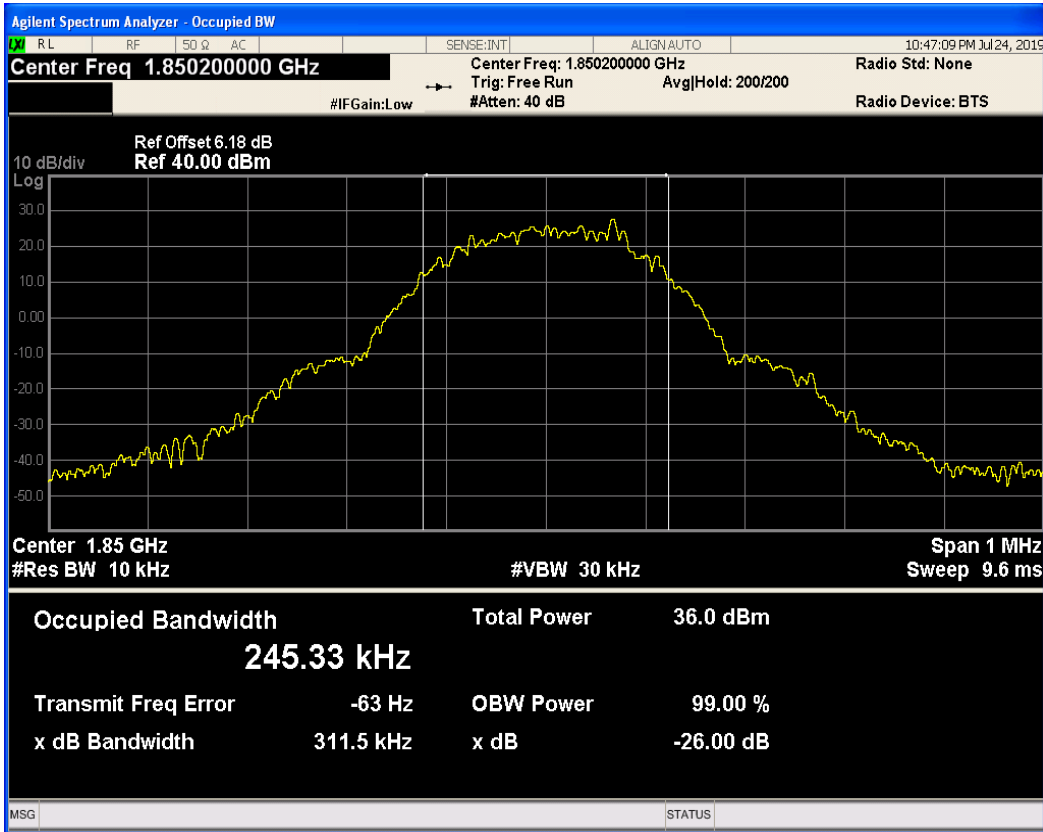

GSM1900 Channel=810

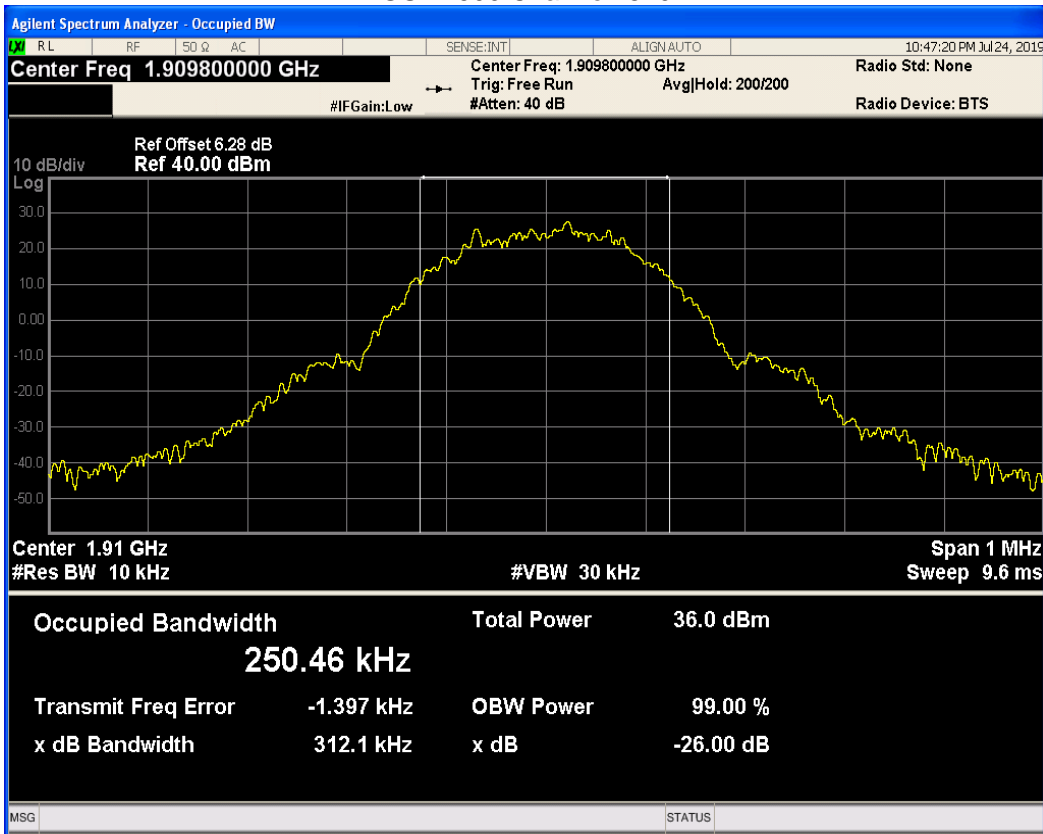

GPRS850 Channel=128

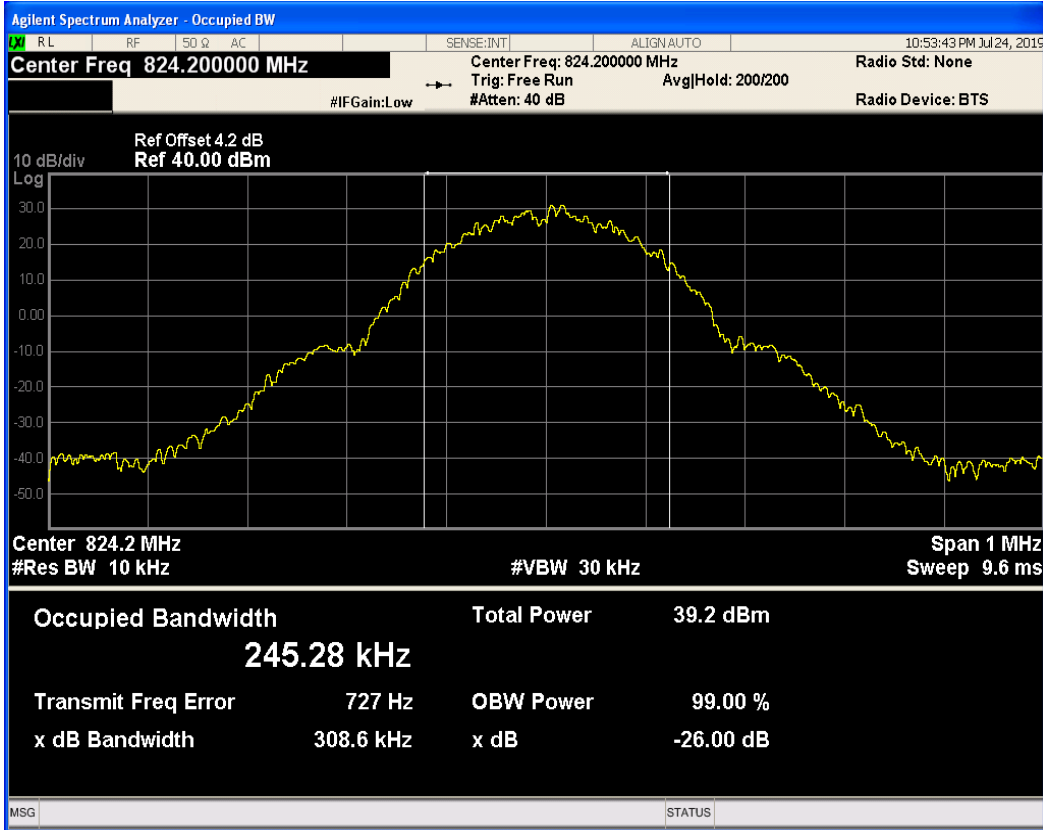

GPRS850 Channel=189

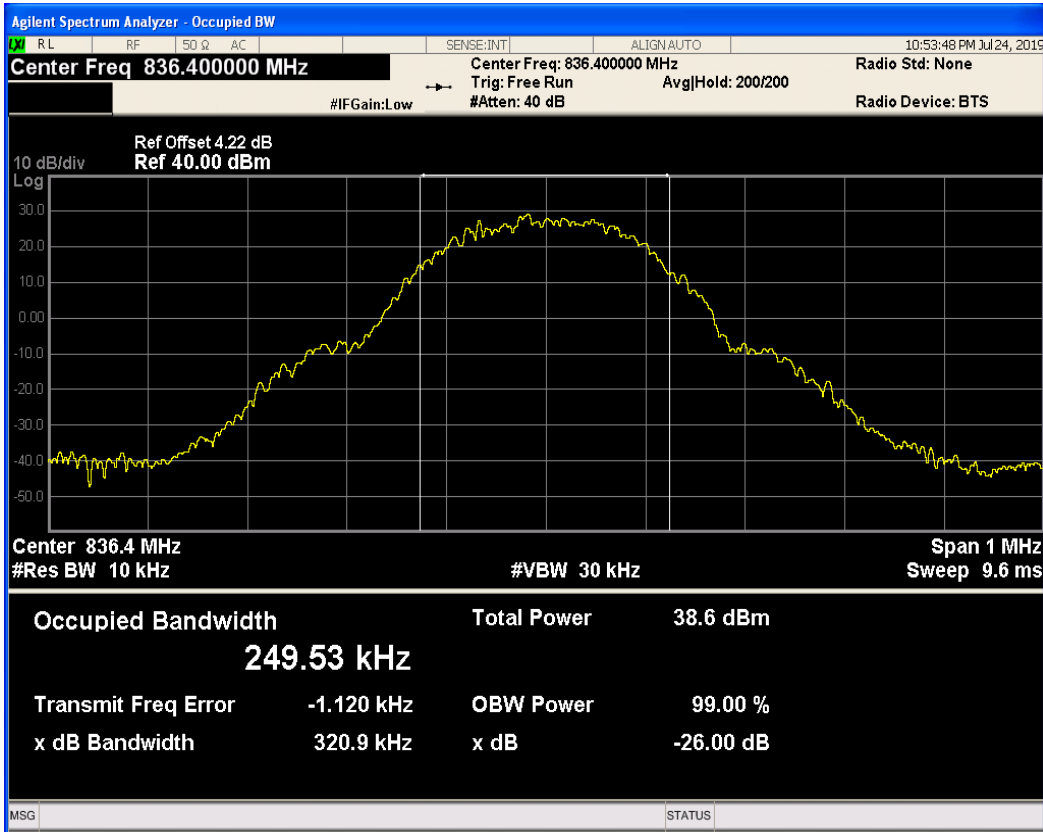

GPRS850 Channel=251

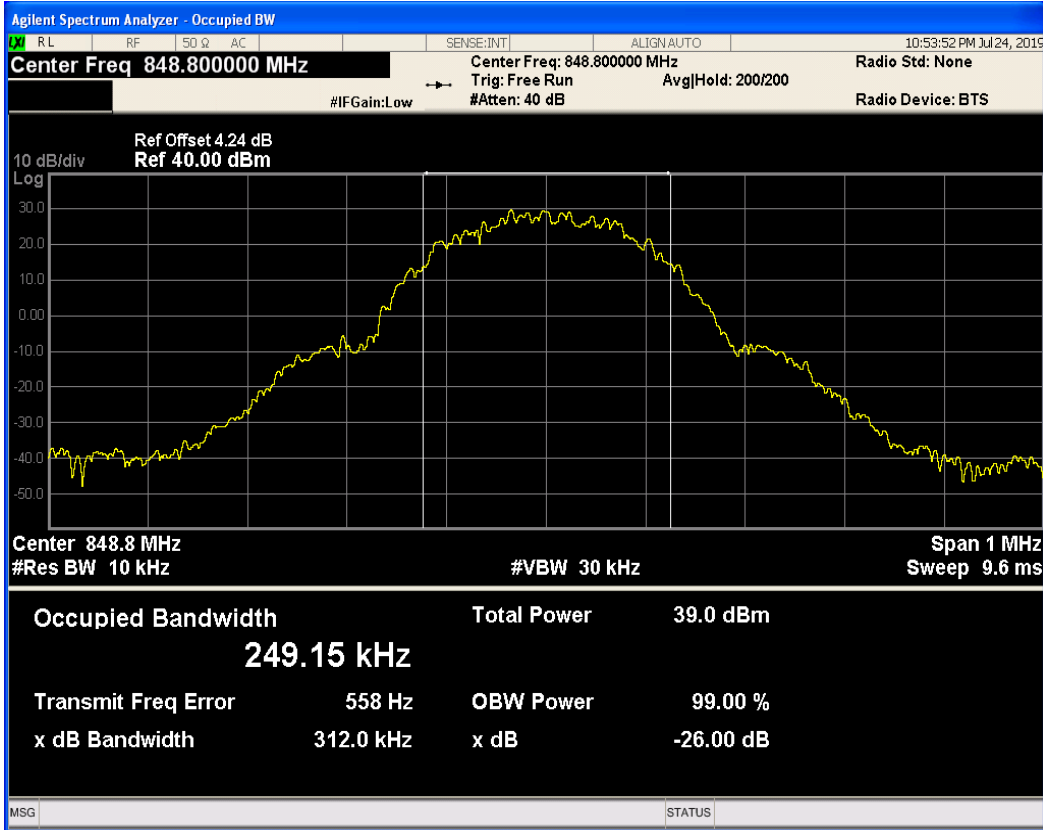

GPRS1900 Channel=512

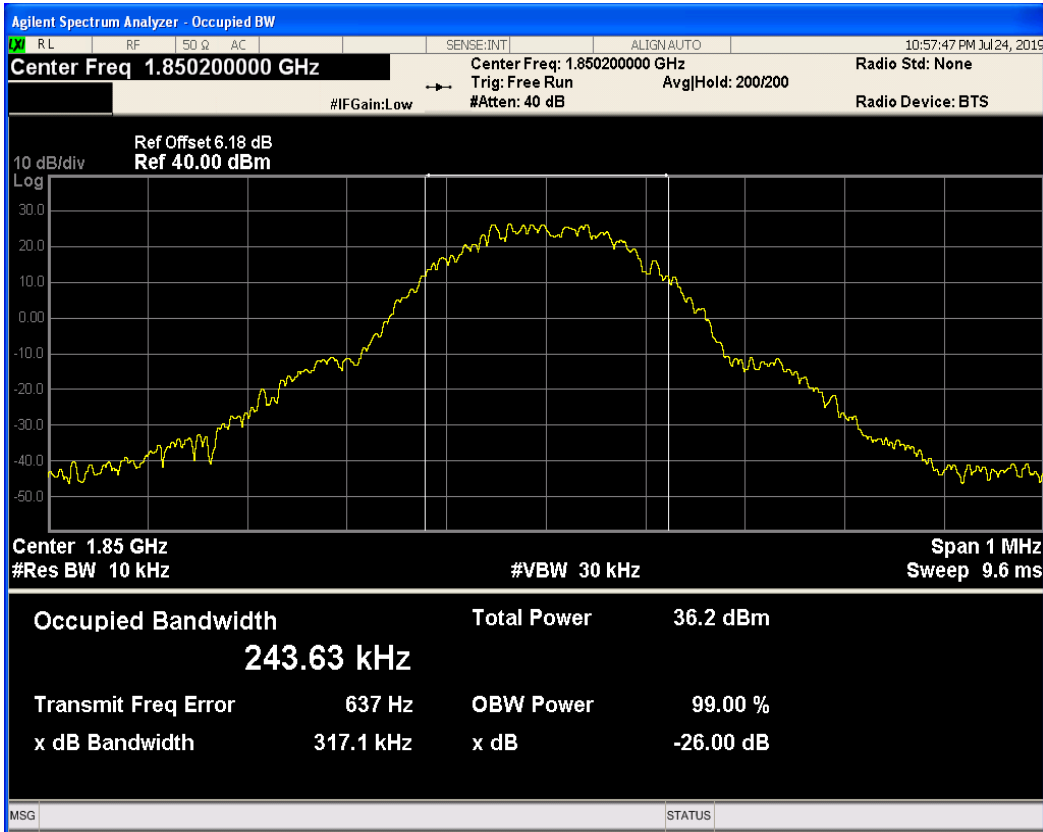

GPRS1900 Channel=661

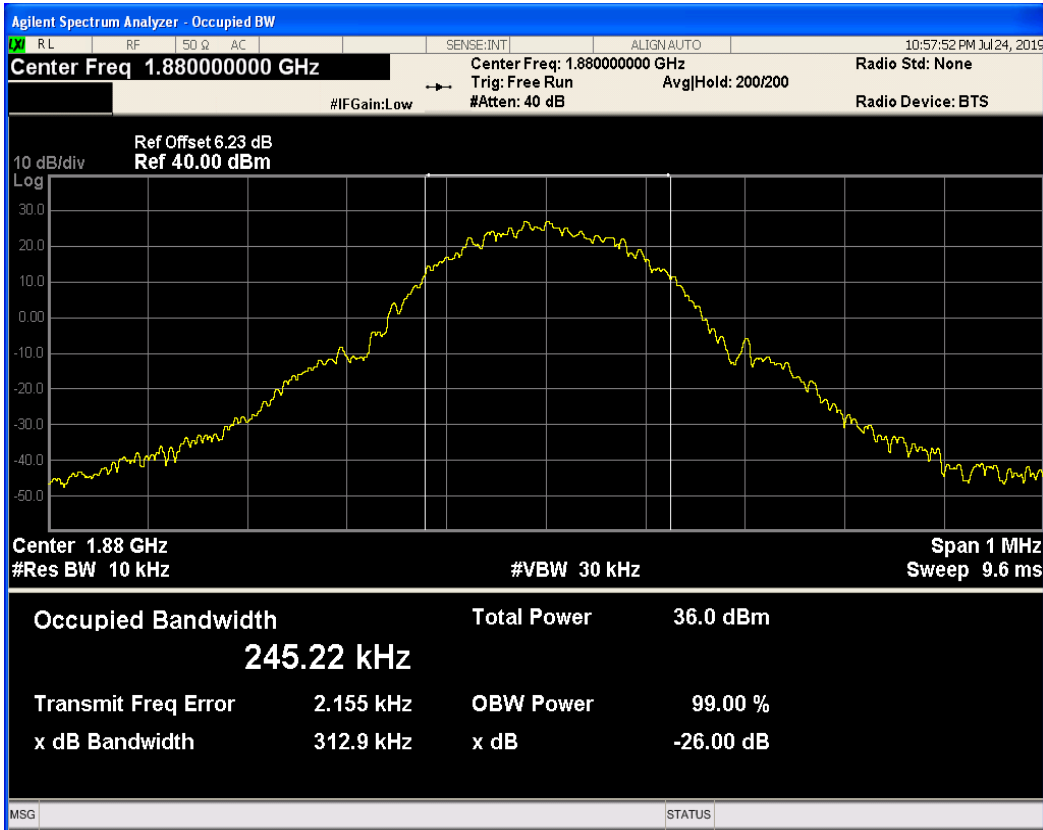

GPRS1900 Channel=810

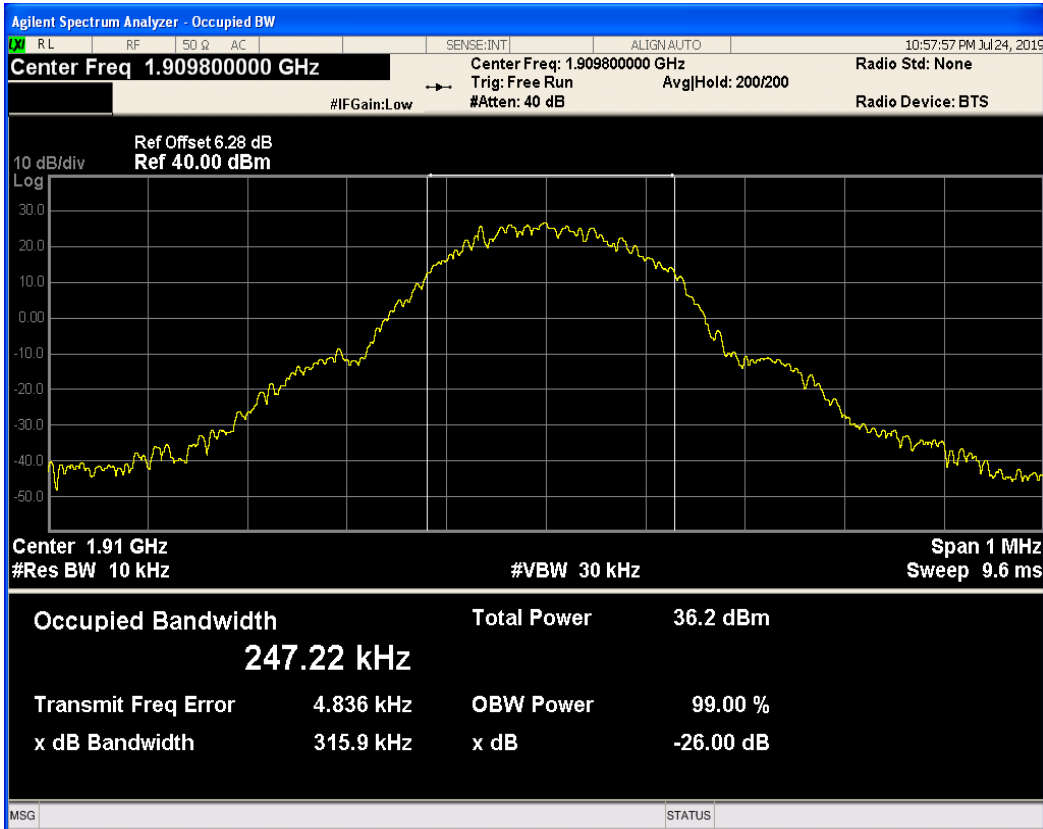

EGPRS850 Channel=128

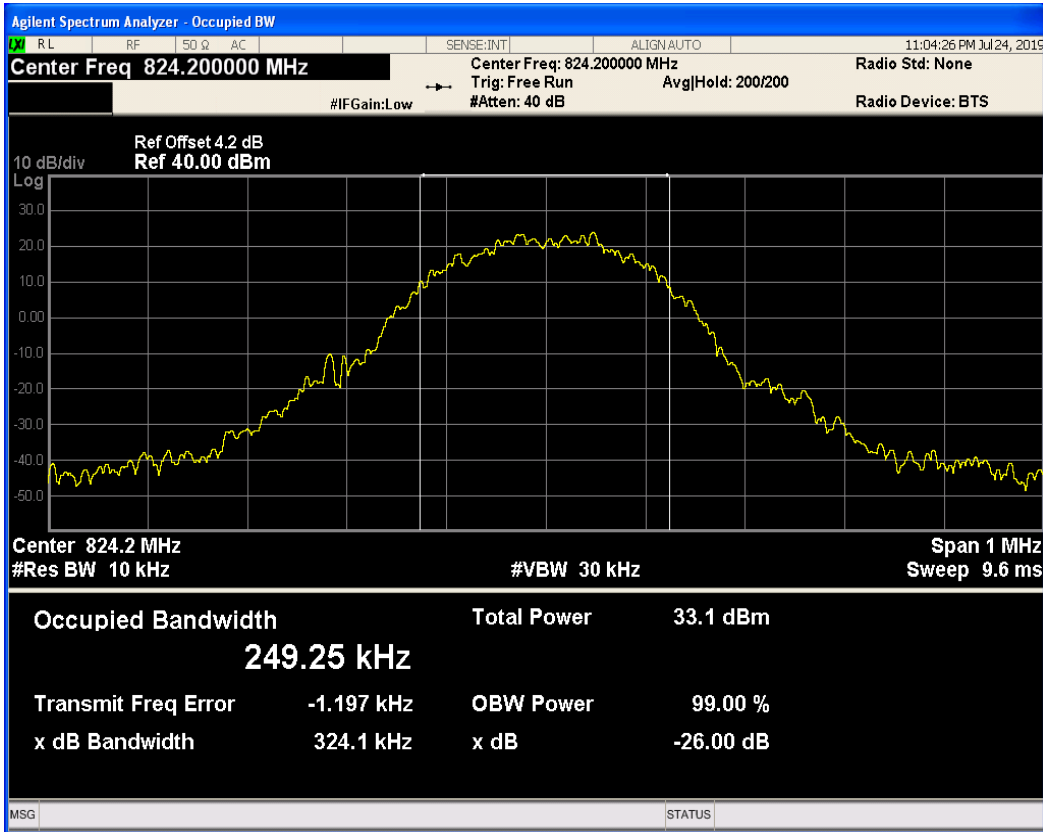

EGPRS850 Channel=189

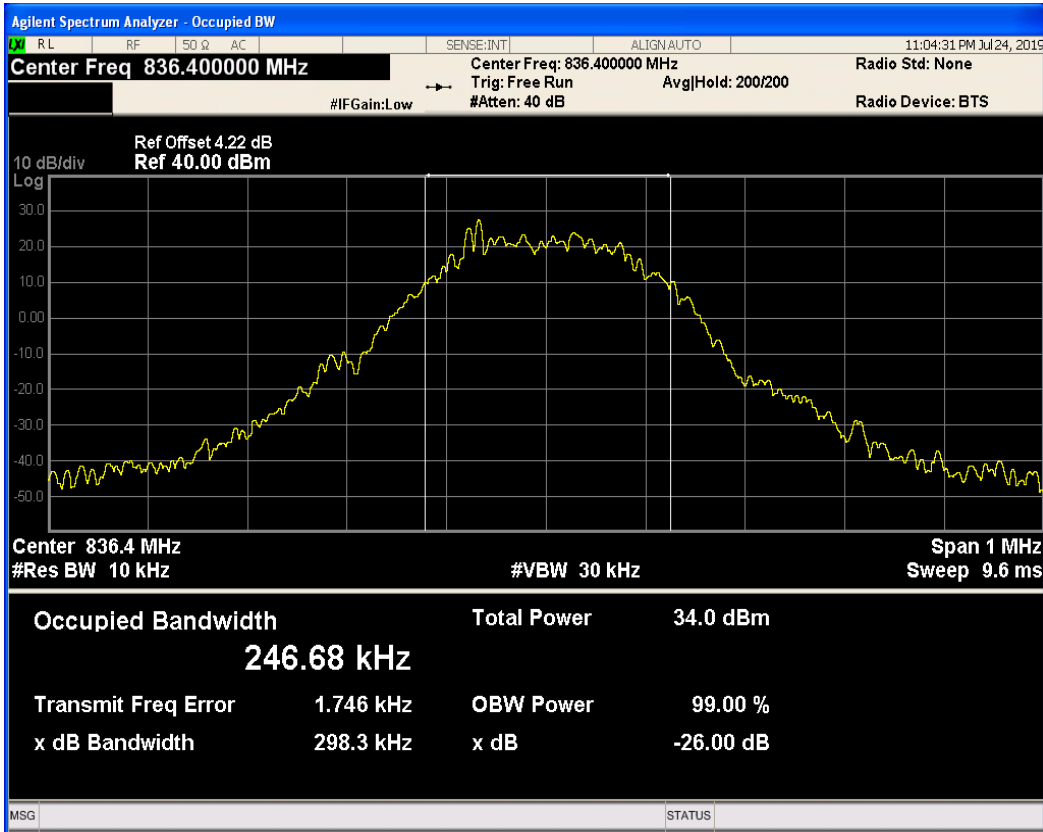

EGPRS850 Channel=251

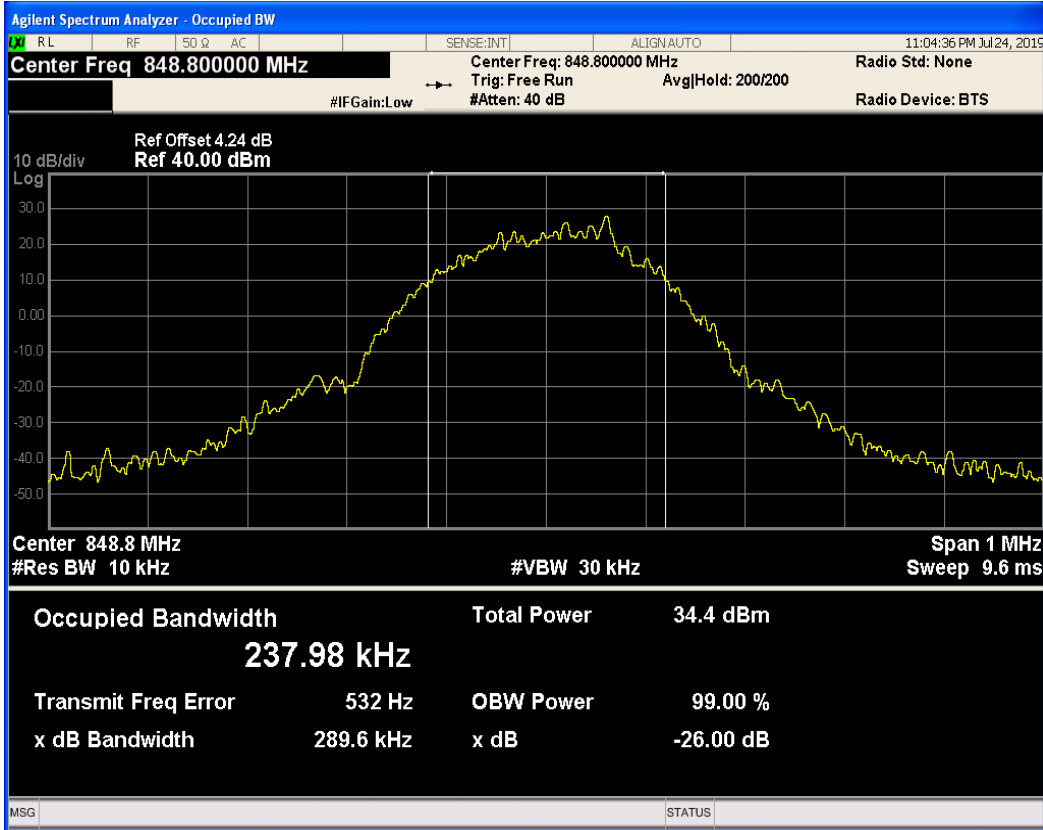

EGPRS1900 Channel=512

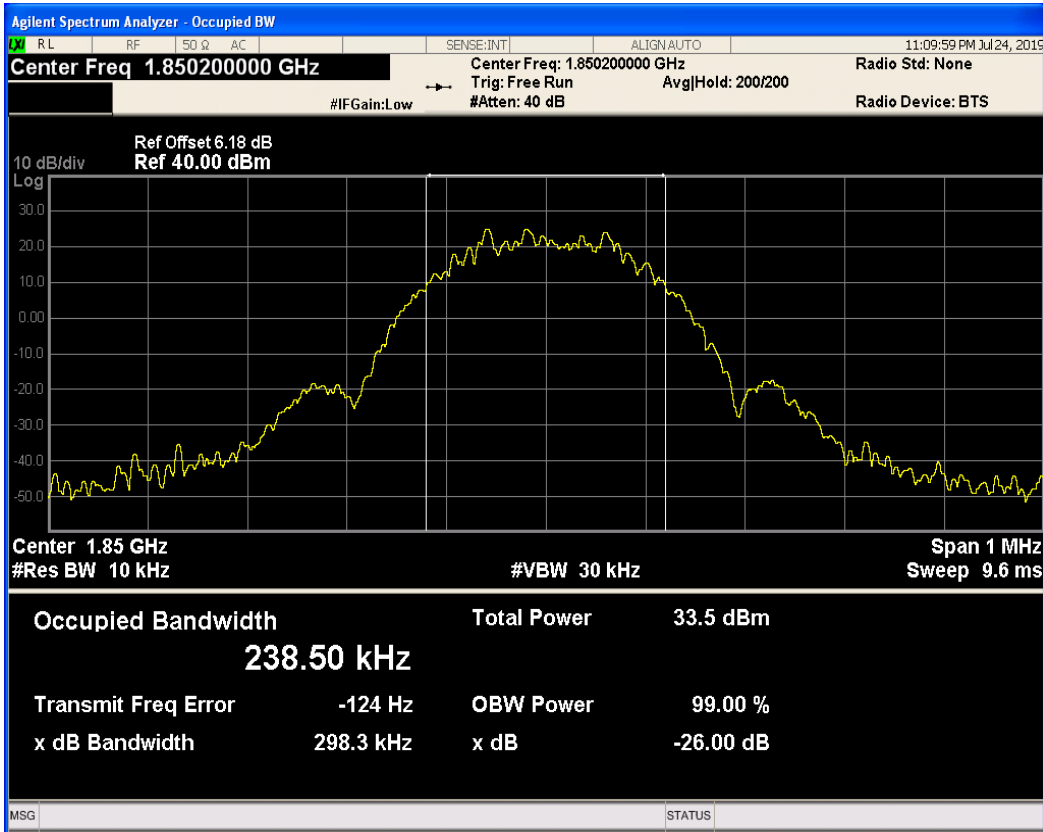

EGPRS1900 Channel=810

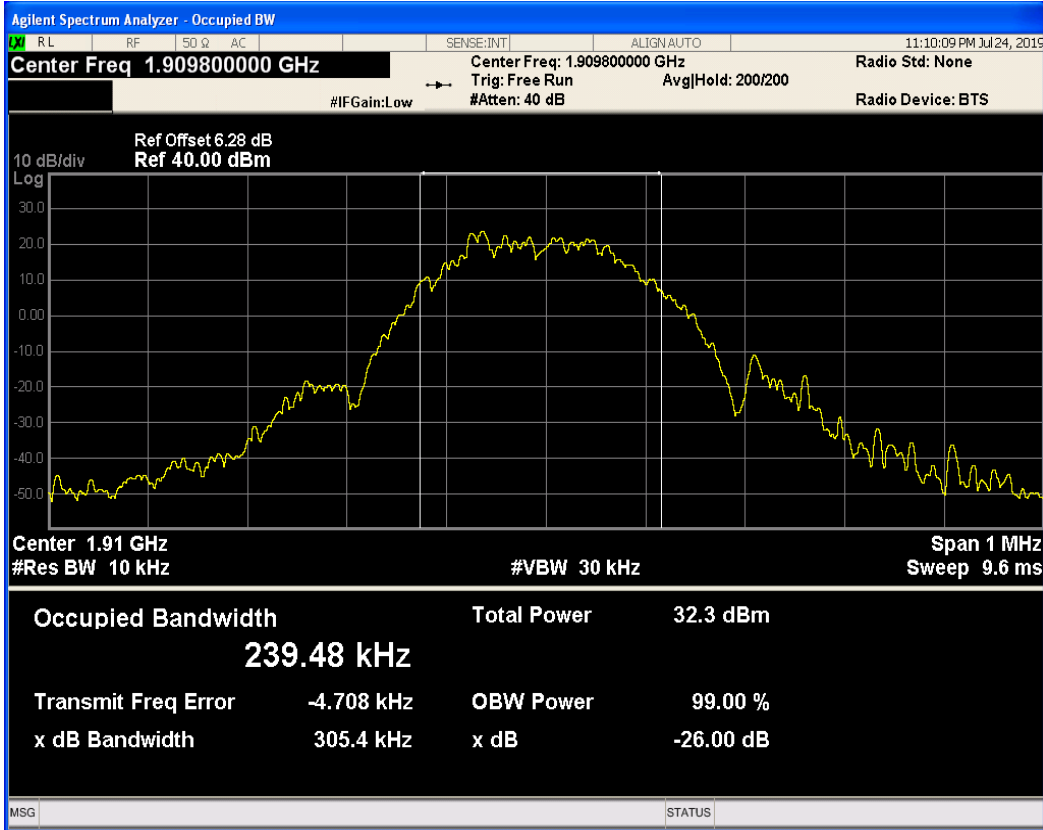

EGPRS1900 Channel=661

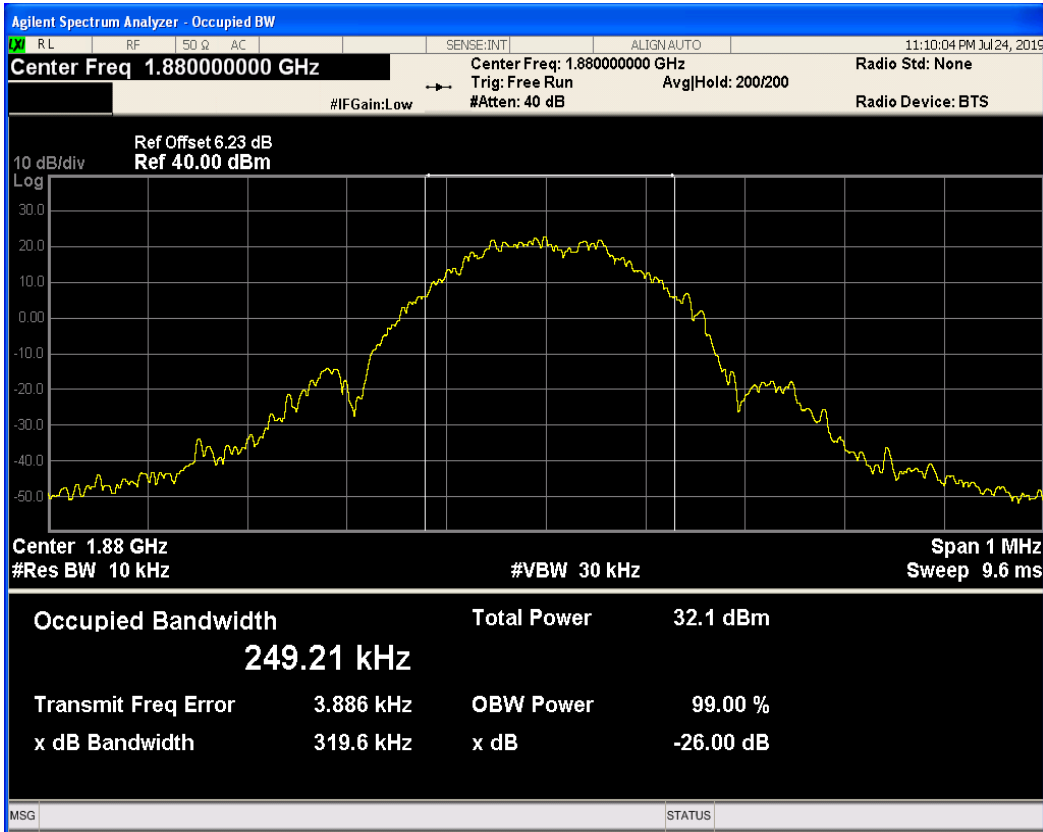

WCDMA Band2 Channel=9262

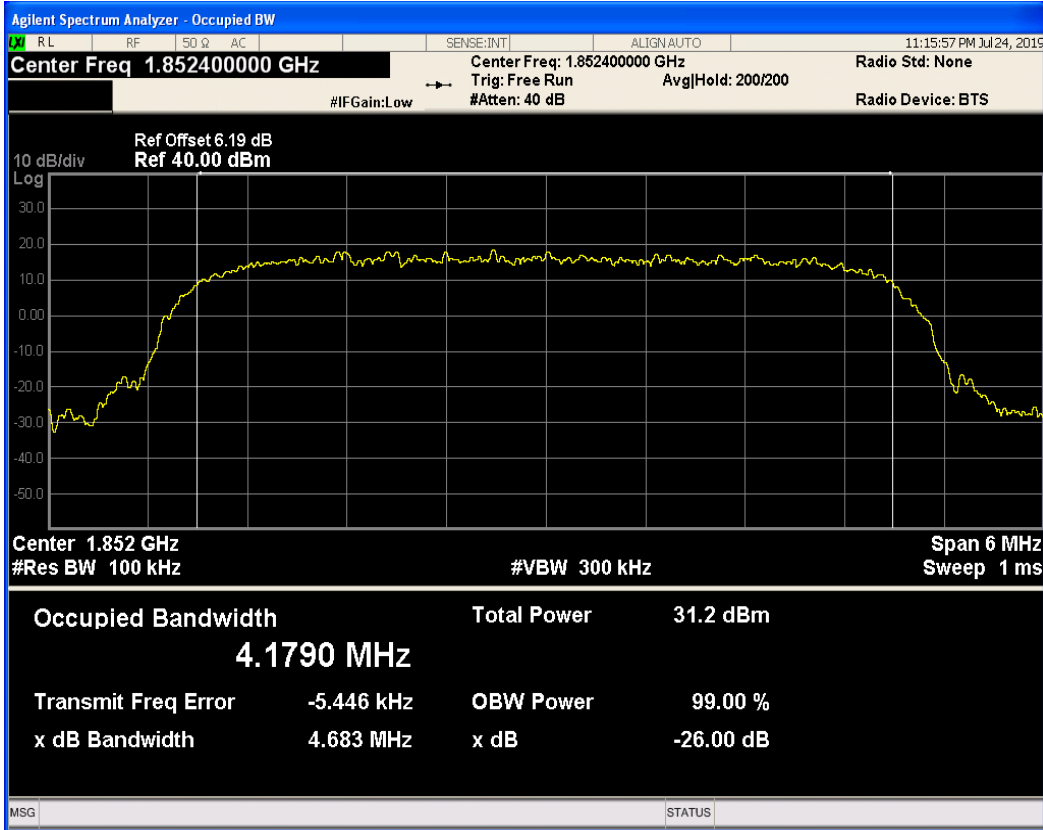

WCDMA Band2 Channel=9400

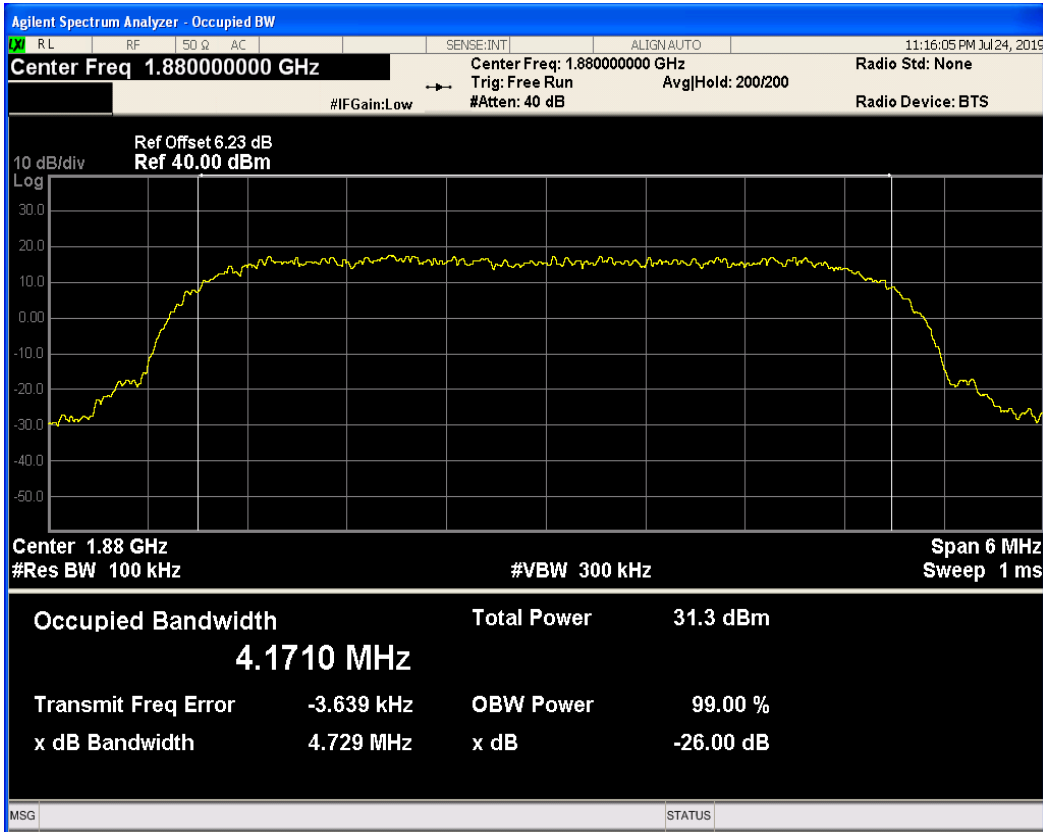

WCDMA Band2 Channel=9538

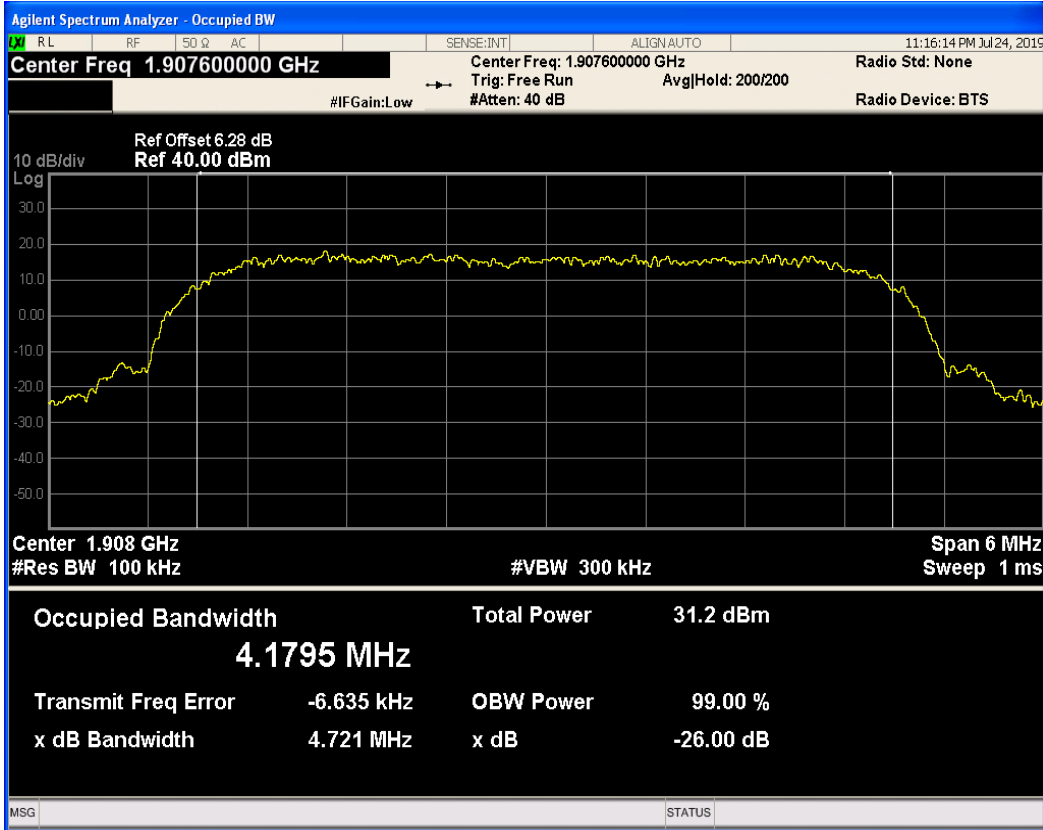

WCDMA Band4 Channel=1513

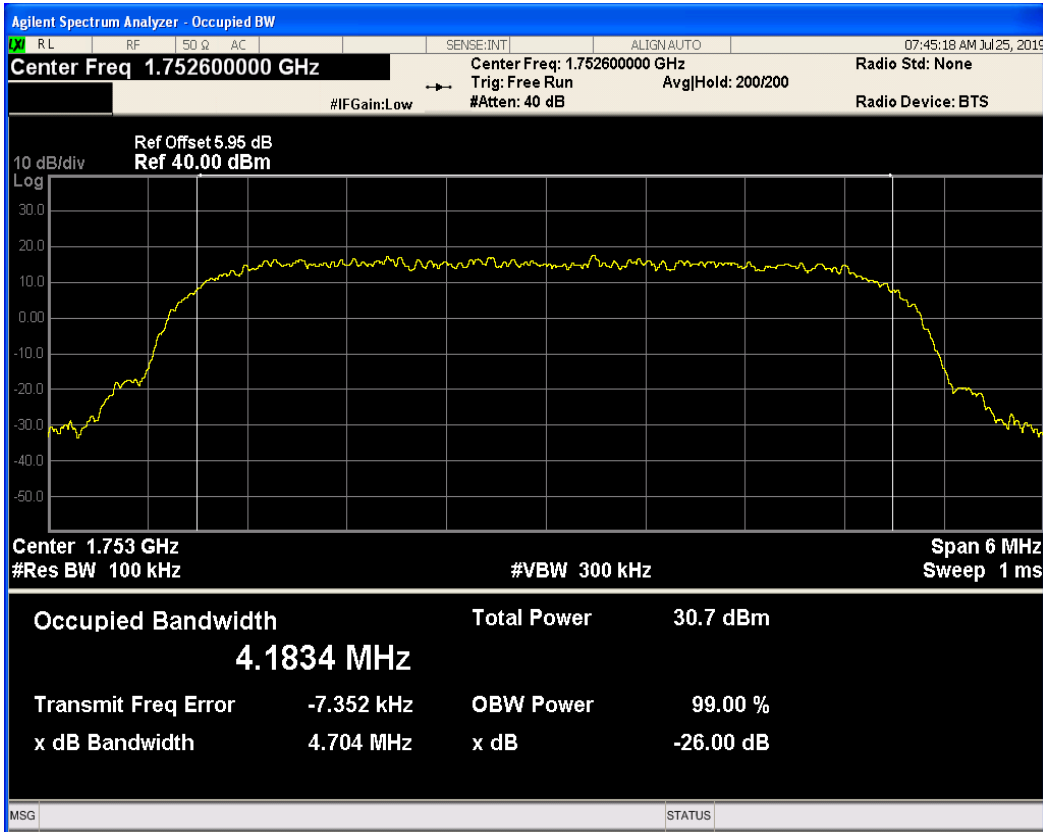

WCDMA Band4 Channel=1412

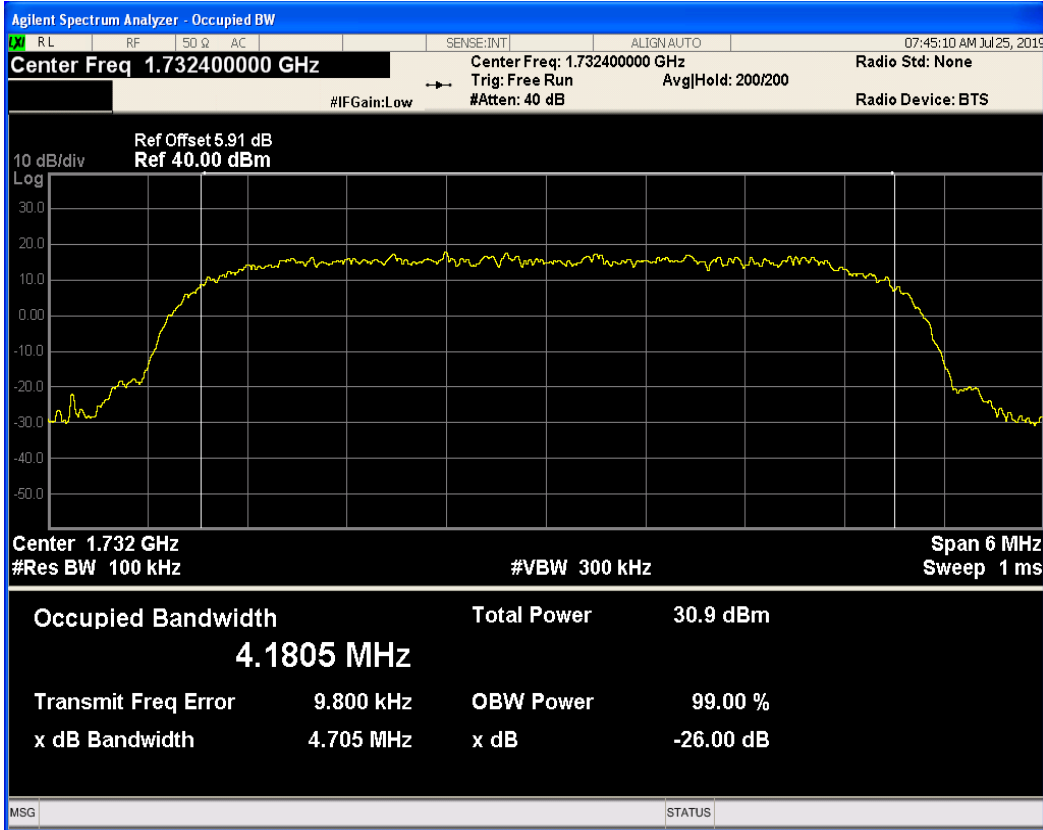

WCDMA Band4 Channel=1312

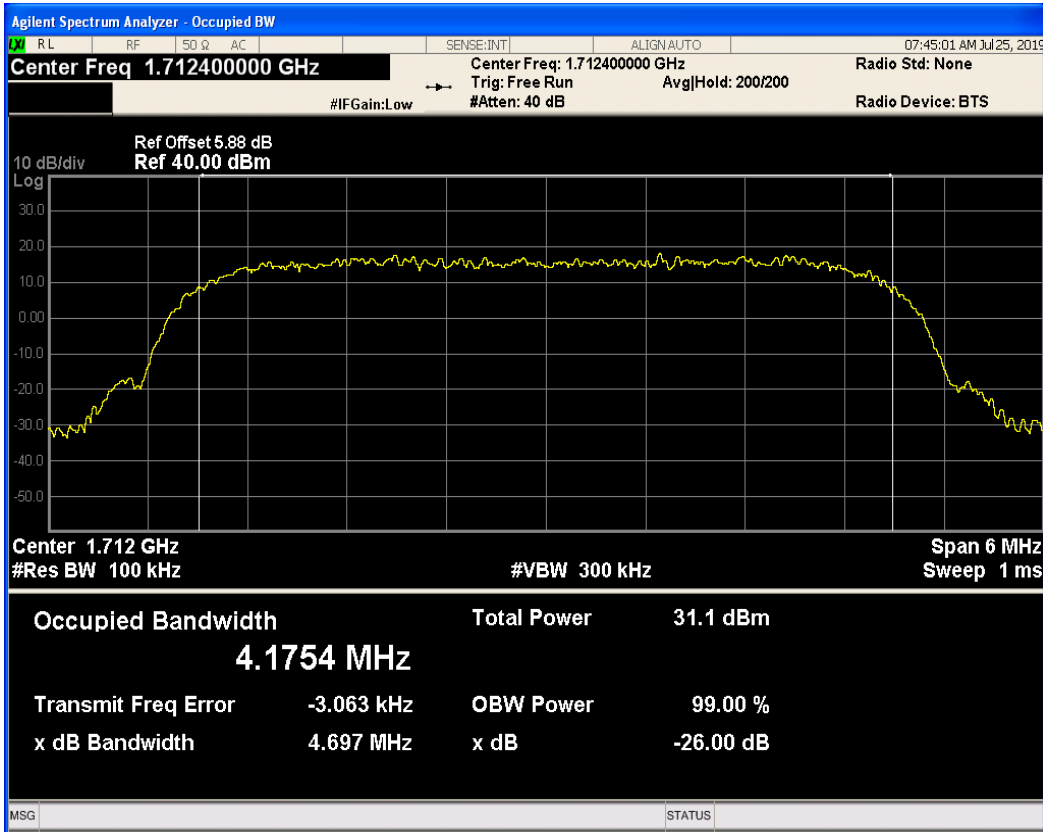

WCDMA Band5 Channel=4132

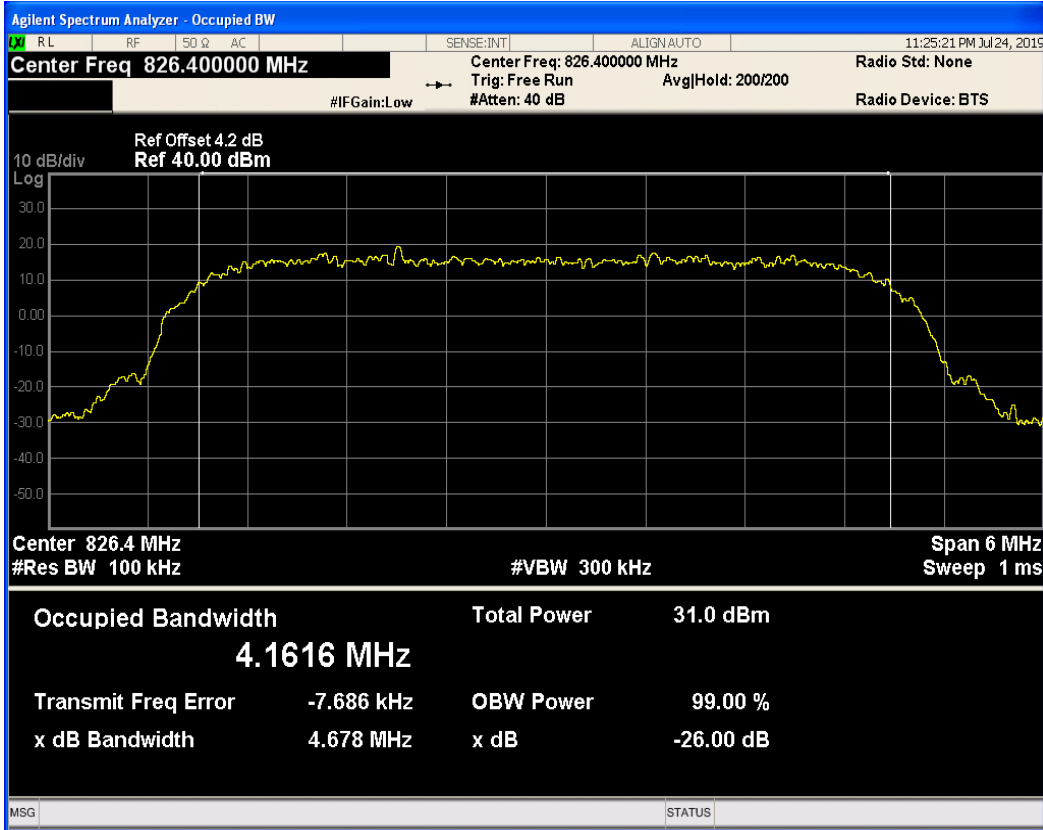

WCDMA Band5 Channel=4182

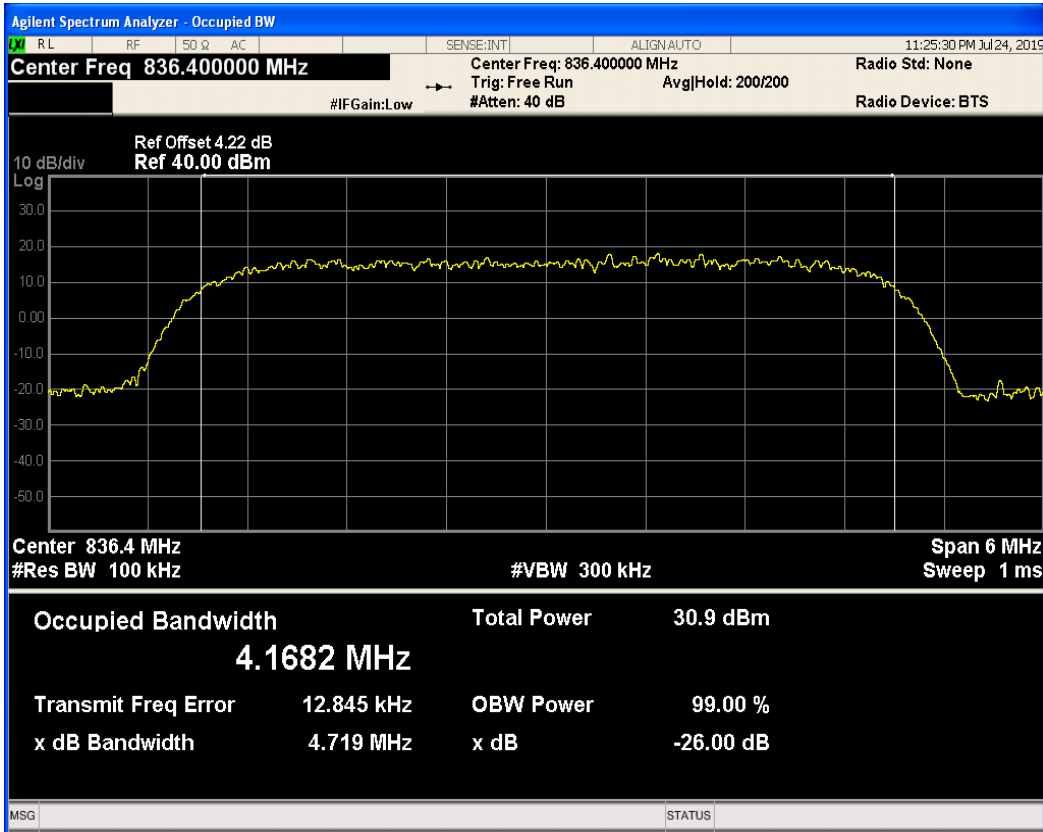

WCDMA Band5 Channel=4233

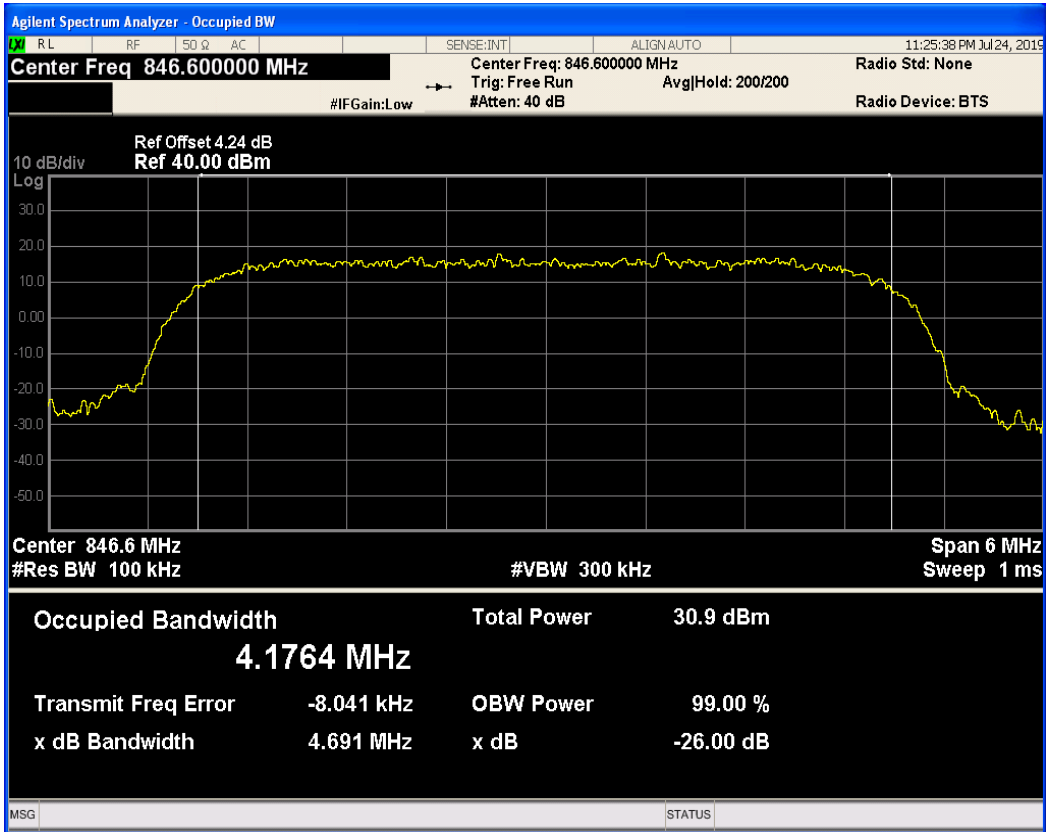

8.4 BAND EDGE

Band	Channel	Frequency (MHz)	Spur Freq (MHz)	Spur Level (dBm)	Limit (dBm)	Verdict
GSM850	128	824.2	823.99	-26.24	-13	PASS
GSM850	251	848.8	849.02	-26.15	-13	PASS
GSM1900	512	1850.2	1849.98	-29.41	-13	PASS
GSM1900	810	1909.8	1910.02	-29.42	-13	PASS
GPRS850	128	824.2	823.99	-26.21	-13	PASS
GPRS850	251	848.8	849.02	-27.96	-13	PASS
GPRS1900	512	1850.2	1849.98	-29.20	-13	PASS
GPRS1900	810	1909.8	1910.01	-30.23	-13	PASS
EGPRS850	128	824.2	823.99	-35.50	-13	PASS
EGPRS850	251	848.8	849.00	-37.30	-13	PASS
EGPRS1900	512	1850.2	1850.00	-35.45	-13	PASS
EGPRS1900	810	1909.8	1910.02	-38.01	-13	PASS
WCDMA Band2	9262	1852.4	1850.00	-28.00	-13	PASS
WCDMA Band2	9538	1907.6	1910.09	-24.42	-13	PASS
WCDMA Band4	1312	1712.4	1710.00	-22.90	-13	PASS
WCDMA Band4	1513	1752.6	1755.00	-22.63	-13	PASS
WCDMA Band5	4132	826.4	824.00	-21.89	-13	PASS
WCDMA Band5	4233	846.6	849.00	-22.86	-13	PASS

GSM850 Channel=128

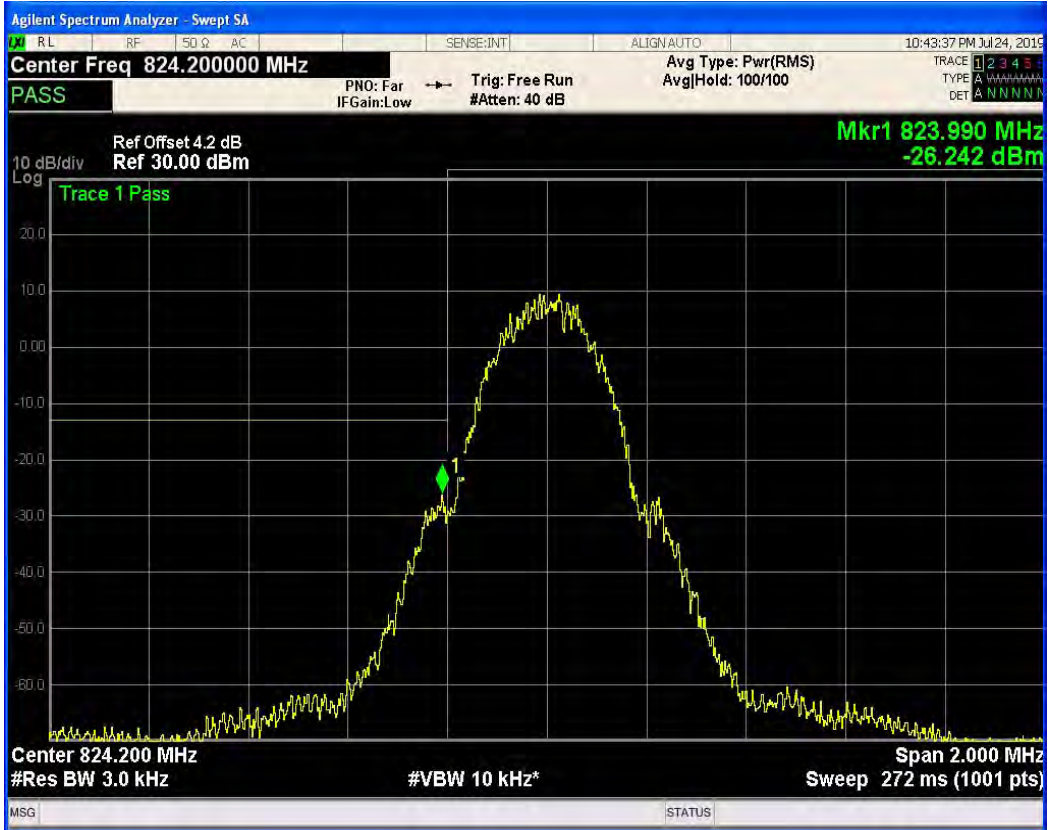

GSM850 Channel=251

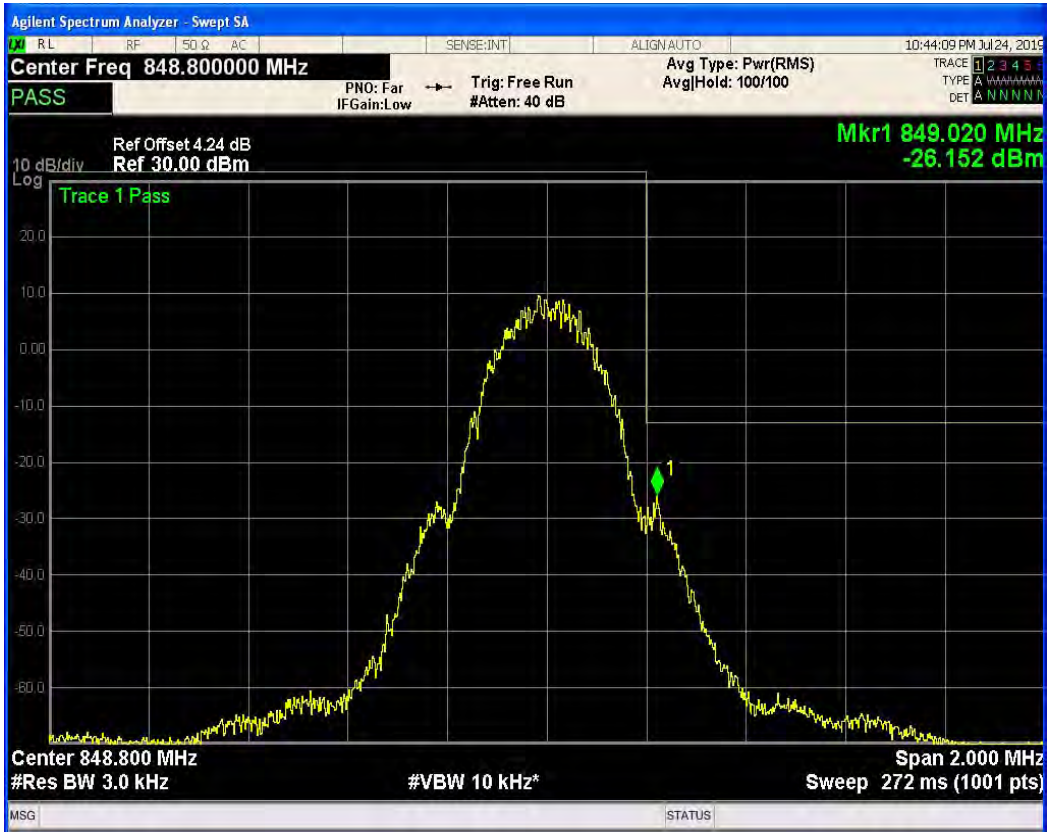

GSM1900 Channel=512

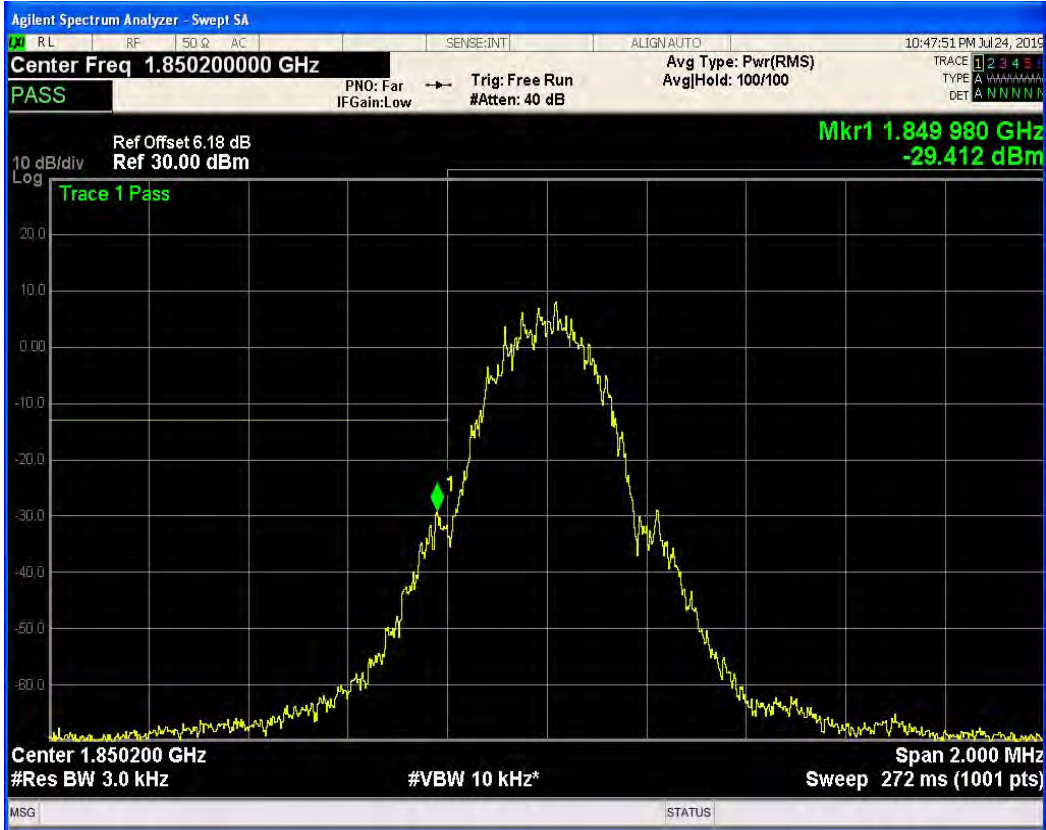

GSM1900 Channel=810

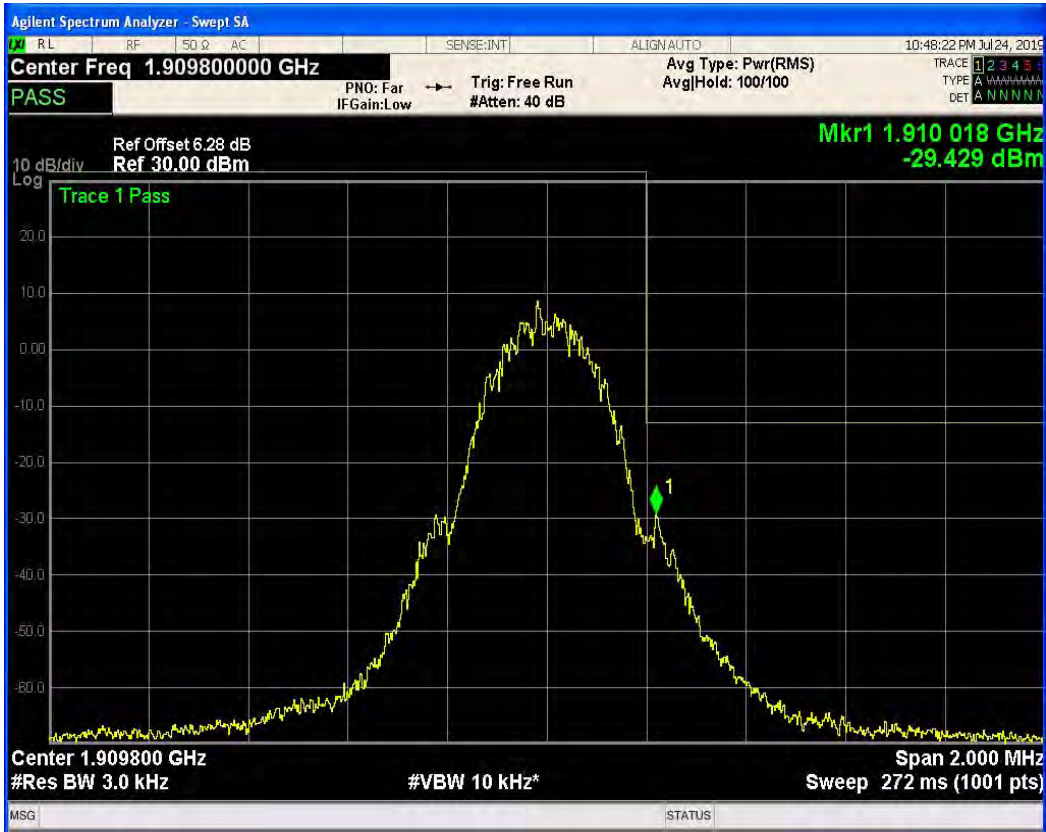

GPRS850 Channel=128

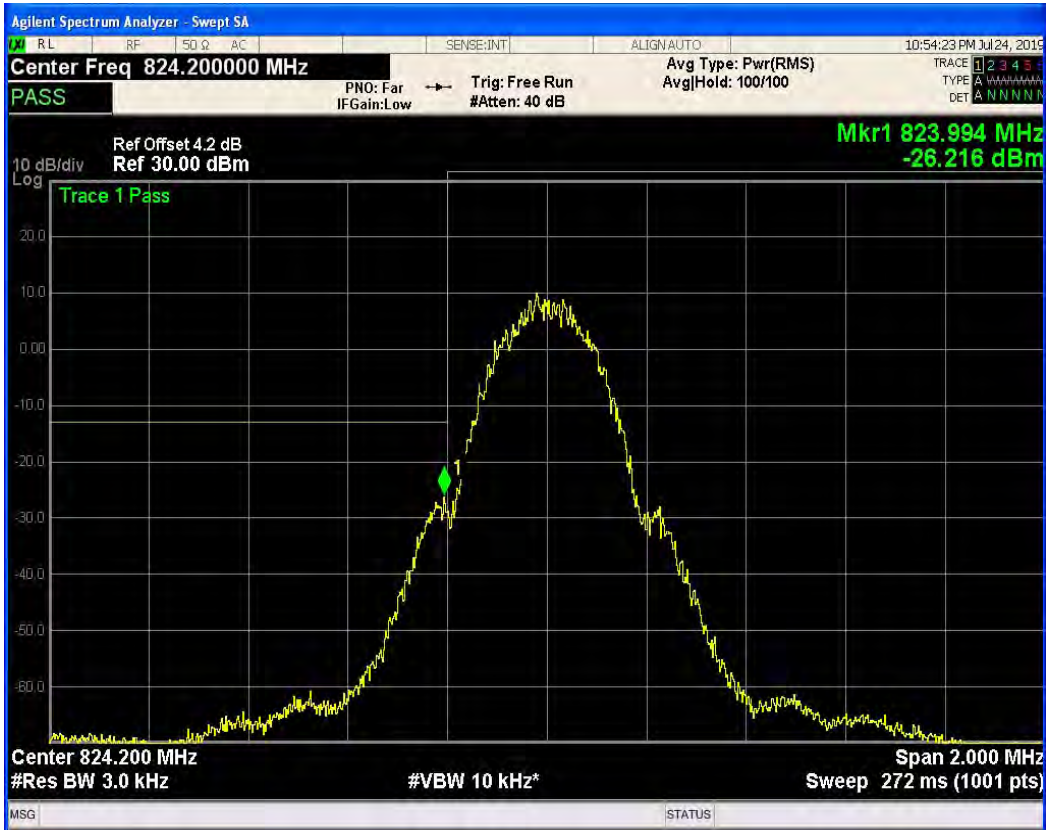

GPRS850 Channel=251

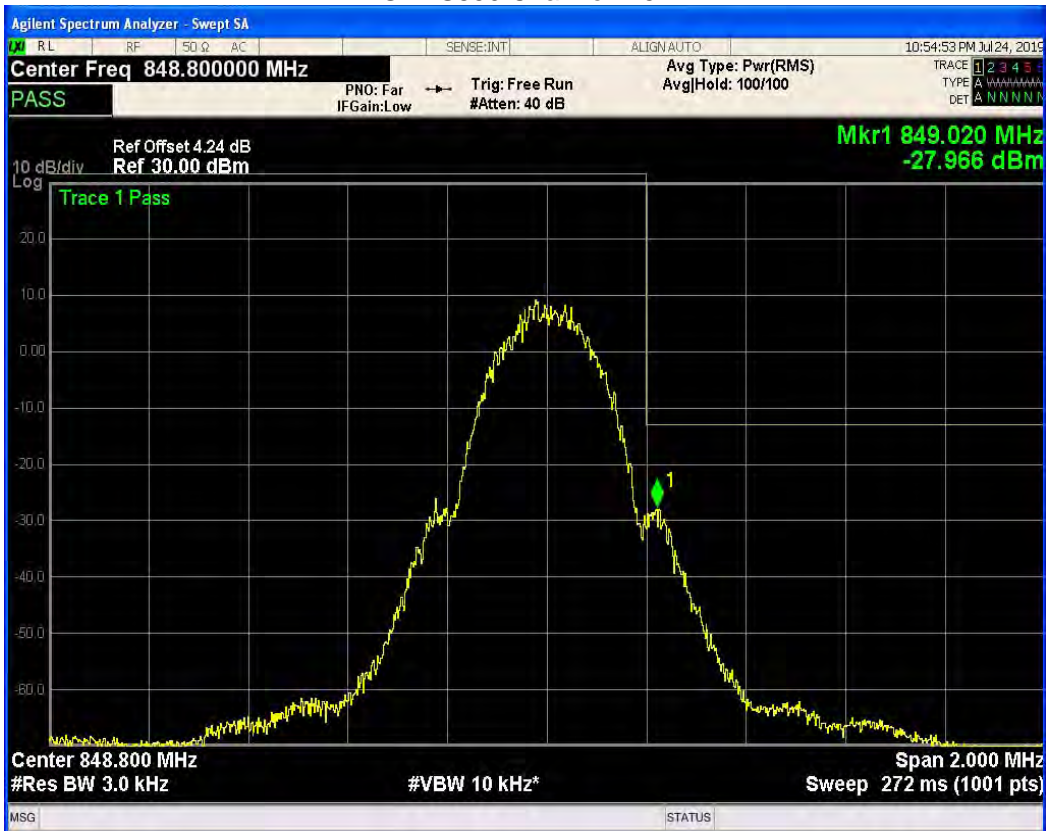

GPRS1900 Channel=512

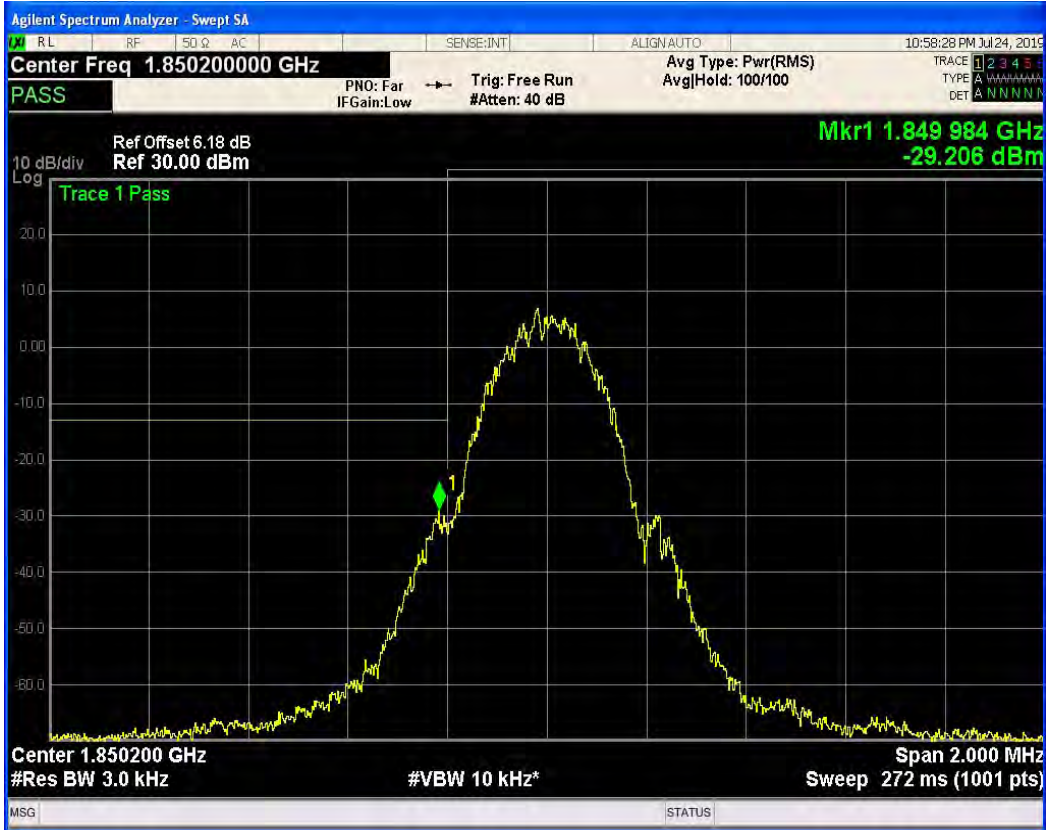

GPRS1900 Channel=810

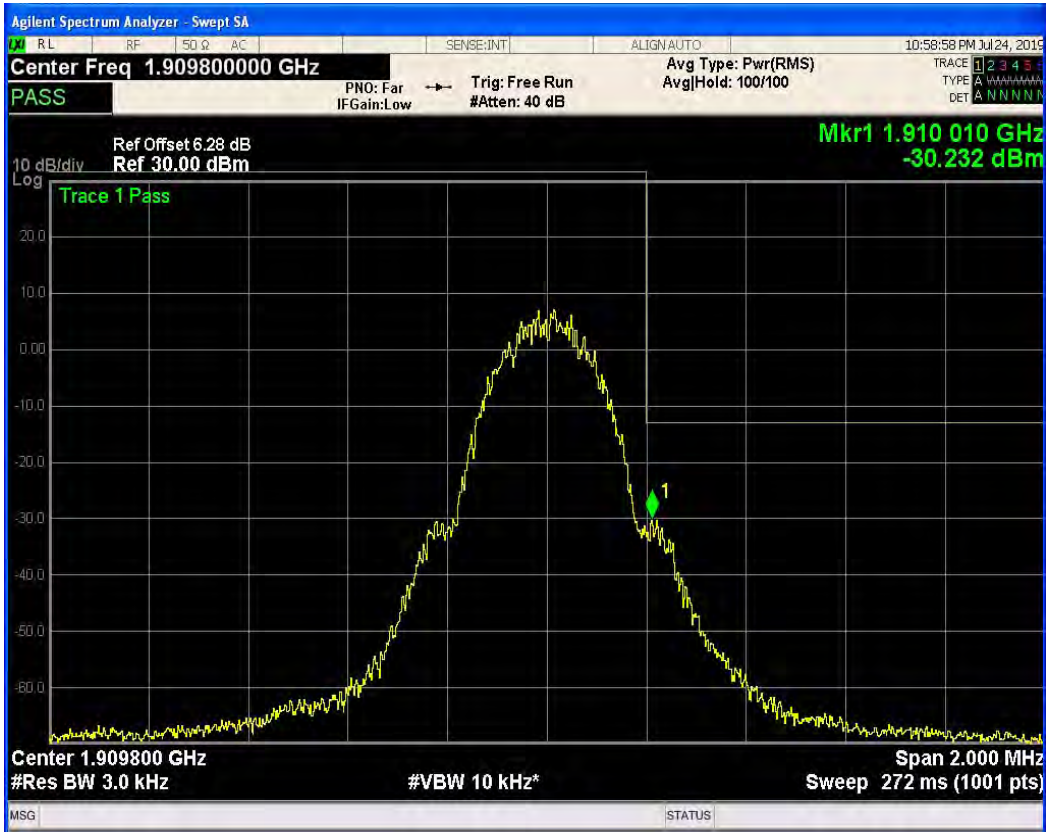

EGPRS850 Channel=128

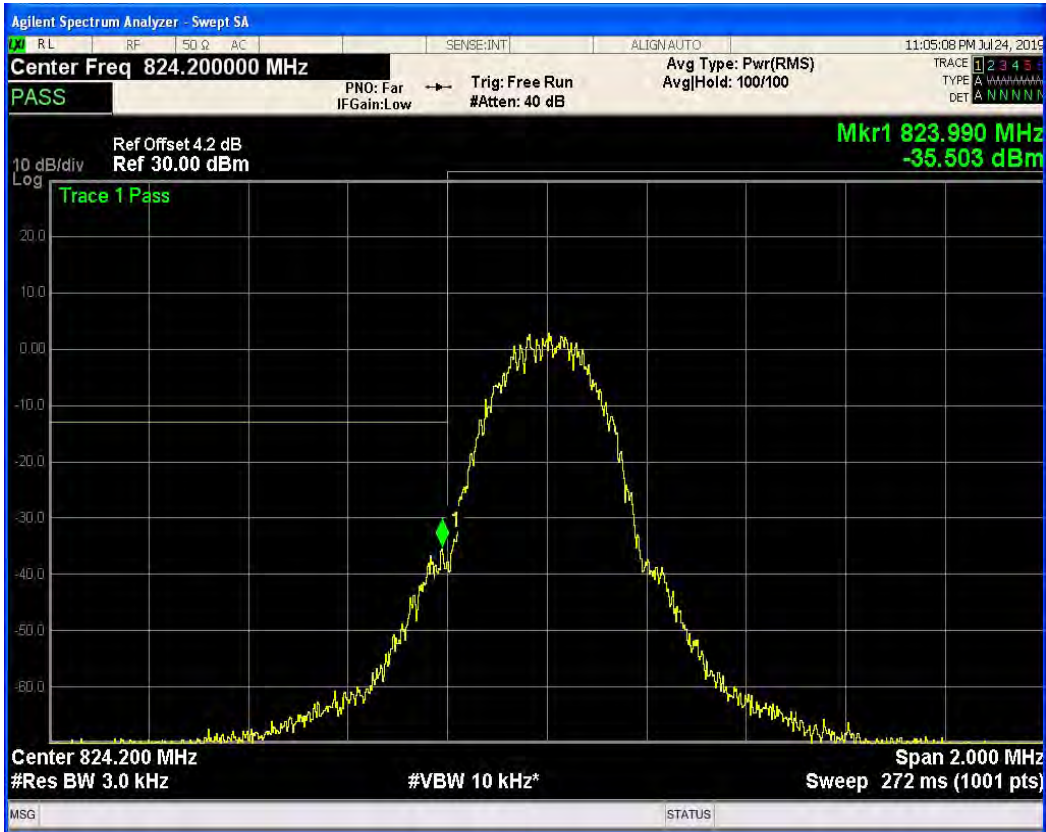

EGPRS850 Channel=251

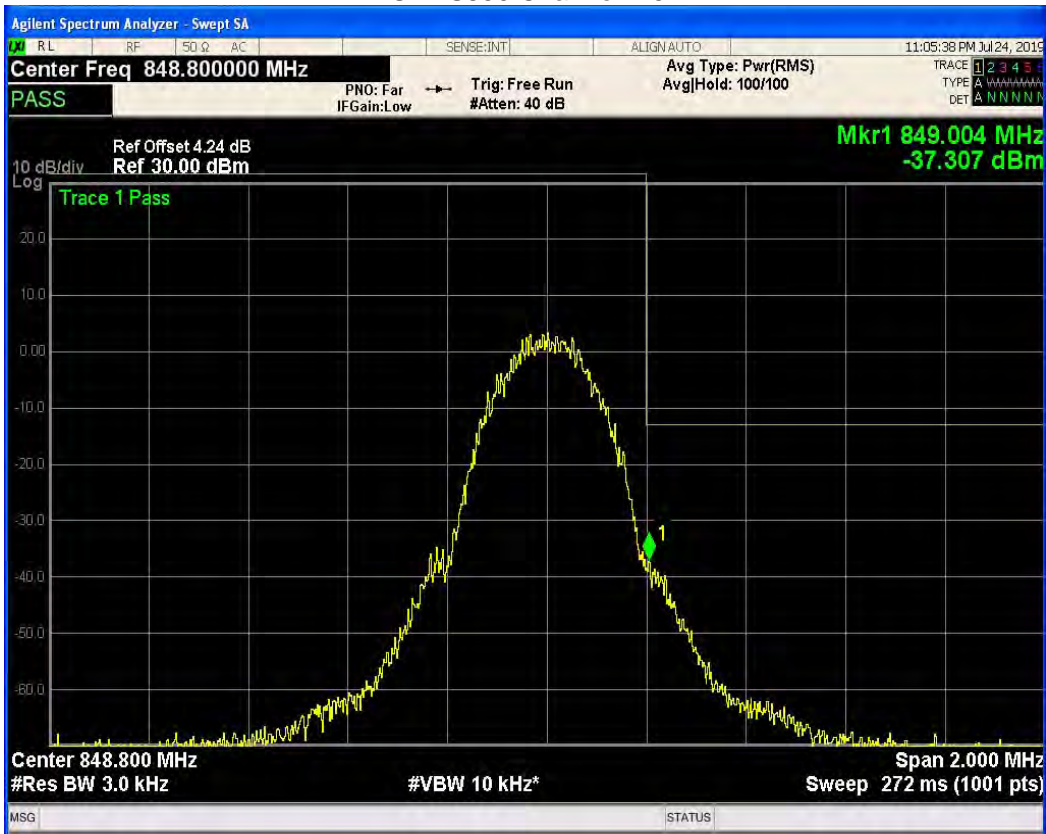

EGPRS1900 Channel=512

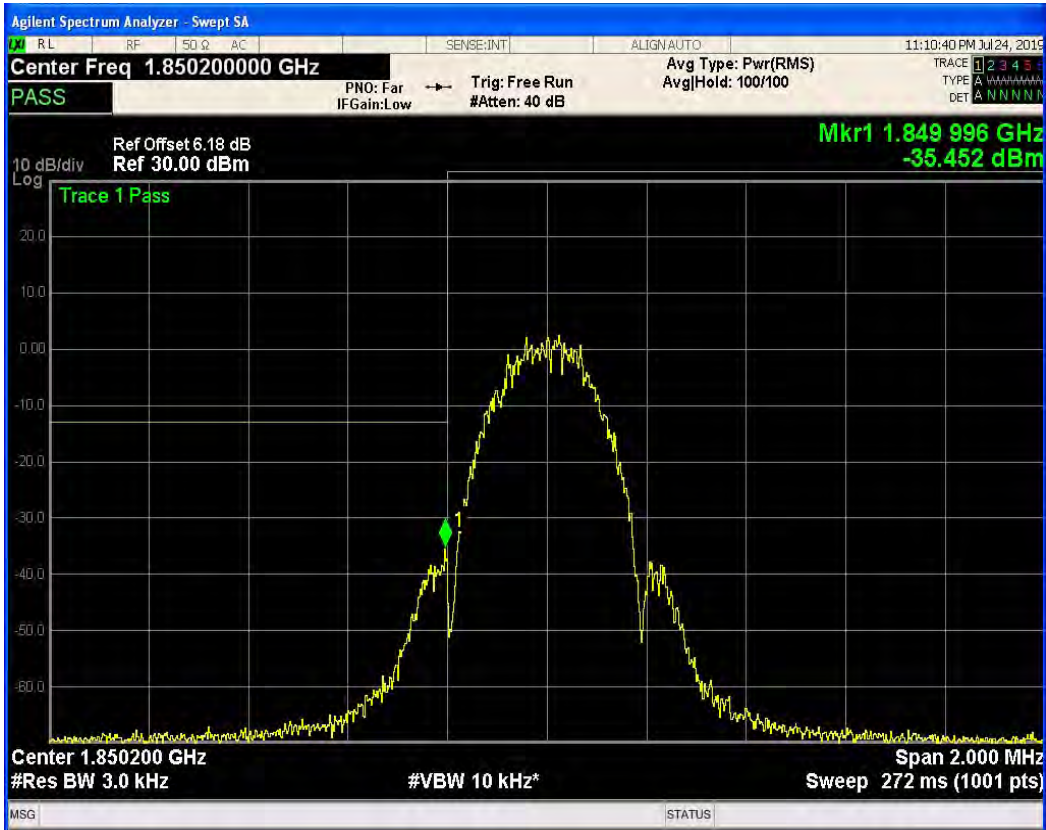

EGPRS1900 Channel=810

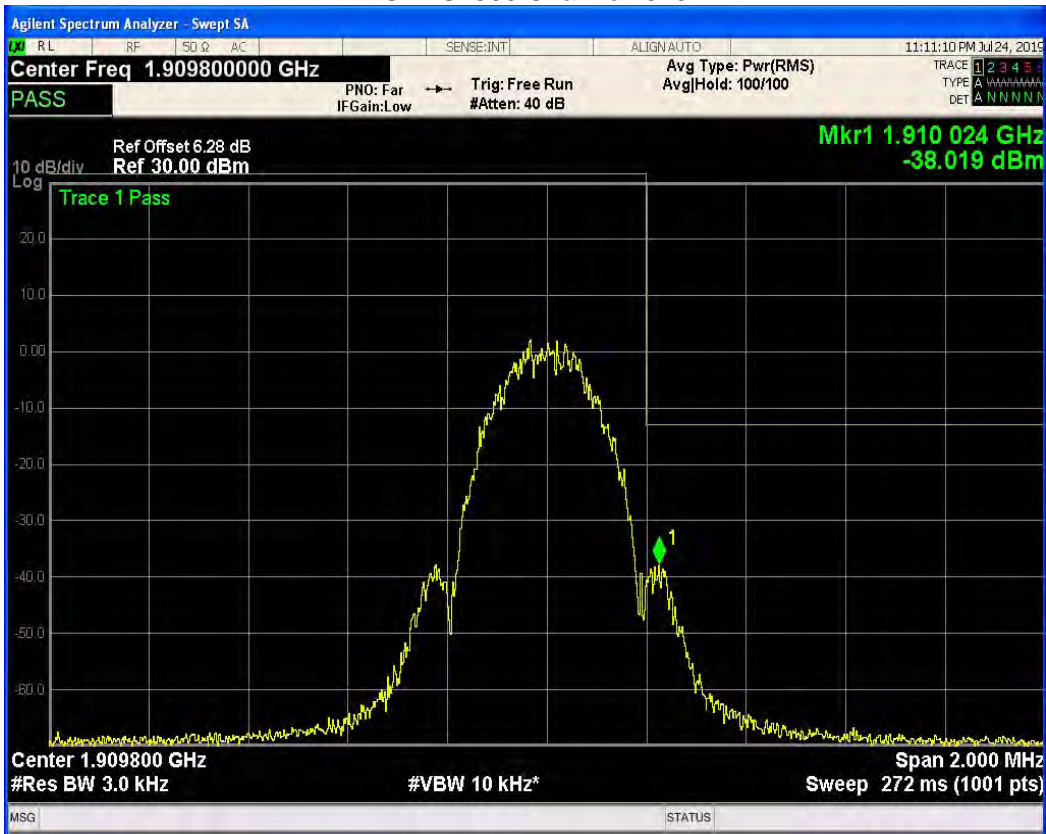

WCDMA Band2 Channel=9262



WCDMA Band2 Channel=9538



WCDMA Band4 Channel=1513



WCDMA Band4 Channel=1312

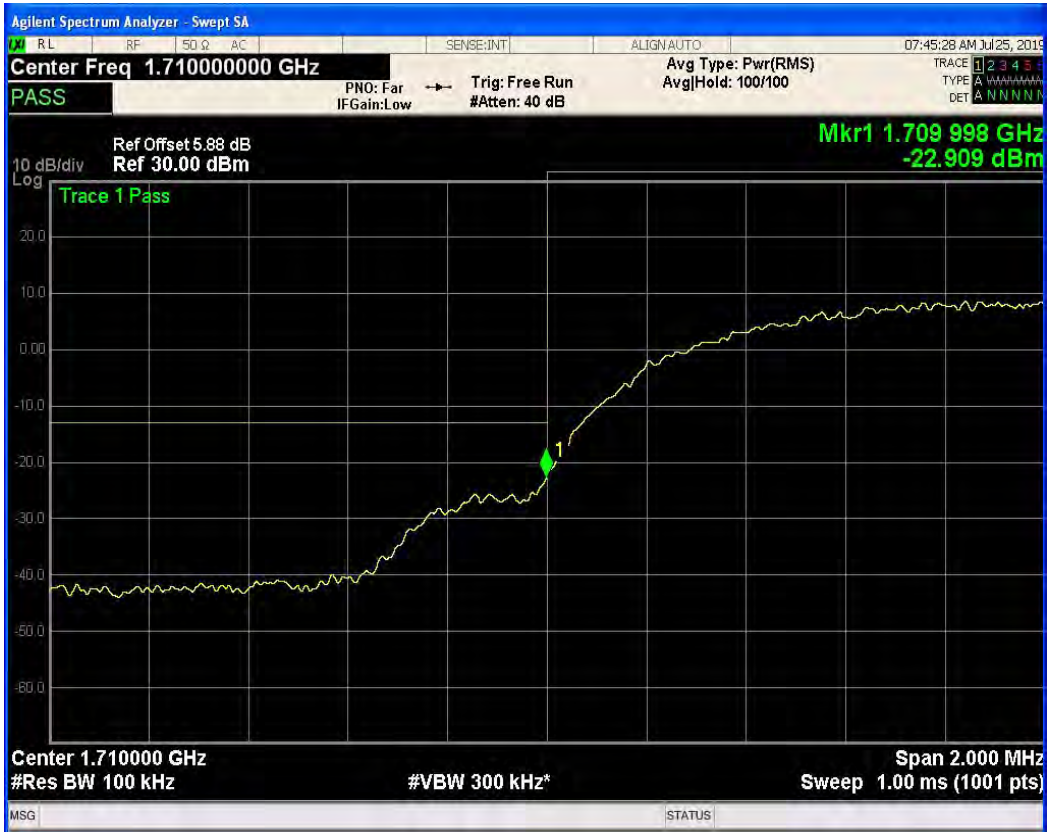

WCDMA Band5 Channel=4132



WCDMA Band5 Channel=4233



8.5 OUT-OF-BAND EMISSIONS

Band	Channel	Frequency (MHz)	Spur Freq (MHz)	Spur Level (dBm)	Limit (dBm)	Verdict
GSM850	128	824.2	1648.38	-28.60	-13	PASS
GSM850	189	836.4	1672.81	-28.40	-13	PASS
GSM850	251	848.8	1697.73	-30.32	-13	PASS
GSM1900	512	1850.2	19664.50	-25.01	-13	PASS
GSM1900	661	1880	19029.46	-25.11	-13	PASS
GSM1900	810	1909.8	17769.85	-24.98	-13	PASS
GPRS850	128	824.2	1648.38	-28.22	-13	PASS
GPRS850	189	836.4	1673.06	-29.11	-13	PASS
GPRS850	251	848.8	1697.73	-29.45	-13	PASS
GPRS1900	512	1850.2	19647.03	-25.16	-13	PASS
GPRS1900	661	1880	18943.59	-25.18	-13	PASS
GPRS1900	810	1909.8	19927.61	-25.22	-13	PASS
EGPRS850	128	824.2	3150.61	-31.55	-13	PASS
EGPRS850	189	836.4	3143.13	-30.91	-13	PASS
EGPRS850	251	848.8	3292.93	-30.96	-13	PASS
EGPRS1900	512	1850.2	19852.22	-24.88	-13	PASS
EGPRS1900	661	1880	18903.15	-25.10	-13	PASS
EGPRS1900	810	1909.8	17762.36	-25.35	-13	PASS
WCDMA Band2	9262	1852.4	18521.22	-25.41	-13	PASS
WCDMA Band2	9400	1880	19947.58	-25.06	-13	PASS
WCDMA Band2	9538	1907.6	19966.05	-25.37	-13	PASS
WCDMA Band4	1312	1712.4	19481.28	-25.57	-13	PASS
WCDMA Band4	1412	1732.4	18441.34	-25.11	-13	PASS
WCDMA Band4	1513	1752.6	19852.72	-25.08	-13	PASS
WCDMA Band5	4132	826.4	3334.31	-31.76	-13	PASS
WCDMA Band5	4182	836.4	2633.17	-31.27	-13	PASS
WCDMA Band5	4233	846.6	3198.72	-31.97	-13	PASS

GSM850 Channel=189

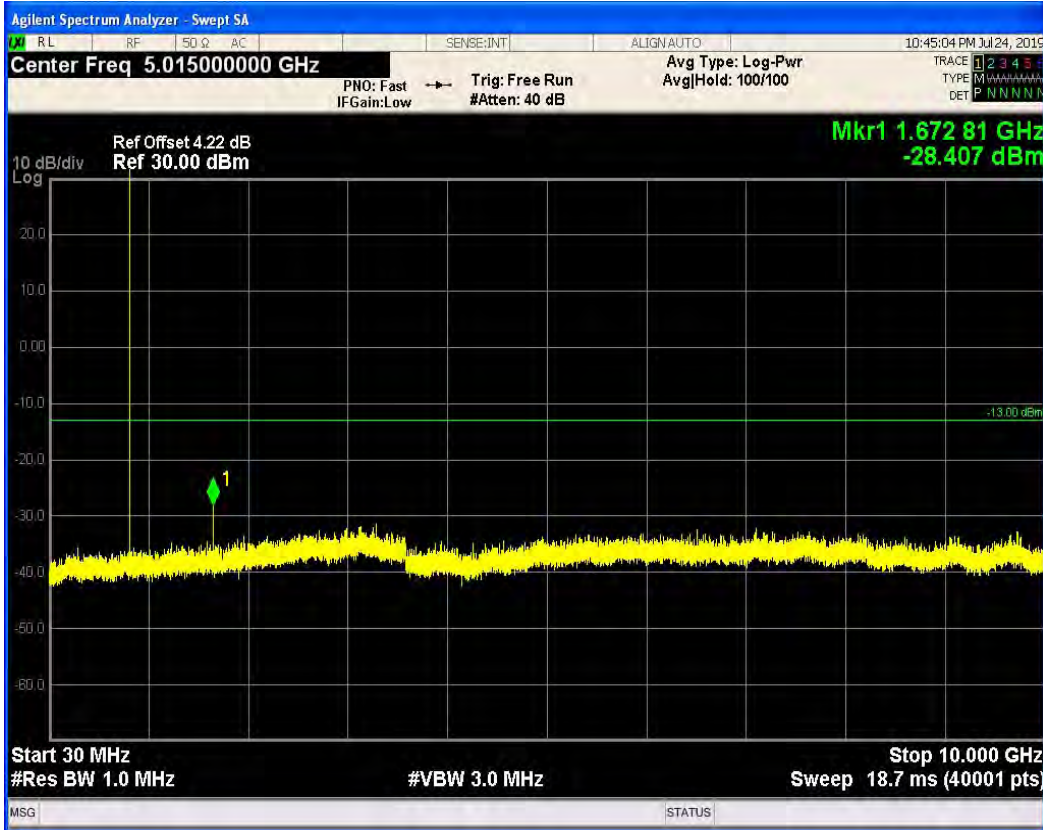

GSM850 Channel=128

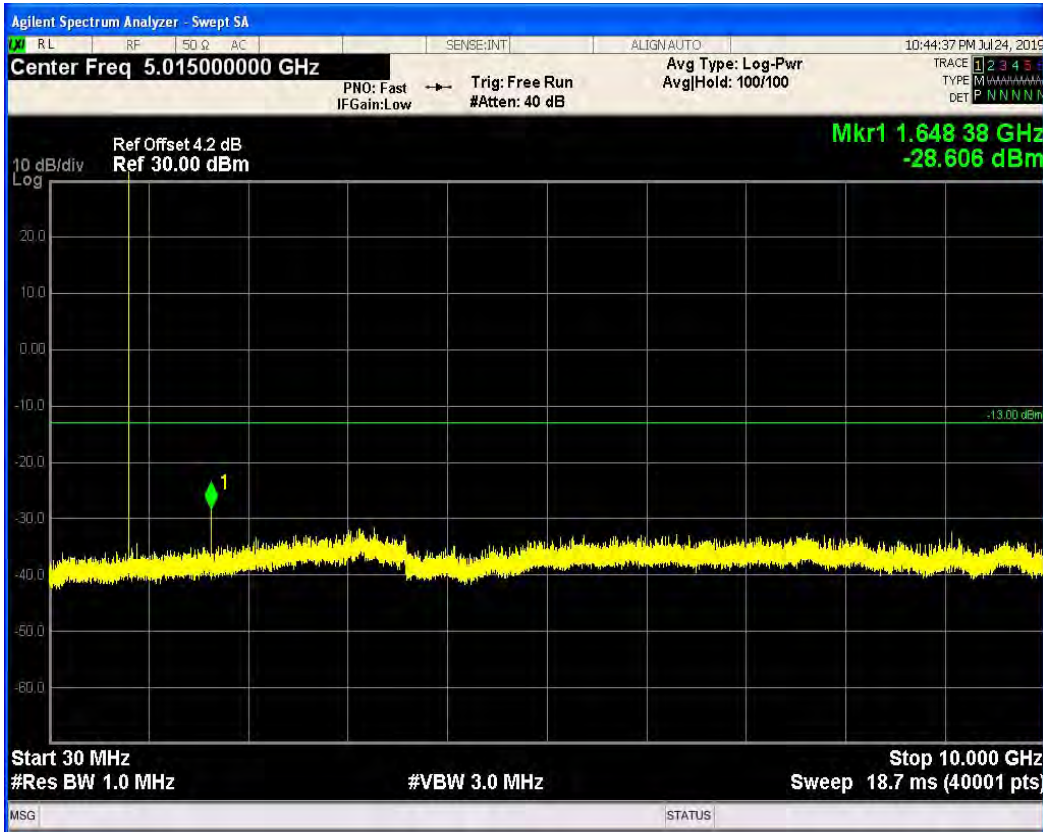

GSM850 Channel=251

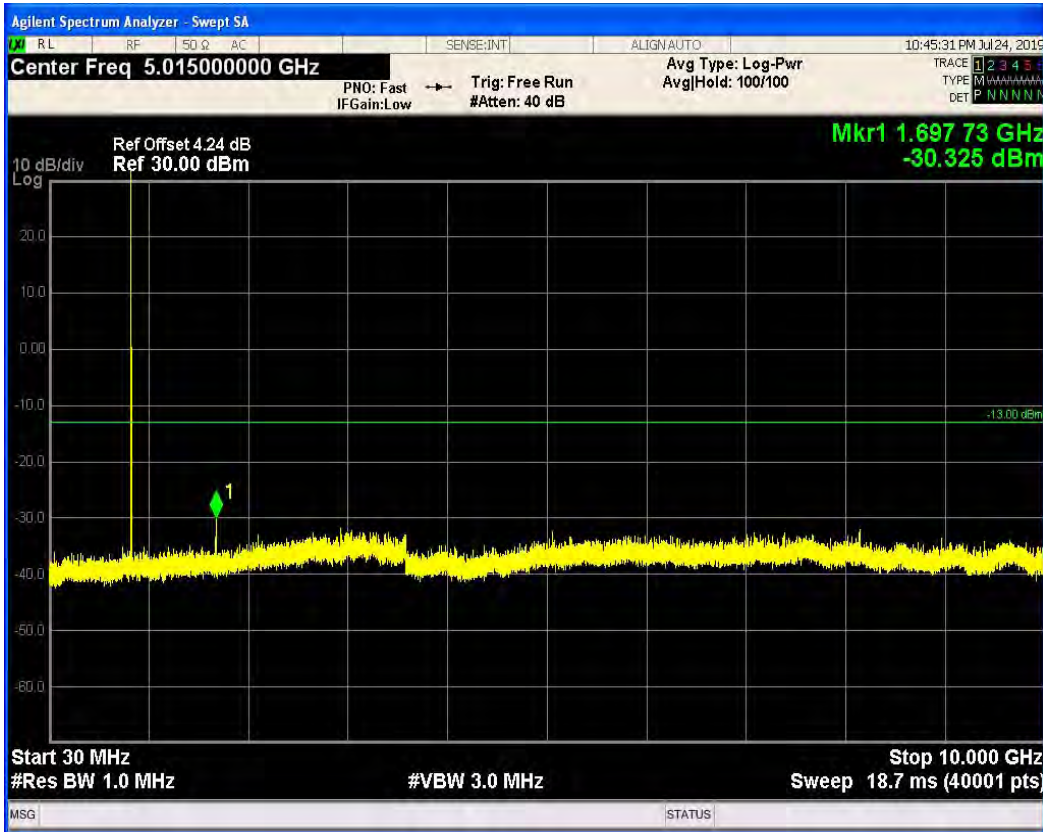

GSM1900 Channel=512

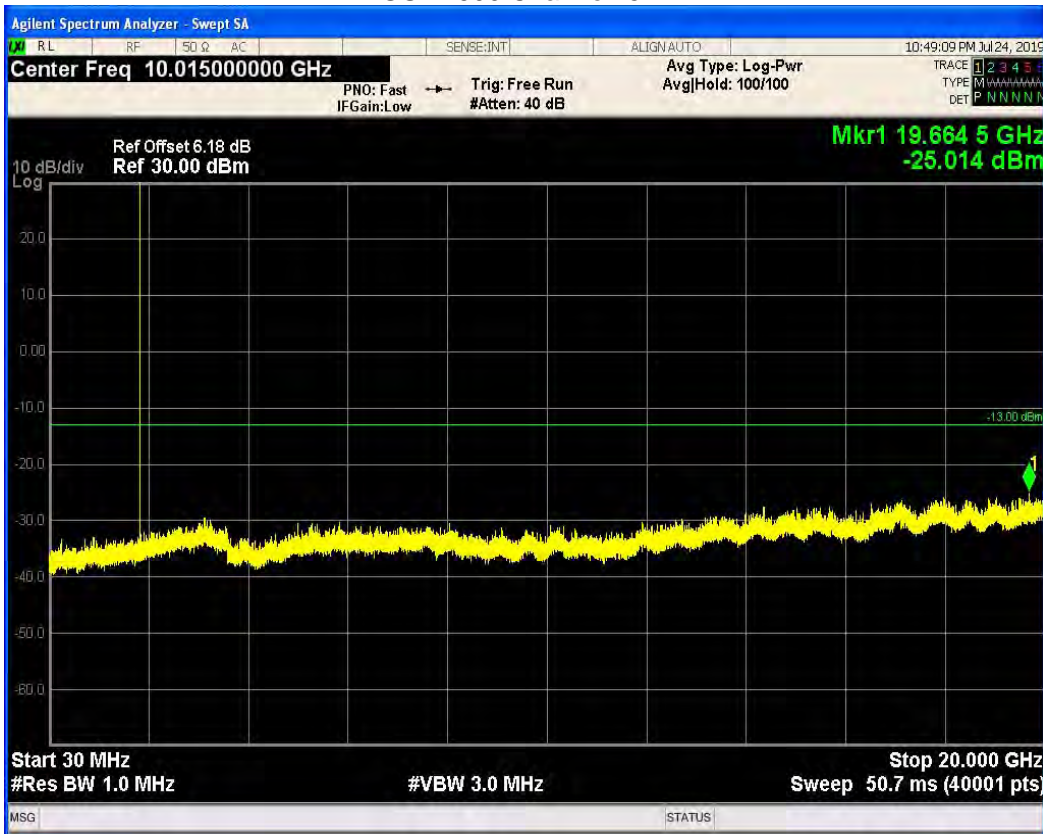

GSM1900 Channel=661

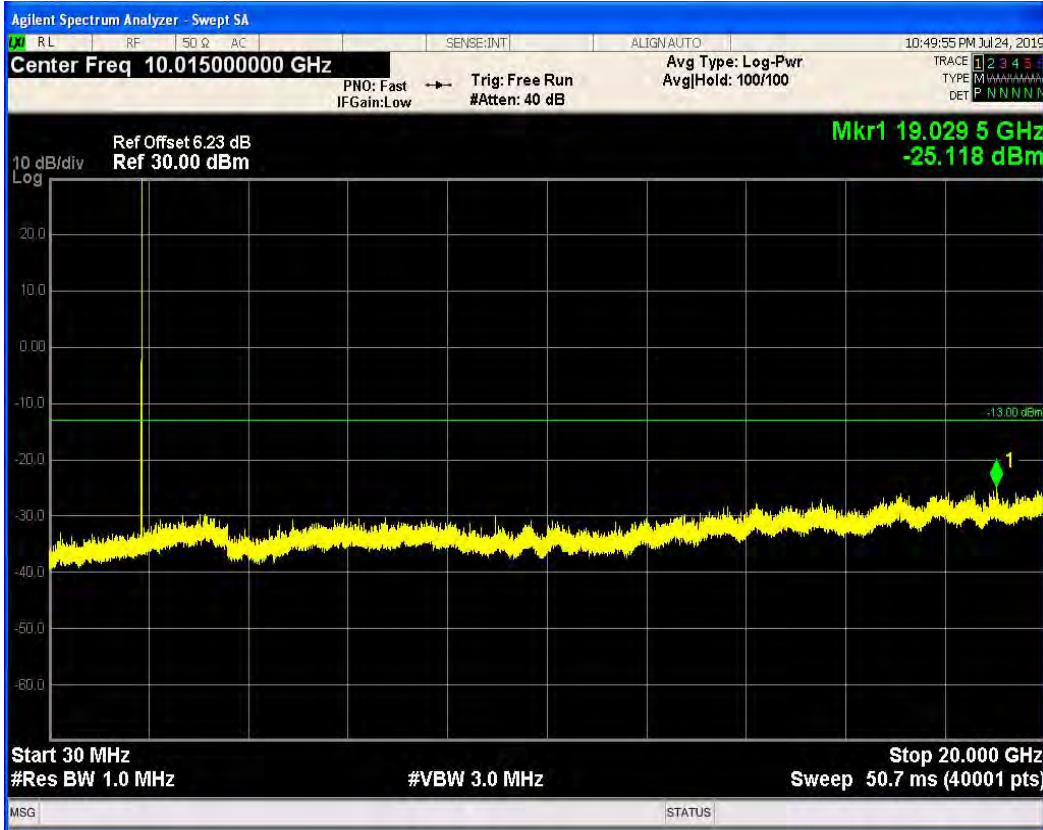

GSM1900 Channel=810

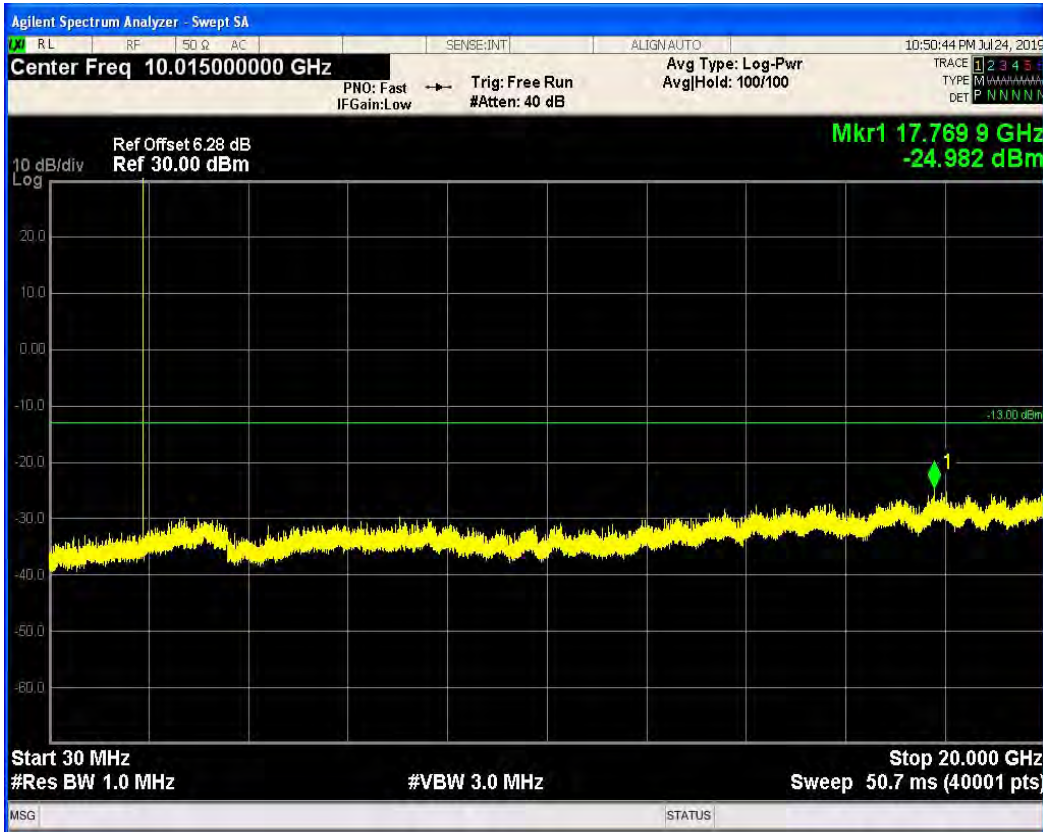

GPRS850 Channel=128

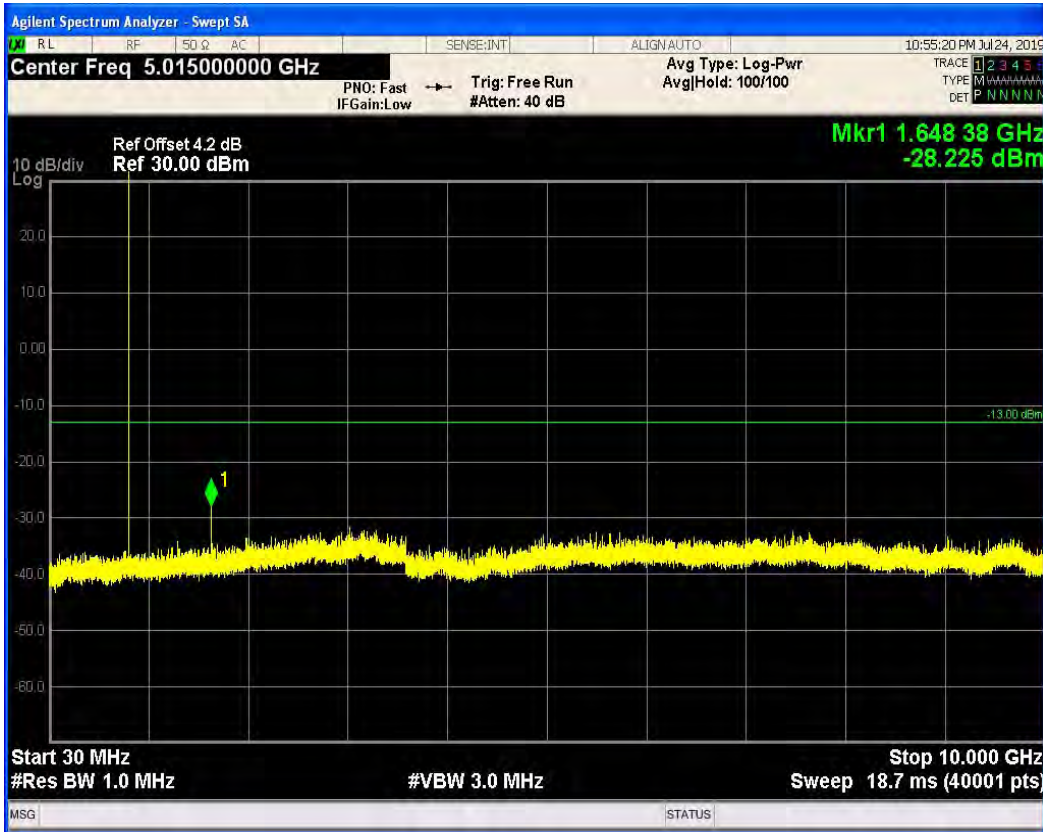

GPRS850 Channel=189

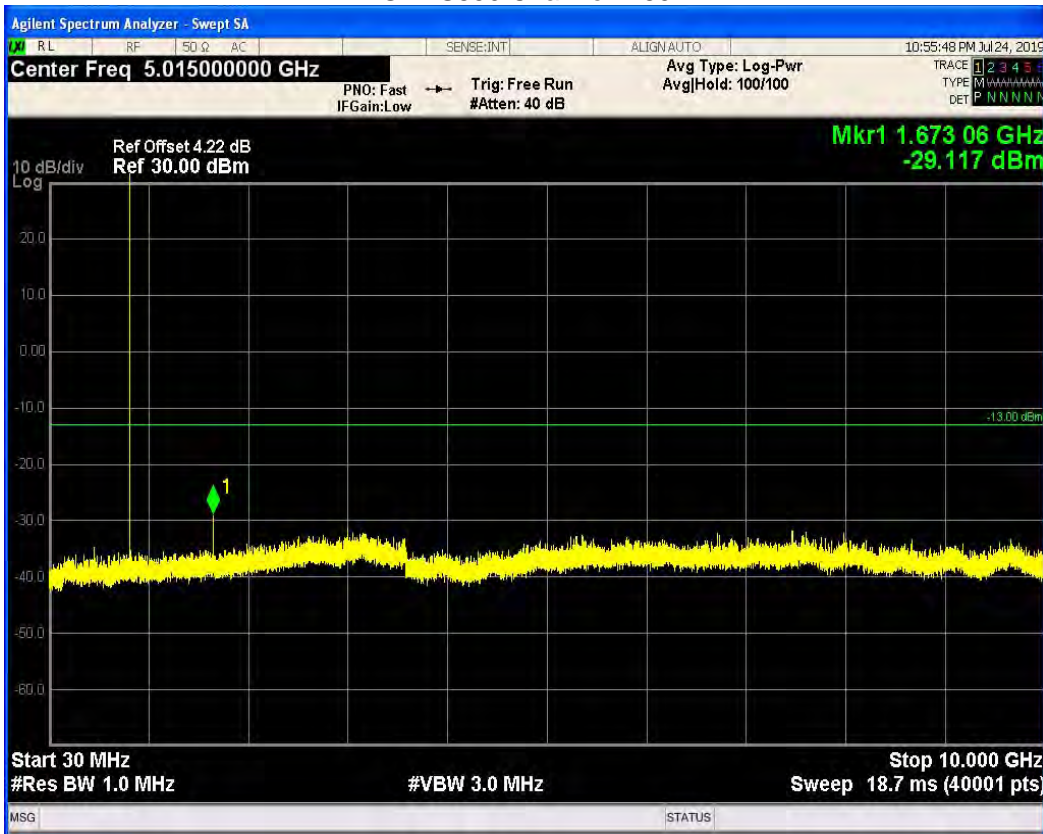

GPRS850 Channel=251

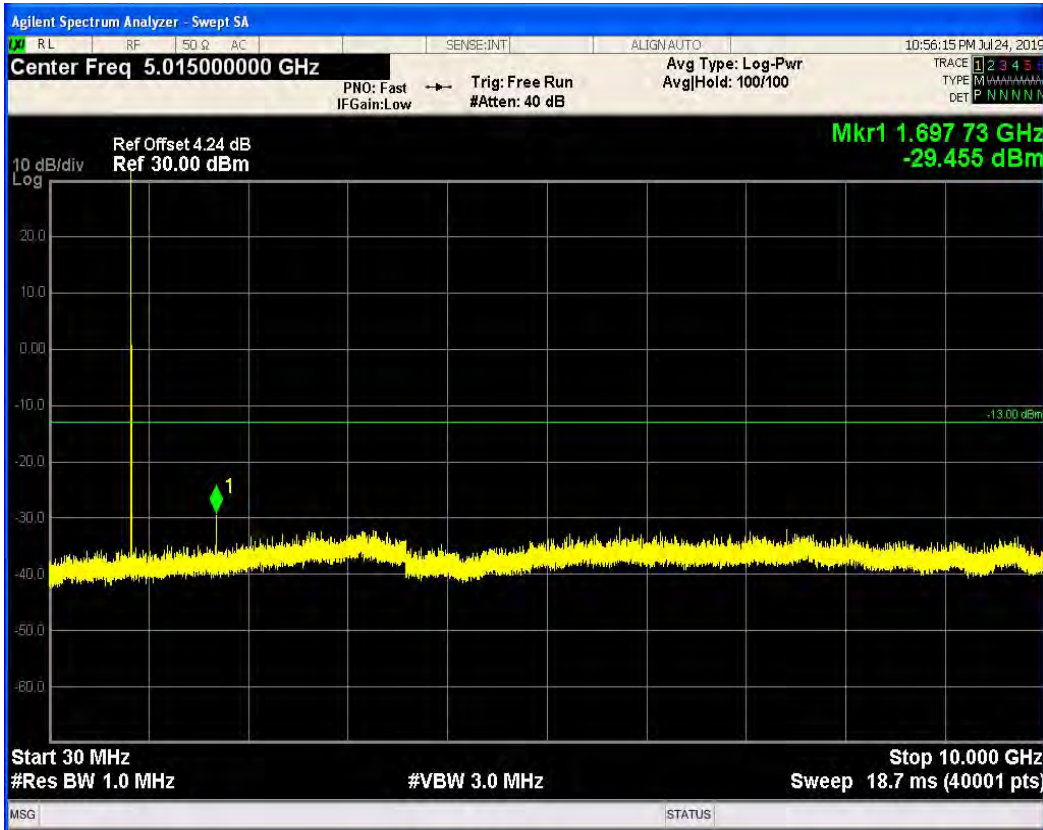

GPRS1900 Channel=512

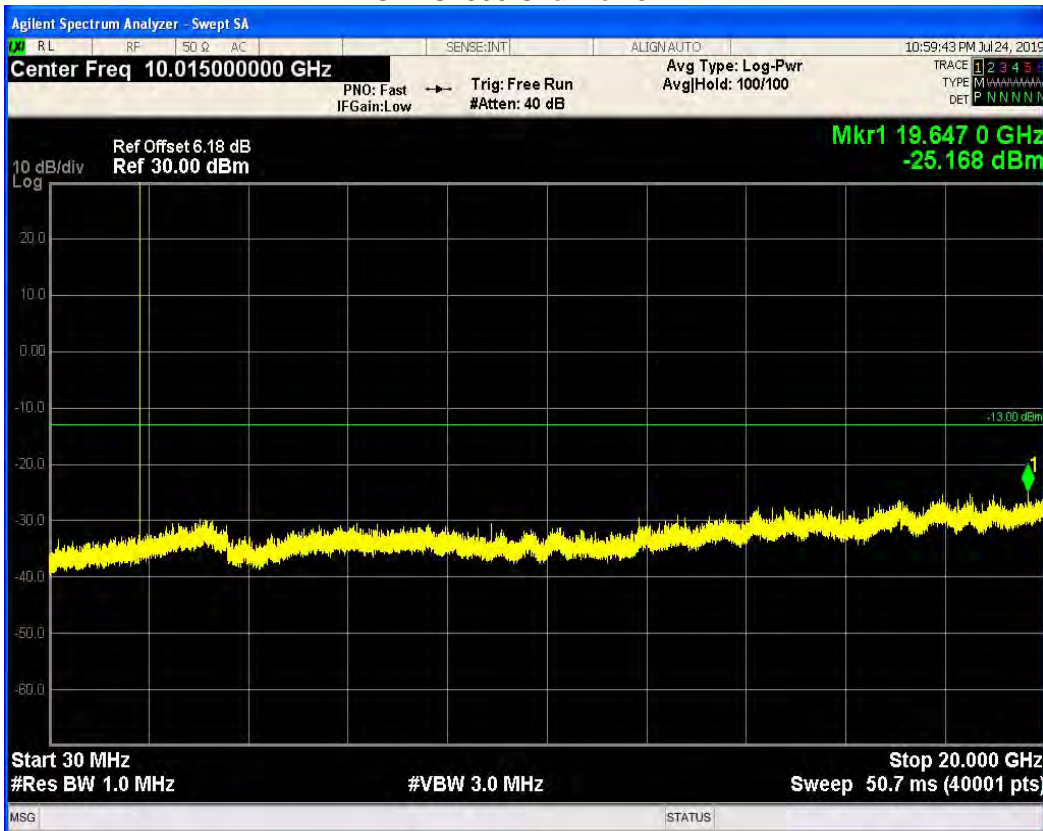

GPRS1900 Channel=661

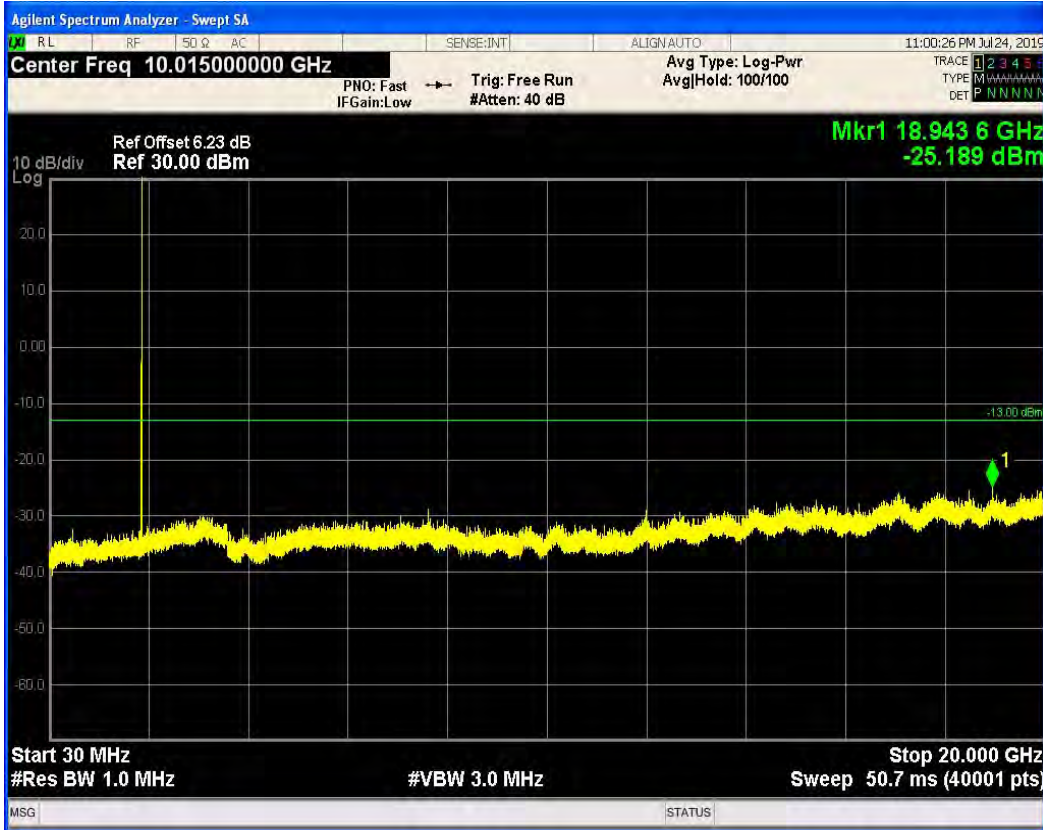

GPRS1900 Channel=810

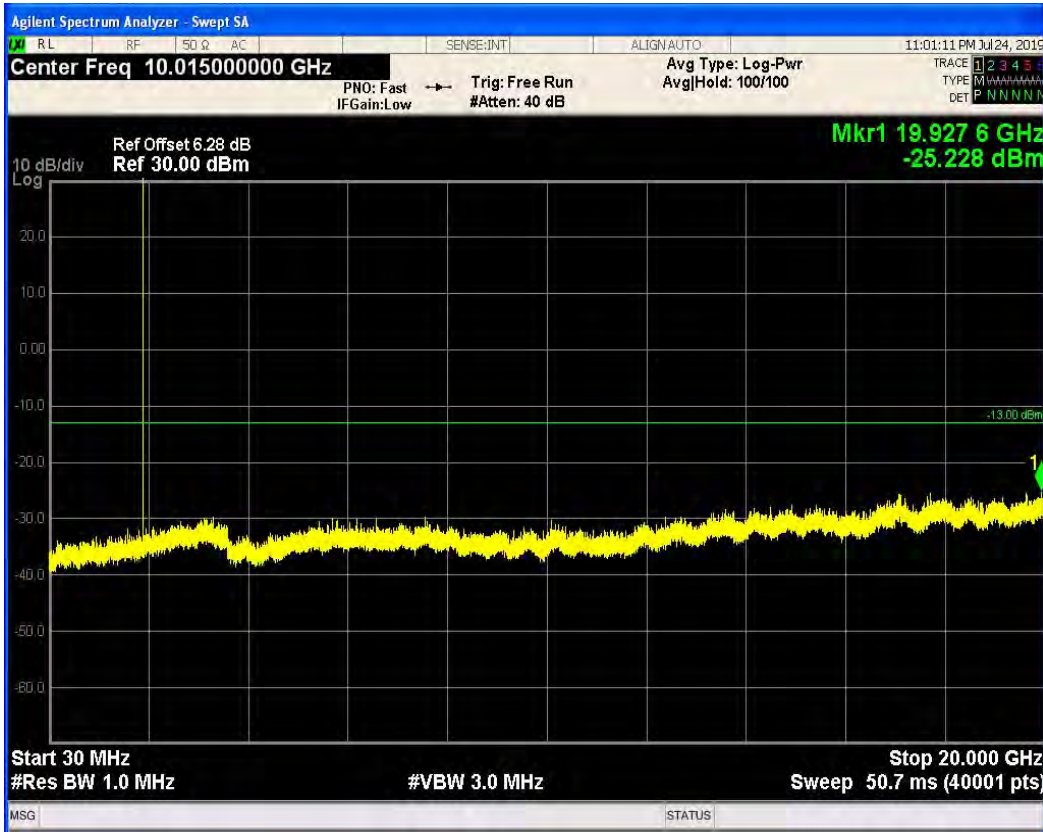

EGPRS850 Channel=128

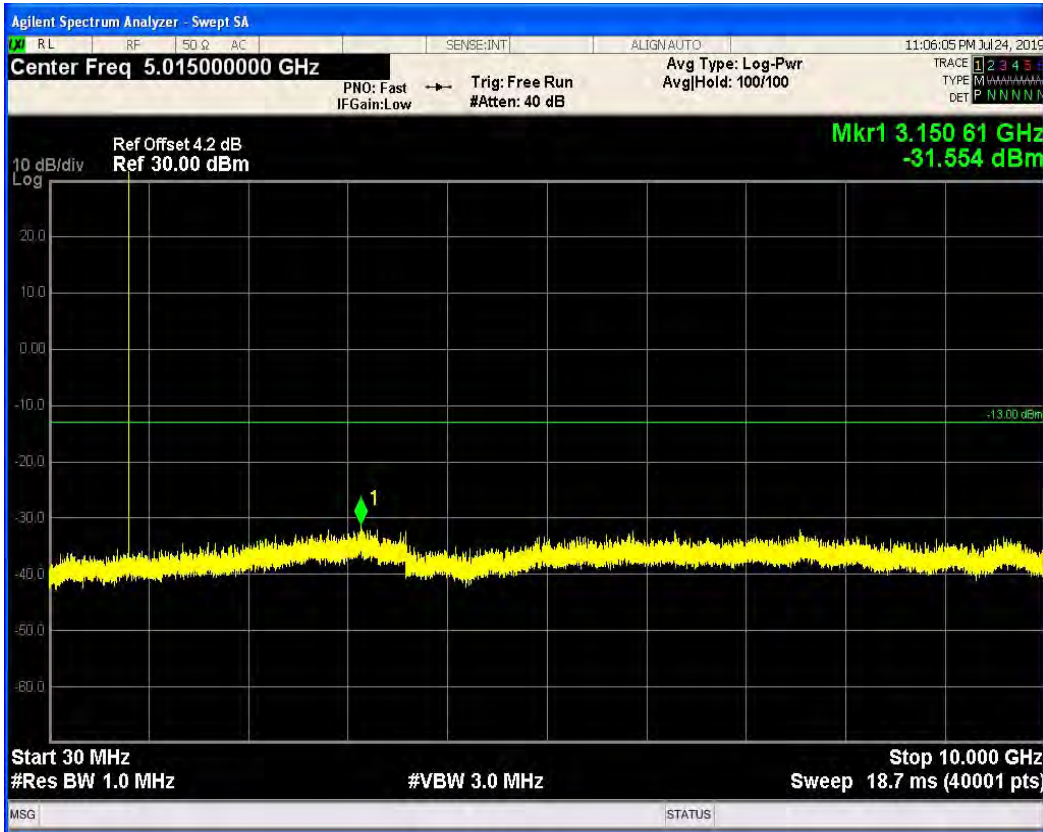

EGPRS850 Channel=189

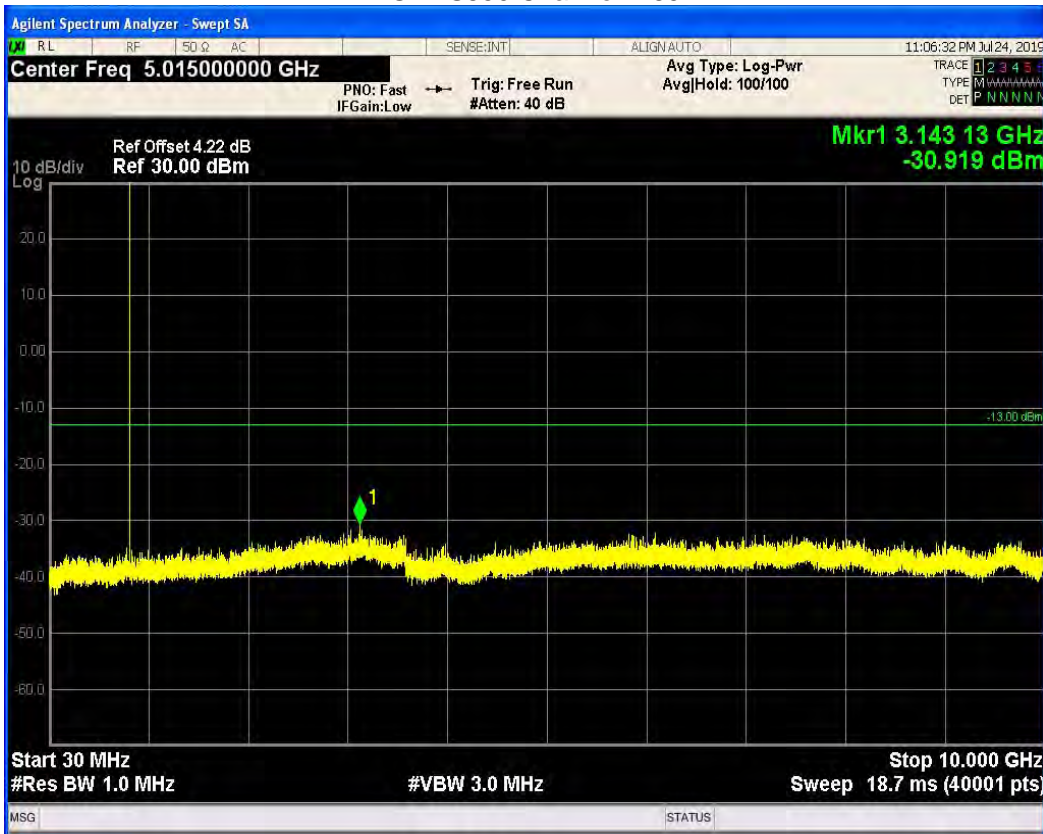

EGPRS850 Channel=251

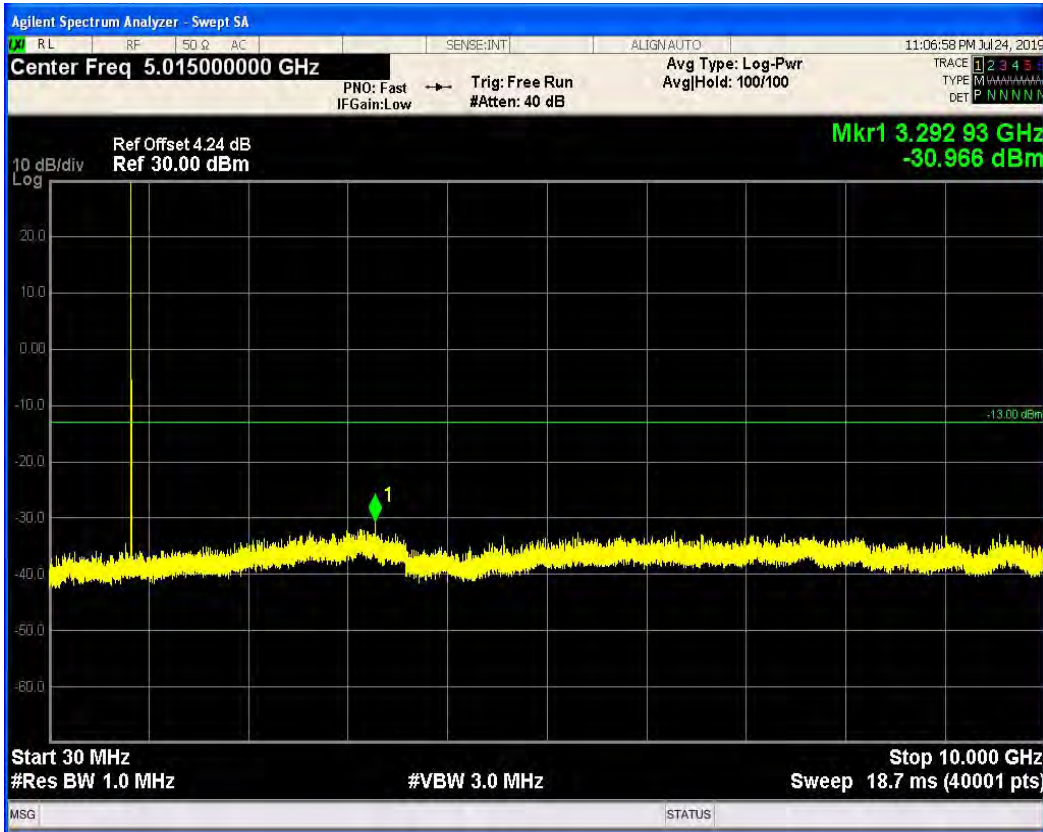

EGPRS1900 Channel=661

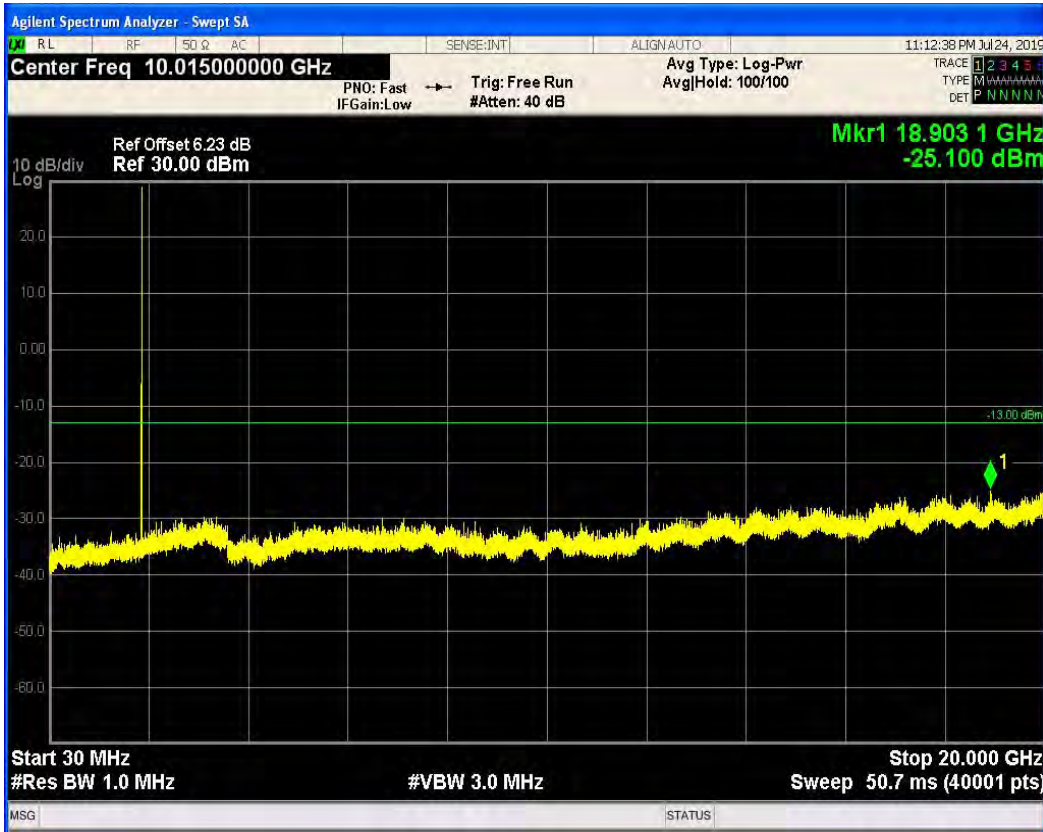

EGPRS1900 Channel=512

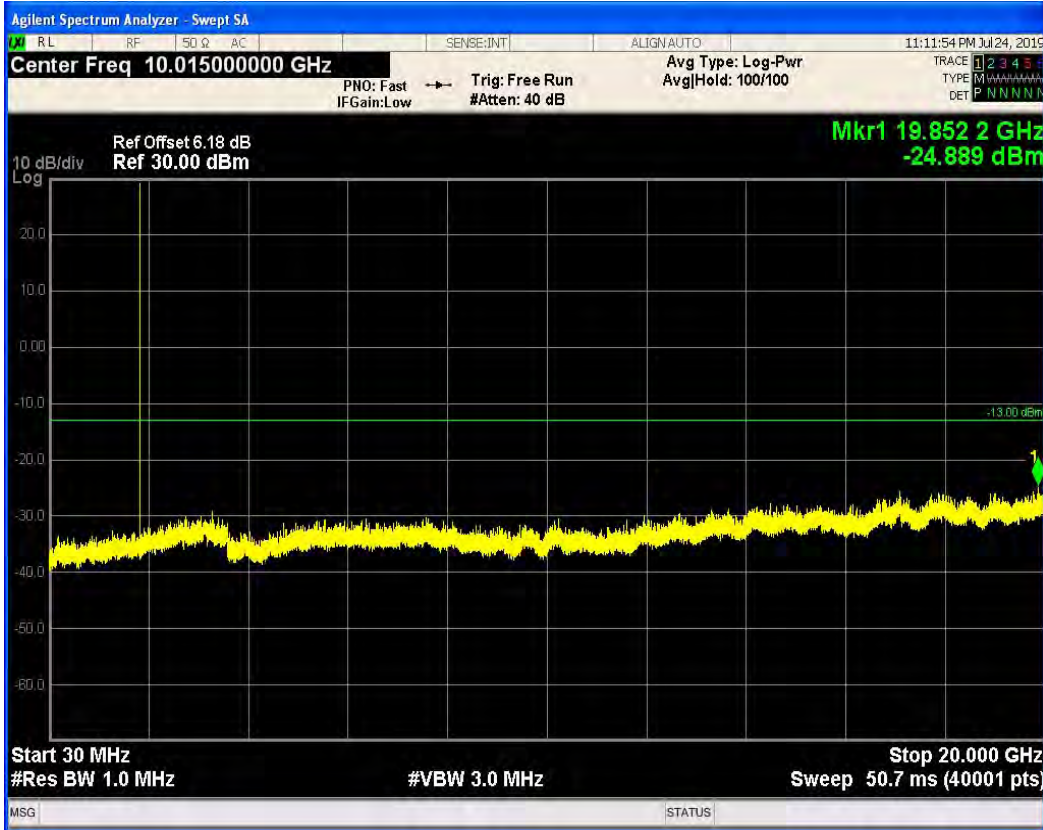

EGPRS1900 Channel=810

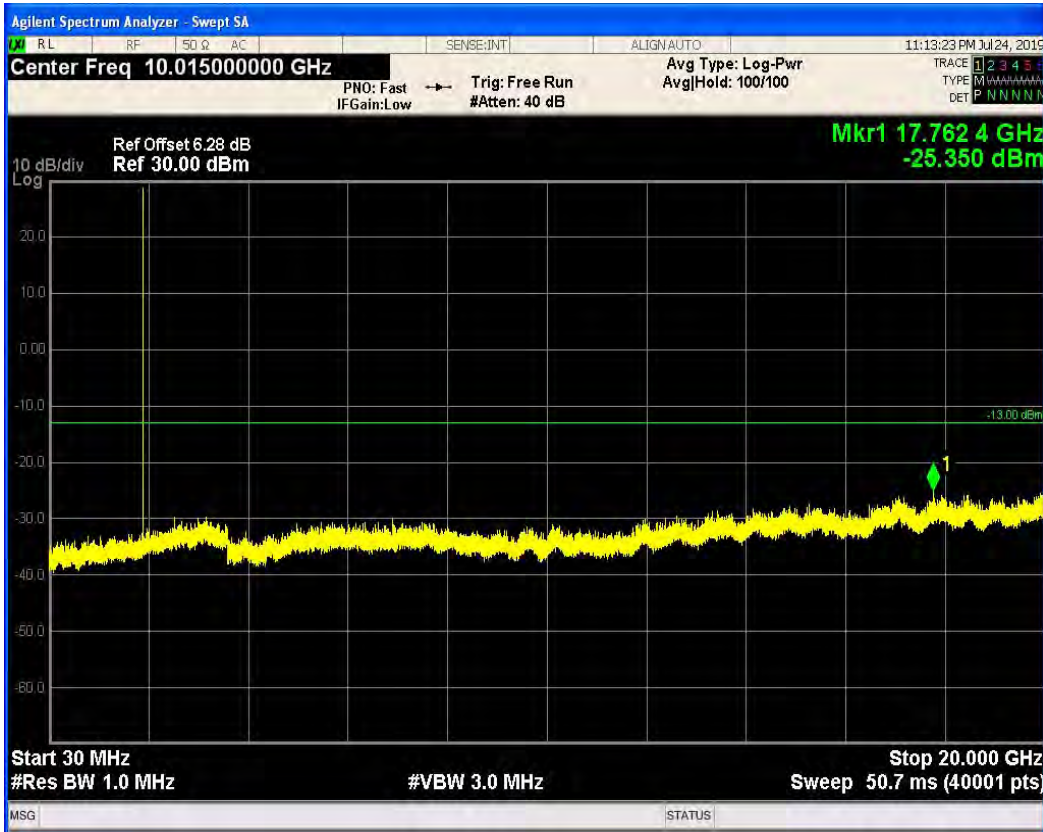

WCDMA Band2 Channel=9262

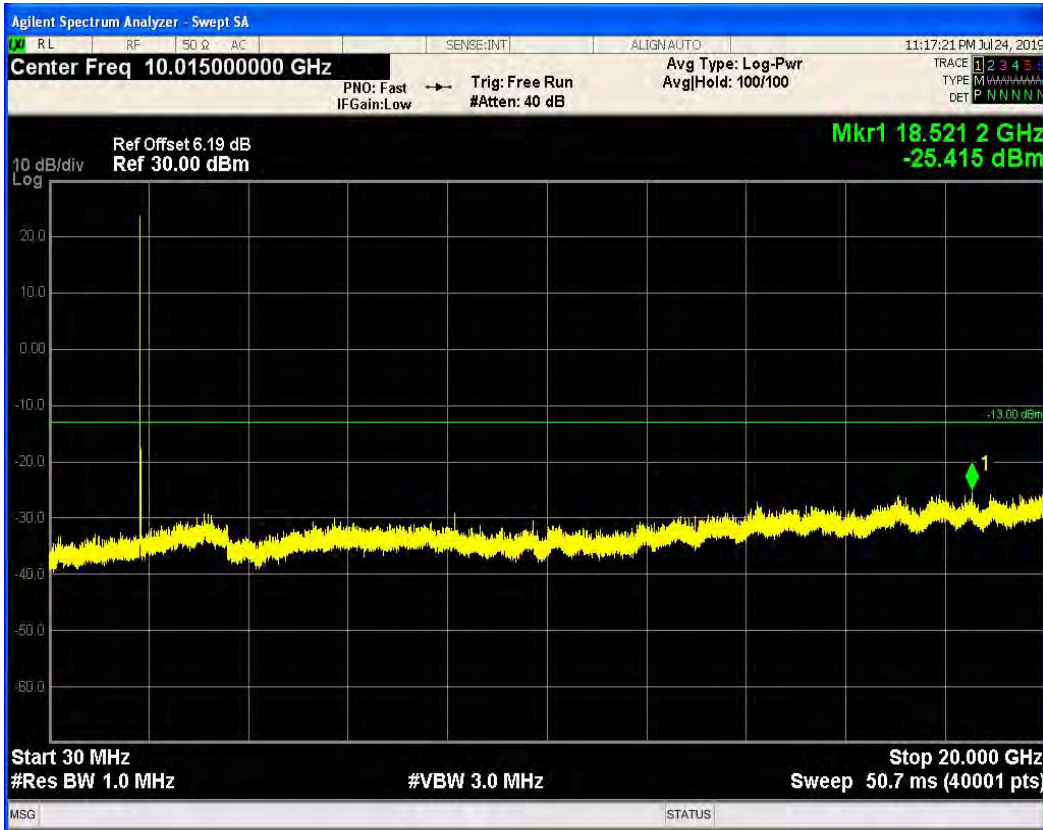

WCDMA Band2 Channel=9400

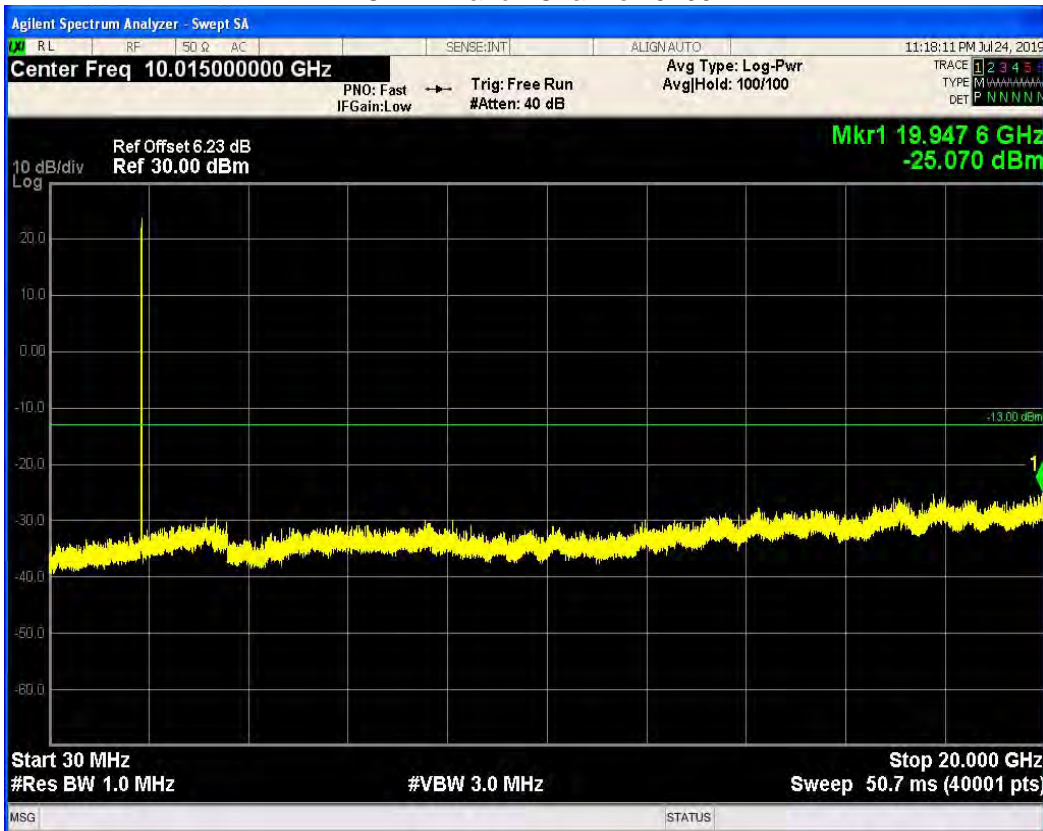

WCDMA Band2 Channel=9538

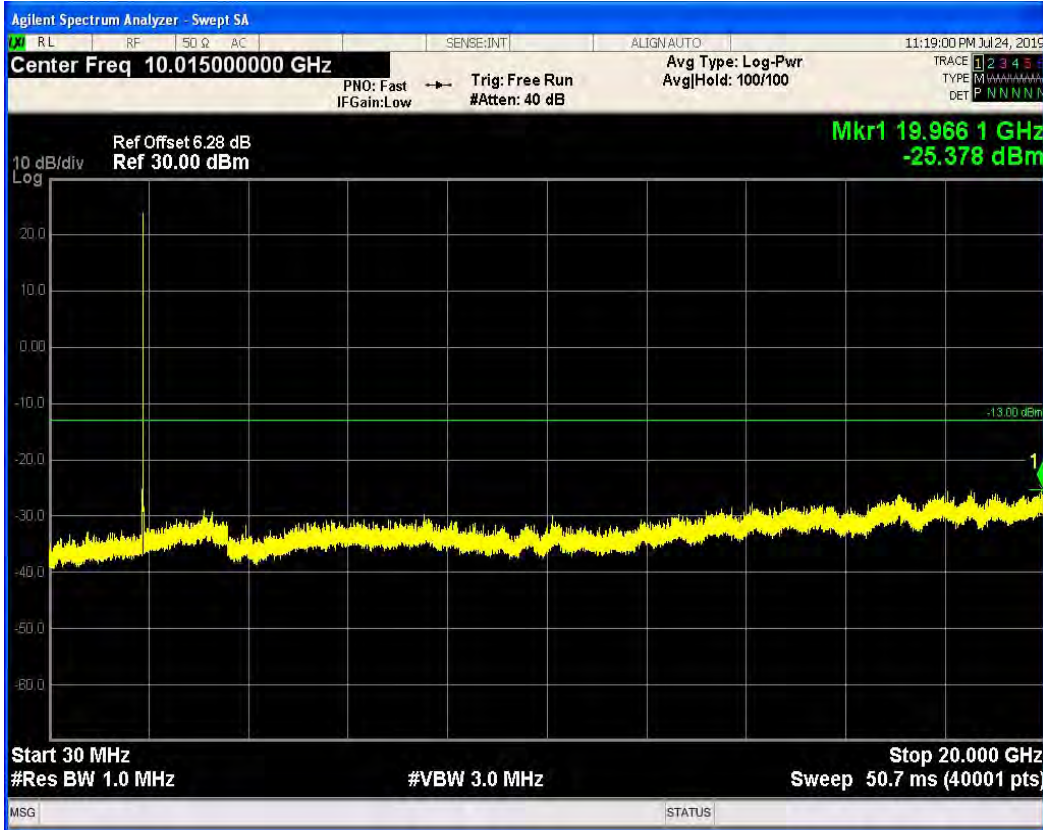

WCDMA Band4 Channel=1513

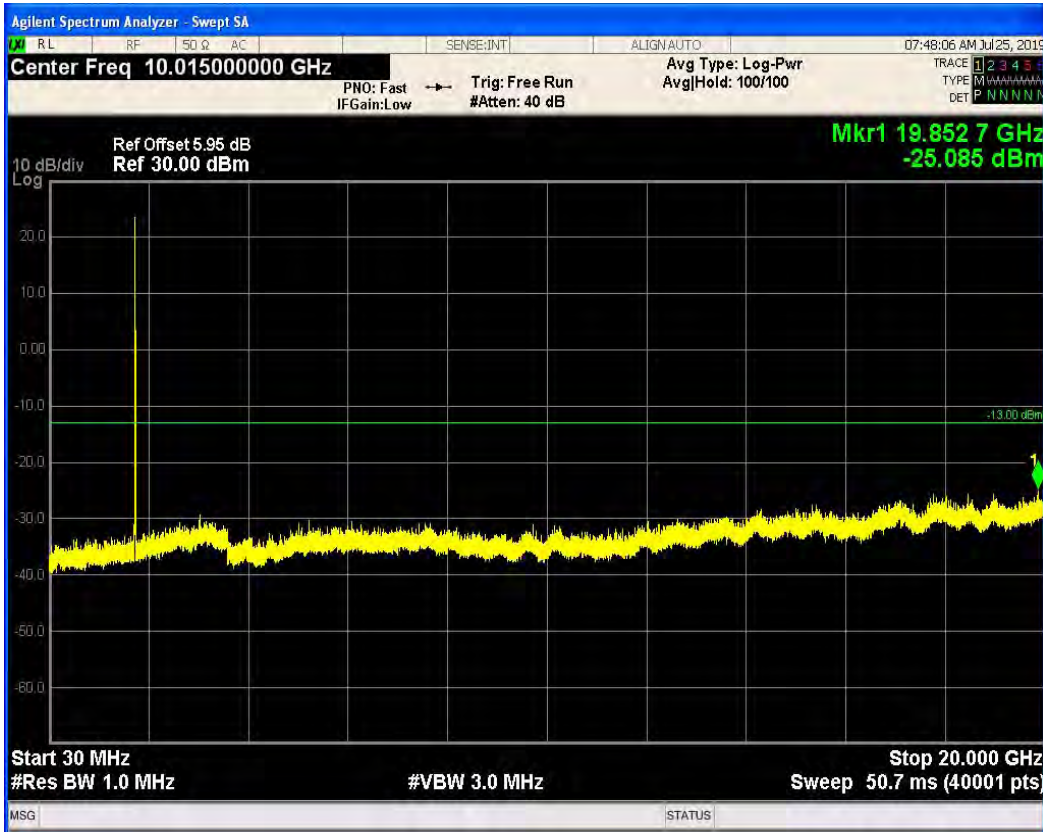

WCDMA Band4 Channel=1412

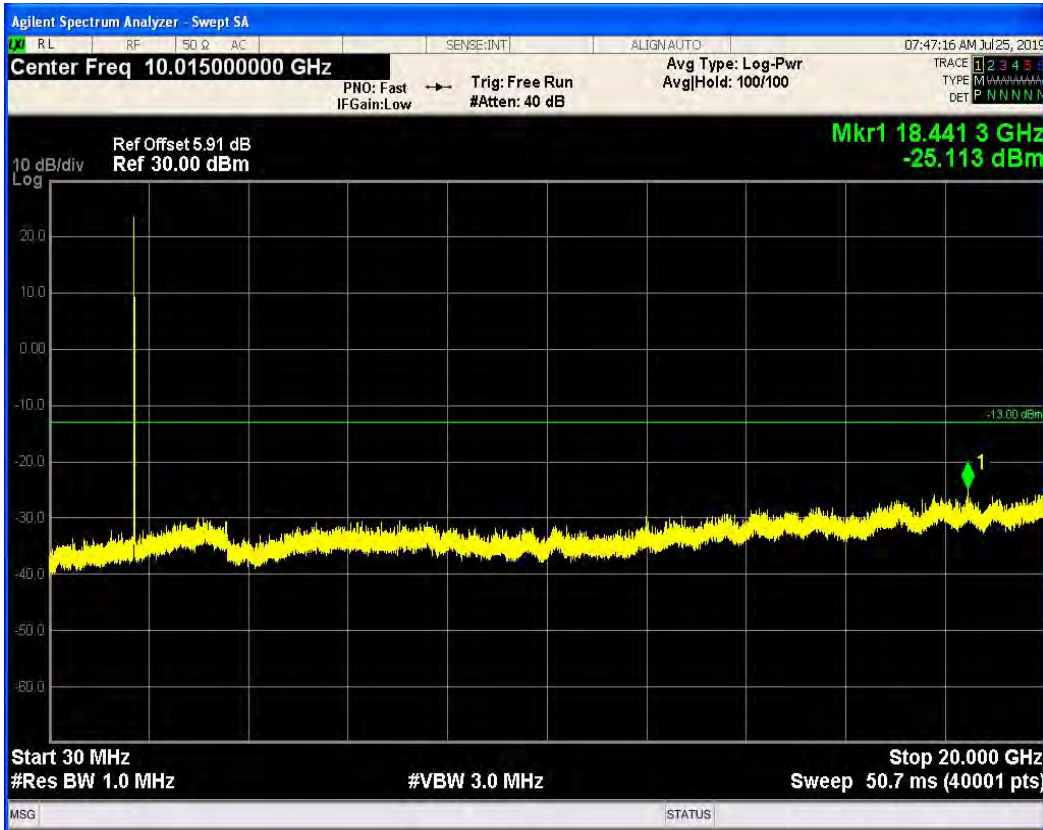

WCDMA Band4 Channel=1312

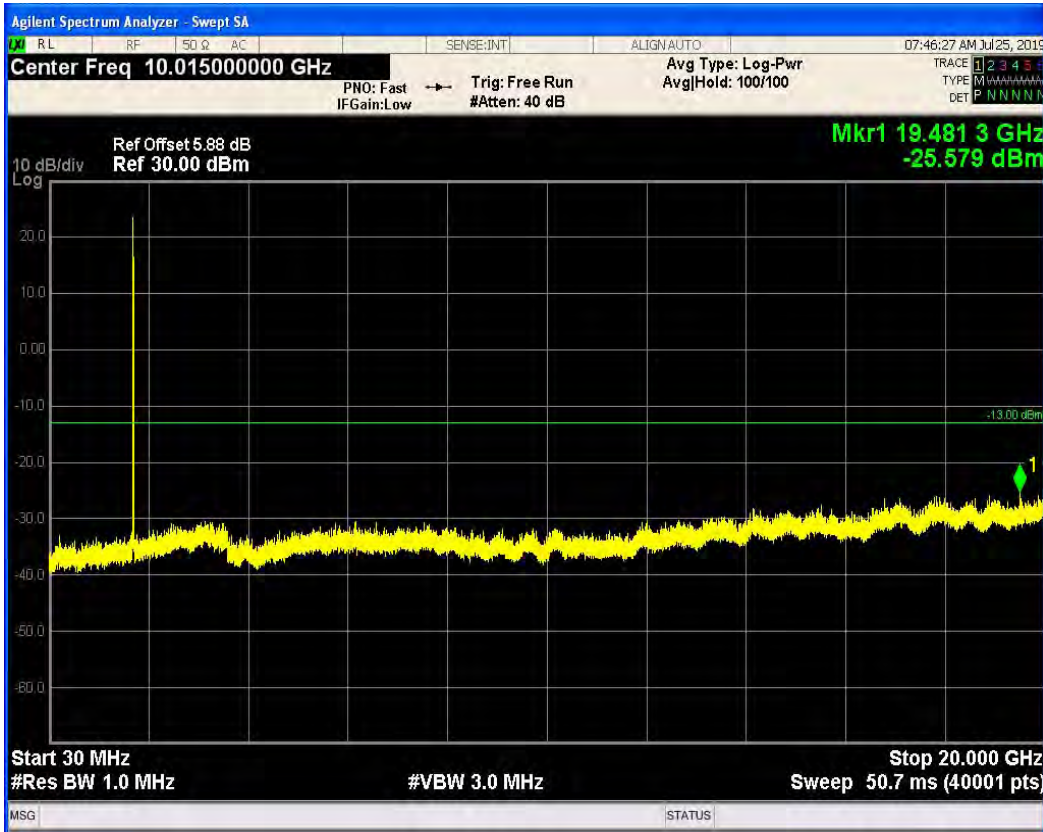

WCDMA Band5 Channel=4132

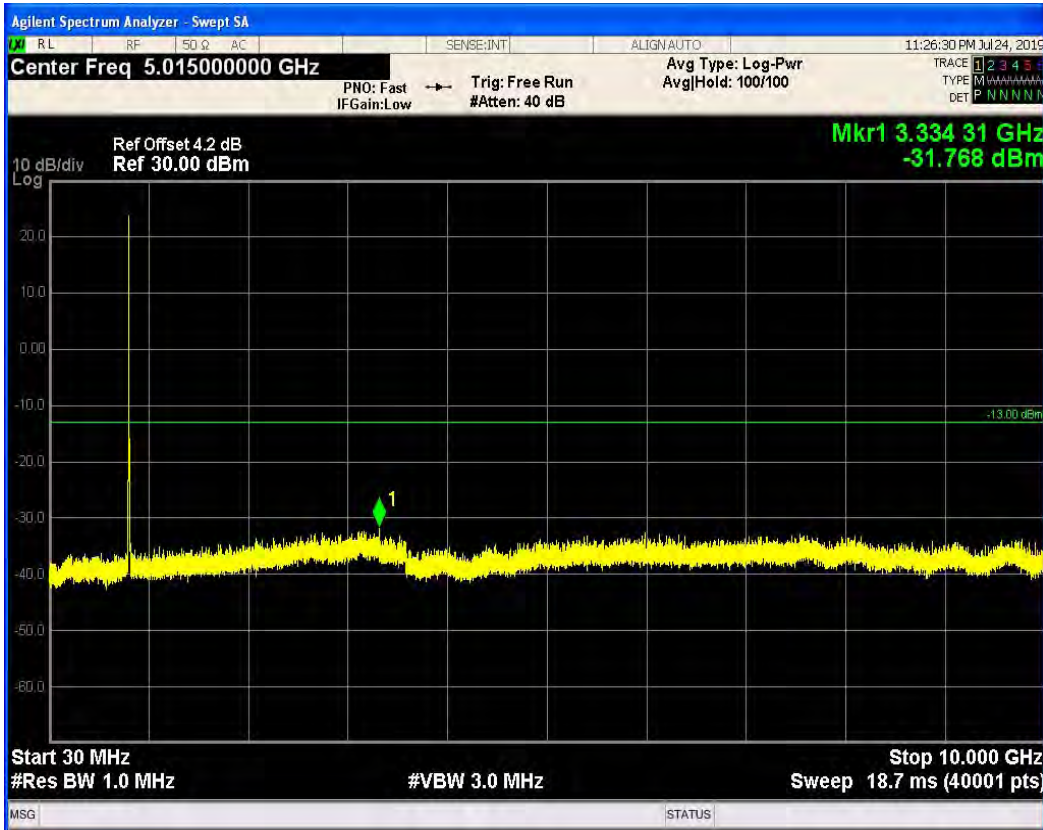

WCDMA Band5 Channel=4182

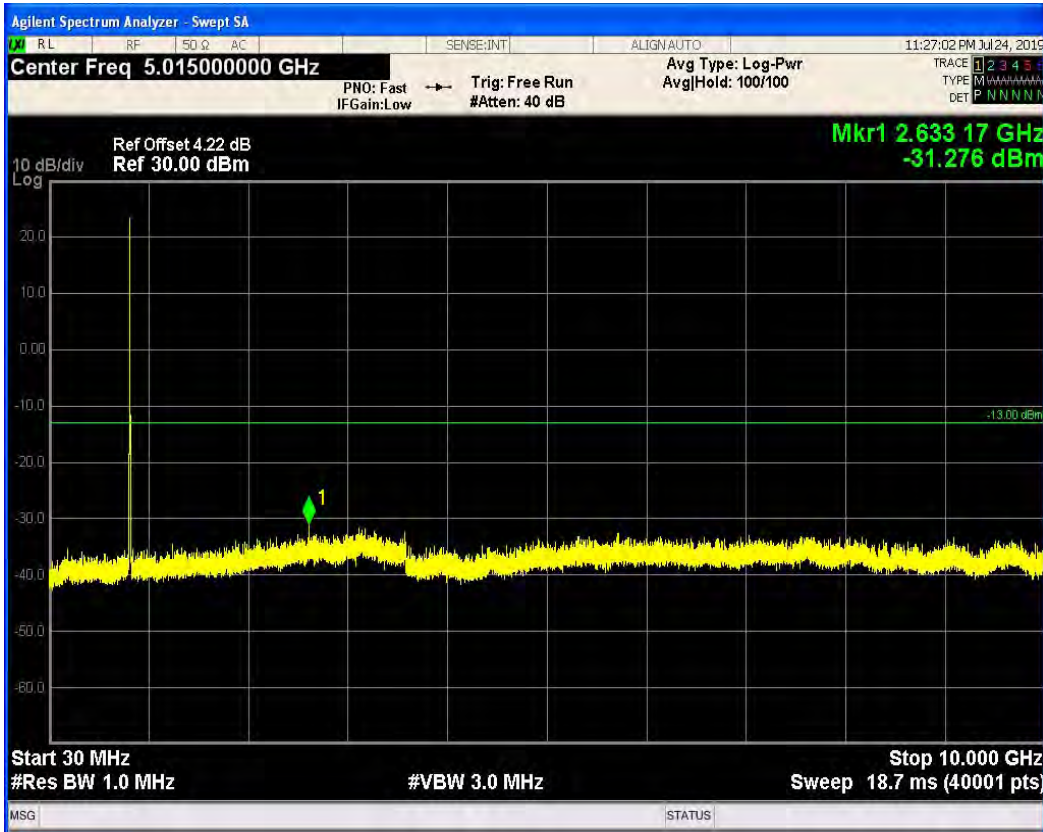

WCDMA Band5 Channel=4233

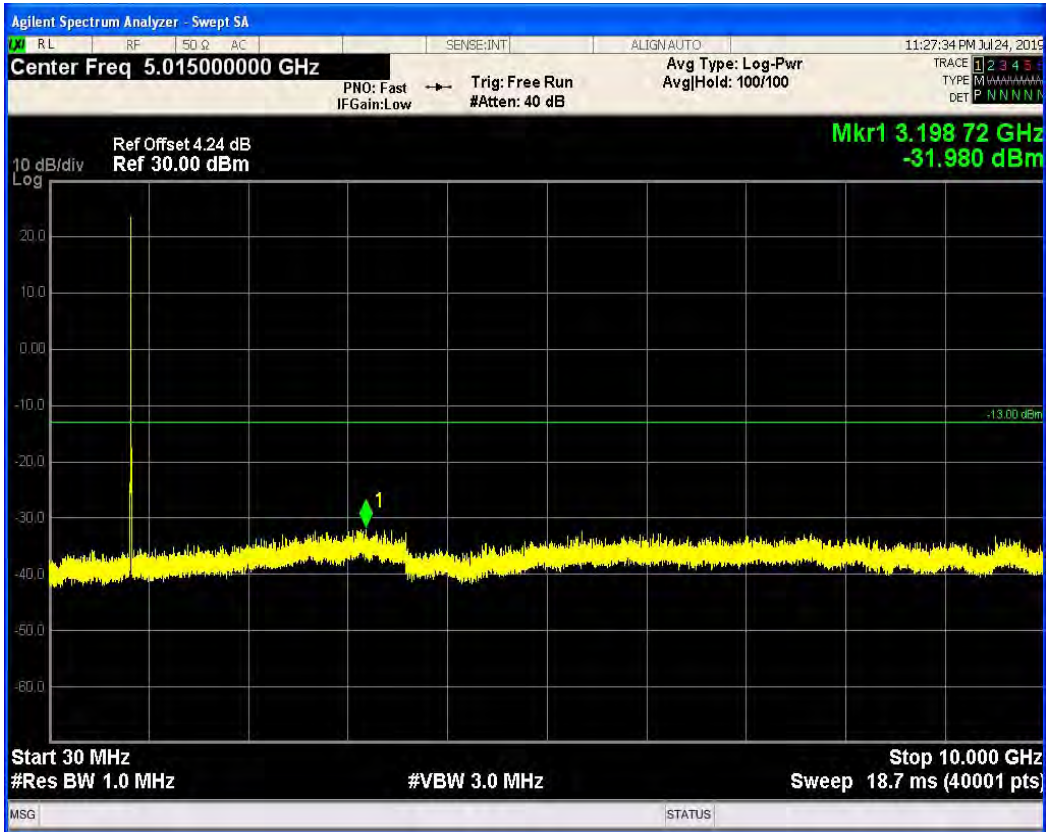

END OF REPORT