

OUKITEL

Smart Phone

K12

Thanks for choosing OUKITEL products

Overview

---

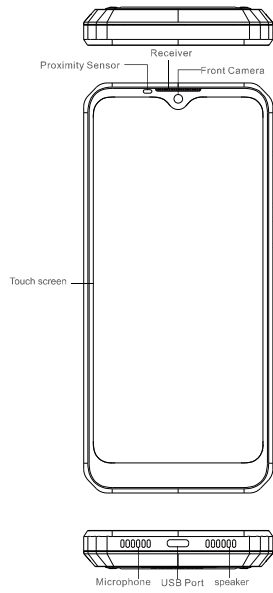

Overview

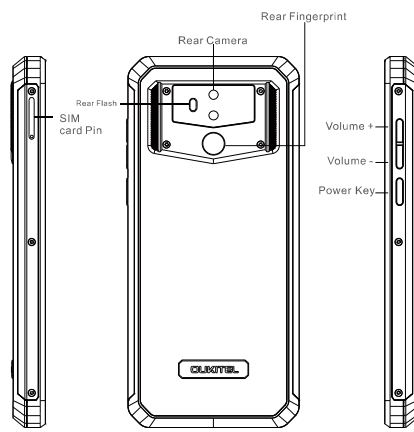

Accessories

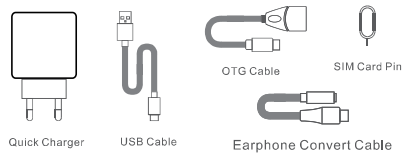

## Battery

---

K12 is included an internal battery.  
You can track your battery status with the icon showed on the top right of the screen. As microwave ovens, stoves, or radiators, batteries may explode when overheated.

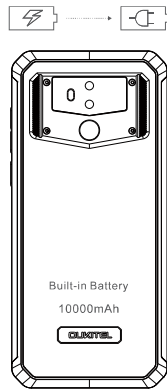

## Warning

- Use only DUKITEL-approved batteries specifically designed for your phone. Incompatible batteries can cause serious injuries or damage to your phone.
- Never place batteries or phones on or in heating devices, such as microwave ovens, stoves, or radiators, Batteries may explode when overheated.

## Overview

---

### Basic parameters

---

Display: 6.3" FHD+ Touchscreen  
Color: Black  
Operating system: Android™ 9 Pie  
Processor: 4x Cortex-A53 up to 2.3GHz/4x Cortex-A53 up to 1.8GHz  
GPU: IMG GE8320 Up to 680MHz  
RAM: 4/6GB  
ROM: 64GB/128GB (Expandable UP to 128GB)  
Battery: 10000mAh, 5V/6A charge

### Camera

---

Rear Camera	Front Camera
16.0MP main camera LED Flash	8.0MP

### Connection (I/O)

---

2G: 850/1900  
3G: band2/5  
4G: band2/4/5/7  
SIM Card Slot: Dual SIM ,Nano+Nano  
FM:87.5 MHz -108 MHz

### Other Features

---

Video: AVI, MP4, WMV, MKV, MOV, ASF, FLV  
Audio: FLAC, APE, AAC, MKA, MP3, M4A, AMR, ALAC, WAV  
Image: JPEG, BMP, GIF, PNG

### Dimensions

---

Height: 163,5mm  
Width: 75,4mm  
Thickness: 14,5mm  
Weight: 290g

### Package contents

---

1*USB Cable	1*Multi-language Manual
1*Charger	1*Phone Case
1*warranty card	1*SIM Card pin
1*Earphone Convert Cable	1*OTG Cable

Comes with the Google™ app and Google Chrome™.  
Android is a trademark of Google LLC.  
MANUFACTURER NAME: SHENZHEN YUNJI INTELLIGENT TECHNOLOGY CO.,LTD  
MANUFACTURER ADDRESS: A-SIDE A2 BUILDING 2/F ENET NEW INDUSTRIAL PARK, NO.20  
DAFU INDUSTRIAL ZONE, ADBEI COMMUNITY, GUANLAN, LONGHUA NEW  
DISTRICT, SHENZHEN CHINA

Visão geral

---

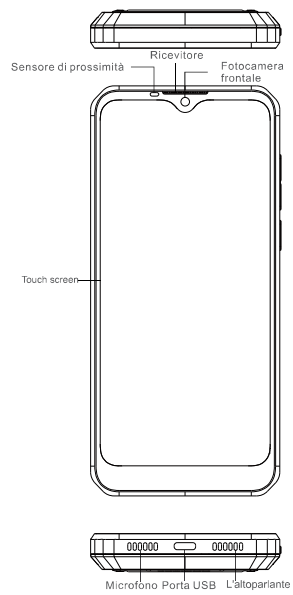

## Visão geral

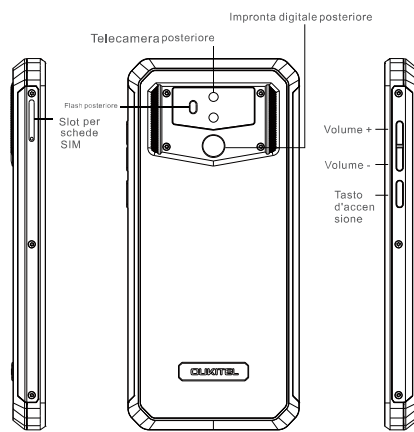

## Accessori

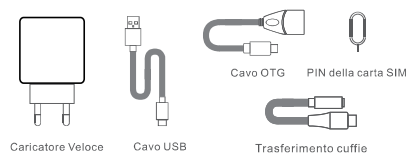

## Batteria

K12 è inclusa una batteria interna.  
Puoi monitorare lo stato della batteria con l'icona mostrata in alto a destra sullo schermo. Come forni a microonde, stufe o radiatori, le batterie possono esplodere se surriscaldate.

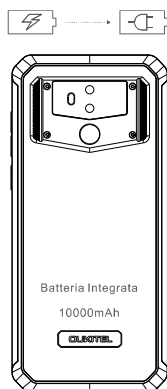

## Avvertimento

- Utilizzare solo batterie approvate da OUKITEL specificamente progettate per il telefono. Le batterie incompatibili possono causare lesioni gravi o danni al telefono.
- Non posizionare mai batterie o telefoni su o in dispositivi di riscaldamento, come forni a microonde, stufe o radiatori. Le batterie possono esplodere se surriscaldate.



## Überblick

---

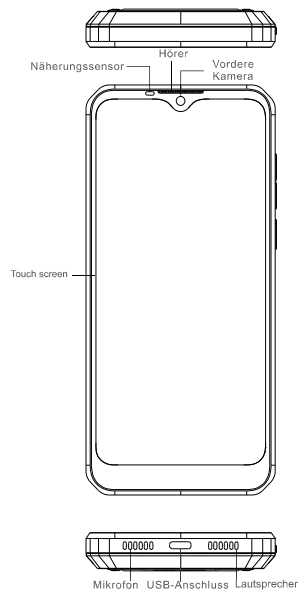

## Überblick

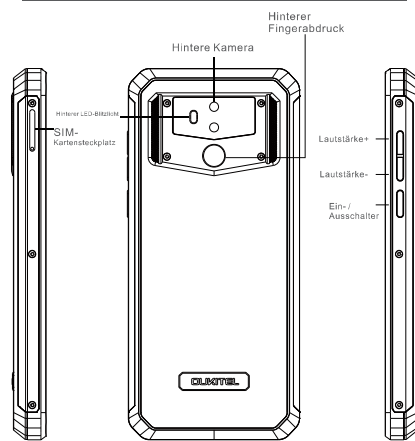

## Zubehör

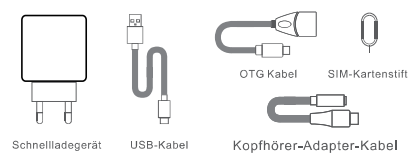

## Akku

Das K12 enthält einen fest verbauten Akku. Sie können den Ladesstatus mit dem Symbol oben rechts auf dem Bildschirm verfolgen. Nicht in der Nähe von Mikrowellen, Öfen oder Heizkörpern aufbewahren, da Akkus bei Überhitzung explodieren können.

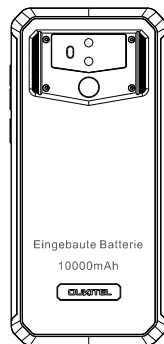

## Warnung

- Verwenden Sie nur durch OUKITEL-zugelassene Akkus, die speziell für Ihr Handy entwickelt wurden. Unverträgliche Akkus können schwere Verletzungen verursachen oder Ihr Telefon beschädigen.
- Legen Sie niemals Akkus oder Telefone auf oder in Heizgeräte, Mikrowellenherde, Öfen oder Heizkörper. Die Akkus können explodieren wenn sie überhitzt werden.

## Überblick

### Grundparameter

Display:	6,3" FHD + Touchscreen
Farben:	Schwarz
Betriebssystem:	Android™ 9 Pie
Prozessor:	4x Cortex-A53 up to 2,3GHz/4x Cortex-A53 up to 1,8GHz
GPU:	Mali G73MP2 up to 680MHz
RAM:	4/6GB
ROM:	64GB/128GB (Externer Speicher: TF-Karte bis zu 128GB)
Akku:	1000mAh, 5V/6A Schnellladung

### Kamera

hintere Kamera	vordere Kamera
16,0MP Hauptkamera LED-Blitlicht	8,0MP

### Verbindung

2G: 850/1900  
3G: 2/5  
4G: 2/4/5/7  
SIM Kartensteckplatz: Dual-SIM, Nano + Nano  
FM: 87.5 MHz - 108 MHz

### weitere Eigenschaften

Video: AVI, MP4, WMV, MKV, MOV, ASF, FLV  
Audio: FLAC, APE, AAC, MKA, MP3, M4A, AMR, ALAC, WAV  
Bild: JPEG, BMP, GIF, PNG

### Abmessungen

Länge: 163,5mm  
Breite: 75,4mm  
Höhe: 14,5mm  
Gewicht: 290g

### Packungsinhalt

1\*USB-Kabel  
1\*Ladegerät  
1\*SIM-Kartenstift  
1\*OTG Kabel  
1\*mehrsprachiges Handbuch  
1\*Garantiekarte  
1\*Schutzfolie  
1\*Kopfhörer-Adapter-Kabel

### Inklusive Google™ App und Google Chrome™.

Android ist eine Marke von Google LLC.  
HERSTELLERNAME: SHENZHEN YUNJI INTELLIGENT TECHNOLOGY CO., LTD  
HERSTELLERADRESSE: A-SIDE A2 BUILDING 2 / FENET NEUER INDUSTRIAL PARK, NO.20 DAFU INDUSTRIAL ZONE, AOBEL COMMUNITY, GUANLAN, LONGHUA NEUES BEZIRK, SHENZHEN CHINA

Общие сведения

---

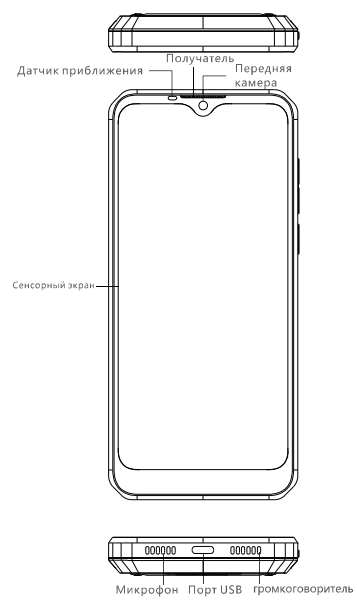

Общие сведения

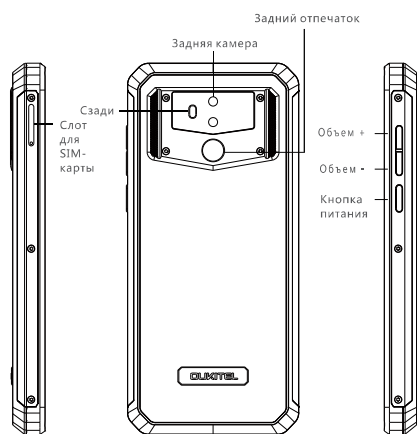

Аксессуары



## Батарея

В комплект поставки K12 входит одна тренья батарея. Вы можете отслеживать состояние батареи с помощью значка, показанного в правом верхнем углу экрана. Вблизи микроволновых печей, кухонных плит или радиаторов, батареи могут взорваться при перегреве.



## Предупреждение

- Используйте только одобренные батареи OUKITEL, специально предназначенные для вашего телефона. Несовместимые батареи могут стать причиной серьезных травм или повреждения телефона.
- Никогда не помещайте батареи и телефоны в нагревающие устройства, например, в микроволновые печи, печи или радиаторы. При перегреве батареи могут взорваться.

Descripción

---

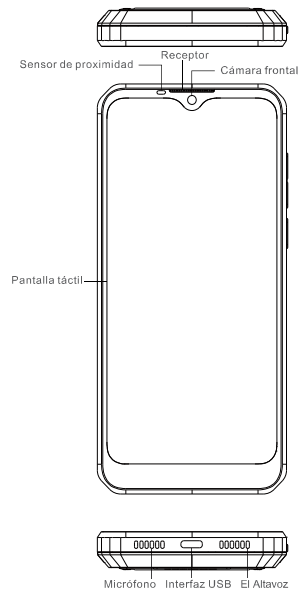



### Descripción

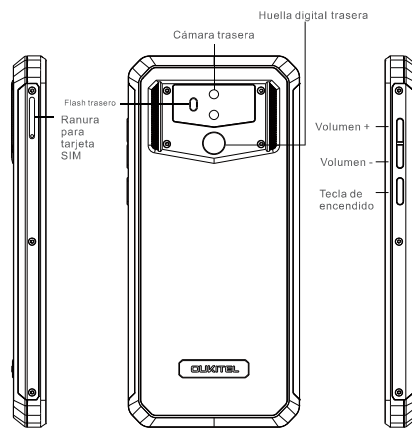

### Accesorios

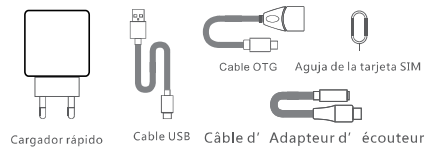

## Batería

K12 incluye batería interna.

Puede controlar el estado de su batería con el icono que se muestra en la parte superior derecha de la pantalla. Las baterías pueden explotar cuando se sobrecaliente en hornos microondas, estufas o radiadores.

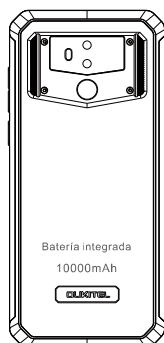

## Advertencia

- Utilice únicamente baterías diseñadas y aprobadas por OUKITEL, si usa baterías incompatibles pueden causar lesiones graves y daños en el teléfono.
- Nunca coloque baterías o teléfonos en o en dispositivos como hornos microondas, estufas o radiadores. Las baterías pueden explotar cuando se sobrecalienta.

## Aperçu

---

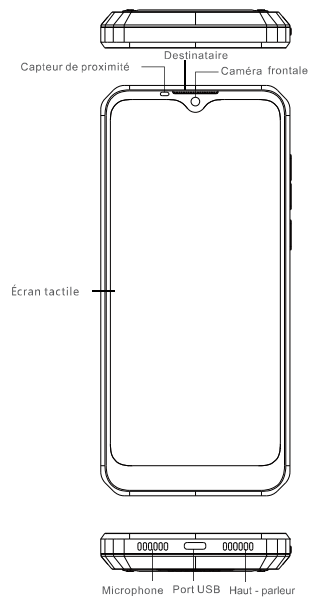

## Aperçu

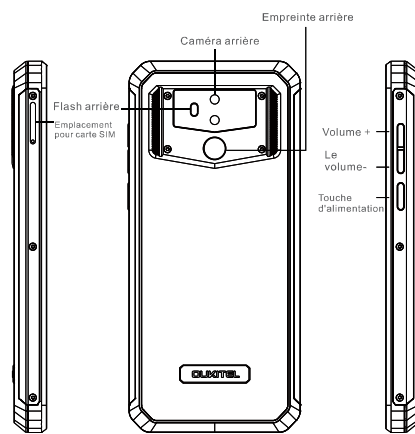

## Accessories

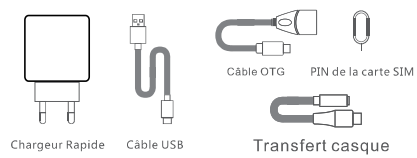

## Batteries

K12 est inclus une batterie interne.  
Vous pouvez suivre l'état de votre batterie avec l'icône affichée en haut à droite de l'écran. Comme four à micro-ondes, cuisinières ou radiateurs, les batteries peuvent exploser lorsqu'elles sont surchauffées.

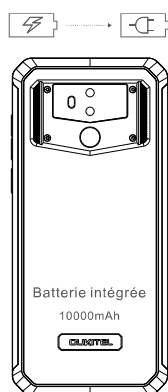

## Attention

- Utilisez uniquement des batteries approuvées par OUKITEL spécialement conçues pour ton téléphone. Les batteries incompatibles peuvent causer des blessures graves ou dommage sur votre téléphone.
- Ne placez jamais les piles ou les téléphones sur ou dans des appareils de chauffage, comme four à micro-ondes, cuisinières ou radiateurs. Les batteries peuvent exploser lorsqu'il est surchauffé.

لمحة عامة

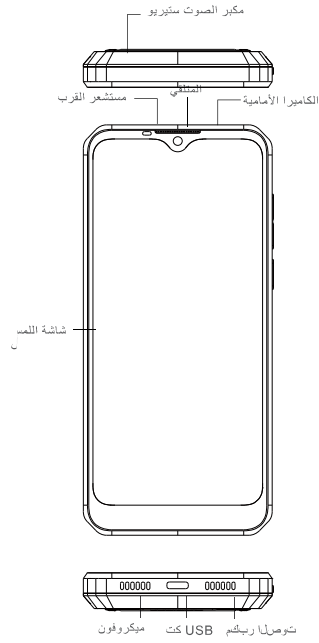

لمحة عامة

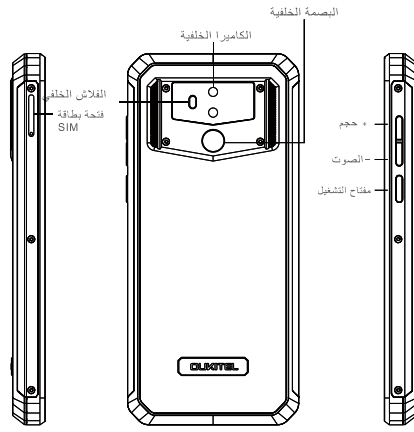

الملحقات

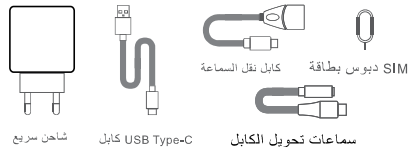

## البطارية

K12 يحتوي على بطارية داخلية  
مكتملة معاملة لتتضمن خلال الأوقات المبردة في الجزء العلوي  
اليمين من الشاشة. كما هو الحال في أفراغ الميكروويف والمواد المشعة،  
يمكن أن تتفجر البطارية عن زيادة حرارتها.

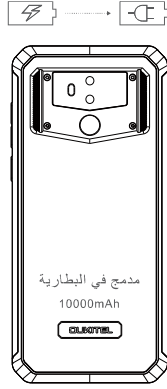

## تحذير:

- استخدام فقط البطاريات المعتمدة من درجة المصممة خصيصاً  
هاتفك. يمكن أن تسبب البطاريات غير المتوافقة إصابات خطيرة  
أو ضرراً بهاتفك.
- لا تضع البطاريات أو الهواتف على أجهزة تسخين، مثل  
أفران الميكروويف أو الموقد أو المشعة. يمكن أن تتفجر البطارية  
عند زيادة حرارتها.



概要

---

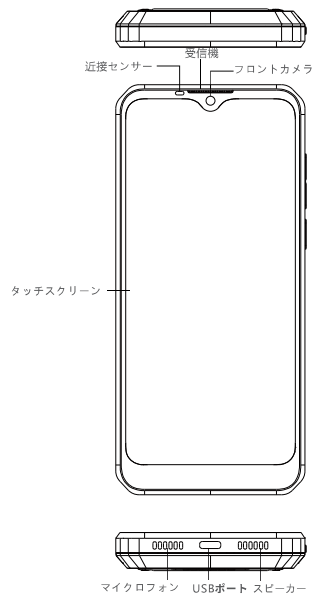

概要

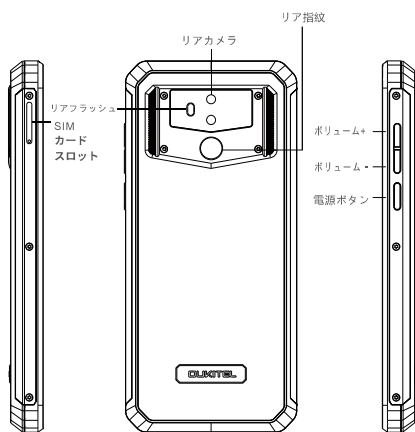

アクセサリ

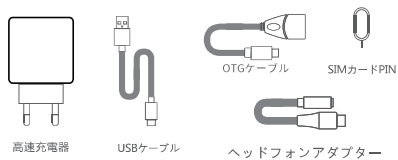

## バッテリー

K12 は内蔵バッテリーが付属しています。  
画面の右上に表示されているアイコンを使ってバッテリーの状態を追跡することができます。電子レンジやストーブなどで電池を加熱すると爆発することがあり危険なのでやめてください。

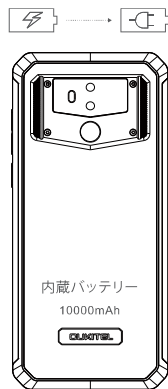

## 警告

- oukitel 専用バッテリー以外は使用しないでください。熱くなる場所にバッテリーやスマホ本体を決して置かないで下さい。電子レンジやストーブなどで電池を加熱すると爆発することがあり危険なのでやめてください。

Manufacturer's Name: OUKITEL

Smart phone

Model number: K12

Operating Temperature: -10° C to 40° C

This device was tested for typical body-worn operations.

To comply with RF exposure requirements, a minimum separation distance of 0mm must be maintained between the user's body and the handset, including the antenna. Third-party belt-clips, holsters, and similar accessories used by this device should not contain any metallic components. Body-worn accessories that do not meet these requirements may not comply with RF exposure requirements and should be avoided. Use only the supplied or an approved antenna.

This device is in compliance with the essential requirements and other relevant provisions of Directive 2014/53/EU. All essential radio test suites have been carried out.

1. Use carefully with the earphone; excessive sound pressure from earphones and headphones can cause hearing loss.

2. CAUTION : RISK OF EXPLOSION IF BATTERY IS REPLACED BY AN INCORRECT TYPE. DISPOSE OF USED BATTERIES ACCORDING TO THE INSTRUCTIONS

3. The product shall only be connected to a USB interface of version USB 2.0

4. Adapter shall be installed near the equipment and shall be easily accessible.

5. The plug is considered as disconnected device of adapter

6. The device complies with RF specifications when the device is used at 0mm from your body

This device complies with part 15 of the FCC Rules. Operation is subject to the condition that this device does not cause harmful interference (1) this device may not cause harmful interference, and (2) this device must accept any interference received, including interference that may cause undesired operation.

This device complies with part 15 of the FCC Rules. Operation is subject to the condition that this device does not cause harmful interference. Any changes or modifications not expressly approved by the party responsible for compliance could void the user's authority to operate the equipment.

NOTE: This equipment has been tested and found to comply with the limits for a Class B digital device, pursuant to Part 15 of the FCC Rules. These limits are designed to provide reasonable protection against harmful interference in a residential installation. This equipment generates, uses and can radiate radio frequency energy and, if not installed and used in accordance with the instructions, may cause harmful interference to radio communications. However, there is no guarantee that interference will not occur in a particular installation.

If this equipment does cause harmful interference to radio or television reception,

which can be determined by turning the equipment off and on, the user is encouraged to try to correct the interference by one or more of the following measures:

-- Reorient or relocate the receiving antenna.

-- Increase the separation between the equipment and receiver.

-- Connect the equipment into an outlet on a circuit different from that to which the receiver is connected.

-- Consult the dealer or an experienced radio/TV technician for help.

**The device has been evaluated to meet general RF exposure requirement. The device can be used in portable exposure condition without restriction.**

Specific Absorption Rate (SAR) information:

This Mobile Phone meets the government's requirements for exposure to radio waves. The guidelines are based on standards that were developed by independent scientific organizations through periodic and thorough evaluation of scientific studies. The standards include a substantial safety margin designed to assure the safety of all persons regardless of age or health.

FCC RF Exposure Information and Statement The SAR limit of USA (FCC) is 1.6 W/kg averaged over one gram of tissue. Device types: K12 (FCC ID: 2ANMU-K12) has also been tested against this SAR limit. The highest SAR value reported under this standard during product certification for use at the ear is 0.541W/kg and when properly worn on the body is 0.698W/kg. This device was tested for typical body-worn operations with the back of the handset kept

10mm from the body. To maintain compliance with FCC RF exposure requirements, use accessories that maintain a 10mm separation distance between the user's body and the back of the handset. The use of belt clips, holsters and similar accessories should not contain metallic components in its assembly. The use of accessories that do not satisfy these requirements may not comply with FCC RF exposure requirements, and should be avoided. Body-worn Operation

This device was tested for typical body-worn operations. To comply with RF exposure requirements, a minimum separation distance of 10mm must be maintained between the user's body and the handset, including the antenna. Third-party belt-clips, holsters, and similar accessories used by this device should not contain any metallic components. Body-worn accessories that do not meet these requirements may not comply with RF exposure requirements and should be avoided. Use only the supplied or an approved antenna.



[www.oukitel.com](http://www.oukitel.com)



MADE IN CHINA