

TEST REPORT

Report No.: BCTC2307919155-5E

Applicant: SHENZHEN YUNJI INTELLIGENT TECHNOLOGY
CO.,LTD

Product Name: Smart Phone

Model/Type
reference: C35

Tested Date: 2023-07-18 to 2023-07-26

Issued Date: 2023-07-27

Shenzhen BCTC Testing Co., Ltd.



FCC ID: 2ANMU-C35SPUT

Product Name: Smart Phone
Trademark: OUKITEL
Model/Type reference: C35
C35 S, C35 Pro, C35 Ultra
Prepared For: SHENZHEN YUNJI INTELLIGENT TECHNOLOGY CO.,LTD
Address: A2 2F BUILDING ENET NEW INDUSTRIAL PARK, DAFU INDUSTRIAL ZONE,
GUANLAN, LONGHUA SHENZHEN, 518XXX China
Manufacturer: SHENZHEN YUNJI INTELLIGENT TECHNOLOGY CO.,LTD
Address: A2 2F BUILDING ENET NEW INDUSTRIAL PARK, DAFU INDUSTRIAL ZONE,
GUANLAN, LONGHUA SHENZHEN, 518XXX China
Prepared By: Shenzhen BCTC Testing Co., Ltd.
Address: 1-2/F., Building B, Pengzhou Industrial Park, No.158, Fuyuan 1st Road,
Zhancheng, Fuhai Subdistrict, Bao'an District, Shenzhen, Guangdong, China
Sample Received Date: 2023-07-18
Sample tested Date: 2023-07-18 to 2023-07-26
Issue Date: 2023-07-27
Report No.: BCTC2307919155-5E
Test Standards: FCC CFR Title 47 Part 2
FCC CFR Title 47 Part22 Subpart H
FCC CFR Title 47 Part24 Subpart E
FCC CFR Title 47 Part27 Subpart L
ANSI/ TIA/ EIA-603-D-2010
FCC KDB 971168 D01 Power Meas. License Digital Systems v02v02
Test Results: PASS
Remark: This is GSM & WCDMAradio test report.

Tested by:

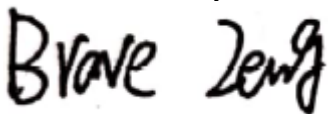

Brave Zeng/ Project Handler

Approved by:



Zero Zhou/Reviewer

The test report is effective only with both signature and specialized stamp. This result(s) shown in this report refer only to the sample(s) tested. Without written approval of Shenzhen BCTC Testing Co., Ltd, this report can't be reproduced except in full. The tested sample(s) and the sample information are provided by the client.

Table Of Content

	Page
Test Report Declaration	
1. Version	4
2. Test Summary	5
3. Measurement Uncertainty	6
4. Product Information And Test Setup	7
4.1 Product Information.....	7
4.2 Test Setup Configuration	8
4.3 Support Equipment	8
4.5 Test Mode.....	9
5. Test Facility And Test Instrument Used.....	10
5.1 Test Facility.....	10
5.2 Test Instrument Used.....	10
6. RF Output Power.....	11
6.1 Block Diagram Of Test Setup.....	11
6.2 Limit	12
6.3 Test procedure.....	13
6.4 Test Result.....	13
7. Peak-to-average Ratio(PAR) of Transmitter.....	21
7.1 Block Diagram Of Test Setup.....	21
7.2 Limit	21
7.3 Test procedure.....	21
7.4 Test Result.....	21
8. Emission Bandwidth	37
8.1 Block Diagram Of Test Setup.....	37
8.2 Limit	37
8.3 Test procedure.....	37
8.4 Test Result.....	37
9. Out of Band Emissions at Antenna Terminal.....	53
9.1 Block Diagram Of Test Setup.....	53
9.2 Limit	53
9.3 Test procedure.....	53
9.4 Test Result.....	53
10. Spurious Radiated Emissions.....	77
10.1 Block Diagram Of Test Setup.....	77
10.2 Limit	78
10.3 Test procedure.....	78
10.4 Test Result.....	79
11. Frequency Stability.....	82
11.1 Block Diagram Of Test Setup.....	82
11.2 Limit	82
11.3 Test procedure.....	82
11.4 Test Result.....	83
12. EUT Photographs.....	86
13. EUT Test Setup Photographs.....	87

(Note: N/A Means Not Applicable)

1. Version

Report No.	Issue Date	Description	Approved
BCTC2307919155-5E	2023-07-27	Original	Valid

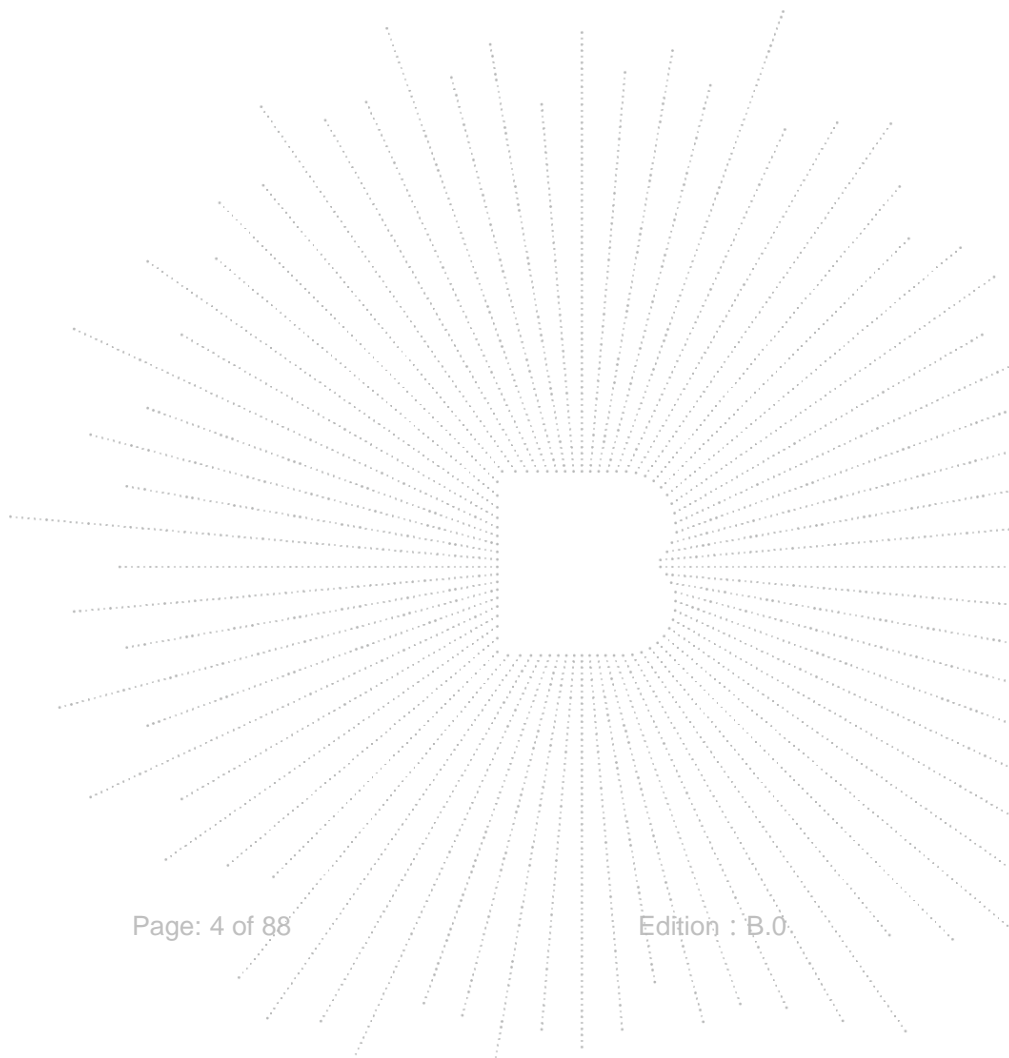

2. Test Summary

The Product has been tested according to the following specifications:

No.	Test Parameter	Clause No.	Results
1	RF Exposure	§1.1307, §2.1093	PASS
2	RF Output Power	§22.913 (a), §24.232 (c), §27.50 (d),	PASS
3	Peak-to-average Ratio(PAR) of Transmitter	§24.232(d), §22.913, §27.50(d),	PASS
4	Emission Bandwidth	§22.917 (b), §24.238(b), §27.53(g)	PASS
5	Spurious Emissions at Antenna Terminal	§22.917 (a), §24.238 (a), §27.53(g), §27.53(h)	PASS
6	Spurious Radiation Emissions	§22.917 (a), §24.238 (a), §27.53(g), §27.53(h)	PASS
7	Out of Band Emissions	§22.917 (a), §24.238 (a), §27.53(g), §27.53(h)	PASS
8	Frequency Stability	§22.355, §24.235, §27.54	PASS

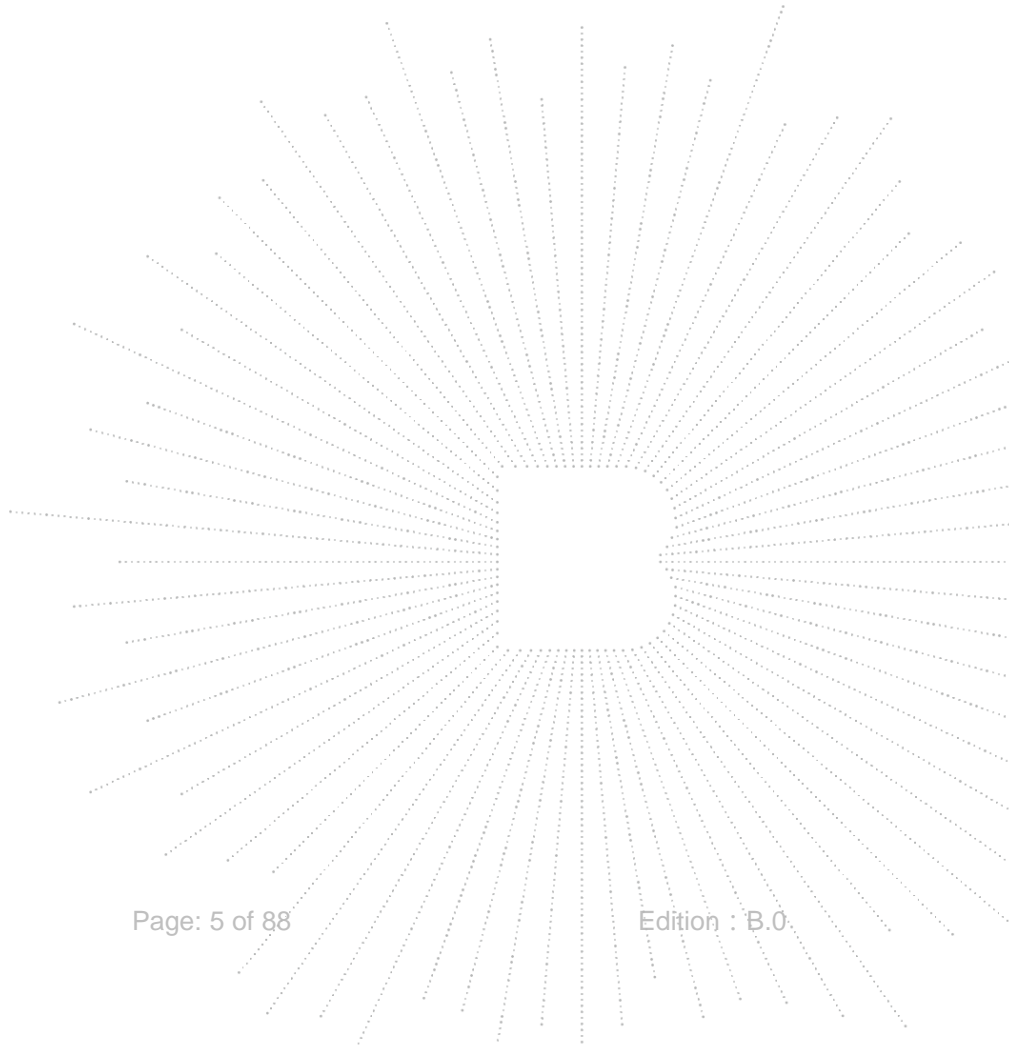

3. Measurement Uncertainty

Where relevant, the following measurement uncertainty levels have been estimated for tests performed on the Product as specified in CISPR 16-4-2. This uncertainty represents an expanded uncertainty expressed at approximately the 95% confidence level using a coverage factor of k=2.

No.	Item	Uncertainty
1	3m chamber Radiated spurious emission(30MHz-1GHz)	U=4.3dB
2	3m chamber Radiated spurious emission(9KHz-30MHz)	U=3.7dB
3	3m chamber Radiated spurious emission(1GHz-18GHz)	U=4.5dB
4	3m chamber Radiated spurious emission(18GHz-40GHz)	U=3.34dB
5	Conducted Emission (150kHz-30MHz)	U=3.20dB
6	Conducted Adjacent channel power	U=1.38dB
7	Conducted output power uncertainty Above 1G	U=1.576dB
8	Conducted output power uncertainty below 1G	U=1.28dB
9	humidity uncertainty	U=5.3%
10	Temperature uncertainty	U=0.59°C

4. Product Information And Test Setup

4.1 Product Information

Model/Type reference:	C35 C35 S, C35 Pro, C35 Ultra
Model differences:	Only the model names are different.
Hardware Version:	FS311-MB-V1.0
Software Version:	OUKITEL_C35_EEA_V02_19062023
Operation Frequency:	GSM/GPRS/EGPRS 850: TX: 824~849MHz; RX: 869~894MHz; GSM/GPRS/EGPRS 1900: TX:1850~1910MHz; RX:1930~1990MHz; WCDMA Band II: TX: 1852.40~1907.60MHz; Rx: 1932.60~1987.40MHz; WCDMA Band IV: TX: 1712.40~1752.60MHz; RX: 2112.60 – 2452.40MHz WCDMA Band V: TX: 826.40~846.60MHz; RX: 871.40~ 891.60MHz;
GPRS Class:	Class 12
Max RF Output Power:	GSM/GPRS/EGPRS 850: 32.74 dBm, GSM/GPRS/EGPRS 1900: 29.36 dBm WCDMA Band II: 22.53 dBm WCDMA Band IV: 22.62 dBm WCDMA Band V: 22.67 dBm
Type of Modulation:	GSM with GMSK Modulation WCDMA Mode with BPSK Modulation HSDPA Mode with QPSK, 16QAM Modulation HSUPA Mode with QPSK, 16QAM Modulation
Type of Emission:	GSM/GPRS 850: 257KGXW EGPRS 850:249KG7W GSM/GPRS 1900: 248KGXW EGPRS 1900:251KG7W WCDMA Band II: 4M17F9W WCDMA Band IV: 4M16F9W WCDMA Band V: 4M18F9W
Antenna installation:	Internal antenna
Antenna Gain:	GSM850: -0.21 dBi GSM1900: 0.13 dBi WCDMA Band II: 0.11 dBi WCDMA Band IV: 0.3 dBi WCDMA Band V: -0.20 dBi
Connecting I/O Port(s)	Please refer to the User's Manual
Ratings:	DC 5V from adapter/DC 3.87V from battery
Adapter Information:	Model: HJ-0502000N2-US Input: 100-240V~50/60Hz 0.3A Output: 5.0V  2.0A

4.2 Test Setup Configuration

See test photographs attached in *EUT TEST SETUP PHOTOGRAPHS* for the actual connections between Product and support equipment.

Conducted Emission:

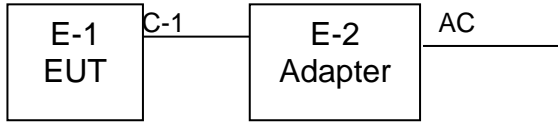

Radiated Spurious Emission

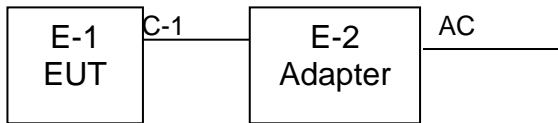

4.3 Support Equipment

No.	Device Type	Brand	Model	Series No.	Note
E-1	Smart Phone	OUKITEL	C35	N/A	EUT
E-2	Adapter	N/A	HJ-0502000N2-US	N/A	Auxiliary

Item	Shielded Type	Ferrite Core	Length	Note
C-1	N/A	N/A	1M	DC cable unshielded

Notes:

- All the equipment/cables were placed in the worst-case configuration to maximize the emission during the test.
- Grounding was established in accordance with the manufacturer's requirements and conditions for the intended use.

4.5 Test Mode

Testing Configure			
Support Band	Support Standard	Channel Frequency	Channel Number
GSM 850	GSM/GPRS/EGPRS	824.2 MHz	128
		836.6 MHz	190
		848.8 MHz	251
PCS 1900	GSM/GPRS/EGPRS	1850.2 MHz	512
		1880.0 MHz	661
		1909.8 MHz	810
WCDMA Band II	WCDMA/HSDPA/HSUPA	1852.4 MHz	9262
		1880.0 MHz	9400
		1907.6 MHz	9538
WCDMA Band IV	WCDMA/HSDPA/HSUPA	1712.4 MHz	1312
		1740 MHz	1450
		1752.6 MHz	1513
WCDMA Band V	WCDMA/HSDPA/HSUPA	826.4 MHz	4132
		836.4 MHz	4182
		846.6 MHz	4233

Note 1: the transmitter has been tested on the communications mode of WCDMA, HSDPA, HSUPA compliance test and record the worst case.
 Note 2: Both the SIM 1 and SIM 2 were tested, the worst mode is the SIM 1, the data recording in the report.

EUT Cable List and Details

Cable Description	Length (M)	Shielded/Unshielded	With Core/Without Core
/	/	/	/
/	/	/	/

Auxiliary Equipment List and Details

Description	Manufacturer	Model	Serial Number
/	/	/	/

Special Cable List and Details

Cable Description	Length (M)	Shielded/Unshielded	With Core/Without Core
/	/	/	/

5. Test Facility And Test Instrument Used

5.1 Test Facility

All measurement facilities used to collect the measurement data are located at Shenzhen BCTC Testing Co., Ltd. Address:1-2/F., Building B, Pengzhou Industrial Park, No.158, Fuyuan 1st Road, Zhancheng, Fuhai Subdistrict, Bao'an District, Shenzhen, Guangdong, China. The site and apparatus are constructed in conformance with the requirements of ANSI C63.4 and CISPR 16-1-1 other equivalent standards.

FCC Test Firm Registration Number: 712850

A2LA certificate registration number is: CN1212

ISED Registered No.: 23583

ISED CAB identifier: CN0017

5.2 Test Instrument Used

Radiated Emissions Test (966 Chamber01)					
Equipment	Manufacturer	Model#	Serial#	Last Cal.	Next Cal.
966 chamber	ChengYu	966 Room	966	May 15, 2023	May 14, 2026
Receiver	R&S	ESR3	102075	May 15, 2023	May 14, 2024
Receiver	R&S	ESRP	101154	May 15, 2023	May 14, 2024
Amplifier	Schwarzbeck	BBV9744	9744-0037	May 15, 2023	May 14, 2024
TRILOG Broadband Antenna	Schwarzbeck	VULB9163	942	May 29, 2023	May 28, 2024
Loop Antenna(9KHz -30MHz)	Schwarzbeck	FMZB1519B	00014	May 31, 2023	May 30, 2024
Amplifier	SKET	LAPA_01G18 G-45dB	\	May 15, 2023	May 14, 2024
Horn Antenna	Schwarzbeck	BBHA9120D	1541	May 31, 2023	May 30, 2024
Amplifier(18G Hz-40GHz)	MITEQ	TTA1840-35-HG	2034381	May 15, 2023	May 14, 2024
Horn Antenn(18GHz -40GHz)	Schwarzbeck	BBHA9170	00822	May 31, 2023	May 30, 2024
Spectrum Analyzer9kHz-40GHz	R&S	FSP40	100363	May 15, 2023	May 14, 2024
Communication test set	R&S	CMW500	126173	Nov. 08, 2022	Nov. 07, 2023
Software	Frad	EZ-EMC	FA-03A2 RE	\	\

6. RF Output Power

6.1 Block Diagram Of Test Setup

Conducted output power test method:

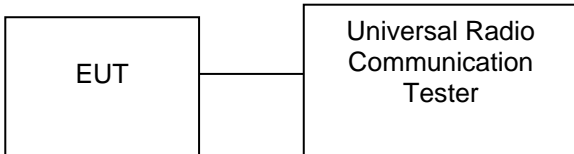

Radiated power test method:

(A) Radiated Emission Test-Up Frequency Below 30MHz

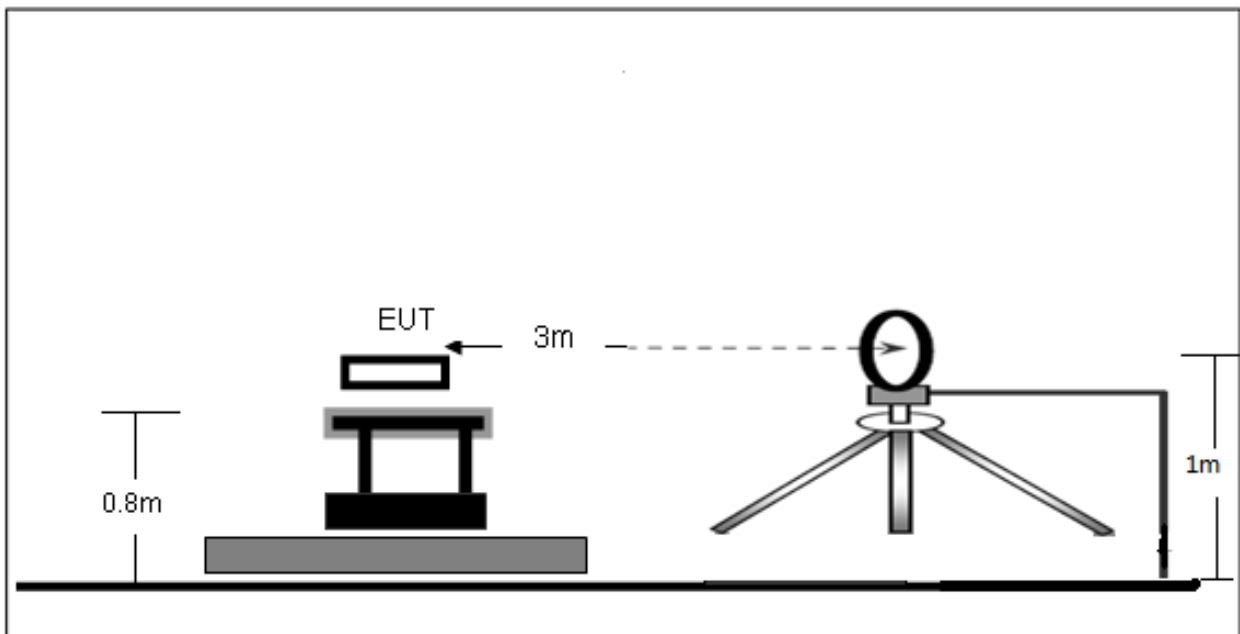

(B) Radiated Emission Test-Up Frequency 30MHz~1GHz

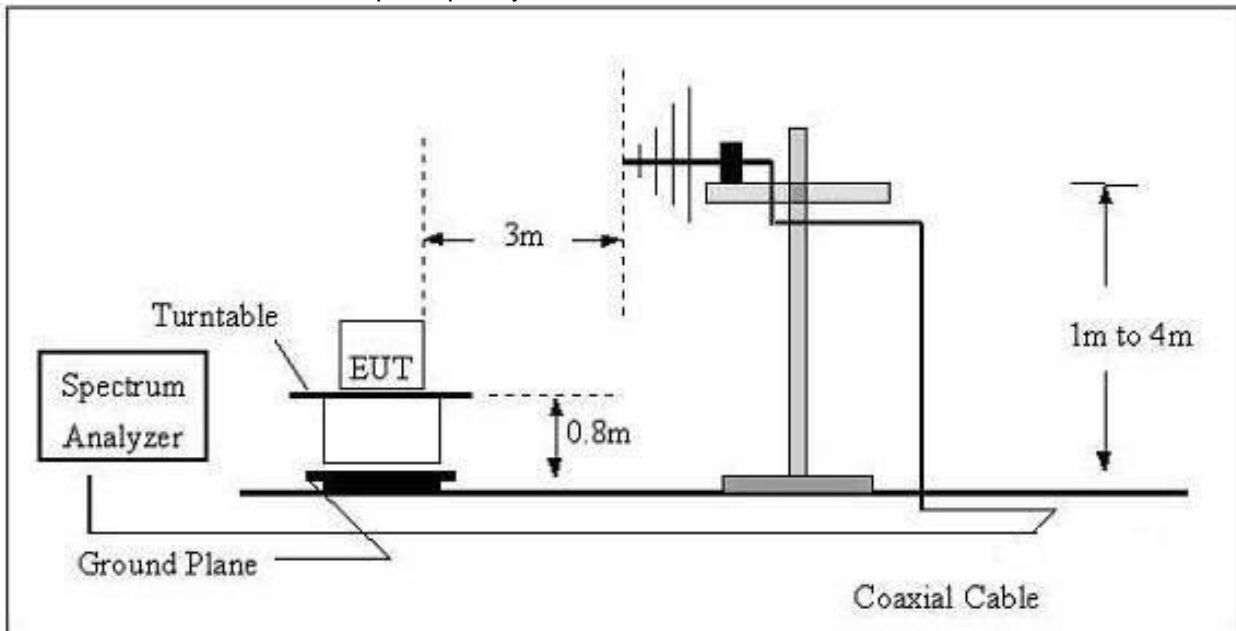

(C) Radiated Emission Test-Up Frequency Above 1GHz

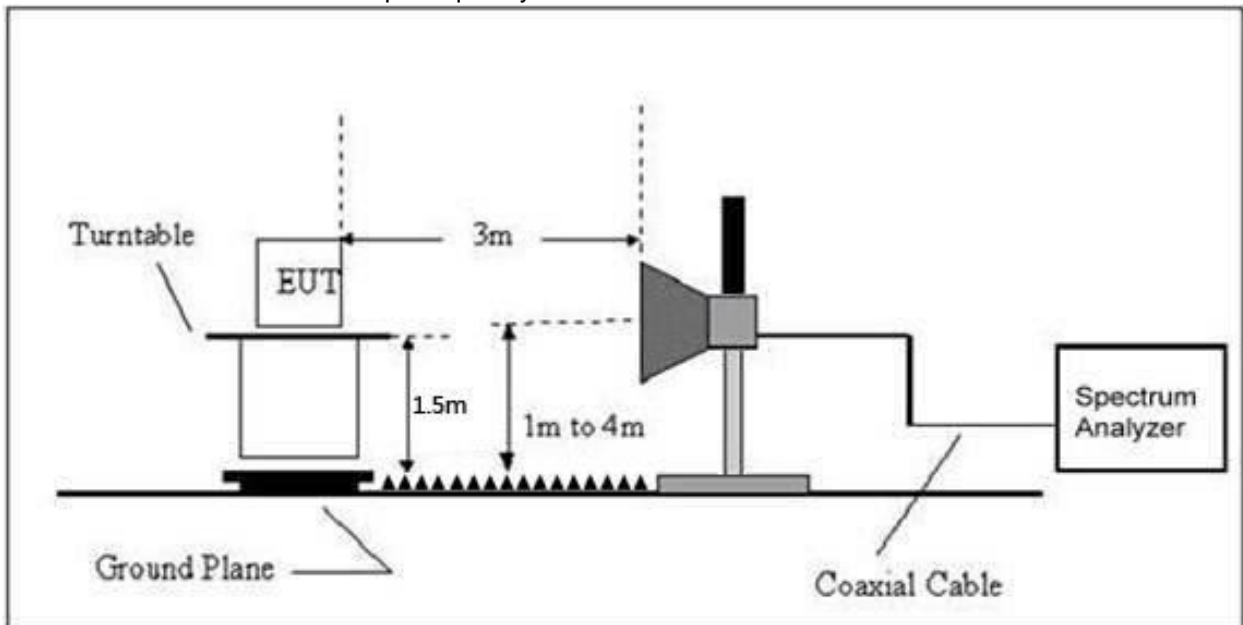

6.2 Limit

According to §22.913(a)(2), The ERP of mobile and portable stations transmitters and auxiliary test transmitters must not exceed 7 Watts.

According to §24.232 (c), Mobile and portable stations are limited to 2 watts EIRP and the equipment must employ a means for limiting power to the minimum necessary for successful communications.

According to §27.50(d)(4), Fixed, mobile, and portable (hand-held) stations operating in the 1710-1755 MHz band and mobile and portable stations operating in the 1695-1710 MHz and 1755-1780 MHz bands are limited to 1 watt EIRP.

6.3 Test procedure

Radiated power test method:

1. The setup of EUT is according with per ANSI/TIA Standard 603D and ANSI C63.4-2014 measurement procedure.
2. The measurement antenna was placed at a distance of 3 meters from the EUT. During the tests, the antenna height and polarization as well as EUT azimuth were varied in order to identify the maximum level of emissions from the EUT. The test was performed by placing the EUT on 3-orthogonal axis.
3. The frequency range up to tenth harmonic of the fundamental frequency was investigated.
4. Remove the EUT and replace it with substitution antenna. A signal generator was connected to the substitution antenna by a non-radiating cable. The absolute levels of the spurious emissions were measured by the substitution.

6.4 Test Result

ERP For GSM Mode GSM850

Frequency (MHz)	Polar (H/V)	Height (Meter)	Table (Degree)	Reading Level (dBm)	Correct Factor (dB)	Measurement (dBm)	FCC Part 22H Limits (dBm)	Result
Low Channel								
824.2	H	1.5	0	27.09	-7.98	19.11	38.45	PASS
824.2	V	1.5	0	27.24	-7.98	19.26	38.45	PASS
Middle Channel								
836.6	H	1.5	0	27.31	-7.56	19.75	38.45	PASS
836.6	V	1.5	0	26.90	-7.56	19.34	38.45	PASS
High Channel								
848.8	H	1.5	0	28.30	-7.14	21.16	38.45	PASS
848.8	V	1.5	0	27.21	-7.14	20.07	38.45	PASS

EIRP For GSM Mode PCS1900

Frequency (MHz)	Polar (H/V)	Height (Meter)	Table (Degree)	Reading Level (dBm)	Correct Factor (dB)	Measurement (dBm)	FCC Part 24E Limits (dBm)	Result
Low Channel								
1850.2	H	1.5	0	50.63	-21.78	28.85	33.00	PASS
1850.2	V	1.5	0	49.38	-21.78	27.60	33.00	PASS
Middle Channel								
1880	H	1.5	0	49.41	-21.67	27.74	33.00	PASS
1880	V	1.5	0	49.51	-21.67	27.84	33.00	PASS
High Channel								
1909.8	H	1.5	0	49.25	-21.55	27.70	33.00	PASS
1909.8	V	1.5	0	48.81	-21.55	27.26	33.00	PASS

ERP For GPRS Mode GSM850

Frequency (MHz)	Polar (H/V)	Height (Meter)	Table (Degree)	Reading Level (dBm)	Correct Factor (dB)	Measurement (dBm)	FCC Part 22H Limits (dBm)	Result
Low Channel								
824.2	H	1.5	0	27.42	-7.98	19.44	38.45	PASS
824.2	V	1.5	0	27.79	-7.98	19.81	38.45	PASS
Middle Channel								
836.6	H	1.5	0	27.62	-7.56	20.06	38.45	PASS
836.6	V	1.5	0	26.97	-7.56	19.41	38.45	PASS
High Channel								
848.8	H	1.5	0	27.93	-7.14	20.79	38.45	PASS
848.8	V	1.5	0	27.75	-7.14	20.61	38.45	PASS

EIRP For GPRS Mode PCS1900

Frequency (MHz)	Polar (H/V)	Height (Meter)	Table (Degree)	Reading Level (dBm)	Correct Factor (dB)	Measurement (dBm)	FCC Part 24E Limits (dBm)	Result
Low Channel								
1850.2	H	1.5	0	48.90	-21.78	27.12	33.00	PASS
1850.2	V	1.5	0	49.64	-21.78	27.86	33.00	PASS
Middle Channel								
1880	H	1.5	0	50.71	-21.67	29.04	33.00	PASS
1880	V	1.5	0	49.32	-21.67	27.65	33.00	PASS
High Channel								
1909.8	H	1.5	0	49.66	-21.55	28.11	33.00	PASS
1909.8	V	1.5	0	49.10	-21.55	27.55	33.00	PASS

ERP For EGPRS Mode GSM850

Frequency (MHz)	Polar (H/V)	Height (Meter)	Table (Degree)	Reading Level (dBm)	Correct Factor (dB)	Measurement (dBm)	FCC Part 22H Limits (dBm)	Result
Low Channel								
824.2	H	1.5	0	27.37	-7.98	19.39	38.45	PASS
824.2	V	1.5	0	27.08	-7.98	19.10	38.45	PASS
Middle Channel								
836.6	H	1.5	0	27.65	-7.56	20.09	38.45	PASS
836.6	V	1.5	0	27.59	-7.56	20.03	38.45	PASS
High Channel								
848.8	H	1.5	0	27.48	-7.14	20.34	38.45	PASS
848.8	V	1.5	0	26.86	-7.14	19.72	38.45	PASS

EIRP For EGPRS Mode PCS1900

Frequency (MHz)	Polar (H/V)	Height (Meter)	Table (Degree)	Reading Level (dBm)	Correct Factor (dB)	Measurement (dBm)	FCC Part 24E Limits (dBm)	Result
Low Channel								
1850.2	H	1.5	0	49.76	-21.78	27.98	33.00	PASS
1850.2	V	1.5	0	49.59	-21.78	27.81	33.00	PASS
Middle Channel								
1880	H	1.5	0	49.10	-21.67	27.43	33.00	PASS
1880	V	1.5	0	49.27	-21.67	27.60	33.00	PASS
High Channel								
1909.8	H	1.5	0	50.15	-21.55	28.60	33.00	PASS
1909.8	V	1.5	0	48.97	-21.55	27.42	33.00	PASS

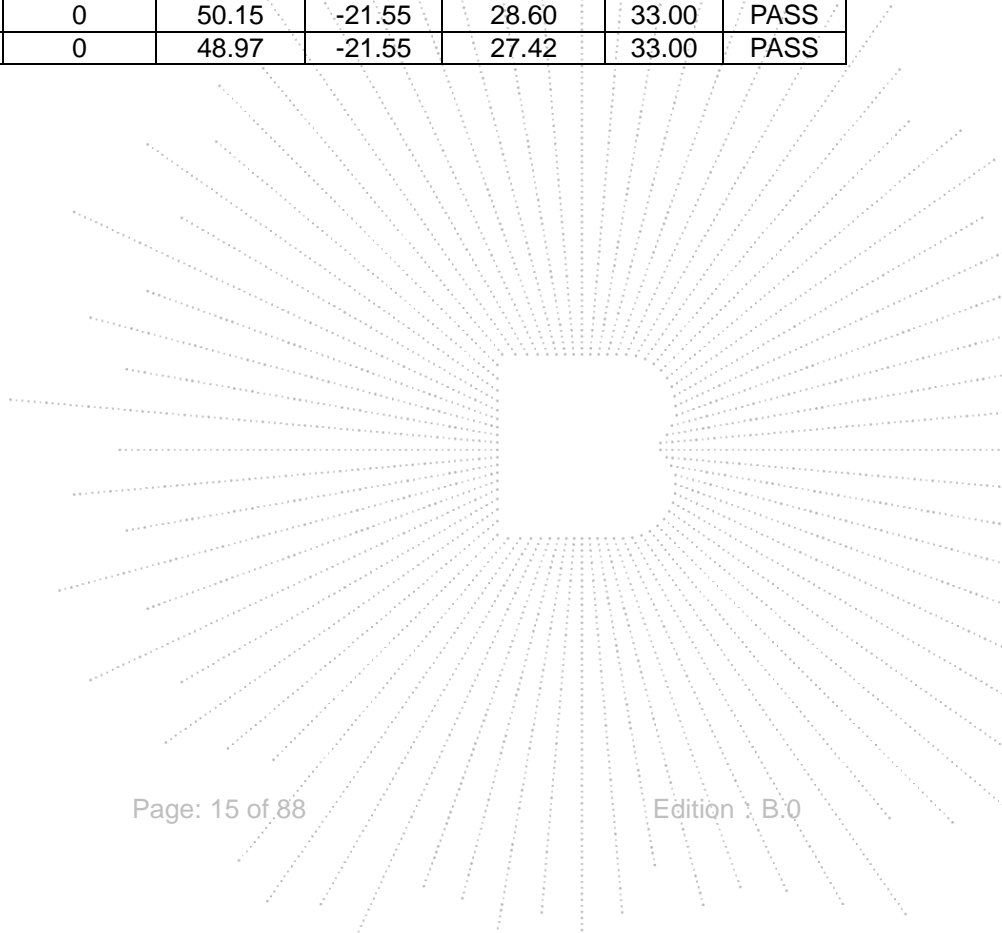

EIRP For WCDMA Mode Band II

Frequency (MHz)	Polar (H/V)	Height (Meter)	Table (Degree)	Reading Level (dBm)	Correct Factor (dB)	Measurement (dBm)	FCC Part 24E Limits (dBm)	Result
Low Channel								
1852.4	H	1.5	0	41.27	-21.77	19.50	33.00	PASS
1852.4	V	1.5	0	40.29	-21.77	18.52	33.00	PASS
Middle Channel								
1880	H	1.5	0	40.85	-21.67	19.18	33.00	PASS
1880	V	1.5	0	39.85	-21.67	18.18	33.00	PASS
High Channel								
1907.6	H	1.5	0	40.00	-21.56	18.44	33.00	PASS
1907.6	V	1.5	0	39.96	-21.56	18.40	33.00	PASS

EIRP For HSDPA Mode Band II

Frequency (MHz)	Polar (H/V)	Height (Meter)	Table (Degree)	Reading Level (dBm)	Correct Factor (dB)	Measurement (dBm)	FCC Part 24E Limits (dBm)	Result
Low Channel								
1852.4	H	1.5	0	41.06	-21.77	19.29	33.00	PASS
1852.4	V	1.5	0	40.08	-21.77	18.31	33.00	PASS
Middle Channel								
1880	H	1.5	0	40.61	-21.67	18.94	33.00	PASS
1880	V	1.5	0	39.96	-21.67	18.29	33.00	PASS
High Channel								
1907.6	H	1.5	0	39.45	-21.56	17.89	33.00	PASS
1907.6	V	1.5	0	39.78	-21.56	18.22	33.00	PASS

EIRP For HSUPA Mode Band II

Frequency (MHz)	Polar (H/V)	Height (Meter)	Table (Degree)	Reading Level (dBm)	Correct Factor (dB)	Measurement (dBm)	FCC Part 24E Limits (dBm)	Result
Low Channel								
1852.4	H	1.5	0	39.64	-21.77	17.87	33.00	PASS
1852.4	V	1.5	0	39.89	-21.77	18.12	33.00	PASS
Middle Channel								
1880	H	1.5	0	40.41	-21.67	18.74	33.00	PASS
1880	V	1.5	0	40.21	-21.67	18.54	33.00	PASS
High Channel								
1907.6	H	1.5	0	39.72	-21.56	18.16	33.00	PASS
1907.6	V	1.5	0	40.36	-21.56	18.80	33.00	PASS

EIRP For WCDMA Mode Band IV

Frequency (MHz)	Polar (H/V)	Height (Meter)	Table (Degree)	Reading Level (dBm)	Correct Factor (dB)	Measurement (dBm)	FCC Part 27L Limits (dBm)	Result
Low Channel								
1712.4	H	1.5	0	40.17	-22.32	17.85	33.00	PASS
1712.4	V	1.5	0	40.19	-22.32	17.87	33.00	PASS
Middle Channel								
1740	H	1.5	0	40.66	-22.24	18.42	33.00	PASS
1740	V	1.5	0	39.97	-22.24	17.73	33.00	PASS
High Channel								
1752.6	H	1.5	0	41.32	-22.16	19.16	33.00	PASS
1752.6	V	1.5	0	39.79	-22.16	17.63	33.00	PASS

EIRP For HSDPA Mode Band IV

Frequency (MHz)	Polar (H/V)	Height (Meter)	Table (Degree)	Reading Level (dBm)	Correct Factor (dB)	Measurement (dBm)	FCC Part 27L Limits (dBm)	Result
Low Channel								
1712.4	H	1.5	0	40.09	-22.32	17.77	33.00	PASS
1712.4	V	1.5	0	40.13	-22.32	17.81	33.00	PASS
Middle Channel								
1740	H	1.5	0	39.61	-22.24	17.37	33.00	PASS
1740	V	1.5	0	39.92	-22.24	17.68	33.00	PASS
High Channel								
1752.6	H	1.5	0	40.12	-22.16	17.96	33.00	PASS
1752.6	V	1.5	0	39.82	-22.16	17.66	33.00	PASS

EIRP For HSUPA Mode Band IV

Frequency (MHz)	Polar (H/V)	Height (Meter)	Table (Degree)	Reading Level (dBm)	Correct Factor (dB)	Measurement (dBm)	FCC Part 27L Limits (dBm)	Result
Low Channel								
1712.4	H	1.5	0	39.66	-22.32	17.34	33.00	PASS
1712.4	V	1.5	0	40.01	-22.32	17.69	33.00	PASS
Middle Channel								
1740	H	1.5	0	40.33	-22.24	18.09	33.00	PASS
1740	V	1.5	0	40.18	-22.24	17.94	33.00	PASS
High Channel								
1752.6	H	1.5	0	40.72	-22.16	18.56	33.00	PASS
1752.6	V	1.5	0	39.97	-22.16	17.81	33.00	PASS

ERP For WCDMA Mode Band V

Frequency (MHz)	Polar (H/V)	Height (Meter)	Table (Degree)	Reading Level (dBm)	Correct Factor (dB)	Measurement (dBm)	FCC Part 22H Limits (dBm)	Result
Low Channel								
826.4	H	1.5	0	17.47	-7.90	9.57	30	PASS
826.4	V	1.5	0	17.80	-7.90	9.90	30	PASS
Middle Channel								
836.4	H	1.5	0	19.16	-7.56	11.60	30	PASS
836.4	V	1.5	0	18.09	-7.56	10.53	30	PASS
High Channel								
846.6	H	1.5	0	19.03	-7.22	11.81	30	PASS
846.6	V	1.5	0	17.60	-7.22	10.38	30	PASS

ERP For HSDPA Mode Band V

Frequency (MHz)	Polar (H/V)	Height (Meter)	Table (Degree)	Reading Level (dBm)	Correct Factor (dB)	Measurement (dBm)	FCC Part 22H Limits (dBm)	Result
Low Channel								
826.4	H	1.5	0	18.65	-7.90	10.75	30	PASS
826.4	V	1.5	0	17.92	-7.90	10.02	30	PASS
Middle Channel								
836.4	H	1.5	0	18.02	-7.56	10.46	30	PASS
836.4	V	1.5	0	17.94	-7.56	10.38	30	PASS
High Channel								
846.6	H	1.5	0	19.17	-7.22	11.95	30	PASS
846.6	V	1.5	0	17.47	-7.22	10.25	30	PASS

ERP For HSUPA Mode Band V

Frequency (MHz)	Polar (H/V)	Height (Meter)	Table (Degree)	Reading Level (dBm)	Correct Factor (dB)	Measurement (dBm)	FCC Part 22H Limits (dBm)	Result
Low Channel								
826.4	H	1.5	0	18.71	-7.90	10.81	30	PASS
826.4	V	1.5	0	17.48	-7.90	9.58	30	PASS
Middle Channel								
836.4	H	1.5	0	18.29	-7.56	10.73	30	PASS
836.4	V	1.5	0	17.50	-7.56	9.94	30	PASS
High Channel								
846.6	H	1.5	0	18.04	-7.22	10.82	30	PASS
846.6	V	1.5	0	18.17	-7.22	10.95	30	PASS

Correction Factor= S.G. Power - Cable loss + Antenna Gain- SPA. Reading

Max. Conducted Output Power

For Cellular Band (GSM850)

Band	GSM850			Limit (dBm)
Channel	128	190	251	
Frequency(MHz)	824.2	836.6	848.8	
GSM	32.69	32.58	32.60	33.0
GPRS Slot -1	32.74	32.67	32.66	33.0
GPRS Slot -2	30.41	30.27	30.21	33.0
GPRS Slot -3	28.24	28.1	28.06	33.0
GPRS Slot -4	26	25.88	25.86	33.0
EGPRS Slot -1	32.68	32.61	32.63	33.0
EGPRS Slot -2	30.38	30.25	30.16	33.0
EGPRS Slot -3	28.18	28.02	27.97	33.0
EGPRS Slot -4	25.94	25.82	25.86	33.0

For PCS Band (GSM1900)

Band	GSM1900			Limit (dBm)
Channel	512	661	810	
Frequency(MHz)	1850.2	1880	1909.8	
GSM	29.30	29.36	29.27	33.0
GPRS Slot -1	29.27	29.34	29.24	33.0
GPRS Slot -2	27.07	27	26.79	33.0
GPRS Slot -3	24.97	24.89	24.63	33.0
GPRS Slot -4	22.83	22.71	22.46	33.0
EGPRS Slot -1	24.83	24.95	24.88	33.0
EGPRS Slot -2	22.89	22.72	23.26	33.0
EGPRS Slot -3	20.74	20.83	21.22	33.0
EGPRS Slot -4	18.79	18.88	18.95	33.0

Band	WCDMA Band II		
Channel	9262	9400	9538
Frequency(MHz)	1852.4	1880.0	1907.6
WCDMA RMC 12.2K	22.28	22.53	22.47
HSDPA Subtest-1	22.19	22.06	21.88
HSDPA Subtest-2	21.72	21.80	21.70
HSDPA Subtest-3	21.26	21.40	21.02
HSDPA Subtest-4	21.42	21.10	20.86
HSUPA Subtest-1	21.86	21.72	21.66
HSUPA Subtest-2	21.97	22.00	21.77
HSUPA Subtest-3	21.61	21.59	21.35
HSUPA Subtest-4	22.07	21.96	21.80
HSUPA Subtest-5	21.95	21.59	21.58

Band	WCDMA Band IV		
Channel	1312	1450	1513
Frequency(MHz)	1712.4	1740	1752.6
WCDMA RMC 12.2K	22.60	22.53	22.62
HSDPA Subtest-1	22.22	22.59	22.44
HSDPA Subtest-2	21.86	22.16	22.06
HSDPA Subtest-3	21.63	21.95	21.77
HSDPA Subtest-4	21.15	21.74	21.68
HSUPA Subtest-1	21.97	22.24	22.19
HSUPA Subtest-2	22.04	22.44	22.26
HSUPA Subtest-3	21.63	22.15	22.06
HSUPA Subtest-4	22.11	22.49	22.28
HSUPA Subtest-5	21.40	22.42	22.08

Band	WCDMA Band V		
Channel	4132	4182	4233
Frequency(MHz)	826.4	836.4	846.6
WCDMA RMC 12.2K	22.41	22.56	22.62
HSDPA Subtest-1	22.67	22.44	22.14
HSDPA Subtest-2	22.28	22.21	21.86
HSDPA Subtest-3	21.95	21.95	21.76
HSDPA Subtest-4	21.92	21.92	21.71
HSUPA Subtest-1	22.60	22.44	22.16
HSUPA Subtest-2	22.60	22.42	22.24
HSUPA Subtest-3	22.14	22.11	21.87
HSUPA Subtest-4	22.57	22.52	22.21
HSUPA Subtest-5	22.29	22.11	22.01

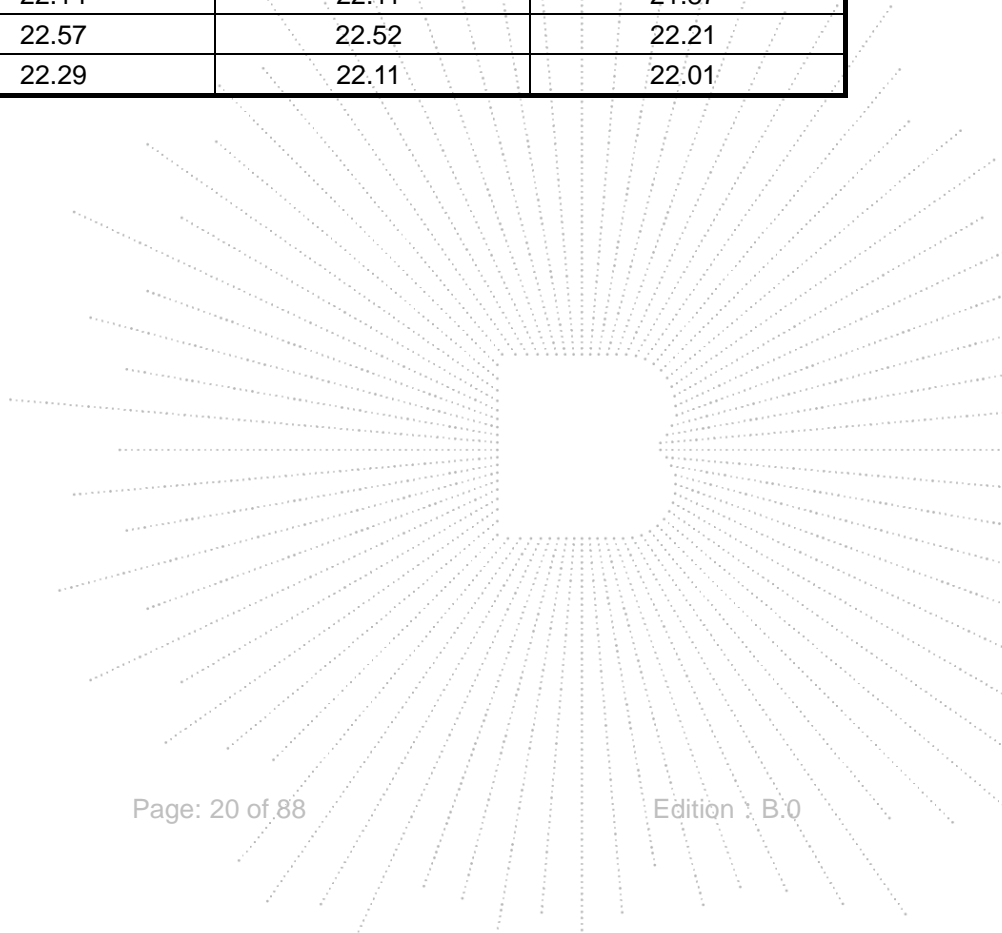

7. Peak-to-average Ratio(PAR) of Transmitter

7.1 Block Diagram Of Test Setup

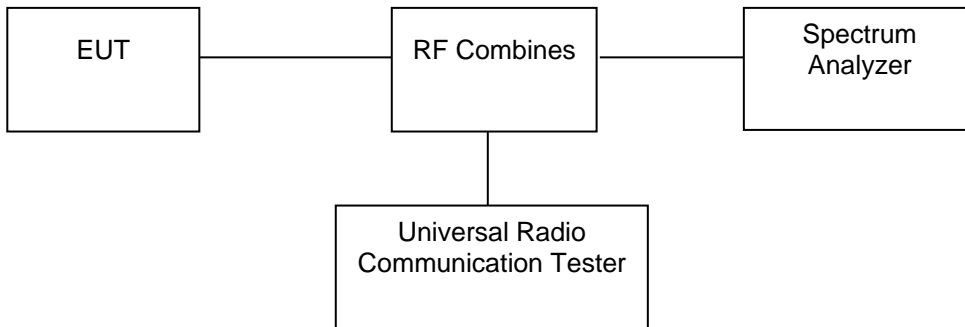

7.2 Limit

According to §24.232(d), Power measurements for transmissions by stations authorized under this section may be made either in accordance with a Commission-approved average power technique or in compliance with paragraph (e) of this section. In both instances, equipment employed must be authorized in accordance with the provisions of §24.51. In measuring transmissions in this band using an average power technique, the peak-to-average ratio (PAR) of the transmission may not exceed 13 dB.

According to §27.50(B), the peak-to-average power ratio (PAPR) of the transmitter output power must not exceed 13 dB. The PAPR measurements should be made using either an instrument with complementary cumulative distribution function (CCDF) capabilities to determine that PAPR will not exceed 13 dB for more than 0.1 percent of the time or other Commission approved procedure. The measurement must be performed using a signal corresponding to the highest PAPR expected during periods of continuous transmission.

7.3 Test procedure

The RF output terminal of the transmitter was connected to the input of the spectrum analyzer via a suitable attenuation. The RBW of the spectrum analyzer was set to 30kHz and the peak-to-average ratio (PAR) of the transmission was recorded. Record the maximum PAPR level associated with a probability of 0.1%.

7.4 Test Result

Band	Channel	Frequency (MHz)	Result (dB)	high Limit (dB)	Verdict
GSM850	128	824.2	2.65	13.00	PASS
GSM850	190	836.6	2.64	13.00	PASS
GSM850	251	848.8	2.63	13.00	PASS
GPRS850	128	824.2	2.69	13.00	PASS
GPRS850	190	836.6	2.67	13.00	PASS
GPRS850	251	848.8	2.67	13.00	PASS
EGPRS850	128	824.2	2.69	13.00	PASS
EGPRS850	190	836.6	2.68	13.00	PASS
EGPRS850	251	848.8	2.67	13.00	PASS

GSM850 Channel=128

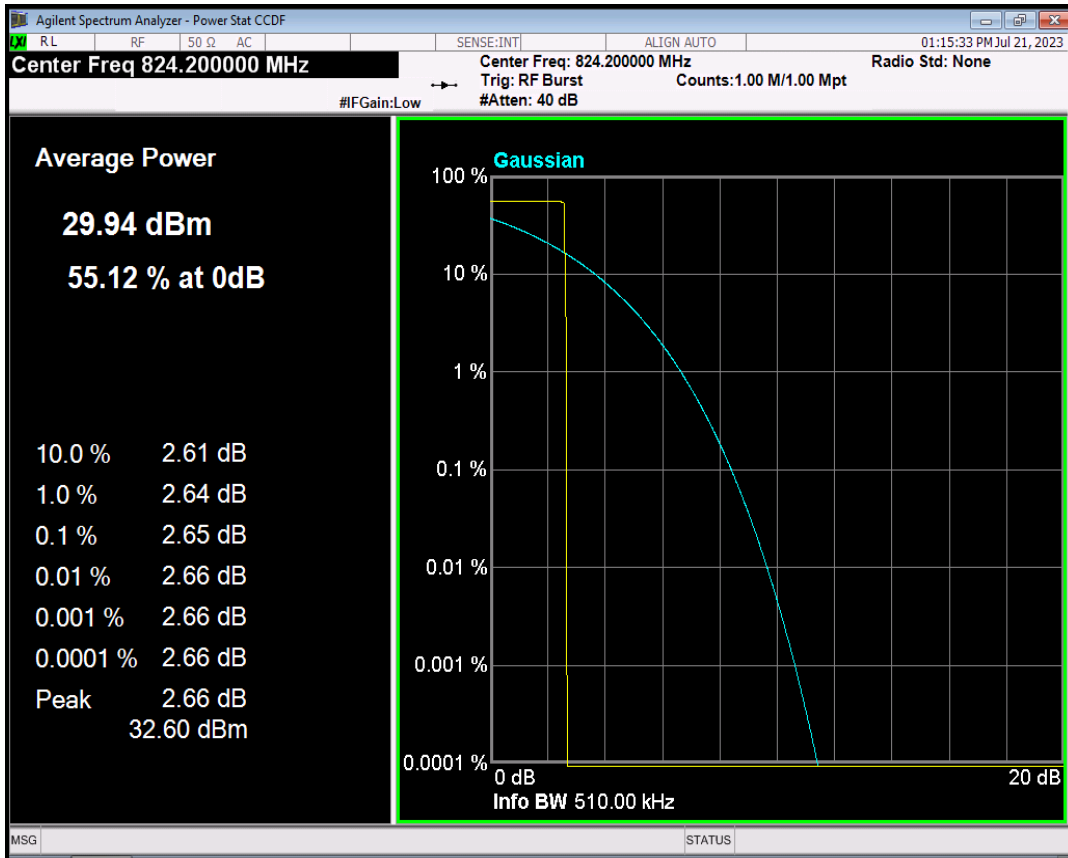

GSM850 Channel=190

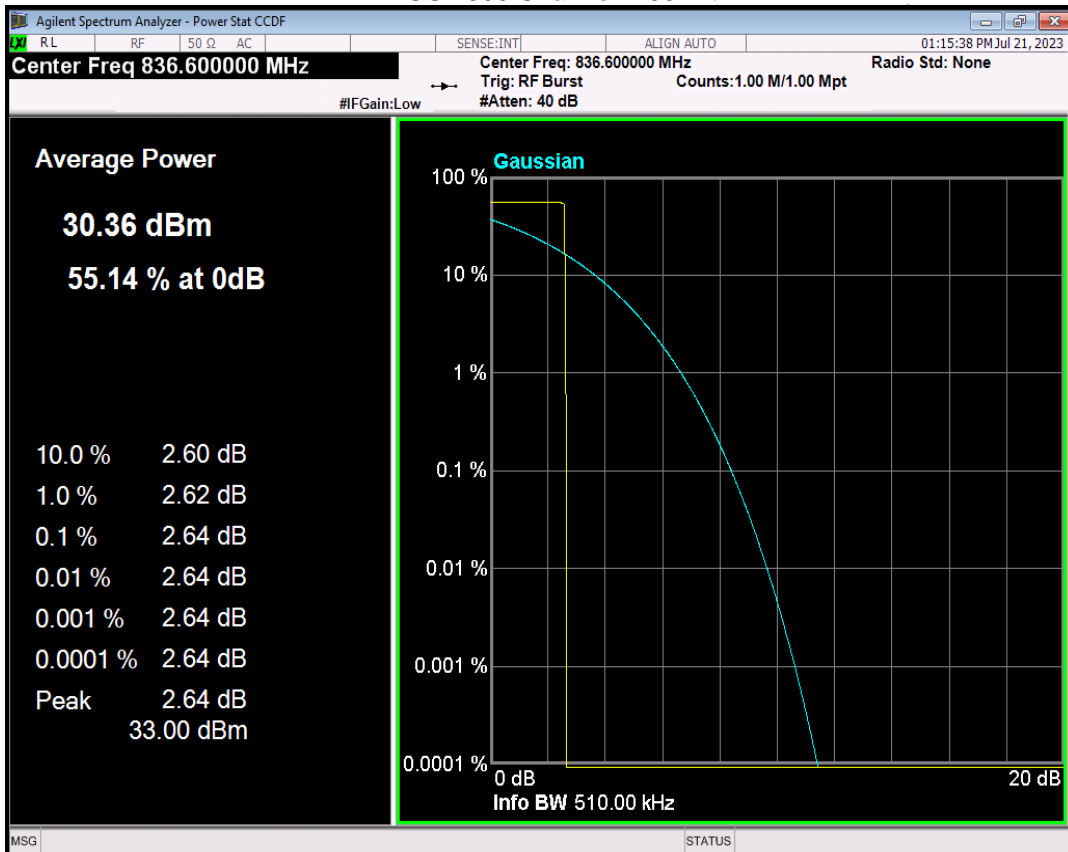

GSM850 Channel=251

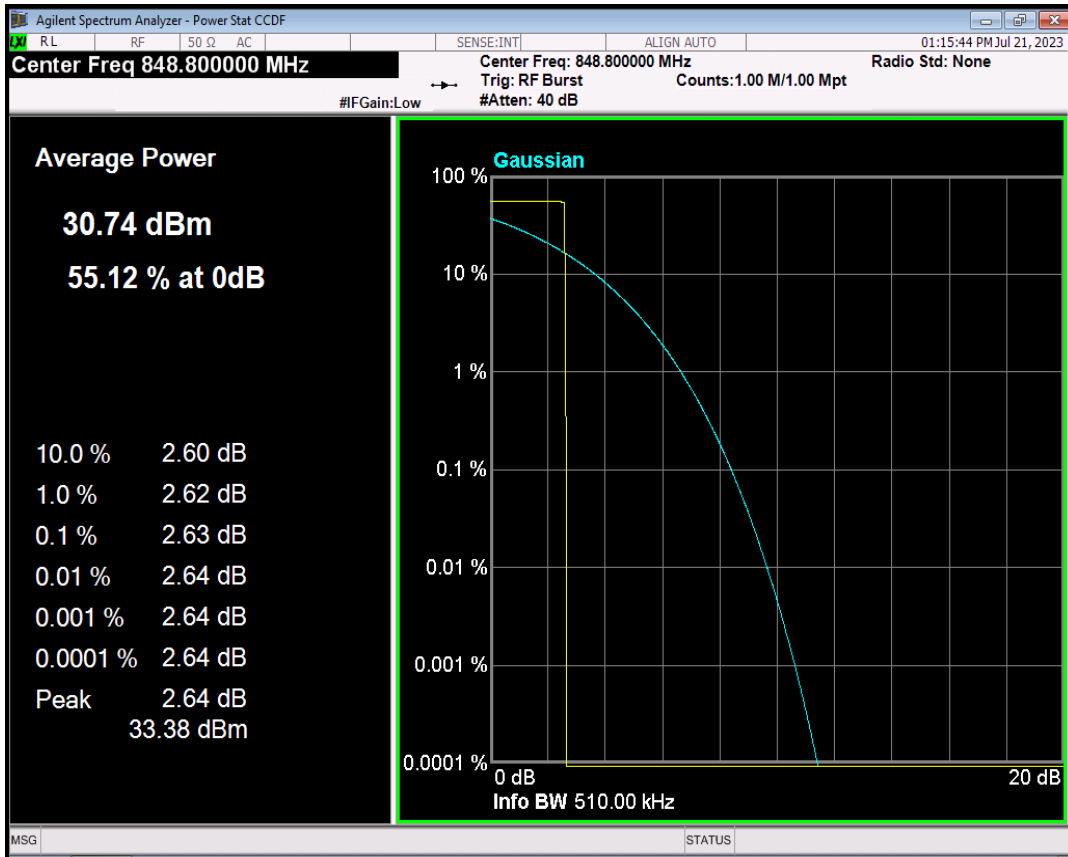

GPRS850 Channel=128

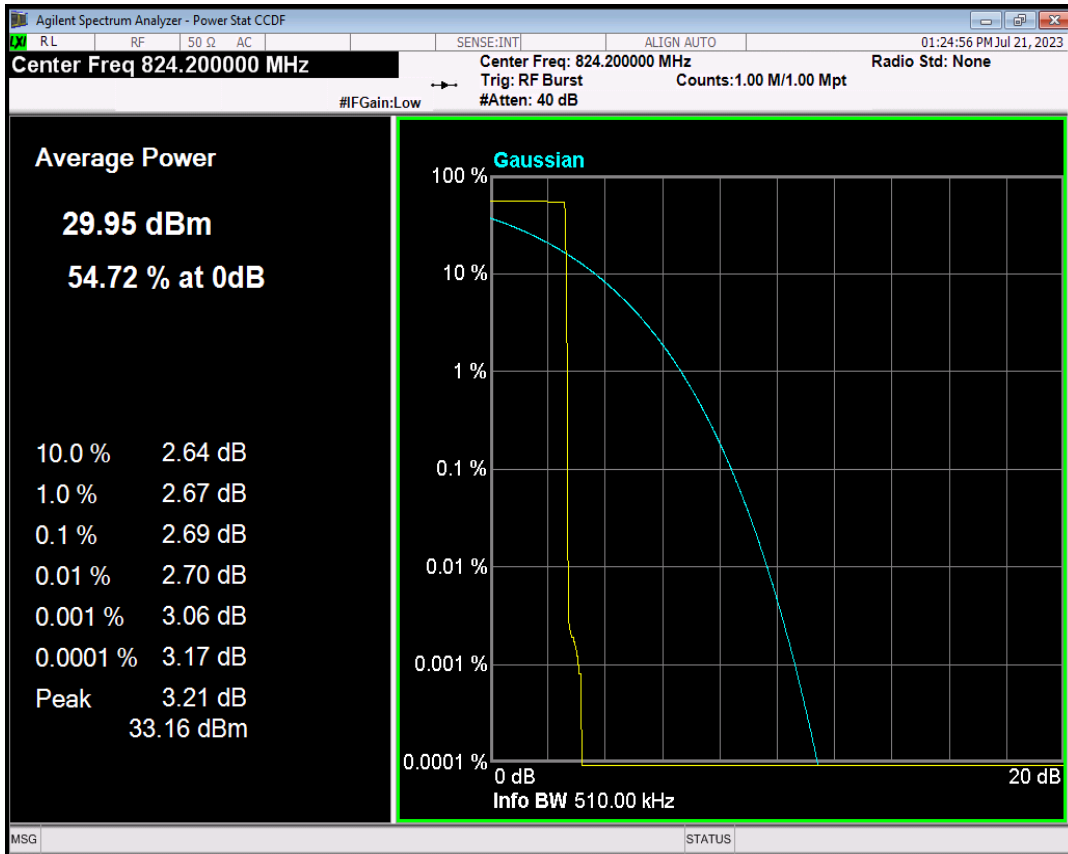

GPRS850 Channel=190

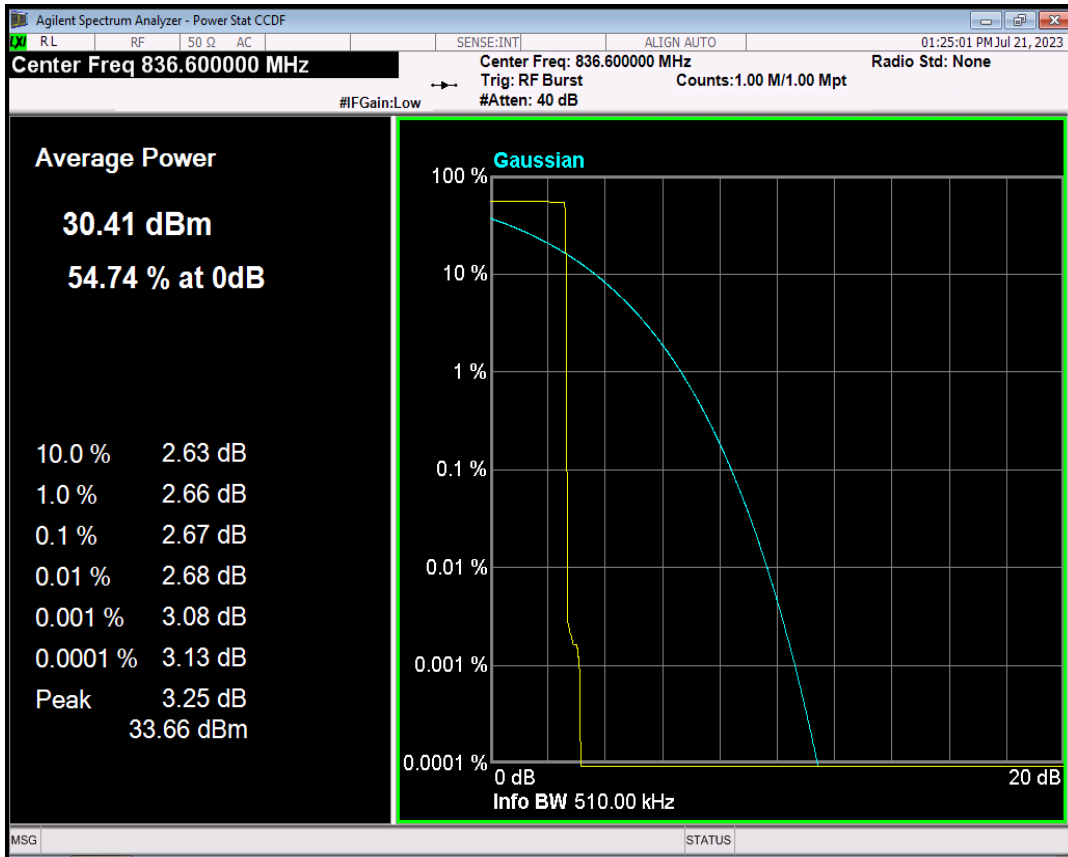

GPRS850 Channel=251

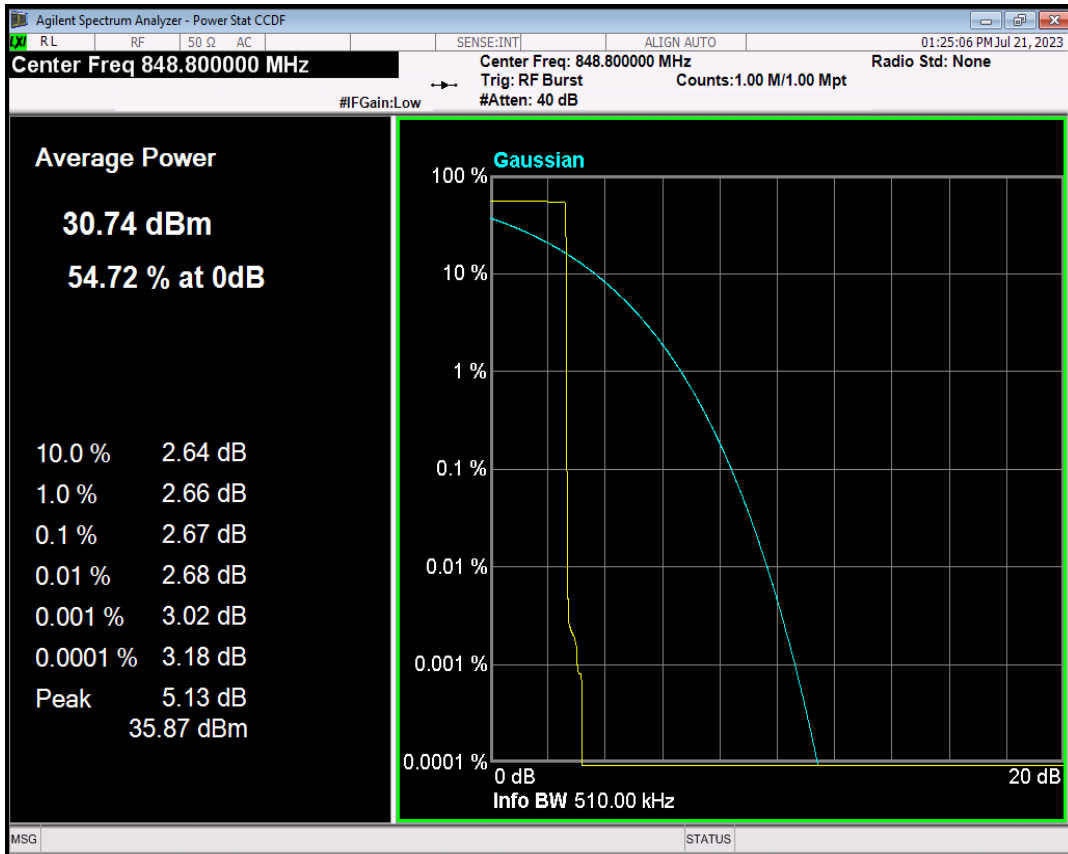

EGPRS850 Channel=128

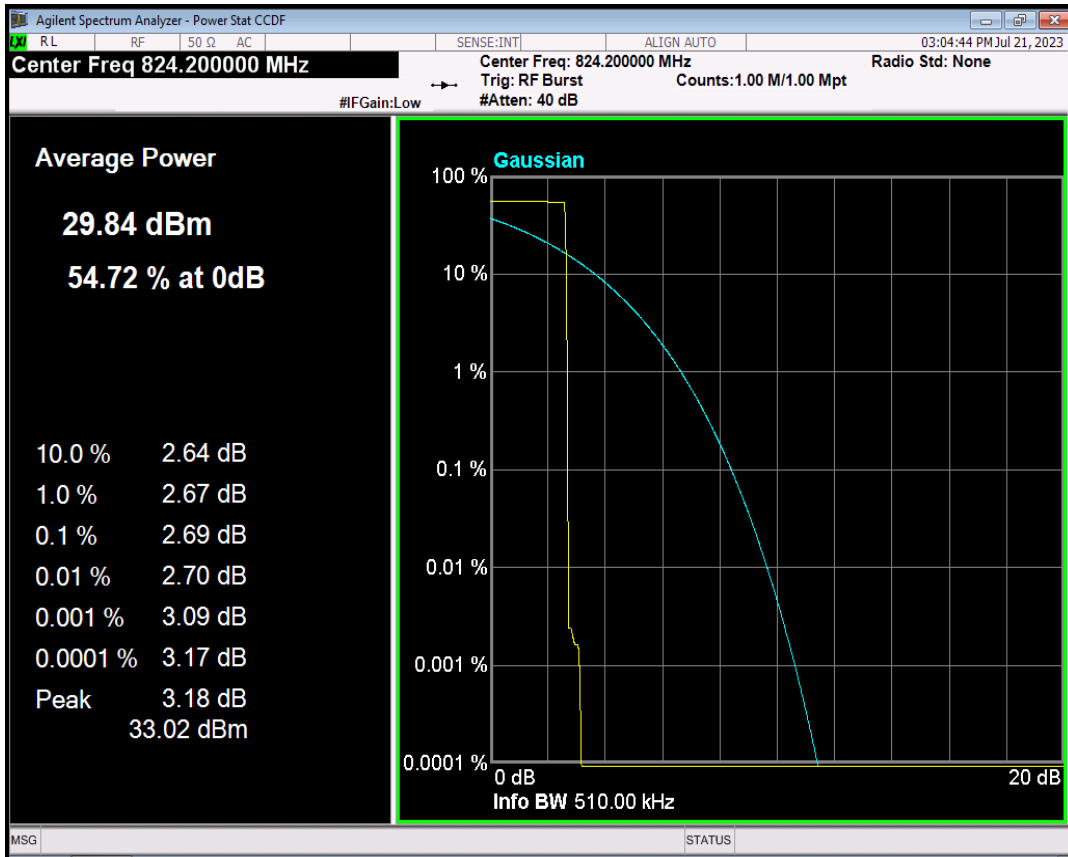

EGPRS850 Channel=190

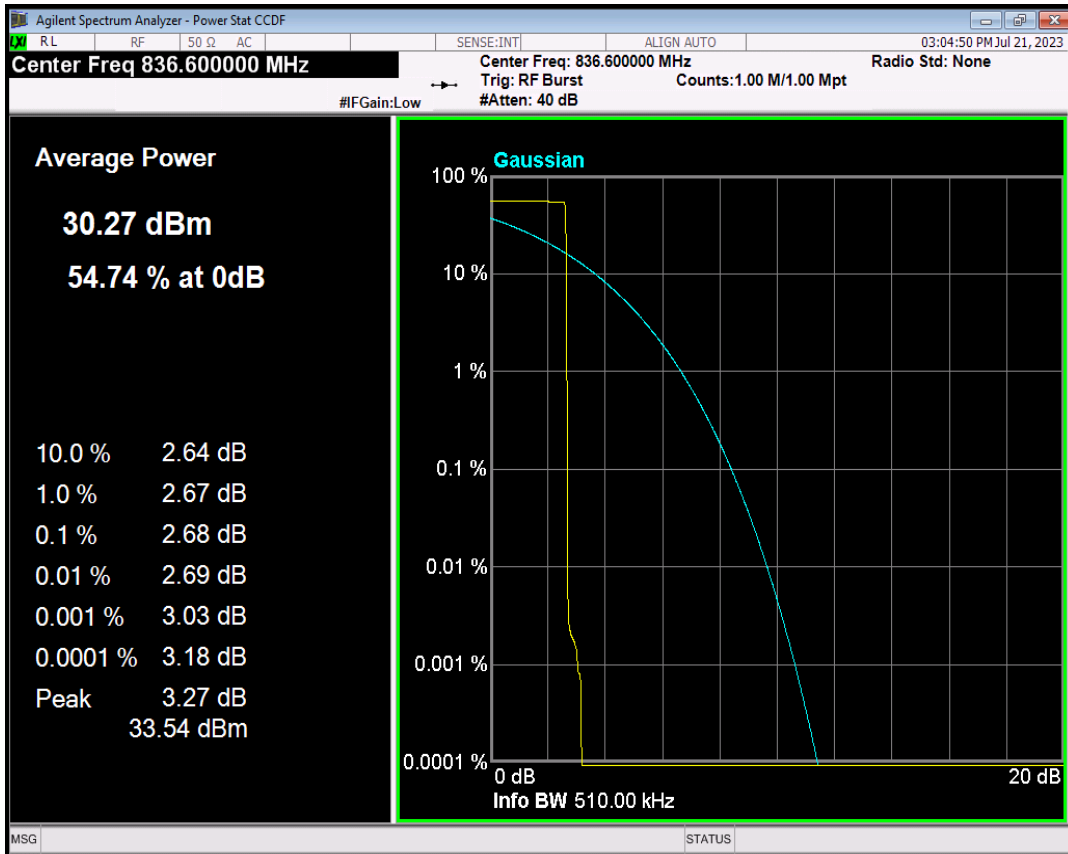

EGPRS850 Channel=251

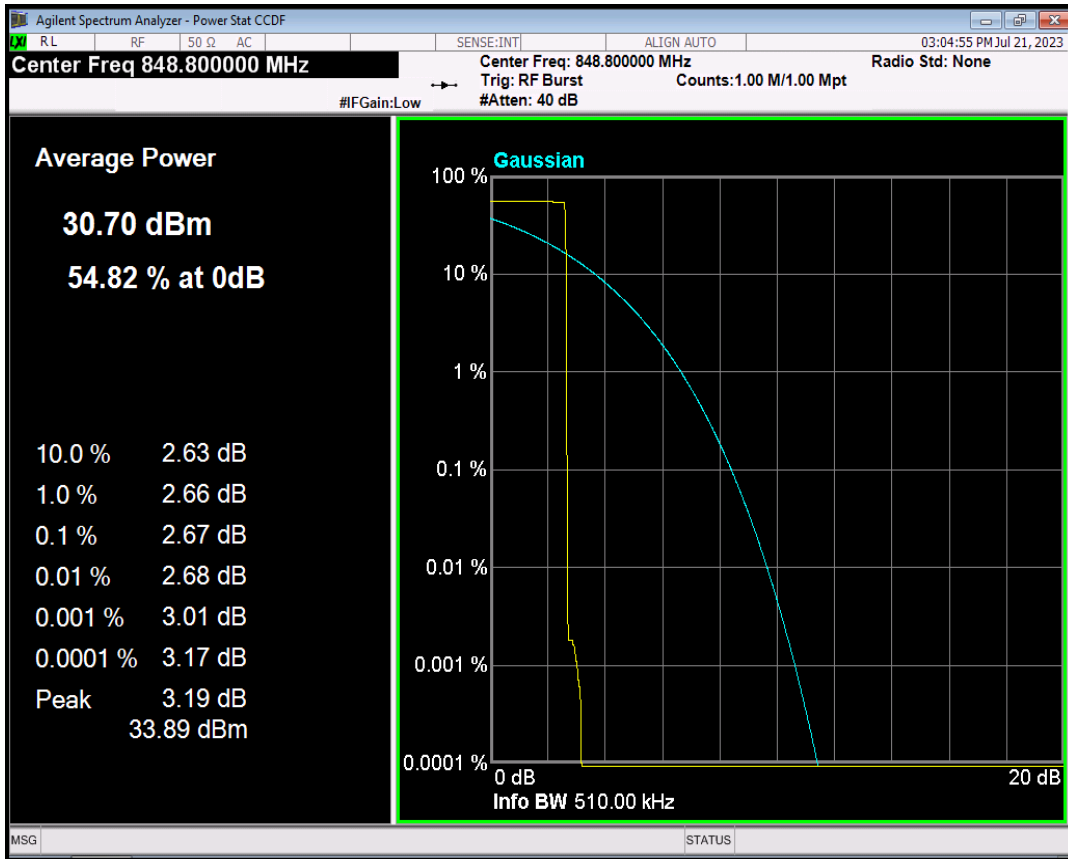

Band	Channel	Frequency (MHz)	Result (dB)	high Limit (dB)	Verdict
GSM1900	512	1850.2	2.65	13.00	PASS
GSM1900	661	1880	2.69	13.00	PASS
GSM1900	810	1909.8	2.78	13.00	PASS
GPRS1900	512	1850.2	2.69	13.00	PASS
GPRS1900	661	1880	2.72	13.00	PASS
GPRS1900	810	1909.8	2.81	13.00	PASS
EGPRS1900	512	1850.2	8.26	13.00	PASS
EGPRS1900	661	1880	8.09	13.00	PASS
EGPRS1900	810	1909.8	8.32	13.00	PASS

GSM1900 Channel=512

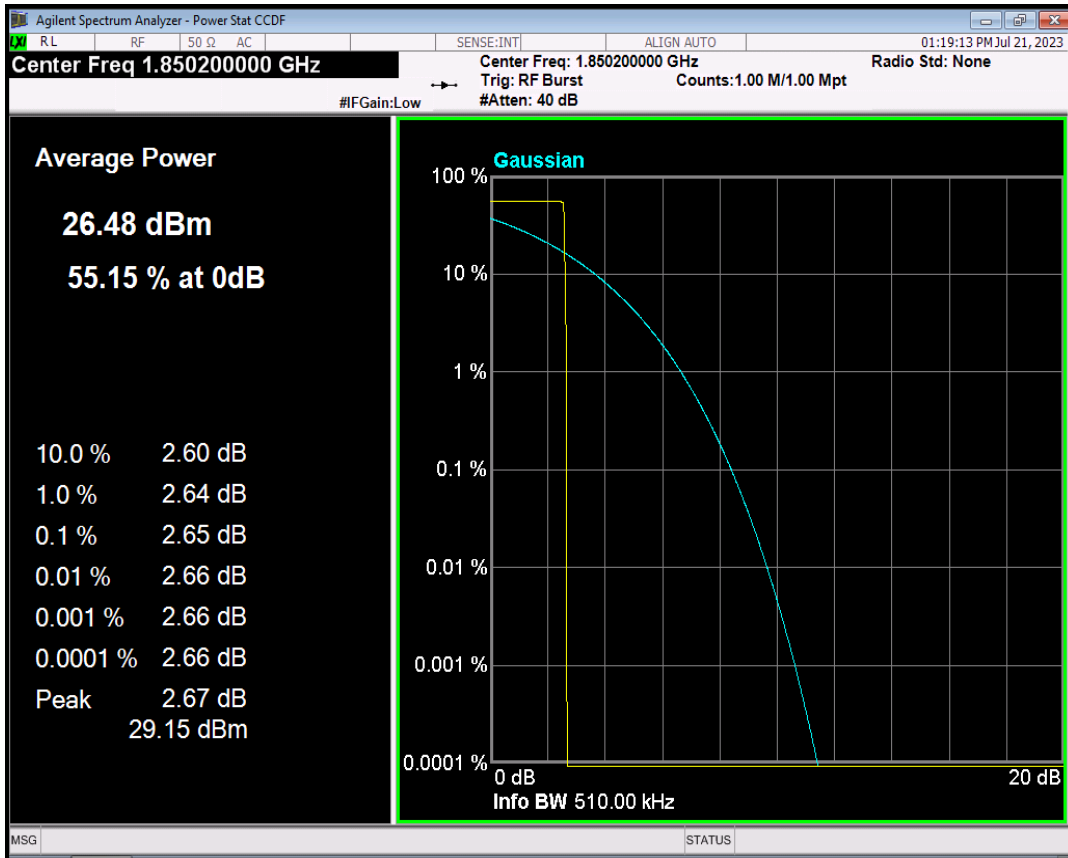

GSM1900 Channel=661

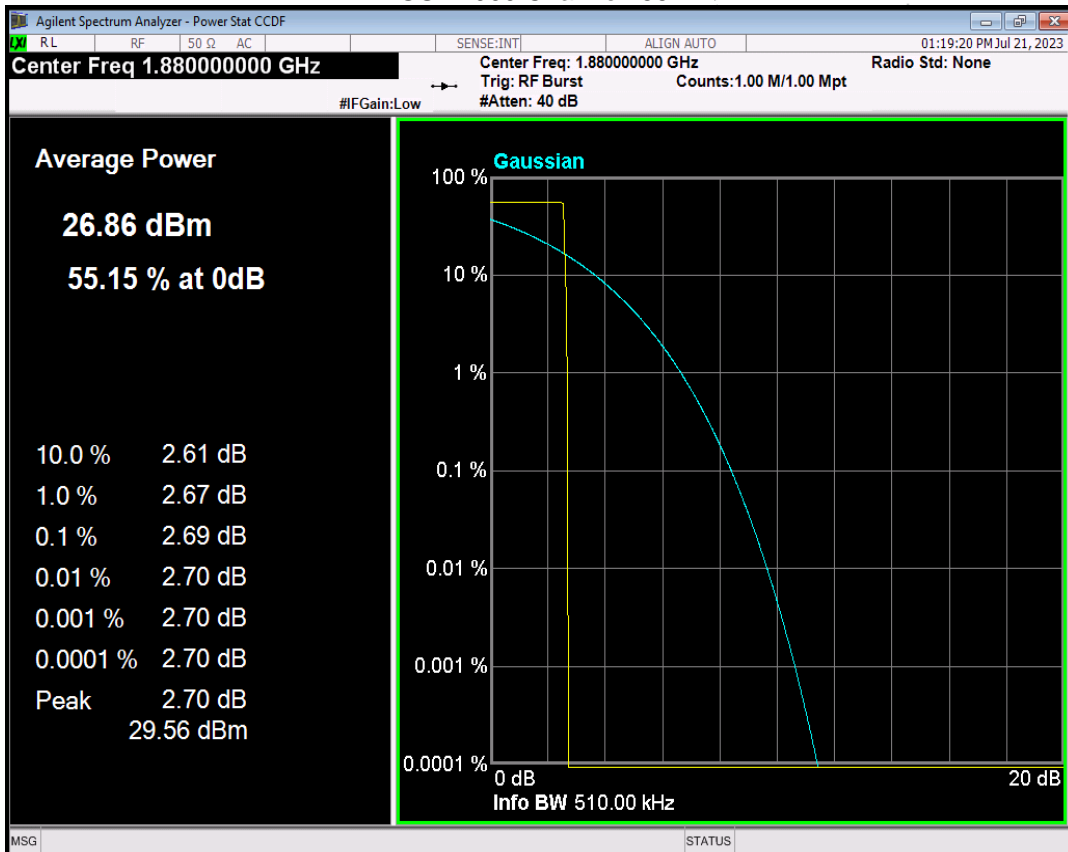

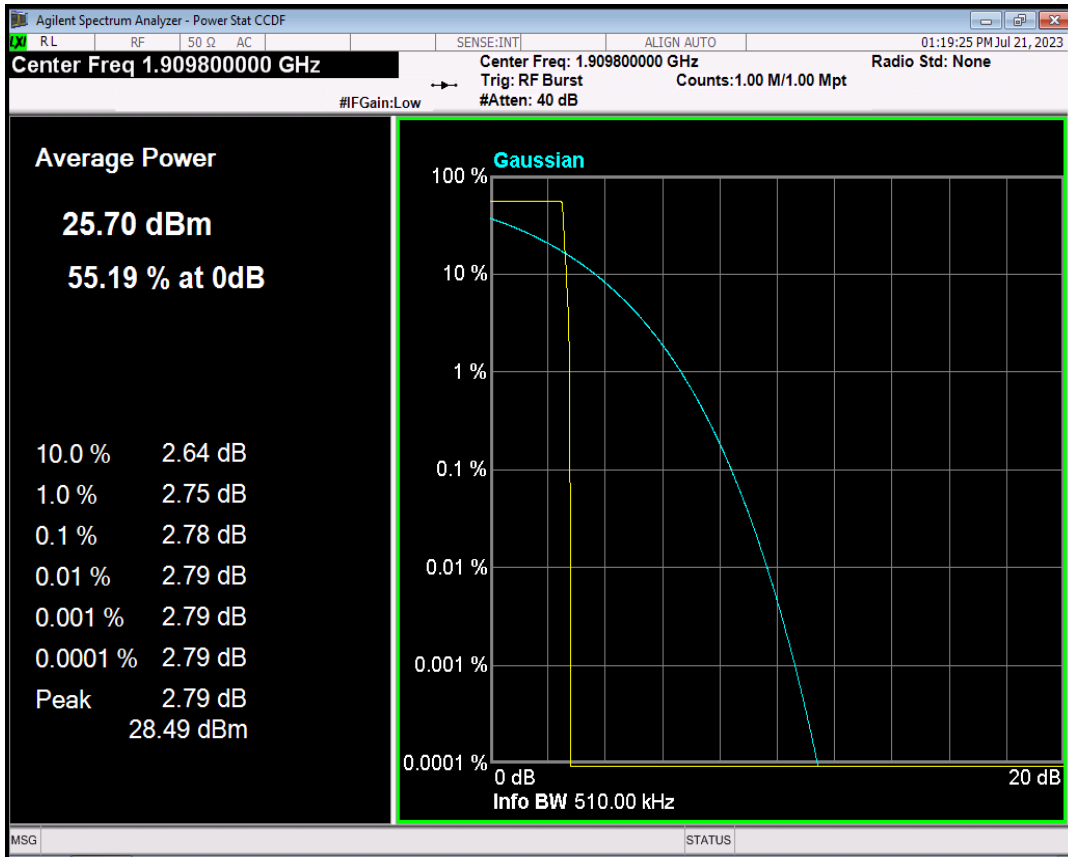
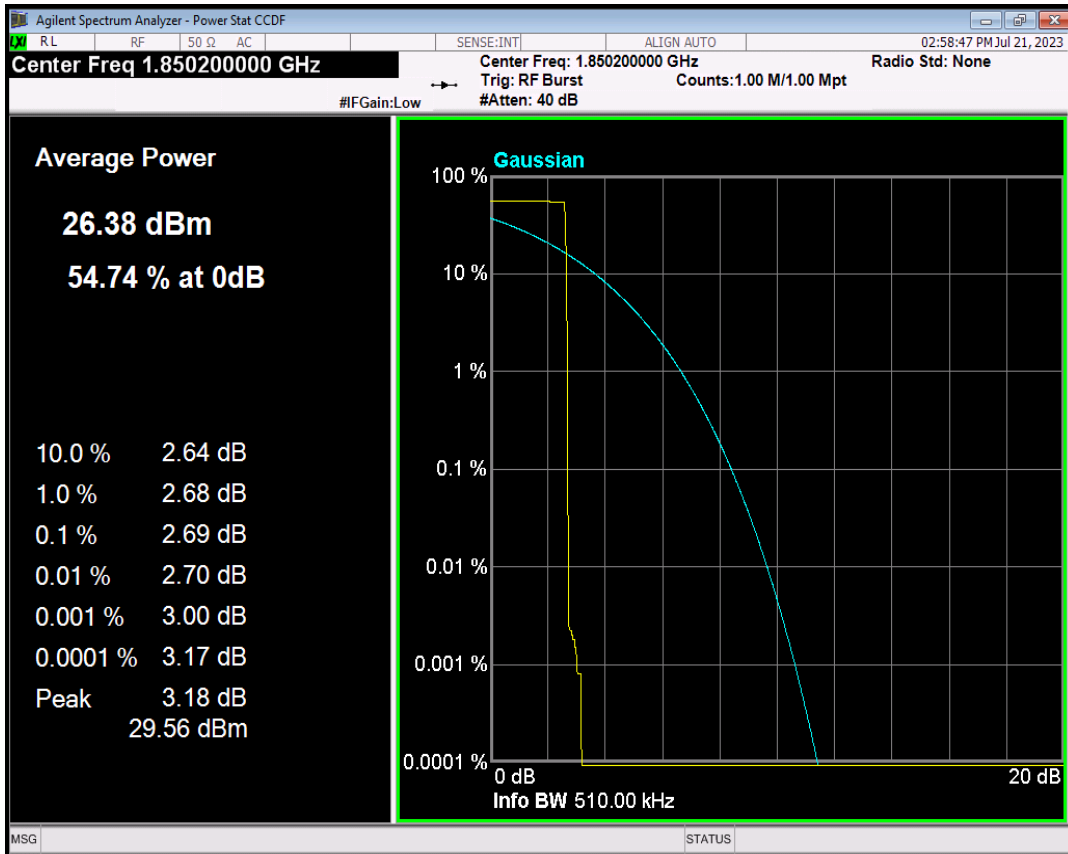
GSM1900 Channel=810

GPRS1900 Channel=512

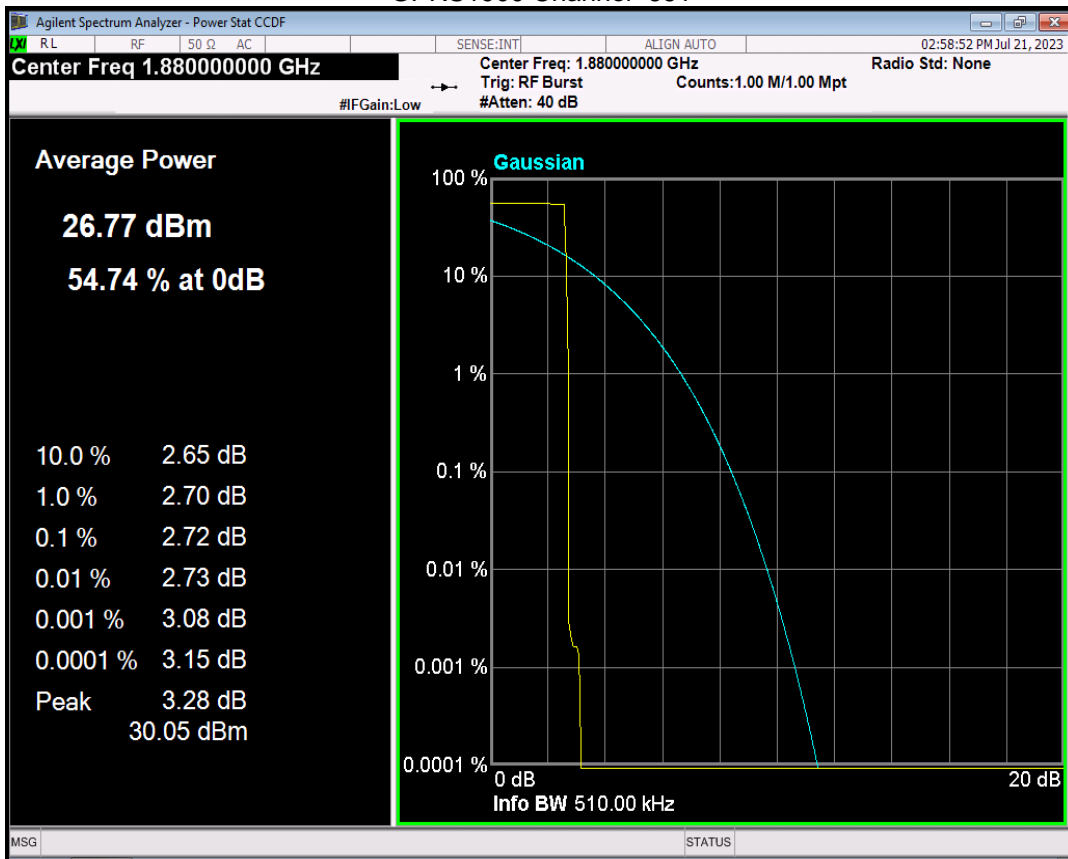
GPRS1900 Channel=661

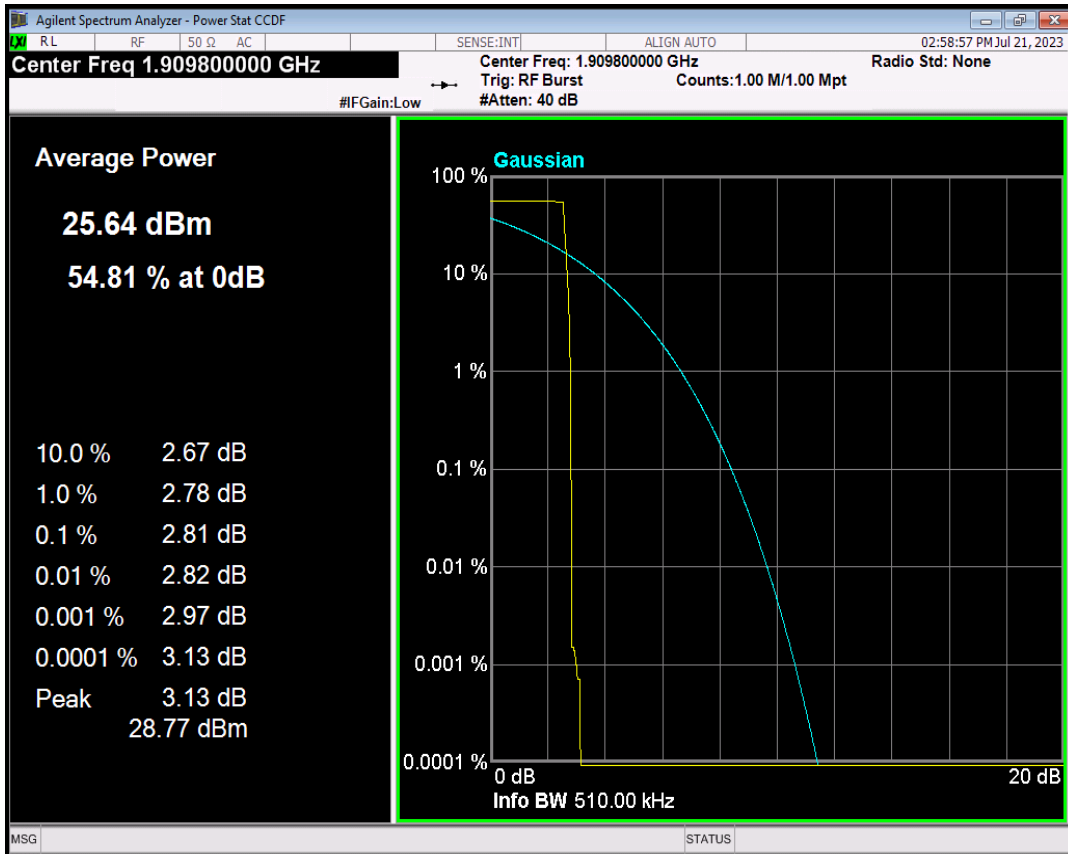

GPRS1900 Channel=810



EGPRS1900 Channel=512

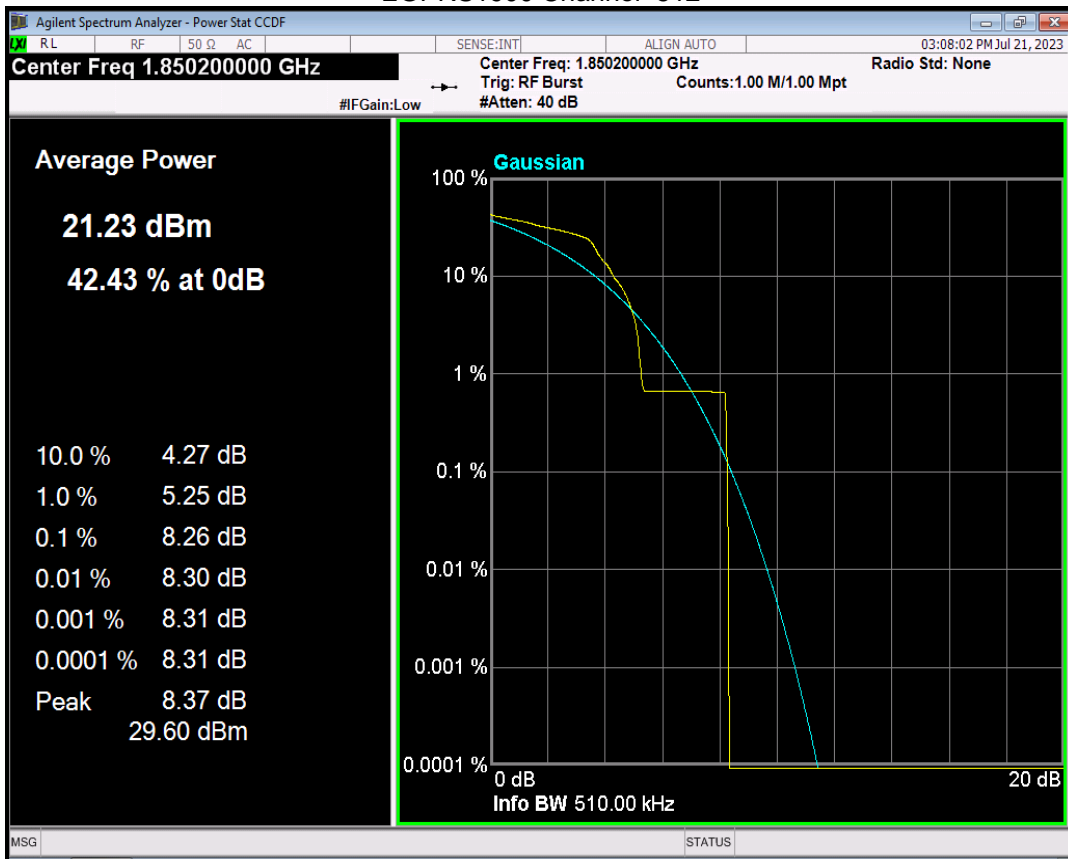

EGPRS1900 Channel=661

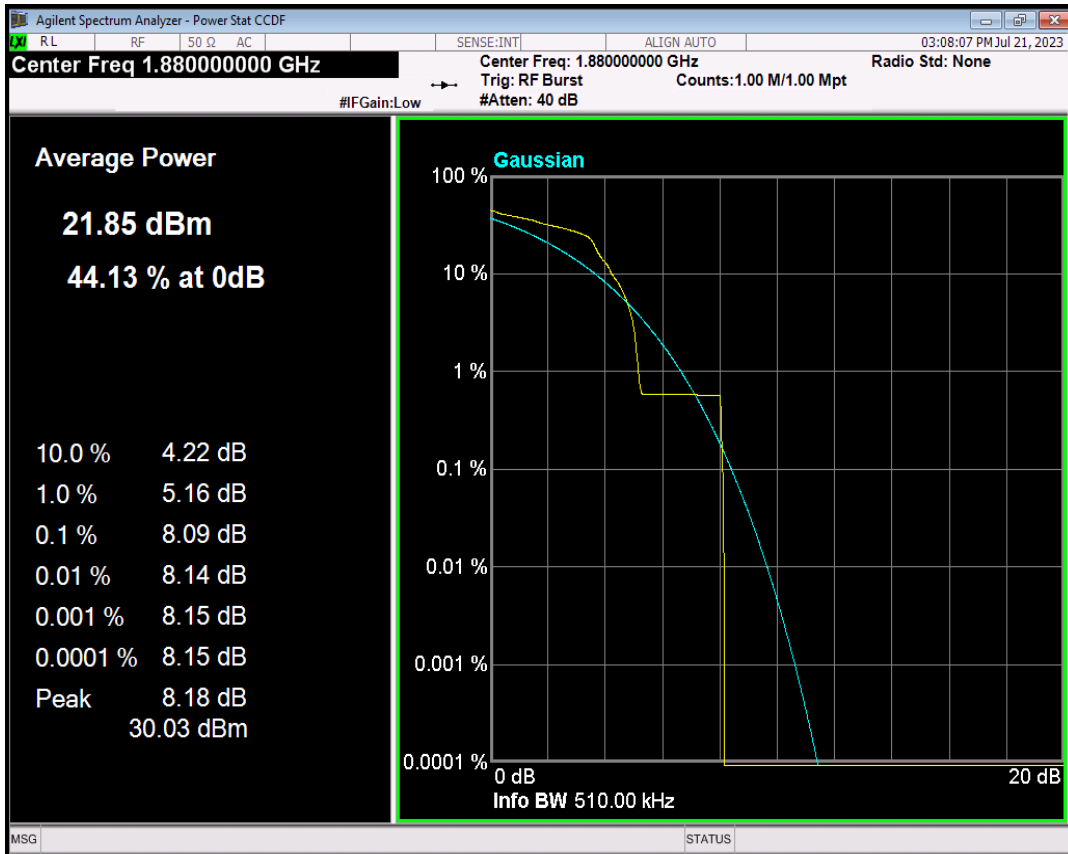

EGPRS1900 Channel=810

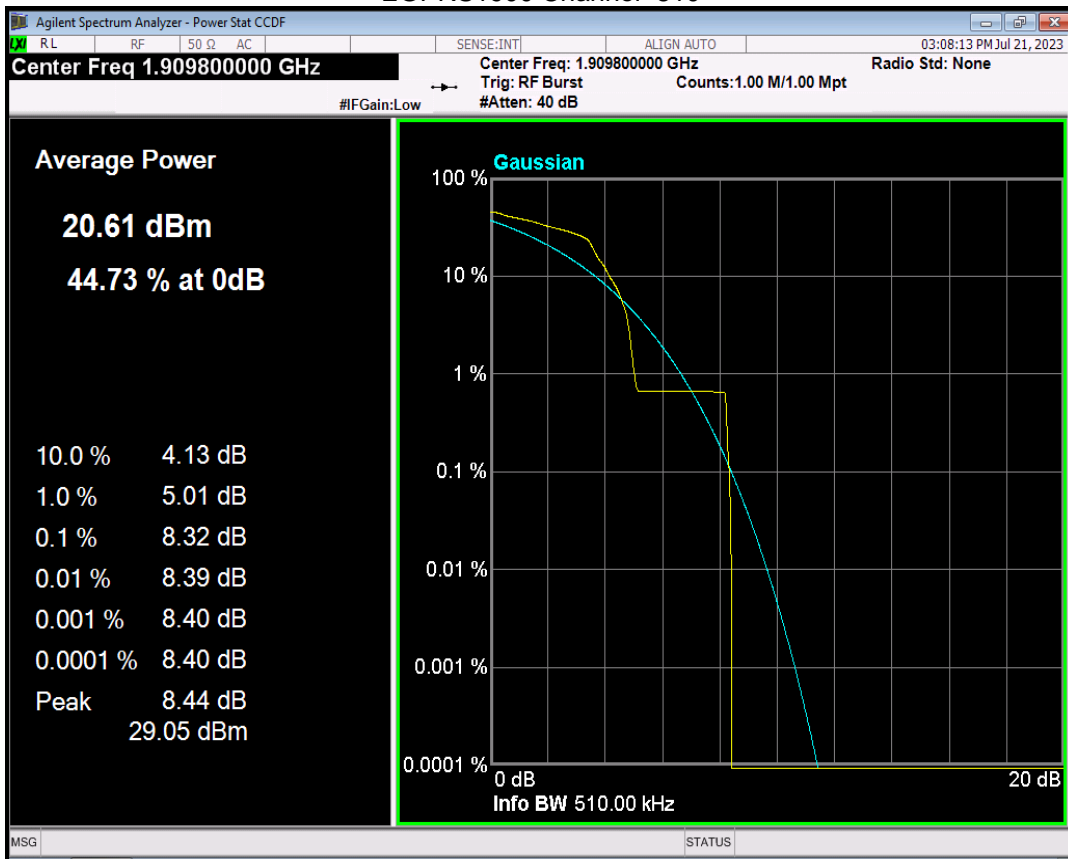

Band	Channel	Frequency (MHz)	Result (dB)	high Limit (dB)	Verdict
WCDMA Band2	9262	1852.4	2.85	13	PASS
WCDMA Band2	9400	1880	2.89	13	PASS
WCDMA Band2	9538	1907.6	2.88	13	PASS
WCDMA Band4	1312	1712.4	2.69	13	PASS
WCDMA Band4	1450	1740	2.86	13	PASS
WCDMA Band4	1513	1752.6	2.72	13	PASS
WCDMA Band5	4132	826.4	3.03	13	PASS
WCDMA Band5	4182	836.4	3.10	13	PASS
WCDMA Band5	4233	846.6	3.06	13	PASS

Note: In WCDMA, RMC, HSDPA and HSUPA all three tests only reflect the worst mode RMC.

WCDMA Band2 Channel=9262

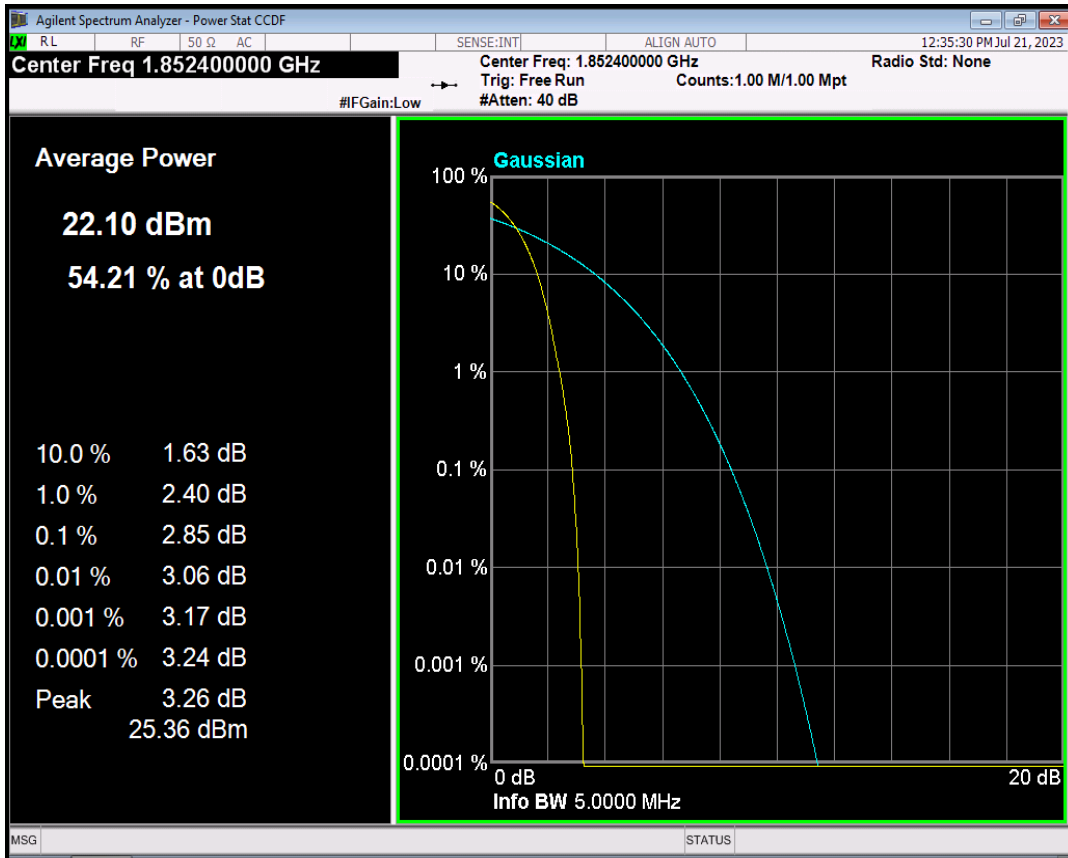

WCDMA Band2 Channel=9400

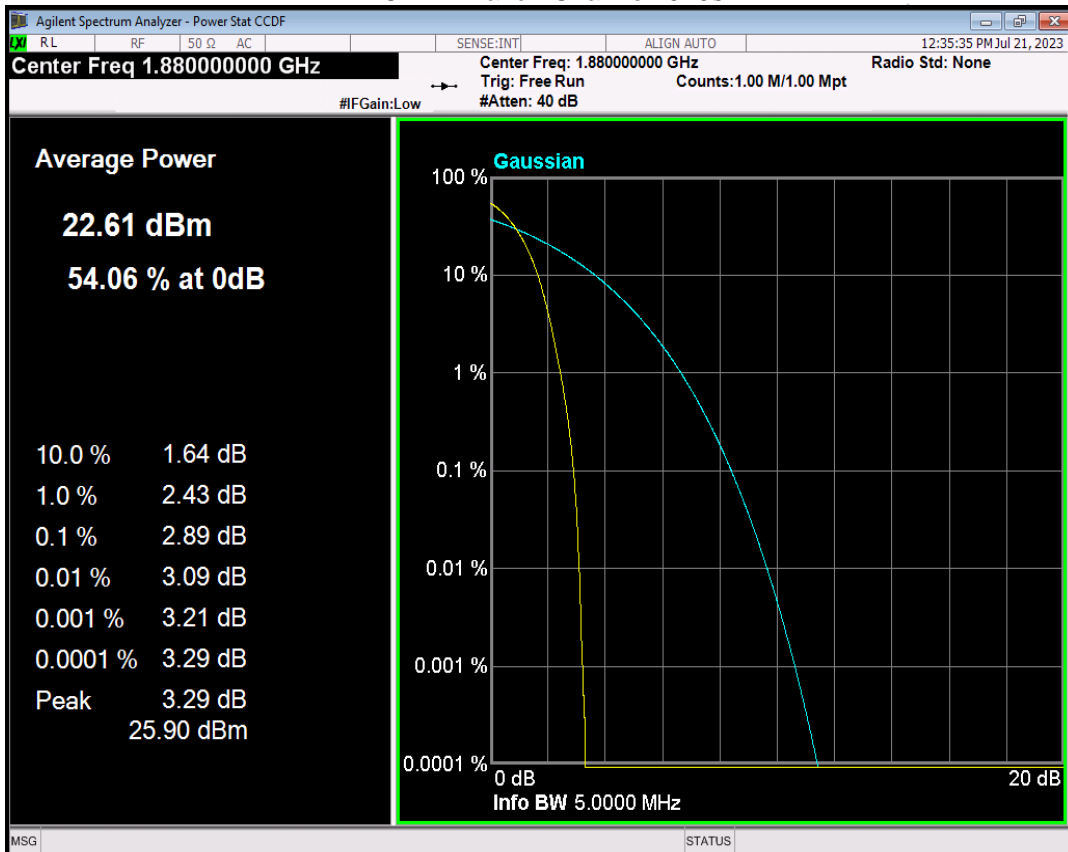

WCDMA Band2 Channel=9538

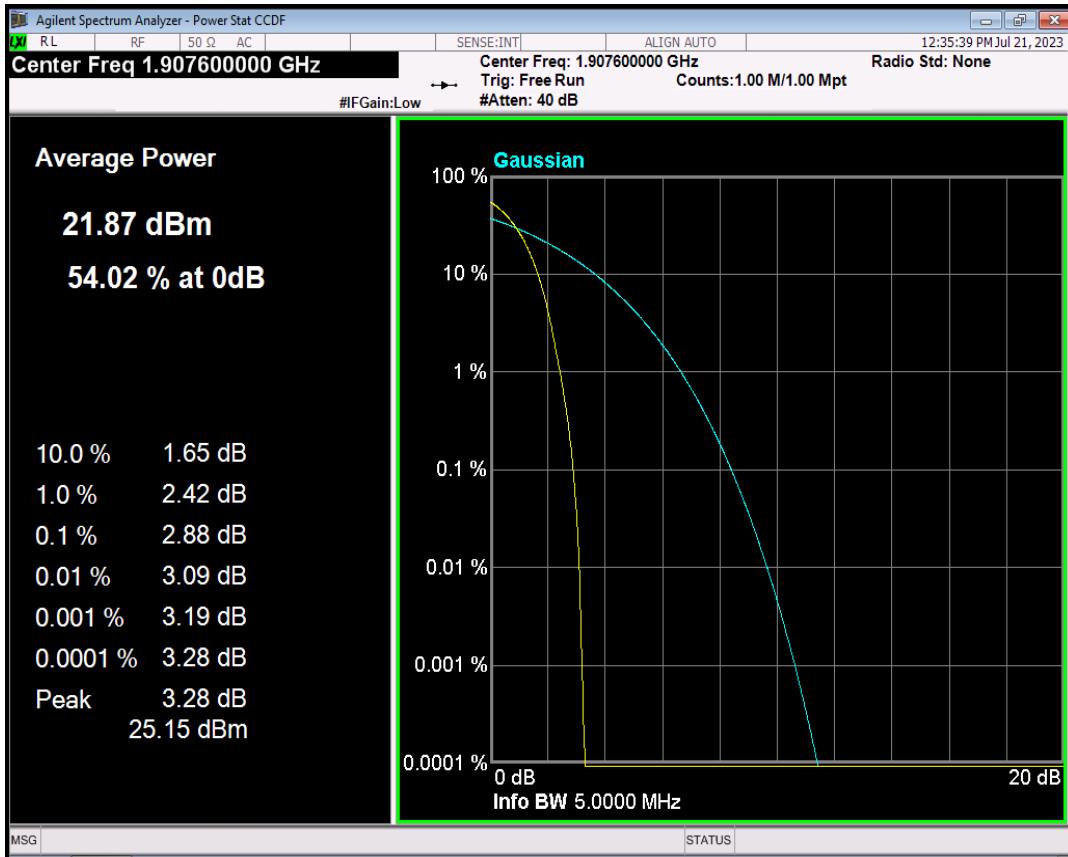

WCDMA Band4 Channel=1312

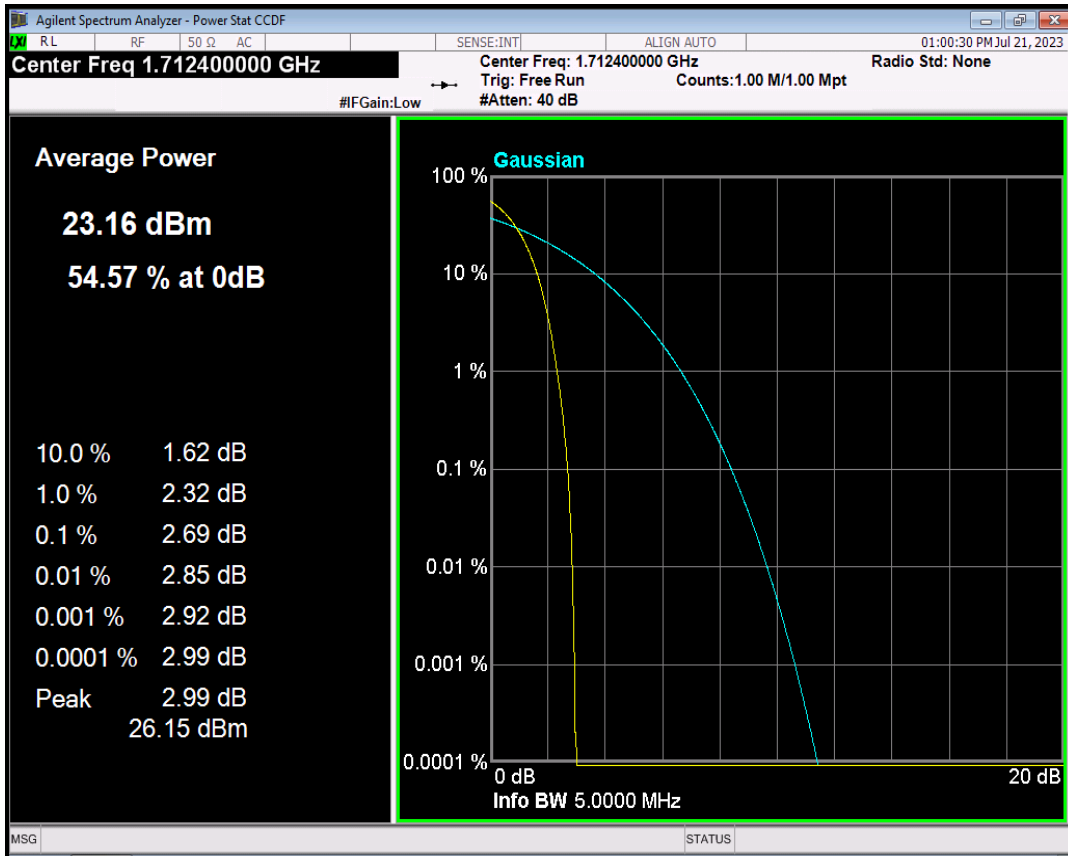

WCDMA Band4 Channel=1450

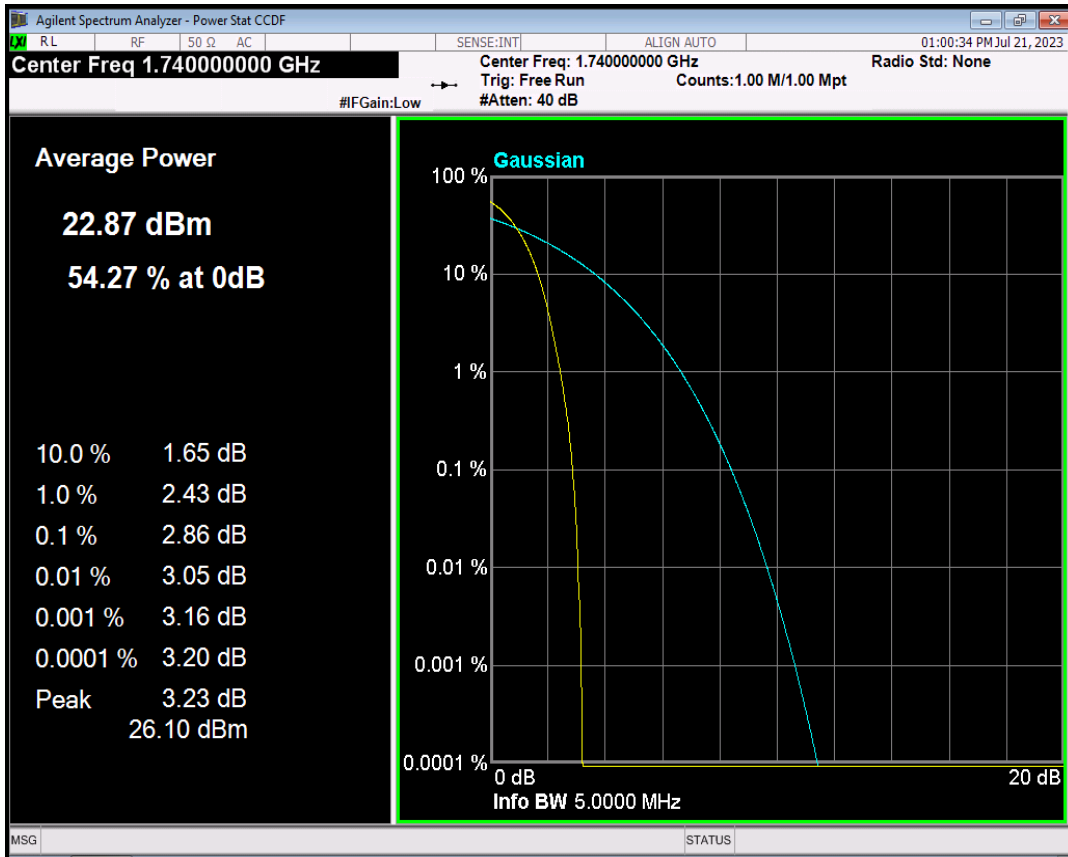

WCDMA Band4 Channel=1513

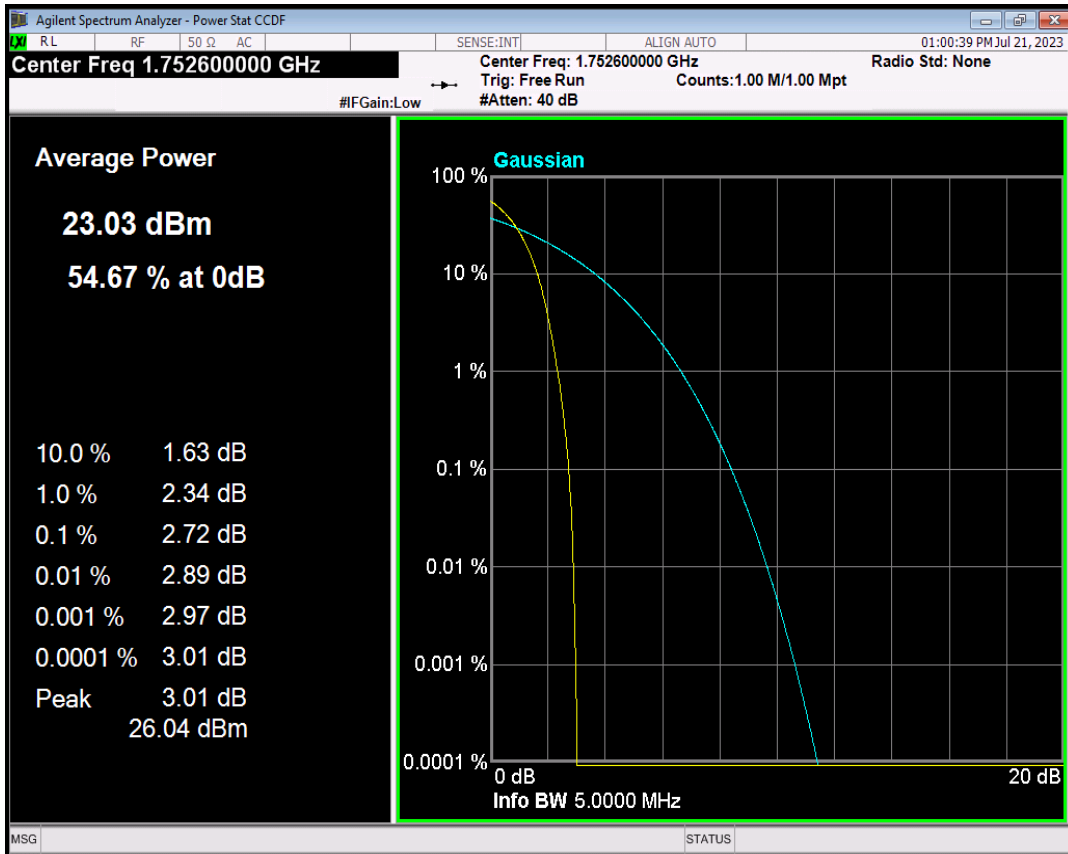

WCDMA Band5 Channel=4132

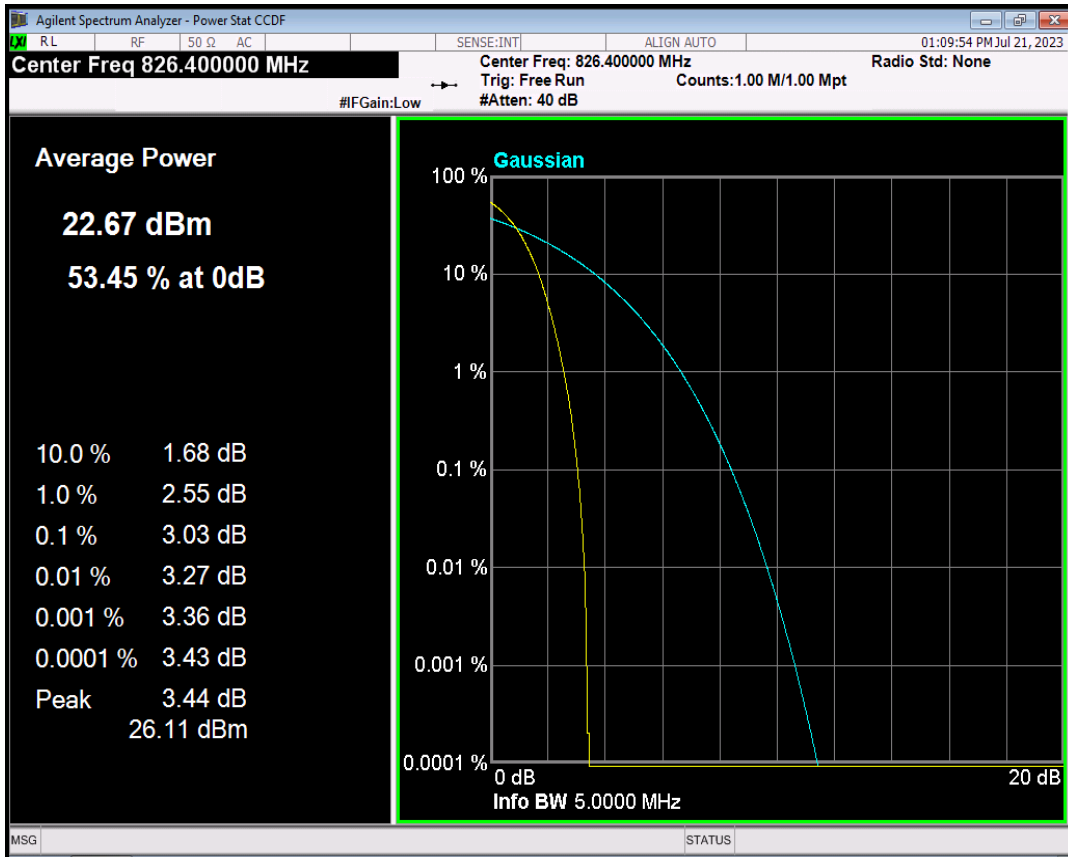

WCDMA Band5 Channel=4182

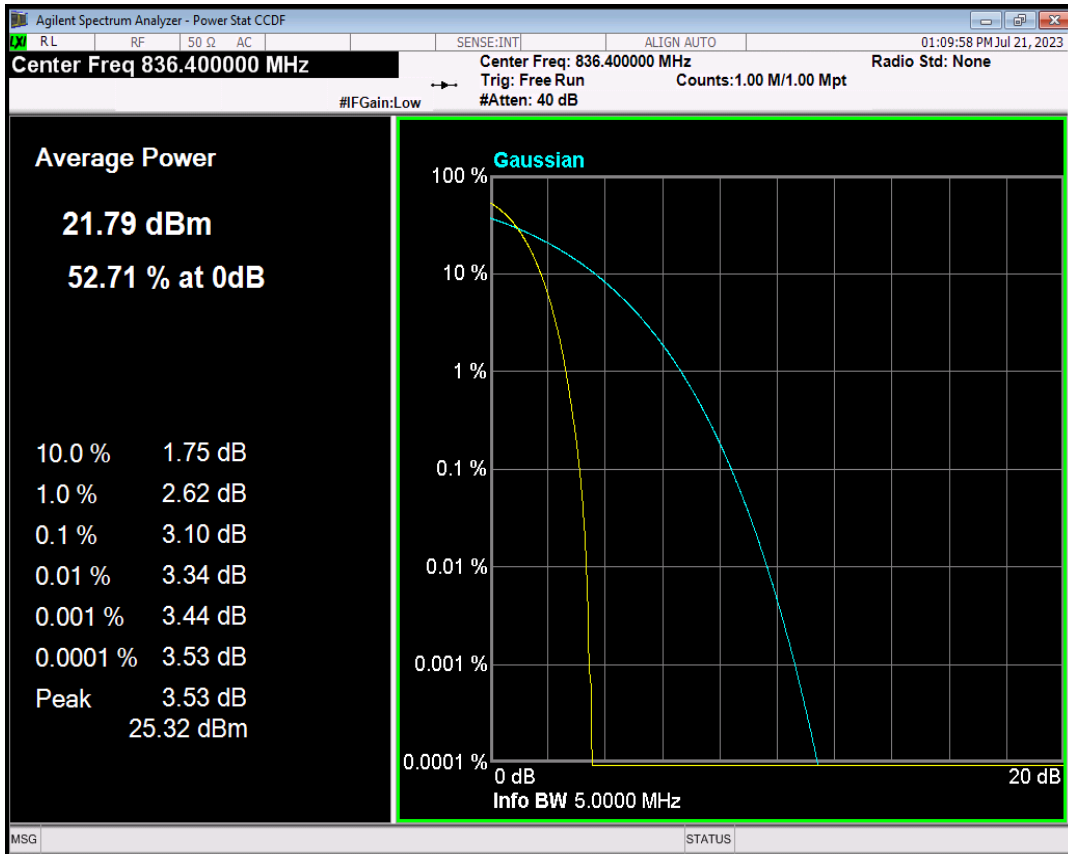

WCDMA Band5 Channel=4233

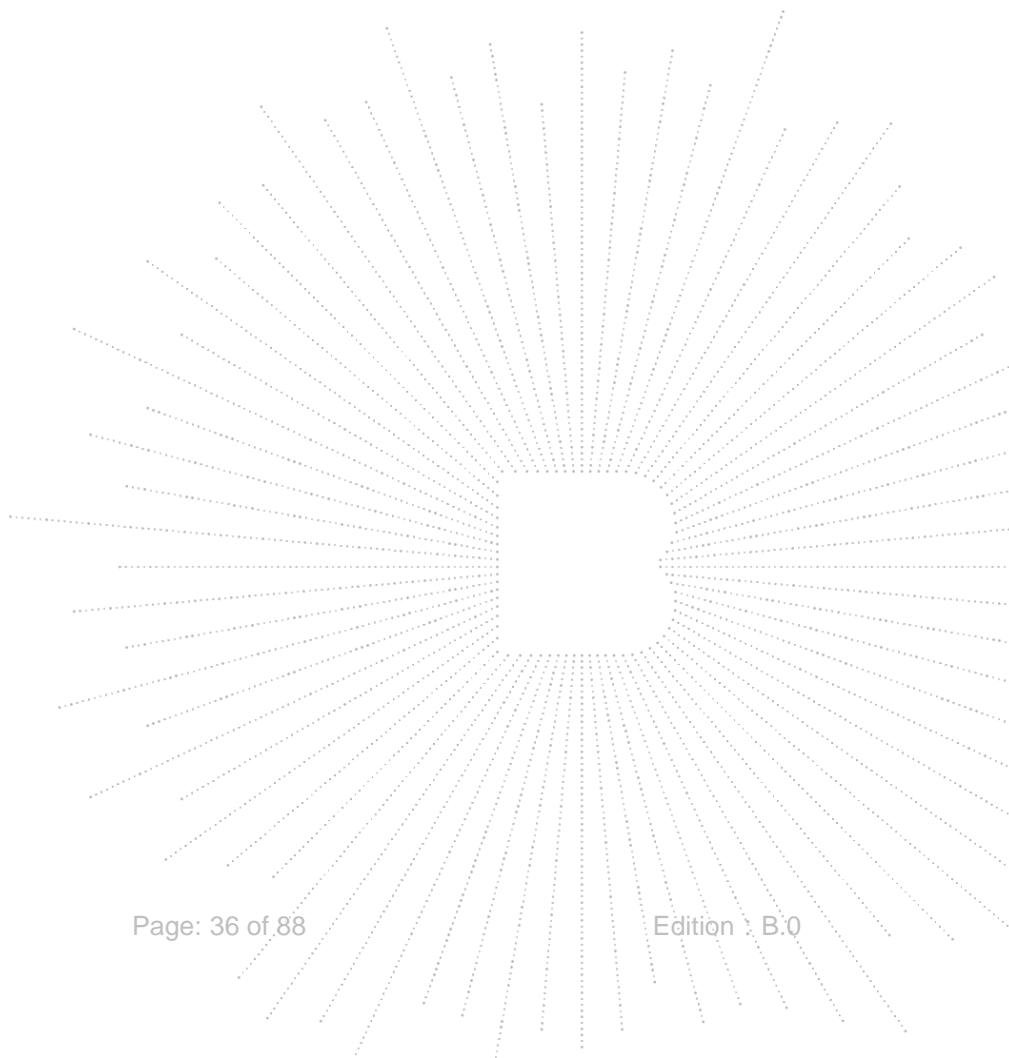
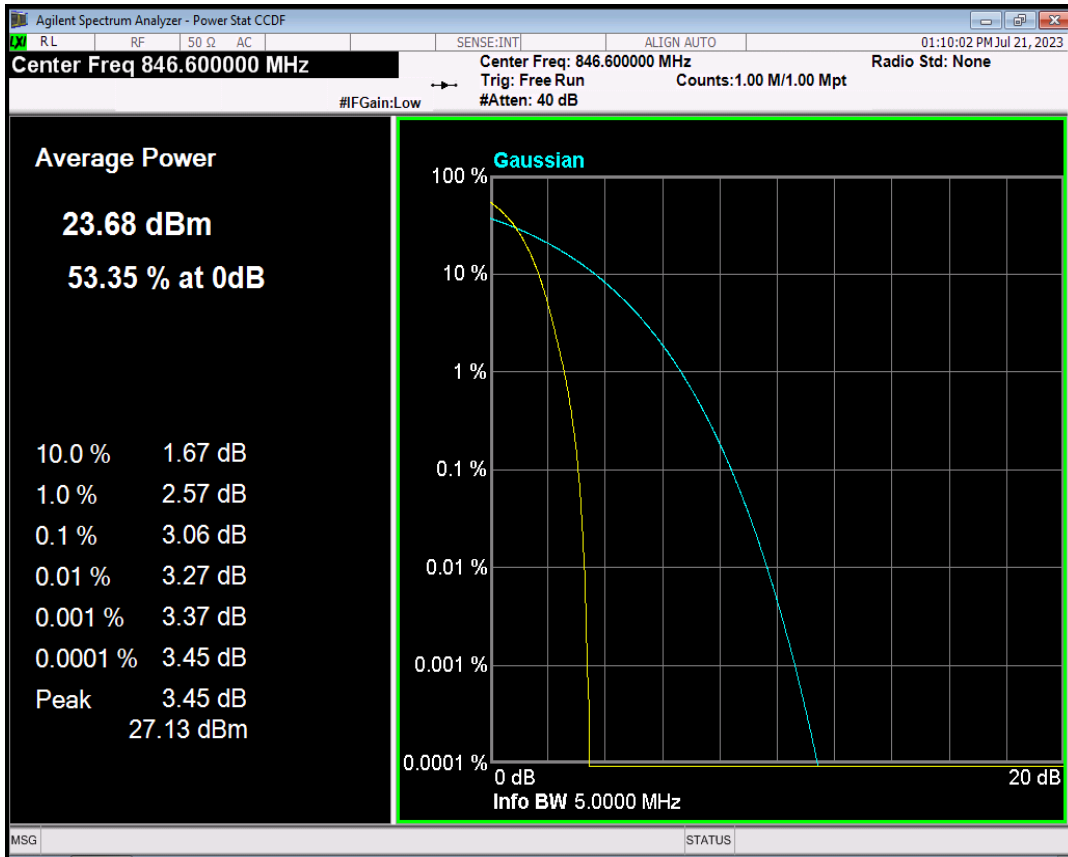

8. Emission Bandwidth

8.1 Block Diagram Of Test Setup

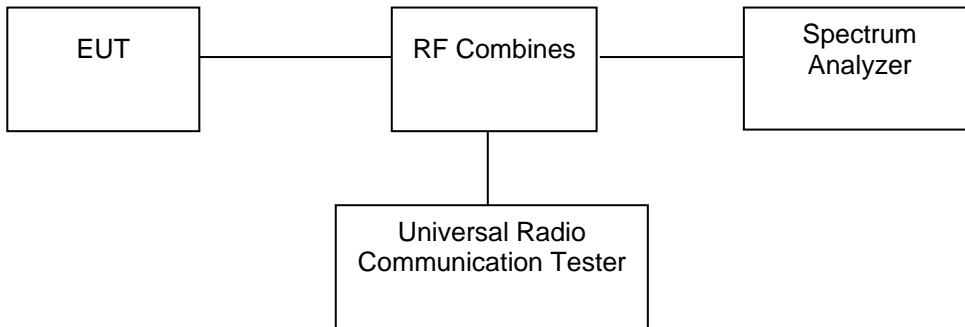

8.2 Limit

According to §22.917(b), The emission bandwidth is defined as the width of the signal between two points, one below the carrier center frequency and one above the carrier center frequency, outside of which all emissions are attenuated at least 26 dB below the transmitter power.

According to §24.238(b), The emission bandwidth is defined as the width of the signal between two points, one below the carrier center frequency and one above the carrier center frequency, outside of which all emissions are attenuated at least 26 dB below the transmitter power.

According to §27.53, The emission bandwidth is defined as the width of the signal between two points, one below the carrier center frequency and one above the carrier center frequency, outside of which all emissions are attenuated at least 26 dB below the transmitter power.

8.3 Test procedure

The RF output terminal of the transmitter was connected to the input of the spectrum analyzer via a suitable attenuation. The RBW of the spectrum analyzer was set to 10kHz for GSM mode and 100kHz for WCDMA mode, VBW shall be at least 3 times the RBW, and the 26dB bandwidth was recorded.

8.4 Test Result

Band	Channel	Frequency (MHz)	99% OBW (kHz)	-26dB EBW (kHz)	Verdict
GSM850	128	824.2	243.931	320.231	PASS
GSM850	190	836.6	247.465	322.046	PASS
GSM850	251	848.8	246.059	324.023	PASS
GPRS850	128	824.2	246.045	308.689	PASS
GPRS850	190	836.6	241.075	317.517	PASS
GPRS850	251	848.8	242.840	310.888	PASS
EGPRS850	128	824.2	244.833	308.628	PASS
EGPRS850	190	836.6	249.044	324.821	PASS
EGPRS850	251	848.8	241.520	311.484	PASS

GSM850 Channel=128

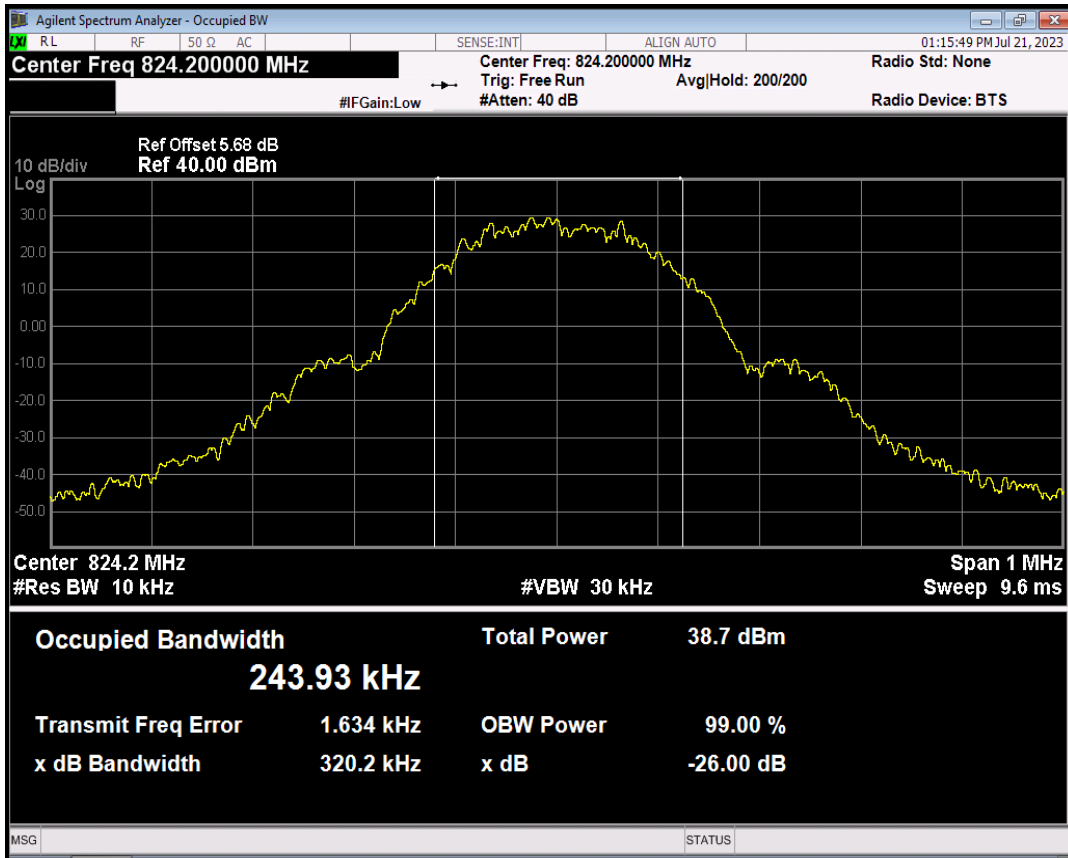

GSM850 Channel=190

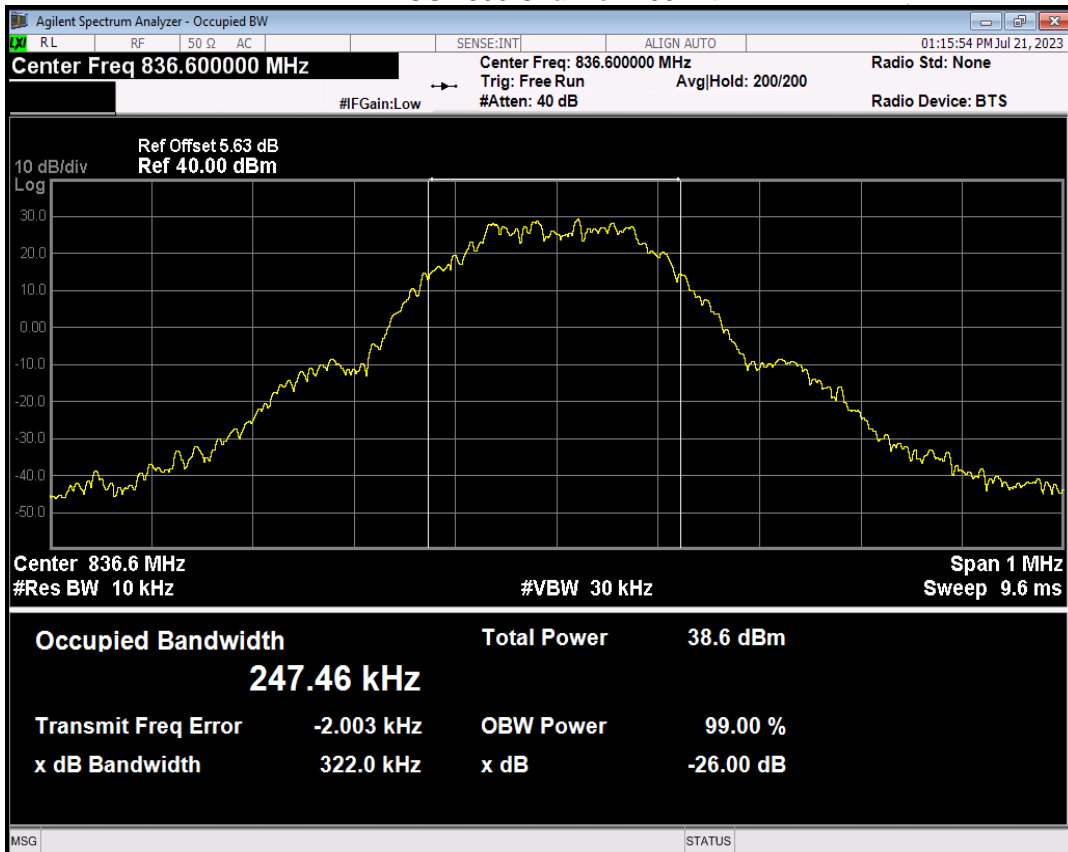

GSM850 Channel=251

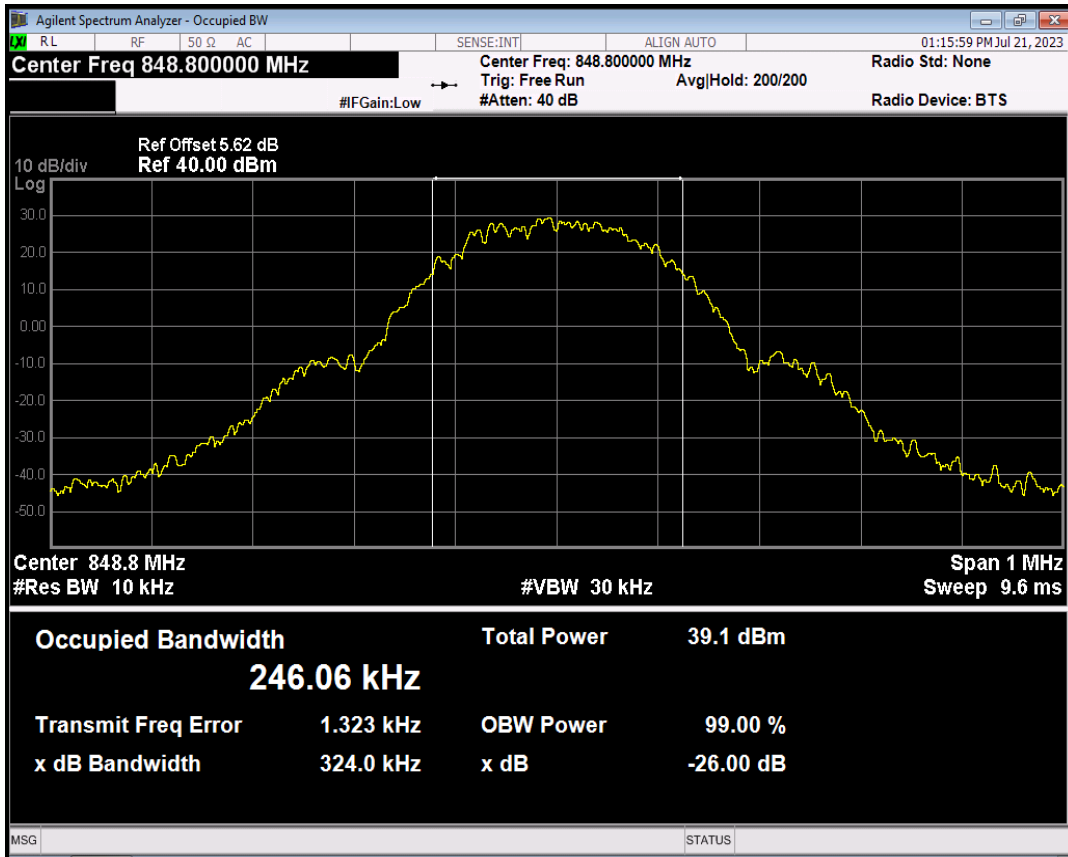

GPRS850 Channel=128

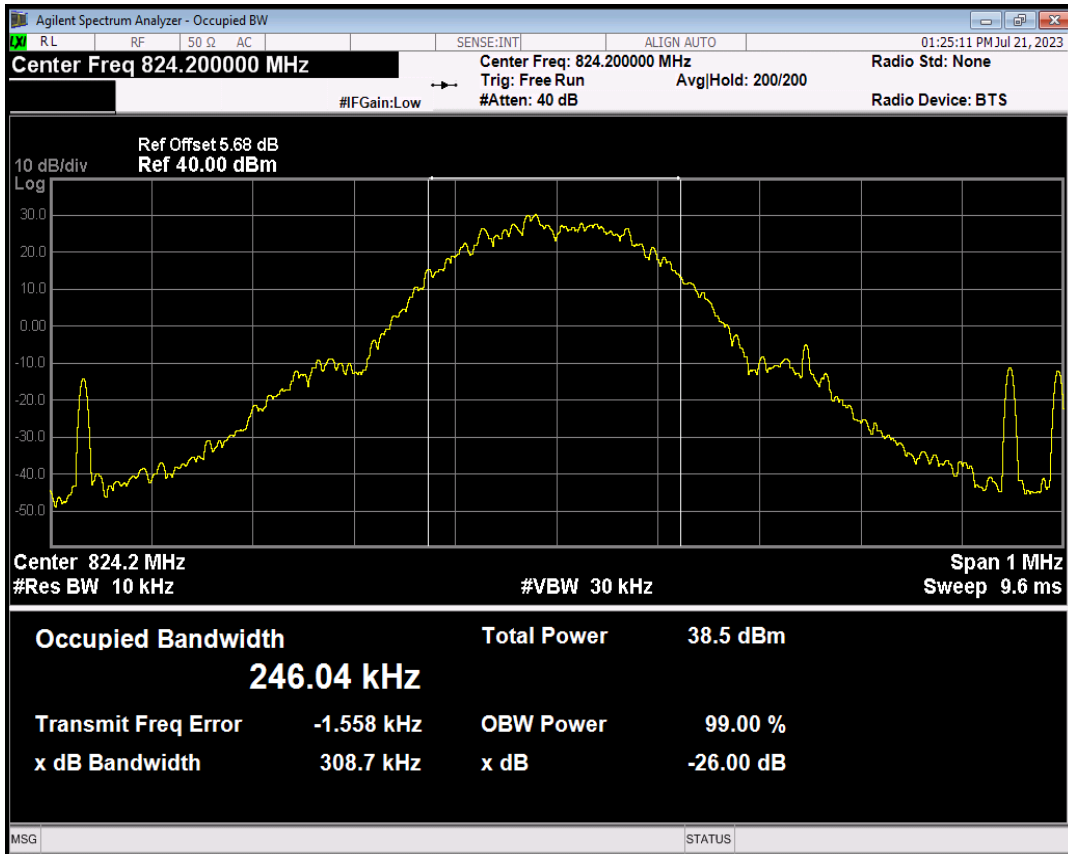

GPRS850 Channel=190

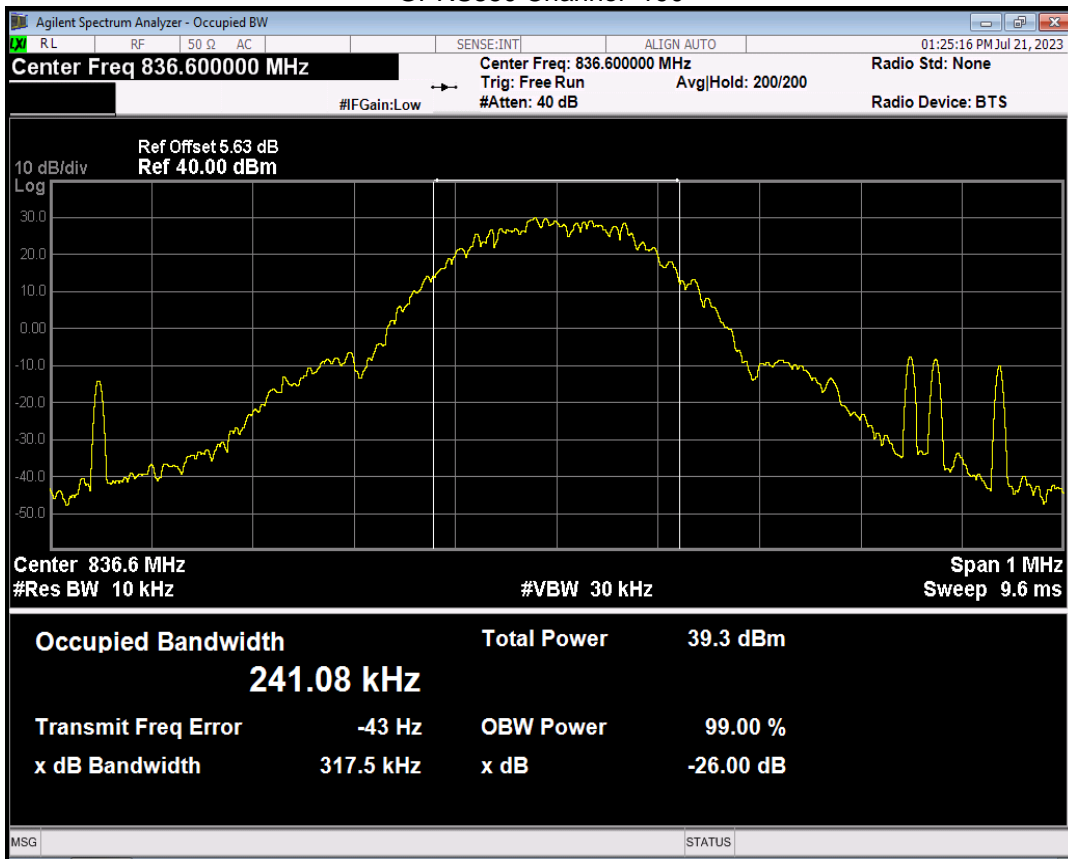

GPRS850 Channel=251

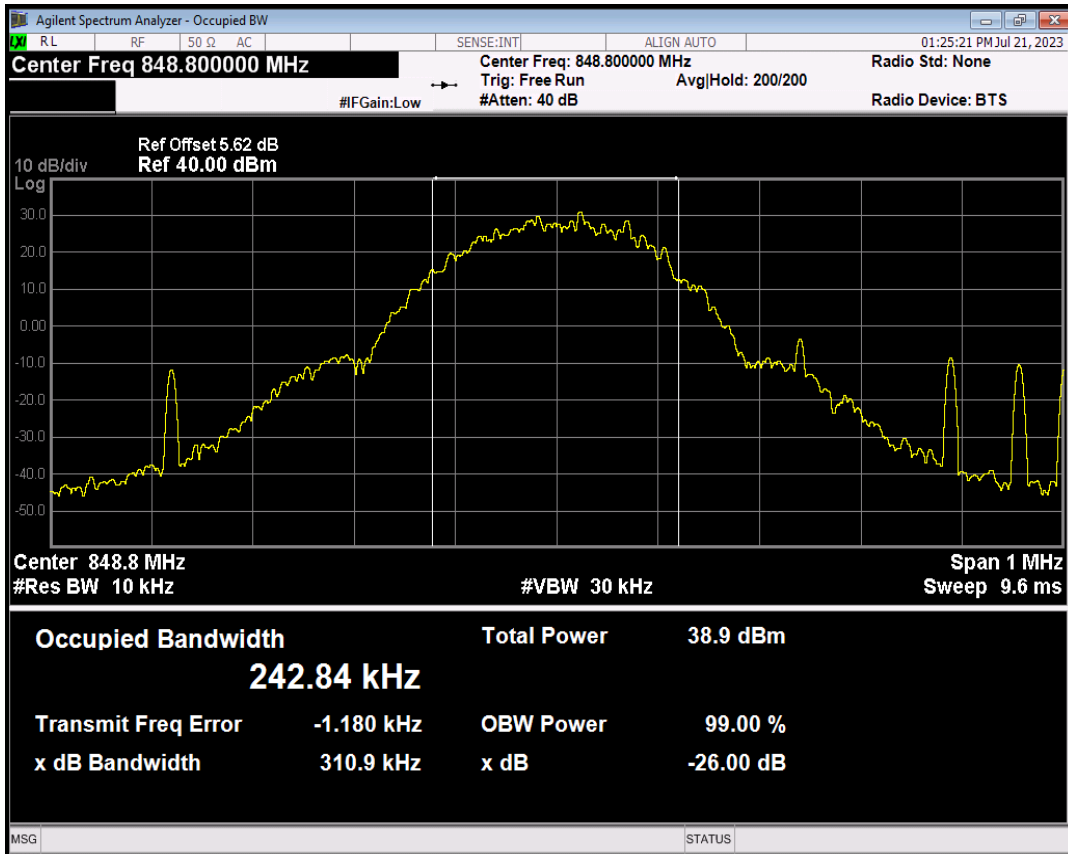

EGPRS850 Channel=128

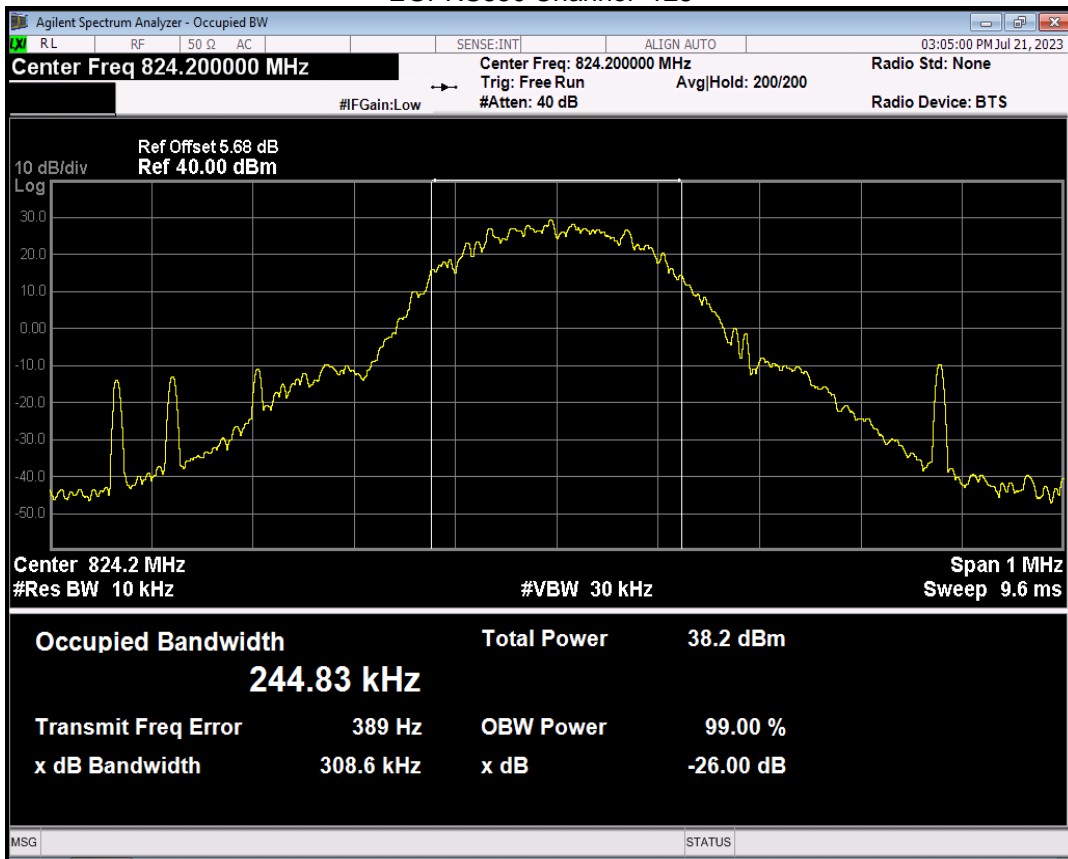

EGPRS850 Channel=190

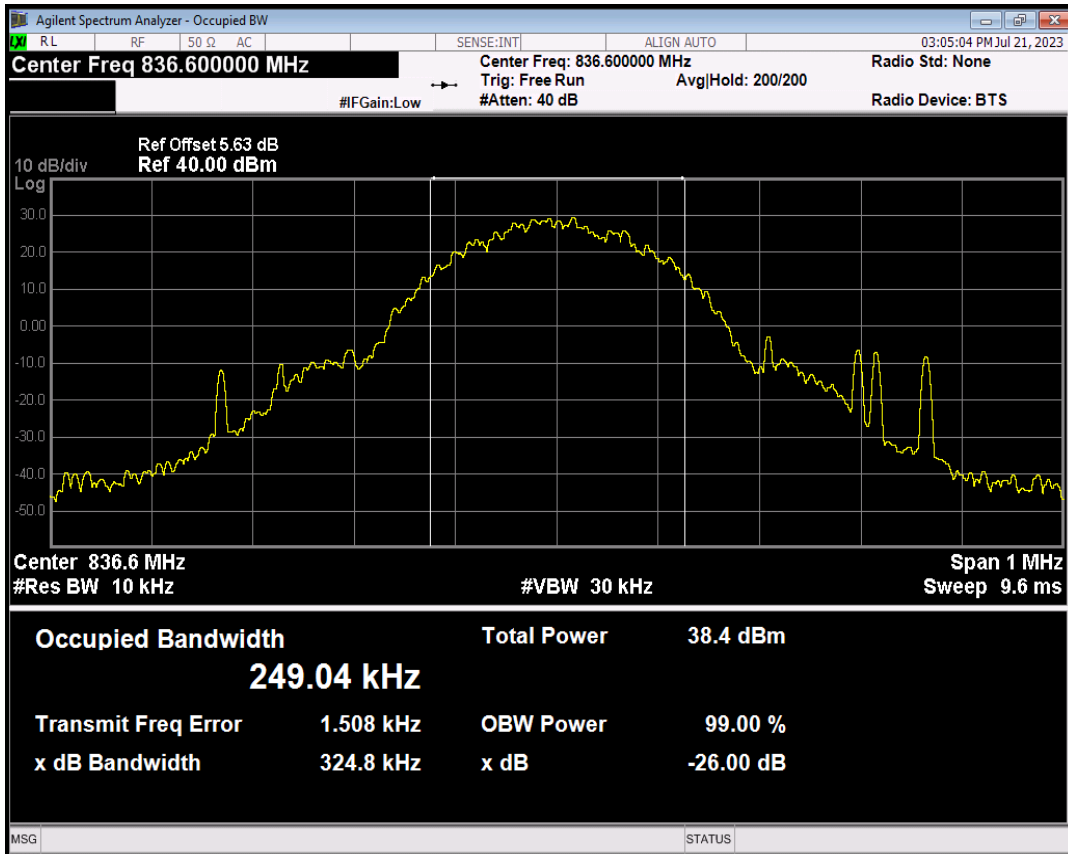

EGPRS850 Channel=251

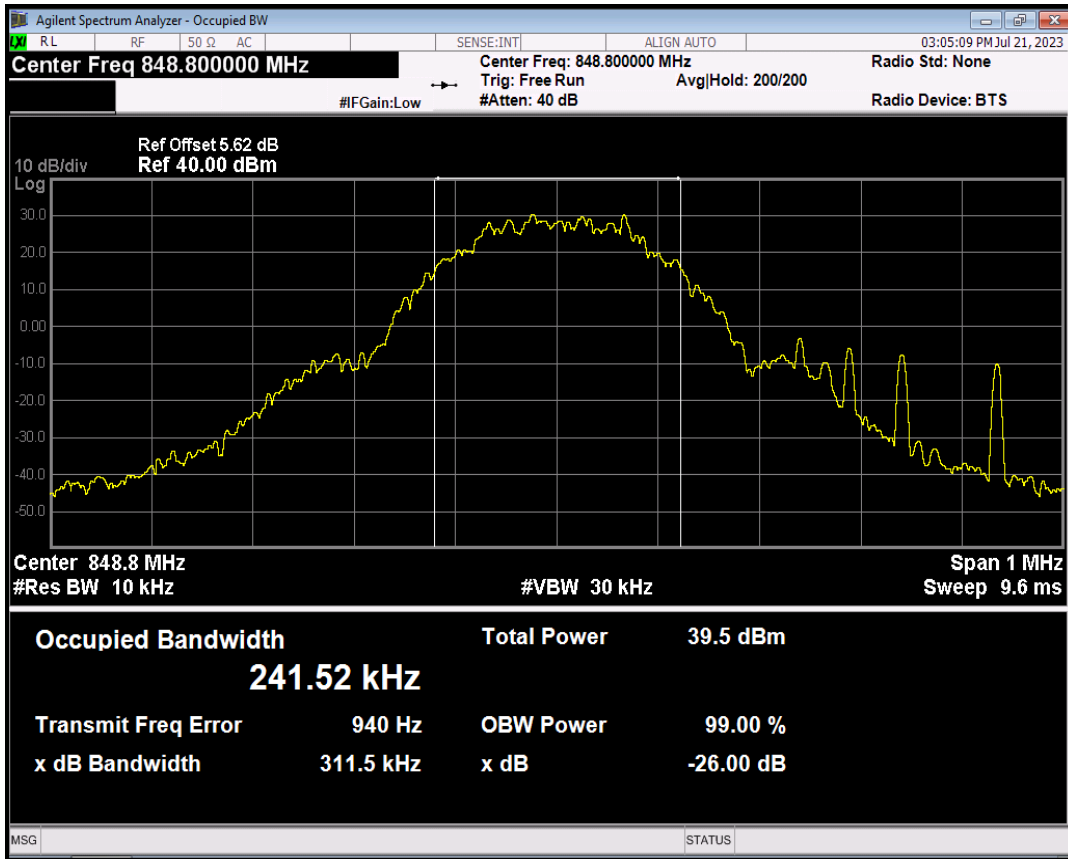

Band	Channel	Frequency (MHz)	99% OBW (kHz)	-26dB EBW (kHz)	Verdict
GSM1900	512	1850.2	247.392	316.669	PASS
GSM1900	661	1880	243.068	320.853	PASS
GSM1900	810	1909.8	241.235	314.366	PASS
GPRS1900	512	1850.2	240.540	314.298	PASS
GPRS1900	661	1880	243.824	314.319	PASS
GPRS1900	810	1909.8	248.679	318.552	PASS
EGPRS1900	512	1850.2	248.581	315.435	PASS
EGPRS1900	661	1880	247.596	312.735	PASS
EGPRS1900	810	1909.8	250.880	324.609	PASS

GSM1900 Channel=512

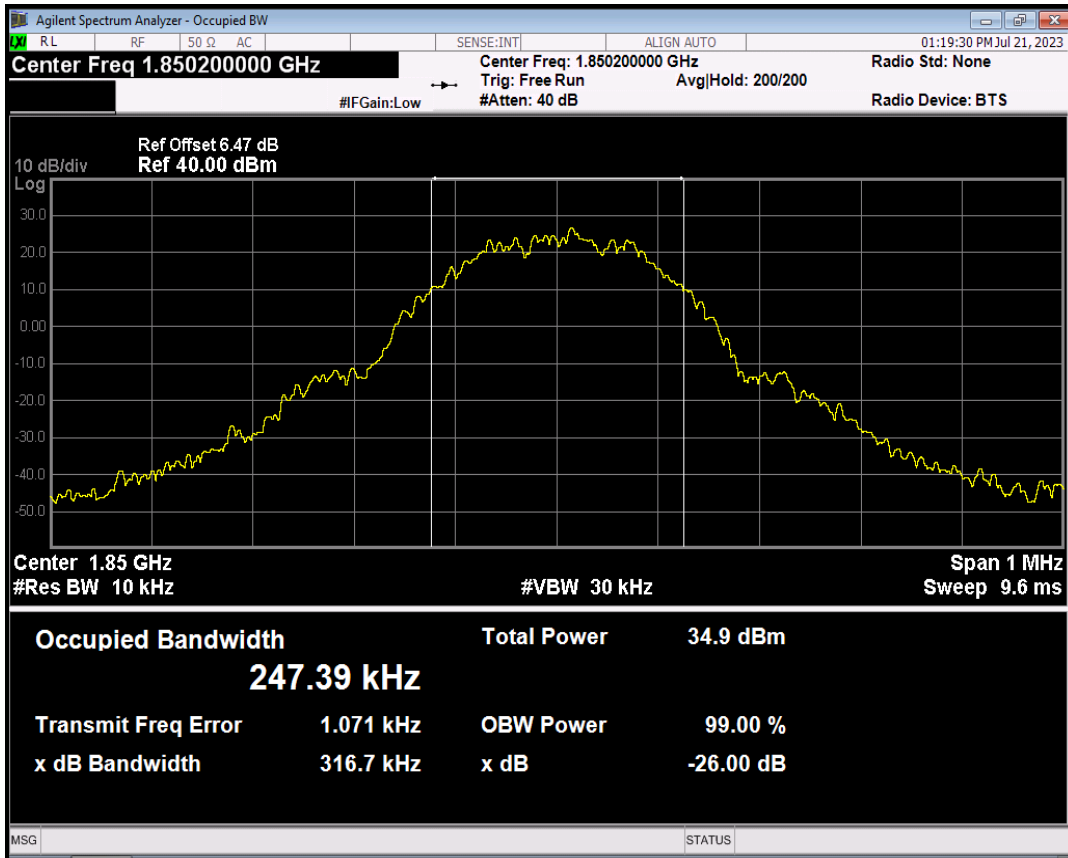

GSM1900 Channel=661

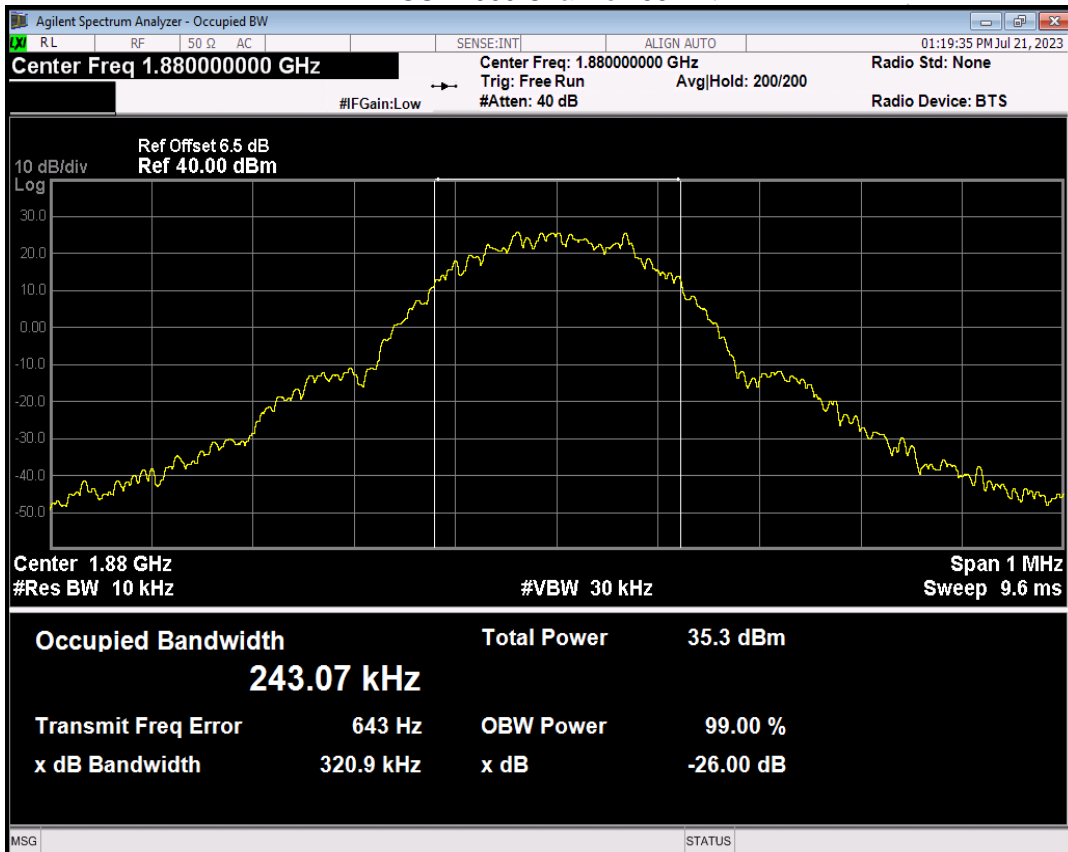

GSM1900 Channel=810

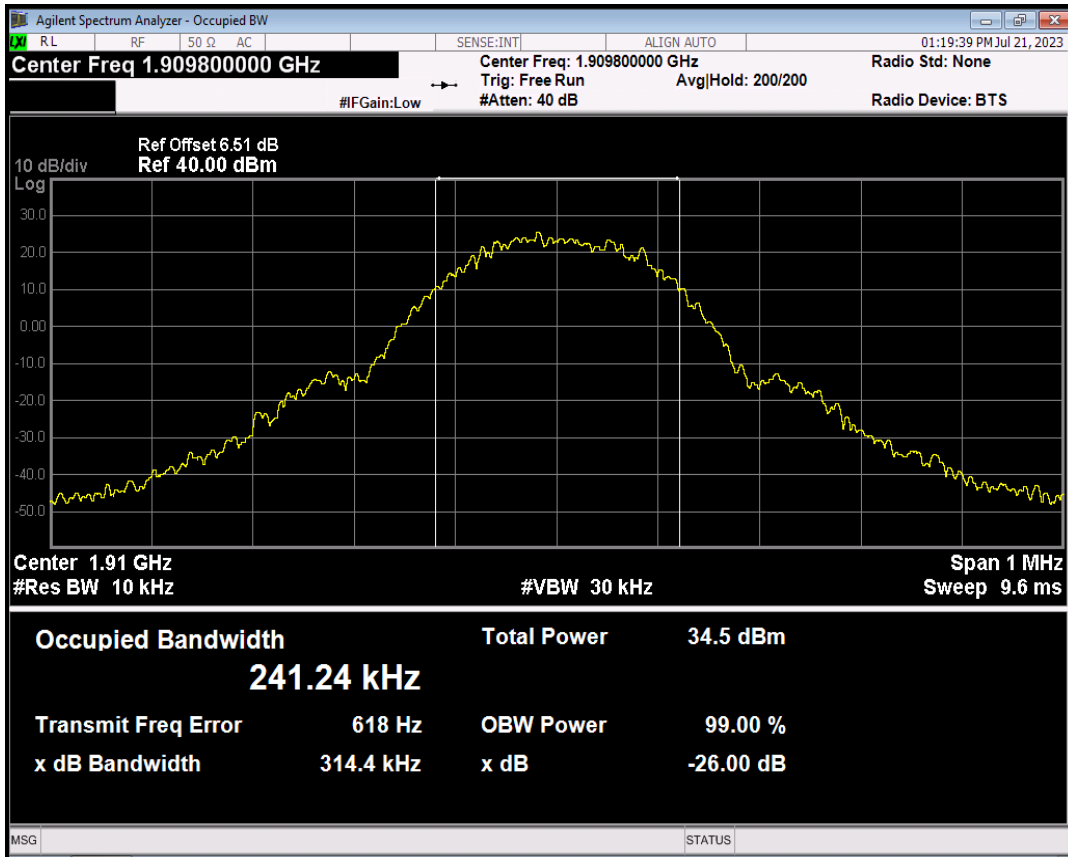

GPRS1900 Channel=512

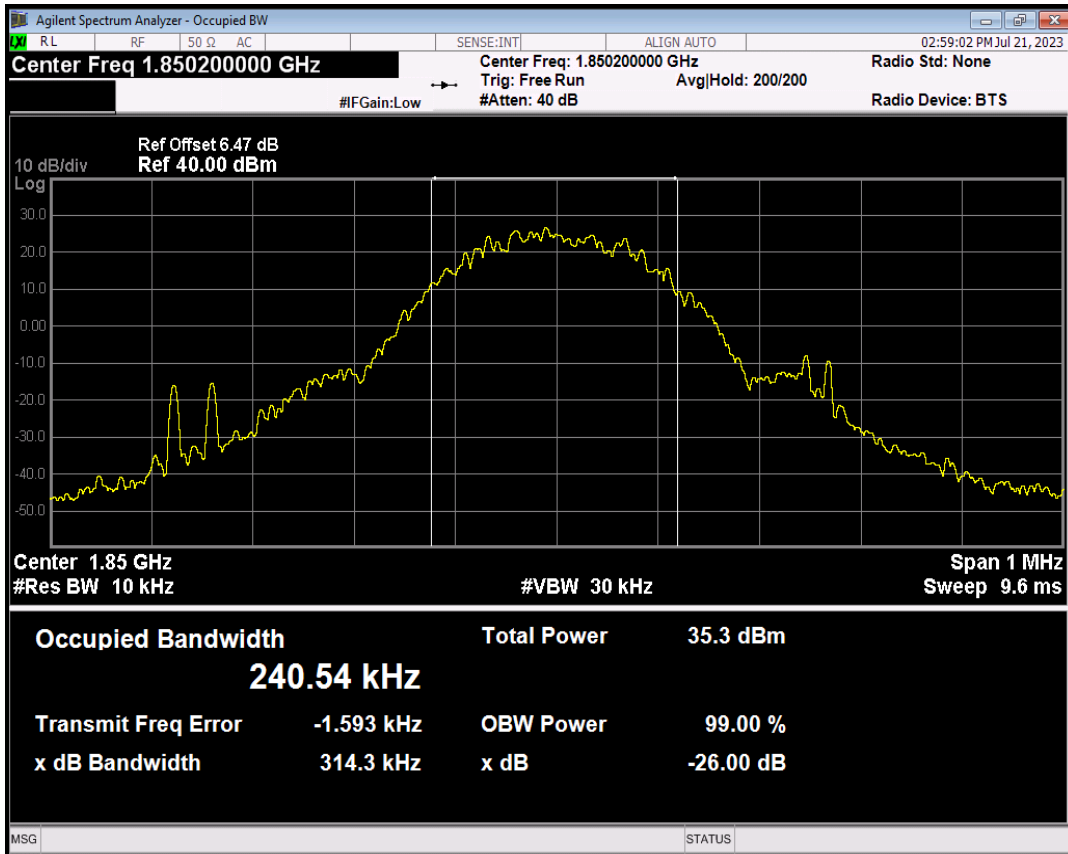

GPRS1900 Channel=661

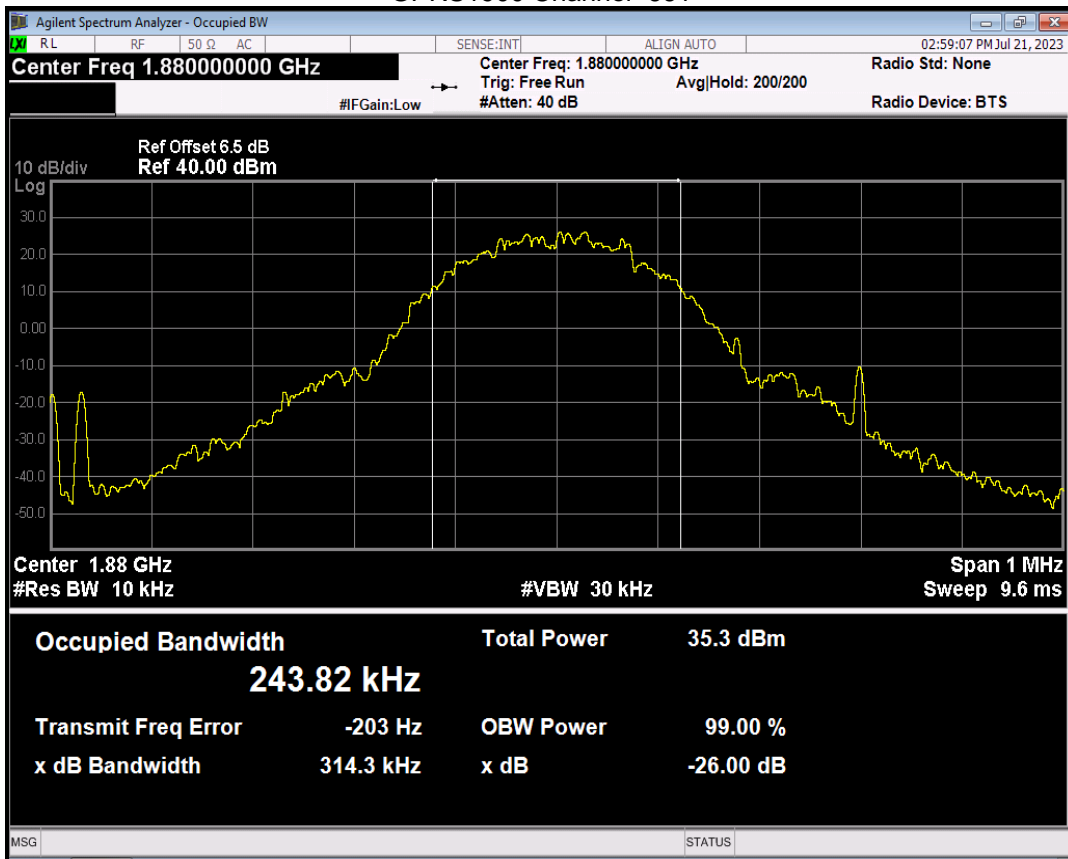

EGPRS1900 Channel=512

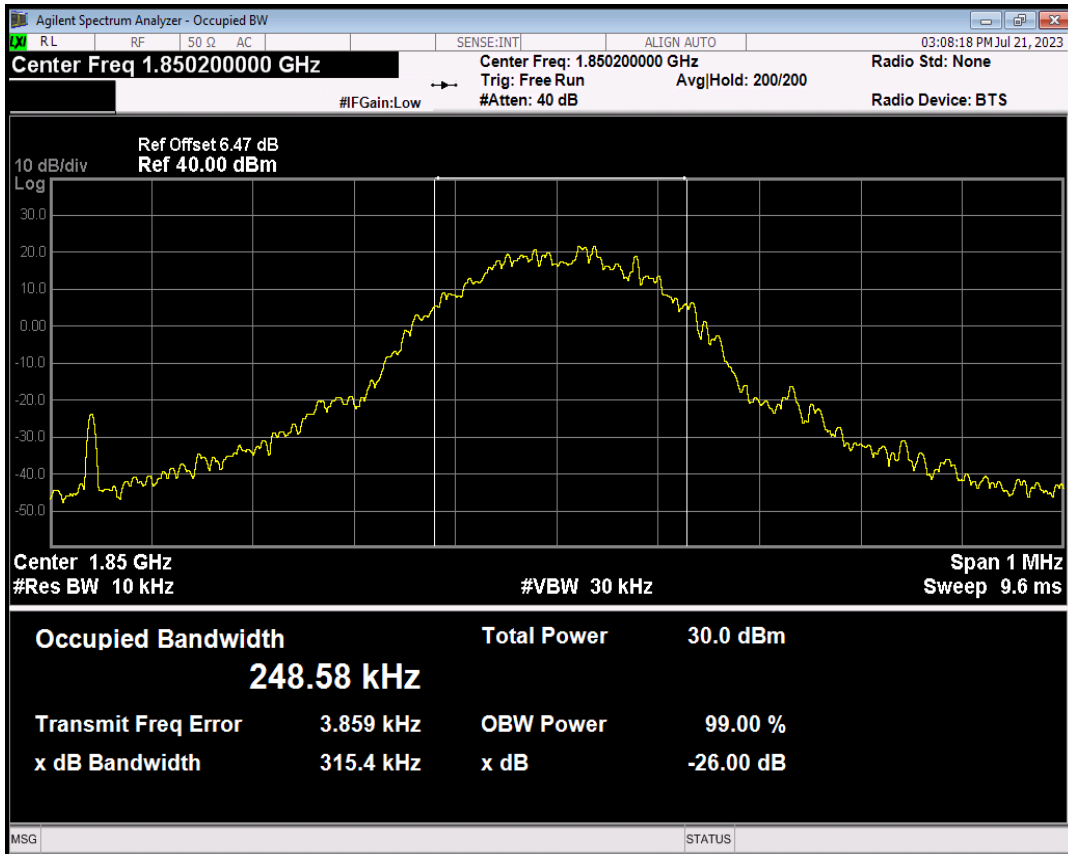

EGPRS1900 Channel=661

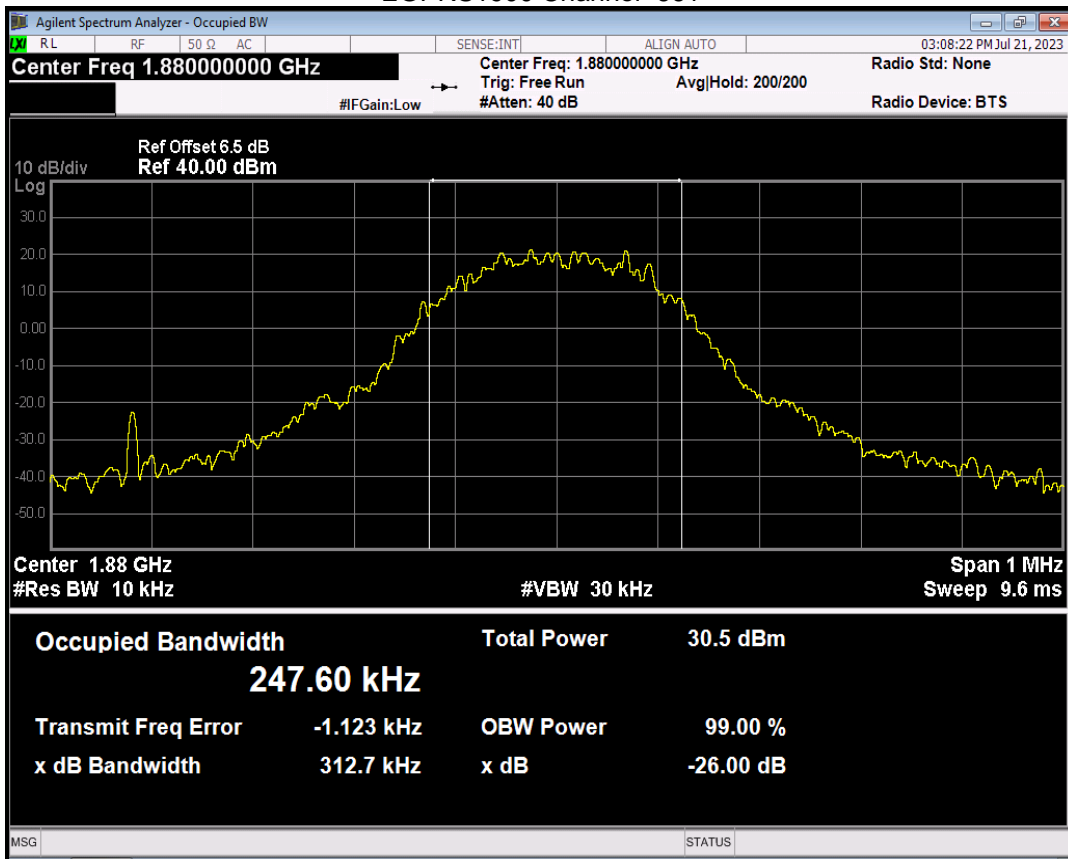

EGPRS1900 Channel=810

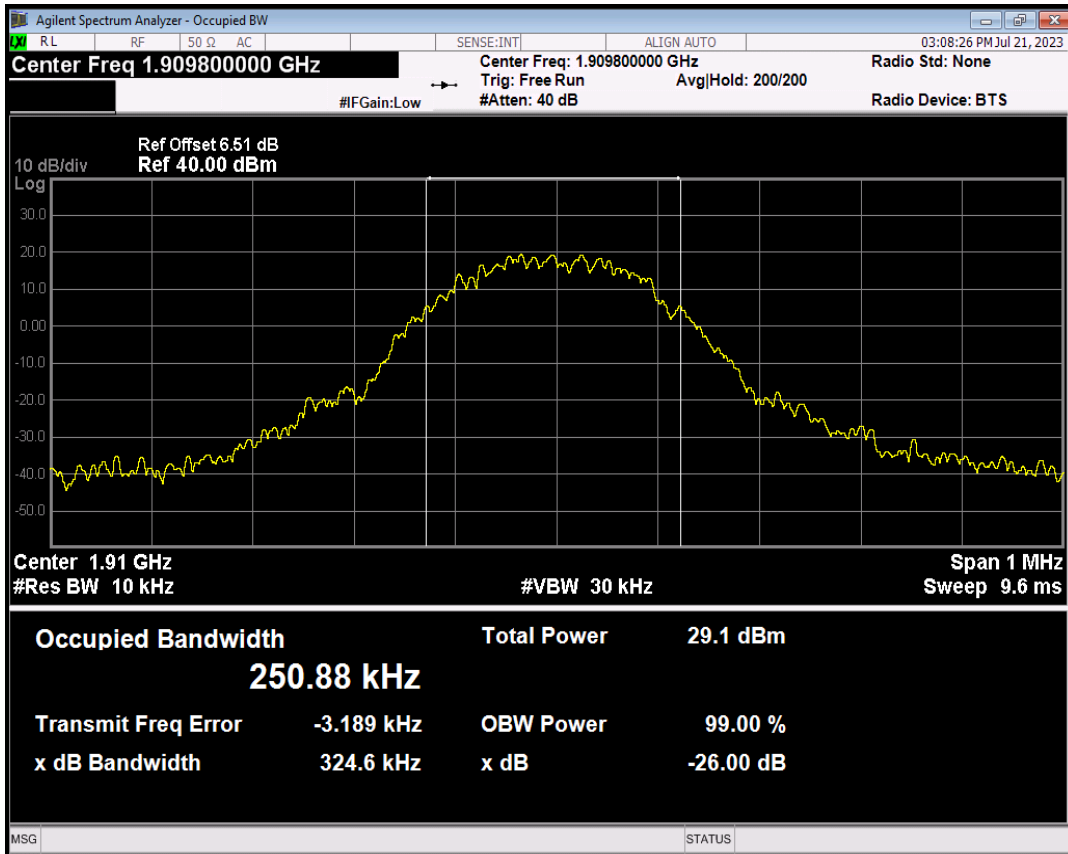

Band	Channel	Frequency (MHz)	99% OBW (kHz)	-26dB EBW (kHz)	Verdict
WCDMA Band2	9262	1852.4	4165.481	4674.675	PASS
WCDMA Band2	9400	1880	4156.411	4679.075	PASS
WCDMA Band2	9538	1907.6	4149.726	4695.182	PASS
WCDMA Band4	1312	1712.4	4156.365	4670.810	PASS
WCDMA Band4	1450	1740	4145.683	4676.940	PASS
WCDMA Band4	1513	1752.6	4155.751	4672.113	PASS
WCDMA Band5	4132	826.4	4150.985	4660.257	PASS
WCDMA Band5	4182	836.4	4182.978	4684.799	PASS
WCDMA Band5	4233	846.6	4152.321	4648.760	PASS

Note: In WCDMA, RMC, HSDPA and HSUPA all three tests only reflect the worst mode RMC.

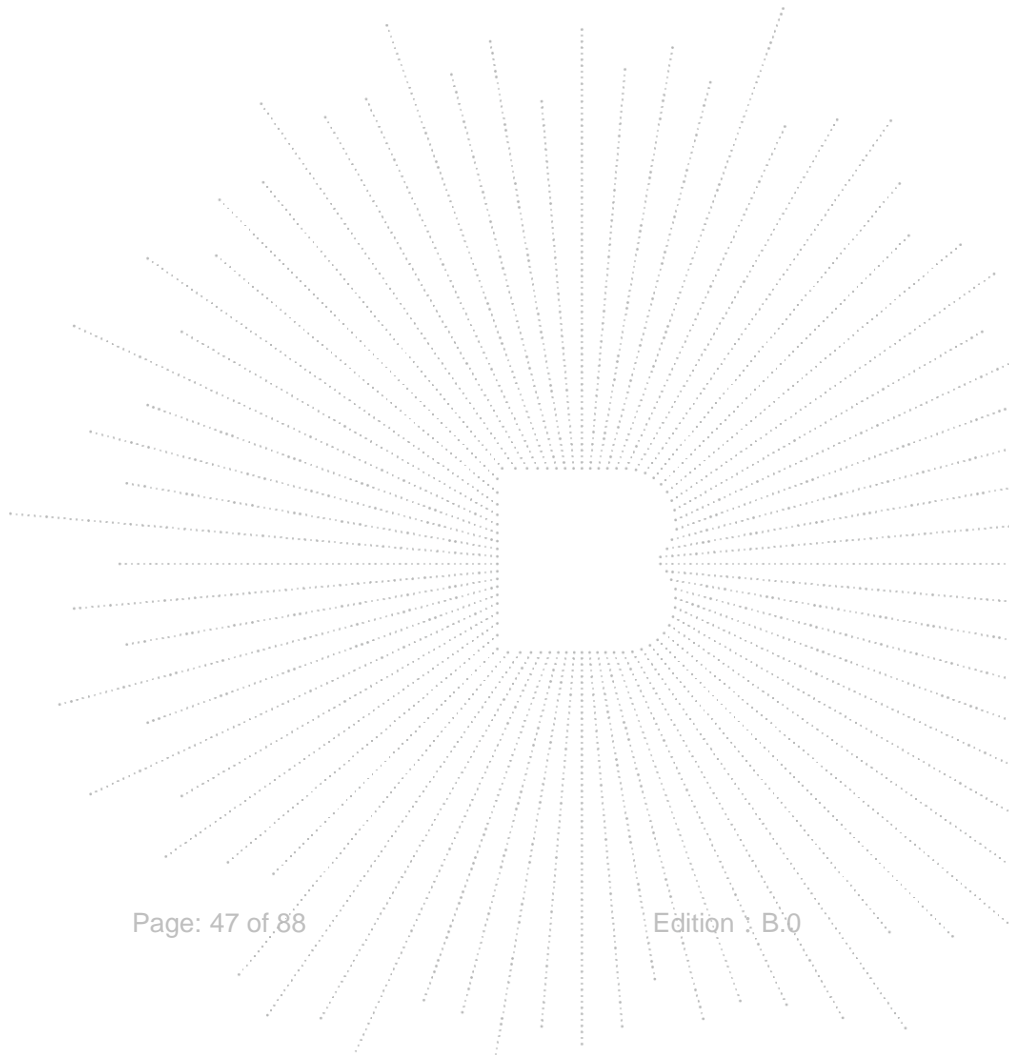

WCDMA Band2 Channel=9262

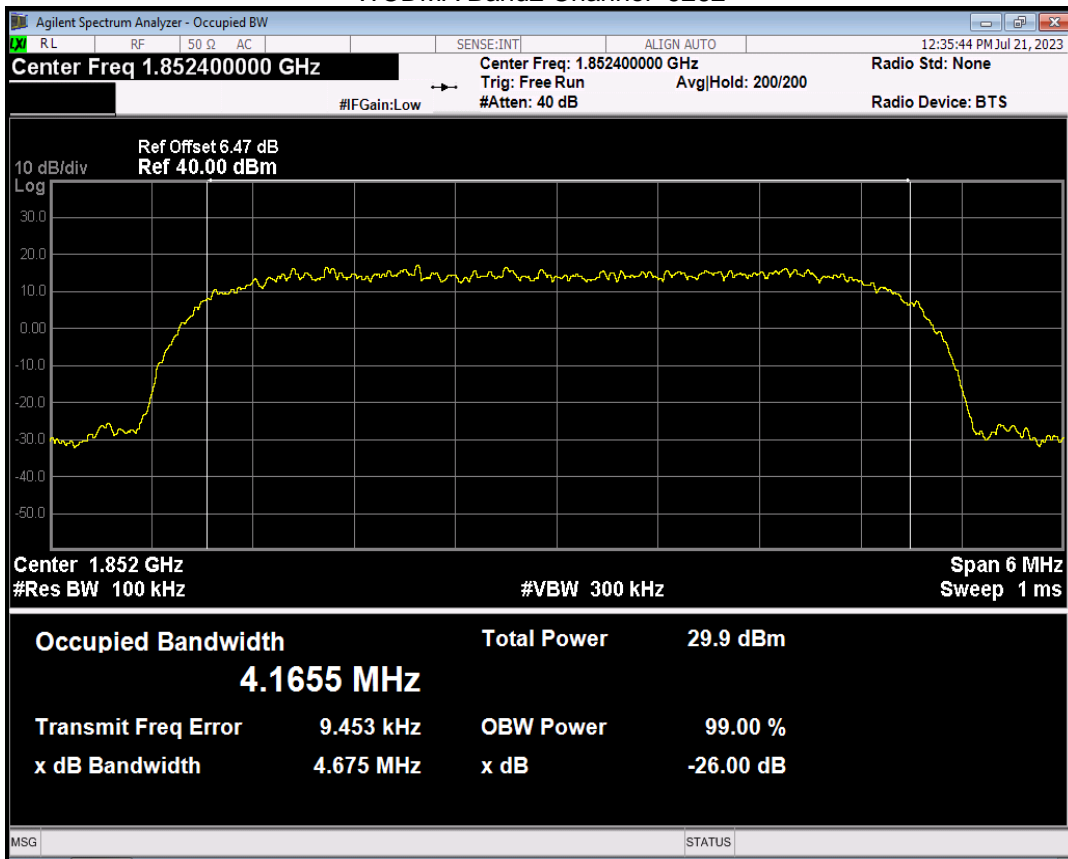

WCDMA Band2 Channel=9400

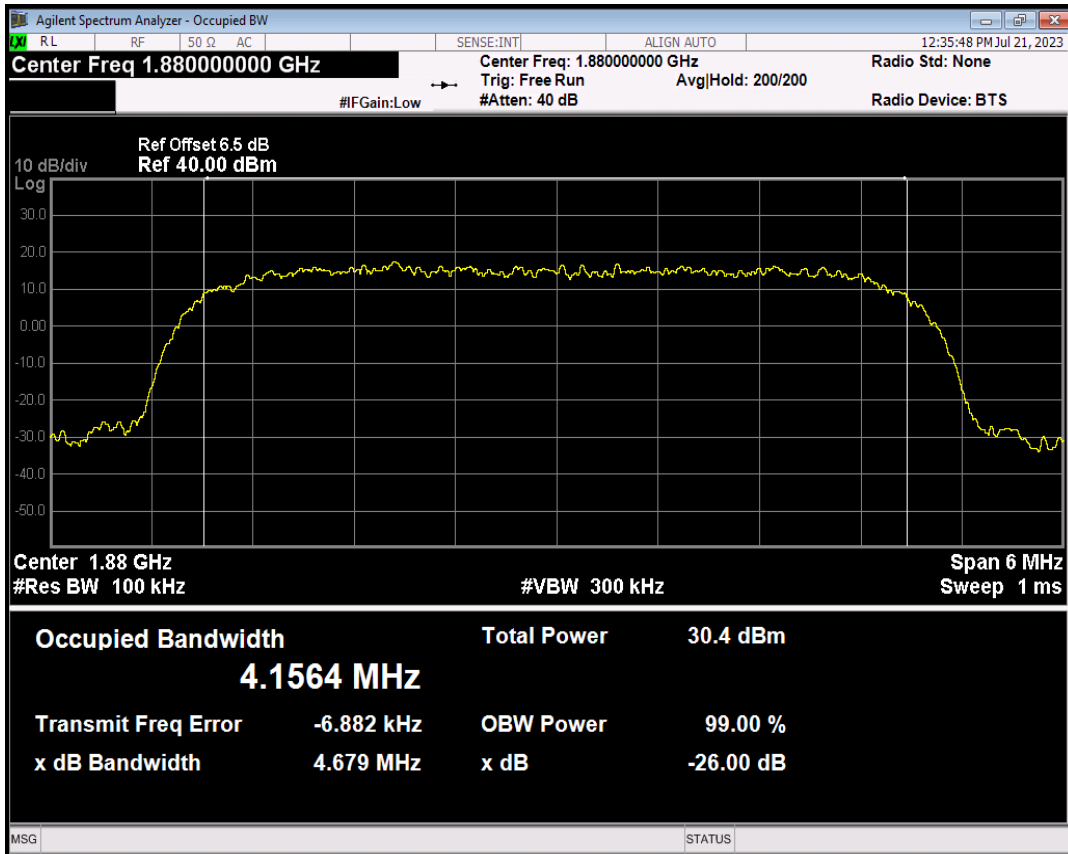

WCDMA Band2 Channel=9538

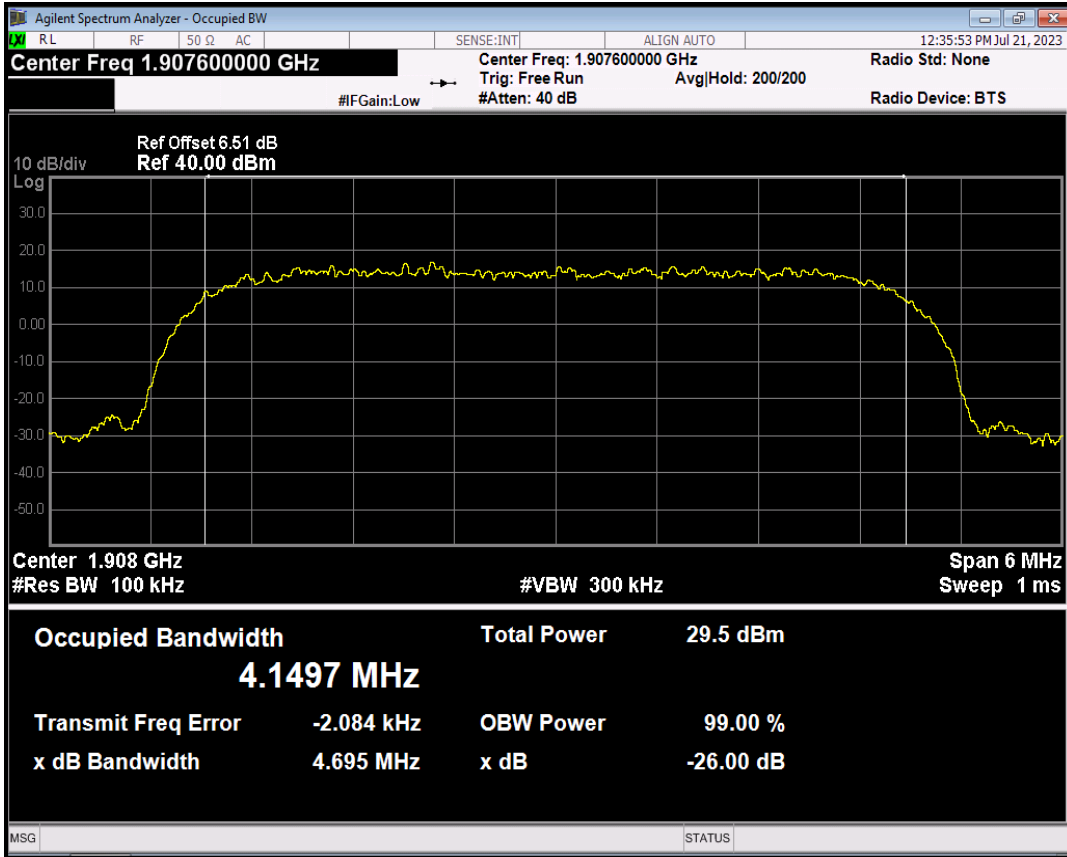

WCDMA Band4 Channel=1312

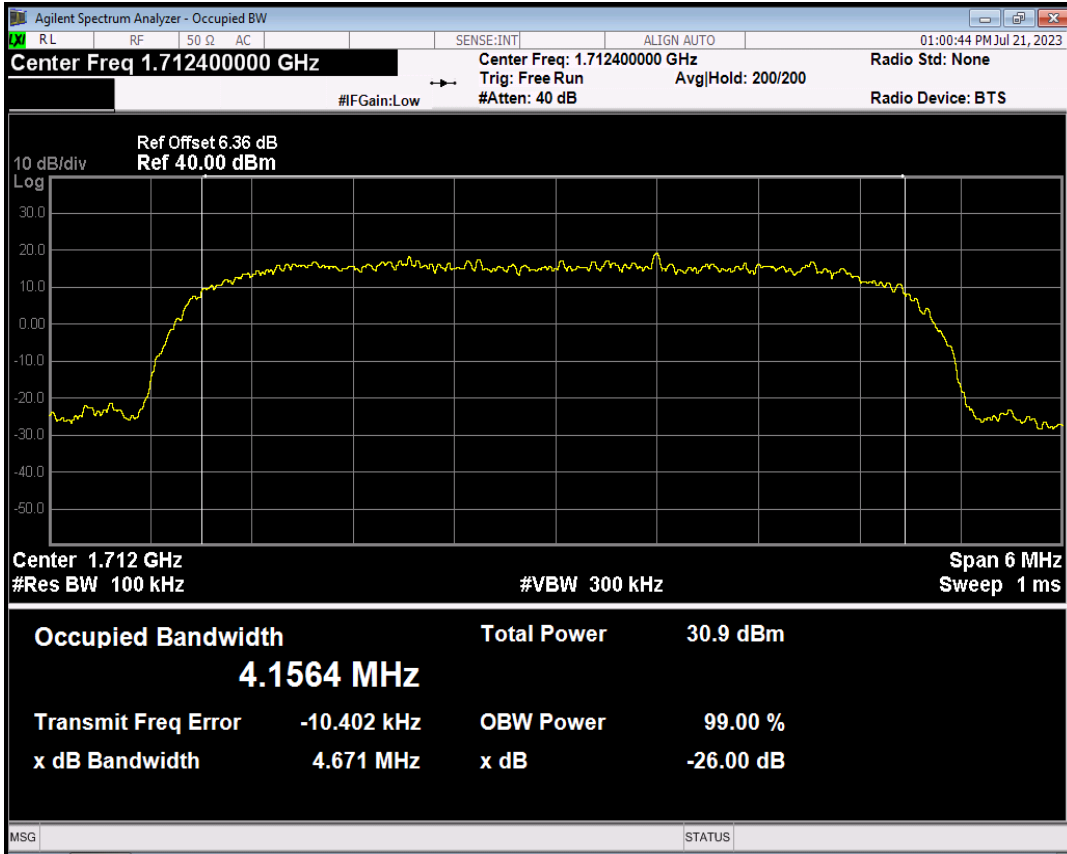

WCDMA Band4 Channel=1450

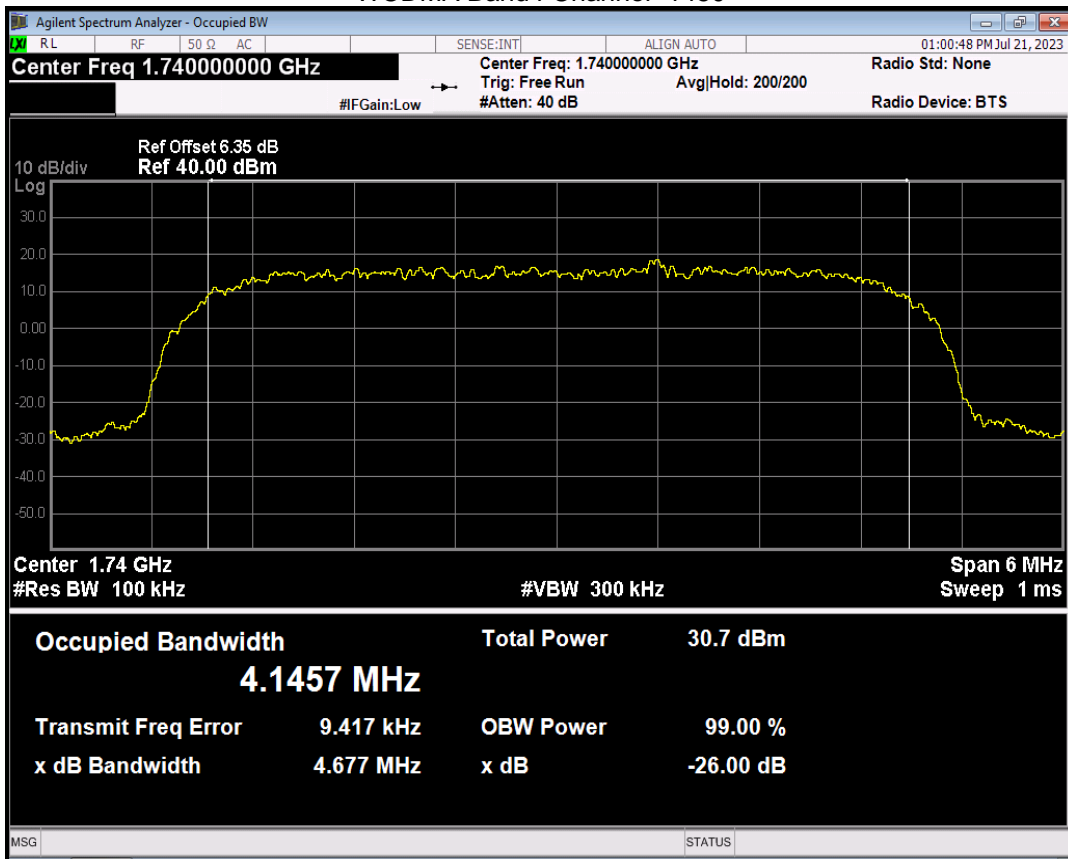

WCDMA Band4 Channel=1513

