

QUICK GUIDE

T1 LED Projector

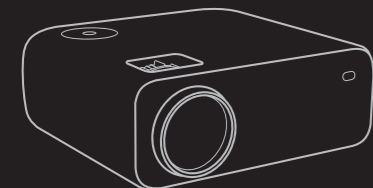

RG1 IEC 62471-5:2015

English

STATEMENT

The projector is product grade A, in living environment the projector may cause wireless disturbance, may be users should do something effectively to the disturbance.

Warning High brightness lamp!
Avoid staring or directly looking at the light especially for children.

Tips
1. Please wash the anti-dust mesh once a month in order to protect your projector!
2. Before using this machine, please remove the protective membrane from the top & bottom cover.

"The Adopted Trademarks HDMI, HDMI High-Definition Multimedia Interface, and the HDMI Logo are trademarks or registered trademarks of HDMI Licensing Administrator, Inc. in the United States and other countries."

Please read this <GUIDE> carefully before use; The company reserves the right of final interpretation; Appearance of the product and the UI please in kind prevail; If product technology or software upgrades, without prior notice.

1 Notice

* How to use the projector correctly:

- 1 When the projector is working, do not look directly at the lens, because the strong light will damage your eyes.
- 2 Do not cover or block the vents, because the inability to dissipate the heat will cause damage to the electronic components inside the projector.
- 3 Do not use chemicals, cleaner or water to clean, and also avoid rain, moisture and leucocratic liquid to corrode circuit board.
- 4 Please put the projector and accessories on the place that children can not reach.
- 5 Please make sure the projector working environment is dry and windy.
- 6 Do not place projector in too warm or too cold room, the high temperature or low temperature will shorten lifespan of the device. The working environment would be 5°C~35°C better.
- 7 Do not put the projector in heating equipment (drying machine, microwave oven) to make it dry.
- 8 Do not press hard or put something heavy on the projector, it will damage projector.
- 9 Do not throw, beat, shake projector, it will damage circuit board in it.
- 10 Do not dismount projector. Please contact after-sales service if you have any problem.
- 11 Do not fix by yourself. If projector can not work normally, please consult with after-sales service or depot repair.

* How to clean the dust screen:

- 1) Pull out the dust screen as shown in Figure 1-3.
- 2) Rinse the dust screen with water and air-dry it in a well-ventilated place.
- 3) Install the clean dust screen in place.

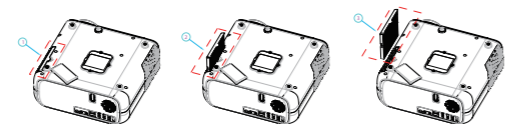

2 Product Overview

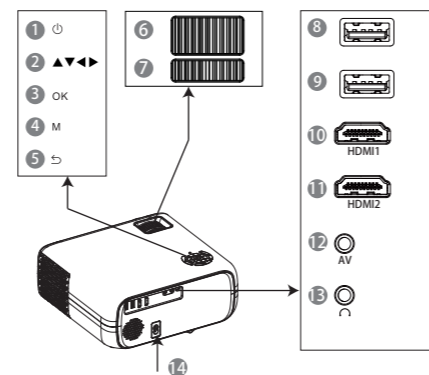

Note: Please refer to the product appearance, this figure is for reference only.

- 1 Power
- 2 Arrow Keys
- 3 Confirm
- 4 Menu Button
- 5 Back
- 6 Lens Focussing
- 7 Keystone Correction
- 8,9 Multimedia Input
- 10,11 Video HD Input
- 12 Audio, Video Input
- 13 Earphone/3.5mm Audio Out
- 14 Power Input(110-240V)

3 Remote Control

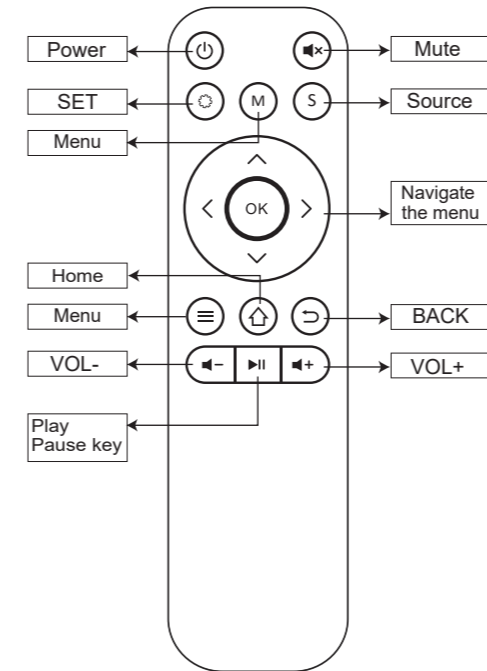

4 Power

- 1: Plug the power cord into a power outlet.
- 2: Press the button "⏻" on the projector or on the remote control.

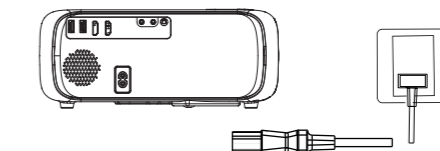

Keystone Correction

Adjust the keystone correction to find the ideal angle of the projection presentation, and it will show the perfect squared image.

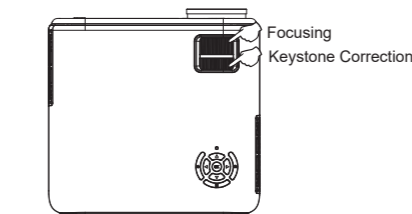

Note: Please refer to the product appearance, this figure is for reference only.

Image focus

Let projector be perpendicular to wall, with the Focusing button to make the picture clear. When focusing, you can broadcasting programs to help you finish focus.

5 Connecting

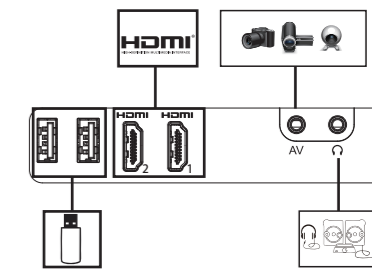

1. Signal source selection

Press the remote control signal source key "S", enter the signal source menu interface. Use the direction key and the confirmation key to select the signal source.

2. HDMI equipment connecting

- 1 HDMI interface can be connected with the computer and other with VGA HDMI output interface devices.
 - 2 Choose the media signal channel : "HDMI".
- Add: Different brand laptop output keys are as follows:

Lenovo	Fn+F3	Fujitsu	Fn+F10
Dell	Fn+F8	Haier	Fn+F3
HP	Fn+F4	NEC	Fn+F3
ThinkPad	Fn+F7	Panasonic	Fn+F3
Asus	Fn+F8	Sharp	Fn+F5
Acer	Fn+F5	Hitachi	Fn+F7
Samsung	Fn+F4	TOSHIBA	Fn+F5
Sony	Fn+F7		

Users of Windows 7 or above. Simply press the +P, select "copy" to connect. If the operation above is invalid, Please update computer graphics driver.

3. AV video equipment connecting

- 1 Use the 3in 1 video tieline comes with projector to connect with AV.
- 2 Choose the media signal channel "AV".

4. 3.5mm audio equipment connecting support 3.5mm earphones and other cable sound equipment.

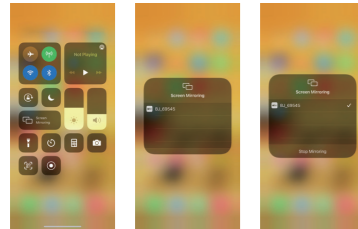

6 Screen Mirroring(iOS)

1. Please make sure your iOS device and projector are under the same Wi-Fi network.
2. For models after iPhone X or iOS 13 or later: Swipe down from the upper-right corner of the screen. For models before iPhone 8 or iOS 11 or earlier: Swipe up from the bottom edge of the screen.
3. Tap  Screen Mirroring, then tap the device with name matches on this screen



7 Screen Mirroring(Mac)

Mac computer:

1. On your Mac, click  in the menu bar at the top of your screen. If you don't see , go to Apple menu > System Preferences > Displays, then select "Show mirroring options in the menu bar when available."
2. Then tap the device with name matches on this screen.



Note: Make sure to connect projector and iPhone to the same WiFi network (or the same WiFi hotspots).

8 Screen Mirroring(Android CastPlay)

CastPlay:

This function could make projector and Android phone/Android Pad share the same screen.

Use CastPlay(projector & phone).

Step 1: projector, settings → WLAN → turn on the WIFI (don't connect the network) → Press "Cast Play on interface";

Step 2: Android phone (such as XIAOMI), turn on WIFI, setting → other connection → WLAN display;

Step 3: Tap the invitation acceptance button showed up on the projection screen during the connection.



Different brand and models of Android phones have different setting paths.

The name of Cast Play will be different, such as media output / projection screen / multi-screen interactive etc.

9 Maintenance and Simple Troubleshooting of Projector

Smart projector is a high-tech product integrating precision optics, electronics and machinery.

The improper maintenance of the projector during the daily use will affect its service life and effects.

For the maintenance, important attention shall be paid to:

1. Dust prevention: Excessive dust will affect the heat dissipation of the projector due to environmental impact. It is suggested to clean its dust filter for one and half months according to the actual environment.

2. Ventilation: As the projector integrates the sound & photo-electricity, the optical source will produce heat during its operation. Therefore, during the installation and use, it shall be ensured that no objects around will block the air inlet and outlet of the projector as the heat dissipation depends on cold air convection to improve its working stability and service life.

3. Lens maintenance: Lens, as the core component of the projector, is directly related to the picture definition and effect. The excessive dust thereon will affect image quality. The dirty lens shall be wiped with soft cotton cloth for the glass lens surface. Hard cloth or abrasives shall not be used.

4. Cleaning: Excessive dust on the projector surface shall be cleaned in a timely manner, as it will affect the heat dissipation.

5. Moisture protection: The projector is vulnerable to the damp air. Its operating humidity is about 45%-60%. The too damp air will affect its working stability.

6. Vibration prevention: The projector shall be strictly protected from strong impact, extrusion and vibration. Try not to move and knock the projector during its normal operation, which will cause the internal circuit faults.

7. The projector shall not be installed on the unstable, shaking and uneven desk.

8. The container with liquid shall not be placed on the projector.

9. The power shall be switched off or the power cord shall be unplugged when not in use.

10. The image is not clear.

1) Check whether there is an appropriate angle between the Projector and projection screen. Place the Projector at a distance of 1.5m~4.2m from the projection screen.

2) Check whether the lens of the Projector is clean. If the lens is dirty, wipe it gently with lens paper.

3) Check whether the lens is pulled beyond the body of the Projector. Uncover the lens and pull it to an appropriate position beyond the body of the Projector.

4) Check whether the focus is adjusted correctly. Rotate the lens to adjust the focus until the image becomes clear.

5) Check whether the correct image signal format is selected. Make sure the video and image settings on the PC are identical with those on the Projector.

6) Check whether the output resolution of the signal source device is HD.

11. Image Distortion or Interference

1) Check whether an extension cord is used. If an extension cord is used, the circuit interference may affect the input signal. Please use a shielded cable instead.

2) The wall or curtain is uneven.

12. Poor Image Color (greenish or reddish)

1) Check whether the color is adjusted correctly. Adjust the color through the MENU button on the Projector or remote control. The contrast may also need to be adjusted.

13. The Projector stops working suddenly.

The Projector overheats, so the overheat protection is activated.

1) Check whether the fan is running properly.

2) Check whether the air vents of the Projector are covered.

14. The remote control is not sensitive or does not work.

Check whether the battery of the remote control needs to be replaced. Replace the battery with a new one (of the same type).

15. Android Projection Failure

1) Check whether your Android phone supports the projection function.

2) Restart the Android projection App on the Projector.

3) Check whether the WiFi function is enabled on the Projector.

16. iPhone Projection Failure

1) Check whether your iPhone and the Projector are on the same network.

2) Restart the iPhone projection App on the Projector.

3) Check whether the WiFi function is enabled on the Projector.

17. No Sound Output

1) No sound is output from the built-in speaker of the Projector.

a) Adjust the volume to the highest level.

b) The current audio format is not compatible with the Projector. Please change the video source.

c) Check whether the Bluetooth mode is activated. Please switch to the normal mode.

d) The Bluetooth speaker is not connected reliably, or not compatible with the Projector. Please restart or replace the Bluetooth speaker.

10 Warranty Certificate

Thanks for purchasing our product! We'll do our best to provide you good service.

We offer the owner of this product ___ months warranty from the date of purchase.

Defects that occur within this warranty period under normal use and care can get related warranty service. If your product is faulty or you are experiencing difficulties to use this product and require assistance, please also contact with your local dealers or authorized also contact with your local dealers or authorized after service center for help.

The warranty does not cover:

1) Any product that has not been installed, operated or maintained in accordance with the manufacturer's operating instructions provided with the product.

2) Any accidental damage, damage due to mishandling or abuse, lack of reasonable care, tampering or attempted repair by unauthorized persons.

3) Any fluctuation in voltage or modification/adjustments made to comply with local voltage requirements broadcast system and other safety or technical standards.

4) If the return is not caused by the product quality problem, you need to bear the freight caused by the return.

Warranty Card

Product information

Model No.: Serial No.:

Date of purchase:

Dealer's Stamp: Barcode:

Order No.:

Customer details

Name:

Address:

Tel.No.:

Email:

FCC compliance statement

This device complies with Part 15 of the FCC Rules. Operation is subject to the following two conditions: (1) this device may not cause harmful interference, and (2) this device must accept any interference received, including interference that may cause undesired operation.

changes or modifications not expressly approved by the party responsible for compliance could void the user's authority to operate the equipment.

This equipment has been tested and found to comply with the limits for a Class B digital device, pursuant to Part 15 of the FCC Rules. These limits are designed to provide reasonable protection against harmful interference in a residential installation. This equipment generates, uses and can radiate radio frequency energy and, if not installed and used in accordance with the instructions, may cause harmful interference to radio communications. However, there is no guarantee that interference will not occur in a particular installation.

If this equipment does cause harmful interference to radio or television reception, which can be determined by turning the equipment off and on, the user is encouraged to try to correct the interference by one or more of the following measures:

-- Reorient or relocate the receiving antenna.

-- Increase the separation between the equipment and receiver.

-- Connect the equipment into an outlet on a circuit different from that to which the receiver is connected.

-- Consult the dealer or an experienced radio/TV technician for help.

FCC Radiation Exposure statement

This equipment complies with FCC radiation exposure limits set forth for an uncontrolled environment. This equipment should be installed and operated with minimum distance 20cm between the radiator and your body. This transmitter must not be co-located or operating in conjunction with any other antenna or transmitter.