

# DATA SHEET

● <b>Product Type</b>	● <b>WLAN / Antenna</b>
● <b>Model Name</b>	● <b>10N</b>
● <b>Revision</b>	● <b>R04</b>
● <b>Part No. / Customer</b>	● <b>5060-000000+101</b>
● <b>Part No.</b>	● <b>T-543-9291042-1</b>

<b>2.4GHz~5GHz Multiple Bands Antenna for WLAN Applications</b>	<b>Part Number: T-543-9291042-1</b>		R01	<b>May. 02, 2014</b>
			R02	<b>Dec. 29, 2014</b>
			R03	<b>Feb. 11, 2015</b>
			R04	<b>Jun. 08, 2015</b>
BY	<b>Grace Chen</b>	DATE	<b>Jun. 09, 2015</b>	
<b>Address :</b> 3F. NO. 382. Sec 1, Wenxing Rd., Zhubei City, Hsinchu County, Taiwan(R.O.C)				
<b>Phone Number :</b> +886-3-6683052				

# 1.Specifications

## 1.1 Specification of WLAN Antenna

Frequency Range (GHz)	2.40GHz~2.50GHz for WLAN Antenna 5.15GHz~5.85GHz for WLAN Antenna
VSWR	2.0 : 1 max for WLAN Antenna
Impedance	50Ω Nominal.
Radio Connector	I-Pex or equivalent
Coaxial Cable	SY or equivalent
Antenna Dimension	25*8.5*0.4mm
Cable Information	Black = 40mm / 1.13OD
Operating Temperature	-40~90℃
Maximum Power	1W
Polarization	Linear
Radiation Pattern	Omni-directional

## 1.2 Photos of Antenna Product



Black Antenna / (T-543-9291042-1)

## 2. Test Methodology

### 2.1 Test Equipment

The equipment for the antenna measurement we used is as follows:

- A. Network Analyzer, support up to 8GHz, to measure the VSWR and input impedance of antenna.
- B. Three-dimensional anechoic chamber to measure antenna gain and radiation pattern (Standard horn antenna was used to calibrate the chamber)
- C. Digital caliper to measure the dimensions.
- D. Climatic chamber for mechanical tests.

### 2.2 Test Setup

#### 2.2.1 Frequency Range

2.40~2.50GHz, for WLAN application

5.15~5.85GHz, for WLAN application

#### 2.2.2 Antenna Configuration

The antenna basically has two parts; the stamping and the cable assembly with the connector on one side. The detailed drawing is attached.

#### 2.2.3 VSWR

The VSWR is measured with network analyzer that support up to 8GHz. All the measurements are performed with the customer provided fixture. Figure 1 shows the typical schematic diagram for measuring VSWR.

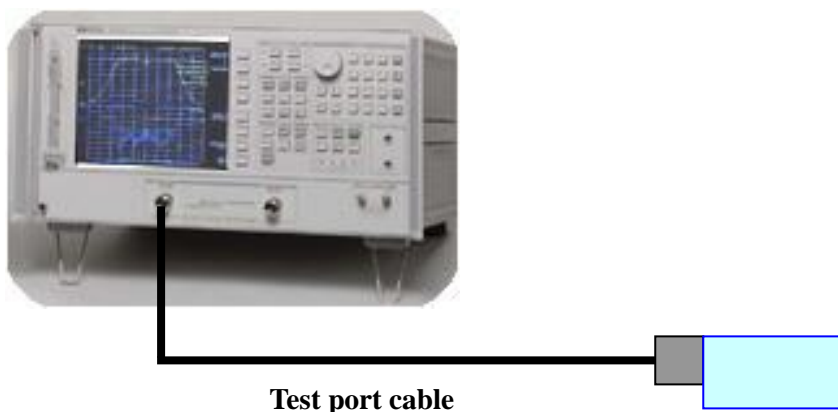

Figure 1. The schematic diagram for measuring VSWR

#### 2.2.4 Radiation Pattern and Gain

The radiation pattern of antenna is measured in both horizontal polarization and vertical polarization. The radiation pattern measurements are performed in the three-dimensional anechoic chamber. The chamber provides less than  $-30\text{dB}$  reflectivity

from 800MHz through 8GHz. The chamber is calibrated using both standard dipole antenna and horn antenna. The Gain here is expressed as dBi that standardizes the isotropic antenna. The Gain measurements and antenna radiation pattern are also performed in the same chamber described previously. Figure 2 shows the schematic diagram for measuring radiation pattern and Gain.

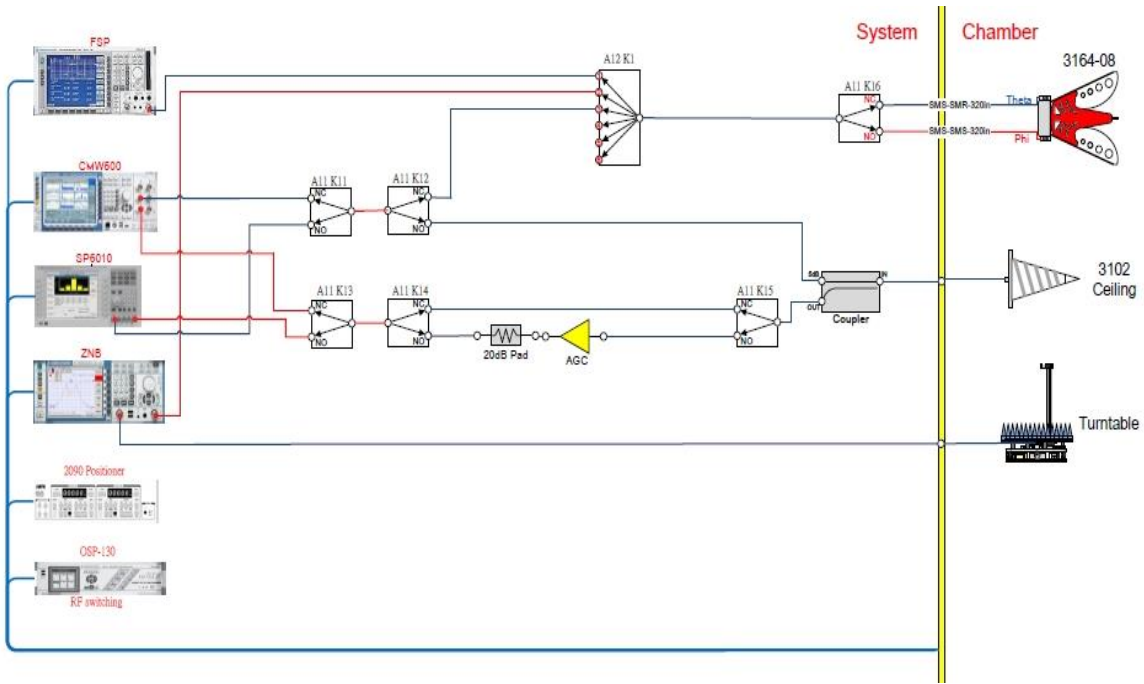
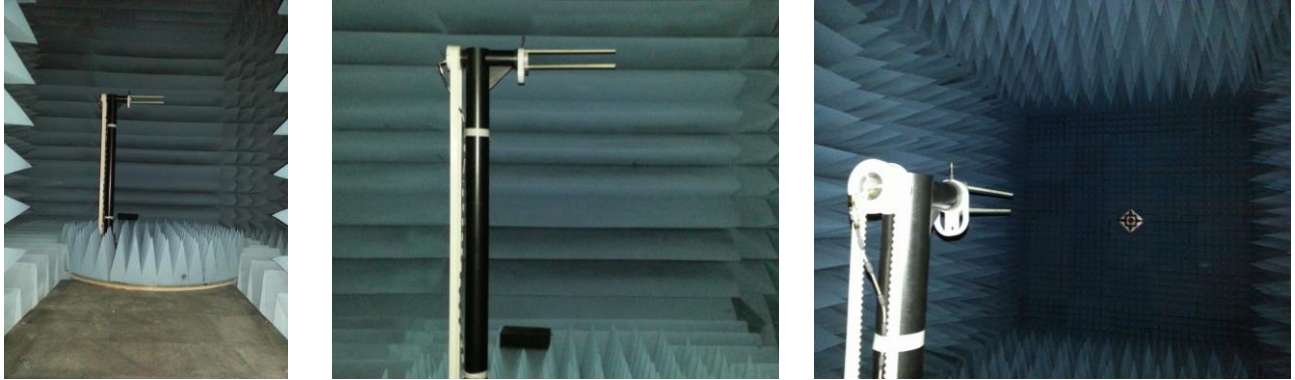
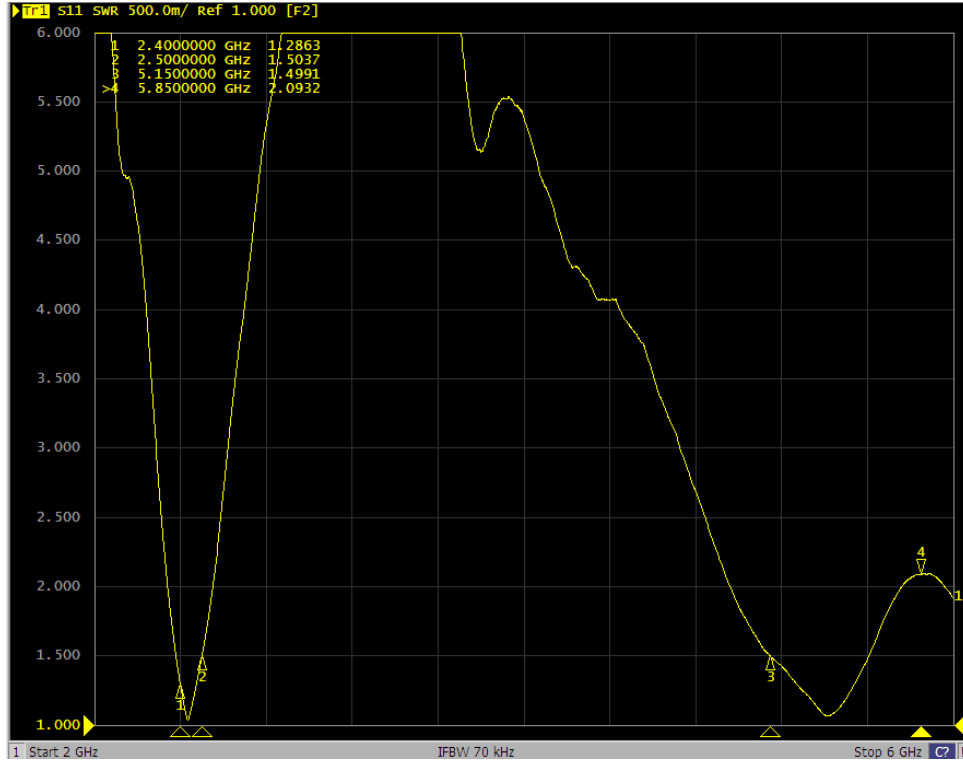

Figure 2. The schematic diagram for measuring radiation pattern and Gain

### 3. Performance Data

#### 3.1 VSWR of Antenna in the Fixture

##### 3.1.1 VSWR of WLAN Black Antenna



### 3.2 Radiation Pattern and Gain

#### 3.2.1 Radiation Pattern & Gain of WLAN Antenna (2.4GHz~5GHz)

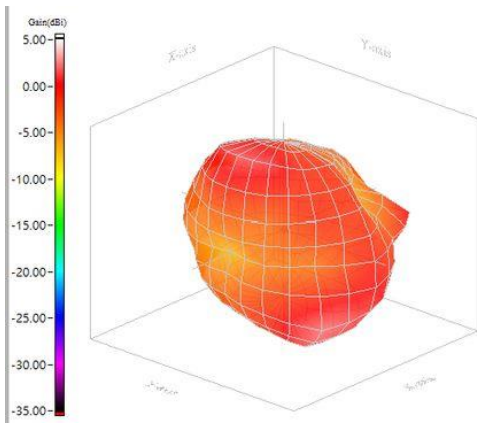

**2.4GHz**

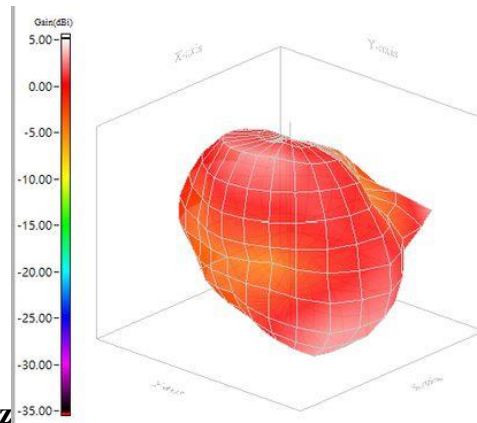

**2.45GHz**

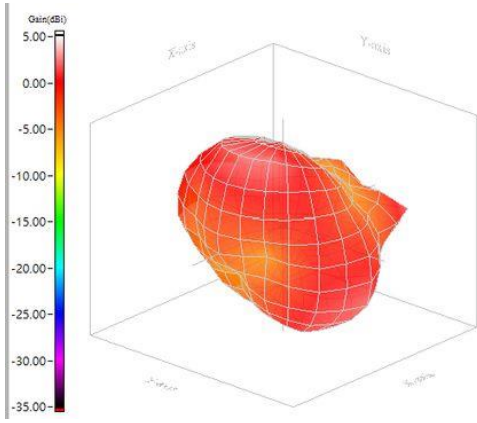

**2.5GHz**

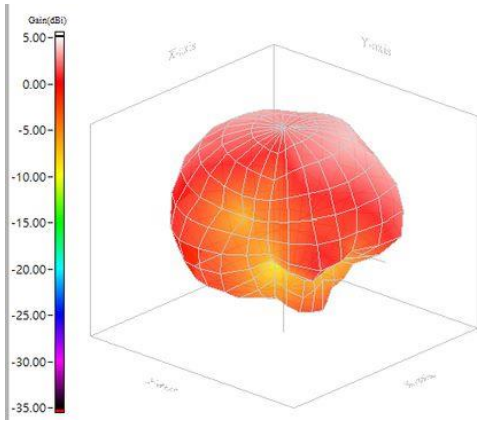

**5.15GHz**

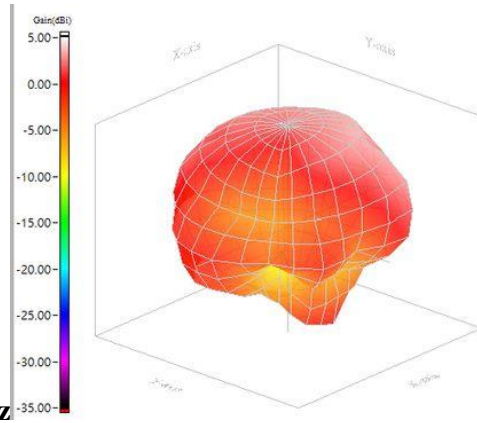

**5.25GHz**

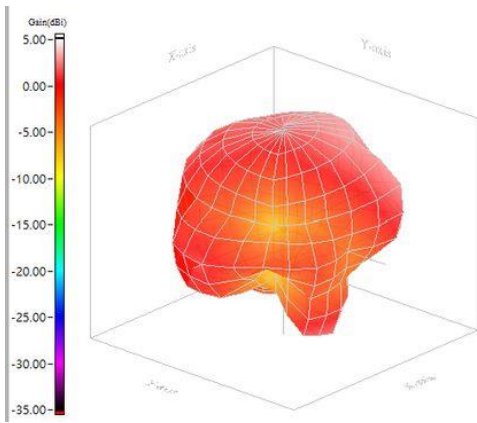

**5.35GHz**

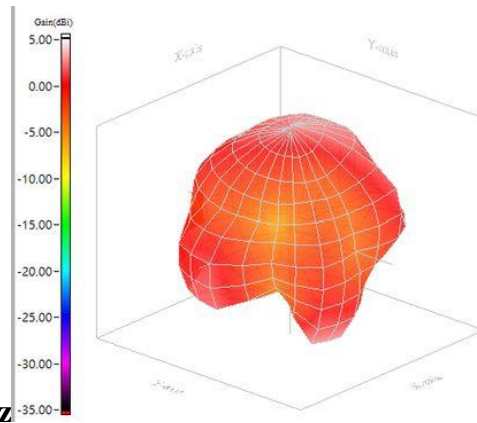

**5.47GHz**

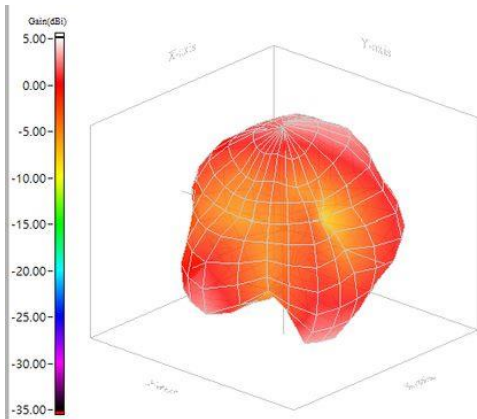

5.6GHz

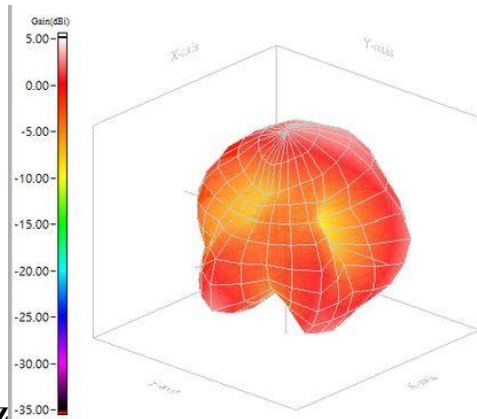

5.725GHz

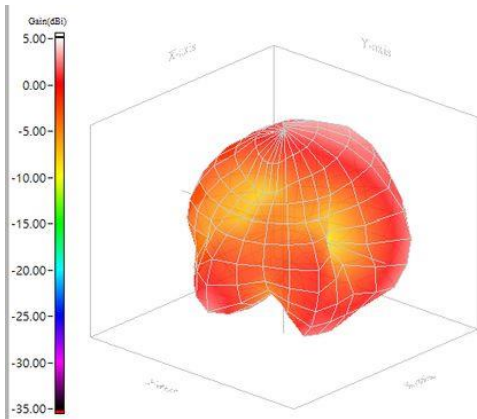

5.785GHz

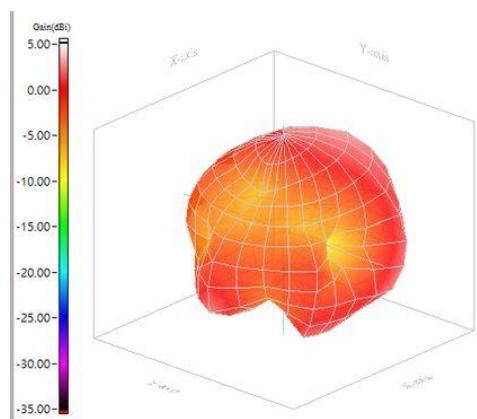

5.85GHz

## Black Antenna

Antenna (Cable color) / Band / Frequency			20140422 WIFI(WIFI+BT) 25x9(mm <sup>2</sup> )-PCB Antenna Gain	
WLAN Aux (White or C)	802.11g	2400	-2.80	52.51%
		2450	-1.65	68.33%
		2500	-2.55	55.56%
	802.11a	5150	-1.28	74.42%
		5250	-1.23	75.29%
		5350	-1.14	76.94%
		5470	-1.46	71.53%
		5600	-1.67	68.04%
		5725	-1.73	67.20%
		5785	-1.84	65.54%
5850	-1.87	65.05%		

## 4. Antenna Drawing

### 4.2 Drawing

#### Black Antenna

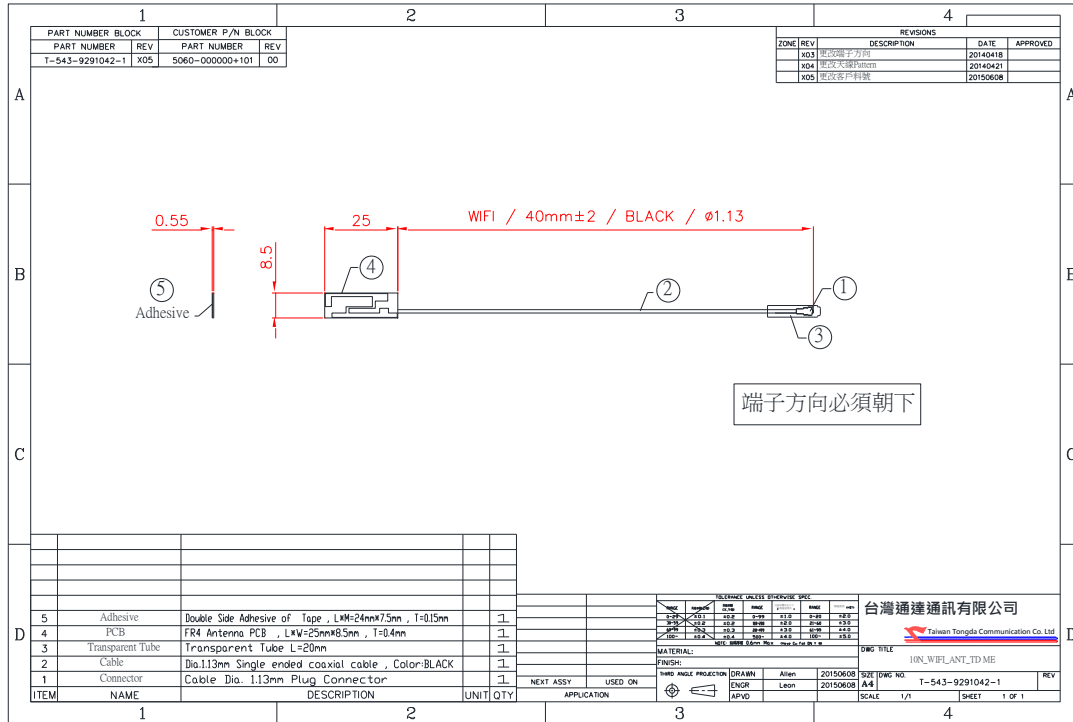

## 5. Reliability Data For Antenna Patch (Reference To IEC / EN)

TEST Items	Limit	Test Method IEC62321:2008	Unit	MDL
Cadmium (Cd)	100	Determination of cadmium by ICP-OES	mg/kg	2
Lead (Pb)	1000	Determination of Lead by ICP-OES	mg/kg	2
Mercury (Hg)	1000	Determination of Mercury by ICP-OES	mg/kg	2
Hexavalent Chromium (Cr-VI)	1000	Determination of Hexavalent Chromium by Colorimetric Method using UV-Vis.	mg/kg	2
PBBS	1000	Determination of PBBs / PBDEs by ICP-OES	mg/kg	5
PBDES	1000	Determination of PBBs / PBDEs by ICP-OES	mg/kg	5



## 6. Ordering Information: Ordering P/N Code

The antennas may be ordered by using the P/N ordering code. These code numbers can be determined by the following rules:

**T – 543 – 929 1042–1**  
 A        B        C        D        E

### A. Company Name

T= Linking

### B. Company Internal Rule

543 = Company BU List

### C. Antenna Function

929 =Antenna Function List

### D. Antenna Project

1032 = Antenna Project List

### E. Antenna Number

1= WLAN Main Antenna

## 7. Revision Control

Revision	Date	Content	Remark
R01	May. 02, 2014	New Issued.	N/A
R02	Dec. 29, 2014	Add Antenna Pattern in Report	N/A
R03	Feb. 11, 2015	Update Antenna Drawing and Customer P/N	N/A
R04	Jun. 08, 2015	Update Antenna Drawing for New Customer P/N	N/A