



Willow Run (WR) Test Labs, Inc.
7117 Fieldcrest Dr.
Brighton, Michigan 48116 USA
Tel: (734) 252-9785
Fax: (734) 926-9785
e-mail: info@wrtest.com

Testing of

Electromagnetic Emissions

per

- USA: CFR Title 47, Part 15.249 (Emissions)
- USA: CFR Title 47, Part 2.1091;2.1093 (Exposure)
- Canada: ISED RSS-210/GENE (Emissions)
- Canada: ISED RSS-102 (Exposure)

are herein reported for

Air Lift Company 72709

Test Report No.: 20170922-RPTAUDI10001Ar0

Copyright © 2017

Applicant/Provider:

Air Lift Company

2727 Snow Road, Lansing Michigan 48917 USA

Phone: (517) 322-2144, Fax: (517) 322-9479

Contact Person: Julian Quick; jquick@airliftcompany.com

Data Recorded by: Joseph Brunett
Dr. Joseph Brunett, EMC-002790-NE

Reviewed by: Joseph Brunett
Dr. Joseph Brunett, EMC-002790-NE

Prepared by: Joseph Brunett
Dr. Joseph Brunett, EMC-002790-NE

Date of Issue: September 22, 2017

Results of testing completed on (or before) March 16, 2017 are as follows.

Emissions: The transmitter intentional emissions **COMPLY** with the regulatory limit(s) by no less than 2.9 dB. Transmit chain spurious or harmonic emissions **COMPLY** by no less than 4.7 dB. Unintentional spurious emissions from digital circuitry **COMPLY** with radiated emission limit(s) by at least 20 dB.

Revision History

Rev. No.	Date	Details	Revised By
r0	September 22, 2017	Initial Release.	J. Brunett

Contents

Revision History	2
Table of Contents	2
1 Test Report Scope and Limitations	4
1.1 Laboratory Authorization	4
1.2 Report Retention	4
1.3 Subcontracted Testing	4
1.4 Limitation of Results	4
1.5 Copyright	4
1.6 Endorsements	4
1.7 Test Location	5
1.8 Traceability and Equipment Used	5
2 Test Specifications and Procedures	6
2.1 Test Specification and General Procedures	6
3 Configuration and Identification of the Equipment Under Test	7
3.1 Description and Declarations	7
3.1.1 EUT Configuration	7
3.1.2 Modes of Operation	7
3.1.3 Variants	7
3.1.4 Test Samples	7
3.1.5 Functional Exerciser	8
3.1.6 Modifications Made	8
3.1.7 Production Intent	8
3.1.8 Declared Exemptions and Additional Product Notes	8
4 Emissions	9
4.1 General Test Procedures	9
4.1.1 Radiated Test Setup and Procedures	9
4.1.2 Conducted Emissions Test Setup and Procedures	11
4.1.3 Power Supply Variation	11
4.1.4 Thermal Variation	11
4.2 Intentional Emissions	12
4.2.1 Fundamental Emission Pulsed Operation	12
4.2.2 Fundamental Emission Bandwidth	13
4.2.3 Fundamental Emission Field Strength	15
4.3 Unintentional Emissions	16
4.3.1 Transmit Chain Spurious Emissions	16
4.3.2 Radiated Digital Spurious	17
4.4 RF Exposure	18
4.4.1 Exposure and Potential Health Hazard	18
5 Measurement Uncertainty	19

List of Tables

1	Test Site List.	5
2	Equipment List.	5
3	EUT Declarations.	7
4	Fundamental Emission Pulsed Operation.	12
5	Fundamental Emission Bandwidth.	13
6	Fundamental Emission Field Strength.	15
7	Transmit Chain Spurious Emissions.	16
8	Electromagnetic Field Exposure.	18
9	Measurement Uncertainty.	19

List of Figures

1	Photos of EUT.	7
2	EUT Test Configuration Diagram.	8
3	Radiated Emissions Diagram of the EUT.	9
4	Radiated Emissions Test Setup Photograph(s).	10
5	Fundamental Emission Pulsed Operation.	12
6	Fundamental Emission Bandwidth.	14

1 Test Report Scope and Limitations

1.1 Laboratory Authorization

Test Facility description and attenuation characteristics are on file with the FCC Laboratory, Columbia, Maryland (FCC Reg. No: 688478) and with ISED Canada, Ottawa, ON (File Ref. No: IC8719A-1 and IC22227-1).

1.2 Report Retention

For equipment verified to comply with the regulations herein, the manufacturer is obliged to retain this report with the product records for the life of the product, and no less than ten years. A copy of this Report will remain on file with this laboratory until September 2027.

1.3 Subcontracted Testing

This report does not contain data produced under subcontract.

1.4 Limitation of Results

The test results contained in this report relate only to the item(s) tested. Any electrical or mechanical modification made to the test item subsequent to the test date shall invalidate the data presented in this report. Any electrical or mechanical modification made to the test item subsequent to this test date shall require reevaluation.

1.5 Copyright

This report shall not be reproduced, except in full, without the written approval of Willow Run (WR) Test Labs, Inc..

1.6 Endorsements

This report shall not be used to claim product endorsement by any accrediting, regulatory, or governmental agency.

1.7 Test Location

The EUT was fully tested by **Willow Run (WR) Test Labs, Inc.**, 7117 Fieldcrest Dr., Brighton, Michigan 48116 USA. Table 1 lists all sites employed herein. Specific test sites utilized are also listed in the test results sections of this report.

Table 1: Test Site List.

Description	Location	Quality Num.
OATS (3 meter)	8501 Beck Rd. Bldg 2227, Belleville MI 48111	OATSA

1.8 Traceability and Equipment Used

Pertinent test equipment used for measurements at this facility is listed in Table 2. The quality system employed at Willow Run (WR) Test Labs, Inc. has been established to ensure all equipment has a clearly identifiable classification, calibration expiry date, and that all calibrations are traceable to the SI through NIST, other recognized national laboratories, accepted fundamental or natural physical constants, ratio type of calibration, or by comparison to consensus standards.

Table 2: Equipment List.

Description	Manufacturer/Model	SN	Quality Num.	Last Cal By / Date Due
Spectrum Analyzer	Rohde & Schwarz / FSV30	101660	RSFSV30001	RS / May-2018
Spectrum Analyzer	Rohde & Schwarz / FSV4	101222	RSFSV4001	RS / Mar-2018
Biconical	EMCO / 93110B	9802-3039	BICEMCO01	Lib. Labs / Aug-2018
Log Periodic Antenna	EMCO / 3146	9305-3614	LOGEMCO01	Lib. Labs / Aug-2018
Quad Ridge Horn	ETS Lind. / 3164-04	00066988	HRNQR316401	Lib. Labs / Aug-2018
Quad Ridge Horn	Singer / A6100	C35200	HQR2TO18S01	Lib. Labs / Aug-2018
K-Band Horn	JEF / NRL Std.	001	HRNK01	WRTL / Jul-2018

2 Test Specifications and Procedures

2.1 Test Specification and General Procedures

The ultimate goal of Air Lift Company is to demonstrate that the Equipment Under Test (EUT) complies with the Rules and/or Directives below. Detailed in this report are the results of testing the Air Lift Company 72709 for compliance to:

Country/Region	Rules or Directive	Referenced Section(s)
United States	Code of Federal Regulations	CFR Title 47, Part 15.249
Canada	ISED Canada	ISED RSS-210/GENe

It has been determined that the equipment under test is subject to the rules and directives above at the date of this testing. In conjunction with these rules and directives, the following specifications and procedures are followed herein to demonstrate compliance (in whole or in part) with these regulations.

ANSI C63.4:2014	"Methods of Measurement of Radio-Noise Emissions from Low-Voltage Electrical and Electronic Equipment in the Range of 9 kHz to 40 GHz"
ANSI C63.10:2013 (USA)	"American National Standard of Procedures for Compliance Testing of Unlicensed Wireless Devices"
CFR 47 2.1091/1093	"447498 D01 General RF Exposure Guidance v06: RF Exposure Procedures and Equipment Authorization Policies for Mobile and Portable Devices"
ISED Canada	"The Measurement of Occupied Bandwidth"
ICES-003; Issue 6 (2016)	"Information Technology Equipment (ITE) Limits and methods of measurement"
ISED Canada RSS-102	"Radio Frequency (RF) Exposure Compliance of Radiocommunication Apparatus (All Frequency Bands)"
ISED Canada SPR-002	"Supplementary Procedure for Assessing Compliance with RSS-102 Nerve Stimulation Exposure Limits."

3 Configuration and Identification of the Equipment Under Test

3.1 Description and Declarations

The EUT is a remote control for an electronic suspension control system. The EUT is approximately 11 x 4 x 3 cm in dimension, and is depicted in Figure 1. It is powered by 6 VDC Lithium Coin-cell batteries. The EUT is a remote with integrated LCD and buttons used to control and gain feedback from a separate electronic suspension device. Table 3 outlines provider declared EUT specifications.

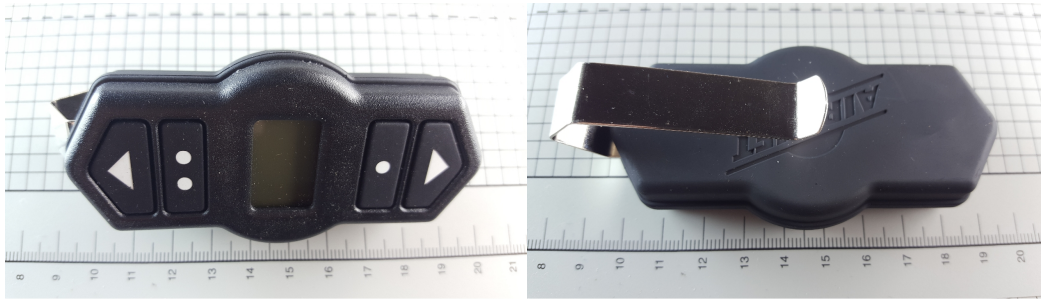

Figure 1: Photos of EUT.

Table 3: EUT Declarations.

General Declarations			
Equipment Type:	2.4GHz Transceiver	Country of Origin:	USA
Nominal Supply:	6 VDC	Oper. Temp Range:	Not Declared
Frequency Range:	2402 – 2480 MHz	Antenna Dimension:	Not Declared
Antenna Type:	PCB Trace	Antenna Gain:	Not Declared
Number of Channels:	40	Channel Spacing:	Not Declared
Alignment Range:	Not Declared	Type of Modulation:	GFSK
United States			
FCC ID Number:	2ANLC-OMQ22817	Classification:	DXT
Canada			
IC Number:	23130-OMQ22817	Classification:	Remote Control Device

3.1.1 EUT Configuration

The EUT is configured for testing as depicted in Figure 2.

3.1.2 Modes of Operation

The EUT is capable of GFSK modulation as tested herein.

3.1.3 Variants

There is only a single variant of the EUT, as tested.

3.1.4 Test Samples

Two samples in total were provided, both with software modified for continuous transmission on the Low, Middle, and High channels.



Figure 2: EUT Test Configuration Diagram.

3.1.5 Functional Exerciser

Normal operating EUT functionality was verified by observation of transmitted signal.

3.1.6 Modifications Made

There were no modifications made to the EUT by this laboratory.

3.1.7 Production Intent

The EUT appears to be a production ready sample.

3.1.8 Declared Exemptions and Additional Product Notes

None.

4 Emissions

4.1 General Test Procedures

4.1.1 Radiated Test Setup and Procedures

Radiated electromagnetic emissions from the EUT are first pre-scanned in our shielded anechoic chamber or GTEM test cell. Spectrum and modulation characteristics of all emissions are recorded. Instrumentation, including spectrum analyzers and other test equipment as detailed in Section 1.7 are employed. After pre-scan, emission measurements are made on the test site of record. If the EUT connects to auxiliary equipment and is table or floor standing, the configurations prescribed in relevant test standards are followed. Alternatively, a layout closest to normal use (as declared by the provider) is employed if the resulting emissions appear to be worst-case in such a configuration. See Figure 3. All intentionally radiating elements that are not fixed-mounted in use are placed on the test table lying flat, on their side, and on their end (3-axes) and the resulting worst case emissions are recorded. If the EUT is fixed-mounted in use, measurements are made with the device oriented in the manner consistent with installation and then emissions are recorded. If the EUT exhibits spurious emissions due to internal receiver circuitry, such emissions are measured with an appropriate carrier signal applied.

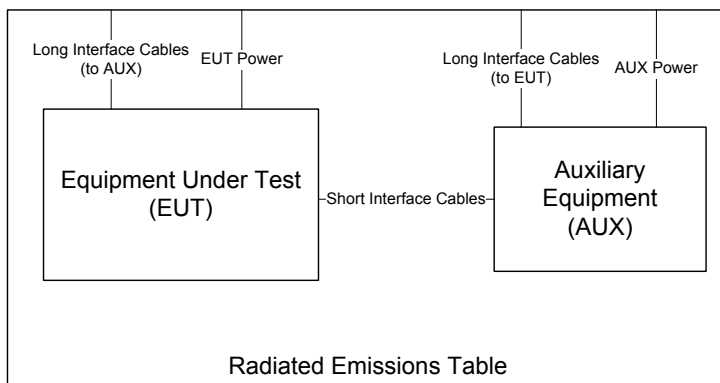

Figure 3: Radiated Emissions Diagram of the EUT.

For devices with intentional emissions below 30 MHz, a shielded loop antenna and/or E-field and H-Field broadband probes are used depending on the regulations. Shielded loops are placed at a 1 meter receive height at the desired measurement distance. For exposure in this band, the broadband probes employed are 10cm diameter single-axis shielded transducers and measurements are repeated and summed over three axes.

Emissions between 30 MHz and 1 GHz are measured using tuned dipoles and/or calibrated broadband antennas. For both horizontal and vertical polarizations, the test antenna is raised and lowered from 1 to 4 m in height until a maximum emission level is detected. The EUT is then rotated through 360° in azimuth until the highest emission is detected. The test antenna is then raised and lowered one last time from 1 to 4 m and the worst case value is recorded. Emissions above 1 GHz are characterized using standard gain horn or broadband ridge-horn antennas on our OATS with a 4 × 5 m rectangle of H-4 absorber placed over the ground screen covering the OATS ground screen. Care is taken to ensure that test receiver resolution and video bandwidths meet the regulatory requirements, and that the emission bandwidth of the EUT is not reduced. Photographs of the test setup employed are depicted in Figure 4.

Where regulations allow for direct measurement of field strength, power values (dBm) measured on the test receiver / analyzer are converted to dBμV/m at the regulatory distance, using

$$E_{dist} = 107 + P_R + K_A - K_G + K_E - C_F$$

where P_R is the power recorded on spectrum analyzer, in dBm, K_A is the test antenna factor in dB/m, K_G is the combined pre-amplifier gain and cable loss in dB, K_E is duty correction factor (when applicable) in dB, and C_F is a distance conversion (employed only if limits are specified at alternate distance) in dB. This field strength value is then compared with the regulatory limit. If effective isotropic radiated power (EIRP) is computed, it is computed as

$$EIRP(dBm) = E_{3m}(dB\mu V/m) - 95.2.$$

When presenting data at each frequency, the highest measured emission under all possible EUT orientations (3-axes) is reported.

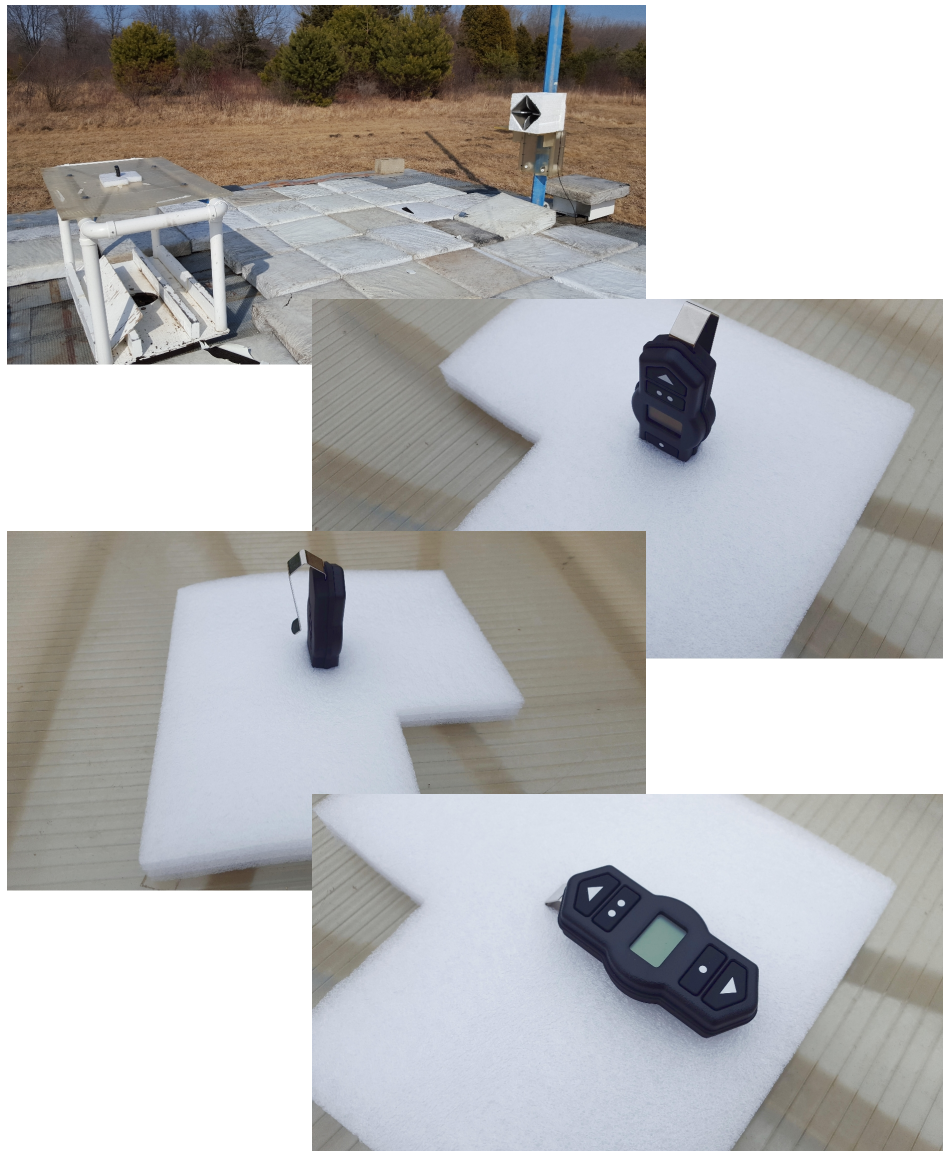

Figure 4: Radiated Emissions Test Setup Photograph(s).

4.1.2 Conducted Emissions Test Setup and Procedures

Battery Power Conducted Spurious The EUT is not subject to measurement of power line conducted emissions as it is powered solely by its internal battery.

4.1.3 Power Supply Variation

Tests at extreme supply voltages are made if required by the the procedures specified in the test standard, and results of this testing are detailed in this report.

In the case the EUT is designed for operation from a battery power source, the extreme test voltages are evaluated over the range specified in the test standard; no less than $\pm 10\%$ of the nominal battery voltage declared by the manufacturer. For all battery operated equipment, worst case intentional and spurious emissions are re-checked employing a new (fully charged) battery.

4.1.4 Thermal Variation

Tests at extreme temperatures are made if required by the procedures specified in the test standard, and results of this testing are detailed in this report. The provider has declared that the EUT is designed for operation over the temperature range Not Declared. Before any temperature measurements are made, the equipment is allowed to reach a thermal balance in the test chamber, temperature and humidity are recorded, and thermal balance is verified via a thermocouple-based probe.

4.2 Intentional Emissions

4.2.1 Fundamental Emission Pulsed Operation

Test Setup & Procedure The test equipment and facilities were setup in accordance with the standards and procedures listed in Section 2.1. Environmental conditions were set at the appropriate temperature and thermal balance was checked with a thermocouple based probe. Duty cycle is reported for all relevant modes of operation. The test equipment employed includes RSFSV30001, DIPEMC001.

Measurement Results The details and results of testing the EUT are summarized in Table 4. Plots showing the measurements made to obtain these values are provided in Figure 5.

Table 4: Fundamental Emission Pulsed Operation.

Frequency Range f > 1 000 MHz	Det Pk	IFBW 3 MHz	VBW 5 MHz	Test Date: 15-Mar-17
				Test Engineer: Joseph Brunett
				EUT Airlift WirelessOne Rmt
				Meas. Distance: Conducted

Pulsed Operation / Duty Cycle								
Transmit Mode	Symbol Rate (Msym/s)	Data Rate (Mbps)	Voltage (V)	Oper. Freq (MHz)	Tx Cycle Time* (ms)	On-Time* (ms)	Duty Cycle (%)	Power Duty Correction (dB)
GFSK	1.000	GFSK (1 Mbps)	13.4	2441.0	-	-	100.0	0.0

Equipment Used: RSFSV30001

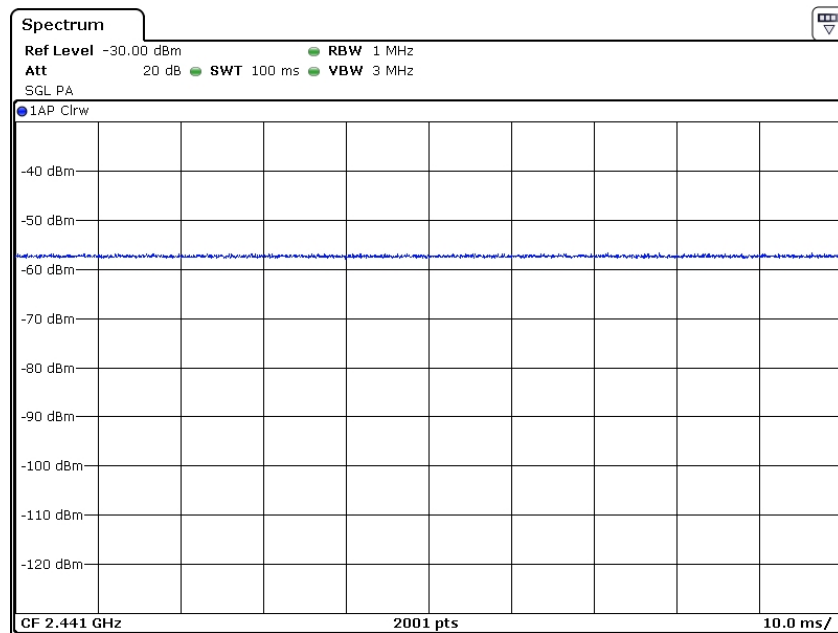

Figure 5: Fundamental Emission Pulsed Operation.

4.2.2 Fundamental Emission Bandwidth

Test Setup & Procedure The test equipment and facilities were setup in accordance with the standards and procedures listed in Section 2.1. Environmental conditions were set at the appropriate temperature and thermal balance was checked with a thermocouple based probe. Emission bandwidth (EBW) of the EUT is measured with the device placed in the test mode(s) with the shortest available frame length and minimum frame spacing. The 20 dB EBW is measured as the max-held peak-detected signal when the IF bandwidth is greater than or equal to 1% of the receiver span. For complex modulations other than ASK and FSK, the 99% emission bandwidth per IC test procedures has a different result, and is also reported. The test equipment employed includes RSFSV30001, DIPEMC001.

Measurement Results The details and results of testing the EUT are summarized in Table 5. Plots showing the measurements made to obtain these values are provided in Figure 6.

Table 5: Fundamental Emission Bandwidth.

Frequency Range	Det	IFBW	VBW	Test Date:	03/16/17
f > 1 000 MHz	Pk	30 kHz	100 kHz	Test Engineer:	Joseph Brunett
f > 1 000 MHz	Pk	30 kHz	100 kHz	EUT	Airlift WirelessOne Rmt
				Meas. Distance:	60 cm

Occupied Bandwidth									
Transmit Mode	Symbol Rate (Msym/s)	Data Rate* (Mbps)	Voltage (V)	Oper. Freq (MHz)	6 dB BW (MHz)	6 dB BW Limit (MHz)	99% OBW (MHz)	20 dB BW (MHz)	Pass/Fail
GFSK	-	-	6.0	2402.0	0.689	-	1.079	1.262	Pass
				2441.0	0.692	-	1.076	1.250	Pass
				2480.0	0.697	-	1.082	1.251	Pass

Equipment Used: RSFSV30001

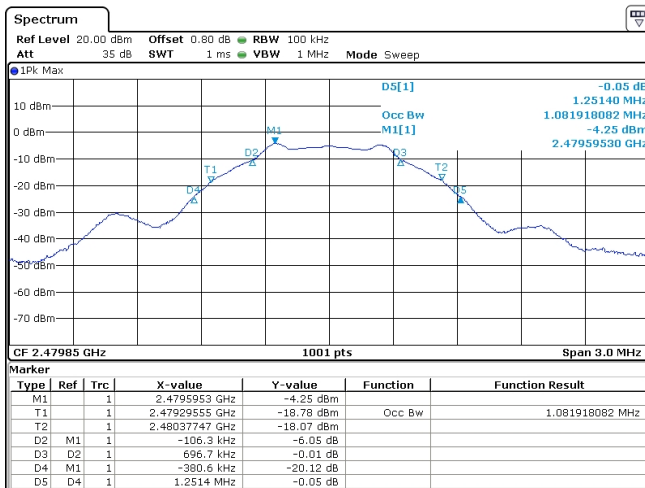
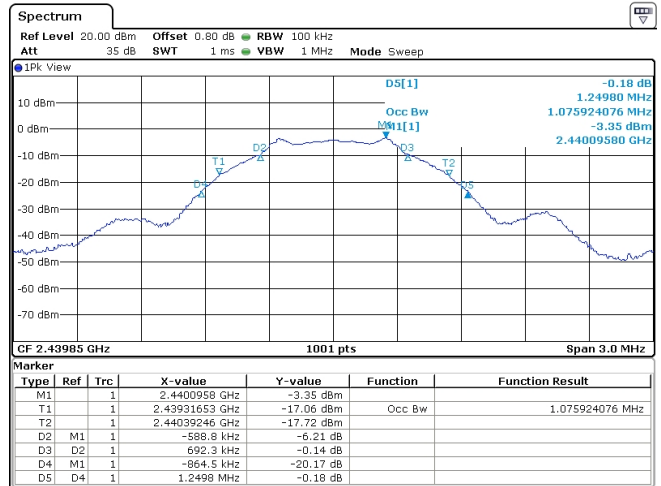
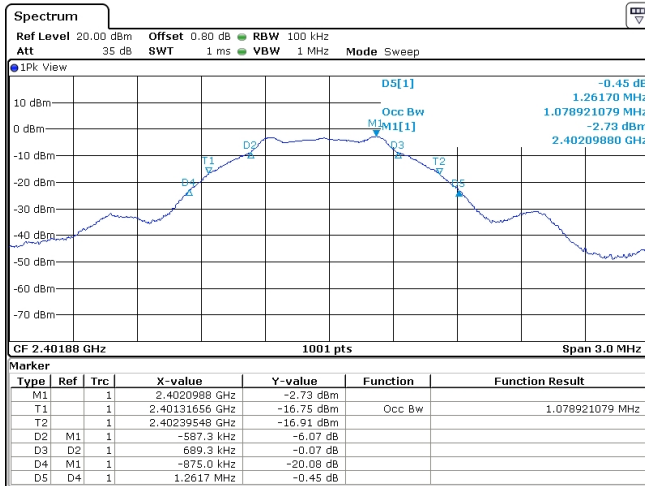

Figure 6: Fundamental Emission Bandwidth.

4.2.3 Fundamental Emission Field Strength

Test Setup & Procedure The test equipment and facilities were setup in accordance with the standards and procedures listed in Section 2.1. Environmental conditions were set at the appropriate temperature and thermal balance was checked with a thermocouple based probe. Fundamental emissions are measured at the regulatory distance on our OATS. The test equipment employed includes RSFSV30001, DIPEMC001.

Measurement Results The details and results of testing the EUT are summarized in Table 6.

Table 6: Fundamental Emission Field Strength.

Frequency Range	Det	IF Bandwidth	Video Bandwidth	Test Date:	16-Mar-17
25 MHz f 1 000 MHz	Pk/QPk	120 kHz	300 kHz	Test Engineer:	Joseph Brunett
f > 1 000 MHz	Pk/Avg	3 MHz	3 MHz	EUT:	Airlift WirelessOne Rmt
Equipment Used: HRN15001, RSFSV30001				Meas. Distance:	3m

FCC/IC

#	Mode	Channel	Freq. MHz	Ant. Used	Ant. Pol.	Pr (Pk)** (dBm)	Ka (dB/m)	Kg (dB)	Efield @ 3m (dBuV/m)	Efield Limit @ 3m (dBuV/m)	Pass (dB)
1	GFSK	L	2402.0	HRNQR316401	H/V		32.2	-0.3	91.1	94.0	2.9
2		M	2441.0	HRNQR316401	H/V		32.5	-0.3	87.6	94.0	6.4
3		H	2480.0	HRNQR316401	H/V		32.8	-0.3	84.3	94.0	9.7
4											
#	Mode	Channel	Freq. MHz	Supply Voltage	Ant. Pol.	Pr ** dBm	Ka dB/m	Kg dB	Efield @ 3m dBm		
5	GFSK	L	2402.0	5.4	H/V		32.2	-0.3	91.0		
6			2402.0	6.0	H/V		32.2	-0.3	91.1		
7			2402.0	6.6	H/V		32.2	-0.3	91.3		

** Measured radiated at 3 meter distance. Peak power measured with IFBW > OBW

4.3 Unintentional Emissions

4.3.1 Transmit Chain Spurious Emissions

Test Setup & Procedure The test equipment and facilities were setup in accordance with the standards and procedures listed in Section 2.1. Environmental conditions were set at the appropriate temperature and thermal balance was checked with a thermocouple based probe. Spurious radiated emissions measurements are performed to 10 times the highest fundamental operating frequency. The test equipment employed includes RSFSV30001, DIPEMC001, UMHORN005.

Measurement Results The details and results of testing the EUT are summarized in Table 7.

Table 7: Transmit Chain Spurious Emissions.

Frequency Range	Det	IF Bandwidth	Video Bandwidth	Test Date:	16-Mar-17
25 MHz f 1 000 MHz	Pk/QPk	120 kHz	300 kHz	Test Engineer:	Joseph Brunett
f > 1 000 MHz	Pk/Avg	1 MHz	3 MHz	EUT:	Airlift WirelessOne Rmt
				Mode:	Modulated
				Meas. Distance:	3m

													FCC/IC
#	Freq. Start MHz	Freq. Stop MHz	Ant. Used	Ant. Pol.	Pr (Pk) dBm	Pr (Avg)* dBm	Ka dB/m	Kg dB	E3(Pk) dBμV/m	E3(Avg)* dBμV/m	E3 Avg Lim dBμV/m	Pass dB	Comments
1	Fundamental Restricted Band Edge (Low Side)												
2	2390.0	2390.0	HRNQR316401	H/V			32.1	-0.3	55.9	47.9	54.0	6.1	all channels
3	Fundamental Restricted Band Edge (High Side)												
4	2483.5	2483.5	HRNQR316401	H/V			32.8	-0.3	58.0	49.3	54.0	4.7	all channels
5	Harmonic / Spurious Emissions												
6	4804.0	4804.0	HRNQR316401	H/V			32.8	-0.5	48.5	45.9	54.0	8.1	
7	4882.0	4805.0	HRNQR316401	H/V			32.8	-0.5	46.9	44.3	54.0	9.7	
8	4960.0	4806.0	HRNQR316401	H/V			32.8	-0.5	46.6	44.0	54.0	10.0	
9	4000.0	6000.0	HRNQR316401	H/V			32.8	-0.5	48.5	45.9	54.0	8.1	all channels; max all
10	7206.0	7206.0	HQR2TO18S01	H/V			33.3	-0.7	45.6	43.5	54.0	10.5	
11	7323.0	7323.0	HQR2TO18S01	H/V			33.4	-0.7	43.2	41.0	54.0	13.0	
12	7440.0	7440.0	HQR2TO18S01	H/V			33.5	-0.7	40.9	38.6	54.0	15.4	
13	6000.0	8400.0	HQR2TO18S01	H/V			32.8	-0.8	45.6	43.5	54.0	10.5	
14	8400.0	12500.0	HQR2TO18S01	H/V			34.3	-1.1	41.7	33.6	54.0	20.4	all channels; max all; noise
15	12500.0	18000.0	HQR2TO18S01	H/V			35.6	-1.6	42.5	33.7	54.0	20.3	all channels; max all; noise
16	18000.0	26000.0	Horn K	H/V			33.6	-3.9	41.6	33.1	54.0	20.9	all channels; max all; noise
17													

*Avg measurements made employing RMS average detector.

4.3.2 Radiated Digital Spurious

The results for the measurement of digital spurious emissions are not reported herein as all digital emissions were greater than 20 dB below the regulatory limit. Radiation from digital components was measured to 4 GHz, or to five times the maximum digital component operating frequency, whichever is greater.

4.4 RF Exposure

4.4.1 Exposure and Potential Health Hazard

To demonstrate compliance with with regulations that place limitations on human electromagnetic field exposure for both the general public and for workers, we compute EIRP from measured emission data. These levels are compared with limits placed by the directives and recommendations detailed in Section 2.1. Table 8 details the results of these computations.

Table 8: Electromagnetic Field Exposure.

USA REF: 2.1091/1093, 447498 D01 General RF Exposure Guidance v06	Test Date: 16-Mar-17
IC REF: RSS-102 Issue 5	Test Engineer: Joseph Brunett
Min. Sep. Distance: <5mm	EUT: Airlift WirelessOne Rmt
	EUT Mode: Cont. Modulated
	Meas. Distance: 3 meters

Freq. MHz	EIRP (Pk) dBm	Duty Factor dB	EIRP (Avg) dBm	EIRP(Avg)** mW	
2402.00	-4.1	.0	-4.1	.39	
2441.00	-7.6	.0	-7.6	.17	
2480.00	-10.9	.0	-10.9	.08	
Canada			USA		
Calculated SAR Threshold (Avg) mW	1-g SAR Body Power Threshold Exclusion Limit (Avg) mW	10-g SAR Extremity Power Threshold Exclusion Limit (Avg) mW	Calculated SAR Threshold (Avg)	1-g SAR Body Power Threshold Exclusion Limit (Avg)	10-g SAR Extremity Power Threshold Exclusion Limit (Avg)
.389	4.000	10.000	0.12	3.0	7.5
.174	4.000	10.000	0.05	3.0	7.5
.081	4.000	10.000	0.03	3.0	7.5

*As Measured / Computed from highest fundamental emission, see fundamental emission section of this report.

**Only RMS level is required, RMS/6min << Pk, Peak emission employed to demonstrate compliance.

5 Measurement Uncertainty

The maximum values of measurement uncertainty for the laboratory test equipment and facilities associated with each test are given in the table below. This uncertainty is computed for a 95.45% confidence level based on a coverage factor of $k = 2$.

Table 9: Measurement Uncertainty.

Measured Parameter	Measurement Uncertainty [†]
Radio Frequency	$\pm(f_{Mkr}/10^7 + RBW/10 + (SPN/(PTS - 1))/2 + 1 \text{ Hz})$
Conducted Emm. Amplitude	$\pm 1.8 \text{ dB}$
3-axis Exp. Amplitude (9 kHz – 30 MHz)	$\pm 0.8 \text{ dB}$
Radiated Emm. Amplitude (30 – 200 MHz)	$\pm 2.7 \text{ dB}$
Radiated Emm. Amplitude (200 – 1000 MHz)	$\pm 2.5 \text{ dB}$
Radiated Emm. Amplitude ($f > 1000 \text{ MHz}$)	$\pm 3.7 \text{ dB}$
DC and Low Frequency Voltages	$\pm 2\%$
Temperature	$\pm 0.5^\circ\text{C}$
Humidity	$\pm 5\%$

[†]Ref: CISPR 16-4-2:2011+A1:2014