

EMC Test Report

regarding

USA: CFR Title 47, Part 15.247 (Emissions)

Canada: ISED RSS-247v2/GENv5 (Emissions)

for

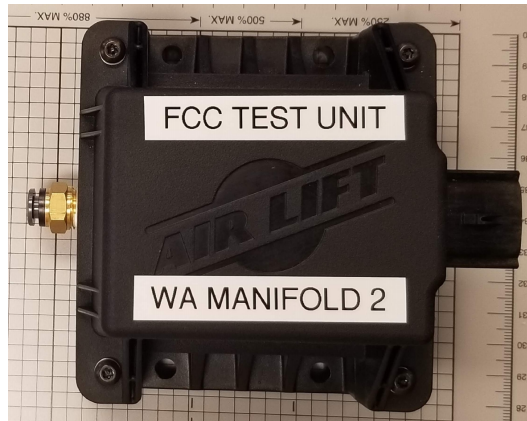

72710

Category: BLE Manifold

Judgments:

15.247/RSS-247v2 Compliant Device

Testing Completed: December 29, 2020



Prepared for:

Air Lift Company

2727 Snow Road, Lansing Michigan 48917 USA

Phone: (517) 322-2144, Fax: (517) 322-9479

Contact: Julian Quick, jquick@airliftcompany.com

Data Recorded by:

Joseph Brunett
Dr. Joseph Brunett, EMC-002790-NE

Reviewed by:

Gordon L. Helm
Gordon Helm, EMC-002401-NE

Prepared by:

Joseph Brunett
Dr. Joseph Brunett, EMC-002790-NE

Date of Issue: December 29, 2020

Revision History

Rev. No.	Date	Details	Revised By
r0	December 29, 2020	Initial Release.	J. Brunett
r1	January 28, 2021	Change of ID numbers.	J. Brunett

Contents

Revision History	2
Table of Contents	2
1 Test Report Scope and Limitations	4
1.1 Laboratory Authorization	4
1.2 Report Retention	4
1.3 Subcontracted Testing	4
1.4 Test Data	4
1.5 Limitation of Results	4
1.6 Copyright	4
1.7 Endorsements	4
1.8 Test Location	5
1.9 Traceability and Equipment Used	5
2 Test Specifications and Procedures	6
2.1 Test Specification and General Procedures	6
3 Configuration and Identification of the Equipment Under Test	7
3.1 Description and Declarations	7
3.1.1 EUT Configuration	8
3.1.2 Modes of Operation	8
3.1.3 Variants	8
3.1.4 Test Samples	8
3.1.5 Functional Exerciser	8
3.1.6 Modifications Made	9
3.1.7 Production Intent	9
3.1.8 Declared Exemptions and Additional Product Notes	9
4 Emissions	10
4.1 General Test Procedures	10
4.1.1 Radiated Test Setup and Procedures	10
4.1.2 Conducted Emissions Test Setup and Procedures	12
4.1.3 Power Supply Variation	12
4.2 Intentional Emissions	13
4.2.1 Duty and Transmission Cycle, Pulsed Operation	13
4.2.2 Fundamental Emission Bandwidth	14
4.2.3 Effective Isotropic Radiated Power	17
4.2.4 Power Spectral Density	18
4.3 Unintentional Emissions	20
4.3.1 Transmit Chain Radiated Spurious Emissions	20
4.3.2 Relative Transmit Chain Spurious Emissions	21
5 Measurement Uncertainty and Accreditation Documents	22

List of Tables

1	Test Site List.	5
2	Equipment List.	5
3	EUT Declarations.	7
4	Pulsed Emission Characteristics (Duty Cycle).	13
5	Intentional Emission Bandwidth.	14
6	Radiated Power Results.	17
7	Power Spectral Density Results.	18
8	Transmit Chain Spurious Emissions.	20
9	Measurement Uncertainty.	22

List of Figures

1	Photos of EUT.	7
2	EUT Test Configuration Diagram.	8
3	Radiated Emissions Diagram of the EUT.	10
4	Radiated Emissions Test Setup Photograph(s).	11
5	Conducted RF Test Setup Photograph(s).	12
6	Pulsed Emission Characteristics (Duty Cycle).	13
7	Intentional Emission Bandwidth.	15
7	Intentional Emission Bandwidth.	16
8	Conducted RF Power Plots	17
9	Power Spectral Density Plots.	19
10	Conducted Transmitter Emissions Measured.	21
11	Accreditation Documents	22

1 Test Report Scope and Limitations

1.1 Laboratory Authorization

Test Facility description and attenuation characteristics are on file with the FCC Laboratory, Columbia, Maryland (FCC Reg. No: US5348 and US5356) and with ISED Canada, Ottawa, ON (File Ref. No: 3161A and 24249). Amber Helm Development L.C. holds accreditation under NVLAP Lab Code 200129-0.

1.2 Report Retention

For equipment verified to comply with the regulations herein, the manufacturer is obliged to retain this report with the product records for the life of the product, and no less than ten years. A copy of this Report will remain on file with this laboratory until January 2031.

1.3 Subcontracted Testing

This report does not contain data produced under subcontract.

1.4 Test Data

This test report contains data included within the laboratories scope of accreditation.

1.5 Limitation of Results

The test results contained in this report relate only to the item(s) tested. Any electrical or mechanical modification made to the test item subsequent to the test date shall invalidate the data presented in this report. Any electrical or mechanical modification made to the test item subsequent to this test date shall require reevaluation.

1.6 Copyright

This report shall not be reproduced, except in full, without the written approval of Amber Helm Development L.C.

1.7 Endorsements

This report shall not be used to claim product endorsement by any accrediting, regulatory, or governmental agency.

1.8 Test Location

The EUT was fully tested by **Amber Helm Development L.C.**, headquartered at 92723 Michigan Hwy-152, Sister Lakes, Michigan 49047 USA. Table 1 lists all sites employed herein. Specific test sites utilized are also listed in the test results sections of this report where needed.

Table 1: Test Site List.

Description	Location	Quality Num.
OATS (3 meter)	3615 E Grand River Rd., Williamston, Michigan 48895	OATSC

1.9 Traceability and Equipment Used

Pertinent test equipment used for measurements at this facility is listed in Table 2. The quality system employed at Amber Helm Development L.C. has been established to ensure all equipment has a clearly identifiable classification, calibration expiry date, and that all calibrations are traceable to the SI through NIST, other recognized national laboratories, accepted fundamental or natural physical constants, ratio type of calibration, or by comparison to consensus standards.

Table 2: Equipment List.

Description	Manufacturer/Model	SN	Quality Num.	Cal/Ver By / Date Due
Spectrum Analyzer	R & S / FSV30	101660	RSFSV30001	RS / Apr-2021
Biconical	EMCO / 93110B	9802-3039	BICEMCO01	Keysight / Aug-2021
Log Periodic Antenna	EMCO / 3146	9305-3614	LOGEMCO01	Keysight / Aug-2021
BNC-BNC Coax	WRTL / RG58/U	001	CAB001-BLACK	AHD / Apr-2021
3.5-3.5MM Coax	PhaseFlex / PhaseFlex	001	CAB015-PURP	AHD / Jan-2021
Quad Ridge Horn	Singer / A6100	C35200	HQR1TO18S01	Keysight / Aug-2021
K-Band Horn	JEF / NRL Std.	001	HRNK01	AHD / Jul-2021

2 Test Specifications and Procedures

2.1 Test Specification and General Procedures

The goal of Air Lift Company is to demonstrate that the Equipment Under Test (EUT) complies with the Rules and/or Directives below. Detailed in this report are the results of testing the Air Lift Company 72710 for compliance to:

Country/Region	Rules or Directive	Referenced Section(s)
United States	Code of Federal Regulations	CFR Title 47, Part 15.247
Canada	ISED Canada	ISED RSS-247v2/GENv5

It has been determined that the equipment under test is subject to the rules and directives above at the date of this testing. In conjunction with these rules and directives, the following specifications and procedures are followed herein to demonstrate compliance (in whole or in part) with these regulations.

ANSI C63.4:2014	"Methods of Measurement of Radio-Noise Emissions from Low-Voltage Electrical and Electronic Equipment in the Range of 9 kHz to 40 GHz"
ANSI C63.10:2013	"American National Standard of Procedures for Compliance Testing of Unlicensed Wireless Devices"
KDB 558074 D01 v05r02	"GUIDANCE FOR COMPLIANCE MEASUREMENTS ON DIGITAL TRANSMISSION SYSTEM, FREQUENCY HOPPING SPREAD SPECTRUM SYSTEM, AND HYBRID SYSTEM DEVICES OPERATING UNDER SECTION 15.247 OF THE FCC RULES "
TP0102RA	"AHD Internal Document TP0102 - Radiated Emissions Test Procedure"
ISED Canada	"The Measurement of Occupied Bandwidth"

3 Configuration and Identification of the Equipment Under Test

3.1 Description and Declarations

The EUT is a remote controlled electronic suspension control module (manifold). The EUT is approximately 12 x 12 x 8 cm in dimension, and is depicted in Figure 1. It is powered by 12 VDC vehicular power system. The EUT is used to control vehicle suspension. Table 3 outlines provider declared EUT specifications.



Figure 1: Photos of EUT.

Table 3: EUT Declarations.

General Declarations	
Equipment Type:	BLE Manifold
Country of Origin:	USA
Nominal Supply:	12 VDC
Oper. Temp Range:	Not Declared
Frequency Range:	2402 – 2480 MHz
Antenna Dimension:	Not Declared
Antenna Type:	SMT Coil
Antenna Gain:	Not Declared
Number of Channels:	40
Channel Spacing:	Not Declared
Alignment Range:	Not Declared
Type of Modulation:	GFSK
United States	
FCC ID Number:	2ANLC-HMK122713
Classification:	DTS
Canada	
IC Number:	23130-HMK122713
Classification:	Spread Spectrum Device, Remote Control Device

3.1.1 EUT Configuration

The EUT is configured for testing as depicted in Figure 2.

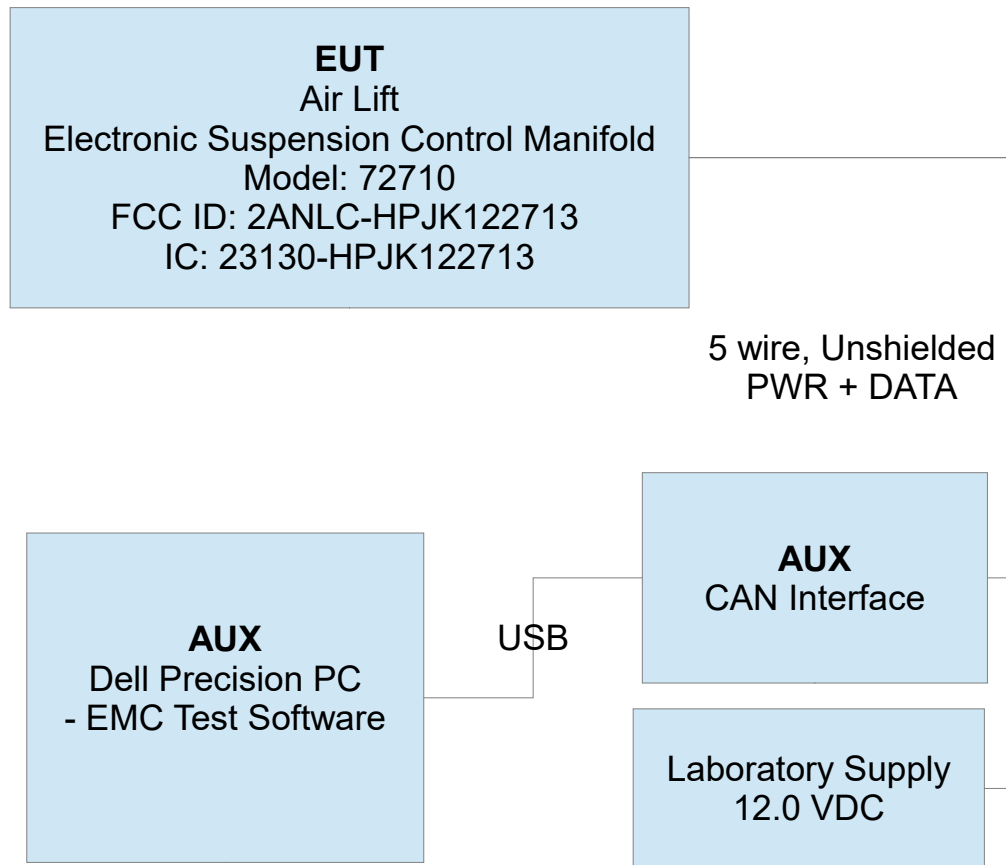

Figure 2: EUT Test Configuration Diagram.

3.1.2 Modes of Operation

The EUT is capable of 1Mbps GFSK modulation as tested herein.

3.1.3 Variants

There is only a single variant of the EUT, as tested.

3.1.4 Test Samples

Two samples in total were provided, each could be controlled by PC software over the EUT CAN bus to be placed into continuous transmission on the Low, Middle, and High channels.

3.1.5 Functional Exerciser

Normal operating EUT functionality was verified by observation of transmitted signal.

3.1.6 Modifications Made

There were no modifications made to the EUT by this laboratory, however the manufacturer did reduce eut power after pretesting to bring the EUT into compliance with the regulatory limits. Manufacturer retains details of the power setting.

3.1.7 Production Intent

The EUT appears to be a production ready sample.

3.1.8 Declared Exemptions and Additional Product Notes

The EUT is permanently installed in a transportation vehicle. As such, digital emissions are exempt from US and Canadian digital emissions regulations (per FCC 15.103(a) and IC correspondence on ICES-003).

4 Emissions

4.1 General Test Procedures

4.1.1 Radiated Test Setup and Procedures

Radiated electromagnetic emissions from the EUT are first pre-scanned in our screen room. Spectrum and modulation characteristics of all emissions are recorded. Instrumentation, including spectrum analyzers and other test equipment as detailed in Section 1.8 are employed. After pre-scan, emission measurements are made on the test site of record. If the EUT connects to auxiliary equipment and is table or floor standing, the configurations prescribed in relevant test standards are followed. Alternatively, a layout closest to normal use (as declared by the provider) is employed if the resulting emissions appear to be worst-case in such a configuration. See Figure 3. All intentionally radiating elements that are not fixed-mounted in use are placed on the test table lying flat, on their side, and on their end (3-axes) and the resulting worst case emissions are recorded. If the EUT is fixed-mounted in use, measurements are made with the device oriented in the manner consistent with installation and then emissions are recorded. If the EUT exhibits spurious emissions due to internal receiver circuitry, such emissions are measured with an appropriate carrier signal applied.

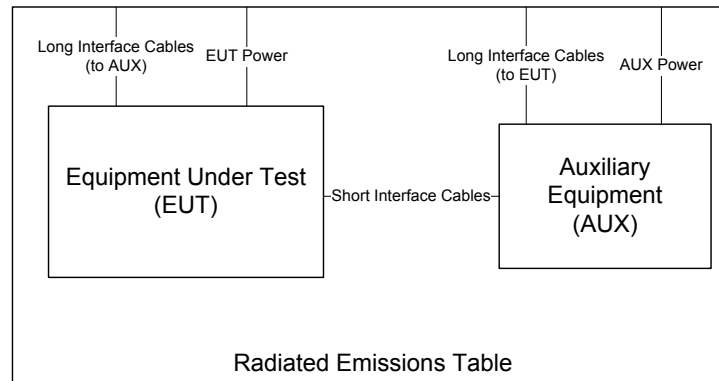

Figure 3: Radiated Emissions Diagram of the EUT.

For devices with intentional emissions below 30 MHz, a shielded loop antenna and/or E-field and H-Field broadband probes are used depending on the regulations. Shielded loops are placed at a 1 meter receive height at the desired measurement distance. For exposure in this band, the broadband probes employed are 10cm diameter single-axis shielded transducers and measurements are repeated and summed over three axes.

Emissions between 30 MHz and 1 GHz are measured using calibrated broadband antennas. For both horizontal and vertical polarizations, the test antenna is raised and lowered from 1 to 4 m in height until a maximum emission level is detected. The EUT is then rotated through 360° in azimuth until the highest emission is detected. The test antenna is then raised and lowered one last time from 1 to 4 m and the worst case value is recorded. Emissions above 1 GHz are characterized using standard gain or broadband ridge-horn antennas on our OATS with a 4×5 m rectangle of ECCOSORB absorber covering the OATS ground screen and a 1.5m table height. Care is taken to ensure that test receiver resolution and video bandwidths meet the regulatory requirements, and that the emission bandwidth of the EUT is not reduced. Photographs of the test setup employed are depicted in Figure 4.

Where regulations allow for direct measurement of field strength, power values (dBm) measured on the test receiver / analyzer are converted to $\text{dB}\mu\text{V}/\text{m}$ at the regulatory distance, using

$$E_{dist} = 107 + P_R + K_A - K_G + K_E - C_F$$

where P_R is the power recorded on spectrum analyzer, in dBm, K_A is the test antenna factor in dB/m, K_G is the combined pre-amplifier gain and cable loss in dB, K_E is duty correction factor (when applicable) in dB, and C_F is a distance conversion (employed only if limits are specified at alternate distance) in dB. This field strength value is then compared with the regulatory limit. If effective isotropic radiated power (EIRP) is computed, it is computed as

$$EIRP(\text{dBm}) = E_{3m}(\text{dB}\mu\text{V}/\text{m}) - 95.2.$$

When presenting data at each frequency, the highest measured emission under all possible EUT orientations (3-axes) is reported.

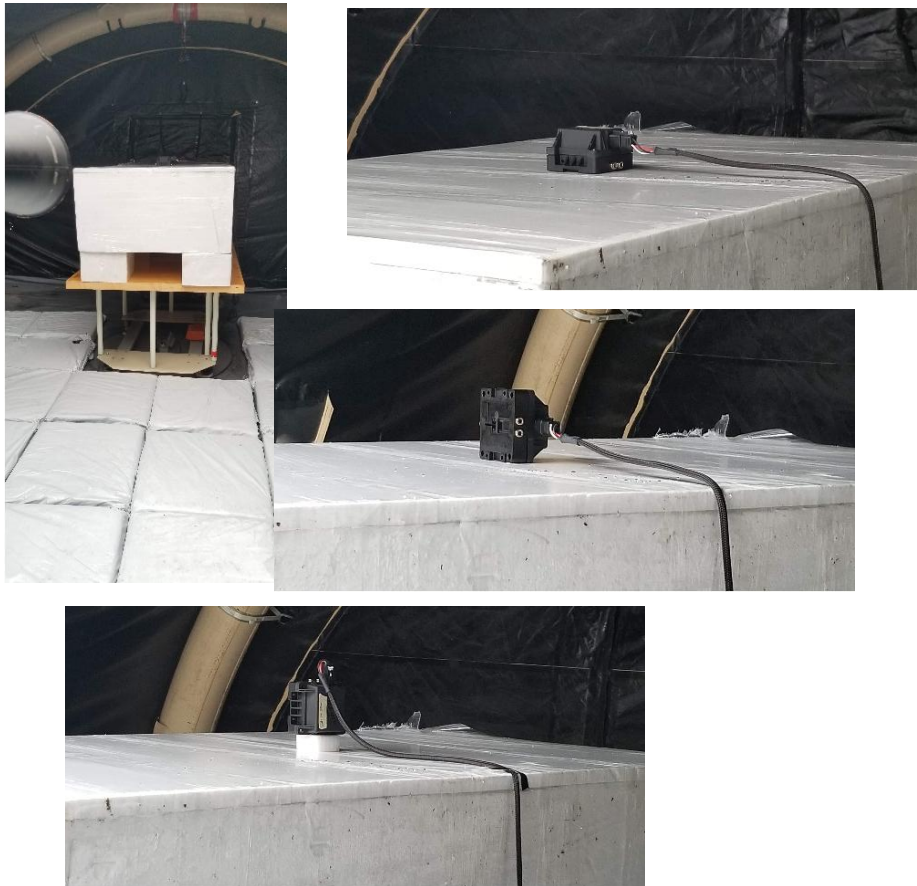

Figure 4: Radiated Emissions Test Setup Photograph(s).

4.1.2 Conducted Emissions Test Setup and Procedures

Transmit Antenna Port Conducted Emissions At least one sample EUT supplied for testing was provided with a 50Ω antenna port. Conducted transmit chain emissions measurements (where applicable) are made by connecting the EUT antenna port directly to the test receiver port. Photographs of the test setup employed are depicted in Figure 5.

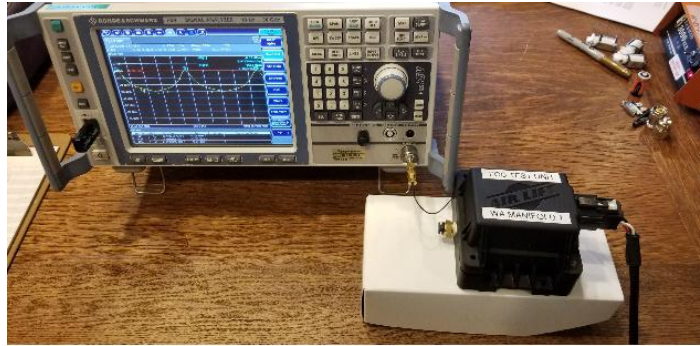

Figure 5: Conducted RF Test Setup Photograph(s).

4.1.3 Power Supply Variation

Tests at extreme supply voltages are made if required by the procedures specified in the test standard, and results of this testing are detailed in this report.

4.2 Intentional Emissions

4.2.1 Duty and Transmission Cycle, Pulsed Operation

The details and results of testing the EUT for pulsed operation are summarized in Table 4. Plots showing the measurements made to obtain these values are provided in Figure 6.

Table 4: Pulsed Emission Characteristics (Duty Cycle).

Frequency Range f > 1 000 MHz	Det Pk	IFBW 3 MHz	VBW 10 MHz	Test Date: 13-Dec-20
				Test Engineer: Joseph Brunett
				EUT Air Lift 72710
				Meas. Distance: Conducted

Pulsed Operation / Duty Cycle								
Transmit Mode	Symbol Rate (Msym/s)	Data Rate (Mbps)	Voltage (V)	Oper. Freq (MHz)	Tx Cycle Time* (ms)	On-Time* (ms)	Duty Cycle (%)	Power Duty Correction (dB)
GFSK	1.000	GFSK (1 Mbps)	13.4	2440.0	0.625	0.390	62.4	2.0

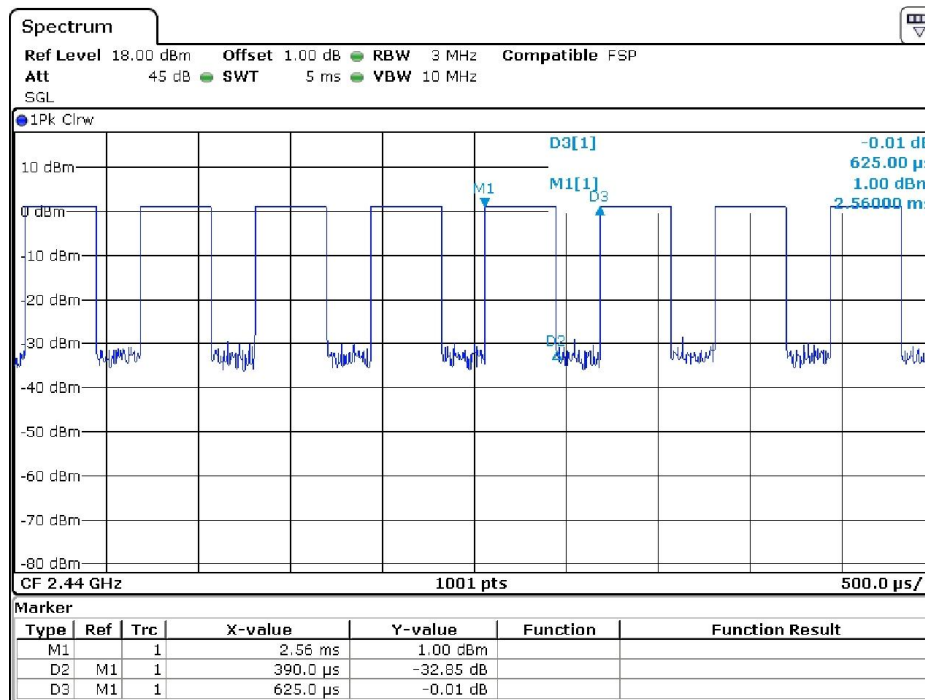

Figure 6: Pulsed Emission Characteristics (Duty Cycle).

4.2.2 Fundamental Emission Bandwidth

Emission bandwidth (EBW) of the EUT is measured with the device placed in the test mode(s) with the shortest available packet length and minimum packet spacing. Radiated emissions are recorded following the test procedures listed in Section 2.1. The 6 dB bandwidth is measured for the lowest, middle, and highest channels available. The 99% emission bandwidth per IC test procedures is also reported. The results of this testing are summarized in Table 5. Plots showing measurements employed obtain the emission bandwidths reported are provided in Figure 7.

Table 5: Intentional Emission Bandwidth.

Test Date: 10/14/20
Test Engineer: Joseph Brunett
EUT: Air Lift 72710
Meas. Distance: Cond.

Occupied Bandwidth								
Transmit Mode	Symbol Rate (Msym/s)	Data Rate* (Mbps)	Voltage (V)	Oper. Freq (MHz)	6 dB BW (MHz)	6 dB BW Limit (MHz)	99% OBW (MHz)	Pass/Fail
GFSK	-	1.0	13.4	2402.0	0.725	-	1.071	Pass
				2440.0	0.722	-	1.064	Pass
				2480.0	0.722	-	1.064	Pass

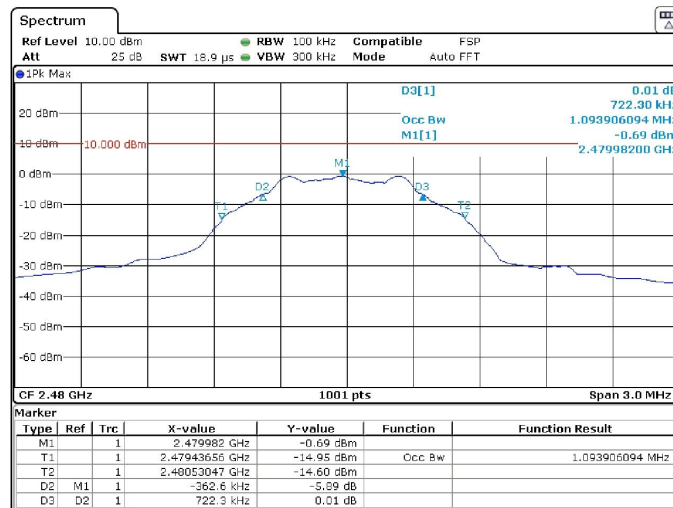
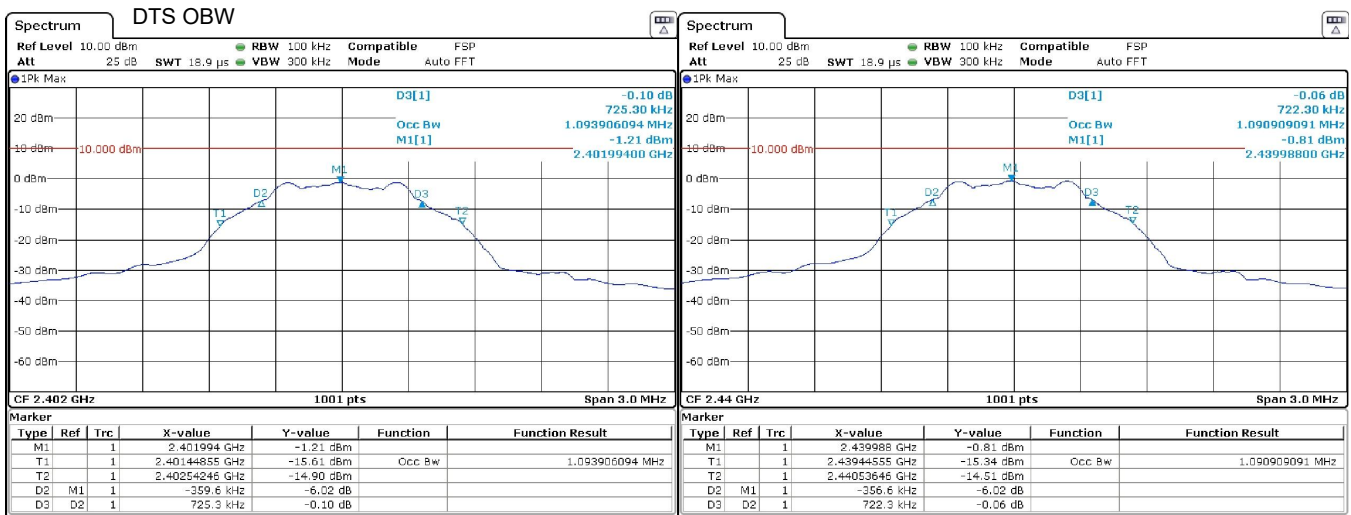

Figure 7(a): Intentional Emission Bandwidth.

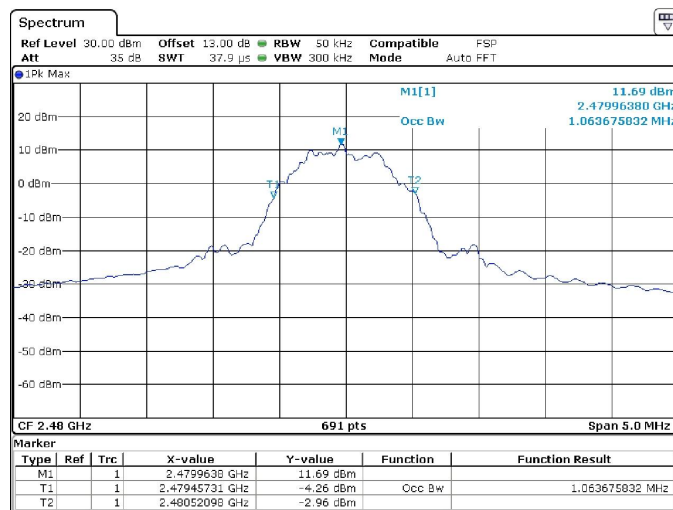
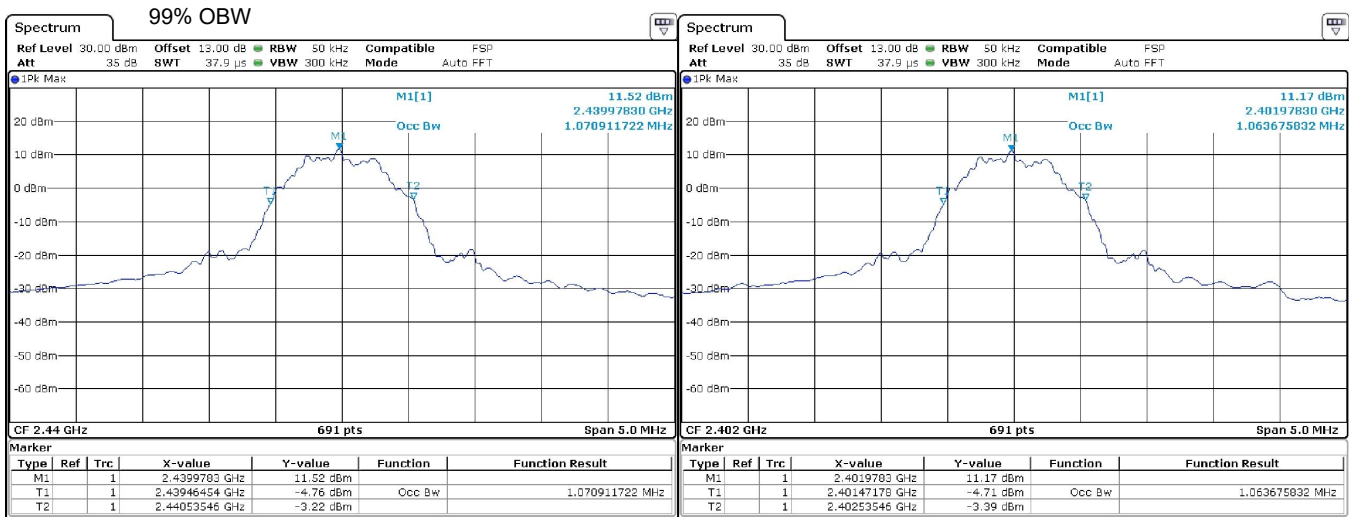

Figure 7(b): Intentional Emission Bandwidth.

4.2.3 Effective Isotropic Radiated Power

The EUT’s radiated power is computed from antenna port conducted power measurements and the gain of the EUT antenna(s). Where the EUT is not sold with an antenna connector, a modified product has been provided including such. Peak conducted output power was measured directly from the EUT at the port where the antenna attaches. The test receiver bandwidth was set to be greater than the measured emission bandwidth of the EUT to capture the true peak. Antenna gain is either provided directly by the antenna manufacturer or measured by comparison between calculated EIRP and conducted output power. Table 6 details the results of these measurements. Plots showing conducted measurements made are depicted in Figure 8.

Table 6: Radiated Power Results.

Frequency Range 25 MHz ≤ f ≤ 1 000 MHz f > 1 000 MHz	Det Pk/QPk Pk/Avg	IF Bandwidth 120 kHz 3 MHz	Video Bandwidth 300 kHz 3 MHz	Test Date: 13-Dec-20
				Test Engineer: J. Brunett
				EUT: Air Lift 72710
				Meas. Distance: 3m

FCC/IC															
#	Mode	Channel	Freq. MHz	Ant. Used	Ant. Pol.	Table Azim. deg	Ant Height m	Ka (dB/m)	Kg (dB)	Efield @ 3m (dBuV/m)	EIRP (Pk) dBm	Pout* (Pk) dBm	Ant Gain dBi	Po Cond (Avg) Limit dBm	Pass dB
1	CW	L	2402.0	HQR1TO18S01	H/V	330.0	1.5	30.5	-0.3	94.2	-1.0	-.2	-0.8	30.0	30.2
2		M	2440.0	HQR1TO18S01	H/V	330.0	1.5	30.7	-0.3	92.3	-2.9	.0	-2.9	30.0	30.0
3		H	2480.0	HQR1TO18S01	H/V	330.0	1.5	30.8	-0.3	90.1	-5.1	.1	-5.2	30.0	29.9
4															
#	Mode	Channel	Freq. MHz	Supply Voltage	Ant. Pol.	Table Azim. deg	Ant Height m	Ka dB/m	Kg dB	E3(Pk) dBuV/m					
5	CW	L	2440.0	13.8	H/V	330.0	1.5	30.7	-0.3	92.3					
6			2440.0	12.0	H/V	330.0	1.5	30.7	-0.3	92.3					
7			2440.0	10.2	H/V	330.0	1.5	30.7	-0.3	92.3					

* Measured conducted out of modified sample.
 ** Measured radiated at 3 meter distance. Peak power measured with IFBW > OBW

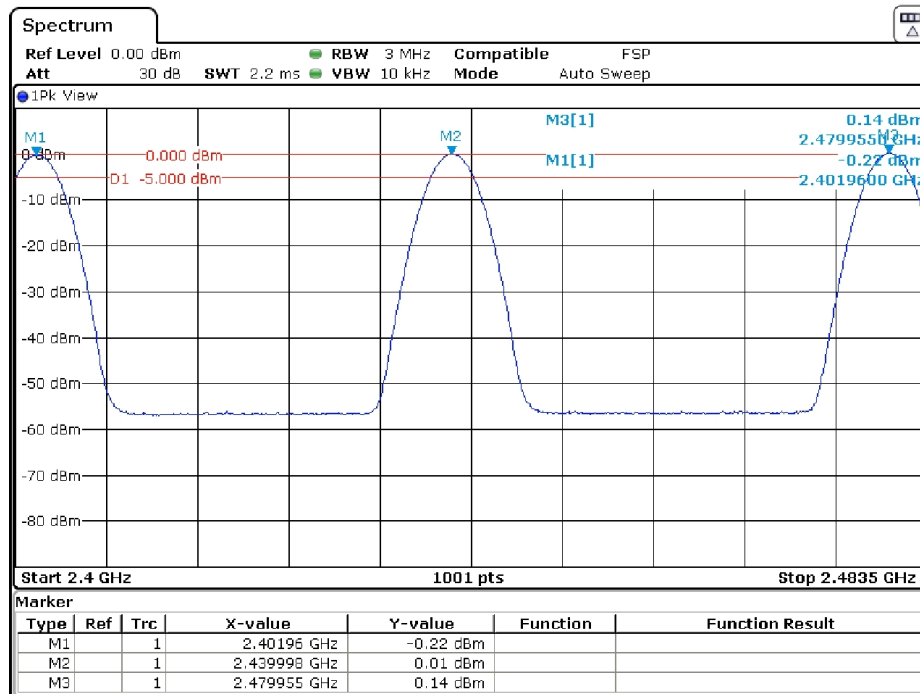

Figure 8: Conducted RF Power Plots

4.2.4 Power Spectral Density

For this test, the EUT was attached directly to the test receiver. Following FCC DTS measurement procedures, the emission spectrum is first scanned for maximum spectral peaks, the span and receiver bandwidth are then reduced until the power spectral density is measured in the prescribed receiver bandwidth. The results of this testing are summarized in Table 7. Plots showing how these measurements were made are depicted in Figure 9.

Table 7: Power Spectral Density Results.

Frequency Range 2400-2483.5	Detector Pk	IF Bandwidth 3 kHz	Video Bandwidth 10 kHz	Test Date: 29-Dec-20
				Test Engineer: Joseph Brunett
				EUT: Air Lift 72710
				Meas. Distance: Conducted

						FCC/IC
Mode	Channel	Frequency (MHz)	Ant. Used	PSDcond (meas)* (dBm/3kHz)	PSD Limit (dBm/3kHz)	Pass By (dB)
CM	L	2402.0	Cond.	-12.3	8.00	20.3
	M	2440.0	Cond.	-12.0	8.00	20.0
	H	2480.0	Cond.	-11.9	8.00	19.9

* PSD measured conducted out the EUT antenna port following FCC DTS PKPSD procedure.

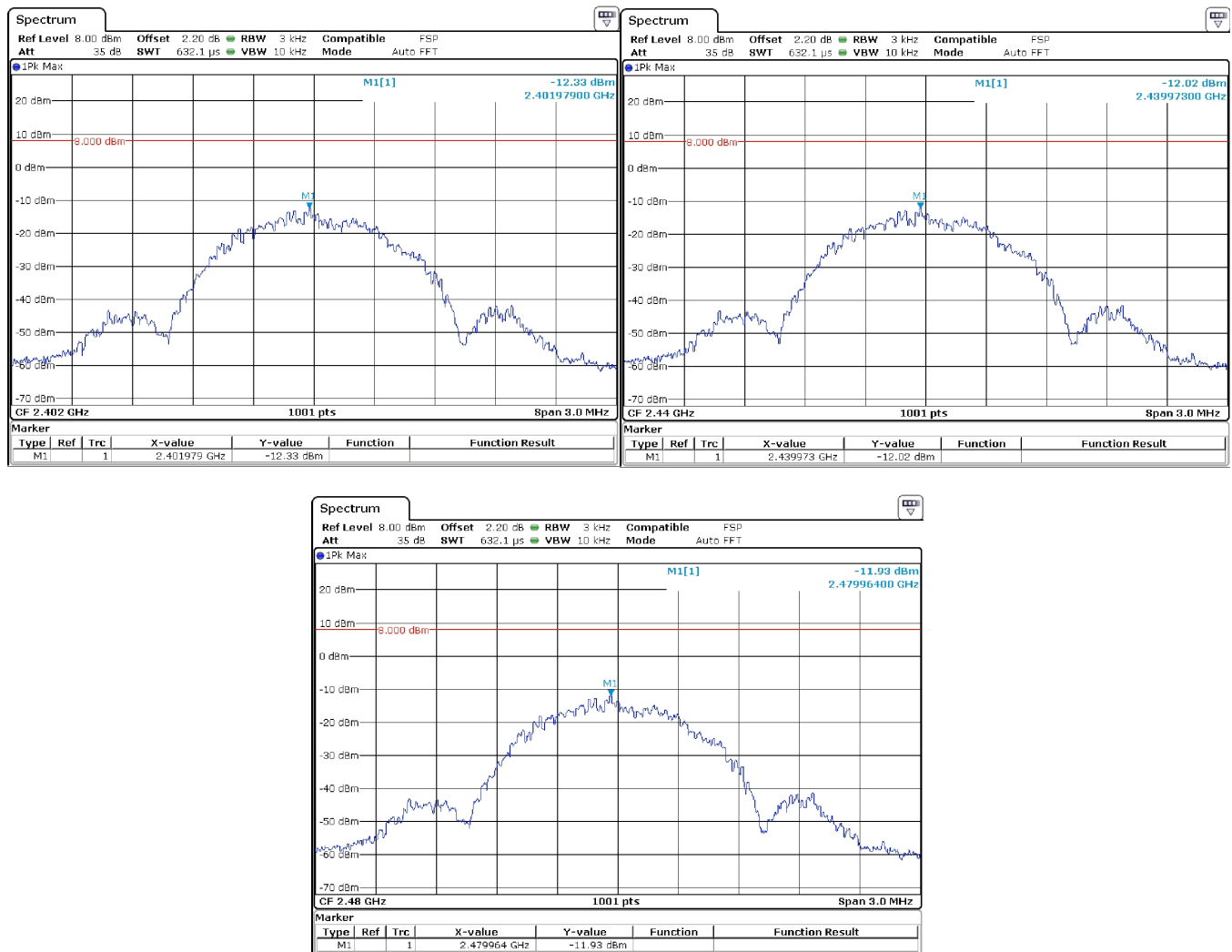

Figure 9: Power Spectral Density Plots.

4.3 Unintentional Emissions

4.3.1 Transmit Chain Radiated Spurious Emissions

The results for the measurement of transmit chain spurious emissions at the nominal voltage and temperature are provided in Table 8. Measurements are performed to 10 times the highest fundamental operating frequency.

Table 8: Transmit Chain Spurious Emissions.

Frequency Range	Det	IF Bandwidth	Video Bandwidth	Test Date:	13-Dec-20
25 MHz ≤ f ≤ 1 000 MHz	Pk/QPk	120 kHz	300 kHz	Test Engineer:	J. Brunett
f > 1 000 MHz	Pk/Avg	1 MHz	3 MHz	EUT:	Air Lift 72710
				Mode:	Cont. Modulated
				Meas. Distance:	3m

													FCC/IC
#	Freq. Start MHz	Freq. Stop MHz	Ant. Used	Ant. Pol.	Table Azim. deg	Ant Height m	Ka dB/m	Kg dB	E3(Pk) dBμV/m	E3(Avg)* dBμV/m	E3 Avg Lim dBμV/m	Pass dB	Comments
1	Fundamental Restricted Band Edge (Low Side)												
2	2390.0	2390.0	HQR1TO18S01	H/V	270	1.5	30.5	-0.3	57.1	34.6	54.0	19.4	all channels
3													
4	Fundamental Restricted Band Edge (High Side)												
5	2483.5	2483.5	HQR1TO18S01	H/V	270	1.5	30.8	-0.3	63.3	48.2	54.0	5.8	all channels
6													
7	Harmonic / Spurious Emissions												
8	4804.0	4804.0	HQR1TO18S01	H/V	90	1.5	32.3	-0.5	39.3		54.0	14.7	
9	4882.0	4805.0	HQR1TO18S01	H/V	90	1.5	32.3	-0.5	41.0		54.0	13.0	
10	4960.0	4806.0	HQR1TO18S01	H/V	90	1.5	32.3	-0.5	40.2		54.0	13.8	
11	4000.0	6000.0	HQR1TO18S01	H/V	all	all	32.6	-0.6	41.0		54.0	13.0	all channels; max all
12	7206.0	7206.0	HQR1TO18S01	H/V	90	1.5	33.2	-0.7	32.4		54.0	21.6	
13	7323.0	7323.0	HQR1TO18S01	H/V	90	1.5	33.3	-0.7	33.3		54.0	20.7	
14	7440.0	7440.0	HQR1TO18S01	H/V	90	1.5	33.4	-0.7	30.1		54.0	23.9	
15	6000.0	8400.0	HQR1TO18S01	H/V	all	all	34.3	-0.8	33.3		54.0	20.7	
16	8400.0	12500.0	HQR1TO18S01	H/V	all	all	35.6	-1.1	41.1		54.0	12.9	all channels; max all; noise
17	12500.0	18000.0	HQR1TO18S01	H/V	all	all	34.2	-1.6	39.9		54.0	14.1	all channels; max all; noise
18	18000.0	26000.0	HRNK01	H/V	all	all	32.0	0.0	41.3		54.0	12.7	all channels; max all; noise
19													
20	NOTE: No other Radio Chain emissions were observed within 20 dB of the spurious emissions limit over the range of 30MHz – 26 GHz												
21													

*Restricted Band measurements made employing RMS detector with Duty Cycle added back following ANSI C63.10 11.12.2.5.2

*Band Edge Avg measurements made following ANSI C63.10 11.13.3.5

4.3.2 Relative Transmit Chain Spurious Emissions

The results for the measurement of transmit chain spurious emissions relative to the fundamental in a 100 kHz receiver bandwidth (at the nominal voltage and temperature) are provided in Figure 10 below.

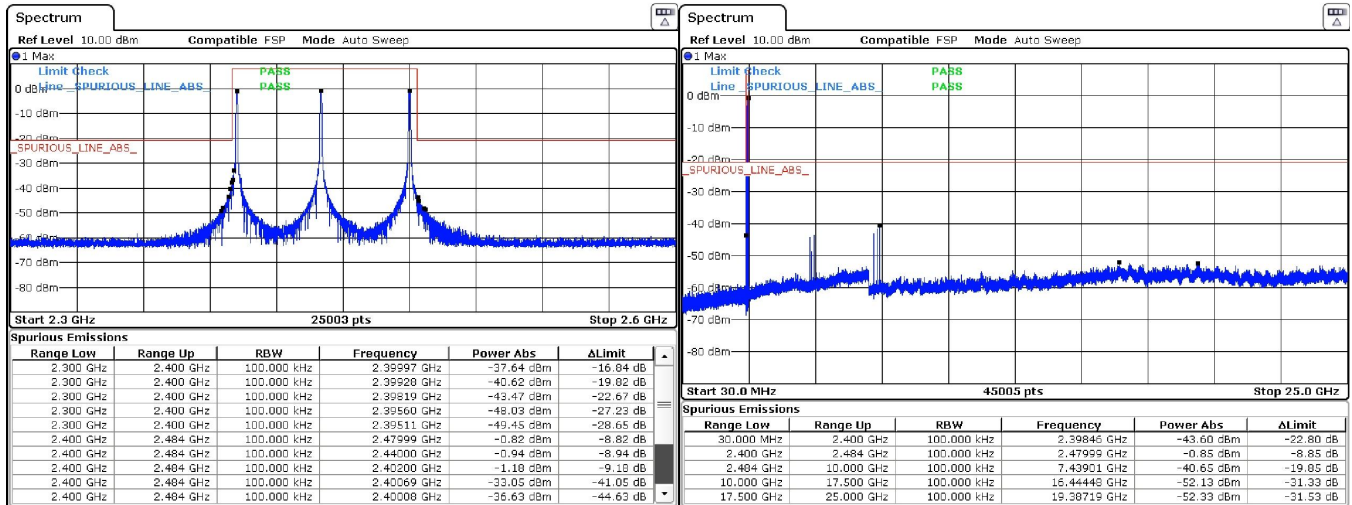

Figure 10: Conducted Transmitter Emissions Measured.

5 Measurement Uncertainty and Accreditation Documents

The maximum values of measurement uncertainty for the laboratory test equipment and facilities associated with each test are given in the table below. This uncertainty is computed for a 95.45% confidence level based on a coverage factor of $k = 2$.

Table 9: Measurement Uncertainty.

Measured Parameter	Measurement Uncertainty [†]
Radio Frequency	$\pm(f_{Mkr}/10^7 + RBW/10 + (SPN/(PTS - 1))/2 + 1 \text{ Hz})$
Conducted Emm. Amplitude	$\pm 1.9 \text{ dB}$
Radiated Emm. Amplitude ($f < 30 \text{ MHz}$)	$\pm 3.1 \text{ dB}$
Radiated Emm. Amplitude (30 – 200 MHz)	$\pm 4.0 \text{ dB}$
Radiated Emm. Amplitude (200 – 1000 MHz)	$\pm 5.2 \text{ dB}$
Radiated Emm. Amplitude ($f > 1000 \text{ MHz}$)	$\pm 3.7 \text{ dB}$

[†]Ref: CISPR 16-4-2:2011+A1:2014



Figure 11: Accreditation Documents