

LE•MEGA  
LIFE & ALOUD

CR6 CLOCK RADIO&CHARGER



Owner's manual

### Important Safety Instructions

1. Read these instructions.
2. Keep these instructions.
3. Heed all warnings.
4. Follow all instructions.
5. **WARNING** - To reduce the risk of fire or electric shock, do not expose this apparatus to rain or moisture.
6. Clean only with a dry cloth.
7. Only use attachments/accessories specified by the manufacturer.
8. Unplug this apparatus during lightning storms or when unused for long periods of time.
9. Keep this product a safe distance away from naked flame, such as a lit candle.
10. Apparatus shall not be exposed to dripping or splashing and no objects filled with liquids, such as vases, shall be placed on the apparatus.
11. Put the remote controller in the fuselage when it is not in use.
12. Don't press more than one key at the same time.
13. In the event that the unit malfunctions, unplug it for 3 seconds, then plug in again.

### Packed with your CR6 you should find:

- 1 Power adapter
- 1 Remote Control (Battery installed)
- 1 Owner's manual
- 1 Warranty Card

### LCD Display

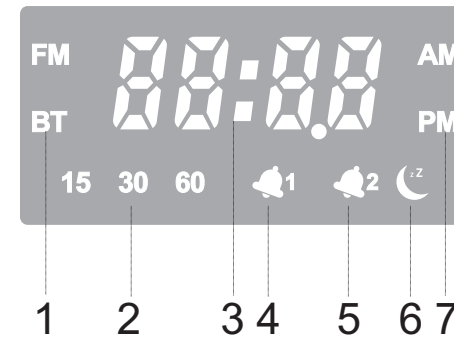

1. Switching between different modes: Bluetooth, FM and Soothing Music mode.
2. Set the sleep timer from 15mins / 30mins / 60mins / Sleep Off in turn
3. Clock display
4. Alarm 1 setting
5. Alarm 2 setting
6. Soothing music mode
7. Switch between AM and PM  
[Note: When you set the Alarm, please note the time is AM or PM]

### Guide To Features (Top touch buttons):

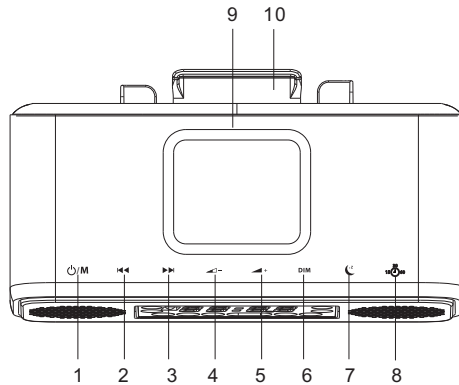

1. (Standby/ MODE): Long Press to Power on/Power off.  
Turn on CR6, Briefly Press M to switch Bluetooth / FM/ Soothing sleep music mode.
2. : In Bluetooth / Soothing sleep music mode, briefly press to previous track.  
  
In FM mode, briefly press to move backward 0.1MHz frequency. Press and hold 2 seconds to auto-scan the backward stations.
3. : In Bluetooth / Soothing sleep music mode, briefly press to next track.  
In FM mode, briefly press to move forward 0.1MHz frequency. Press and hold 2 seconds to auto-scan the stations.

4. VOL- / - : Press and hold - button to decrease the volume quickly. Briefly press - to decrease the volume one step by one step.

5. VOL+ / + : Press and hold + button to increase the volume quickly. Briefly press + to increase the volume one step by one step.

6. DIM: Press this button to adjust the LCD brightness: High/Mid/Low in turn.

7. Soothing sleep music: Press once to enter "Soothing sleep music" source, Press again to change the Soothing sleep music: frog croaks, Ocean Waves, Thunder & Rain, Campfire, White noise, Running Water, Insect Sound, Birds chirping and Lullaby in turn.

8. Sleep : In FM/BT/Soothing sleep music mode, Press to set the time interval 15mins /30mins/ 60mins/Sleep Off in turn.

9. Wireless charging area: Put your phone that supports wireless charging on the charging area until the mobile phone is prompted to charge.

10. Remote control holder: Put your remote control to the remote control holder to avoid missing.

11. Snooze: After the alarm activates, press any of the buttons on the top of the units or on remote control to

temporarily mute the alarm for 5 minutes, or briefly press the Alarm/Sleep button to cancel activation.

### Back Overview

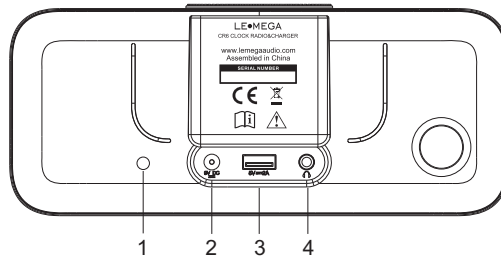

1. FM Wire Antenna
2. 9V DC
3. 5V 1A USB charging
4. Headphone jack

### Remote Control (Remove clear tab over battery before use):

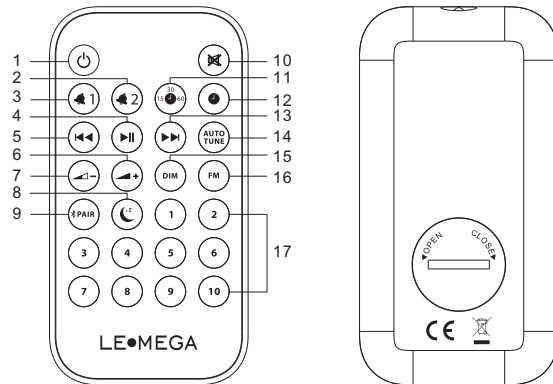

1. **⏻/Standby**: Long Press to Power on/Power off.

2. **ALARM 2**: Press ALARM 2 button to activate or deactivate alarm. Alarm2 icon will appear when Alarm is activated.

Press and hold Alarm2 to start Alarm Setting.

When the hours flash, use **⏪/⏩** to set the hours, press Alarm2 to confirm and continue.

When the minutes flash, use **⏪/⏩** to set the minutes, press Alarm2 to confirm and continue.

Alarm mode: FM station [The last listened FM station]

3. **ALARM 1** : Same operation as Alarm 2.

Alarm mode: Birds chirping soothing sleep music.

4. **▶||** : Press **▶||** to select Play/Pause under Bluetooth mode.

In FM mode, after AUTOTUNE full scanning the stations, press the **▶||** button to switch the saved stations from low frequency to high frequency.

5. **⏪**: In Bluetooth and Soothing music mode, Briefly press to previous track.

In FM mode, Briefly press **⏪** to move forward 0.1MHz frequency. Press and hold **⏪** to auto-scan the forward stations.

6. **VOL+ / ▲+**: Press and hold **▲+** button to increase the volume quickly. Briefly press **▲+** to increase the volume one step by one step.



7. **VOL- / ▼-** : Press and hold **▼-** button to decrease



the volume quickly. Briefly press  to decrease the volume one step by one step.

8.  Soothing music: Press once to enter "Soothing music" source, Press again to change the Soothing music: frog croaks, Ocean Waves, Thunder & Rain, Campfire, White noise, Running Water, Insect Sound, Birds chirping and Lullaby in turn.



9.  PAIR : In other modes, briefly press the Pair button to access Bluetooth mode directly. In Bluetooth mode, Press this button to connect or disconnect BT connection.

10.  / MUTE: Press once to mute the sound when playing. Press again to un-mute the sound.





11.  / SLEEP: In FM/BT/ Soothing music Mode, Press  to set the time interval 15mins/30mins/60mins/ Sleep Off in turn before the unit is set to standby mode.

12.  / CLOCK : Press and hold  to start the time setting.

When the hours flash, use  /  to set the hours, press CLOCK to confirm and continue.

When the minutes flash, use  /  to set the minutes, press  to confirm and continue.

Note: If the time stops flashing while setting, repeat the above steps.

13. : In Bluetooth and Soothing sleep music mode, briefly press  to the next track.  
In FM mode, Briefly press  to move forward 0.1MHz frequency. Press and hold  to auto-scan the forward

stations.

14. **AUTO TUNE**: Press AUTO TUNE button to auto-scan the stations under the FM mode and save the strong signal stations automatically. Play the first saved station after finishing full scan.



15. **DIM**: Press DIM to adjust the brightness from High/Mid/Low in turns.



16. **FM**: In other mode, Press FM to enter FM mode directly.

17. **1-10** : In FM mode, Long press number 1 to number 10 to save the favorite stations; Short Press number 1 to number 10 to select the favorite station or Preset recall.

#### FM RADIO

1. Press "M" button on the unit or press "FM" button on the remote to enter to FM mode;

2. Briefly press  /  to move backward /forward each 0.1MHz frequency to search stations. Or press AUTOTUNE button on remote control to auto-scan the active stations and save the strong signal stations automatically.

3.  : press the  button to switch the saved stations from low frequency to high frequency.

Noted: To get a good radio signal, fully unwind antenna and move it around until you get good reception.

#### BLUETOOTH

1. Turn on CR6, Press "M" button on the unit or press  PAIR button on the remote to enter to Bluetooth mode;

2. Select Bluetooth device name "LEMEGA CR6" when it appears on your device's screen to connect.
3. You can start to play your music files wirelessly. Adjust the volume level on your device.
4. Press **PAIR** on the remote control to connect or disconnect Bluetooth.

### SPECIFICATIONS

Model: CR6

Type: CLOCK RADIO&CHARGER

Drivers: 2 x 1.75"

Power output: RMS 10W

Wireless charging output: 10W

Power Supply: 9V 3A

Dimensions: L 200 X H83 X D111.5 MM

Weight: 580g

Specifications are subject to change without notice.



Correct Disposal of this product. This marking indicates that this product should not be disposed with other household wastes throughout the EU. To prevent possible harm to the environment or human health from uncontrolled waste disposal, recycle it responsibly to promote the sustainable reuse of material resources. To return your used device, please use the return and collection systems or contact the retailer where the product was purchased. They can take this product for environmental safe recycling.

Any Changes or modifications not expressly approved by the party responsible for compliance could void the user's authority to operate the equipment. This device complies with part 15 of the FCC Rules. Operation is subject to the following two conditions:

(1) This device may not cause harmful interference, and (2) this device must accept any interference received, including interference that may cause undesired operation.

Note: This equipment has been tested and found to comply with the limits for a Class B digital device, pursuant to part 15 of the FCC Rules. These limits are designed to provide reasonable protection against harmful interference in a residential installation. This equipment generates, uses and can radiate radio frequency energy and, if not installed and used in accordance with the instructions, may cause harmful interference to radio communications. However, there is no guarantee that interference will not occur in a particular installation. If this equipment does cause harmful interference to radio or television reception, which can be determined by turning the equipment off and on, the user is encouraged to try to correct the interference by one or more of the following measures:

- Reorient or relocate the receiving antenna.
- Increase the separation between the equipment and receiver.
- Connect the equipment into an outlet on a circuit different from that to which the receiver is connected.
- Consult the dealer or an experienced radio/TV technician for help.

**FCC Radiation Exposure Statement:**

This equipment complies with FCC radiation exposure limits set forth for an uncontrolled environment .

This transmitter must not be co-located or operating in conjunction with any other antenna or transmitter.

This equipment should be installed and operated with minimum distance 20cm between the radiator &you body.

**Note:**

1. Do not ingest battery, Chemical Burn Hazard.
  2. [The remote control supplied with] This product contains a coin / button cell battery. If the coin / button cell battery is swallowed, it can cause severe internal burns in just 2 hours and can lead to death.
  3. Keep new and used batteries away from children. If the battery compartment does not close securely, stop using the product and keep it away from children.
- If you think batteries might have been swallowed or placed inside any part of the body, seek immediate medical attention.

**LE•MEGA**  
**LIFE & ALOUD**

CR6 CLOCK RADIO&CHARGER

If you have any questions or suggestions,  
please share with us.

[info@lemegaaudio.com](mailto:info@lemegaaudio.com)  
[www.lemegaaudio.com](http://www.lemegaaudio.com)

  
MADE IN CHINA