

TEST REPORT

Product Name : Mobile Digital Video Recorder
Model Number : 4112-HVR
FCC ID : 2ANKU-4112-HVR

Prepared for : SAFETY VISION, LLC
Address : 6100 W SAM HOUSTON PKWY N HOUSTON, TX
77041-5113, UNITED STATES OF AMERICA

Prepared by : EMTEK (SHENZHEN) CO., LTD.
Address : Building 69, Majialong Industry Zone, Nanshan District,
Shenzhen, Guangdong, China

Tel: (0755) 26954280
Fax: (0755) 26954282

Report Number : ES201014022W02
Date(s) of Tests : Oct. 20, 2020 to Nov. 23, 2020
Date of issue : Nov. 25, 2020

1 TEST RESULT CERTIFICATION

Applicant : SAFETY VISION, LLC
 Address : 6100 W SAM HOUSTON PKWY N HOUSTON, TX 77041-5113, UNITED STATES OF AMERICA
 Manufacturer : SAFETY VISION, LLC
 Address : 6100 W SAM HOUSTON PKWY N HOUSTON, TX 77041-5113, UNITED STATES OF AMERICA
 EUT : Mobile Digital Video Recorder
 Model Name : 4112-HVR
 Trademark : SAFETY VISION

Measurement Procedure Used:

APPLICABLE STANDARDS	
STANDARD	TEST RESULT
FCC 47 CFR Part 15, Subpart E	PASS

The above equipment was tested by EMTEK (SHENZHEN) CO., LTD. The test data, data evaluation, test procedures, and equipment configurations shown in this report were made in accordance with the procedures given in ANSI C63.10 (2013) and the energy emitted by the sample EUT tested as described in this report is in compliance with the requirements of FCC Part 15.407

The test results of this report relate only to the tested sample identified in this report.

Date of Test : Oct. 20, 2020 to Nov. 23, 2020

Prepared by:



Sewen Guo /Editor

Reviewer:



Joe Xia /Supervisor

Approve & Authorized Signer :



Lisa Wang/Manager



TABLE OF CONTENTS

1	TEST RESULT CERTIFICATION	2
2	EUT TECHNICAL DESCRIPTION	4
3	SUMMARY OF TEST RESULT	5
4	TEST METHODOLOGY	6
4.1	GENERAL DESCRIPTION OF APPLIED STANDARDS	6
4.2	MEASUREMENT EQUIPMENT USED	6
4.3	DESCRIPTION OF TEST MODES	7
5	FACILITIES AND ACCREDITATIONS	9
5.1	FACILITIES	9
5.2	LABORATORY ACCREDITATIONS AND LISTINGS	9
6	TEST SYSTEM UNCERTAINTY	10
7	SETUP OF EQUIPMENT UNDER TEST	11
7.1	RADIO FREQUENCY TEST SETUP	11
7.2	RADIO FREQUENCY TEST SETUP	11
7.3	CONDUCTED EMISSION TEST SETUP	13
7.4	BLOCK DIAGRAM CONFIGURATION OF TEST SYSTEM	14
7.5	SUPPORT EQUIPMENT	14
8	TEST REQUIREMENTS	15
8.1	BANDWIDTH MEASUREMENT	15
8.2	MAXIMUM CONDUCTED OUTPUT POWER	47
8.3	MAXIMUM PEAK POWER DENSITY	51
8.4	FREQUENCY STABILITY	69
8.5	UNDESIRABLE RADIATED SPURIOUS EMISSION	74
8.6	POWER LINE CONDUCTED EMISSIONS	93
8.7	ANTENNA APPLICATION	94

2 EUT TECHNICAL DESCRIPTION

Characteristics	Description	
Product	Mobile Digital Video Recorder	
Model Number	4112-HVR	
Sample number	1#	
Wifi Type	<input checked="" type="checkbox"/> UNII-1: 5150MHz-5250MHz Band <input checked="" type="checkbox"/> UNII-3 with 5725MHz-5850MHz Band	
WLAN Supported	<input checked="" type="checkbox"/> 802.11a <input checked="" type="checkbox"/> 802.11n(20MHz channel bandwidth) <input checked="" type="checkbox"/> 802.11n(40MHz channel bandwidth) <input checked="" type="checkbox"/> 802.11ac(20MHz channel bandwidth) <input checked="" type="checkbox"/> 802.11ac(40MHz channel bandwidth) <input checked="" type="checkbox"/> 802.11ac(80MHz channel bandwidth)	
Data Rate	802.11a:54/48/36/24/18/12/9/6Mbps 802.11n:up to 300 Mbps 802.11ac:up to 867Mbps	
Modulation	<input checked="" type="checkbox"/> OFDM with BPSK/QPSK/16QAM/64QAM for 802.11a/n; <input checked="" type="checkbox"/> OFDM with BPSK/QPSK/16QAM/64QAM/256QAM for 802.11ac;	
Frequency Range	<input checked="" type="checkbox"/> UNII-1: 5150MHz-5250MHz Band	
	<input checked="" type="checkbox"/> 5180-5240MHz for 802.11a; <input checked="" type="checkbox"/> 5180-5240MHz for 802.11n(HT20); <input checked="" type="checkbox"/> 5180-5240MHz for 802.11ac(HT20);	<input checked="" type="checkbox"/> 5190-5230MHz for 802.11n(HT40); <input checked="" type="checkbox"/> 5190-5230MHz for 802.11ac(HT40); <input checked="" type="checkbox"/> 5210MHz for 802.11ac(HT80);
	<input checked="" type="checkbox"/> UNII-3 with 5725MHz-5850MHz Band	
	<input checked="" type="checkbox"/> 5745-5825MHz for 802.11a; <input checked="" type="checkbox"/> 5745-5825MHz for 802.11n(HT20); <input checked="" type="checkbox"/> 5745-5825MHz for 802.11ac(HT20);	<input checked="" type="checkbox"/> 5755-5795MHz for 802.11n(HT40); <input checked="" type="checkbox"/> 5755-5795MHz for 802.11ac(HT40); <input checked="" type="checkbox"/> 5775MHz for 802.11ac(HT80);
TPC Function	<input type="checkbox"/> Applicable	<input checked="" type="checkbox"/> Not Applicable
Antenna Type	External Antennna	
Antenna Gain	2 dBi	
Transmit Power	Output Power (Max.) for UNII-1	12.42dBm
	Output Power (Max.) for UNII-3	11.74dBm
Power supply	DC 8-36V	

Note: for more details, please refer to the User's manual of the EUT.

3 SUMMARY OF TEST RESULT

FCC Part Clause	Test Parameter	Verdict	Remark
15.407 (a) 15.407 (e)	99% , 6dB and 26dB Bandwidth	PASS	
15.407 (a)	Maximum Conducted Output Power	PASS	
15.407 (a)	Peak Power Spectral Density	PASS	
15.407 (b)	Radiated Spurious Emission	PASS	
15.407(g)	Frequency Stability	PASS	
15.407 (b)(6) 15.207	Power Line Conducted Emission	PASS	
15.407(a) 15.203	Antenna Application	PASS	
NOTE1: N/A (Not Applicable) Remark: The test method refers to KDB 789033 and FCC 47 CFR Part 2, Subpart J			

RELATED SUBMITTAL(S) / GRANT(S):

This submittal(s) (test report) is intended for FCC ID: 2ANKU-4112-HVR filing to comply with Section 15.407 of the FCC Part 15, Subpart E Rules.

4 TEST METHODOLOGY

4.1 GENERAL DESCRIPTION OF APPLIED STANDARDS

According to its specifications, the EUT must comply with the requirements of the following standards:

FCC 47 CFR Part 15, Subpart E

4.2 MEASUREMENT EQUIPMENT USED

4.2.1 Conducted Emission Test Equipment

EQUIPMENT TYPE	MFR	MODEL NUMBER	SERIAL NUMBER	LASTCAL.	DUE CAL.
Test Receiver	Rohde & Schwarz	ESCS30	828985/018	05/16/2020	05/15/2021
L.I.S.N.	Schwarzbeck	NNLK8129	8129203	05/16/2020	05/15/2021
50Ω Coaxial Switch	Anritsu	MP59B	M20531	05/16/2020	05/15/2021
Pulse Limiter	Rohde & Schwarz	ESH3-Z2	100006	05/16/2020	05/15/2021
Voltage Probe	Rohde & Schwarz	TK9416	N/A	05/16/2020	05/15/2021
I.S.N	Rohde & Schwarz	ENY22	1109.9508.02	05/16/2020	05/15/2021

4.2.2 Radiated Emission Test Equipment

EQUIPMENT TYPE	MFR	MODEL NUMBER	SERIAL NUMBER	LAST CAL.	DUE CAL.
EMI Test Receiver	Rohde & Schwarz	ESU	1302.6005.26	05/16/2020	05/15/2021
Pre-Amplifier	HP	8447D	2944A07999	05/16/2020	05/15/2021
Bilog Antenna	Schwarzbeck	VULB9163	142	05/16/2020	05/15/2021
Loop Antenna	ARA	PLA-1030/B	1029	05/16/2020	05/15/2021
Horn Antenna	Schwarzbeck	BBHA 9170	BBHA9170399	05/16/2020	05/15/2021
Horn Antenna	Schwarzbeck	BBHA 9120	D143	05/16/2020	05/15/2021
Cable	Schwarzbeck	AK9513	ACRX1	05/16/2020	05/15/2021
Cable	Rosenberger	N/A	FP2RX2	05/16/2020	05/15/2021
Cable	Schwarzbeck	AK9513	CRPX1	05/16/2020	05/15/2021
Cable	Schwarzbeck	AK9513	CRRX2	05/16/2020	05/15/2021

4.2.3 Radio Frequency Test Equipment

EQUIPMENT TYPE	MFR	MODEL NUMBER	SERIAL NUMBER	LASTCAL.	DUE CAL.
Spectrum Analyzer	Agilent	E4407B	88156318	05/16/2020	05/15/2021
Signal Analyzer	Agilent	N9010A	My53470879	05/16/2020	05/15/2021
Power meter	Anritsu	ML2495A	0824006	05/16/2020	05/15/2021
Power sensor	Anritsu	MA2411B	0738172	05/16/2020	05/15/2021
Temperature & Humidity Chamber	YINHE	SDH0525F	2003003	05/16/2020	05/15/2021

Remark: Each piece of equipment is scheduled for calibration once a year.

4.3 DESCRIPTION OF TEST MODES

The EUT has been tested under its typical operating condition.

The EUT configuration for testing is installed on RF field strength measurement to meet the Commissions requirement and operating in a manner which intends to maximize its emission characteristics in a continuous normal application.

The Transmitter was operated in the normal operating mode. The TX frequency was fixed which was for the purpose of the measurements.

Test of channel included the lowest and middle and highest frequency to perform the test, then record on this report.

Pre-defined engineering program for regulatory testing used to control the EUT for staying in continuous transmitting and receiving mode is programmed.

Wifi 5G with U-NII - 1

Frequency and Channel list for 802.11a/n (HT20)/802.11ac (HT20):

Channel	Frequency (MHz)	Channel	Frequency (MHz)	Channel	Frequency (MHz)
36	5180	44	5220		
40	5200	48	5240		

Frequency and Channel list for 802.11n (HT40)/ 802.11ac (HT40):

Channel	Frequency (MHz)	Channel	Frequency (MHz)	Channel	Frequency (MHz)
38	5190				
46	5230				

Frequency and Channel list for 802.11ac Wave2 (HT80):

Channel	Frequency (MHz)	Channel	Frequency (MHz)	Channel	Frequency (MHz)
42	5210				

Test Frequency and Channel for 802.11a/n (HT20)/802.11ac (HT20):

Lowest Frequency		Middle Frequency		Highest Frequency	
Channel	Frequency (MHz)	Channel	Frequency (MHz)	Channel	Frequency (MHz)
36	5180	40	5200	48	5240

Test Frequency and channel for 802.11n (HT40)/ 802.11ac (HT40):

Lowest Frequency		Middle Frequency		Highest Frequency	
Channel	Frequency (MHz)	Channel	Frequency (MHz)	Channel	Frequency (MHz)
38	5190	N/A	N/A	46	5230

Test Frequency and channel for 802.11ac Wave2 (HT80):

Lowest Frequency		Middle Frequency		Highest Frequency	
Channel	Frequency (MHz)	Channel	Frequency (MHz)	Channel	Frequency (MHz)
42	5210	N/A	N/A	N/A	N/A

Wifi 5G with U-NII -3

Frequency and Channel list for 802.11a/n (HT20)/802.11ac (HT20):

Channel	Frequency (MHz)	Channel	Frequency (MHz)	Channel	Frequency (MHz)
149	5745	157	5785	165	5825
153	5765	161	5805		

Frequency and Channel list for 802.11n (HT40)/ 802.11ac (HT40):

Channel	Frequency (MHz)	Channel	Frequency (MHz)	Channel	Frequency (MHz)
151	5755				
159	5795				

Frequency and Channel list for 802.11ac (HT80):

Channel	Frequency (MHz)	Channel	Frequency (MHz)	Channel	Frequency (MHz)
155	5775				

Test Frequency and Channel for 802.11a/n (HT20)/802.11ac (HT20):

Lowest Frequency		Middle Frequency		Highest Frequency	
Channel	Frequency (MHz)	Channel	Frequency (MHz)	Channel	Frequency (MHz)
149	5745	157	5785	165	5825

Test Frequency and channel for 802.11n (HT40)/ 802.11ac (HT40):

Lowest Frequency		Middle Frequency		Highest Frequency	
Channel	Frequency (MHz)	Channel	Frequency (MHz)	Channel	Frequency (MHz)
151	5755	N/A	N/A	159	5795

Test Frequency and channel for 802.11ac (HT80):

Lowest Frequency		Middle Frequency		Highest Frequency	
Channel	Frequency (MHz)	Channel	Frequency (MHz)	Channel	Frequency (MHz)
155	5775				

5 FACILITIES AND ACCREDITATIONS

5.1 FACILITIES

All measurement facilities used to collect the measurement data are located at

Building 69, Majialong Industry Zone District, Nanshan District, Shenzhen, China

The sites are constructed in conformance with the requirements of ANSI C63.7, ANSI C63.10 and CISPR Publication 22.

5.2 LABORATORY ACCREDITATIONS AND LISTINGS

Site Description

EMC Lab.

: Accredited by CNAS, 2018.11.30

The certificate is valid until 2022.10.28

The Laboratory has been assessed and proved to be in compliance with CNAS-CL01:2006 (identical to ISO/IEC 17025:2017)

The Certificate Registration Number is L2291

Accredited by FCC,

Designation Number: CN1204

Test Firm Registration Number: 882943

Accredited by A2LA, August 25, 2020

The Certificate Registration Number is 4321.01

Accredited by Industry Canada, November 09, 2018

The Conformity Assessment Body Identifier is CN0008

Name of Firm

: EMTEK(SHENZHEN) CO., LTD.

Site Location

: Building 69, Majialong Industry Zone,
Nanshan District, Shenzhen, Guangdong, China

6 TEST SYSTEM UNCERTAINTY

The following measurement uncertainty levels have been estimated for tests performed on the apparatus:

Parameter	Uncertainty
Radio Frequency	$\pm 1 \times 10^{-5}$
Maximum Peak Output Power Test	$\pm 1.0\text{dB}$
Conducted Emissions Test	$\pm 2.0\text{dB}$
Radiated Emission Test	$\pm 2.0\text{dB}$
Power Density	$\pm 2.0\text{dB}$
Occupied Bandwidth Test	$\pm 1.0\text{dB}$
Band Edge Test	$\pm 3\text{dB}$
All emission, radiated	$\pm 3\text{dB}$
Antenna Port Emission	$\pm 3\text{dB}$
Temperature	$\pm 0.5^\circ\text{C}$
Humidity	$\pm 3\%$

Measurement Uncertainty for a level of Confidence of 95%

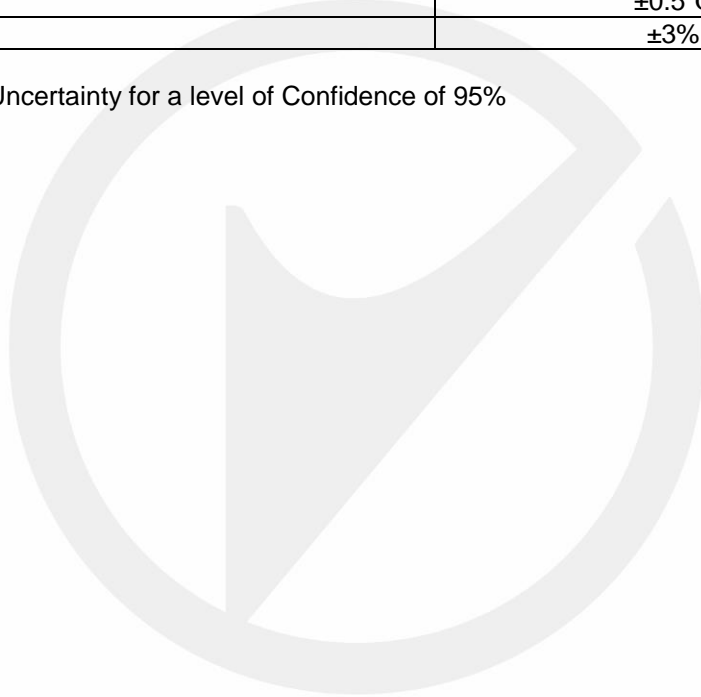

7 SETUP OF EQUIPMENT UNDER TEST

7.1 RADIO FREQUENCY TEST SETUP

The WLAN component's antenna ports(s) of the EUT are connected to the measurement instrument per an appropriate attenuator. The EUT is controlled by PC/software to emit the specified signals for the purpose of measurements.

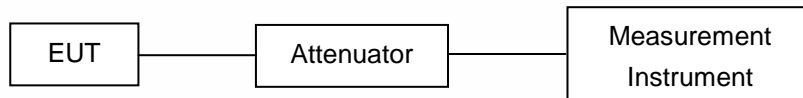

7.2 RADIO FREQUENCY TEST SETUP

The test site semi-anechoic chamber has met the requirement of NSA tolerance 4 dB according to the standards: ANSI C63.10. The test distance is 3m. The setup is according to the requirements in Section 13.1.4.1 of ANSI C63.10-2013 and CAN/CSA-CEI/IEC CISPR 22.

Below 30MHz:

The EUT is placed on a turntable 0.8 meters above the ground in the chamber, 3 meter away from the antenna (loop antenna). The Antenna should be positioned with its plane vertical at the specified distance from the EUT and rotated about its vertical axis for maximum response at each azimuth about the EUT. The center of the loop shall be 1 m above the ground. For certain applications, the loop antenna plane may also need to be positioned horizontally at the specified distance from the EUT.

Above 30MHz:

The EUT is placed on a turntable 0.8 meters above the ground in the chamber, 3 meter away from the antenna. The maximal emission value is acquired by adjusting the antenna height, polarisation and turntable azimuth. Normally, the height range of antenna is 1 m to 4 m, the azimuth range of turntable is 0° to 360°, and the receive antenna has two polarizations Vertical (V) and Horizontal (H).

Above 1GHz:

(Note: the FCC's permission to use 1.5m as an alternative per TCBC Conf call of Dec. 2, 2014.)

The EUT is placed on a turntable 1.5 meters above the ground in the chamber, 3 meter away from the antenna. The maximal emission value is acquired by adjusting the antenna height, polarisation and turntable azimuth. Normally, the height range of antenna is 1 m to 4 m, the azimuth range of turntable is 0° to 360°, and the receive antenna has two polarizations Vertical (V) and Horizontal (H).

(a) Radiated Emission Test Set-Up, Frequency Below 30MHz

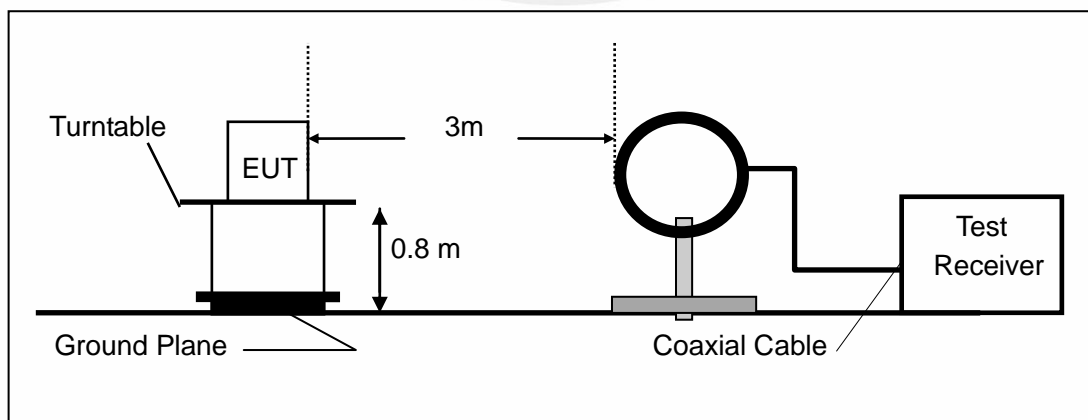

(b) Radiated Emission Test Set-Up, Frequency Below 1000MHz

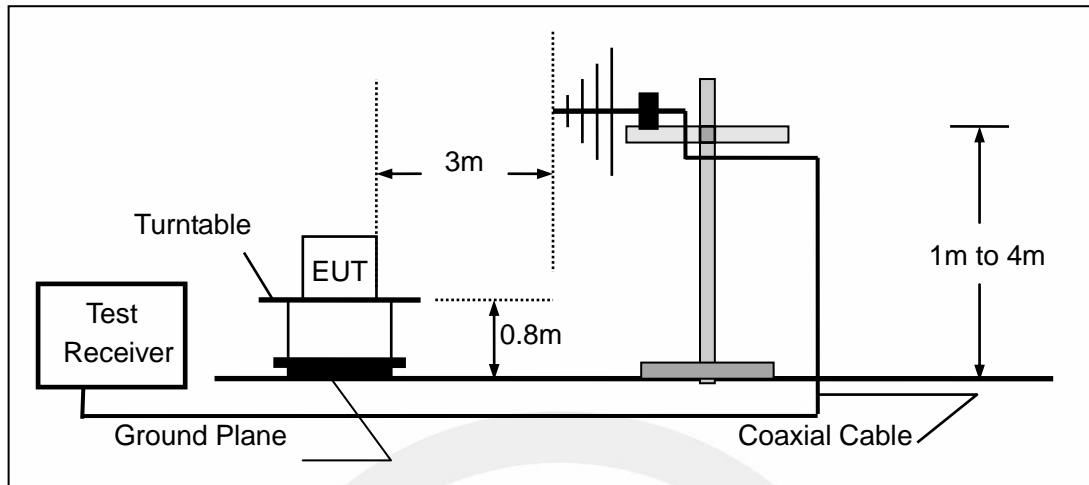

(c) Radiated Emission Test Set-Up, Frequency above 1000MHz

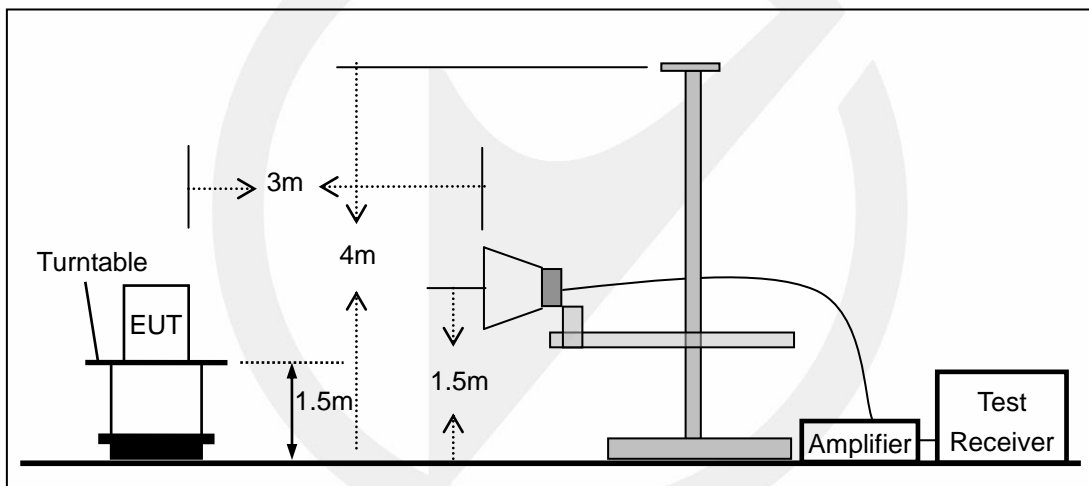

7.3 CONDUCTED EMISSION TEST SETUP

The mains cable of the EUT (maybe per AC/DC Adapter) must be connected to LISN. The LISN shall be placed 0.8 m from the boundary of EUT and bonded to a ground reference plane for LISN mounted on top of the ground reference plane. This distance is between the closest points of the LISN and the EUT. All other units of the EUT and associated equipment shall be at least 0.8m from the LISN.

Ground connections, where required for safety purposes, shall be connected to the reference ground point of the LISN and, where not otherwise provided or specified by the manufacturer, shall be of same length as the mains cable and run parallel to the mains connection at a separation distance of not more than 0.1 m.

According to the requirements in Section 13.1.4.1 of ANSI C63.10-2013 Conducted emissions from the EUT measured in the frequency range between 0.15 MHz and 30 MHz using CISPR Quasi-Peak and average detector mode.

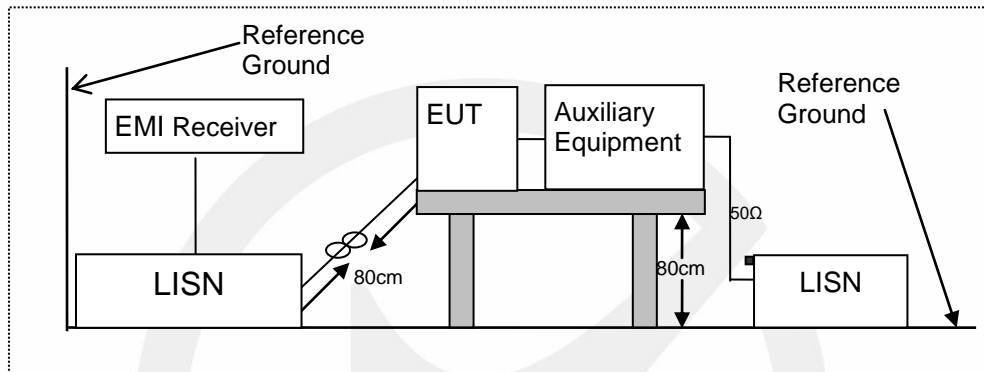

7.4 BLOCK DIAGRAM CONFIGURATION OF TEST SYSTEM

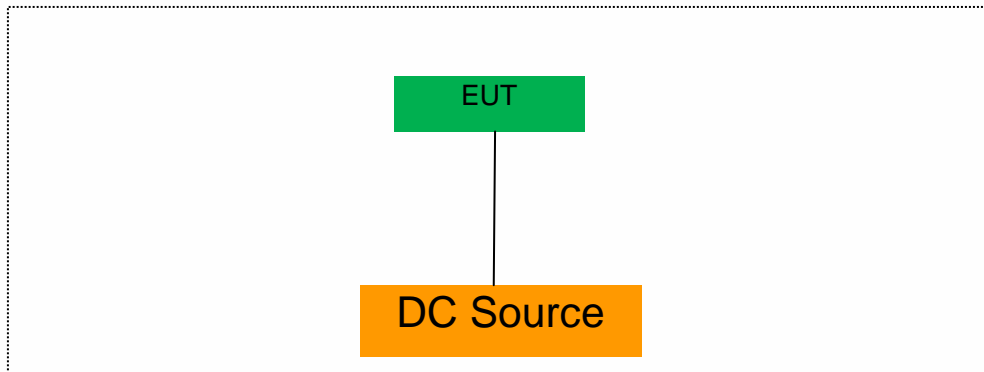

7.5 SUPPORT EQUIPMENT

EUT Cable List and Details			
Cable Description	Length (m)	Shielded/Unshielded	With / Without Ferrite
/	/	/	/

Auxiliary Cable List and Details			
Cable Description	Length (m)	Shielded/Unshielded	With / Without Ferrite
/	/	/	/

Auxiliary Equipment List and Details			
Description	Manufacturer	Model	Serial Number
Notebook	acer	ZR1	LXTECOCO76643158 372500

Notes:

- 1.All the equipment/cables were placed in the worst-case configuration to maximize the emission during the test.
- 2.Grounding was established in accordance with the manufacturer’s requirements and conditions for the intended use.

8 TEST REQUIREMENTS

8.1 BANDWIDTH MEASUREMENT

8.1.1 Applicable Standard

According to FCC Part 15.407(a)(1) for UNII Band I
According to FCC Part 15.407(a)(2) for UNII Band II-A and UNII Band II-C
According to FCC Part 15.407(a)(3) for UNII Band III
According to FCC Part 15.407(e) for UNII Band III
According to 789033 D02 Section II(C)
According to 789033 D02 Section II(D)

8.1.2 Conformance Limit

(1) For the band 5.15-5.25 GHz.

(iv) For mobile and portable client devices in the 5.15-5.25 GHz band, the maximum conducted output power over the frequency band of operation shall not exceed 250 mW provided the maximum antenna gain does not exceed 6 dBi. In addition, the maximum power spectral density shall not exceed 11 dBm in any 1 megahertz band. If transmitting antennas of directional gain greater than 6 dBi are used, both the maximum conducted output power and the maximum power spectral density shall be reduced by the amount in dB that the directional gain of the antenna exceeds 6 dBi.

(2) For the 5.25-5.35 GHz and 5.47-5.725 GHz bands, the maximum conducted output power over the frequency bands of operation shall not exceed the lesser of 250 mW or 11 dBm + 10 log B, where B is the 26 dB emission bandwidth in megahertz. In addition, the maximum power spectral density shall not exceed 11 dBm in any 1 megahertz band. If transmitting antennas of directional gain greater than 6 dBi are used, both the maximum conducted output power and the maximum power spectral density shall be reduced by the amount in dB that the directional gain of the antenna exceeds 6 dBi.

(3) For the band 5.725-5.85 GHz, the maximum conducted output power over the frequency band of operation shall not exceed 1 W. In addition, the maximum power spectral density shall not exceed 30 dBm in any 500-kHz band. If transmitting antennas of directional gain greater than 6 dBi are used, both the maximum conducted output power and the maximum power spectral density shall be reduced by the amount in dB that the directional gain of the antenna exceeds 6 dBi. However, fixed point-to-point U-NII devices operating in this band may employ transmitting antennas with directional gain greater than 6 dBi without any corresponding reduction in transmitter conducted power. Fixed, point-to-point operations exclude the use of point-to-multipoint systems, omnidirectional applications, and multiple collocated transmitters transmitting the same information. The operator of the U-NII device, or if the equipment is professionally installed, the installer, is responsible for ensuring that systems employing high gain directional antennas are used exclusively for fixed, point-to-point operations.

(e) Within the 5.725-5.85 GHz band, the minimum 6 dB bandwidth of U-NII devices shall be at least 500 kHz.

8.1.3 Test Configuration

Test according to clause 6.1 radio frequency test setup

8.1.4 Test Procedure

According to 789033 D02 v02r01 section C&D, the following is the measurement procedure.

1. Emission Bandwidth (EBW)

- a) Set RBW = approximately 1% of the emission bandwidth.
- b) Set the VBW > RBW.
- c) Detector = Peak.
- d) Trace mode = max hold.
- e) Measure the maximum width of the emission that is 26 dB down from the maximum of the emission.

Compare this with the RBW setting of the analyzer. Readjust RBW and repeat measurement as needed until the RBW/EBW ratio is approximately 1%.

2. Minimum Emission Bandwidth for the band 5.725-5.85 GHz

Section 15.407(e) specifies the minimum 6 dB emission bandwidth of at least 500 KHz for the band 5.715-5.85 GHz. The following procedure shall be used for measuring this bandwidth:

- a) Set RBW = 100 kHz.
- b) Set the video bandwidth (VBW) $\geq 3 \times$ RBW.
- c) Detector = Peak.
- d) Trace mode = max hold.
- e) Sweep = auto couple.
- f) Allow the trace to stabilize.
- g) Measure the maximum width of the emission that is constrained by the frequencies associated with the two outermost amplitude points (upper and lower frequencies) that are attenuated by 6 dB relative to the maximum level measured in the fundamental emission.

Note: The automatic bandwidth measurement capability of a spectrum analyzer or EMI receiver may be employed if it implements the functionality described above.

D. 99 Percent Occupied Bandwidth

The 99-percent occupied bandwidth is the frequency bandwidth such that, below its lower and above its upper frequency limits, the mean powers are each equal to 0.5 % of the total mean power of the given emission. Measurement of the 99-percent occupied bandwidth is required only as a condition for using the optional band-edge measurement techniques described in section II.G.3.d). Measurements of 99-percent occupied bandwidth may also optionally be used in lieu of the EBW to 789033 D02 v01r02 General UNII Test Procedures New Rules v01 define the minimum frequency range over which the spectrum is integrated when measuring maximum conducted output power as described in section II.E. However, the EBW must be measured to determine bandwidth dependent limits on maximum conducted output power in accordance with 15.407(a).

The following procedure shall be used for measuring (99 %) power bandwidth:

1. Set center frequency to the nominal EUT channel center frequency.
2. Set span = 1.5 times to 5.0 times the OBW.
3. Set RBW = 1 % to 5 % of the OBW
4. Set VBW $\geq 3 \cdot$ RBW
5. Video averaging is not permitted. Where practical, a sample detection and single sweep mode shall be used. Otherwise, peak detection and max hold mode (until the trace stabilizes) shall be used.
6. Use the 99 % power bandwidth function of the instrument (if available).
7. If the instrument does not have a 99 % power bandwidth function, the trace data points are recovered and directly summed in power units. The recovered amplitude data points, beginning at the lowest frequency, are placed in a running sum until 0.5 % of the total is reached; that frequency is recorded as the lower frequency. The process is repeated until 99.5 % of the total is reached; that frequency is recorded as the upper frequency. The 99% occupied bandwidth is the difference between these two frequencies.

8.1.5 Test Results

5150-5250MHz

Test Mode	Test Channel MHz		26 dB Bandwidth MHz	99% Bandwidth MHz	Verdict
802.11a	CH36	5180	21.245	16.903	Pass
	CH40	5200	21.360	16.903	Pass
	CH48	5240	21.708	16.845	Pass
802.11n-HT20	CH36	5180	22.171	17.829	Pass
	CH40	5200	22.402	17.945	Pass
	CH48	5240	22.113	17.887	Pass
802.11ac(HT20)	CH36	5180	21.650	17.887	Pass
	CH40	5200	21.708	17.829	Pass
	CH48	5240	21.823	17.829	Pass
802.11n-HT40	CH38	5190	42.490	36.469	Pass
	CH46	5230	42.370	36.469	Pass
802.11ac(HT40)	CH38	5190	43.180	36.469	Pass
	CH46	5230	43.300	36.585	Pass
802.11ac(HT80)	CH42	5210	82.660	75.485	Pass

99% Occupied Bandwidth
Test Model 802.11a

U-NII - 1
Frequency(MHz)

5180

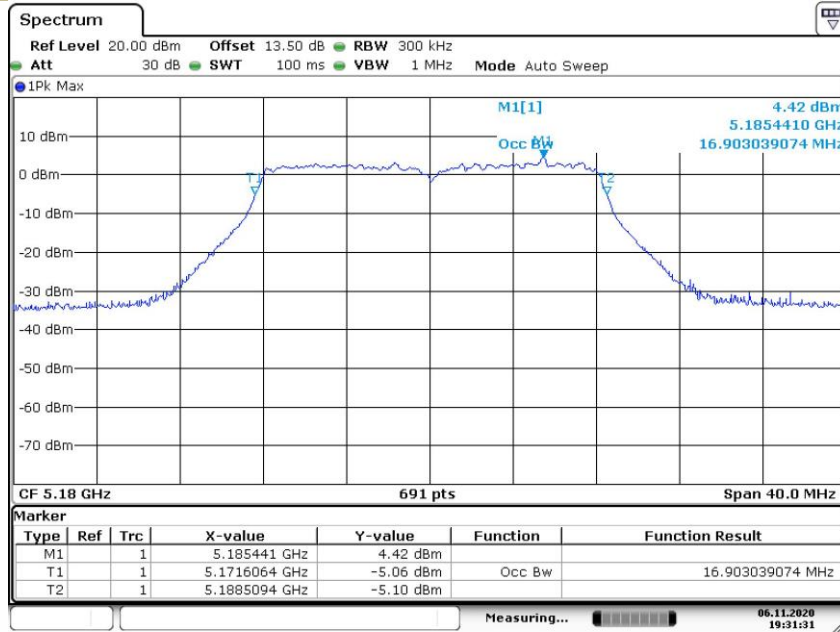

Date: 6.NOV.2020 19:31:31

99% Occupied Bandwidth
Test Model 802.11a

U-NII - 1
Frequency(MHz)

5200

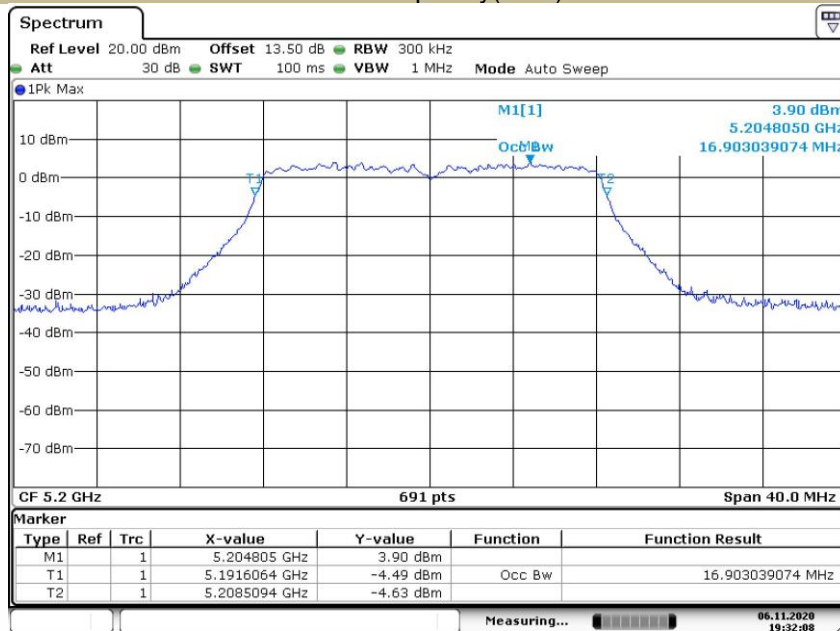

Date: 6.NOV.2020 19:32:09

99% Occupied Bandwidth
Test Model 802.11a

U-NII - 1
Frequency(MHz)

5240

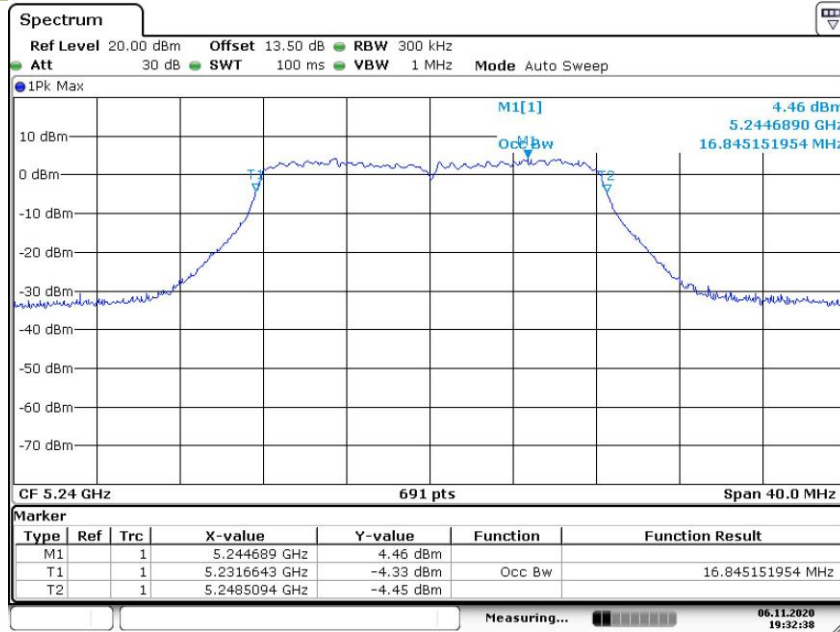

Date: 6.NOV.2020 19:32:38

99% Occupied Bandwidth
Test Model 802.11n-HT20

U-NII - 1
Frequency(MHz)

5180

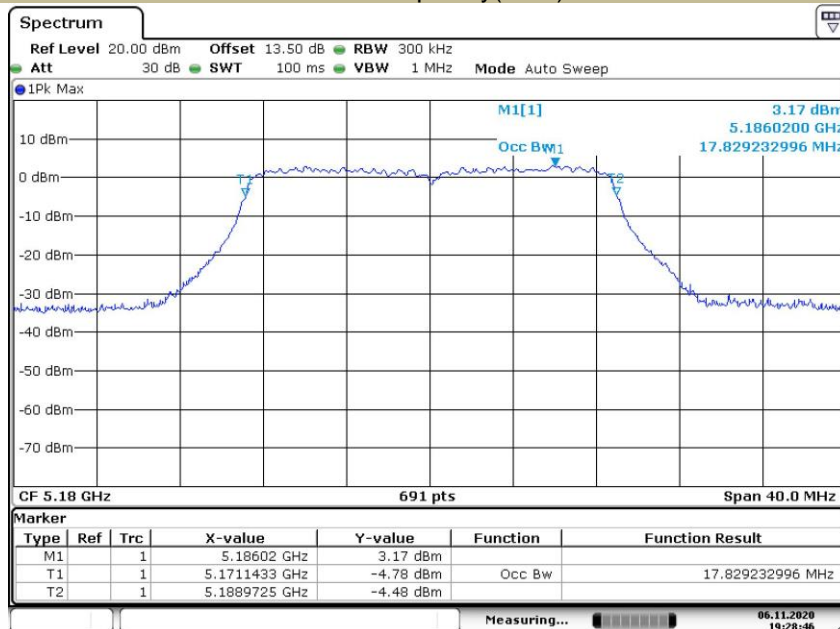

Date: 6.NOV.2020 19:28:46

99% Occupied Bandwidth
Test Model 802.11n-HT20

U-NII - 1
Frequency(MHz) 5200

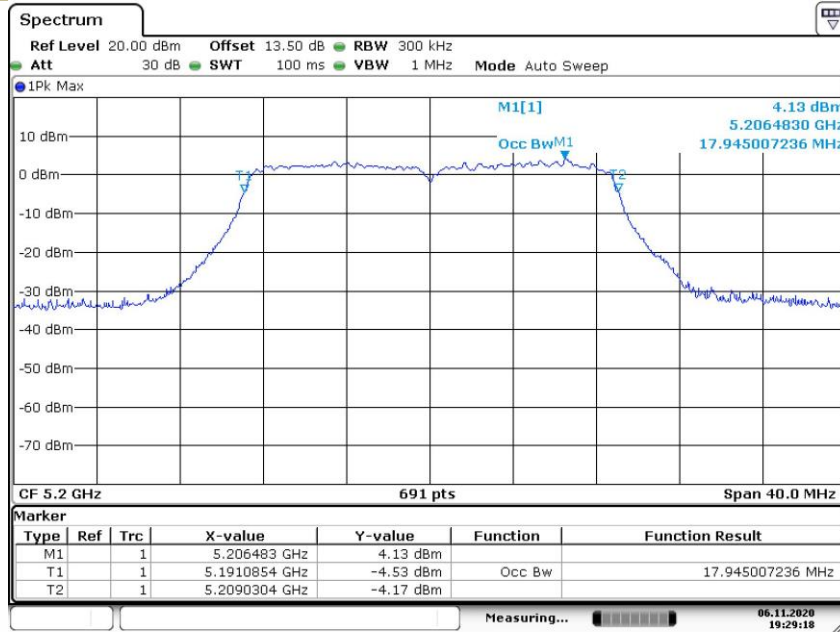

Date: 6.NOV.2020 19:29:18

99% Occupied Bandwidth
Test Model 802.11n-HT20

U-NII - 1
Frequency(MHz) 5240

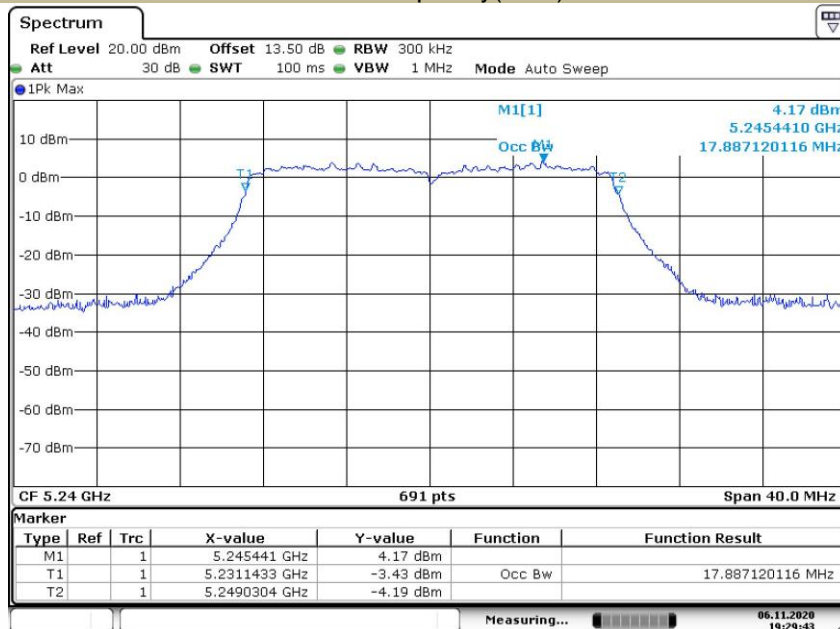

Date: 6.NOV.2020 19:29:44

99% Occupied Bandwidth
Test Model 802.11ac(HT20)

U-NII - 1
Frequency(MHz)

5180

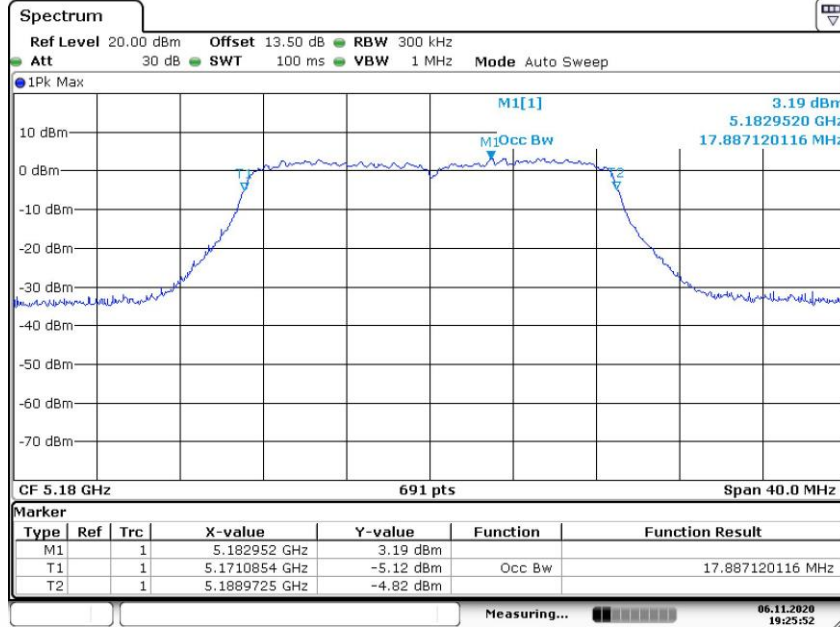

Date: 6.NOV.2020 19:25:53

99% Occupied Bandwidth
Test Model 802.11ac(HT20)

U-NII - 1
Frequency(MHz)

5200

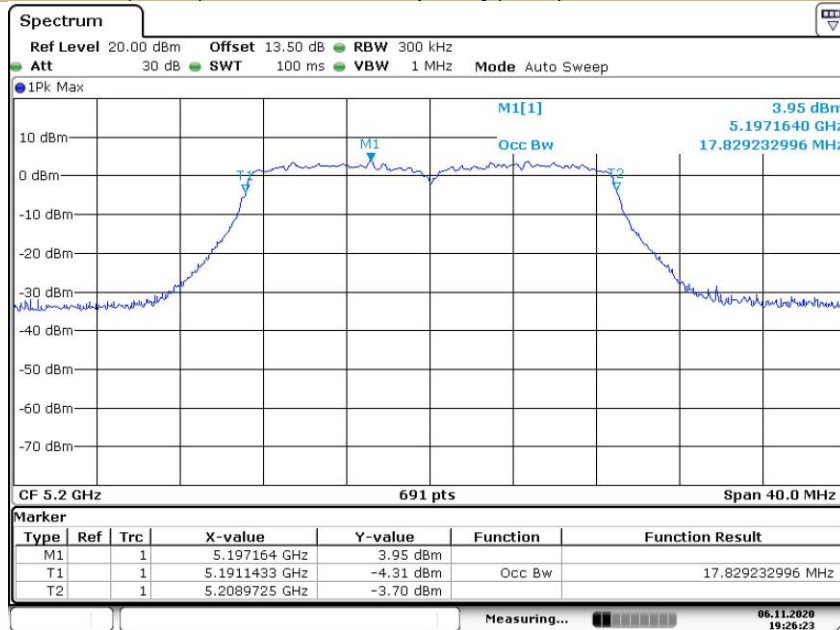

Date: 6.NOV.2020 19:26:23

99% Occupied Bandwidth
Test Model 802.11ac(HT20)

U-NII - 1
Frequency(MHz) 5240

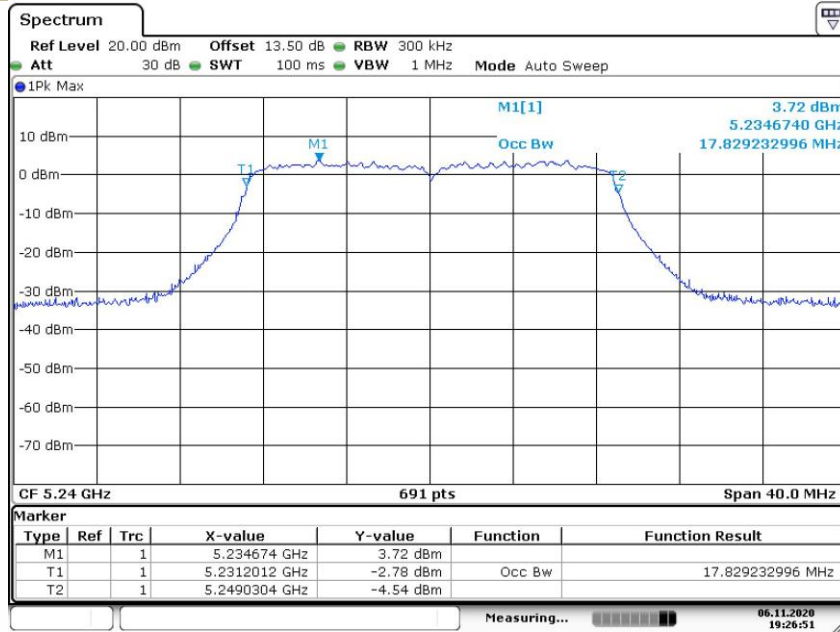

Date: 6.NOV.2020 19:26:52

99% Occupied Bandwidth
Test Model 802.11n-HT40

U-NII - 1
Frequency(MHz) 5190

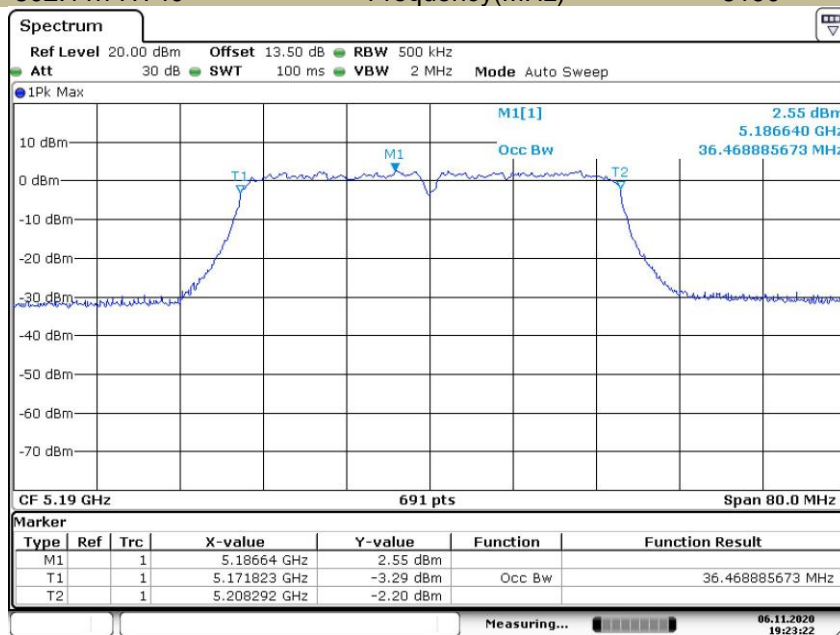

Date: 6.NOV.2020 19:23:22

99% Occupied Bandwidth
Test Model 802.11n-HT40

U-NII - 1
Frequency(MHz) 5230

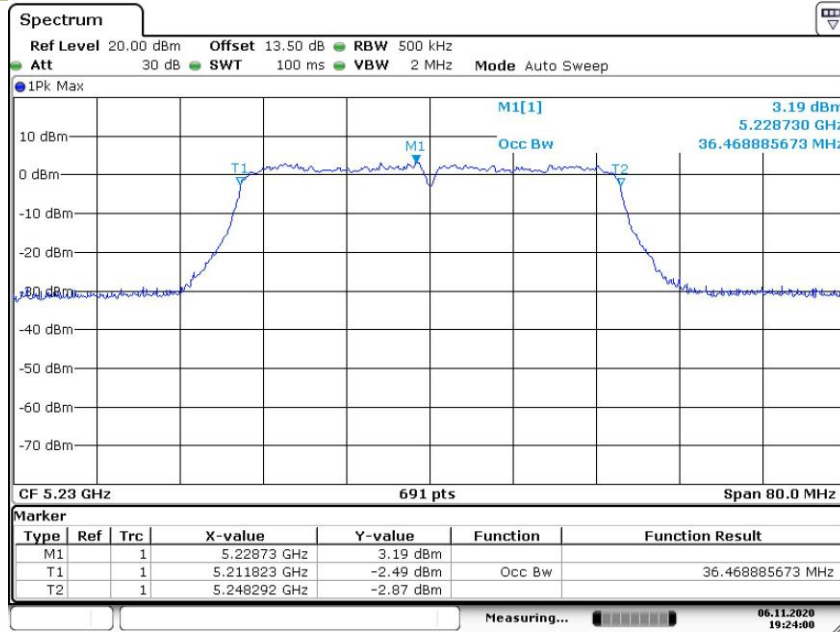

Date: 6.NOV.2020 19:24:00

99% Occupied Bandwidth
Test Model 802.11ac(HT40)

U-NII - 1
Frequency(MHz) 5190



Date: 6.NOV.2020 19:20:37

99% Occupied Bandwidth
Test Model 802.11ac(HT40)

U-NII - 1
Frequency(MHz) 5230

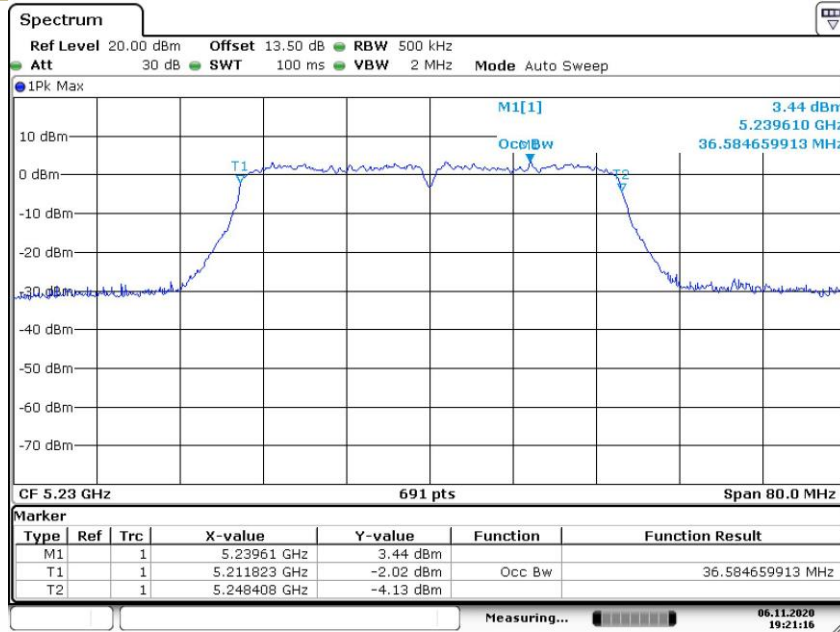

Date: 6.NOV.2020 19:21:17

99% Occupied Bandwidth
Test Model 802.11ac 80

U-NII - 1
Frequency(MHz) 5210

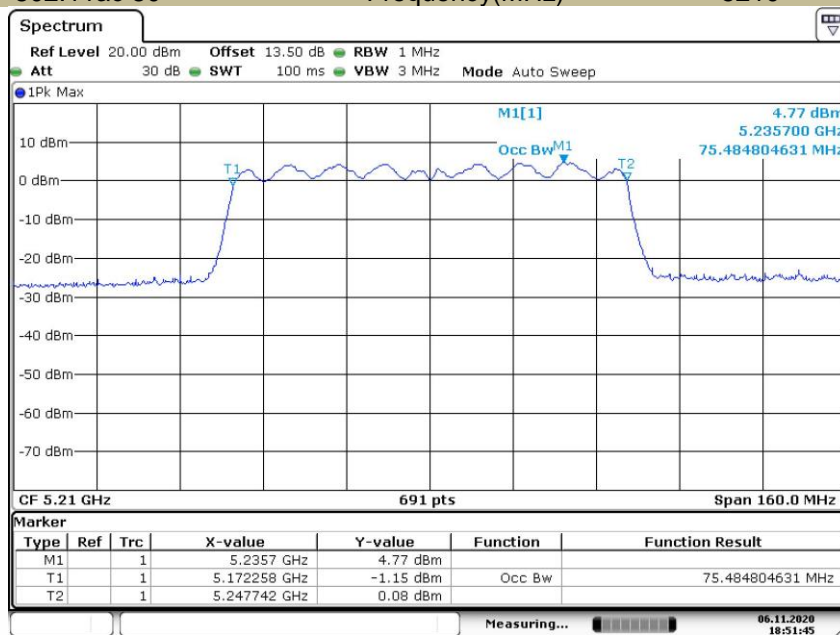

Date: 6.NOV.2020 18:51:45

26dB Emission Bandwidth

U-NII - 1

Test Model 802.11a

Frequency(MHz)

5180

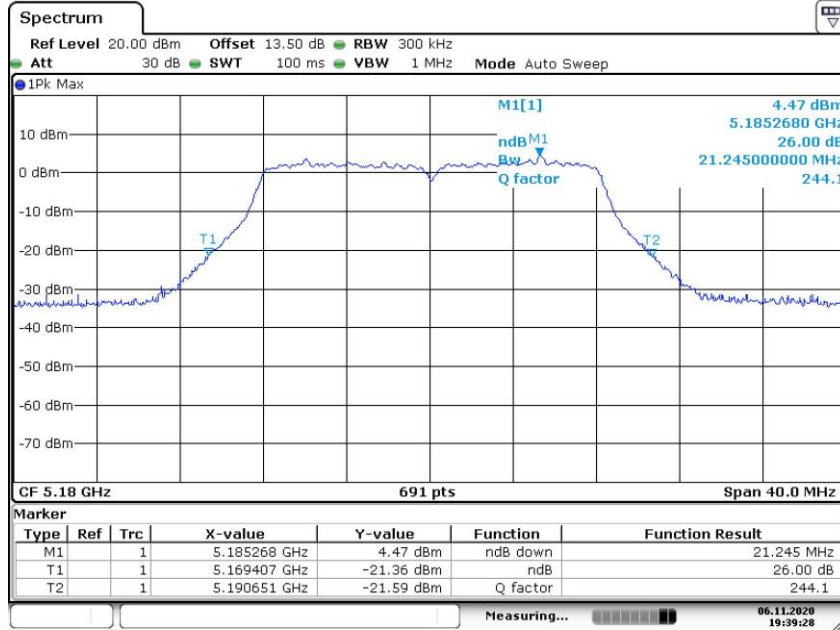

Date: 6.NOV.2020 19:39:28

26dB Emission Bandwidth

U-NII - 1

Test Model 802.11a

Frequency(MHz)

5200

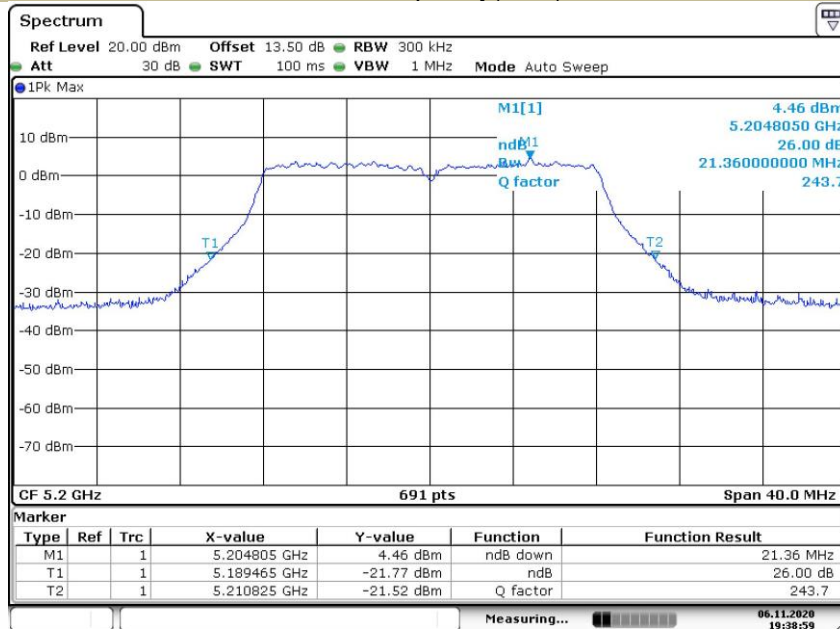

Date: 6.NOV.2020 19:38:59

26dB Emission Bandwidth

U-NII - 1

Test Model 802.11a

Frequency(MHz)

5240

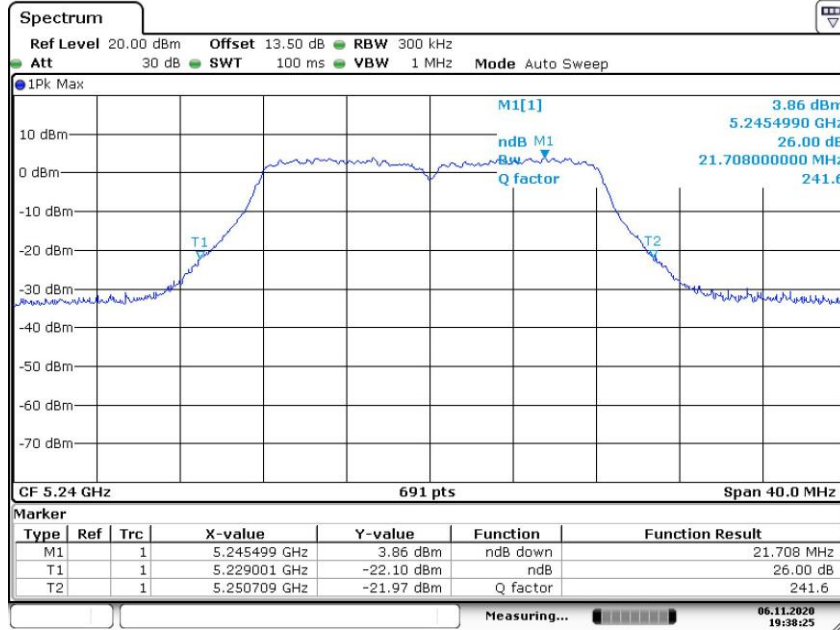

Date: 6.NOV.2020 19:38:25

26dB Emission Bandwidth

U-NII - 1

Test Model 802.11n-HT20

Frequency(MHz)

5180

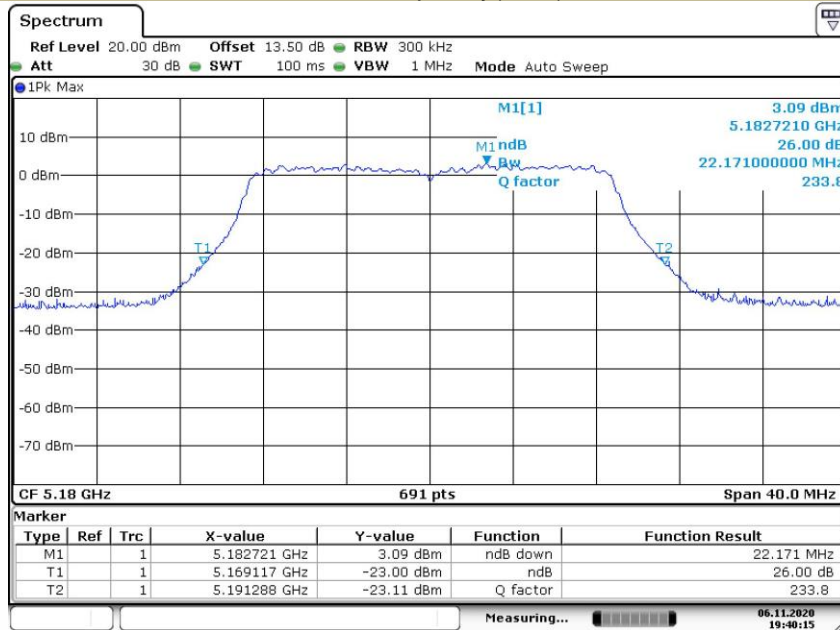

Date: 6.NOV.2020 19:40:15

26dB Emission Bandwidth U-NII - 1
 Test Model 802.11n-HT20 Frequency(MHz) 5200

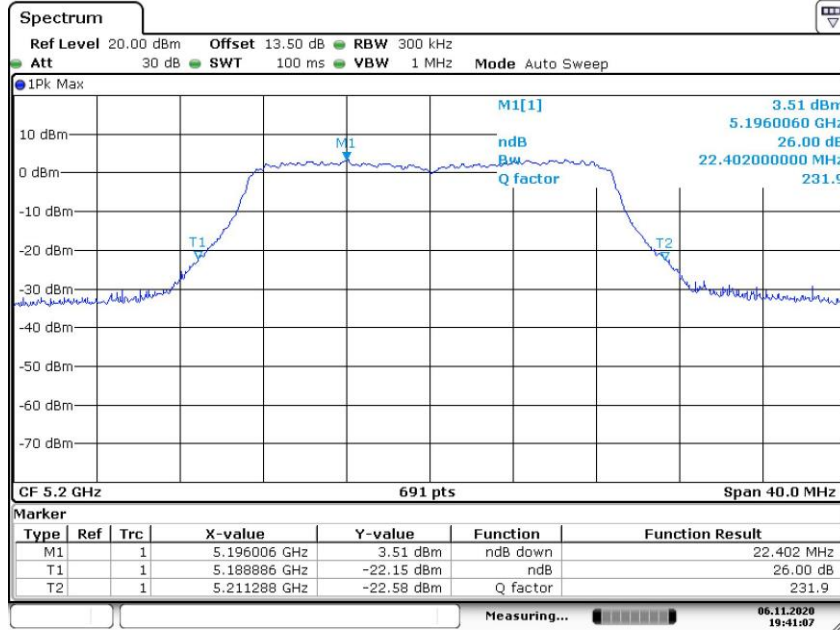

Date: 6.NOV.2020 19:41:07

26dB Emission Bandwidth U-NII - 1
 Test Model 802.11n-HT20 Frequency(MHz) 5240

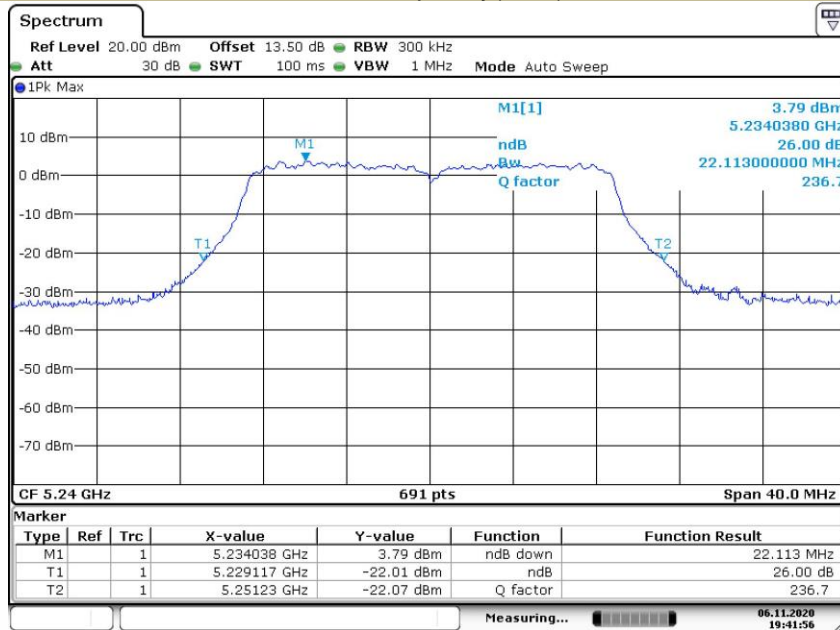

Date: 6.NOV.2020 19:41:55

26dB Emission Bandwidth
Test Model 802.11ac(HT20)

U-NII - 1
Frequency(MHz)

5180

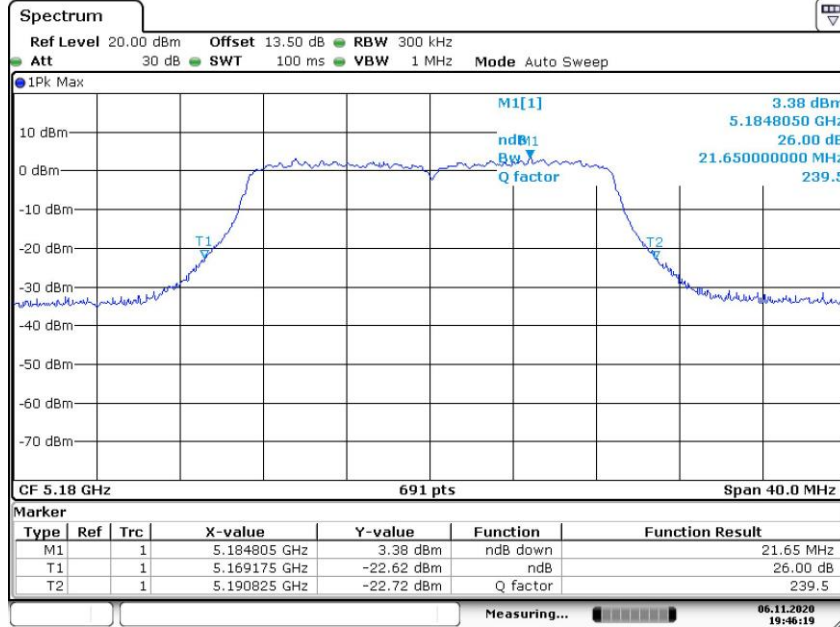

Date: 6.NOV.2020 19:46:19

26dB Emission Bandwidth
Test Model 802.11ac(HT20)

U-NII - 1
Frequency(MHz)

5200

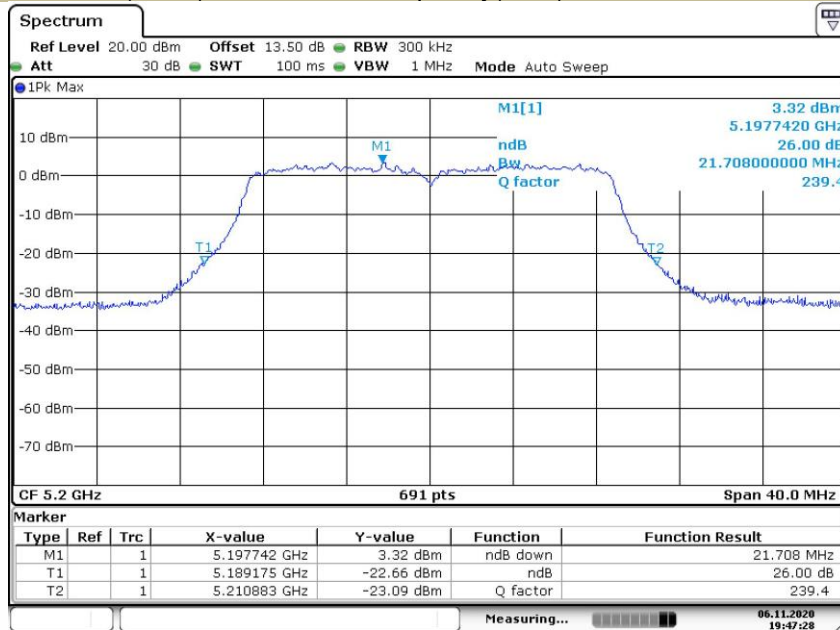

Date: 6.NOV.2020 19:47:28

26dB Emission Bandwidth **U-NII - 1**
Test Model 802.11ac(HT20) **Frequency(MHz)** 5240

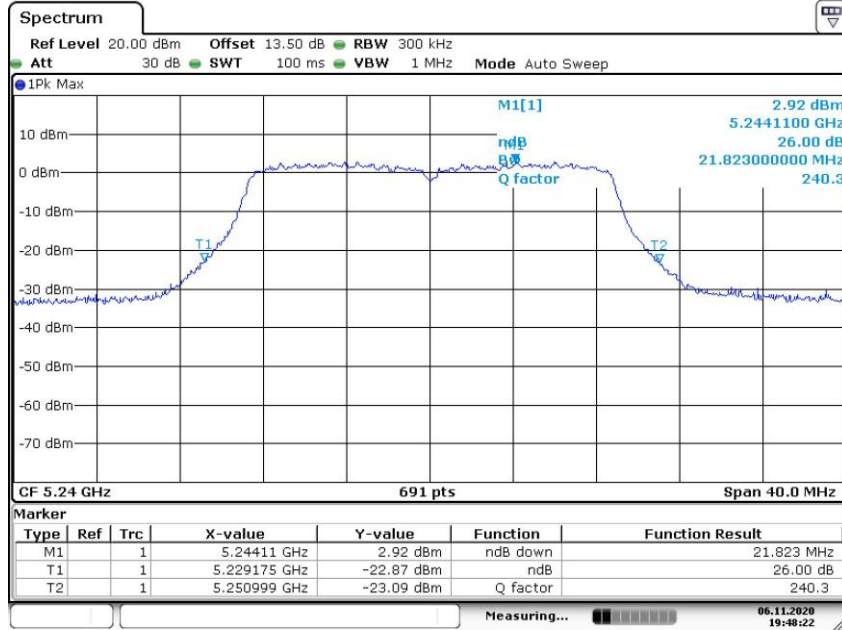

Date: 6.NOV.2020 19:48:22

26dB Emission Bandwidth **U-NII - 1**
Test Model 802.11n-HT40 **Frequency(MHz)** 5190

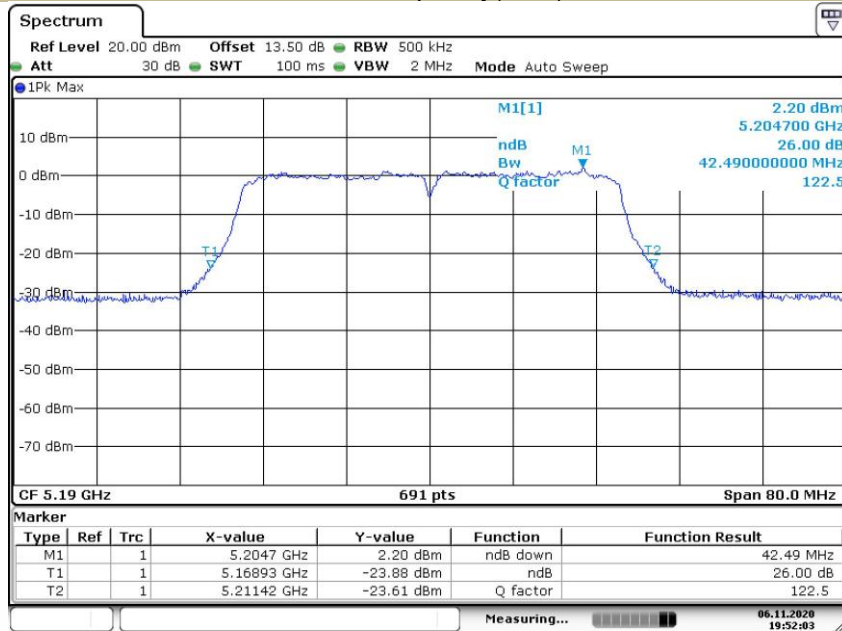

Date: 6.NOV.2020 19:52:03

26dB Emission Bandwidth
Test Model 802.11n-HT40

U-NII - 1
Frequency(MHz) 5230

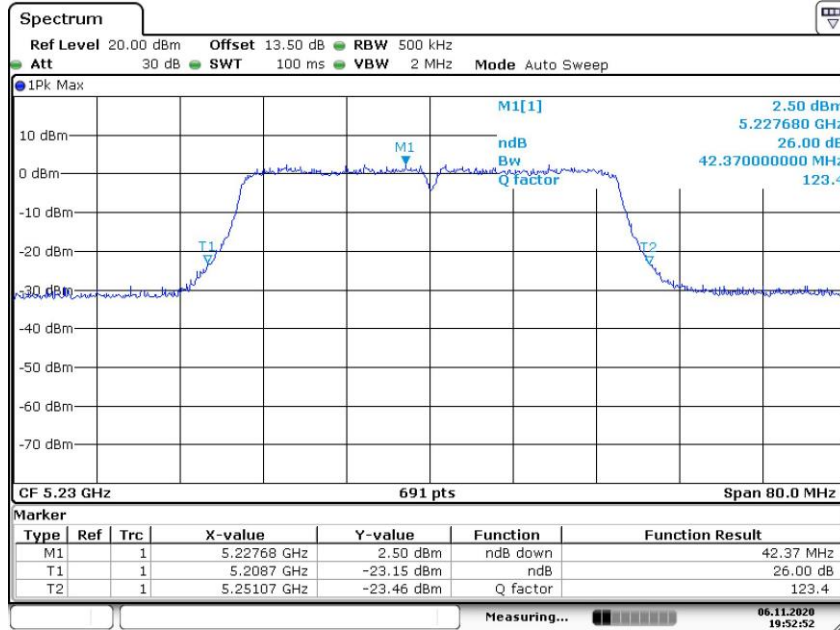

Date: 6.NOV.2020 19:52:52

26dB Emission Bandwidth
Test Model 802.11ac(HT40)

U-NII - 1
Frequency(MHz) 5190



Date: 6.NOV.2020 19:57:57

26dB Emission Bandwidth **U-NII - 1**
Test Model 802.11ac(HT40) **Frequency(MHz)** 5230

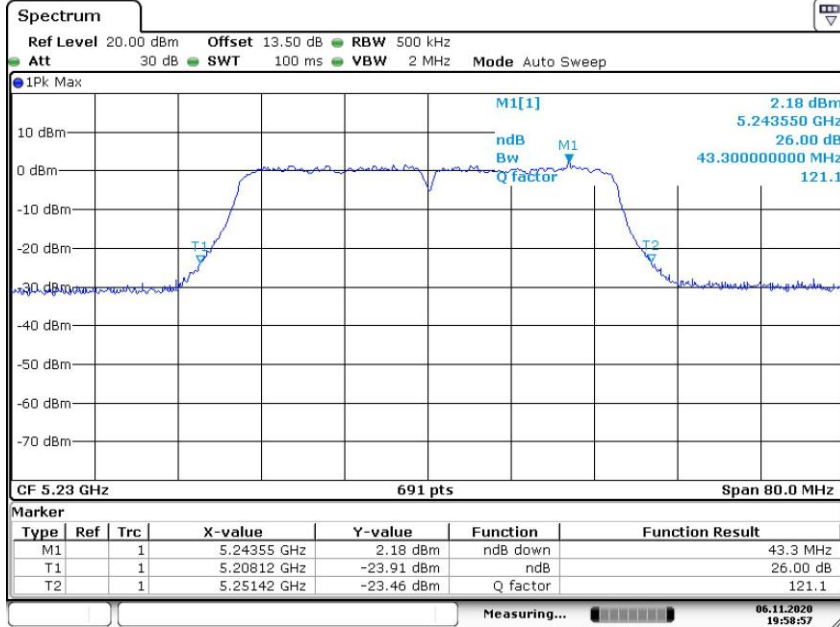

Date: 6.NOV.2020 19:58:57

26dB Emission Bandwidth **U-NII - 1**
Test Model 802.11ac 80 **Frequency(MHz)** 5210

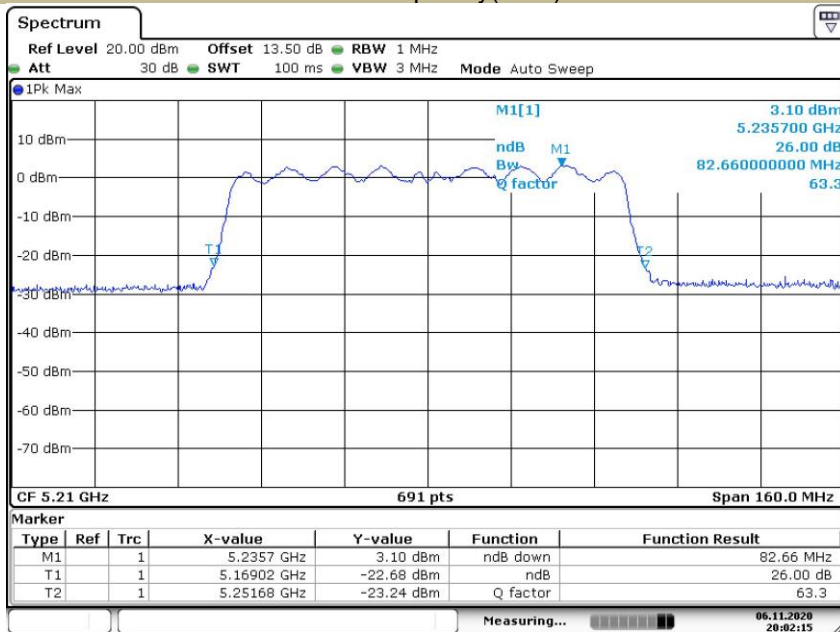

Date: 6.NOV.2020 20:02:15

5725-5850MHz

Test Mode	Test Channel MHz		6 dB Bandwidth MHz	99% Bandwidth MHz	Limit kHz
802.11a	CH149	5745	16.093	16.845	≥500
	CH157	5785	16.035	16.787	≥500
	CH165	5825	16.208	16.961	≥500
802.11n-HT20	CH149	5745	17.077	17.887	≥500
	CH157	5785	16.903	17.771	≥500
	CH165	5825	17.366	17.887	≥500
802.11ac(HT20)	CH149	5745	16.903	17.945	≥500
	CH157	5785	17.135	17.945	≥500
	CH165	5825	17.482	17.945	≥500
802.11n-HT40	CH151	5755	35.080	36.469	≥500
	CH159	5795	35.430	36.469	≥500
802.11ac(HT40)	CH151	5755	35.080	36.700	≥500
	CH159	5795	35.200	36.469	≥500
802.11ac(HT80)	CH155	5775	75.020	75.485	≥500

99% Occupied Bandwidth
Test Model 802.11a

U-NII - 3
Frequency(MHz)

5745

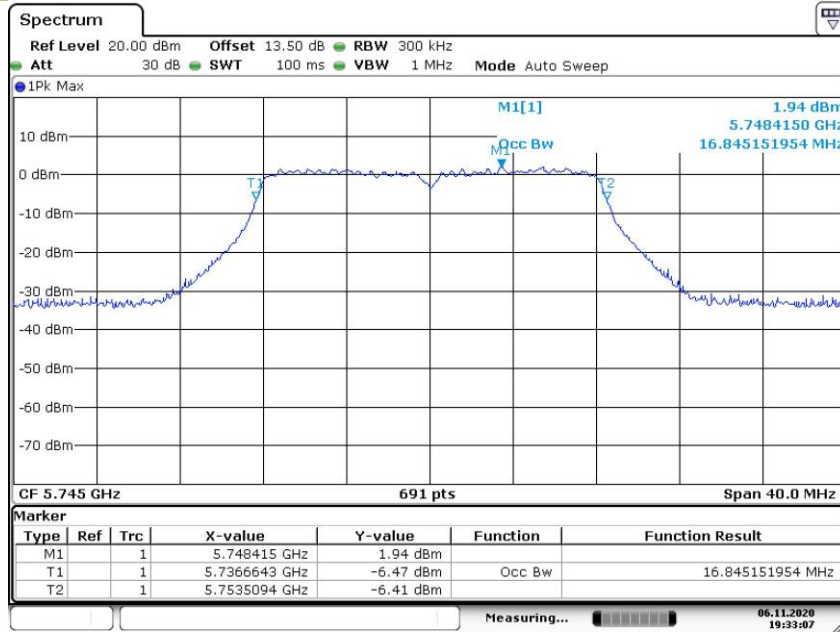

Date: 6.NOV.2020 19:33:08

99% Occupied Bandwidth
Test Model 802.11a

U-NII - 3
Frequency(MHz)

5785

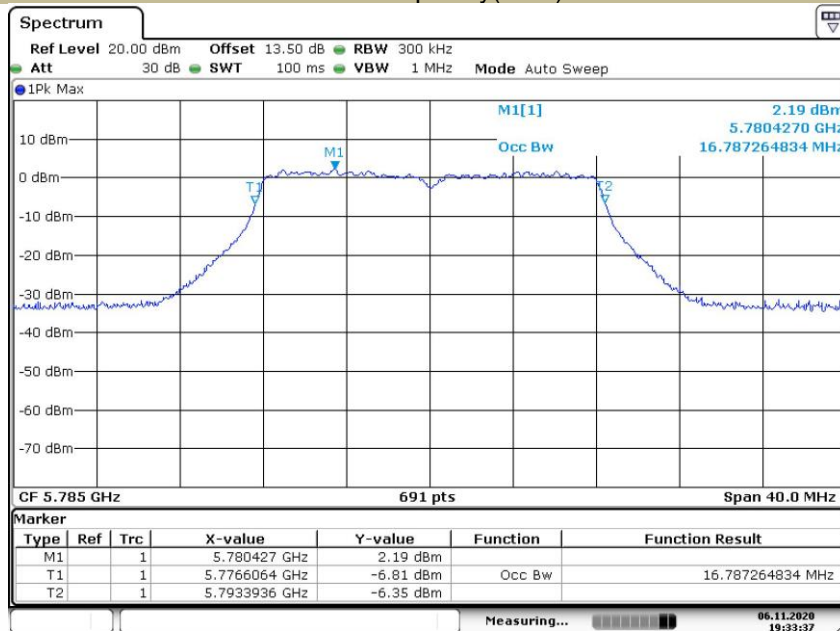

Date: 6.NOV.2020 19:33:37

99% Occupied Bandwidth
Test Model 802.11a

U-NII - 3
Frequency(MHz)

5825

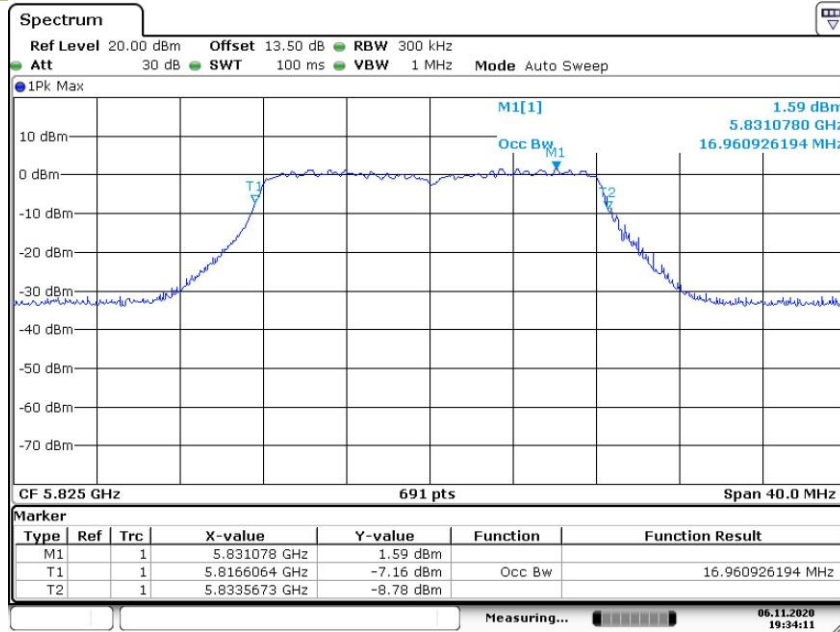

Date: 6.NOV.2020 19:34:12

99% Occupied Bandwidth
Test Model 802.11n-HT20

U-NII - 3
Frequency(MHz)

5745

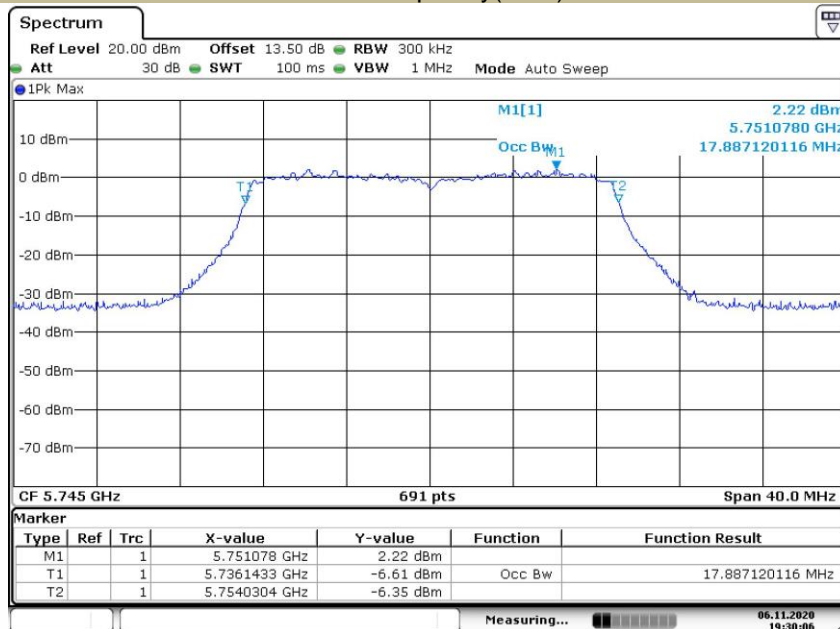

Date: 6.NOV.2020 19:30:06

99% Occupied Bandwidth
Test Model 802.11n-HT20

U-NII - 3
Frequency(MHz)

5785

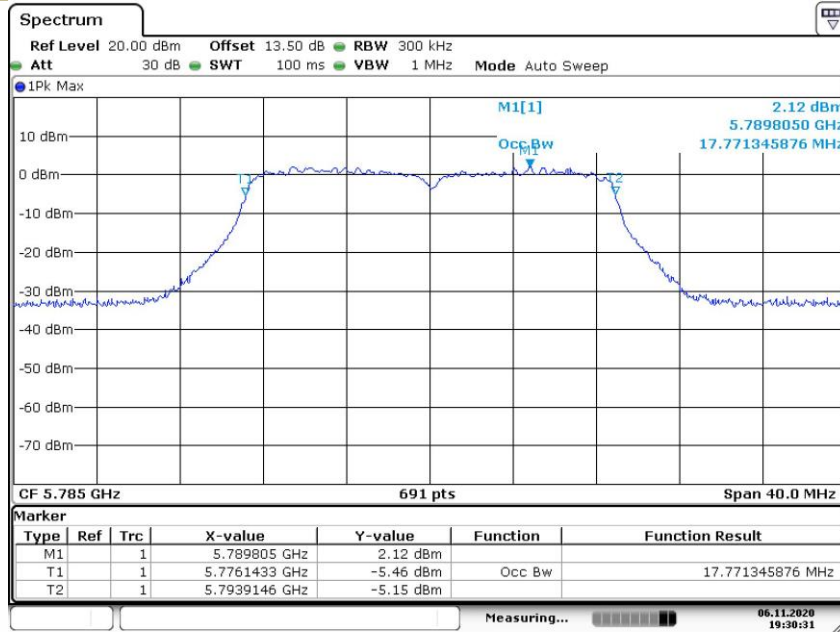

Date: 6.NOV.2020 19:30:32

99% Occupied Bandwidth
Test Model 802.11n-HT20

U-NII - 3
Frequency(MHz)

5825

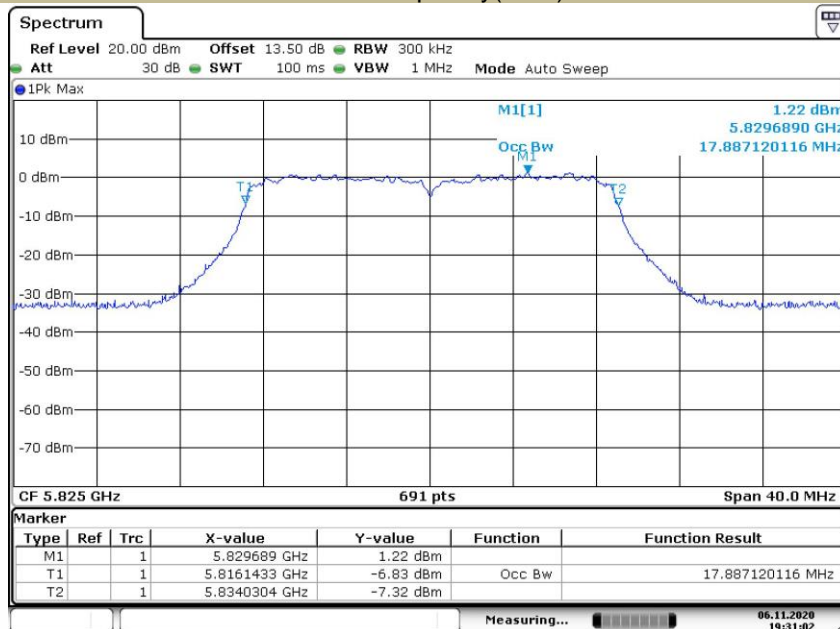

Date: 6.NOV.2020 19:31:01