

FCC Radio Test Report

FCC ID: 2ANK8-S08

Original Grant

Report No. : TB-FCC165562
Applicant : Shenzhen Forever Young Technology Co.,Ltd
Equipment Under Test (EUT)
EUT Name : WiFi Infrared Remote Control
Model No. : S08
Series Model No. : N/A
Brand Name : Zitech
Receipt Date : 2019-04-19
Test Date : 2019-04-19 to 2019-04-30
Issue Date : 2019-05-05
Standards : FCC Part 15, Subpart C (15.247: 2018)
Test Method : ANSI C63.10: 2013
Conclusions : **PASS**

In the configuration tested, the EUT complied with the standards specified above,
The EUT technically complies with the FCC and IC requirements

Test/Witness Engineer : Jason xu

Test/Witness Engineer : IVAN SU

Approved & Authorized : Ray Lai



This report details the results of the testing carried out on one sample. The results contained in this test report do not relate to other samples of the same product. The manufacturer should ensure that all products in series production are in conformity with the product sample detailed in the report.

Contents

CONTENTS.....	2
1. GENERAL INFORMATION ABOUT EUT	5
1.1 Client Information.....	5
1.2 General Description of EUT (Equipment Under Test)	5
1.3 Block Diagram Showing the Configuration of System Tested.....	6
1.4 Description of Support Units	6
1.5 Description of Test Mode.....	6
1.6 Description of Test Software Setting	8
1.7 Measurement Uncertainty	8
1.8 Test Facility.....	9
2. TEST SUMMARY	10
3. TEST EQUIPMENT	11
4. CONDUCTED EMISSION TEST	12
4.1 Test Standard and Limit.....	12
4.2 Test Setup.....	12
4.3 Test Procedure.....	12
4.4 EUT Operating Mode	13
4.5 Test Data.....	13
5. RADIATED EMISSION TEST	14
5.1 Test Standard and Limit.....	14
5.2 Test Setup.....	15
5.3 Test Procedure.....	16
5.4 EUT Operating Condition	17
5.5 Test Data.....	17
6. RESTRICTED BANDS REQUIREMENT	18
6.1 Test Standard and Limit.....	18
6.2 Test Setup.....	18
6.3 Test Procedure.....	18
6.4 EUT Operating Condition	19
6.5 Test Data.....	19
7. BANDWIDTH TEST	20
7.1 Test Standard and Limit.....	20
7.2 Test Setup.....	20
7.3 Test Procedure.....	20
7.4 EUT Operating Condition	20
7.5 Test Data.....	20
8. PEAK OUTPUT POWER TEST.....	21
8.1 Test Standard and Limit.....	21

- 8.2 Test Setup..... 21
- 8.3 Test Procedure..... 21
- 8.4 EUT Operating Condition 21
- 8.5 Test Data..... 21
- 9. POWER SPECTRAL DENSITY TEST 22**
 - 9.1 Test Standard and Limit..... 22
 - 9.2 Test Setup..... 22
 - 9.3 Test Procedure..... 22
 - 9.4 EUT Operating Condition 22
 - 9.5 Test Data..... 22
- 10. ANTENNA REQUIREMENT..... 23**
 - 10.1 Standard Requirement..... 23
 - 10.2 Antenna Connected Construction..... 23
- ATTACHMENT A-- CONDUCTED EMISSION TEST DATA 24**
- ATTACHMENT C-- RESTRICTED BANDS REQUIREMENT AND BAND-EDGE TEST DATA 38**
- ATTACHMENT D-- BANDWIDTH TEST DATA..... 53**
- ATTACHMENT E-- PEAK OUTPUT POWER TEST DATA..... 59**
- ATTACHMENT F-- POWER SPECTRAL DENSITY TEST DATA..... 62**

Revision History

Report No.	Version	Description	Issued Date
TB-FCC165562	Rev.01	Initial issue of report	2019-05-05

1. General Information about EUT

1.1 Client Information

Applicant	:	Shenzhen Forever Young Technology Co.,Ltd
Address	:	4/F, No.5 Bldg, Fu Hong Industrial Park, Fu Yong Town, Bao'an District, Shenzhen, China
Manufacturer	:	Shenzhen Forever Young Technology Co.,Ltd
Address	:	4/F, No.5 Bldg, Fu Hong Industrial Park, Fu Yong Town, Bao'an District, Shenzhen, China

1.2 General Description of EUT (Equipment Under Test)

EUT Name	:	WiFi Infrared Remote Control	
Models No.	:	S08	
Model Different	:	N/A	
Product Description	:	Operation Frequency:	802.11b/g/n(HT20): 2412MHz~2462MHz
	:	Number of Channel:	802.11b/g/n(HT20):11 channels <i>see note(3)</i>
	:	RF Output Power:	802.11b: 15.97dBm 802.11g: 15.45dBm 802.11n (HT20): 14.48dBm
	:	Antenna Gain:	2.5dBi PCB Antenna
	:	Modulation Type:	802.11b: DSSS(CCK, DQPSK, DBPSK) 802.11g/n: OFDM(BPSK,QPSK,16QAM, 64QAM)
	:	Bit Rate of Transmitter:	802.11b:11/5.5/2/1 Mbps 802.11g:54/48/36/24/18/12/9/6 Mbps 802.11n:up to 150Mbps
Power Supply	:	DC Voltage by AC/DC Adapter supplied	
Power Rating	:	Input: DC 5V1A	
Software Version	:	N/A	
Hardware Version	:	N/A	
Connecting I/O Port(S)	:	Please refer to the User's Manual	

Note:

- (1) This Test Report is FCC Part 15.247 for 802.11b/g/n, the test procedure follows the FCC KDB 558074 D01 DTS Meas Guidance v05.

(2) For a more detailed features description, please refer to the manufacturer's specifications or the User's Manual.

(3) Channel List:

Channel	Frequency (MHz)	Channel	Frequency (MHz)	Channel	Frequency (MHz)
01	2412	05	2432	09	2452
02	2417	06	2437	10	2457
03	2422	07	2442	11	2462
04	2427	08	2447		

Note: CH 01~CH 11 for 802.11b/g/n(HT20)

(4) The Antenna information about the equipment is provided by the applicant.

1.3 Block Diagram Showing the Configuration of System Tested

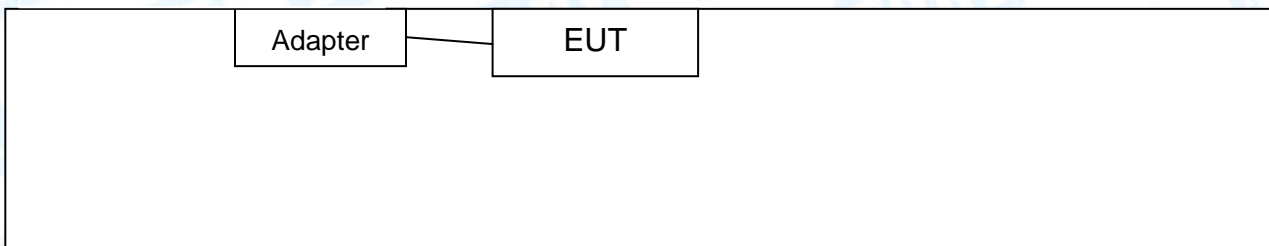

1.4 Description of Support Units

The EUT has been tested as an independent unit.

1.5 Description of Test Mode

To investigate the maximum EMI emission characteristics generated from EUT, the test system was pre-scanning tested based on the consideration of following EUT operation mode or test configuration mode which possibly have effect on EMI emission level. Each of these EUT operation mode(s) or test configuration mode(s) mentioned follows was evaluated respectively.

For Conducted Test	
Final Test Mode	Description
Mode 1	Normal Working with TX B Mode

For Radiated Test	
Final Test Mode	Description
Mode 2	TX Mode B Mode Channel 01/06/11
Mode 3	TX Mode G Mode Channel 01/06/11
Mode 4	TX Mode N(HT20) Mode Channel 01/06/11

Note:

- (1) For all test, we have verified the construction and function in typical operation. And all the test modes were carried out with the EUT in transmitting operation in maximum power with all kinds of data rate.
According to ANSI C63.10 standards, the measurements are performed at the highest, Middle, lowest available channels, and the worst case data rate as follows:
 - 802.11b Mode: CCK (1 Mbps)
 - 802.11g Mode: OFDM (6 Mbps)
 - 802.11n (HT20) Mode: MCS 0 (6.5 Mbps)
- (2) During the testing procedure, the continuously transmitting with the maximum power mode was programmed by the customer.
- (3) The EUT is considered a portable unit; in normal use it was positioned on X-plane. The worst case was found positioned on X-plane. Therefore only the test data of this X-plane was used for radiated emission measurement test.

1.6 Description of Test Software Setting

During testing channel & Power controlling software provided by the customer was used to control the operating channel as well as the output power level. The RF output power selection is for the setting of RF output power expected by the customer and is going to be fixed on the firmware of the final end product power parameters of WLAN.

Test Software Version	SecureCRT.exe		
	Channel	CH 01	CH 06
IEEE 802.11b DSSS	20	20	20
IEEE 802.11g OFDM	40	40	40
IEEE 802.11n (HT20)	45	45	45

1.7 Measurement Uncertainty

The reported uncertainty of measurement $y \pm U$, where expanded uncertainty U is based on a standard uncertainty multiplied by a coverage factor of $k=2$, providing a level of confidence of approximately 95 %.

Test Item	Parameters	Expanded Uncertainty (U_{Lab})
Conducted Emission	Level Accuracy: 9kHz~150kHz	± 3.42 dB
	150kHz to 30MHz	± 3.42 dB
Radiated Emission	Level Accuracy: 9kHz to 30 MHz	± 4.60 dB
Radiated Emission	Level Accuracy: 30MHz to 1000 MHz	± 4.40 dB
Radiated Emission	Level Accuracy: Above 1000MHz	± 4.20 dB

1.8 Test Facility

The testing report were performed by the Shenzhen Toby Technology Co., Ltd., in their facilities located at 1A/F., Bldg.6, Yusheng Industrial Zone, The National Road No.107 Xixiang Section 467, Xixiang, Bao'an, Shenzhen, Guangdong, China. At the time of testing, the following bodies accredited the Laboratory:

CNAS (L5813)

The Laboratory has been accredited by CNAS to ISO/IEC 17025: 2005 General Requirements for the Competence of Testing and Calibration Laboratories for the competence in the field of testing. And the Registration No.: CNAS L5813.

A2LA Certificate No.: 4750.01

The laboratory has been accredited by American Association for Laboratory Accreditation(A2LA) to ISO/IEC 17025: 2005 General Requirements for the Competence of Testing and Calibration Laboratories for the technical competence in the field of Electrical Testing. And the A2LA Certificate No.: 4750.01. FCC Accredited Test Site Number: 854351.

IC Registration No.: (11950A-1)

The Laboratory has been registered by Certification and Engineering Bureau of Industry Canada for radio equipment testing. The site registration: Site# 11950A-1.

2. Test Summary

FCC Part 15 Subpart C(15.247)/ RSS 247 Issue 2				
Standard Section		Test Item	Judgment	Remark
FCC	IC			
15.203	/	Antenna Requirement	PASS	N/A
15.207	RSS-GEN 7.2.4	Conducted Emission	PASS	N/A
15.205	RSS-GEN 7.2.2	Restricted Bands	PASS	N/A
15.247(a)(2)	RSS 247 5.2 (1)	6dB Bandwidth	PASS	N/A
15.247(b)	RSS 247 5.4 (4)	Peak Output Power	PASS	N/A
15.247(e)	RSS 247 5.2 (2)	Power Spectral Density	PASS	N/A
15.247(d)	RSS 247 5.5	Band Edge	PASS	N/A
15.247(d)& 15.209	RSS 247 5.5	Transmitter Radiated Spurious Emission	PASS	N/A

Note: “/” for no requirement for this test item.
N/A is an abbreviation for Not Applicable.

3. Test Equipment

Conducted Emission Test					
Equipment	Manufacturer	Model No.	Serial No.	Last Cal.	Cal. Due Date
EMI Test Receiver	Rohde & Schwarz	ESCI	100321	Jul. 18, 2018	Jul. 17, 2019
RF Switching Unit	Compliance Direction Systems Inc	RSU-A4	34403	Jul. 18, 2018	Jul. 17, 2019
AMN	SCHWARZBECK	NNBL 8226-2	8226-2/164	Jul. 18, 2018	Jul. 17, 2019
LISN	Rohde & Schwarz	ENV216	101131	Jul. 18, 2018	Jul. 17, 2019
Radiation Emission Test					
Equipment	Manufacturer	Model No.	Serial No.	Last Cal.	Cal. Due Date
Spectrum Analyzer	Agilent	E4407B	MY45106456	Jul. 18, 2018	Jul. 17, 2019
EMI Test Receiver	Rohde & Schwarz	ESPI	100010/007	Jul. 18, 2018	Jul. 17, 2019
Bilog Antenna	ETS-LINDGREN	3142E	00117537	Jan. 27, 2019	Jan. 26, 2020
Bilog Antenna	ETS-LINDGREN	3142E	00117542	Jan. 27, 2019	Jan. 26, 2020
Horn Antenna	ETS-LINDGREN	3117	00143207	Mar.03, 2019	Mar. 02, 2020
Horn Antenna	ETS-LINDGREN	3117	00143209	Mar.03, 2019	Mar. 02, 2020
Loop Antenna	SCHWARZBECK	FMZB 1519 B	1519B-059	Mar.04, 2019	Mar. 03, 2020
Pre-amplifier	Sonoma	310N	185903	Mar.03, 2019	Mar. 02, 2020
Pre-amplifier	HP	8449B	3008A00849	Mar.03, 2019	Mar. 02, 2020
Cable	HUBER+SUHNER	100	SUCOFLEX	Jan. 27, 2019	Jan. 26, 2020
Positioning Controller	ETS-LINDGREN	2090	N/A	N/A	N/A
Antenna Conducted Emission					
Equipment	Manufacturer	Model No.	Serial No.	Last Cal.	Cal. Due Date
Spectrum Analyzer	Agilent	E4407B	MY45106456	Jul. 18, 2018	Jul. 17, 2019
Spectrum Analyzer	Rohde & Schwarz	ESCI	100010/007	Jul. 18, 2018	Jul. 17, 2019
MXA Signal Analyzer	Agilent	N9020A	MY49100060	Sep. 15, 2018	Sep. 14, 2019
Vector Signal Generator	Agilent	N5182A	MY50141294	Sep. 15, 2018	Sep. 14, 2019
Analog Signal Generator	Agilent	N5181A	MY50141953	Sep. 15, 2018	Sep. 14, 2019
RF Power Sensor	DARE!! Instruments	RadiPowerRPR3006W	17I00015SNO26	Sep. 15, 2018	Sep. 14, 2019
	DARE!! Instruments	RadiPowerRPR3006W	17I00015SNO29	Sep. 15, 2018	Sep. 14, 2019
	DARE!! Instruments	RadiPowerRPR3006W	17I00015SNO31	Sep. 15, 2018	Sep. 14, 2019
	DARE!! Instruments	RadiPowerRPR3006W	17I00015SNO33	Sep. 15, 2018	Sep. 14, 2019

4. Conducted Emission Test

4.1 Test Standard and Limit

4.1.1 Test Standard

FCC Part 15.207

4.1.2 Test Limit

Conducted Emission Test Limit

Frequency	Maximum RF Line Voltage (dB μ V)	
	Quasi-peak Level	Average Level
150kHz~500kHz	66 ~ 56 *	56 ~ 46 *
500kHz~5MHz	56	46
5MHz~30MHz	60	50

Notes:

(1) *Decreasing linearly with logarithm of the frequency.

(2) The lower limit shall apply at the transition frequencies.

(3) The limit decrease in line with the logarithm of the frequency in the range of 0.15 to 0.50MHz.

4.2 Test Setup

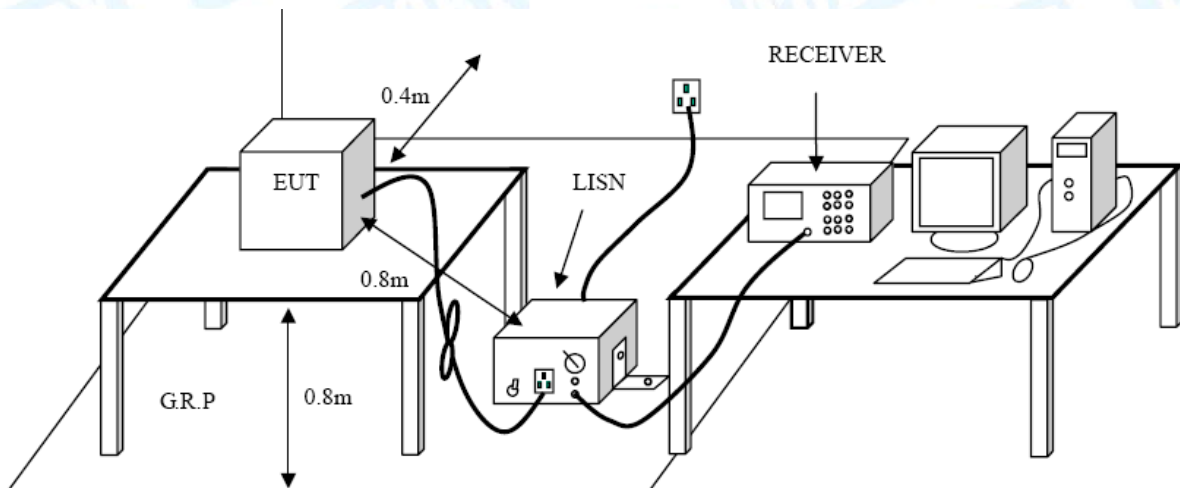

4.3 Test Procedure

The EUT was placed 0.8 meters from the horizontal ground plane with EUT being connected to the power mains through a line impedance stabilization network (LISN). All other support equipments powered from additional LISN(s). The LISN provide 50 Ohm/ 50uH of coupling impedance for the measuring instrument.

Interconnecting cables that hang closer than 40 cm to the ground plane shall be folded back and forth in the center forming a bundle 30 to 40 cm long.

I/O cables that are not connected to a peripheral shall be bundled in the center. The end of the cable may be terminated, if required, using the correct terminating impedance. The overall length shall not exceed 1 m.

LISN at least 80 cm from nearest part of EUT chassis.

The bandwidth of EMI test receiver is set at 9kHz, and the test frequency band is from 0.15MHz to 30MHz.

4.4 EUT Operating Mode

Please refer to the description of test mode.

4.5 Test Data

Please refer to the Attachment A.

5. Radiated Emission Test

5.1 Test Standard and Limit

5.1.1 Test Standard

FCC Part 15.209

5.1.2 Test Limit

Radiated Emission Limits (9 kHz~1000 MHz)

Frequency (MHz)	Field Strength (microvolt/meter)	Measurement Distance (meters)
0.009~0.490	2400/F(KHz)	300
0.490~1.705	24000/F(KHz)	30
1.705~30.0	30	30
30~88	100	3
88~216	150	3
216~960	200	3
Above 960	500	3

Radiated Emission Limit (Above 1000MHz)

Frequency (MHz)	Distance of 3m (dBuV/m)	
	Peak	Average
Above 1000	74	54

Note:

- (1) The tighter limit applies at the band edges.
- (2) Emission Level(dBuV/m)=20log Emission Level(uV/m)

5.2 Test Setup

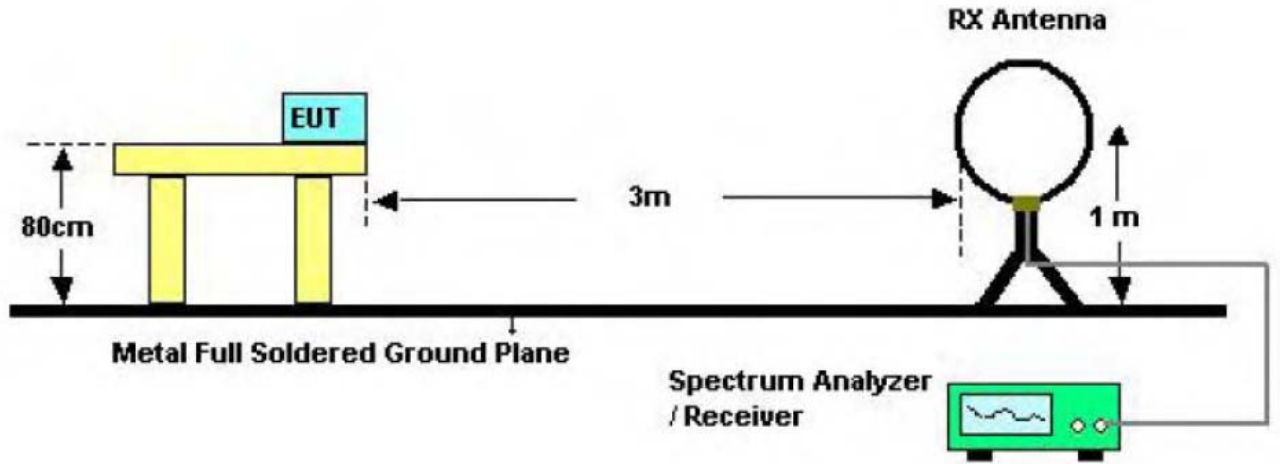

Below 30MHz Test Setup

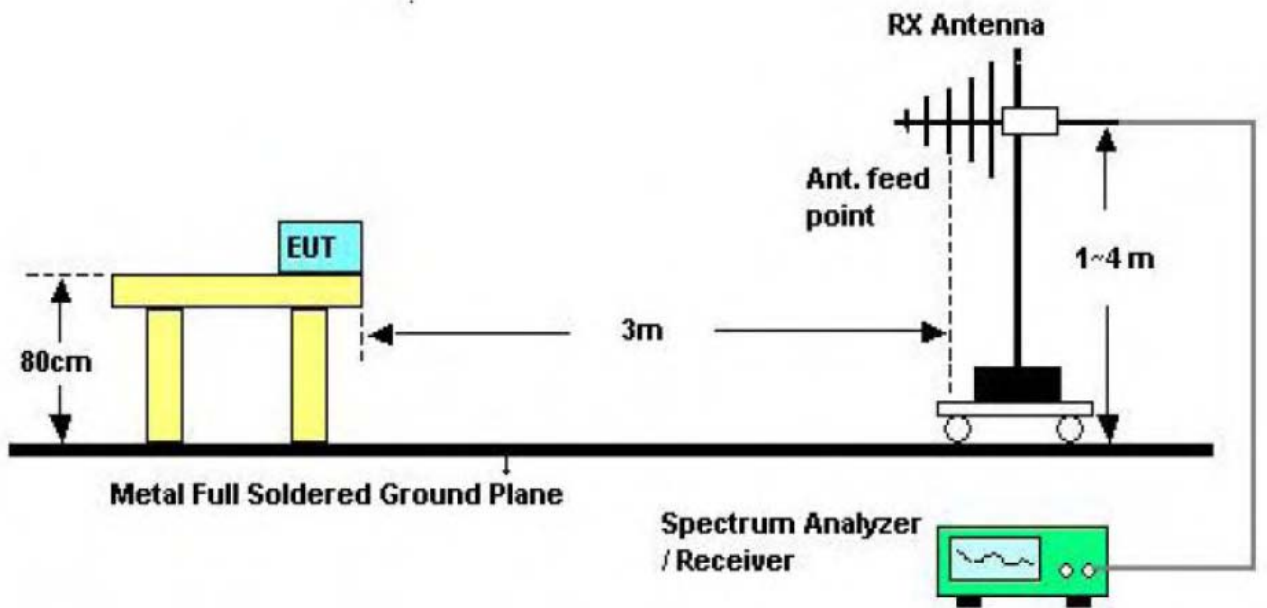

Below 1000MHz Test Setup

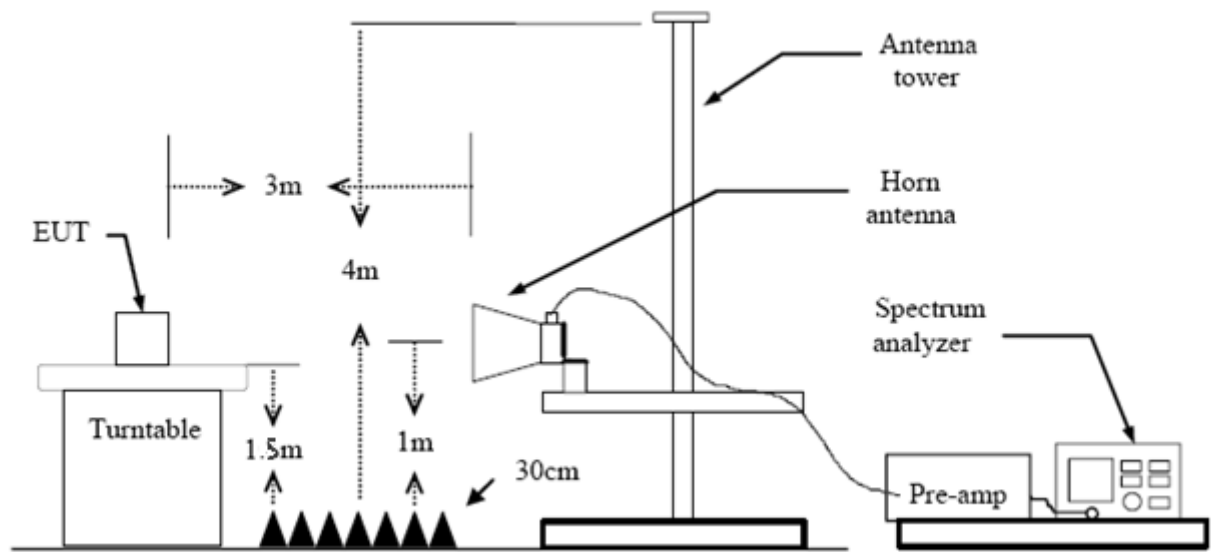

Above 1GHz Test Setup

5.3 Test Procedure

- (1) Measurements at frequency above 1GHz. The EUT was placed on a rotating 1.5m high above the ground. RF absorbers covered the ground plane with a minimum area of 3.0m by 3.0m between the EUT and measurement receiver antenna. The RF absorber shall not exceed 30cm in high above the conducting floor. The table was rotated 360 degrees to determine the position of the highest radiation.
- (2) Measurements at frequency Below 1GHz. The EUT was placed on a rotating 0.8m high above the ground. RF absorbers covered the ground plane with a minimum area of 3.0m by 3.0m between the EUT and measurement receiver antenna. The RF absorber shall not exceed 30cm in high above the conducting floor. The table was rotated 360 degrees to determine the position of the highest radiation.
- (3) The Test antenna shall vary between 1m and 4m, Both Horizontal and Vertical antenna are set to make measurement.
- (4) The initial step in collecting conducted emission data is a spectrum analyzer peak detector mode pre-scanning the measurement frequency range. Significant peaks are then marked and then Quasi Peak detector mode re-measured.
- (5) If the Peak Mode measured value compliance with and lower than Quasi Peak Mode Limit Bellow 1 GHz, the EUT shall be deemed to meet QP Limits and then no additional QP Mode measurement performed. But the Peak Value and average value both need to comply with applicable limit above 1 GHz.
- (6) Testing frequency range below 1GHz the measuring instrument use VBW=120 kHz with Quasi-peak detection.
- (7) Testing frequency range above 1GHz the measuring instrument use RBW=1 MHz and VBW=3 MHz with Peak Detector for Peak Values, and use RBW=1 MHz and VBW=10 Hz with Peak Detector for Average Values.

(8) For the actual test configuration, please see the test setup photo.

5.4 EUT Operating Condition

The Equipment Under Test was set to Continual Transmitting in maximum power.

5.5 Test Data

Remark: During testing above 1GHz the measuring instrument use RBW=1 MHz and VBW=3 MHz with Peak Detector for Peak Values, and use RBW=1 MHz and VBW=10 Hz with Peak Detector for Average Values.

Please refer to the Attachment B.

6. Restricted Bands Requirement

6.1 Test Standard and Limit

6.1.1 Test Standard

FCC Part 15.247(d)

FCC Part 15.209

FCC Part 15.205

6.1.2 Test Limit

Restricted Frequency Band (MHz)	Distance of 3m (dBuV/m)	
	Peak	Average
2310 ~2390	74	54
2483.5 ~2500	74	54

6.2 Test Setup

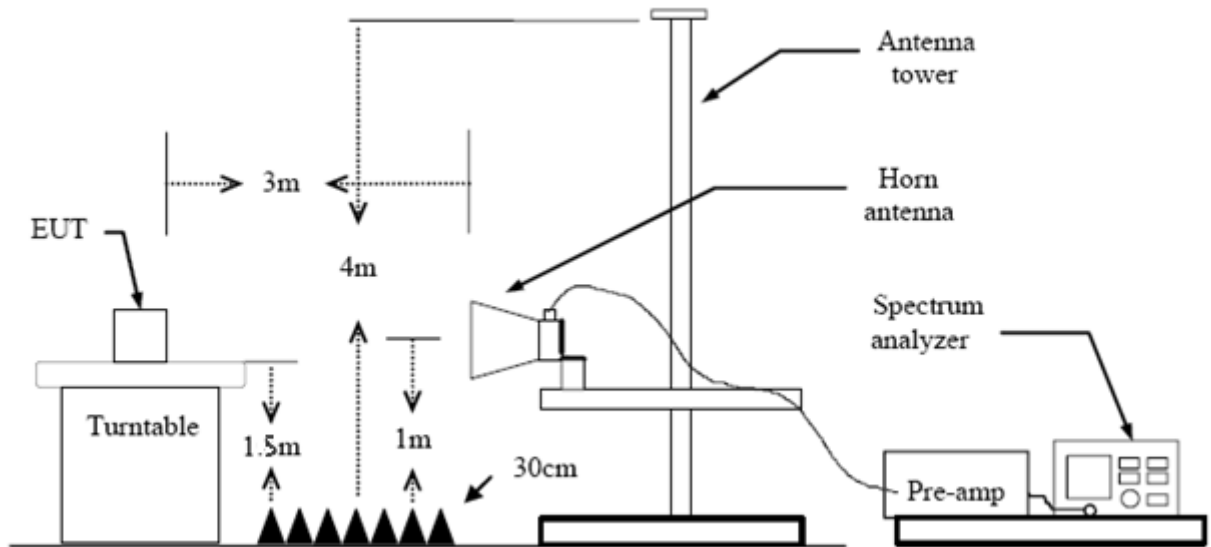

6.3 Test Procedure

- (1) The measuring distance of 3m shall be used for measurements at frequency Below 1GHz and above 1 GHz. The EUT was placed on a rotating 0.8m high above ground, the table was rotated 360 degrees to determine the position of the highest radiation.
- (2) Measurements at frequency above 1GHz. The EUT was placed on a rotating 1.5m high above the ground. RF absorbers covered the ground plane with a minimum area of 3.0m by 3.0m between the EUT and measurement receiver antenna. The RF absorber shall not exceed 30cm in high above the conducting floor. The table was rotated 360 degrees to determine the position of the highest radiation.

- (3) The Test antenna shall vary between 1m and 4m, Both Horizontal and Vertical antenna are set to make measurement.
- (4) The initial step in collecting conducted emission data is a spectrum analyzer peak detector mode pre-scanning the measurement frequency range. Significant peaks are then marked and then Quasi Peak detector mode re-measured.
- (5) If the Peak Mode measured value compliance with and lower than Quasi Peak Mode Limit Bellow 1 GHz, the EUT shall be deemed to meet QP Limits and then no additional QP Mode measurement performed. But the Peak Value and average value both need to comply with applicable limit above 1 GHz.
- (6) Testing frequency range below 1GHz the measuring instrument use VBW=120 kHz with Quasi-peak detection.
- (7) Testing frequency range above 1GHz the measuring instrument use RBW=1 MHz and VBW=3 MHz with Peak Detector for Peak Values, and use RBW=1 MHz and VBW=10 Hz with Peak Detector for Average Values.
- (8) For the actual test configuration, please see the test setup photo.

6.4 EUT Operating Condition

The Equipment Under Test was set to Continual Transmitting in maximum power.

6.5 Test Data

Please refer to the Attachment C.

7. Bandwidth Test

7.1 Test Standard and Limit

7.1.1 Test Standard

FCC Part 15.247 (a)(2)

7.1.2 Test Limit

FCC Part 15 Subpart C(15.247)		
Test Item	Limit	Frequency Range(MHz)
Bandwidth	≥ 500 KHz (6dB bandwidth)	2400~2483.5

7.2 Test Setup

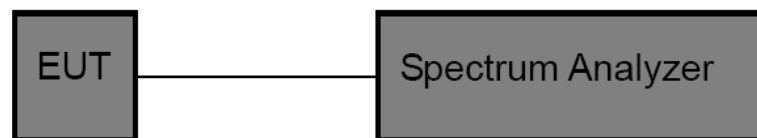

7.3 Test Procedure

- (1) The EUT was directly connected to the spectrum analyzer and antenna output port as show in the block diagram above.
- (2) The bandwidth is measured at an amplitude level reduced 6dB from the reference level. The reference level is the level of the highest amplitude signal observed from the transmitter at the fundamental frequency. Once the reference level is established, the equipment is conditioned with typical modulating signal to produce the worst -case (i.e the widest) bandwidth.
- (3) Measure the channel separation the spectrum analyzer was set to Resolution Bandwidth:100 kHz, and Video Bandwidth:300 kHz, Detector: Peak, Sweep Time set auto.

7.4 EUT Operating Condition

The EUT was set to continuously transmitting in each mode and low, Digital photo framesdle and high channel for the test.

7.5 Test Data

Please refer to the Attachment D.

8. Peak Output Power Test

8.1 Test Standard and Limit

8.1.1 Test Standard

FCC Part 15.247 (b)

8.1.2 Test Limit

FCC Part 15 Subpart C(15.247)		
Test Item	Limit	Frequency Range(MHz)
Peak Output Power	1 Watt or 30 dBm	2400~2483.5

8.2 Test Setup

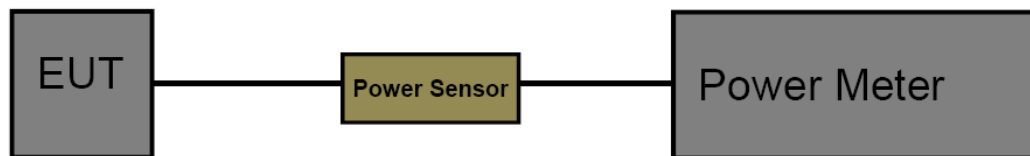

8.3 Test Procedure

The measurement is according to section 9.1.2 of KDB 558074 D01 DTS Meas Guidance v05. The EUT was connected to RF power meter via a broadband power sensor as show the block above. The power sensor video bandwidth is greater than or equal to the DTS bandwidth of the equipment.

8.4 EUT Operating Condition

The EUT was set to continuously transmitting in the max power during the test.

8.5 Test Data

Please refer to the Attachment E.

9. Power Spectral Density Test

9.1 Test Standard and Limit

9.1.1 Test Standard

FCC Part 15.247 (e)

9.1.2 Test Limit

FCC Part 15 Subpart C(15.247)		
Test Item	Limit	Frequency Range(MHz)
Power Spectral Density	8dBm(in any 3 kHz)	2400~2483.5

9.2 Test Setup

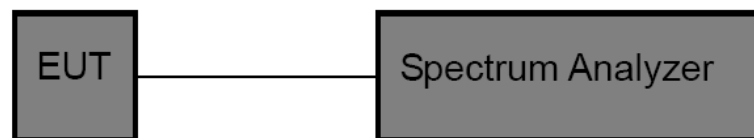

9.3 Test Procedure

The EUT was directly connected to the Spectrum Analyzer and antenna output port as show in the block diagram above. The measurement according to section 10.2 of KDB 558074 D01 DTS Meas Guidance v05.

- (1) The EUT was directly connected to the spectrum analyzer and antenna output port as show in the block diagram above.
- (2) Set analyser center frequency to DTS channel center frequency.
- (3) Set the span to 1.5 times the DTS bandwidth.
- (4) Set the RBW to: 3 kHz
- (5) Set the VBW to: 10 kHz
- (6) Detector: peak
- (7) Sweep time: auto
- (8) Allow trace to fully stabilize. Then use the peak marker function to determine the maximum amplitude level.

9.4 EUT Operating Condition

The EUT was set to continuously transmitting in each mode and low, Digital photo framesdle and high channel for the test.

9.5 Test Data

Please refer to the Attachment F.

10. Antenna Requirement

10.1 Standard Requirement

10.1.1 Standard

FCC Part 15.203

10.1.2 Requirement

An intentional radiator shall be designed to ensure that no antenna other than that furnished by the responsible party shall be used with the device. The use of a permanently attached antenna or of an antenna that uses a unique coupling to the intentional radiator shall be considered sufficient to comply with the provisions of this Section. The manufacturer may design the unit so that a broken antenna can be replaced by the user, but the use of a standard antenna jack or electrical connector is prohibited.

10.2 Antenna Connected Construction

The gains of the antenna used for transmitting is 2.5dBi, and the antenna de-signed with permanent attachment and no consideration of replacement. Please see the EUT photo for details.

Result

The EUT antenna is a PCB Antenna. It complies with the standard requirement.

Antenna Type
<input checked="" type="checkbox"/> Permanent attached antenna
<input type="checkbox"/> Unique connector antenna
<input type="checkbox"/> Professional installation antenna

Attachment A-- Conducted Emission Test Data

Temperature:	25 °C	Relative Humidity:	55%
Test Voltage:	AC 120V/60Hz		
Terminal:	Line		
Test Mode:	Mode 1		
Remark:	Only worse case is reported		

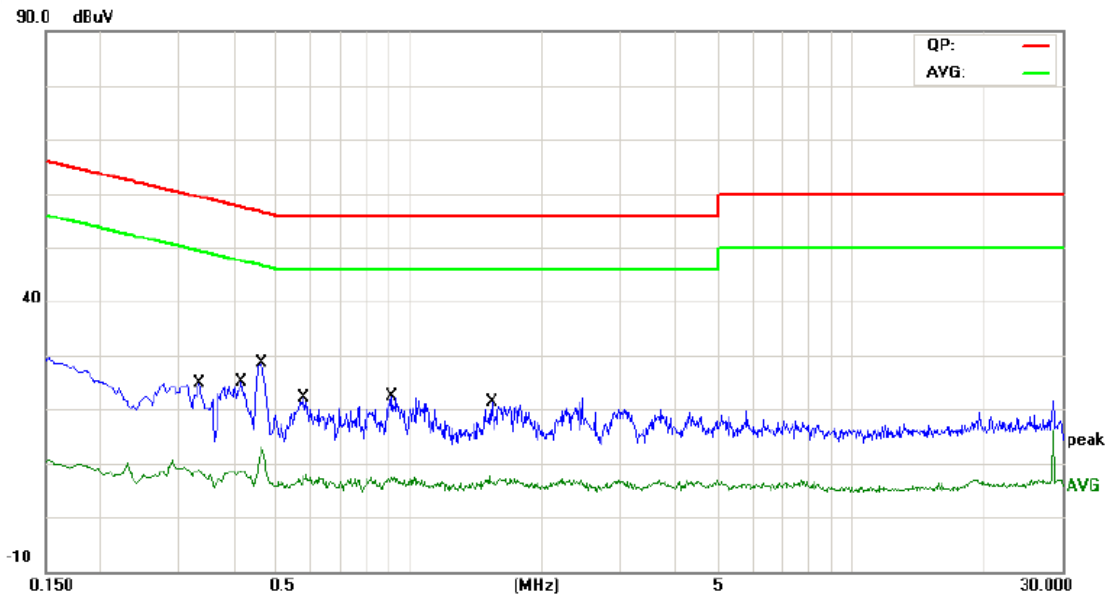

No.	Mk.	Freq. MHz	Reading Level dBuV	Correct Factor dB	Measure- ment dBuV	Limit dBuV	Over dB	Detector
1		0.3339	5.82	9.59	15.41	59.35	-43.94	QP
2		0.3339	-2.01	9.59	7.58	49.35	-41.77	AVG
3		0.4180	6.90	9.60	16.50	57.49	-40.99	QP
4		0.4180	-1.76	9.60	7.84	47.49	-39.65	AVG
5	*	0.4620	13.50	9.60	23.10	56.66	-33.56	QP
6		0.4620	2.05	9.60	11.65	46.66	-35.01	AVG
7		0.5780	3.98	9.60	13.58	56.00	-42.42	QP
8		0.5780	-3.41	9.60	6.19	46.00	-39.81	AVG
9		0.9180	3.88	9.60	13.48	56.00	-42.52	QP
10		0.9180	-3.02	9.60	6.58	46.00	-39.42	AVG
11		1.5420	1.99	9.61	11.60	56.00	-44.40	QP
12		1.5420	-3.66	9.61	5.95	46.00	-40.05	AVG

Emission Level= Read Level+ Correct Factor

Temperature:	25 °C	Relative Humidity:	55%
Test Voltage:	AC 120V/60Hz		
Terminal:	Neutral		
Test Mode:	Mode 1		
Remark:	Only worse case is reported		

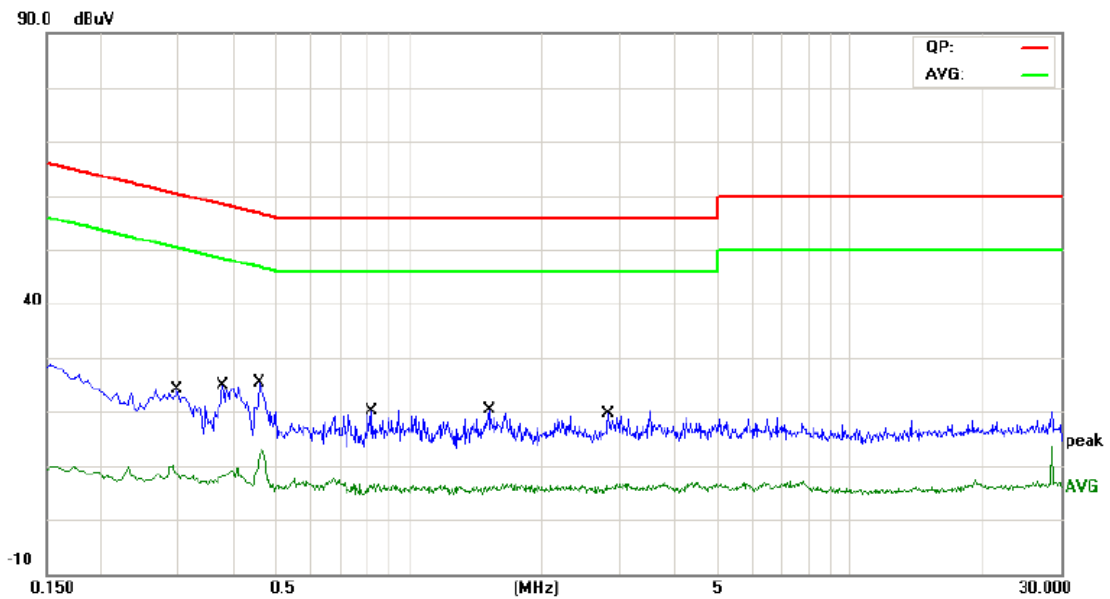

No.	Mk.	Freq. MHz	Reading Level dBuV	Correct Factor dB	Measure- ment dBuV	Limit dBuV	Over dB	Detector
1		0.2980	6.07	9.57	15.64	60.30	-44.66	QP
2		0.2980	-2.32	9.57	7.25	50.30	-43.05	AVG
3		0.3780	5.64	9.58	15.22	58.32	-43.10	QP
4		0.3780	-1.95	9.58	7.63	48.32	-40.69	AVG
5		0.4580	8.55	9.58	18.13	56.73	-38.60	QP
6	*	0.4580	2.45	9.58	12.03	46.73	-34.70	AVG
7		0.8220	1.19	9.59	10.78	56.00	-45.22	QP
8		0.8220	-4.05	9.59	5.54	46.00	-40.46	AVG
9		1.5180	1.14	9.60	10.74	56.00	-45.26	QP
10		1.5180	-4.40	9.60	5.20	46.00	-40.80	AVG
11		2.8380	0.51	9.66	10.17	56.00	-45.83	QP
12		2.8380	-4.44	9.66	5.22	46.00	-40.78	AVG

Emission Level= Read Level+ Correct Factor

Attachment B-- Radiated Emission Test Data

9KHz~30MHz

From 9KHz to 30MHz: Conclusion: PASS

Note: The amplitude of spurious emissions which are attenuated by more than 20dB below the permissible value has no need to be reported.

30MHz~1GHz

Temperature:	25 °C	Relative Humidity:	55%
Test Voltage:	AC 120V/60HZ		
Ant. Pol.	Horizontal		
Test Mode:	TX B Mode 2412MHz		
Remark:	Only worse case is reported		

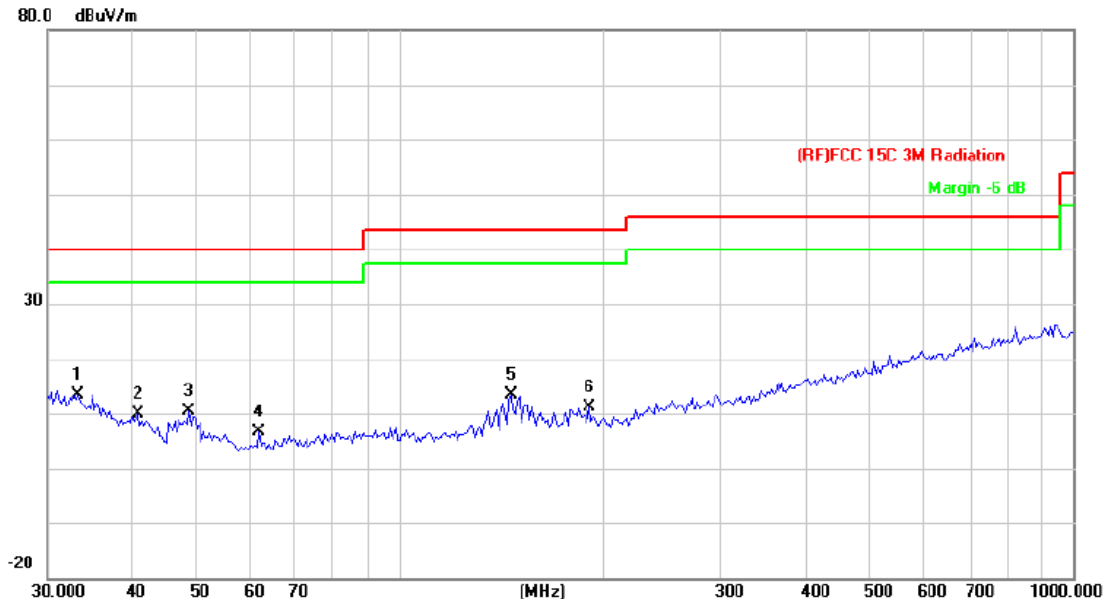

No.	Mk.	Freq. MHz	Reading Level dBuV	Correct Factor dB/m	Measure- ment dBuV/m	Limit dBuV/m	Over dB	Detector
1	*	33.3279	28.84	-15.50	13.34	40.00	-26.66	QP
2		40.8446	29.30	-19.52	9.78	40.00	-30.22	QP
3		48.6719	33.25	-22.80	10.45	40.00	-29.55	QP
4		61.7781	30.79	-24.21	6.58	40.00	-33.42	QP
5		146.3735	35.18	-21.81	13.37	43.50	-30.13	QP
6		191.0738	31.02	-19.82	11.20	43.50	-32.30	QP

*:Maximum data x:Over limit !:over margin

Emission Level= Read Level+ Correct Factor

Temperature:	25 °C	Relative Humidity:	55%
Test Voltage:	AC 120V/60HZ		
Ant. Pol.	Vertical		
Test Mode:	TX B Mode 2412MHZ		
Remark:	Only worse case is reported		

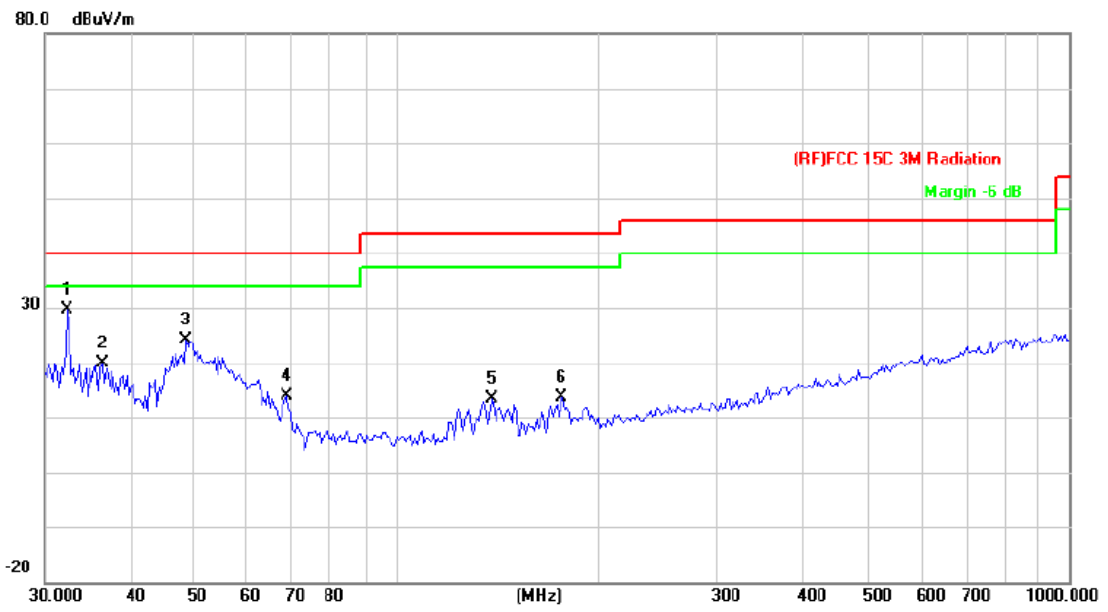

No.	Mk.	Freq.	Reading Level	Correct Factor	Measurement	Limit	Over	Detector
		MHz	dBuV	dB/m	dBuV/m	dBuV/m	dB	
1	*	32.4059	44.43	-14.81	29.62	40.00	-10.38	QP
2		36.5092	37.43	-17.46	19.97	40.00	-20.03	QP
3		48.6719	46.92	-22.80	24.12	40.00	-15.88	QP
4		68.6310	37.45	-23.63	13.82	40.00	-26.18	QP
5		138.3873	35.86	-22.47	13.39	43.50	-30.11	QP
6		175.6516	34.03	-20.32	13.71	43.50	-29.79	QP

*:Maximum data x:Over limit !:over margin

Emission Level= Read Level+ Correct Factor

Above 1GHz

Temperature:	25 °C	Relative Humidity:	55%
Test Voltage:	AC 120V/60HZ		
Ant. Pol.	Horizontal		
Test Mode:	TX B Mode 2412MHz		
Remark:	No report for the emission which more than 10 dB below the prescribed limit.		

No.	Mk.	Freq.	Reading Level	Correct Factor	Measurement	Limit	Over	Detector
		MHz	dBuV	dB/m	dBuV/m	dBuV/m	dB	
1	*	4824.980	29.17	14.55	43.72	54.00	-10.28	AVG
2		4823.404	43.14	14.55	57.69	74.00	-16.31	peak

Emission Level= Read Level+ Correct Factor

Temperature:	25 °C	Relative Humidity:	55%
Test Voltage:	AC 120V/60HZ		
Ant. Pol.	Vertical		
Test Mode:	TX B Mode 2412MHz		
Remark:	No report for the emission which more than 10 dB below the prescribed limit.		

No.	Mk.	Freq.	Reading Level	Correct Factor	Measurement	Limit	Over	Detector
		MHz	dBuV	dB/m	dBuV/m	dBuV/m	dB	
1		4824.356	43.86	14.55	58.41	74.00	-15.59	peak
2	*	4824.776	29.19	14.55	43.74	54.00	-10.26	AVG

Emission Level= Read Level+ Correct Factor

Temperature:	25 °C	Relative Humidity:	55%
Test Voltage:	AC 120V/60HZ		
Ant. Pol.	Horizontal		
Test Mode:	TX B Mode 2437MHz		
Remark:	No report for the emission which more than 10 dB below the prescribed limit.		

No. Mk.	Freq.	Reading Level	Correct Factor	Measurement	Limit	Over	
	MHz	dBuV	dB/m	dBuV/m	dBuV/m	dB	Detector
1	4873.468	43.60	14.86	58.46	74.00	-15.54	peak
2 *	4874.916	29.06	14.86	43.92	54.00	-10.08	AVG

Emission Level= Read Level+ Correct Factor

Temperature:	25 °C	Relative Humidity:	55%
Test Voltage:	AC 120V/60HZ		
Ant. Pol.	Vertical		
Test Mode:	TX B Mode 2437MHz		
Remark:	No report for the emission which more than 10 dB below the prescribed limit.		

No. Mk.	Freq.	Reading Level	Correct Factor	Measurement	Limit	Over	
	MHz	dBuV	dB/m	dBuV/m	dBuV/m	dB	Detector
1 *	4874.800	29.06	14.86	43.92	54.00	-10.08	AVG
2	4874.928	43.72	14.86	58.58	74.00	-15.42	peak

Emission Level= Read Level+ Correct Factor

Temperature:	25 °C	Relative Humidity:	55%
Test Voltage:	AC 120V/60HZ		
Ant. Pol.	Horizontal		
Test Mode:	TX B Mode 2462MHz		
Remark:	No report for the emission which more than 10 dB below the prescribed limit.		

No.	Mk.	Freq.	Reading Level	Correct Factor	Measurement	Limit	Over	Detector
		MHz	dBuV	dB/m	dBuV/m	dBuV/m	dB	
1	*	4924.860	29.49	15.18	44.67	54.00	-9.33	AVG
2		4924.760	43.91	15.18	59.09	74.00	-14.91	peak

Emission Level= Read Level+ Correct Factor

Temperature:	25 °C	Relative Humidity:	55%
Test Voltage:	AC 120V/60HZ		
Ant. Pol.	Vertical		
Test Mode:	TX B Mode 2462MHz		
Remark:	No report for the emission which more than 10 dB below the prescribed limit.		

No.	Mk.	Freq.	Reading Level	Correct Factor	Measurement	Limit	Over	Detector
		MHz	dBuV	dB/m	dBuV/m	dBuV/m	dB	
1		4923.136	43.85	15.17	59.02	74.00	-14.98	peak
2	*	4924.900	29.54	15.18	44.72	54.00	-9.28	AVG

Emission Level= Read Level+ Correct Factor

Temperature:	25 °C	Relative Humidity:	55%
Test Voltage:	AC 120V/60HZ		
Ant. Pol.	Horizontal		
Test Mode:	TX G Mode 2412MHz		
Remark:	No report for the emission which more than 10 dB below the prescribed limit.		

No.	Mk.	Freq.	Reading Level	Correct Factor	Measurement	Limit	Over	Detector
		MHz	dBuV	dB/m	dBuV/m	dBuV/m	dB	
1		4824.884	43.37	14.55	57.92	74.00	-16.08	peak
2	*	4823.972	29.15	14.55	43.70	54.00	-10.30	AVG

Emission Level= Read Level+ Correct Factor

Temperature:	25 °C	Relative Humidity:	55%
Test Voltage:	AC 120V/60HZ		
Ant. Pol.	Vertical		
Test Mode:	TX G Mode 2412MHz		
Remark:	No report for the emission which more than 10 dB below the prescribed limit.		

No.	Mk.	Freq.	Reading Level	Correct Factor	Measurement	Limit	Over	Detector
		MHz	dBuV	dB/m	dBuV/m	dBuV/m	dB	
1	*	4824.960	29.17	14.55	43.72	54.00	-10.28	AVG
2		4823.192	43.79	14.55	58.34	74.00	-15.66	peak

Emission Level= Read Level+ Correct Factor

Temperature:	25 °C	Relative Humidity:	55%
Test Voltage:	AC 120V/60HZ		
Ant. Pol.	Horizontal		
Test Mode:	TX G Mode 2437MHz		
Remark:	No report for the emission which more than 10 dB below the prescribed limit.		

No.	Mk.	Freq.	Reading Level	Correct Factor	Measurement	Limit	Over	
		MHz	dBuV	dB/m	dBuV/m	dBuV/m	dB	Detector
1	*	4874.880	29.04	14.86	43.90	54.00	-10.10	AVG
2		4874.176	42.72	14.86	57.58	74.00	-16.42	peak

Emission Level= Read Level+ Correct Factor

Temperature:	25 °C	Relative Humidity:	55%
Test Voltage:	AC 120V/60HZ		
Ant. Pol.	Vertical		
Test Mode:	TX G Mode 2437MHz		
Remark:	No report for the emission which more than 10 dB below the prescribed limit.		

No.	Mk.	Freq.	Reading Level	Correct Factor	Measurement	Limit	Over	
		MHz	dBuV	dB/m	dBuV/m	dBuV/m	dB	Detector
1		4873.244	43.26	14.86	58.12	74.00	-15.88	peak
2	*	4874.900	29.07	14.86	43.93	54.00	-10.07	AVG

Emission Level= Read Level+ Correct Factor

Temperature:	25 °C	Relative Humidity:	55%
Test Voltage:	AC 120V/60HZ		
Ant. Pol.	Horizontal		
Test Mode:	TX G Mode 2462MHz		
Remark:	No report for the emission which more than 10 dB below the prescribed limit.		

No.	Mk.	Freq.	Reading Level	Correct Factor	Measurement	Limit	Over	
		MHz	dBuV	dB/m	dBuV/m	dBuV/m	dB	Detector
1		4923.036	44.19	15.17	59.36	74.00	-14.64	peak
2	*	4924.740	29.48	15.18	44.66	54.00	-9.34	AVG

Emission Level= Read Level+ Correct Factor

Temperature:	25 °C	Relative Humidity:	55%
Test Voltage:	AC 120V/60HZ		
Ant. Pol.	Vertical		
Test Mode:	TX G Mode 2462MHz		
Remark:	No report for the emission which more than 10 dB below the prescribed limit.		

No.	Mk.	Freq.	Reading Level	Correct Factor	Measurement	Limit	Over	
		MHz	dBuV	dB/m	dBuV/m	dBuV/m	dB	Detector
1	*	4924.152	29.54	15.17	44.71	54.00	-9.29	AVG
2		4923.204	43.80	15.17	58.97	74.00	-15.03	peak

Emission Level= Read Level+ Correct Factor

Temperature:	25 °C	Relative Humidity:	55%
Test Voltage:	AC 120V/60HZ		
Ant. Pol.	Horizontal		
Test Mode:	TX N(HT20) Mode 2412MHz		
Remark:	No report for the emission which more than 10 dB below the prescribed limit.		

No.	Mk.	Freq.	Reading Level	Correct Factor	Measurement	Limit	Over	
		MHz	dBuV	dB/m	dBuV/m	dBuV/m	dB	Detector
1	*	4825.000	29.14	14.55	43.69	54.00	-10.31	AVG
2		4824.356	43.28	14.55	57.83	74.00	-16.17	peak

Emission Level= Read Level+ Correct Factor

Temperature:	25 °C	Relative Humidity:	55%
Test Voltage:	AC 120V/60HZ		
Ant. Pol.	Vertical		
Test Mode:	TX N(HT20) Mode 2412MHz		
Remark:	No report for the emission which more than 10 dB below the prescribed limit.		

No.	Mk.	Freq.	Reading Level	Correct Factor	Measurement	Limit	Over	
		MHz	dBuV	dB/m	dBuV/m	dBuV/m	dB	Detector
1		4824.360	43.56	14.55	58.11	74.00	-15.89	peak
2	*	4824.980	29.16	14.55	43.71	54.00	-10.29	AVG

Emission Level= Read Level+ Correct Factor

Temperature:	25 °C	Relative Humidity:	55%
Test Voltage:	AC 120V/60HZ		
Ant. Pol.	Horizontal		
Test Mode:	TX N(HT20) Mode 2437MHz		
Remark:	No report for the emission which more than 10 dB below the prescribed limit.		

No.	Mk.	Freq.	Reading Level	Correct Factor	Measurement	Limit	Over	
		MHz	dBuV	dB/m	dBuV/m	dBuV/m	dB	Detector
1		4873.804	43.60	14.86	58.46	74.00	-15.54	peak
2	*	4874.980	29.06	14.86	43.92	54.00	-10.08	AVG

Emission Level= Read Level+ Correct Factor

Temperature:	25 °C	Relative Humidity:	55%
Test Voltage:	AC 120V/60HZ		
Ant. Pol.	Vertical		
Test Mode:	TX N(HT20) Mode 2437MHz		
Remark:	No report for the emission which more than 10 dB below the prescribed limit.		

No.	Mk.	Freq.	Reading Level	Correct Factor	Measurement	Limit	Over	
		MHz	dBuV	dB/m	dBuV/m	dBuV/m	dB	Detector
1	*	4874.920	29.07	14.86	43.93	54.00	-10.07	AVG
2		4874.952	42.86	14.86	57.72	74.00	-16.28	peak

Emission Level= Read Level+ Correct Factor

Temperature:	25 °C	Relative Humidity:	55%
Test Voltage:	AC 120V/60HZ		
Ant. Pol.	Horizontal		
Test Mode:	TX N(HT20) Mode 2462MHz		
Remark:	No report for the emission which more than 10 dB below the prescribed limit.		

No.	Mk.	Freq.	Reading Level	Correct Factor	Measurement	Limit	Over	
		MHz	dBuV	dB/m	dBuV/m	dBuV/m	dB	Detector
1	*	4924.856	29.48	15.18	44.66	54.00	-9.34	AVG
2		4924.072	43.71	15.17	58.88	74.00	-15.12	peak

Emission Level= Read Level+ Correct Factor

Temperature:	25 °C	Relative Humidity:	55%
Test Voltage:	AC 120V/60HZ		
Ant. Pol.	Vertical		
Test Mode:	TX N(HT20) Mode 2462MHz		
Remark:	No report for the emission which more than 10 dB below the prescribed limit.		

No.	Mk.	Freq.	Reading Level	Correct Factor	Measurement	Limit	Over	
		MHz	dBuV	dB/m	dBuV/m	dBuV/m	dB	Detector
1		4923.668	43.75	15.17	58.92	74.00	-15.08	peak
2	*	4924.052	29.51	15.17	44.68	54.00	-9.32	AVG

Emission Level= Read Level+ Correct Factor

Conducted RF Spurious Emission Test Data

Temperature:	25 °C	Relative Humidity:	55%
Test Voltage:	AC 120/60Hz		
Test Mode:	TX B Mode		
Remark:	This report only shall the worst case mode for TX IEEE 802.11b.		

2412 MHz

0.03GHz-26.5GHz

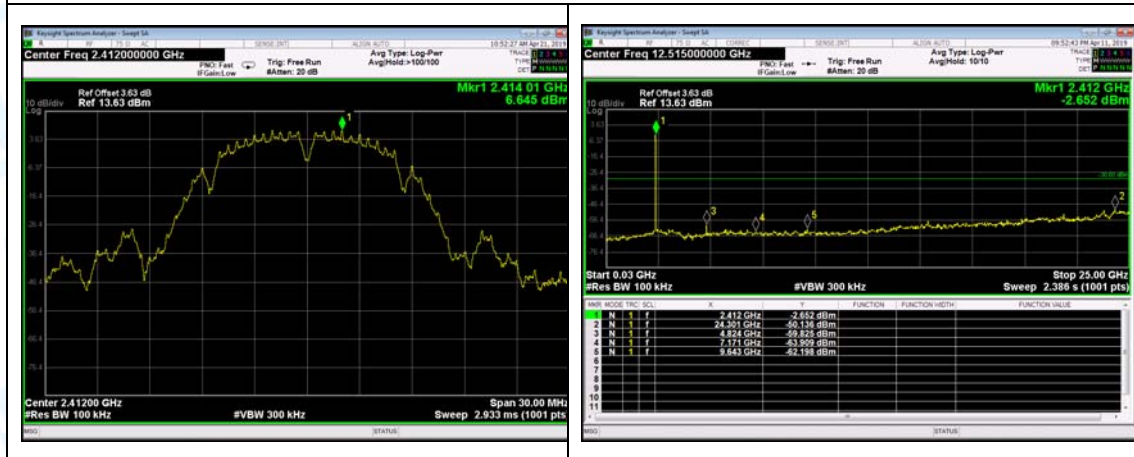

2462 MHz

0.03GHz-26.5GHz

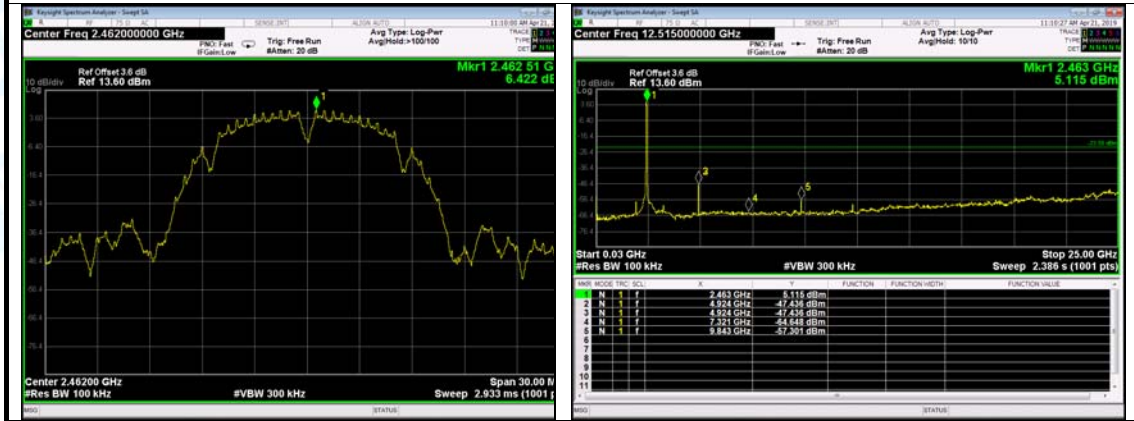

Attachment C-- Restricted Bands Requirement and Band-edge Test Data

(1) Radiation Test

Temperature:	25 °C	Relative Humidity:	55%
Test Voltage:	AC 120V/60HZ		
Ant. Pol.	Horizontal		
Test Mode:	TX B Mode 2412MHz		
Remark:	N/A		

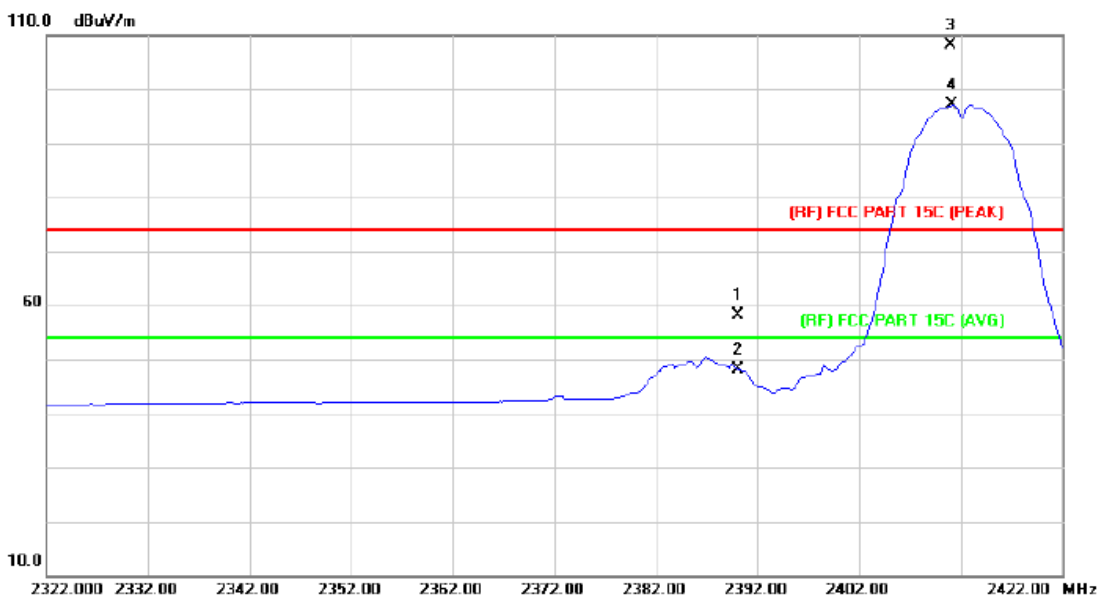

No.	Mk.	Freq. MHz	Reading Level dBuV	Correct Factor dB/m	Measure- ment dBuV/m	Limit dBuV/m	Over dB	Detector
1		2390.000	55.85	2.28	58.13	74.00	-15.87	peak
2		2390.000	45.84	2.28	48.12	54.00	-5.88	AVG
3	X	2411.000	105.75	2.39	108.14	Fundamental Frequency		peak
4	*	2411.200	94.73	2.39	97.12	Fundamental Frequency		AVG

Emission Level= Read Level+ Correct Factor

Temperature:	25 °C	Relative Humidity:	55%
Test Voltage:	AC 120V/60HZ		
Ant. Pol.	Vertical		
Test Mode:	TX B Mode 2412MHz		
Remark:	N/A		

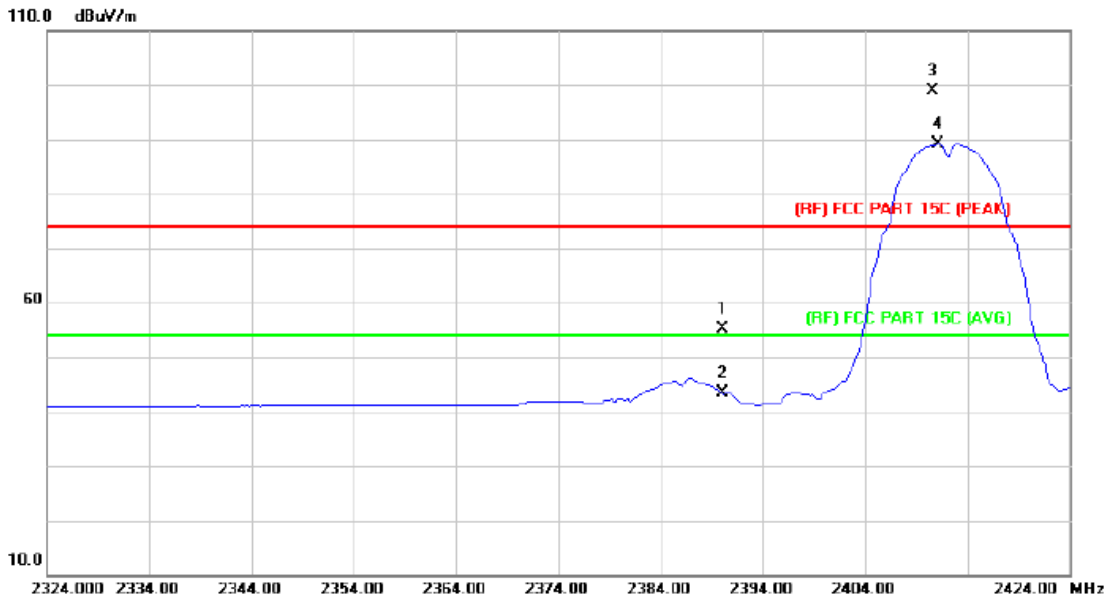

No.	Mk.	Freq. MHz	Reading Level dBuV	Correct Factor dB/m	Measure- ment dBuV/m	Limit dBuV/m	Over dB	Detector
1		2390.000	52.83	2.28	55.11	74.00	-18.89	peak
2		2390.000	41.10	2.28	43.38	54.00	-10.62	AVG
3	X	2410.600	96.59	2.39	98.98	Fundamental Frequency		peak
4	*	2411.200	86.86	2.39	89.25	Fundamental Frequency		AVG

Emission Level= Read Level+ Correct Factor

Temperature:	25 °C	Relative Humidity:	55%
Test Voltage:	AC 120V/60HZ		
Ant. Pol.	Horizontal		
Test Mode:	TX B Mode 2462MHz		
Remark:	N/A		

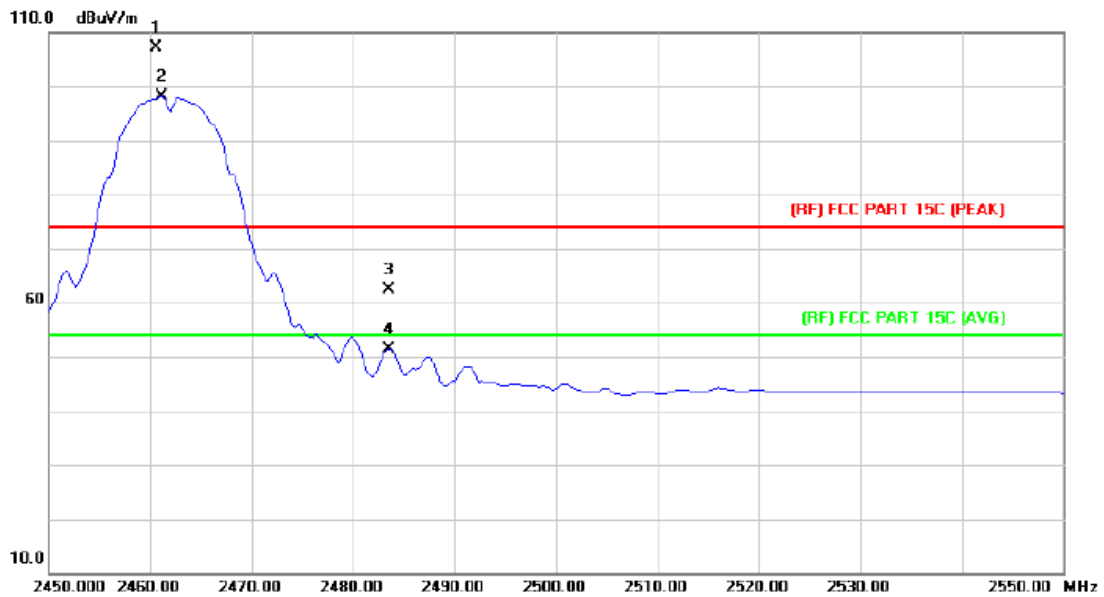

No.	Mk.	Freq. MHz	Reading Level dBuV	Correct Factor dB/m	Measure- ment dBuV/m	Limit dBuV/m	Over dB	Detector
1	X	2460.600	104.42	2.61	107.03	Fundamental Frequency		peak
2	*	2461.200	95.45	2.62	98.07	Fundamental Frequency		AVG
3		2483.500	59.61	2.71	62.32	74.00	-11.68	peak
4		2483.500	48.71	2.71	51.42	54.00	-2.58	AVG

Emission Level= Read Level+ Correct Factor

Temperature:	25 °C	Relative Humidity:	55%
Test Voltage:	AC 120V/60HZ		
Ant. Pol.	Vertical		
Test Mode:	TX B Mode 2462MHz		
Remark:	N/A		

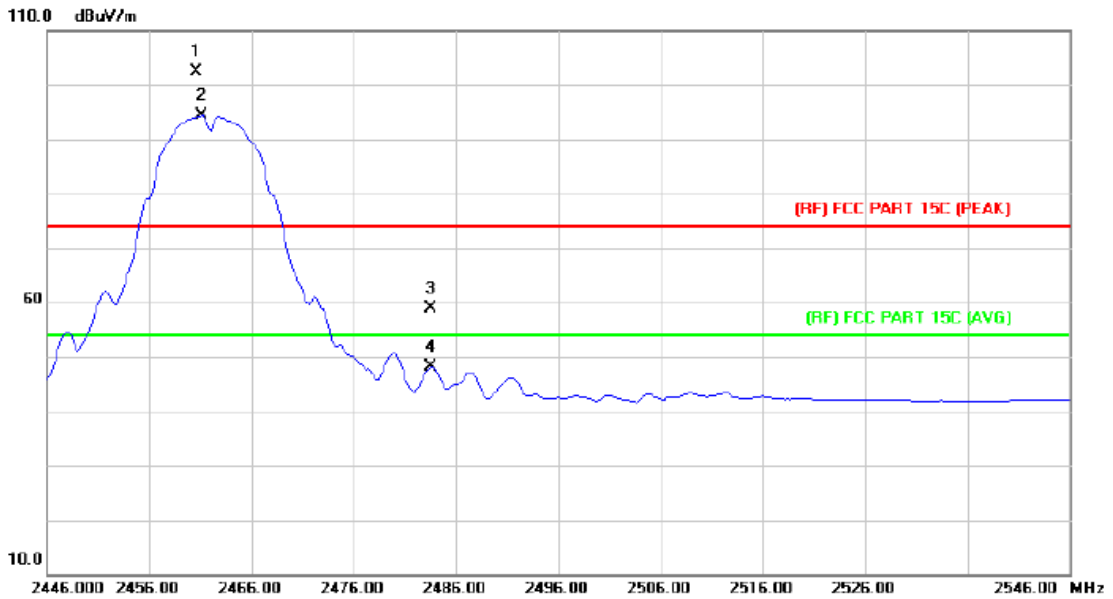

No.	Mk.	Freq. MHz	Reading Level dBuV	Correct Factor dB/m	Measure- ment dBuV/m	Limit dBuV/m	Over dB	Detector
1	X	2460.600	99.72	2.61	102.33	Fundamental Frequency		peak
2	*	2461.200	91.65	2.62	94.27	Fundamental Frequency		AVG
3		2483.500	56.28	2.71	58.99	74.00	-15.01	peak
4		2483.500	45.32	2.71	48.03	54.00	-5.97	AVG

Emission Level= Read Level+ Correct Factor

Temperature:	25 °C	Relative Humidity:	55%
Test Voltage:	AC 120V/60HZ		
Ant. Pol.	Horizontal		
Test Mode:	TX G Mode 2412MHz		
Remark:	N/A		

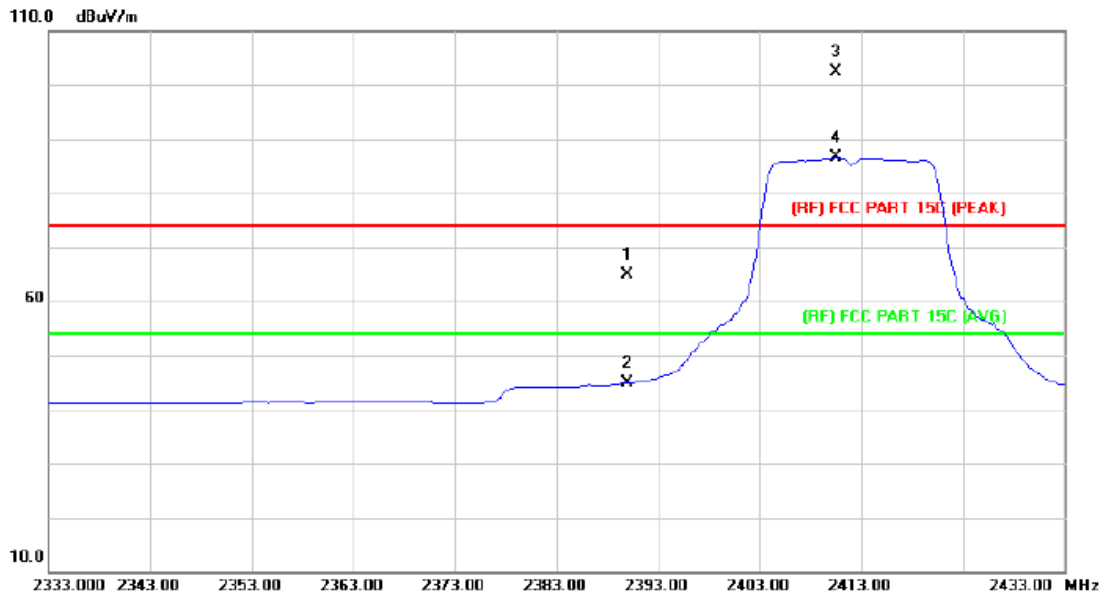

No.	Mk.	Freq. MHz	Reading Level dBuV	Correct Factor dB/m	Measure- ment dBuV/m	Limit dBuV/m	Over dB	Detector
1		2390.000	62.49	2.28	64.77	74.00	-9.23	peak
2		2390.000	42.49	2.28	44.77	54.00	-9.23	AVG
3	X	2410.600	100.01	2.39	102.40	Fundamental Frequency		peak
4	*	2410.600	84.14	2.39	86.53	Fundamental Frequency		AVG

Emission Level= Read Level+ Correct Factor

Temperature:	25 °C	Relative Humidity:	55%
Test Voltage:	AC 120V/60HZ		
Ant. Pol.	Vertical		
Test Mode:	TX G Mode 2412MHz		
Remark:	N/A		

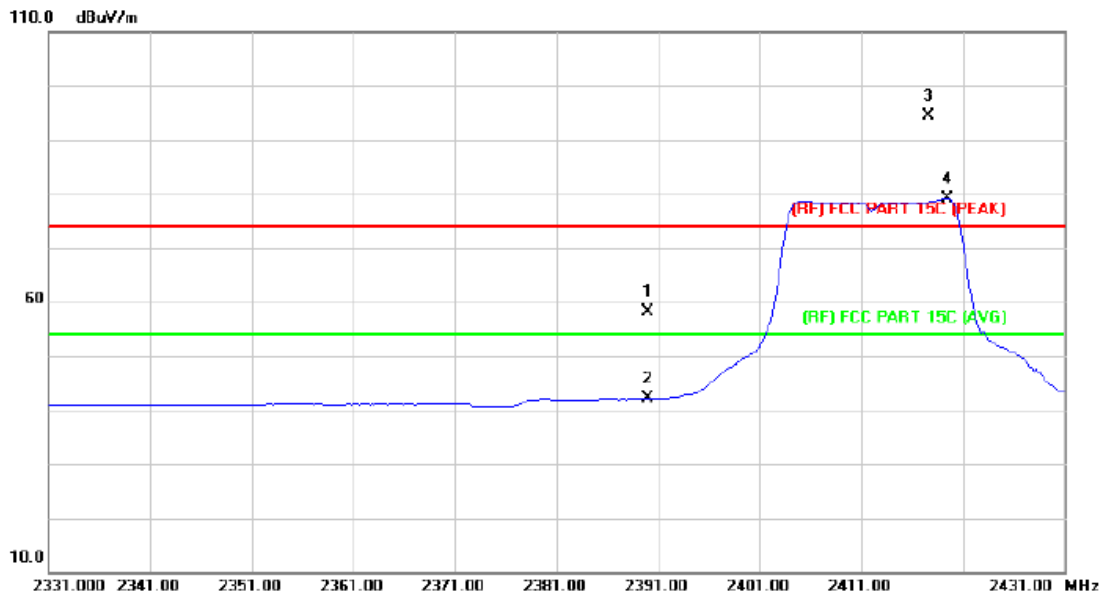

No.	Mk.	Freq. MHz	Reading Level dBuV	Correct Factor dB/m	Measure- ment dBuV/m	Limit dBuV/m	Over dB	Detector
1		2390.000	55.92	2.28	58.20	74.00	-15.80	peak
2		2390.000	39.84	2.28	42.12	54.00	-11.88	AVG
3	X	2417.600	91.95	2.42	94.37	Fundamental Frequency		peak
4	*	2419.400	76.77	2.42	79.19	Fundamental Frequency		AVG

Emission Level= Read Level+ Correct Factor

Temperature:	25 °C	Relative Humidity:	55%
Test Voltage:	AC 120V/60HZ		
Ant. Pol.	Horizontal		
Test Mode:	TX G Mode 2462MHz		
Remark:	N/A		

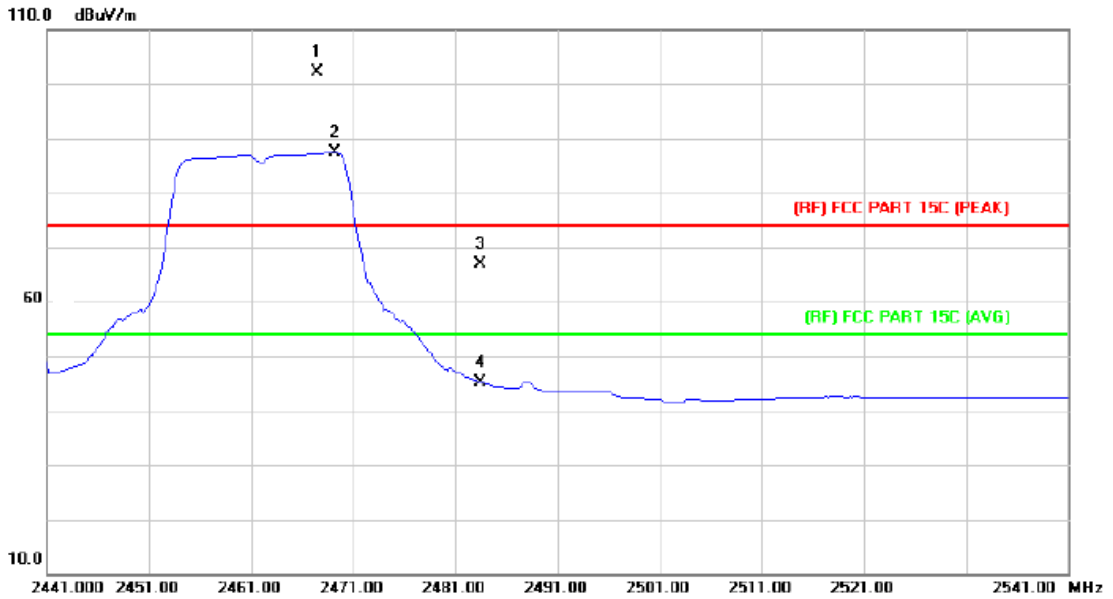

No.	Mk.	Freq. MHz	Reading Level dBuV	Correct Factor dB/m	Measure- ment dBuV/m	Limit dBuV/m	Over dB	Detector
1	X	2467.400	99.52	2.64	102.16	Fundamental Frequency		peak
2	*	2469.200	84.81	2.65	87.46	Fundamental Frequency		AVG
3		2483.500	64.19	2.71	66.90	74.00	-7.10	peak
4		2483.500	42.43	2.71	45.14	54.00	-8.86	AVG

Emission Level= Read Level+ Correct Factor

Temperature:	25 °C	Relative Humidity:	55%
Test Voltage:	AC 120V/60HZ		
Ant. Pol.	Vertical		
Test Mode:	TX G Mode 2462MHz		
Remark:	N/A		

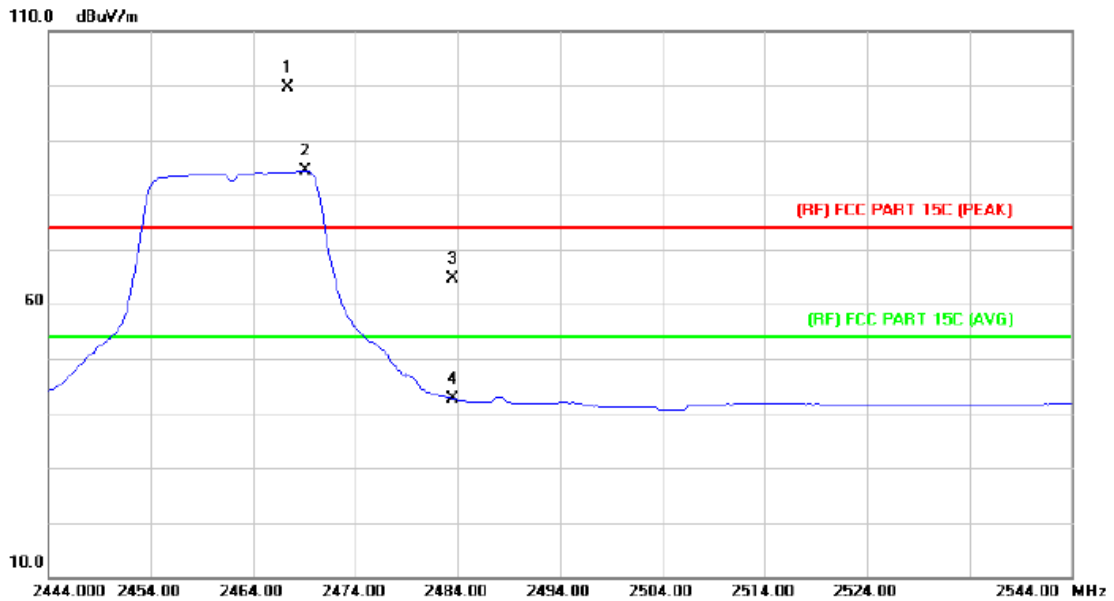

No.	Mk.	Freq. MHz	Reading Level dBuV	Correct Factor dB/m	Measure- ment dBuV/m	Limit dBuV/m	Over dB	Detector
1	X	2467.400	96.98	2.64	99.62	Fundamental Frequency		peak
2	*	2469.200	81.71	2.65	84.36	Fundamental Frequency		AVG
3		2483.500	61.91	2.71	64.62	74.00	-9.38	peak
4		2483.500	39.92	2.71	42.63	54.00	-11.37	AVG

Emission Level= Read Level+ Correct Factor

Temperature:	25 °C	Relative Humidity:	55%
Test Voltage:	AC 120V/60HZ		
Ant. Pol.	Horizontal		
Test Mode:	TX N(HT20) Mode 2412MHz		
Remark:	N/A		

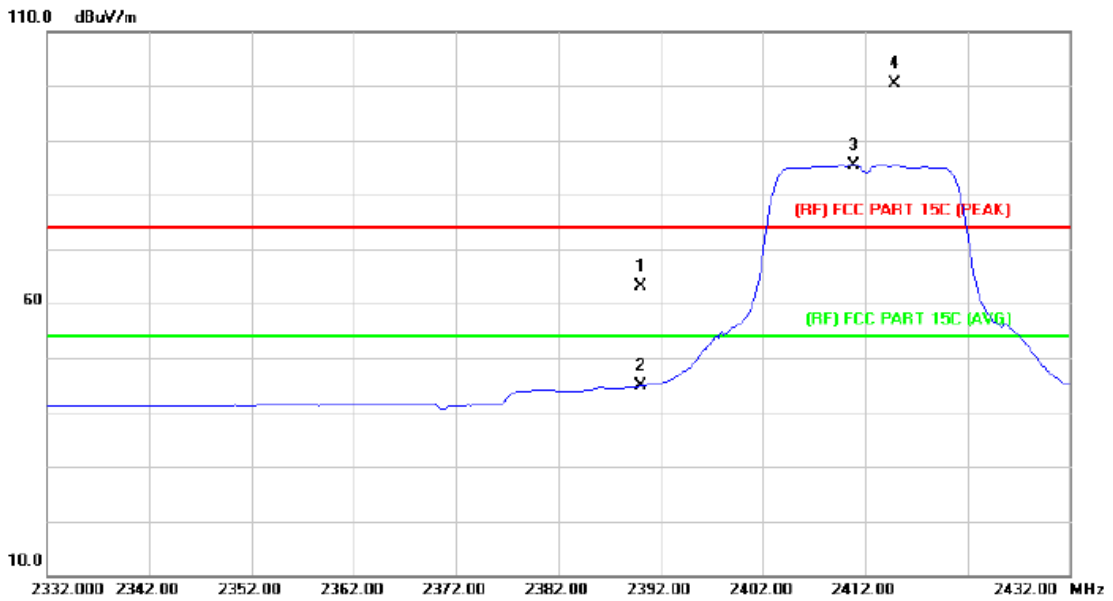

No.	Mk.	Freq. MHz	Reading Level dBuV	Correct Factor dB/m	Measure- ment dBuV/m	Limit dBuV/m	Over dB	Detector
1		2390.000	60.81	2.28	63.09	74.00	-10.91	peak
2		2390.000	42.50	2.28	44.78	54.00	-9.22	AVG
3	*	2410.800	83.10	2.39	85.49	Fundamental Frequency		AVG
4	X	2414.800	97.89	2.40	100.29	Fundamental Frequency		peak

Emission Level= Read Level+ Correct Factor

Temperature:	25 °C	Relative Humidity:	55%
Test Voltage:	AC 120V/60HZ		
Ant. Pol.	Vertical		
Test Mode:	TX N(HT20) Mode 2412MHz		
Remark:	N/A		

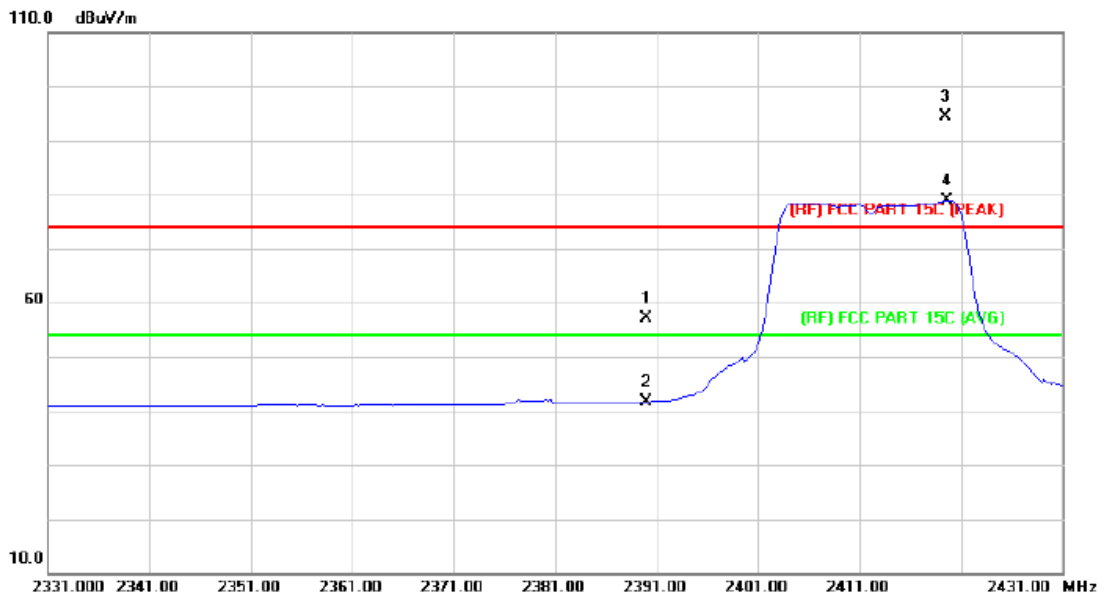

No.	Mk.	Freq. MHz	Reading Level dBuV	Correct Factor dB/m	Measure- ment dBuV/m	Limit dBuV/m	Over dB	Detector
1		2390.000	54.93	2.28	57.21	74.00	-16.79	peak
2		2390.000	39.39	2.28	41.67	54.00	-12.33	AVG
3	X	2419.400	92.06	2.42	94.48	Fundamental Frequency		peak
4	*	2419.600	76.54	2.42	78.96	Fundamental Frequency		AVG

Emission Level= Read Level+ Correct Factor

Temperature:	25 °C	Relative Humidity:	55%
Test Voltage:	AC 120V/60HZ		
Ant. Pol.	Horizontal		
Test Mode:	TX N(HT20) Mode 2462MHz		
Remark:	N/A		

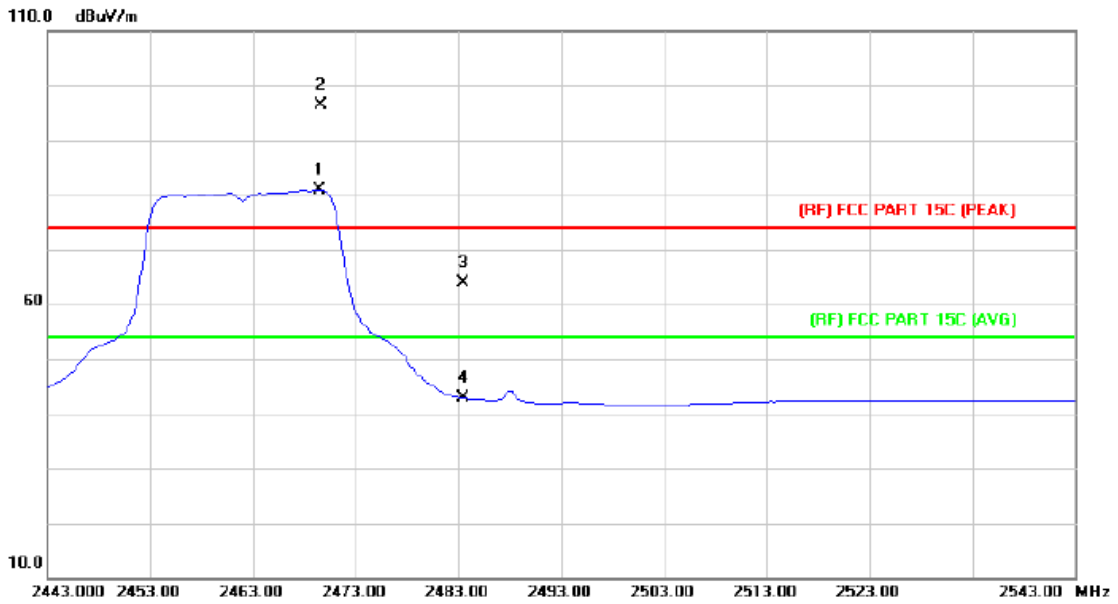

No.	Mk.	Freq. MHz	Reading Level dBuV	Correct Factor dB/m	Measure- ment dBuV/m	Limit dBuV/m	Over dB	Detector
1	*	2469.400	78.30	2.65	80.95	Fundamental Frequency		AVG
2	X	2469.600	93.78	2.65	96.43	Fundamental Frequency		peak
3		2483.500	61.16	2.71	63.87	74.00	-10.13	peak
4		2483.500	40.10	2.71	42.81	54.00	-11.19	AVG

Emission Level= Read Level+ Correct Factor

Temperature:	25 °C	Relative Humidity:	55%
Test Voltage:	AC 120V/60HZ		
Ant. Pol.	Vertical		
Test Mode:	TX N(HT20) Mode 2462MHz		
Remark:	N/A		

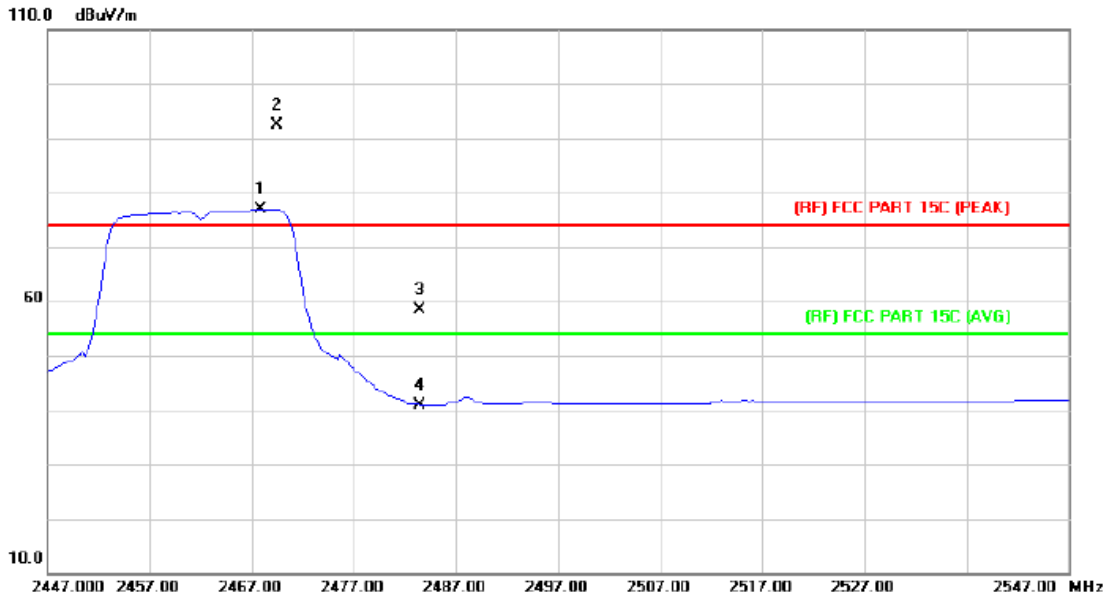

No.	Mk.	Freq. MHz	Reading Level dBuV	Correct Factor dB/m	Measure- ment dBuV/m	Limit dBuV/m	Over dB	Detector
1	*	2467.800	74.30	2.64	76.94	Fundamental Frequency		AVG
2	X	2469.400	89.78	2.65	92.43	Fundamental Frequency		peak
3		2483.500	55.72	2.71	58.43	74.00	-15.57	peak
4		2483.500	38.25	2.71	40.96	54.00	-13.04	AVG

Emission Level= Read Level+ Correct Factor

(2) Conducted Test

Temperature:	25 °C	Relative Humidity:	55%
Test Voltage:	AC 120V/60HZ		
Test Mode:	TX B Mode 2412MHz / TX B Mode 2462MHz		
Remark:	The EUT is programed in continuously transmitting mode		

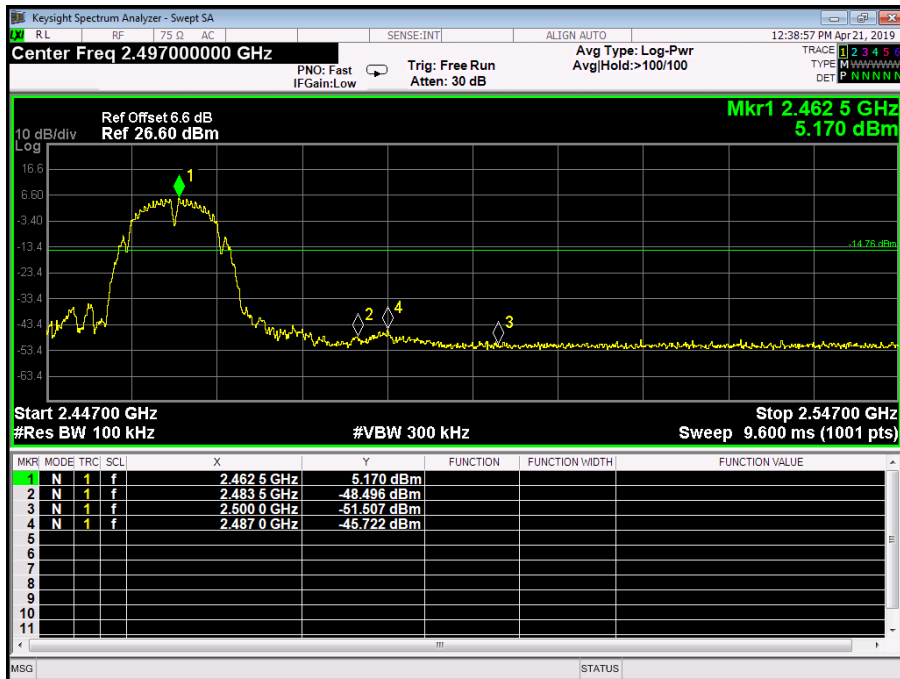
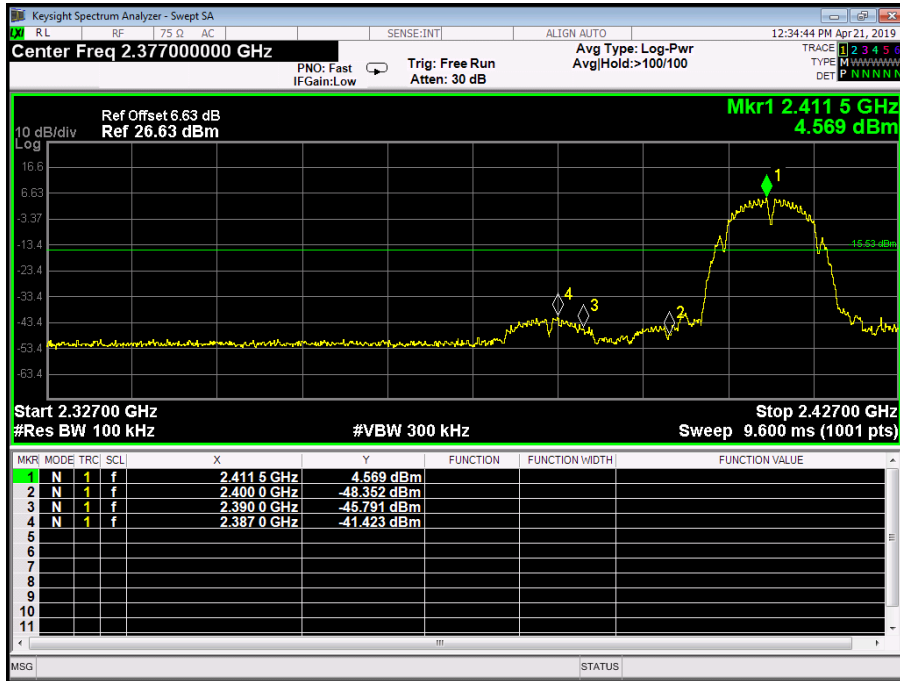

Temperature:	25 °C	Relative Humidity:	55%
Test Voltage:	AC 120V/60HZ		
Test Mode:	TX G Mode 2412MHz / TX G Mode 2462MHz		
Remark:	The EUT is programed in continuously transmitting mode		

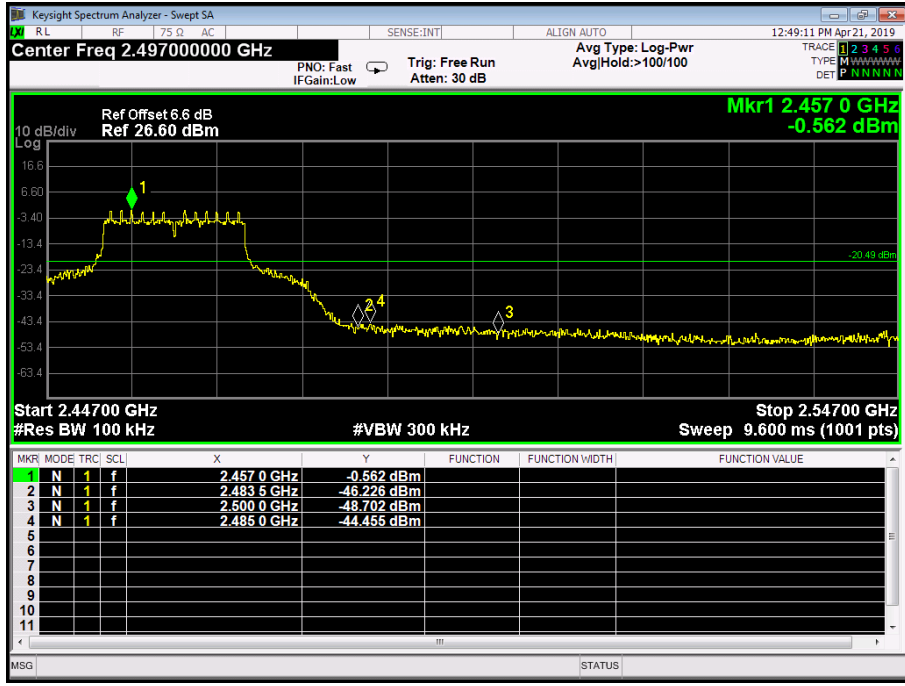
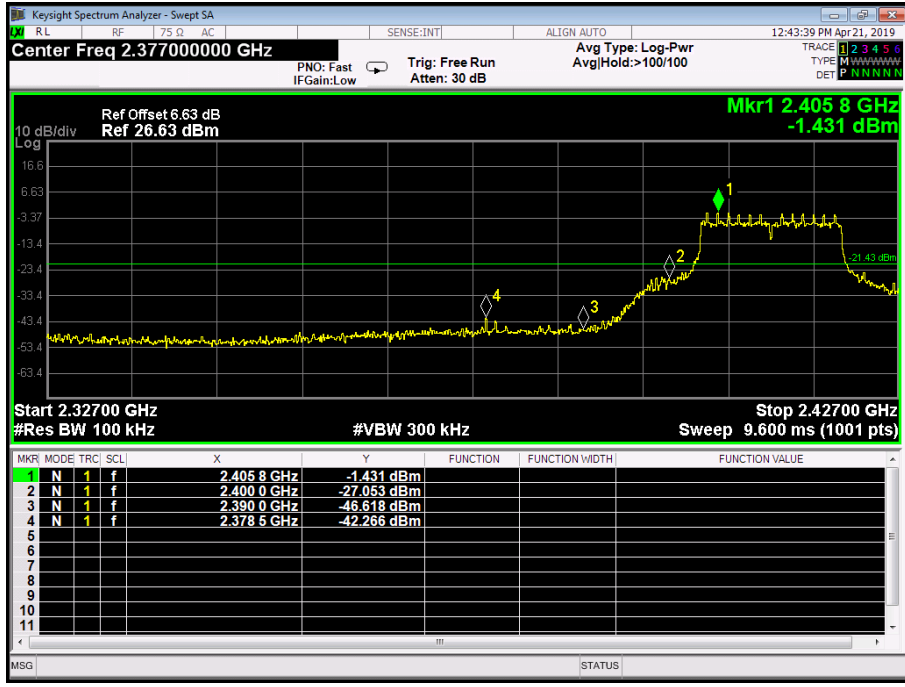

Temperature:	25 °C	Relative Humidity:	55%
Test Voltage:	AC 120V/60HZ		
Test Mode:	TX N(HT20) Mode 2412MHz / TX N(HT20) Mode 2462MHz		
Remark:	The EUT is programed in continuously transmitting mode		

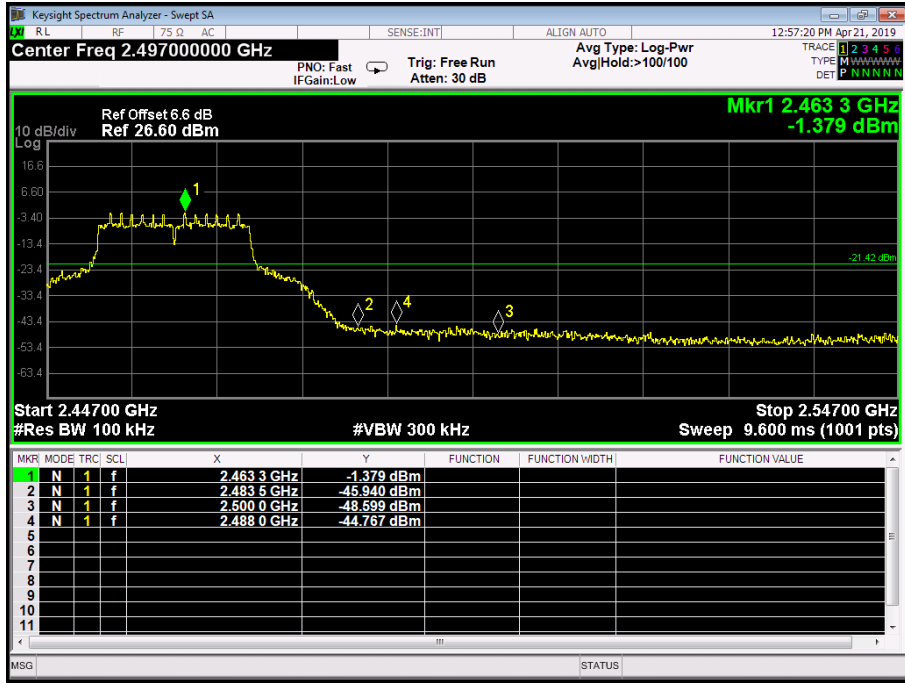
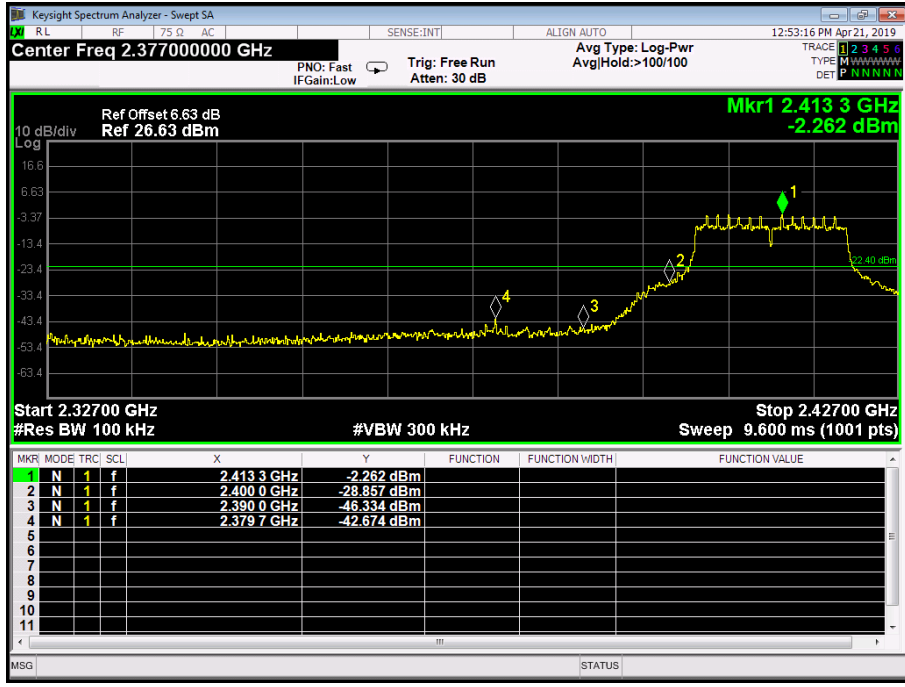

Attachment D-- Bandwidth Test Data

Temperature:	25 °C	Relative Humidity:	55%
Test Voltage:	AC 120V/60HZ		
Test Mode:	TX 802.11B Mode		
Channel frequency (MHz)	6dB Bandwidth (MHz)	99% Bandwidth (MHz)	Limit (MHz)
2412	8.101	10.707	>=0.5
2437	8.544	10.668	
2462	8.064	10.618	
802.11B Mode			
2412 MHz			

802.11B Mode

2437 MHz

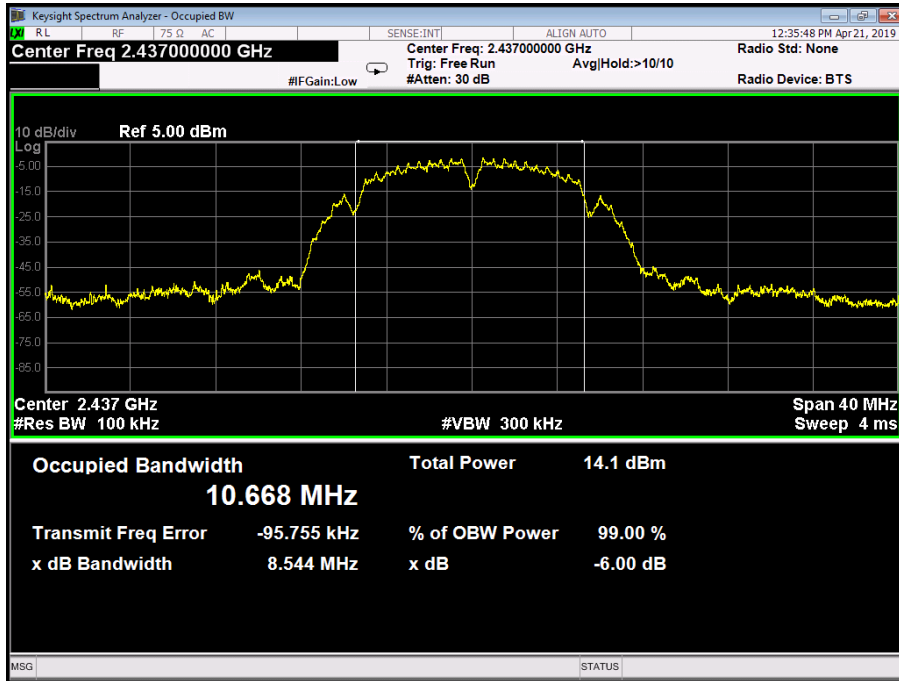

802.11B Mode

2462 MHz

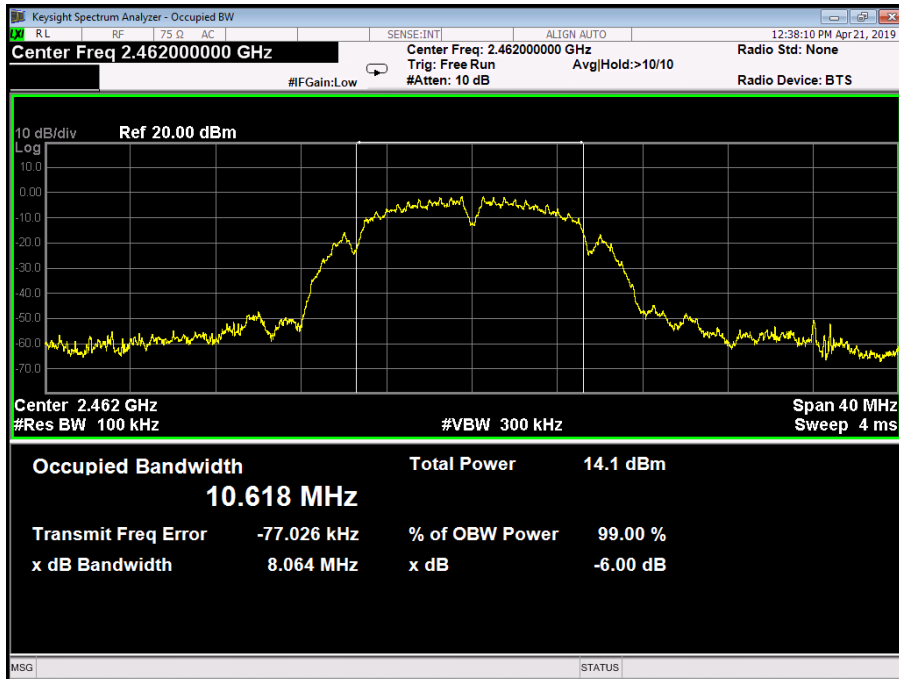

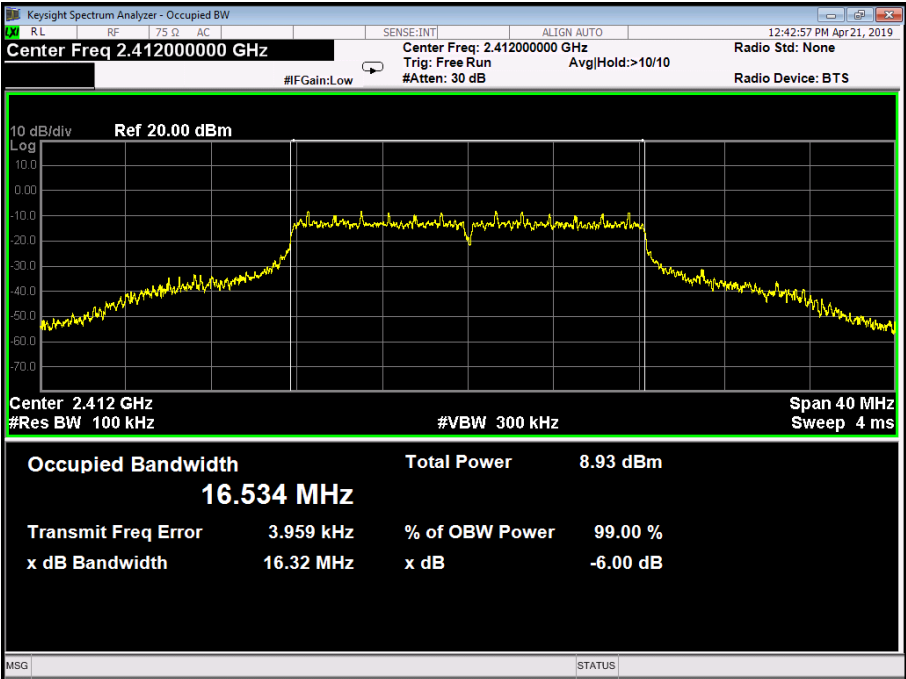
Temperature:	25 °C	Relative Humidity:	55%
Test Voltage:	AC 120V/60HZ		
Test Mode:	TX 802.11G Mode		
Channel frequency (MHz)	6dB Bandwidth (MHz)	99% Bandwidth (MHz)	Limit (MHz)
2412	16.32	16.534	>=0.5
2437	16.35	16.619	
2462	16.33	16.808	
802.11G Mode			
2412 MHz			
			

802.11G Mode

2437 MHz

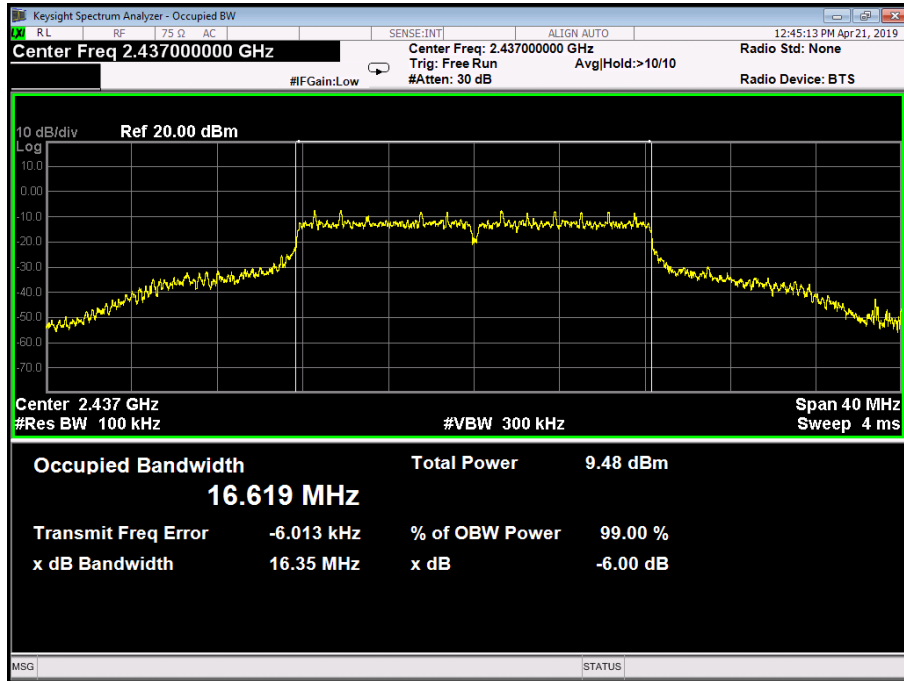

802.11G Mode

2462 MHz

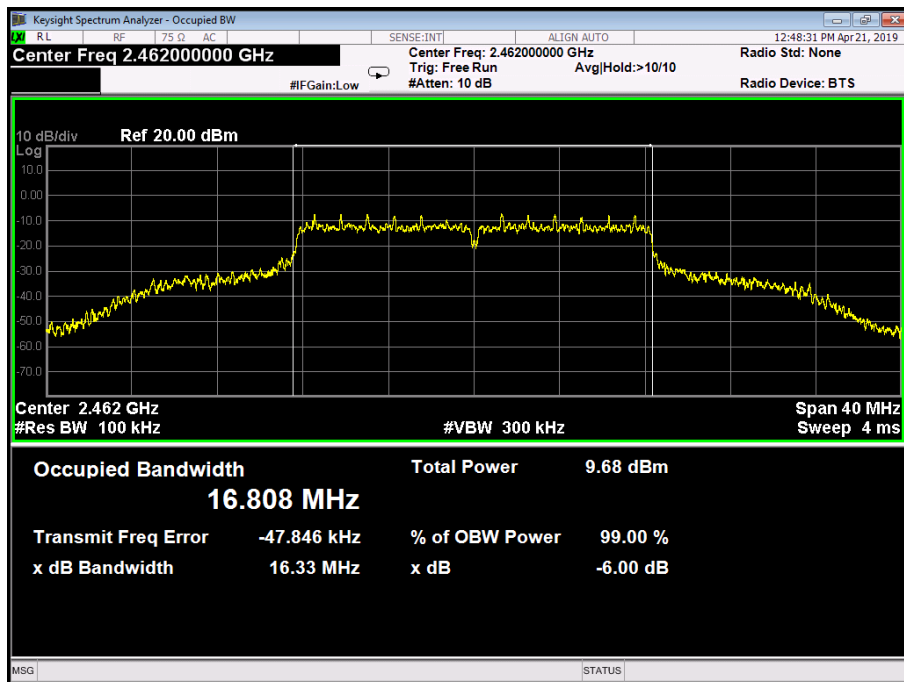

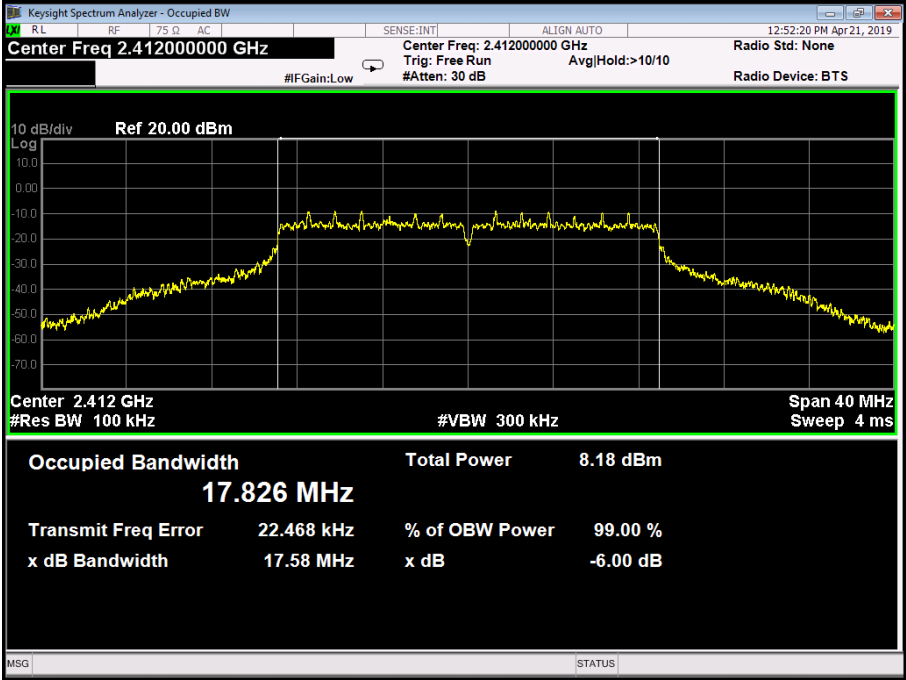
Temperature:	25 °C	Relative Humidity:	55%
Test Voltage:	AC 120V/60HZ		
Test Mode:	TX 802.11N(HT20) Mode		
Channel frequency (MHz)	6dB Bandwidth (MHz)	99% Bandwidth (MHz)	Limit (MHz)
2412	17.58	17.826	≥0.5
2437	17.58	17.906	
2462	17.57	18.111	
802.11N(HT20) Mode			
2412 MHz			
			

802.11N(HT20) Mode

2437 MHz

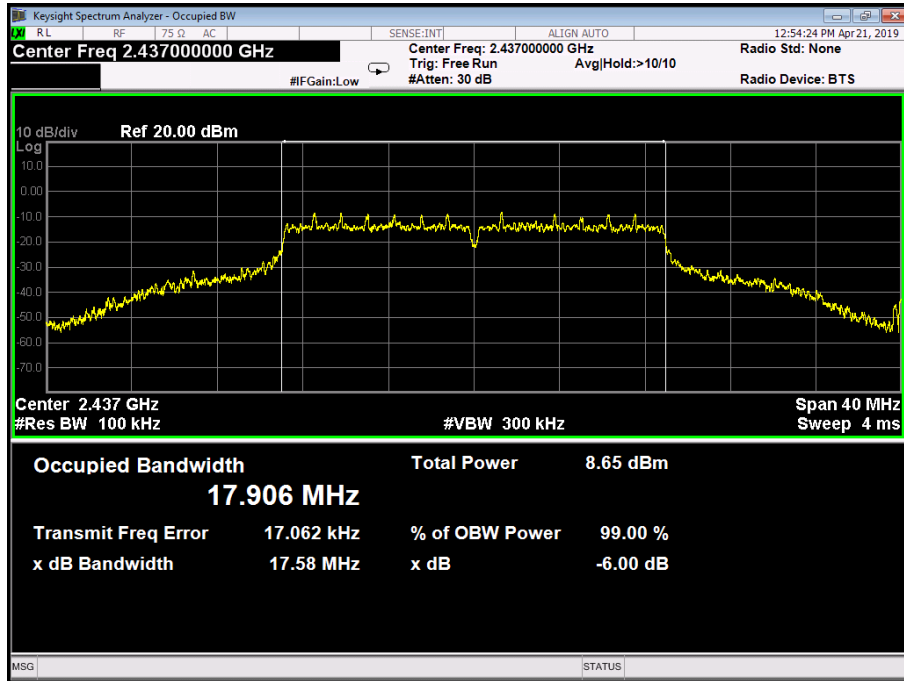

802.11N(HT20) Mode

2462 MHz

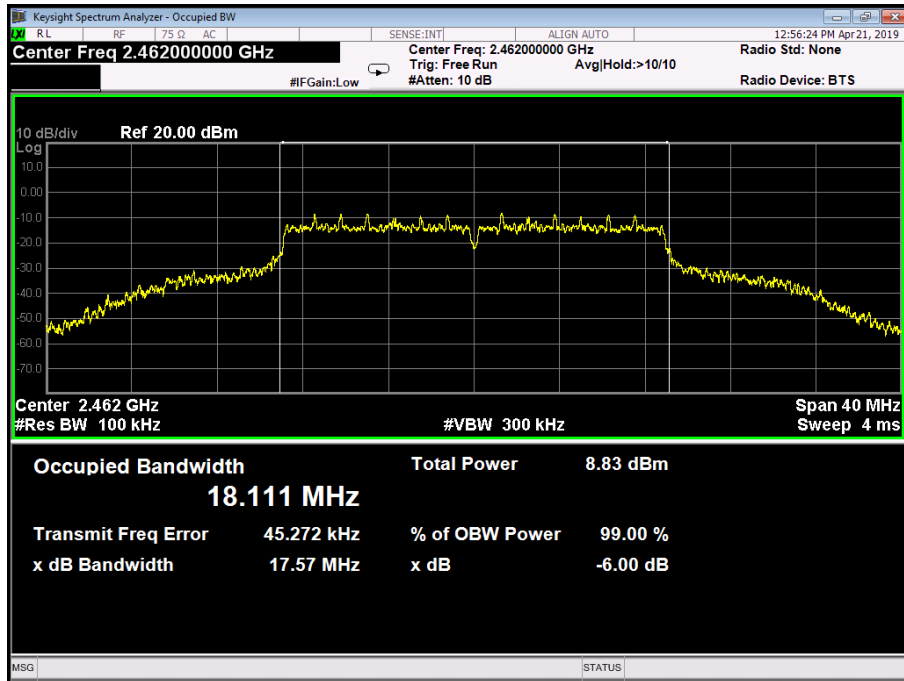

Attachment E-- Peak Output Power Test Data

Test Conditions:		Continuous transmitting Mode	
Temperature:		25 °C	Relative Humidity: 55%
Test Voltage:		AC 120V/60HZ	
Mode	Channel frequency (MHz)	Test Result (dBm)	Limit (dBm)
802.11b	2412	15.39	30
	2437	15.73	
	2462	15.97	
802.11g	2412	14.54	
	2437	15.15	
	2462	15.45	
802.11n (HT20)	2412	13.77	
	2437	14.28	
	2462	14.48	
Result: PASS			

Duty Cycle		
Mode	Channel frequency (MHz)	Test Result
802.11b	2412	>98%
	2437	
	2462	
802.11g	2412	
	2437	
	2462	
802.11n (HT20)	2412	
	2437	
	2462	

Please see below plots

802.11 B Mode 2437 MHz

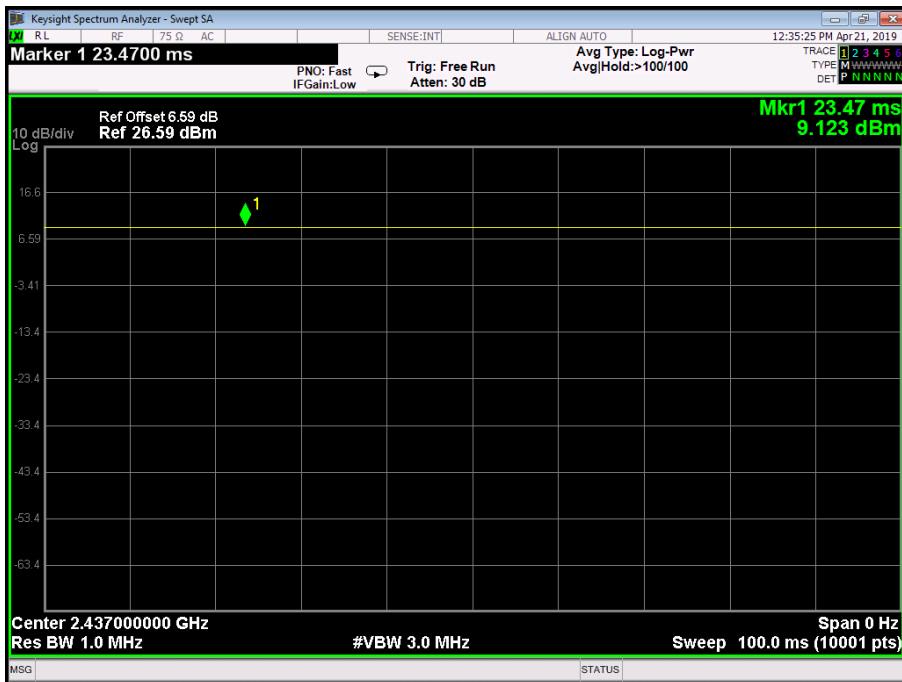

802.11 G Mode 2437 MHz

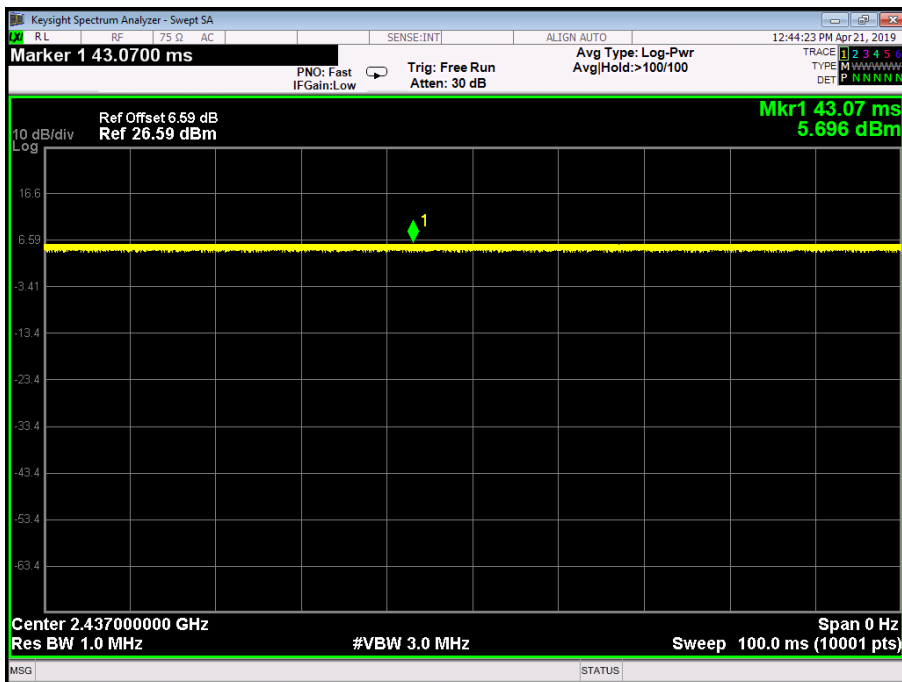

802.11 N(HT20) Mode 2437 MHz

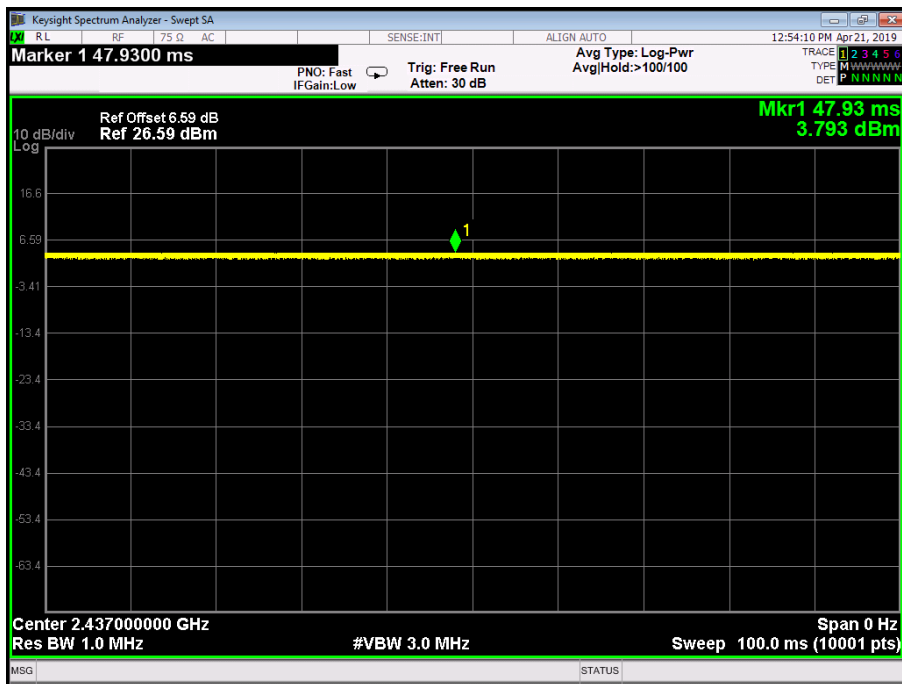

Attachment F-- Power Spectral Density Test Data

Temperature:	25 °C	Relative Humidity:	55%
Test Voltage:	AC 120V/60HZ		
Test Mode:	TX 802.11B Mode		
Channel Frequency (MHz)	Power Density (dBm/3 kHz)	Limit (dBm/3kHz)	
2412	-10.012	8	
2437	-10.038		
2462	-9.866		

802.11B Mode

2412 MHz

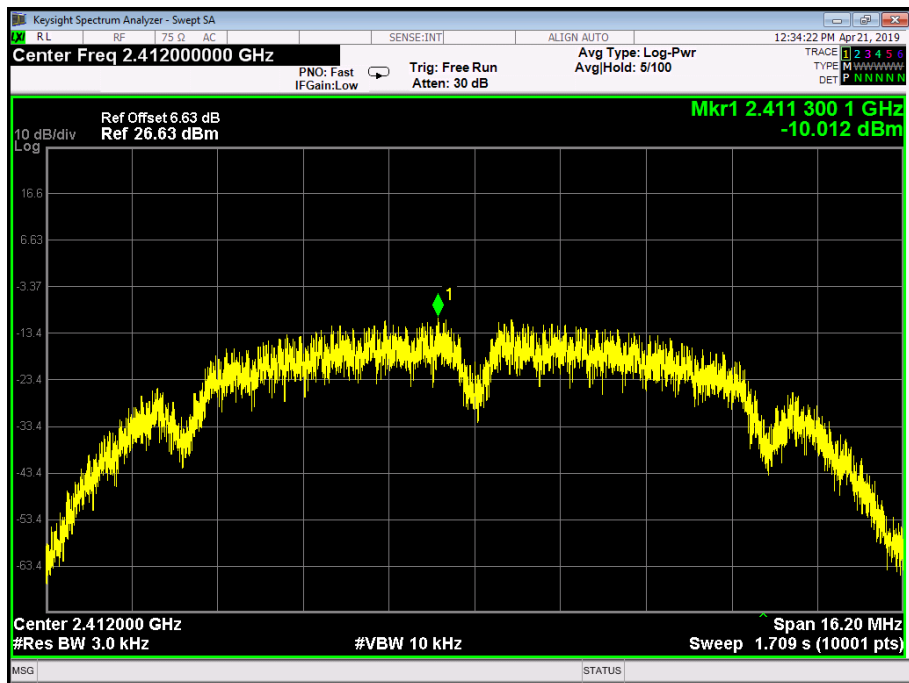

802.11B Mode
2437 MHz

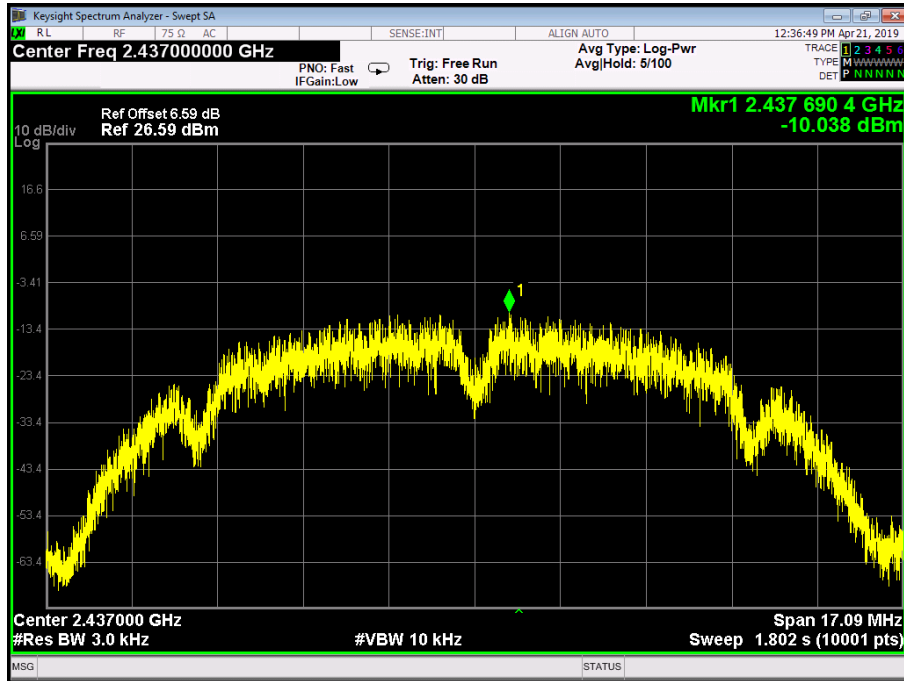

802.11B Mode
2462 MHz

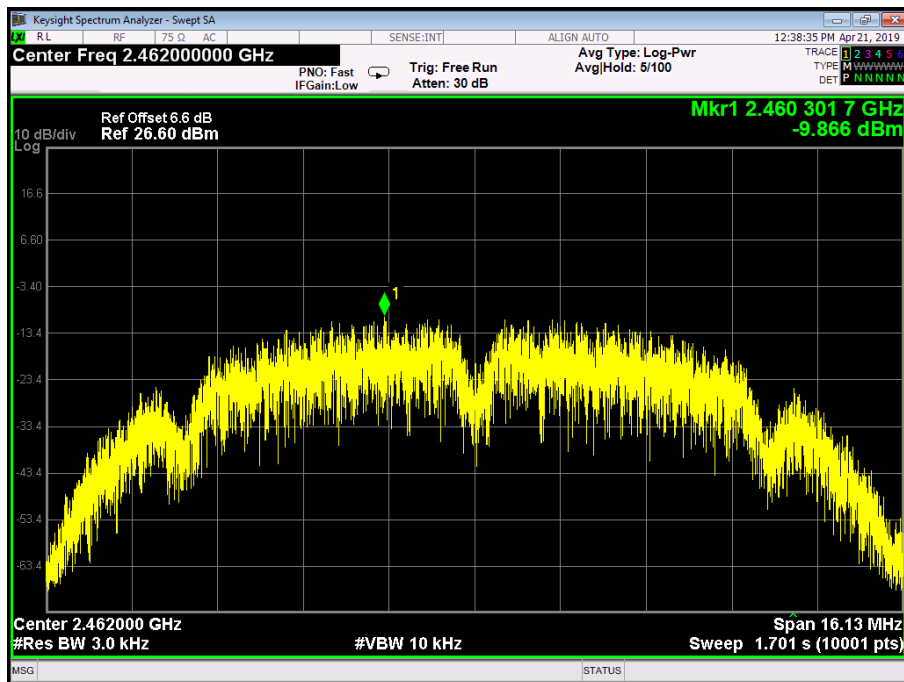

Temperature:	25 °C	Temperature:	25 °C
Test Voltage:	AC 120V/60HZ		
Test Mode:	TX 802.11G Mode		
Channel Frequency (MHz)	Power Density (dBm/3 kHz)	Limit (dBm/3kHz)	
2412	-16.313	8	
2437	-16.795		
2462	-15.469		
802.11G Mode			

2412 MHz

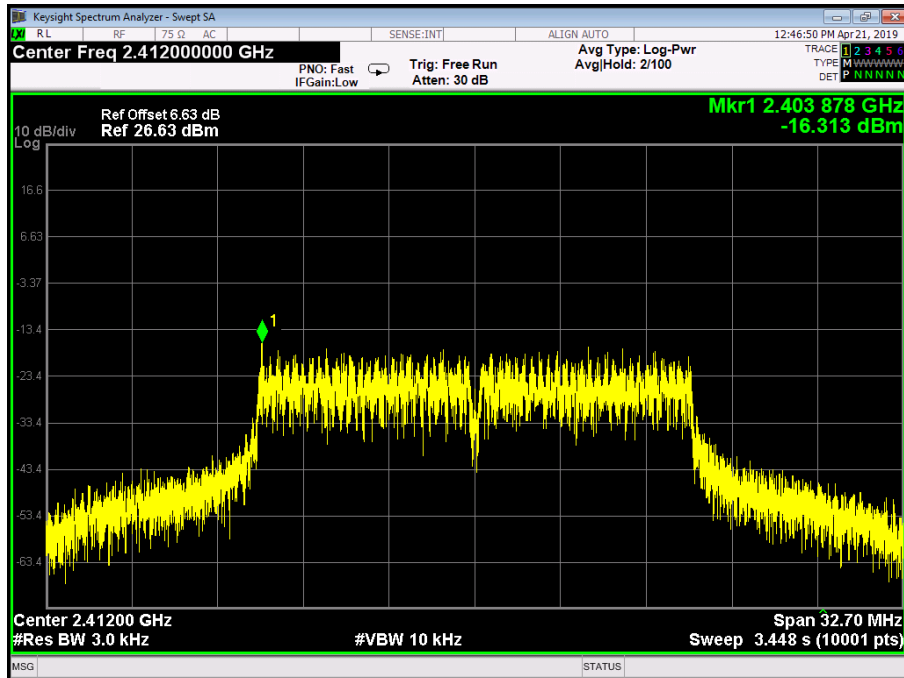

802.11G Mode
2437 MHz

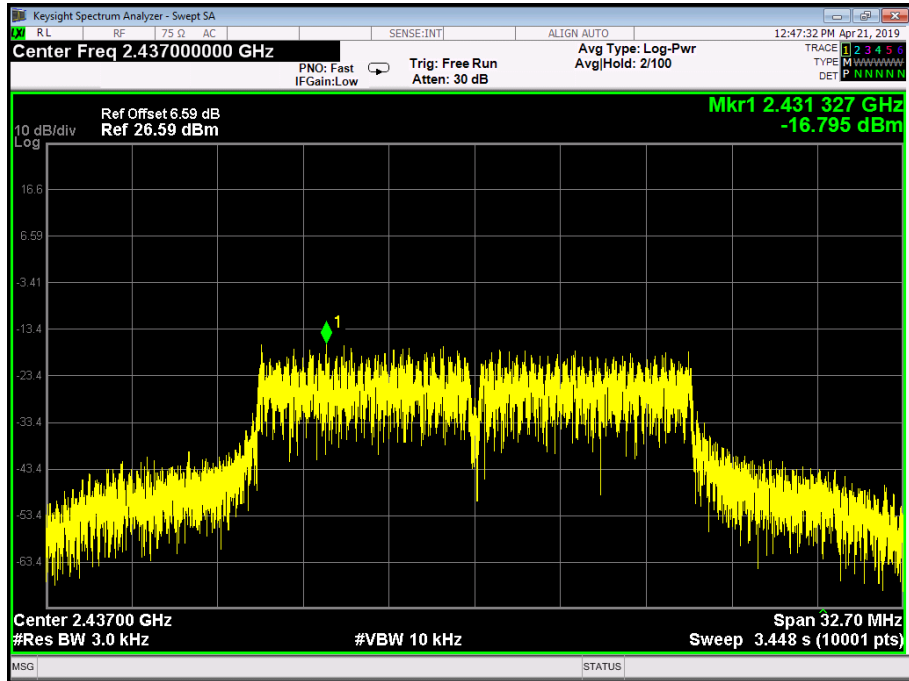

802.11G Mode
2462 MHz

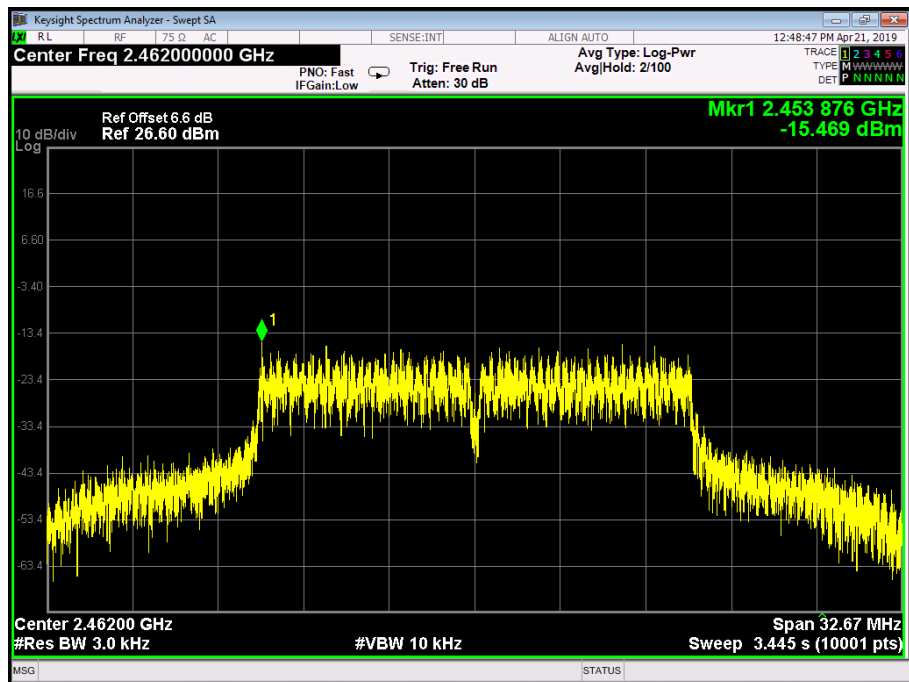

Temperature:	25 °C	Temperature:	25 °C
Test Voltage:	AC 120V/60HZ		
Test Mode:	TX 802.11N(HT20) Mode		
Channel Frequency (MHz)	Power Density (dBm/3 kHz)	Limit (dBm/3kHz)	
2412	-18.246	8	
2437	-17.393		
2462	-17.526		

802.11N(HT20) Mode

2412 MHz

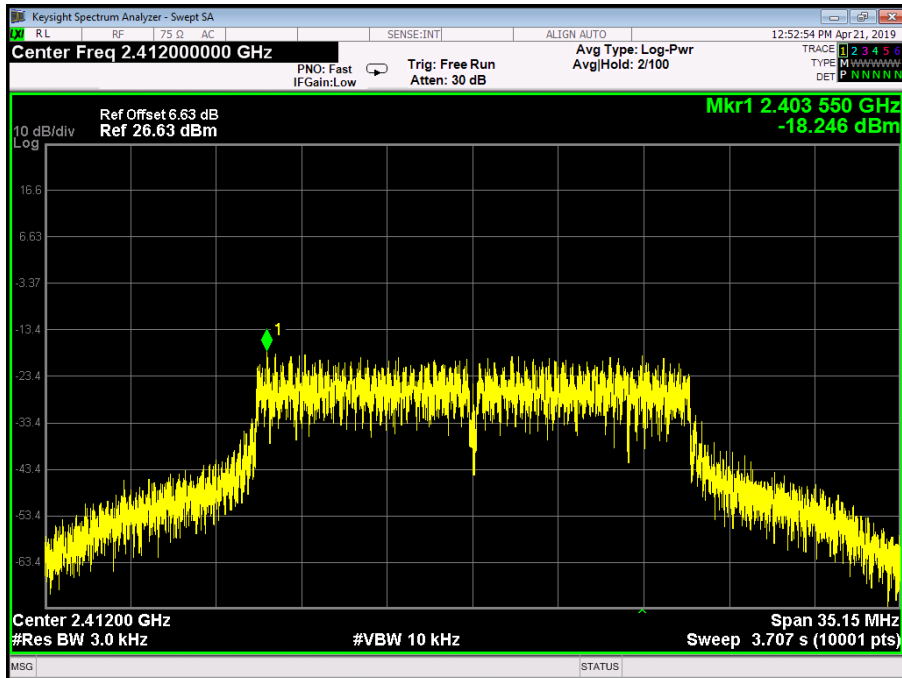

**802.11N(HT20) Mode
2437 MHz**

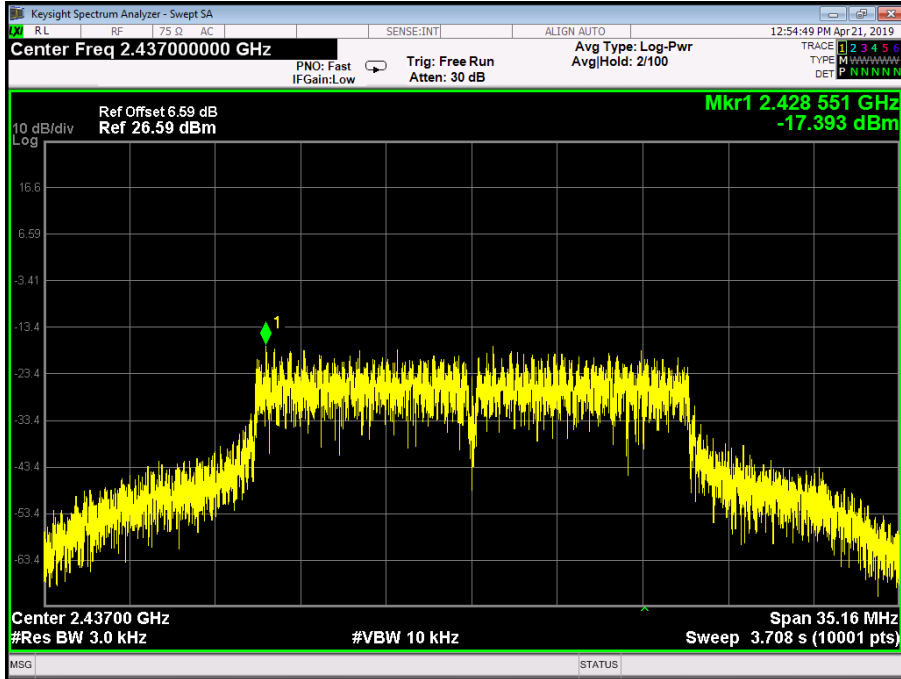

**802.11N(HT20) Mode
2462 MHz**

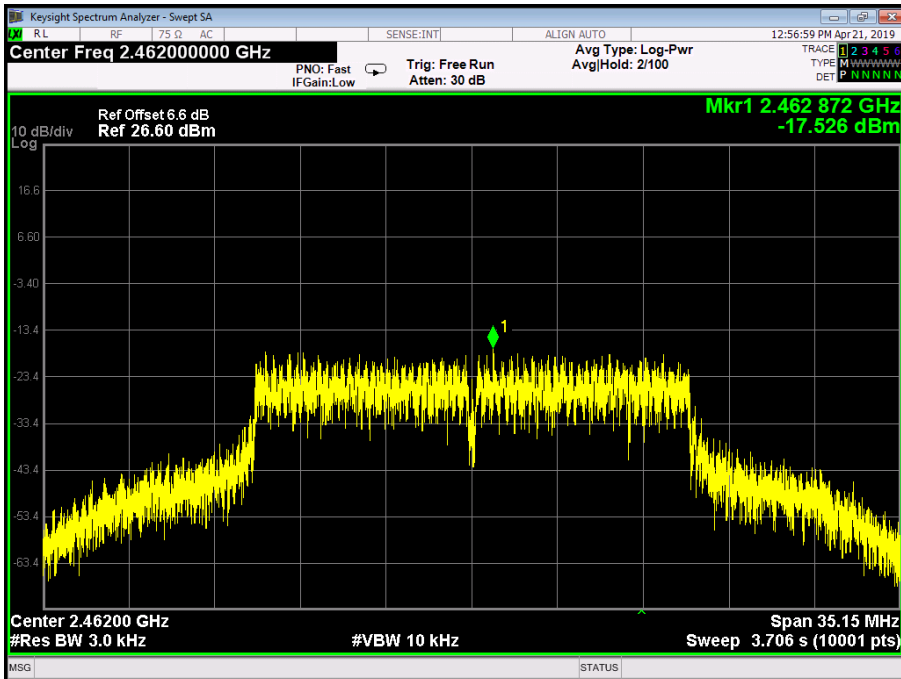

-----END OF REPORT-----