



FCC LISTED, REGISTRATION
 NUMBER: 2764.01

ISED LISTED REGISTRATION
 NUMBER: 23595-1

Test report No:
 2416ERM.005

Test report

REFERENCE STANDARD: USA FCC Part 90

Identification of item tested	Cat1 Module Supporting B2/B5/B12/B25/B26
Trademark	Sequans Communications
Model and /or type reference	SP150Q
Other identification of the product	FCC ID: 2AAGMSP150Q IMEI TAC:35199610
Features	<p>Sequans SP150Q module includes Calliope Category 1 baseband, a complete triple band RF front end, memory and required circuitry to meet 3GPP E-UTRA (Long Term Evolution - LTE, Release 10 set of specifications).</p> <ul style="list-style-type: none"> - Operates on LTE bands 25, 26, 2, 5, 12 - Ultra-small 22.5 x 22.5 x 1.5 mm LGA module - Single or dual antenna - Based on Sequans' Calliope LTE Cat 1 platform 3GPP Release 10; software-upgradable to Release 11 - PTCRB compliant - Category 1 throughput (10Mbps DL/ 5 Mbps UL) - Multi-band FDD and TDD capable - Embedded IMS clients
Manufacturer	Sequans Communications S.A. 15-55 Boulevard Charles de Gaulle, Colombes, 92700, France.
Test method requested, standard	USA FCC Part 90 Measurement Guidance 971168 D01 v02r02 for certification of Licensed Digital Transmitters. ANSI C63.26 – 2015.
Summary	IN COMPLIANCE
Approved by (name / position & signature)	Domingo Galvez EMC&RF Lab Manager
Date of issue	03-25-2019
Report template No	FDT08_21

Index

Competences and guarantees	3
General conditions	3
Uncertainty	3
Data provided by the client.....	4
Usage of samples	4
Test sample description	5
Identification of the client.....	5
Testing period and place.....	6
Document history	6
Environmental conditions	7
Remarks and comments	8
Testing verdicts.....	8
Summary	8
List of equipment used during the test.....	9
Appendix A: Test Results for FCC Part 90	10

Competences and guarantees

DEKRA Certification Inc. is a testing laboratory accredited by A2LA (The American Association for Laboratory Accreditation), to perform the tests indicated in the Certificate 2764.01.

DEKRA Certification Inc. is a testing laboratory competent to carry out the tests described in this report.

In order to assure the traceability to other national and international laboratories, DEKRA Certification Inc. has a calibration and maintenance program for its measurement equipment.

DEKRA Certification Inc. guarantees the reliability of the data presented in this report, which is the result of the measurements and the tests performed to the item under test on the date and under the conditions stated on the report and, it is based on the knowledge and technical facilities available at DEKRA Certification at the time of performance of the test.

DEKRA Certification Inc. is liable to the client for the maintenance of the confidentiality of all information related to the item under test and the results of the test.

The results presented in this Test Report apply only to the particular item under test established in this document.

IMPORTANT: No parts of this report may be reproduced or quoted out of context, in any form or by any means, except in full, without the previous written permission of DEKRA Certification Inc.

General conditions

1. This report is only referred to the item that has undergone the test.
2. This report does not constitute or imply on its own an approval of the product by the Certification Bodies or competent Authorities.
3. This document is only valid if complete; no partial reproduction can be made without previous written permission of DEKRA Certification Inc.
4. This test report cannot be used partially or in full for publicity and/or promotional purposes without previous written permission of DEKRA Certification Inc. and the Accreditation Bodies.

Uncertainty

Uncertainty (factor $k=2$) was calculated according to the DEKRA Certification internal document PODT000.

Frequency (MHz)	U(k=2)	Units
30-180	3.82	dB
180-1000	2.61	dB
1000-18000	2.92	dB
18000-40000	2.15	dB

Data provided by the client

The SP150Q is a complete LTE module including base-band, RF and memory, for the design of connected consumer electronics devices, tablet and laptop computers, machine-to-machine devices, and other devices with embedded LTE connectivity. SP150Q is based on Sequans' Calliope platform.

DEKRA declines any responsibility with respect to the information provided by the client and that may affect the validity of results.

Usage of samples

Samples undergoing test have been selected by: The client.

Sample S/01 is composed of the following elements:

Control N°	Description	Model	Serial N°	Date of reception
2416.02	Sequans SP150Q	SP150Q	IMEI:351996100001464	02/19/2019
2416.04	Radial isotropic Antenna	OmniLogo 90200	1868A-A38927180014	02/19/2019
2416.05	Radial isotropic Antenna	OmniLogo 90200	1RR0100174TLB	02/19/2019
2416.08	USB cable	C15332	-	02/19/2019

1. Sample S/01 has undergone following test(s):

All conducted and radiated tests indicated in appendix A.

Test sample description

Ports..... :	Port name and description		Cable				
			Specified length [m]	Attached during test		Shielded	
	USB		2	<input checked="" type="checkbox"/>		<input type="checkbox"/>	
	UART0			<input type="checkbox"/>		<input type="checkbox"/>	
	UART2			<input type="checkbox"/>		<input type="checkbox"/>	
	UART3			<input type="checkbox"/>		<input type="checkbox"/>	
	PWR			<input type="checkbox"/>		<input type="checkbox"/>	
	SIM			<input type="checkbox"/>		<input type="checkbox"/>	
Supplementary information to the ports..... :	Insert 1 SIM card in one of SIM -2FF or SIM-3FF holder. Do not insert SIM in both SIM-2FF and SIM-3FF at the same time						
Rated power supply	Voltage and Frequency			Reference poles			
				L1	L2	L3	N
	<input type="checkbox"/>	AC: 230Vac / 50Hz.	<input type="checkbox"/>	<input type="checkbox"/>	<input type="checkbox"/>	<input type="checkbox"/>	<input type="checkbox"/>
	<input type="checkbox"/>	AC:	<input type="checkbox"/>	<input type="checkbox"/>	<input type="checkbox"/>	<input type="checkbox"/>	<input type="checkbox"/>
	<input checked="" type="checkbox"/>	DC: 5V from USB 2.0 port					
Rated Power	5V from USB 2.0 port						
Clock frequencies	USB 2.0						
Other parameters..... :	No Data provided						
Software version	4.3.4.3						
Hardware version..... :	SP150 EVT1						
Dimensions in cm (L x W x D) :	17 x 24 mm						
Mounting position..... :	<input checked="" type="checkbox"/>	Table top equipment					
	<input type="checkbox"/>	Wall/Ceiling mounted equipment					
	<input type="checkbox"/>	Floor standing equipment					
	<input type="checkbox"/>	Hand-held equipment					
	<input type="checkbox"/>	Other:					
Modules/parts	Module/parts of test item			Type		Manufacturer	
	HWPT-003-B			interface board		Sequans	
Accessories (not part of the test item)	Description		Type			Manufacturer	
	USB wire		cable				
	OmniLOG 90200		antenna			Omnilog	
Documents as provided by the applicant..... :	Description		File name			Issue date	
	Equipment declaration data		FDT30_14 Declaration Equipment Data			2018/12/28	

Copy of marking plate:



Identification of the client

Sequans Communications S.A.
15-55 Boulevard Charles de Gaulle, Colombes, 92700, France

Testing period and place

Test Location	DEKRA Certification, Inc.
Date (start)	02-21-2019
Date (finish)	03-11-2019

Document history

Report number	Date	Description
2416ERM.005	03-25-2019	First release

Environmental conditions

In the control chamber, the following limits were not exceeded during the test:

Temperature	Min. = 15 °C Max. = 35 °C
Relative humidity	Min. = 30 % Max. = 75 %
Air pressure	Min. = 860 mbar Max. = 1060 mbar

In the semi anechoic chamber, the following limits were not exceeded during the test.

Temperature	Min. = 15 °C Max. = 35 °C
Relative humidity	Min. = 30 % Max. = 75 %
Air pressure	Min. = 860 mbar Max. = 1060 mbar

In the chamber for conducted measurements, the following limits were not exceeded during the test:

Temperature	Min. = 15 °C Max. = 35 °C
Relative humidity	Min. = 30 % Max. = 60 %
Air pressure	Min. = 860 mbar Max. = 1060 mbar

Remarks and comments

The tests have been performed by the technical personnel: Sravani Gollamudi and Koji Nishimoto.

Testing verdicts

Not applicable :	N/A
Pass :	P
Fail :	F
Not measured :	N/M

Summary

FCC PART 90/ PARAGRAPH				
Report Section	Part 90 Spec Clause	Test Description	Verdict	Remark
A.1	§2.1046 and § 90.635 (b)	RF Output power	P	N/A
A.2	§2.1055 and § 90.213	Frequency stability	P	N/A
A.3	§ 2.1049 and § 90.209(7)	Occupied Bandwidth	P	N/A
A.4	§2.1051 and §90.691	Spurious emissions at antenna terminals	P	N/A
A.5	§90.691	Spurious emissions at antenna terminals at Block edges	P	N/A
A.6	§2.1051 and §90.691	Radiated emissions	P	N/A
<u>Supplementary information and remarks:</u>				
N/A				

List of equipment used during the test

Conducted Measurements

CONTROL NUMBER	DESCRIPTION	LAST CALIBRATION	NEXT CALIBRATION
1014	Signal analyzer Rohde & Schwarz FSV40	2017/03	2019/03
1149	Wideband Radio Communication Tester Rohde & Schwarz CMW 500	2018/07	2020/07
1041	EMI Test Receiver Rohde & Schwarz ESR 7	2017/04	2019/03
101	Climatic chamber Espec	2019/10	2020/10

Radiated Measurements

CONTROL NUMBER	DESCRIPTION	LAST CALIBRATION	NEXT CALIBRATION
1179	Semi anechoic Absorber Lined Chamber Frankonia SAC 3 plus "L"	N/A	N/A
1065	BiconicalLog antenna ETS LINDGREN 3142E	2017/03	2020/03
1058	Double-ridge Waveguide Horn antenna 1-18 GHz	2017/03	2020/03
1059	Double-ridge Waveguide Horn antenna 18- 40 GHz	2017/03	2020/03
1014	Spectrum analyzer Rohde & Schwarz FSV40	2017/03	2019/03
0980	RF pre-amplifier 30 MHz-6 GHz Bonn Elektronik BLMA 0360-01N	2017/05	2019/05
0981	RF pre-amplifier 1-18 GHz Bonn Elektronik BLMA 0118-2A	2018/10	2020/10
1015,1017, 1019, 1020	Rohde & Schwarz EMC32 software	N/A	N/A

Appendix A: Test Results for FCC Part 90

Appendix A Content

PRODUCT INFORMATION	12
DESCRIPTION OF TEST CONDITIONS	13
TEST A.1: RF OUTPUT POWER.....	14
TEST A.2: FREQUENCY STABILITY	31
TEST A.3: OCCUPIED BANDWIDTH	33
TEST A.4: SPURIOUS EMISSIONS AT ANTENNA TERMINALS.....	58
TEST A.5: SPURIOUS EMISSIONS AT ANTENNA TERMINALS AT BLOCK EDGES	66
TEST A.6: RADIATED EMISSIONS.....	78

PRODUCT INFORMATION

The following information is provided by the client

Information	Description
Modulation	QPSK, QAM
Maximum RF Output Power	23 dBm
Operation mode:	
- Operating Frequency Range	Band 26: 814-824 MHz
- Nominal Channel Bandwidth	Band 26: 1.4 / 3 / 5 / 10 / 15 MHz
Extreme operating conditions	
- Temperature range	T _{nom} = +15 to + 35 T _{min} = -30 T _{max} = +50
Antenna type	Radial Isotropic
Antenna gain	0 dBi
Nominal Voltage	
- Supply Voltage	5 Vdc
- Type of power source	USB 2.0 port
Equipment type	LTE module CAT1

DESCRIPTION OF TEST CONDITIONS

The worst case was found when positioned as the table below. Following channel(s) was (were) selected for the final test as listed below:

TEST CONDITIONS	DESCRIPTION										
<p>TC#01 LTE Band 26</p>	<p><u>Power supply (V):</u> $V_{nominal} = 5 \text{ Vdc}$</p> <p><u>Test Frequencies for Conducted tests:</u></p> <p><u>1.4 MHz Bandwidth:</u> -Lowest Channel: 26697(814.7 MHz) -Middle Channel: 26740(819 MHz) -Highest Channel: 26783(823.3 MHz)</p> <p><u>3 MHz Bandwidth:</u> -Lowest Channel: 26705(815.5 MHz) -Middle Channel: 26740(819 MHz) -Highest Channel: 26775(822.5 MHz)</p> <p><u>5 MHz Bandwidth:</u> -Lowest Channel: 26715(816.5 MHz) -Middle Channel: 26740(819 MHz) -Highest Channel: 26765(821.5 MHz)</p> <p><u>10 MHz Bandwidth:</u> - Channel: 26740(819 MHz)</p> <p><u>15 MHz Bandwidth:</u> - Channel: 26765(821.5 MHz)</p> <p><u>Test Frequencies for Radiated tests:</u></p> <table border="1" data-bbox="451 1644 1308 1835"> <thead> <tr> <th>Available Frequencies</th> <th>Tested Frequency</th> <th>Channel Bandwidth</th> <th>Modulation</th> <th>Mode</th> </tr> </thead> <tbody> <tr> <td>814 to 824 MHz</td> <td>816.5 MHz 819 MHz 822.5 MHz</td> <td>5 MHz</td> <td>QPSK</td> <td>1 RB</td> </tr> </tbody> </table> <p>Note: This device was tested under all bandwidths, RB configurations and modulations. The worst case found in QPSK modulation.</p>	Available Frequencies	Tested Frequency	Channel Bandwidth	Modulation	Mode	814 to 824 MHz	816.5 MHz 819 MHz 822.5 MHz	5 MHz	QPSK	1 RB
Available Frequencies	Tested Frequency	Channel Bandwidth	Modulation	Mode							
814 to 824 MHz	816.5 MHz 819 MHz 822.5 MHz	5 MHz	QPSK	1 RB							

TEST A.1: RF OUTPUT POWER

LIMITS:	Product standard:	FCC Part 90
	Test standard:	FCC §2.1046 and §90.635 (b).

LIMITS

The ERP of mobile transmitters and auxiliary test transmitters must not exceed 2 Watts.

The peak-to-average ratio (PAR) of the transmission shall not exceed 13 dB.

TEST SETUP

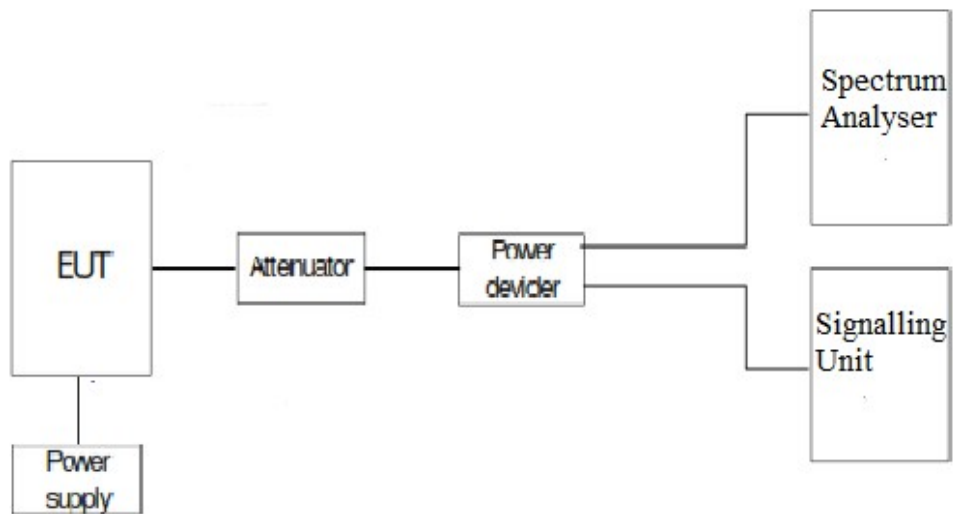

TESTED SAMPLES:	S/01
TESTED CONDITIONS MODES:	TC#01
TEST RESULTS:	PASS

LTE QPSK AND 16QAM MODULATION. Bandwidth = 1.4 MHz

Channel	Average power at antenna port (dBm)	Maximum declared antenna gain (dBi)	Maximum E.I.R.P. average power (dBm)	PAPR (dB)
Lowest	21.93	0.0	21.93	7.25
Middle	21.27	0.0	21.27	6.67
Highest	20.67	0.0	20.67	6.81

LTE QPSK AND 16QAM MODULATION. Bandwidth = 3 MHz

Channel	Average power at antenna port (dBm)	Maximum declared antenna gain (dBi)	Maximum E.I.R.P. average power (dBm)	PAPR (dB)
Lowest	21.75	0.0	21.75	6.61
Middle	21.02	0.0	21.02	7.07
Highest	20.74	0.0	20.74	7.16

LTE QPSK AND 16QAM MODULATION. Bandwidth = 5 MHz

Channel	Average power at antenna port (dBm)	Maximum declared antenna gain (dBi)	Maximum E.I.R.P. average power (dBm)	PAPR (dB)
Lowest	22.06	0.0	22.06	6.43
Middle	21.67	0.0	21.67	7.01
Highest	20.88	0.0	20.88	6.67

LTE QPSK AND 16QAM MODULATION. Bandwidth = 10 MHz

Channel	Average power at antenna port (dBm)	Maximum declared antenna gain (dBi)	Maximum E.I.R.P. average power (dBm)	PAPR (dB)
Single	22.06	0.0	22.06	6.81

LTE QPSK AND 16QAM MODULATION. Bandwidth = 15 MHz

Channel	Average power at antenna port (dBm)	Maximum declared antenna gain (dBi)	Maximum E.I.R.P. average power (dBm)	PAPR (dB)
Single	21.11	0.0	21.11	6.84
Measurement uncertainty (dB)			<±0.95	

TEST RESULTS (Cont):

Bandwidth (MHz)	Channel Location Frequency (MHz) Channel Number	Modulation	Resource Block Size	Resource Block Offset	Average power at antenna port (dBm)	PAPR (dB)
1.4	Lowest (26697 (814.7 MHz))	QPSK	1	0	21.93	5.71
			1	5	21.77	
			3	0	21.71	
			3	2	21.7	
			6	0	20.78	
		16-QAM	1	0	20.89	7.25
			1	5	20.83	
			3	0	20.69	
			3	2	20.64	
			6	0	19.71	
	Middle (26740 (819 MHz))	QPSK	1	0	21.27	5.91
			1	5	21.15	
			3	0	21.17	
			3	2	21.12	
			6	0	20.24	
		16-QAM	1	0	20.4	6.67
			1	5	20.26	
			3	0	20.24	
			3	2	20.21	
			6	0	19.3	
	Highest (26783 (823.3 MHz))	QPSK	1	0	20.67	5.94
			1	5	20.5	
			3	0	20.52	
			3	2	20.45	
6			0	19.53		
16-QAM		1	0	19.71	6.81	
		1	5	19.66		
		3	0	19.39		
		3	2	19.35		
		6	0	18.6		

TEST RESULTS (Cont):						
Bandwidth (MHz)	Channel Location Frequency (MHz) Channel Number	Modulation	Resource Block Size	Resource Block Offset	Average power at antenna port (dBm)	PAPR (dB)
3	Lowest (26705 (815.5 MHz))	QPSK	1	0	21.75	5.62
			1	14	21.38	
			8	0	20.44	
			8	7	20.33	
			15	0	20.32	
		16-QAM	1	0	20.85	6.61
			1	14	20.51	
			8	0	19.45	
			8	7	19.39	
			15	0	19.35	
	Middle (26740 (819 MHz))	QPSK	1	0	21.02	5.77
			1	14	20.97	
			8	0	20.05	
			8	7	19.93	
			15	0	19.94	
		16-QAM	1	0	20.14	7.07
			1	14	19.96	
			8	0	19.09	
			8	7	18.97	
			15	0	19.03	
Highest (26775 (822.5 MHz))	QPSK	1	0	20.74	6.20	
		1	14	20.39		
		8	0	19.54		
		8	7	19.35		
		15	0	19.41		
	16-QAM	1	0	19.81	7.16	
		1	14	19.49		
		8	0	18.64		
		8	7	18.48		
		15	0	18.43		

TEST RESULTS (Cont):						
Bandwidth (MHz)	Channel Location Frequency (MHz) Channel Number	Modulation	Resource Block Size	Resource Block Offset	Average power at antenna port (dBm)	PAPR (dB)
5	Lowest (26715 (816.5 MHz))	QPSK	1	0	22.06	5.86
			1	24	21.37	
			12	0	20.52	
			12	11	20.28	
			25	0	20.31	
		16-QAM	1	0	21.1	6.43
			1	24	20.55	
			12	0	19.49	
			12	11	19.27	
			25	0	21.03	
	Middle (26740 (819 MHz))	QPSK	1	0	21.67	5.83
			1	24	20.97	
			12	0	20.1	
			12	11	19.92	
			25	0	20.01	
		16-QAM	1	0	20.72	7.01
			1	24	20.08	
			12	0	19.12	
			12	11	18.98	
			25	0	20.95	
Highest (26765 (821.5 MHz))	QPSK	1	0	20.88	5.88	
		1	24	19.78		
		12	0	19.59		
		12	11	19.44		
		25	0	19.6		
	16-QAM	1	0	20.06	6.67	
		1	24	19.55		
		12	0	18.84		
		12	11	18.51		
		25	0	20.48		

TEST RESULTS (Cont):

Bandwidth (MHz)	Channel Location Frequency (MHz) Channel Number	Modulation	Resource Block Size	Resource Block Offset	Average power at antenna port (dBm)	PAPR (dB)
10	26740 (819 MHz)	QPSK	1	0	22.06	5.68
			1	49	20.04	
			25	0	19.94	
			25	24	19.66	
			50	0	19.69	
		16-QAM	1	0	20.97	6.81
			1	26	19.83	
			27	0	19.98	

Bandwidth (MHz)	Channel Location Frequency (MHz) Channel Number	Modulation	Resource Block Size	Resource Block Offset	Average power at antenna port (dBm)	PAPR (dB)
15	26765 (821.5 MHz)	QPSK	1	0	21.11	5.74
			1	74	20.03	
			36	0	19.61	
			36	37	19.04	
			75	0	20.66	
		16-QAM	1	0	20.11	6.84
			1	26	19.59	
			27	0	19.57	

TEST RESULTS (Cont):

PAPR
 Bandwidth = 1.4 MHz. Modulation QPSK. RB Size: 1. RB Offset: 0.
 Lowest channel

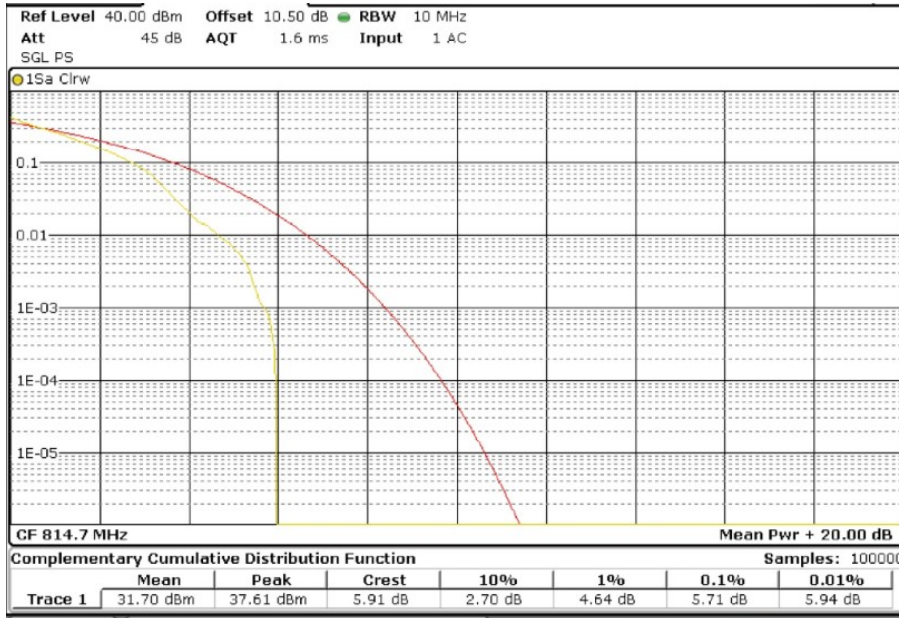

Middle channel

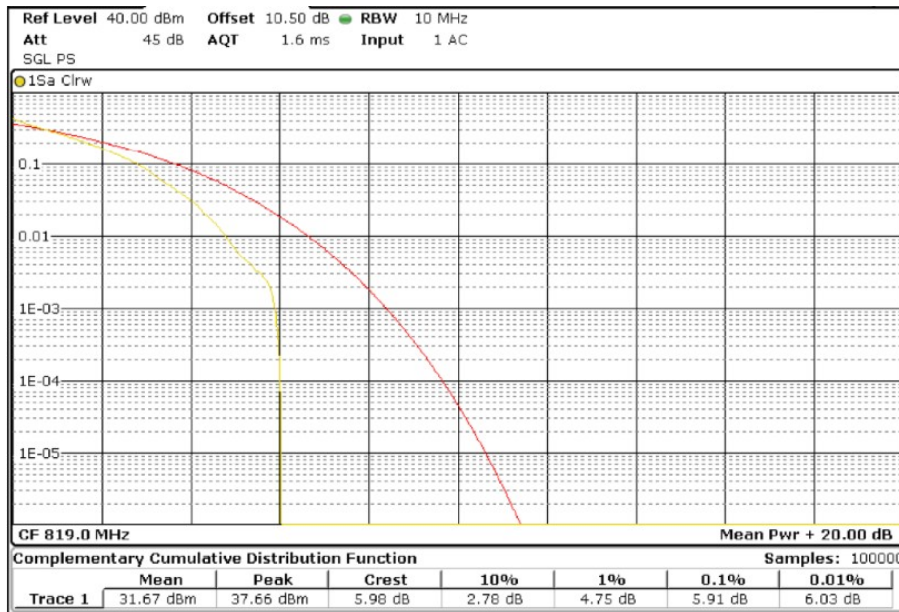

TEST RESULTS (Cont):

Highest channel

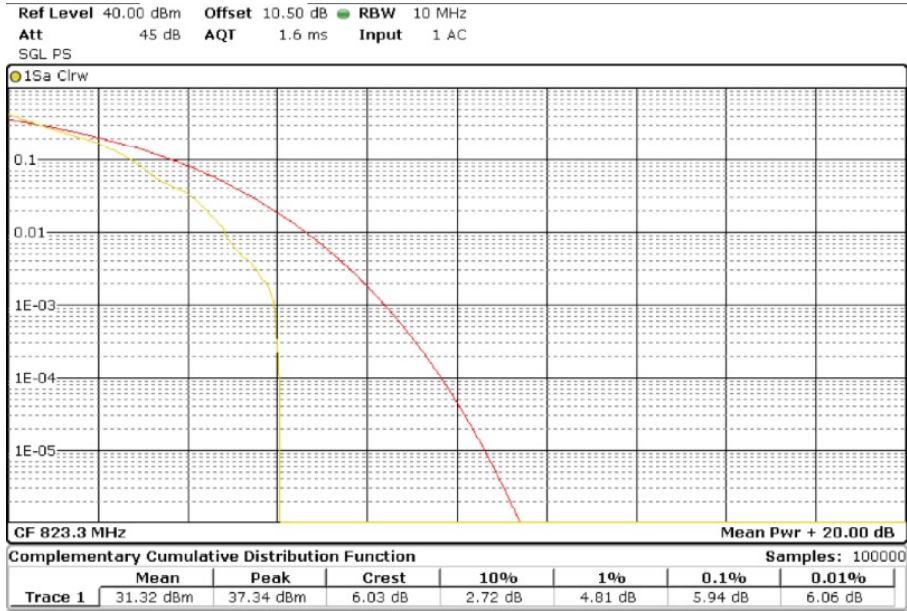

PAPR

Bandwidth = 1.4 MHz. Modulation 16QAM. RB Size: 1. RB Offset: 0.

Lowest channel

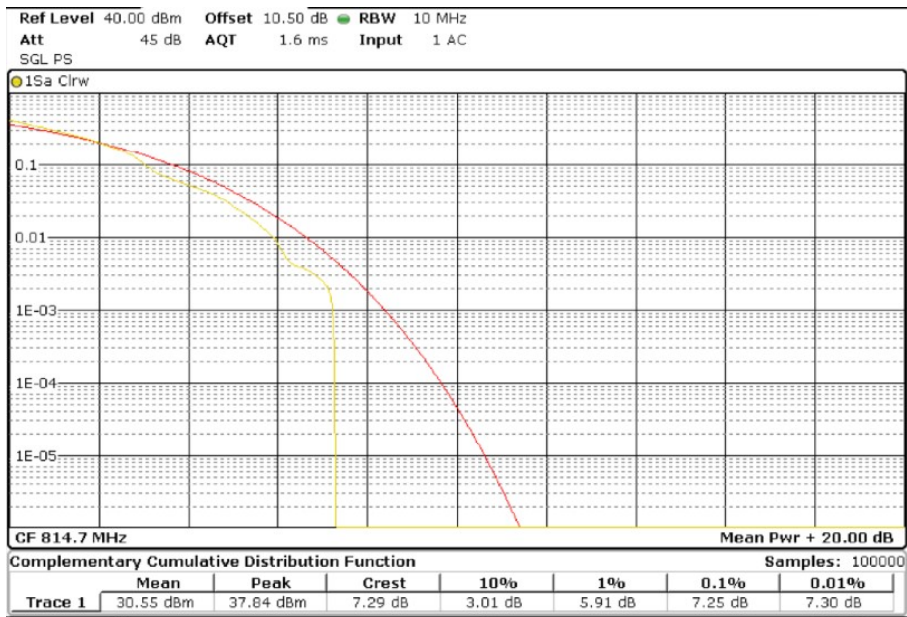

TEST RESULTS (Cont):

Middle channel

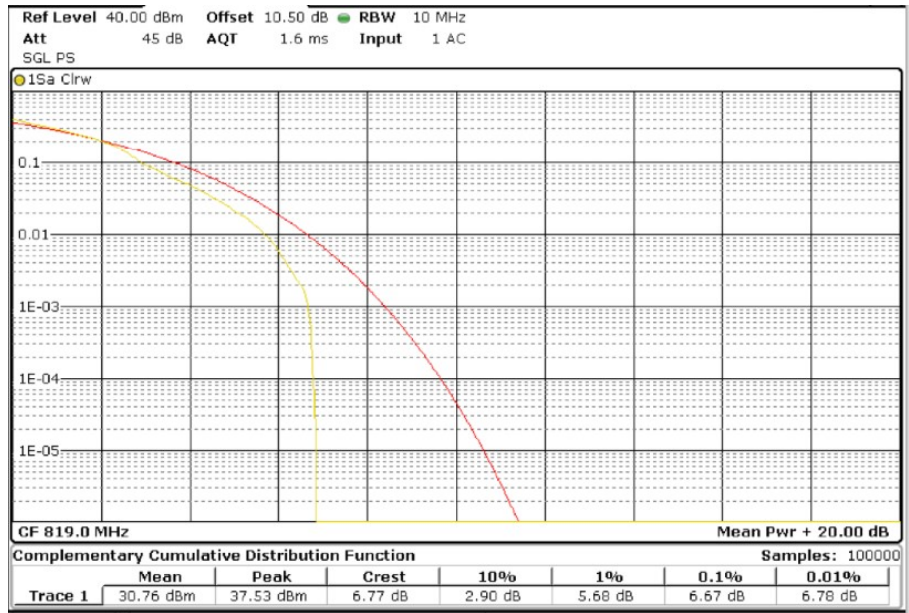

Highest channel

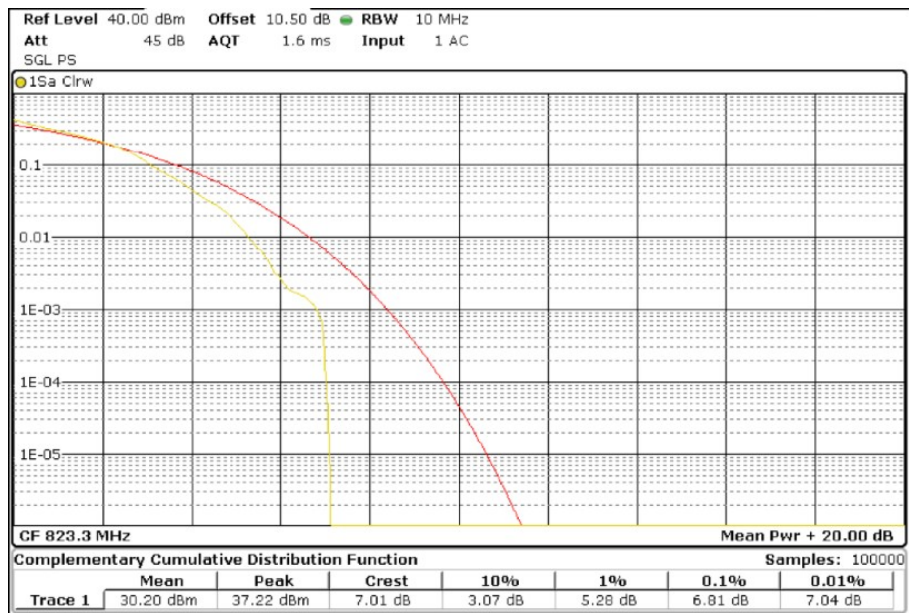

TEST RESULTS (Cont):

PAPR
 Bandwidth = 3 MHz. Modulation QPSK. RB Size: 1. RB Offset: 0.
 Lowest channel

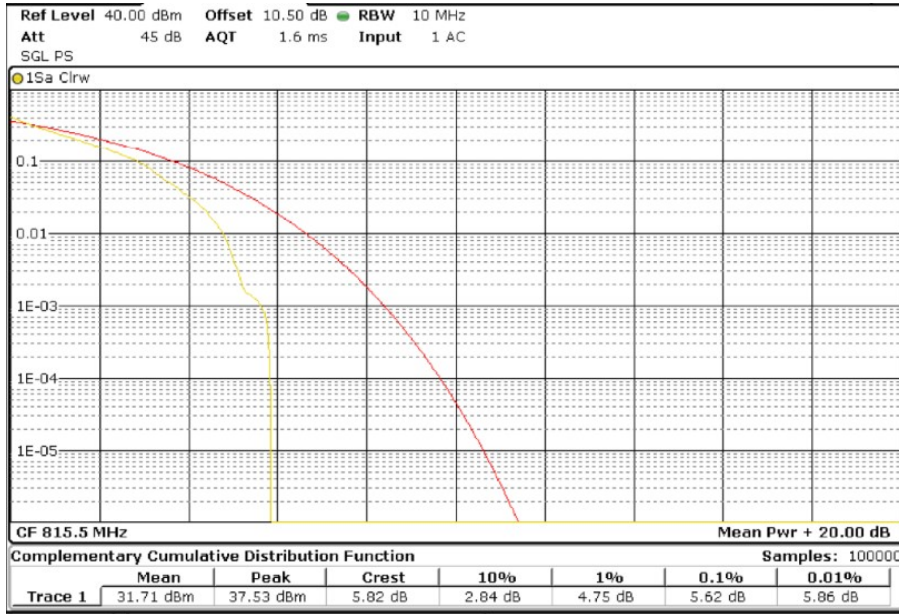

Middle channel

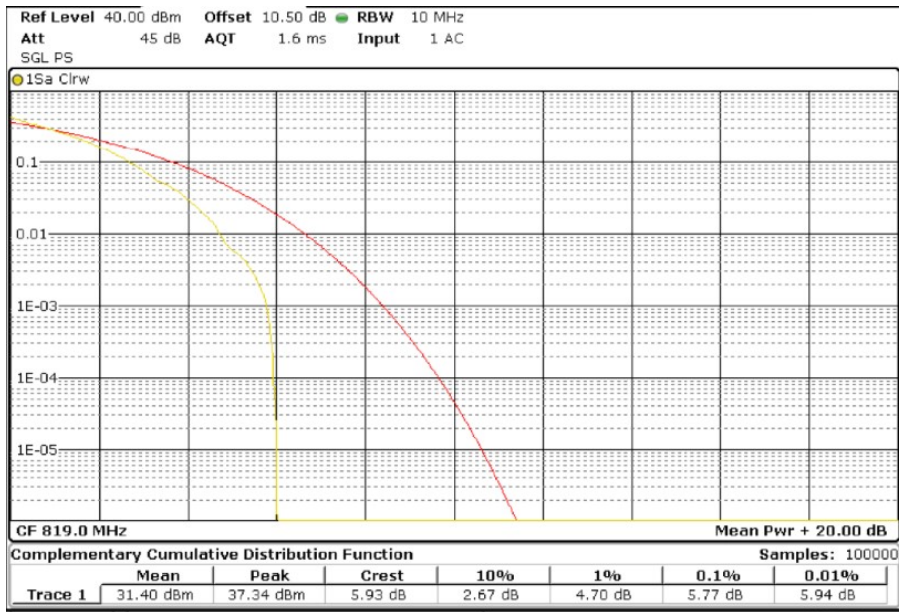

TEST RESULTS (Cont):

Highest channel

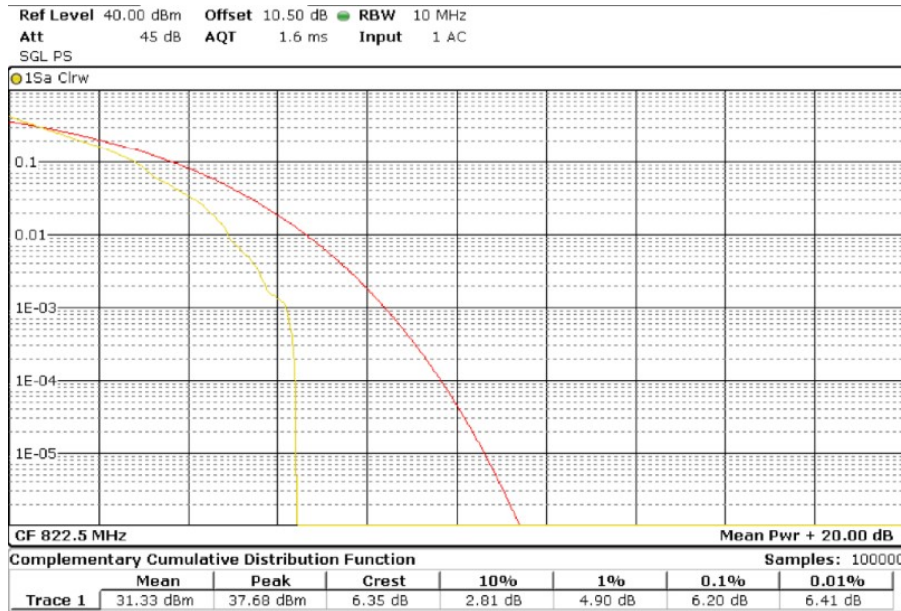

PAPR

Bandwidth = 3 MHz. Modulation 16QAM. RB Size: 1. RB Offset: 0.

Lowest channel

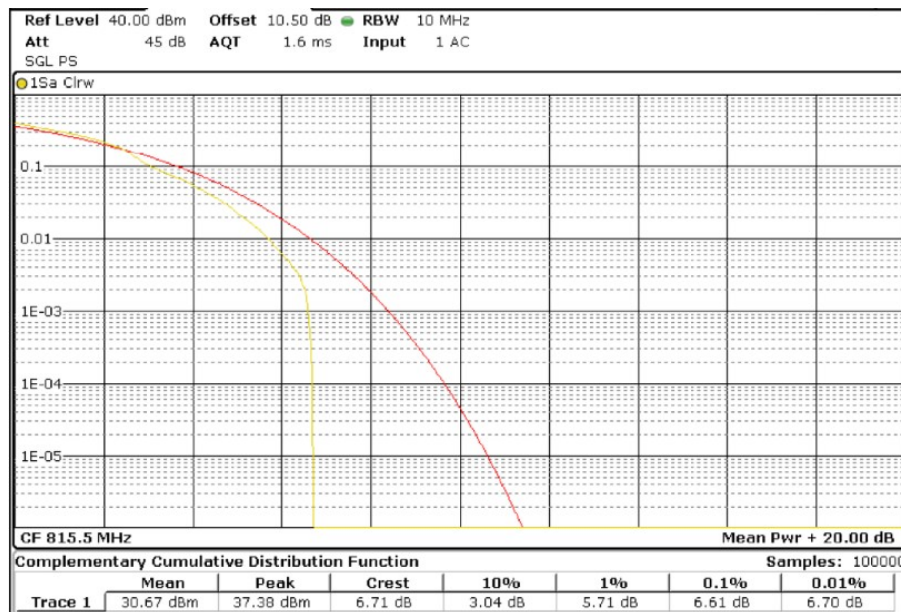

TEST RESULTS (Cont):

Middle channel

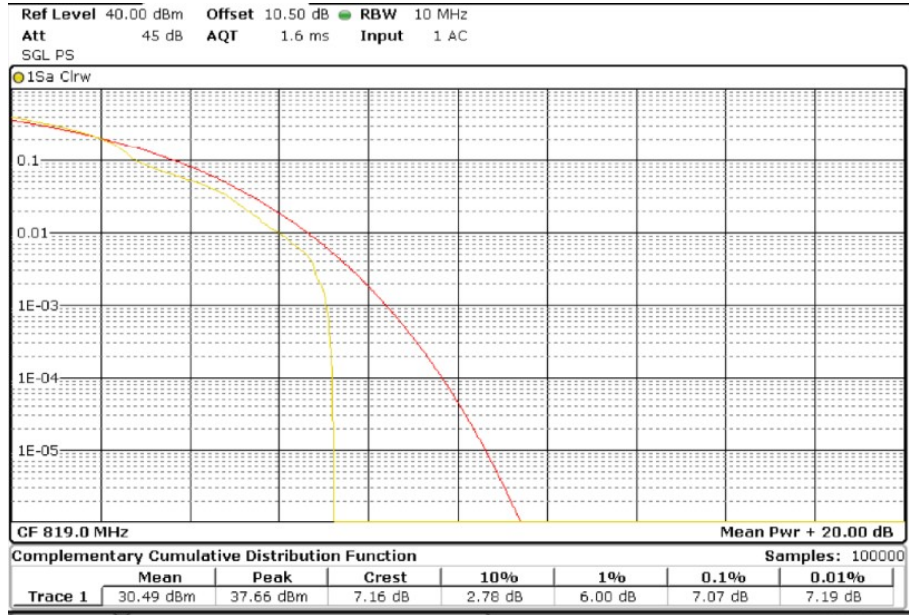

Highest channel



TEST RESULTS (Cont):

PAPR
 Bandwidth = 5 MHz. Modulation QPSK. RB Size: 1. RB Offset: 0.
 Lowest channel

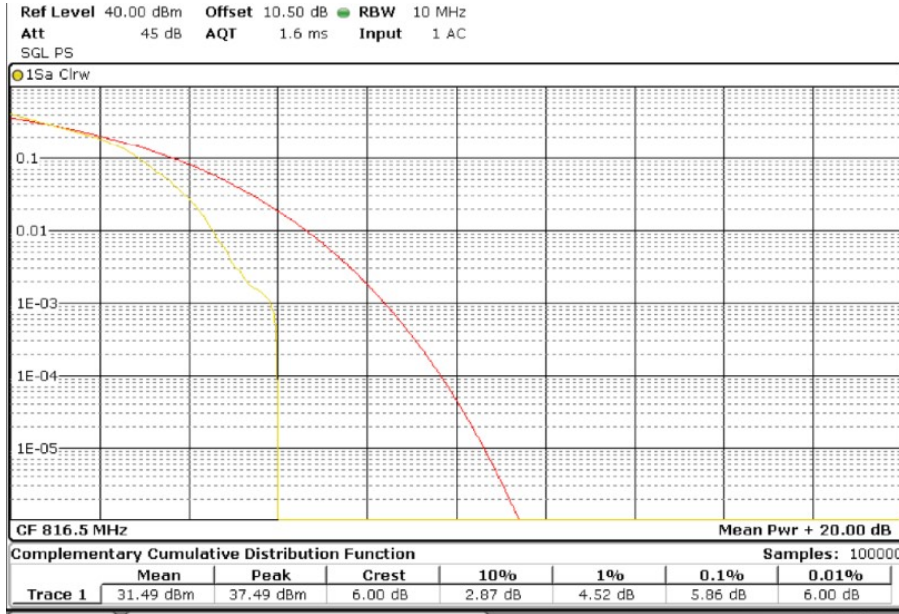

Middle channel

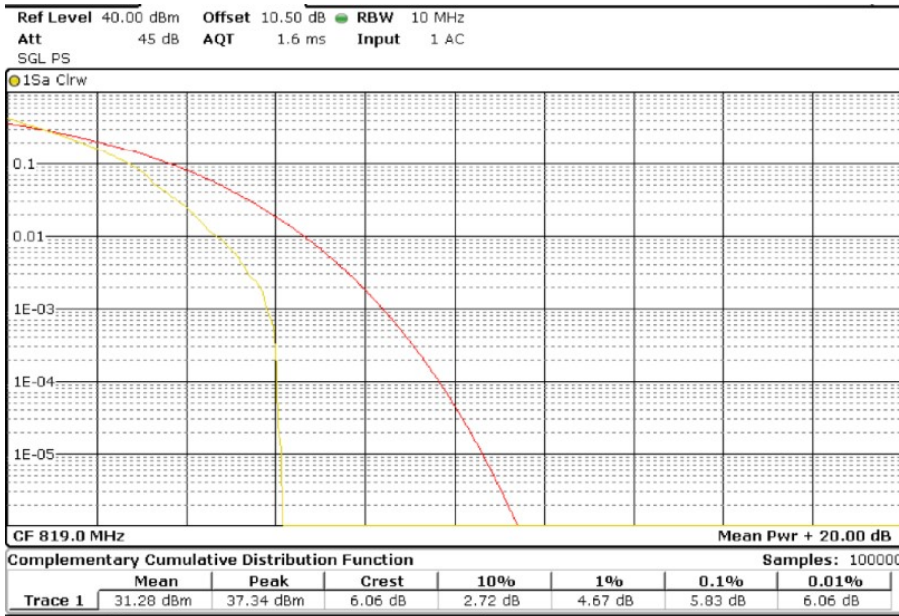

TEST RESULTS (Cont):

Highest channel

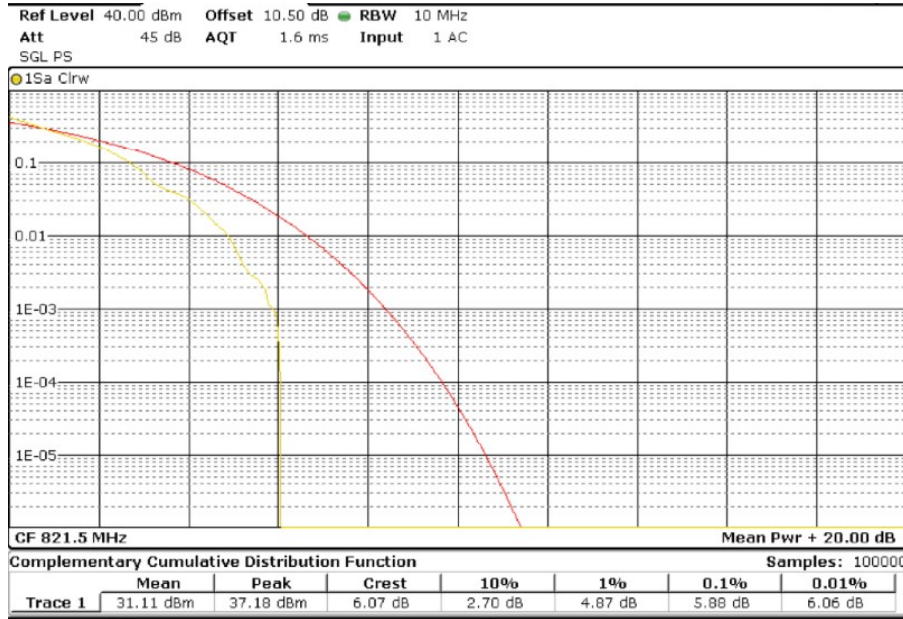

Bandwidth = 5 MHz. Modulation 16QAM. RB Size: 1. RB Offset: 0.
 Lowest channel

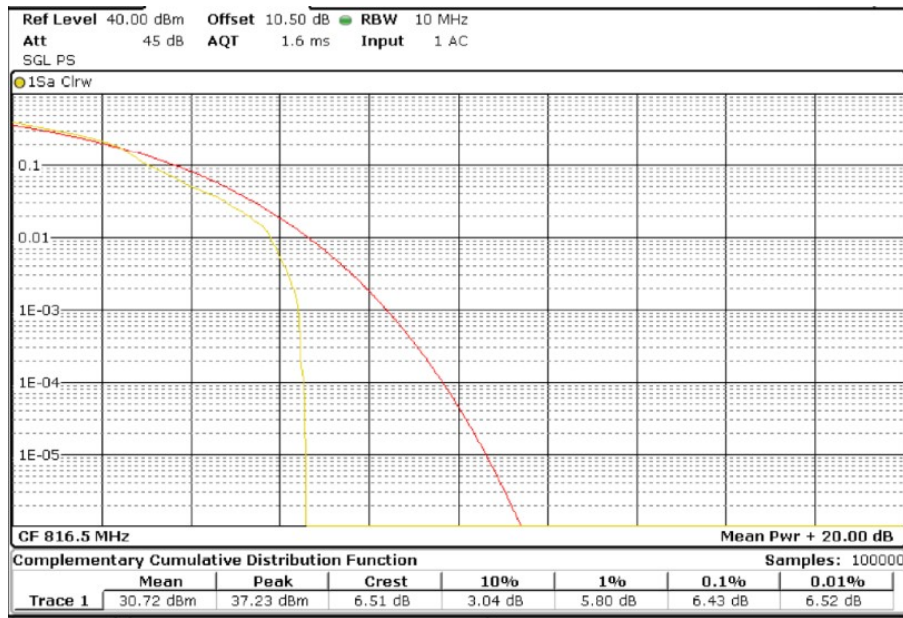

TEST RESULTS (Cont):

Middle channel

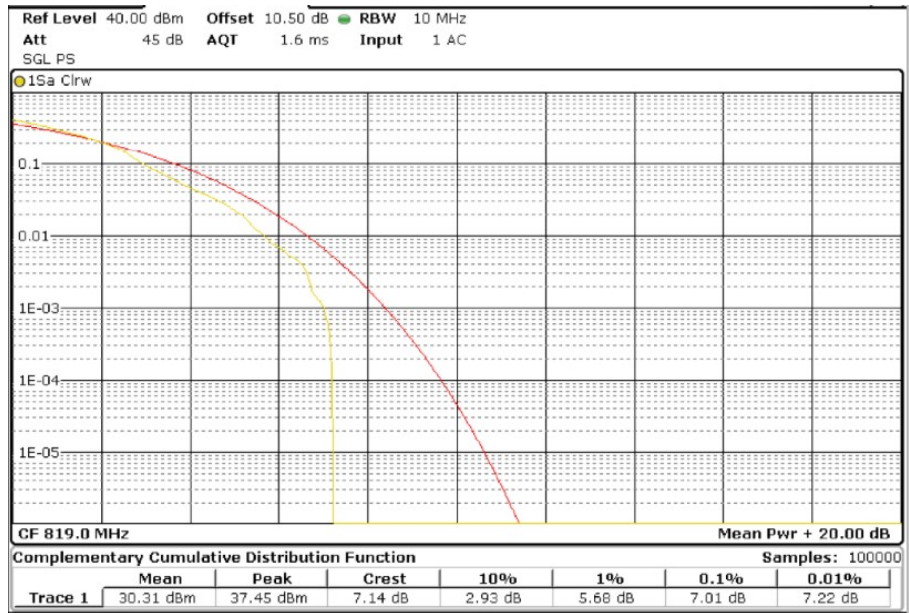

Highest channel

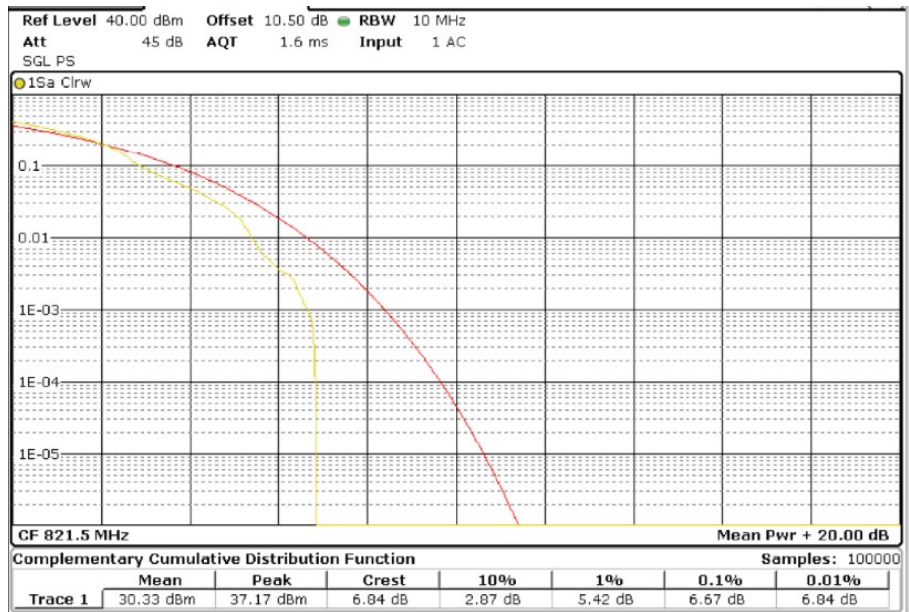

TEST RESULTS (Cont):

Bandwidth = 10 MHz. Modulation QPSK. RB Size: 1. RB Offset: 0.

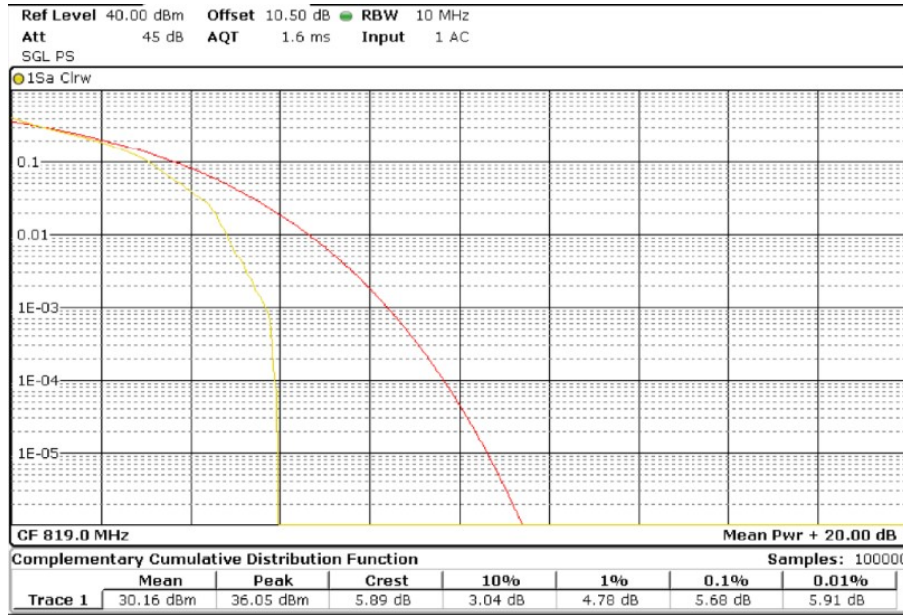

Bandwidth = 10 MHz. Modulation 16 QAM. RB Size: 1. RB Offset: 0.

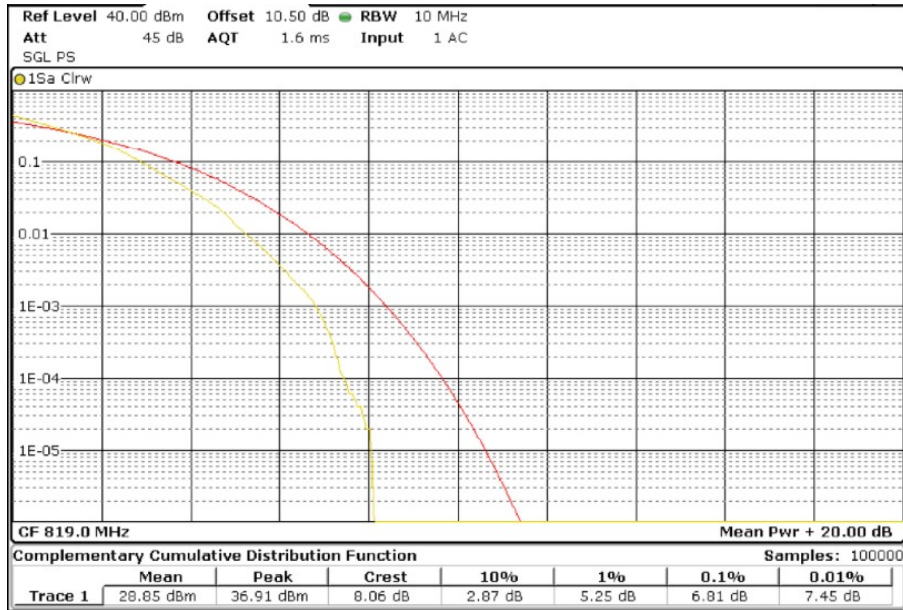

TEST RESULTS (Cont):

PAPR
 Bandwidth = 15 MHz. Modulation QPSK. RB Size: 1. RB Offset: 0.



Bandwidth = 15 MHz. Modulation 16QAM. RB Size: 1. RB Offset: 0.

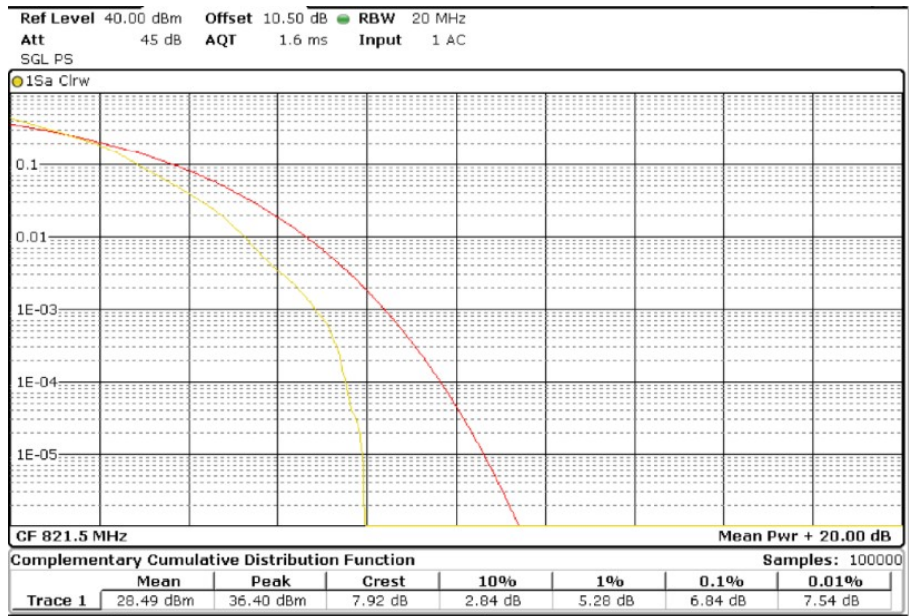

TEST A.2: FREQUENCY STABILITY

LIMITS:	Product standard:	FCC Part 90
	Test standard:	FCC §2.1055 and § 90.213

LIMITS

The frequency stability shall be enough to ensure that the fundamental emissions stay within the authorized bands of operation.

TEST SETUP

The frequency tolerance measurements over temperature variations were made over the temperature range of -30°C to +50°C. The EUT was placed inside a climatic chamber and the temperature was raised hourly in 10°C steps from -30°C up to +50°C.

The supply voltage was varied between 85% and 115% of nominal voltage.

The EUT was set in “call mode” in the middle channel using the Universal Radio Communication Tester R&S CMW500 and the maximum frequency error was measured using the built-in calibrated frequency meter.

For LTE mode the QPSK modulation was used for the test as it is the worst case for conducted power.

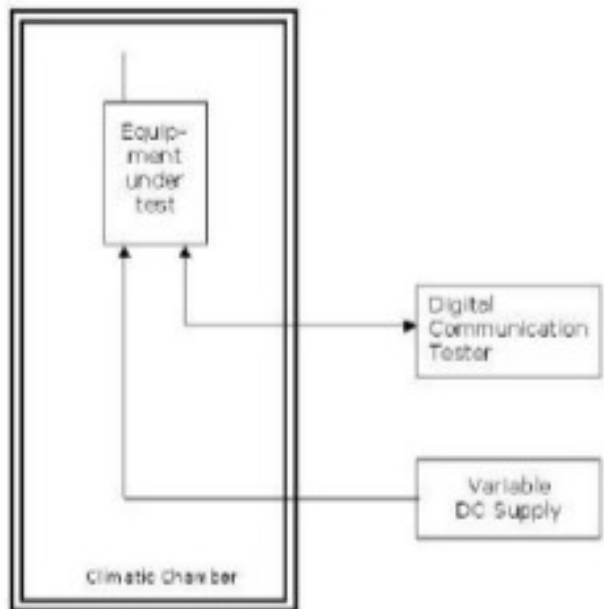

TESTED SAMPLES:	S/01
TESTED CONDITIONS MODES:	TC#01
TEST RESULTS:	PASS

LTE QPSK MODULATION. BW = 5 MHz

Frequency stability over temperature variations

Temperature (°C)	Frequency Error (Hz)	Frequency Error (ppm)	Frequency Error (%)
50	0.76	0.0009	0.00000009
40	0.37	0.0005	0.00000005
30	-0.56	-0.0007	-0.00000007
20	2.32	0.0028	0.00000028
10	-1.72	-0.0021	-0.00000021
0	-0.39	-0.0005	-0.00000005
-10	-0.36	-0.0004	-0.00000004
-20	0.29	0.0004	0.00000004
-30	-1.7	-0.0021	-0.00000021

Frequency stability over voltage variations

Battery Supply voltage	Voltage (V)	Frequency Error (Hz)	Frequency Error (ppm)	Frequency Error (%)
Vmax	4.4	0.64	0.0008	0.00000008
Vmin	3.3	-2.29	-0.0028	-0.00000028

TEST A.3: OCCUPIED BANDWIDTH

LIMITS:	Product standard:	FCC Part 90.
	Test standard:	FCC § 2.1049 and §90.209(7)

LIMITS

Reference only.

TEST SETUP

The occupied bandwidth measurement was performed at the output terminals of the EUT using an attenuator, power splitter and spectrum analyzer. The EUT was controlled via the Universal Radio Communication Tester R&S CMW500 selecting maximum transmission power of the EUT and different modes of modulation. The 99% occupied bandwidth and the -26 dBc bandwidth were measured directly using the built-in bandwidth measuring option of spectrum analyzer.

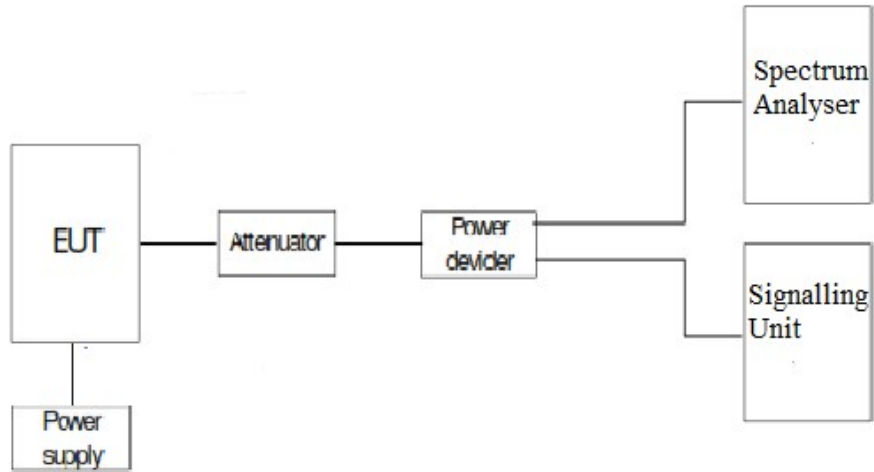

TESTED SAMPLES:	S/01
TESTED CONDITIONS MODES:	TC#01
TEST RESULTS:	PASS

LTE QPSK MODULATION. BW = 1.4 MHz

Channel	Lowest	Middle	Highest
99% Occupied bandwidth (MHz)	1.11	1.11	1.11
-26 dBc bandwidth (MHz)	1.39	1.37	1.38

LTE 16QAM MODULATION. BW = 1.4 MHz

Channel	Lowest	Middle	Highest
99% Occupied bandwidth (MHz)	1.10	1.10	1.10
-26 dBc bandwidth (MHz)	1.38	1.38	1.38

LTE QPSK MODULATION. BW = 3 MHz

Channel	Lowest	Middle	Highest
99% Occupied bandwidth (MHz)	2.81	2.82	2.82
-26 dBc bandwidth (MHz)	3.02	3.01	3.00

LTE 16QAM MODULATION. BW = 3 MHz

Channel	Lowest	Middle	Highest
99% Occupied bandwidth (MHz)	2.82	2.82	2.82
-26 dBc bandwidth (MHz)	3.00	3.00	3.01

LTE QPSK MODULATION. BW = 5 MHz

Channel	Lowest	Middle	Highest
99% Occupied bandwidth (MHz)	4.90	4.90	4.91
-26 dBc bandwidth (MHz)	5.79	5.81	5.81

TEST RESULTS (Cont):			
LTE 16QAM MODULATION. BW = 5 MHz			
Channel	Lowest	Middle	Highest
99% Occupied bandwidth (MHz)	4.90	4.90	4.90
-26 dBc bandwidth (MHz)	5.79	5.81	5.81
LTE QPSK MODULATION. BW = 10 MHz			
Channel	Single		
99% Occupied bandwidth (MHz)	9.18		
-26 dBc bandwidth (MHz)	10.30		
LTE 16QAM MODULATION. BW = 10 MHz			
Channel	Single		
99% Occupied bandwidth (MHz)	5.24		
-26 dBc bandwidth (MHz)	6.19		
LTE QPSK MODULATION. BW = 15 MHz			
Channel	Single		
99% Occupied bandwidth (MHz)	13.41		
-26 dBc bandwidth (MHz)	14.24		
LTE 16QAM MODULATION. BW = 15 MHz			
Channel	Single		
99% Occupied bandwidth (MHz)	4.95		
-26 dBc bandwidth (MHz)	5.69		

TEST RESULTS (Cont):

LTE QPSK MODULATION, BW = 1.4 MHz
 Lowest Channel 99% Occupied Bandwidth

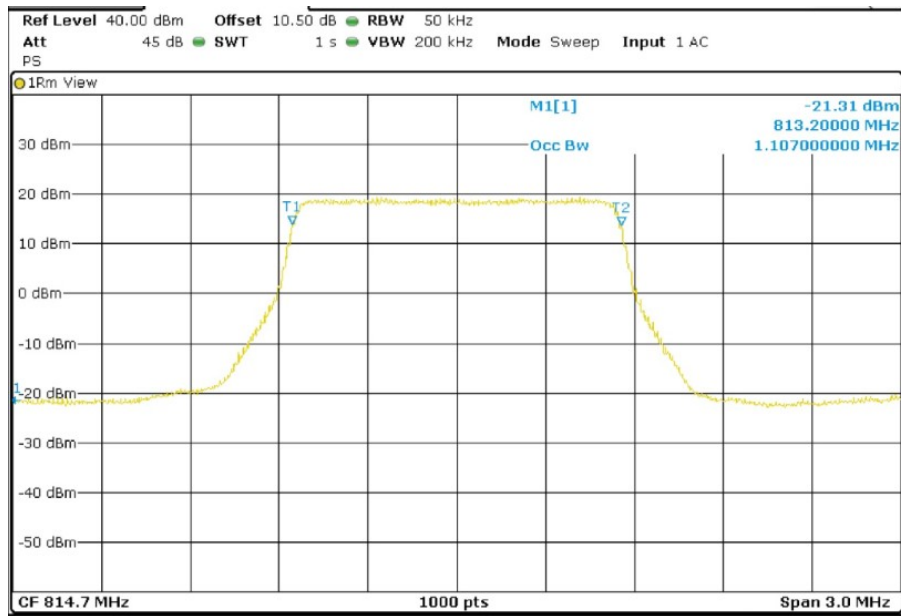

Lowest Channel -26dBc Bandwidth kHz

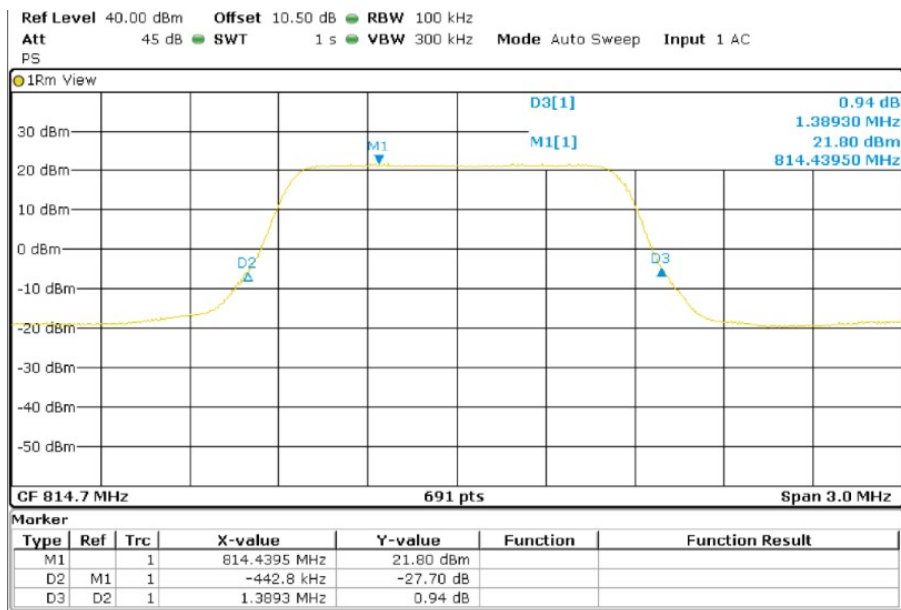

TEST RESULTS (Cont):

Middle Channel 99% Occupied Bandwidth

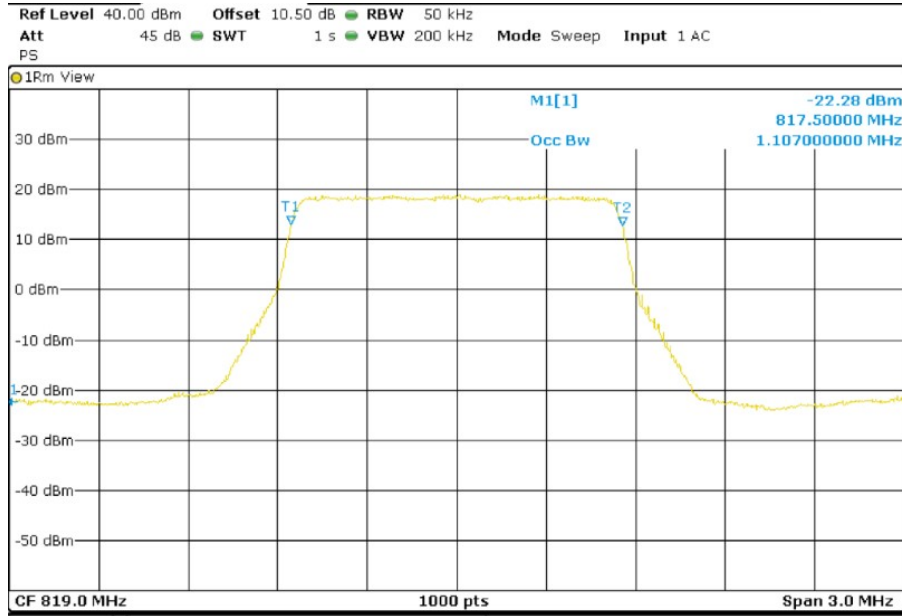

Middle Channel 26dBc Bandwidth kHz

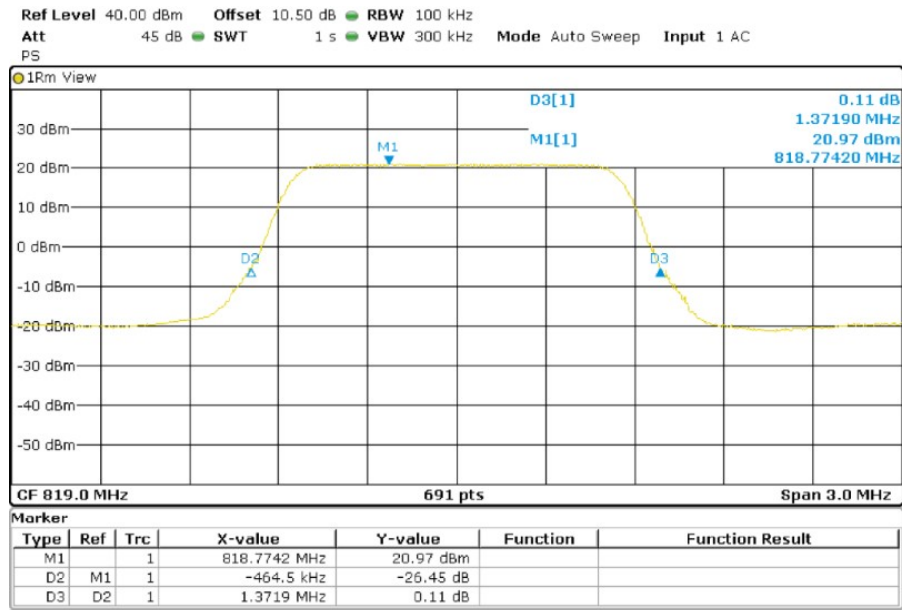

TEST RESULTS (Cont):

Highest Channel 99% Occupied Bandwidth

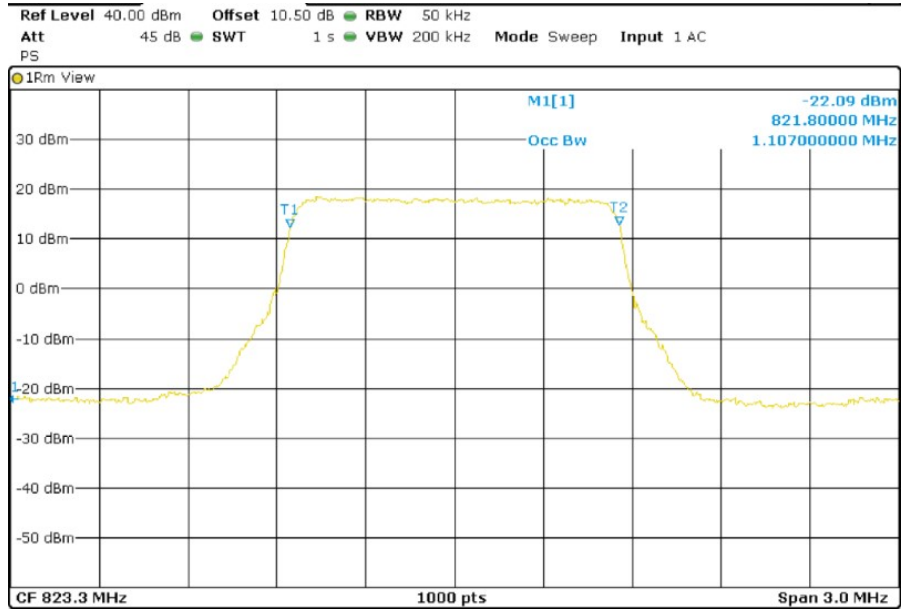

Highest Channel 26dBc Bandwidth kHz

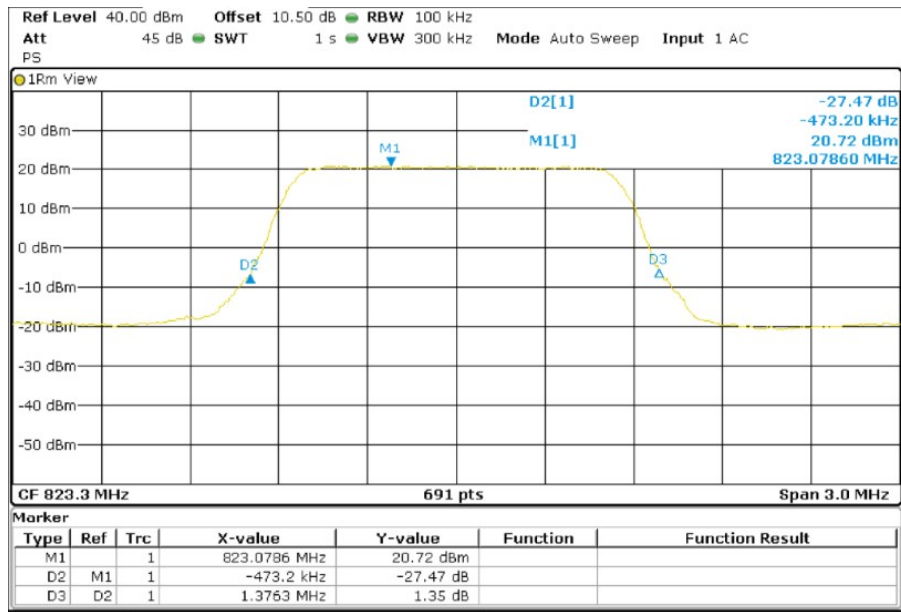

TEST RESULTS (Cont):

LTE 16 QAM MODULATION. BW = 1.4 MHz
 Lowest Channel 99% Occupied Bandwidth

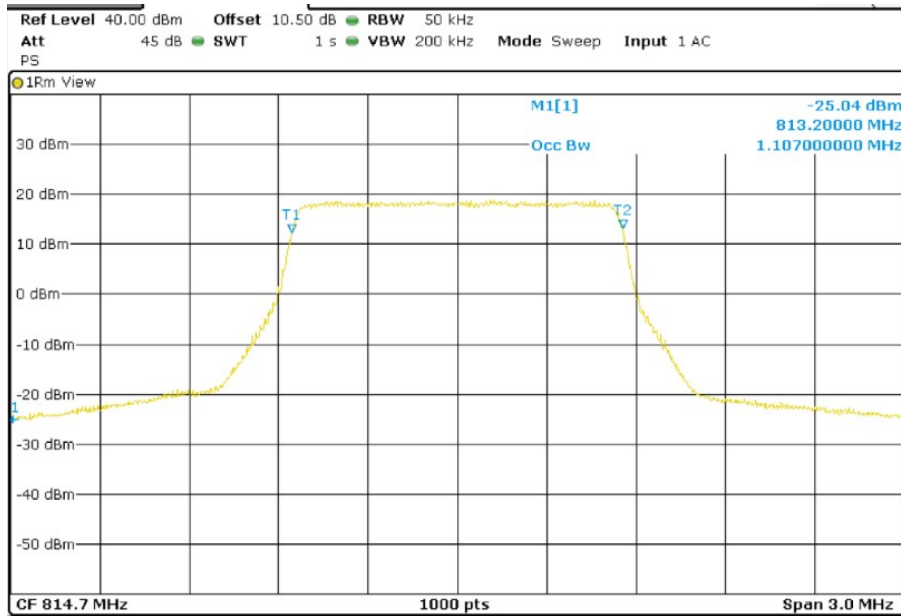

Lowest Channel -26dBc Bandwidth kHz

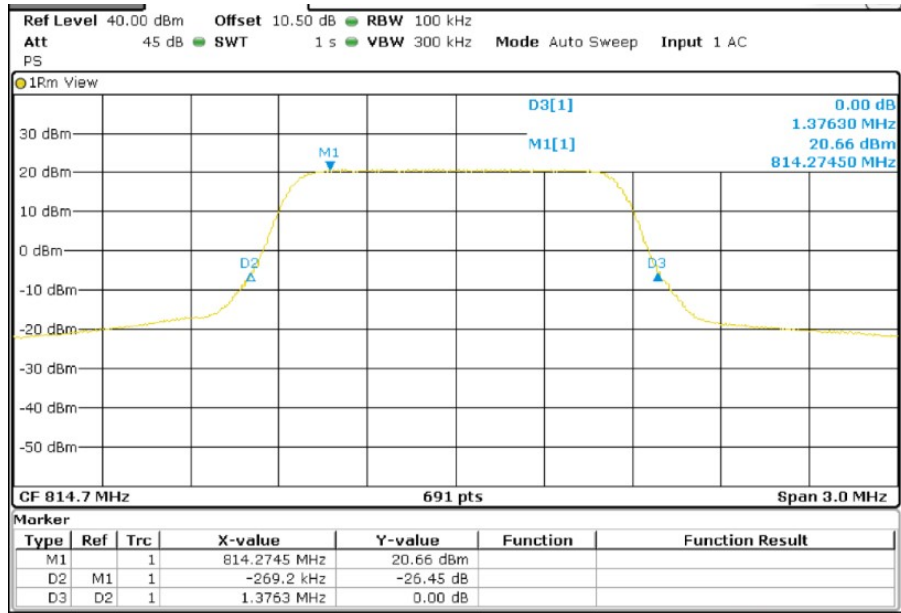

TEST RESULTS (Cont):

Middle Channel 99% Occupied Bandwidth

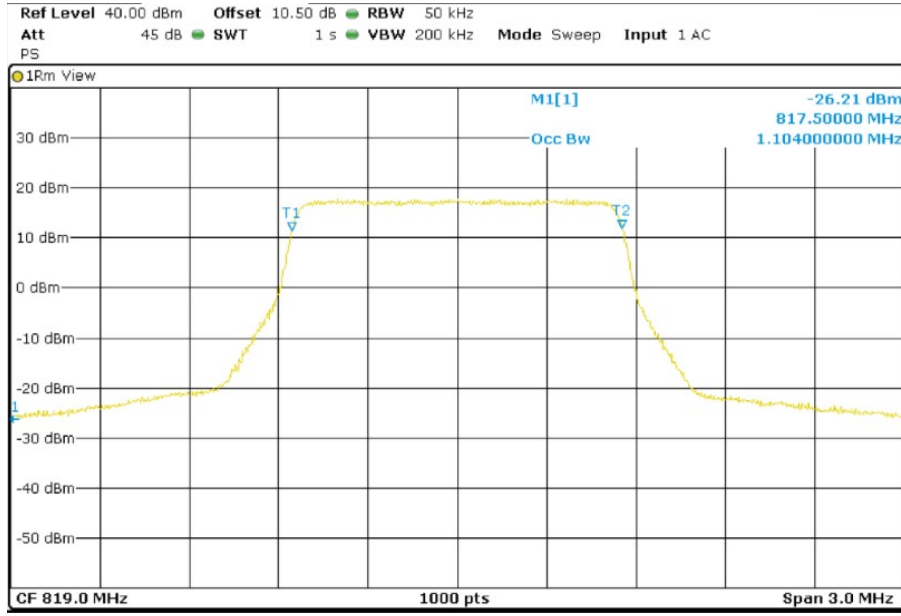

Middle Channel 26dBc Bandwidth kHz

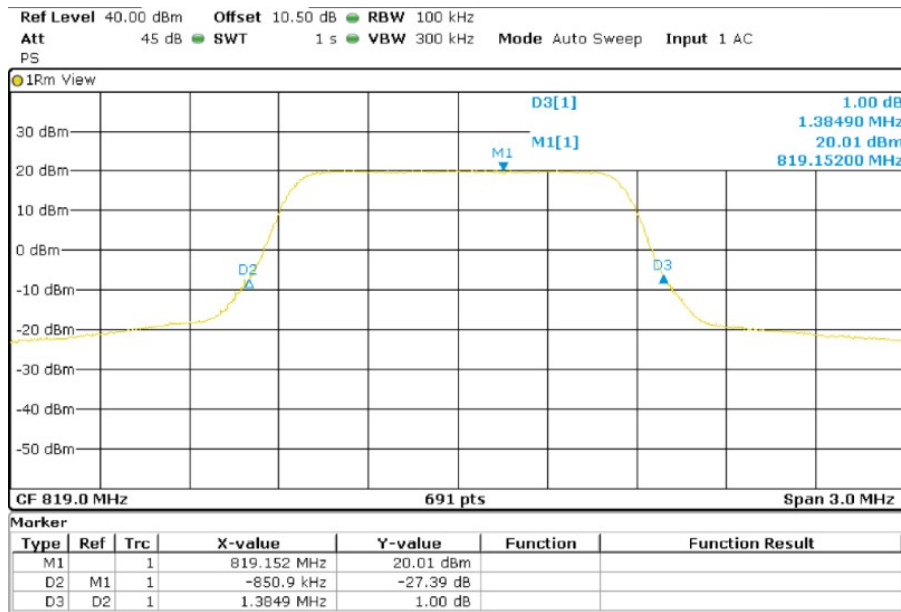

TEST RESULTS (Cont):

Highest Channel 99% Occupied Bandwidth

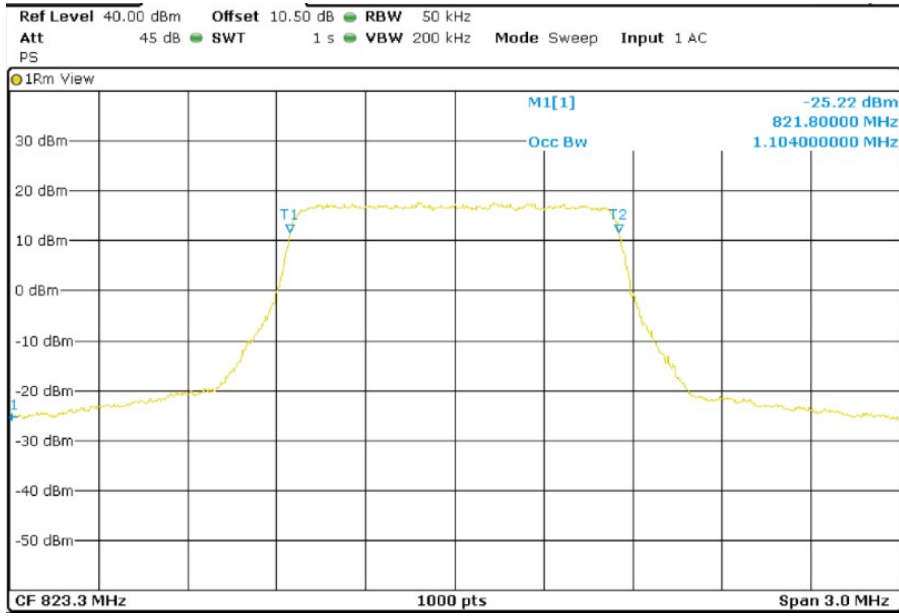

Highest Channel 26dBc Bandwidth kHz

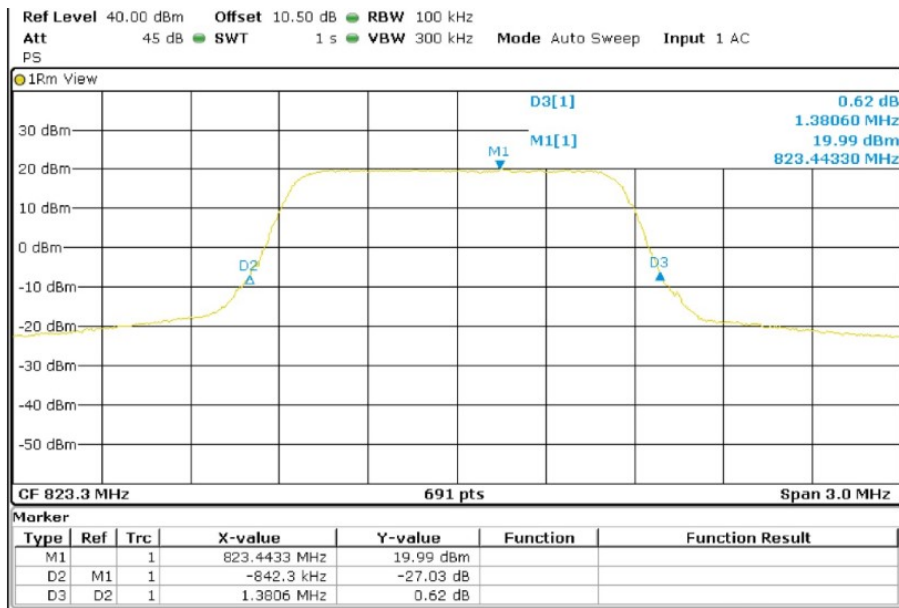

TEST RESULTS (Cont):

LTE QPSK MODULATION. BW = 3 MHz

Lowest Channel 99% Occupied Bandwidth

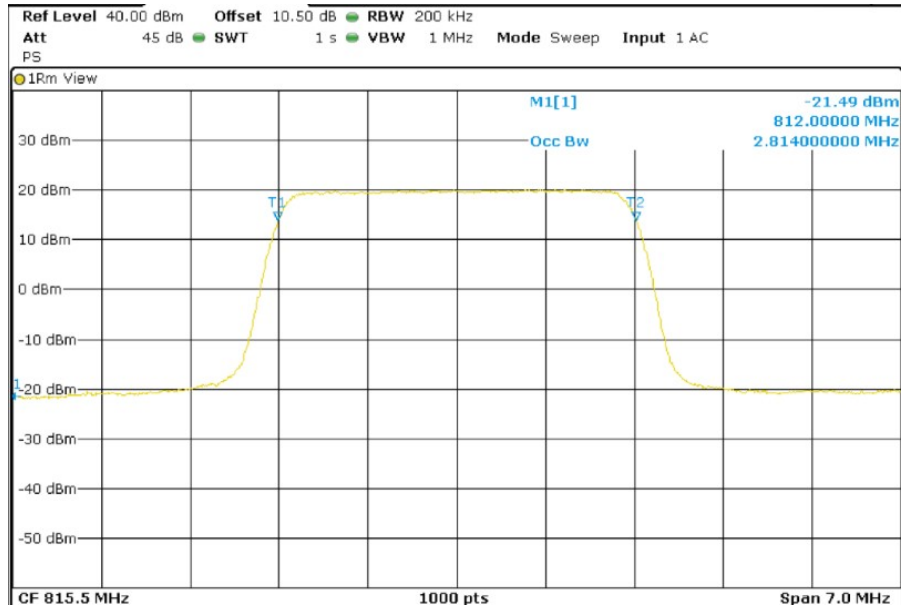

Lowest Channel -26dBc Bandwidth kHz

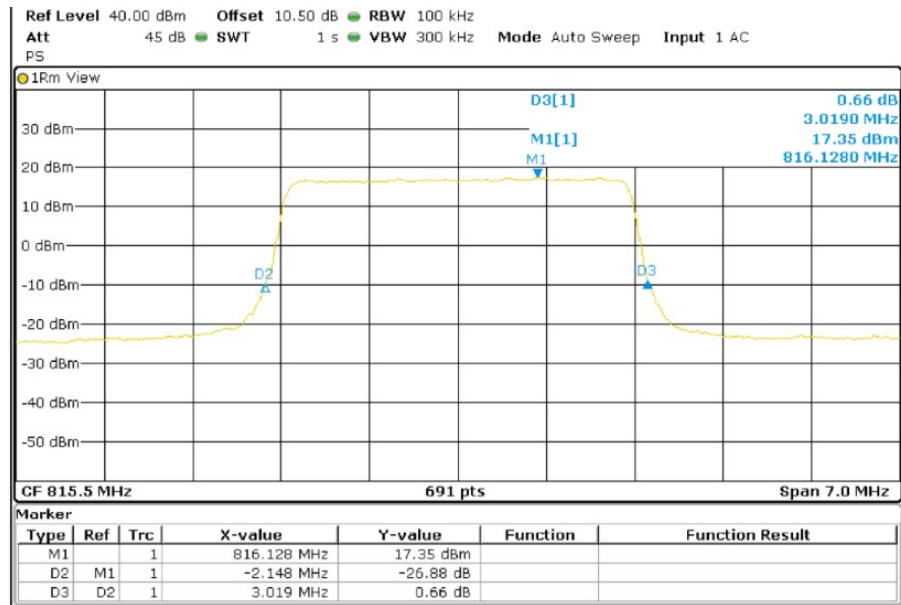

TEST RESULTS (Cont):

Middle Channel 99% Occupied Bandwidth



Middle Channel 26dBc Bandwidth kHz

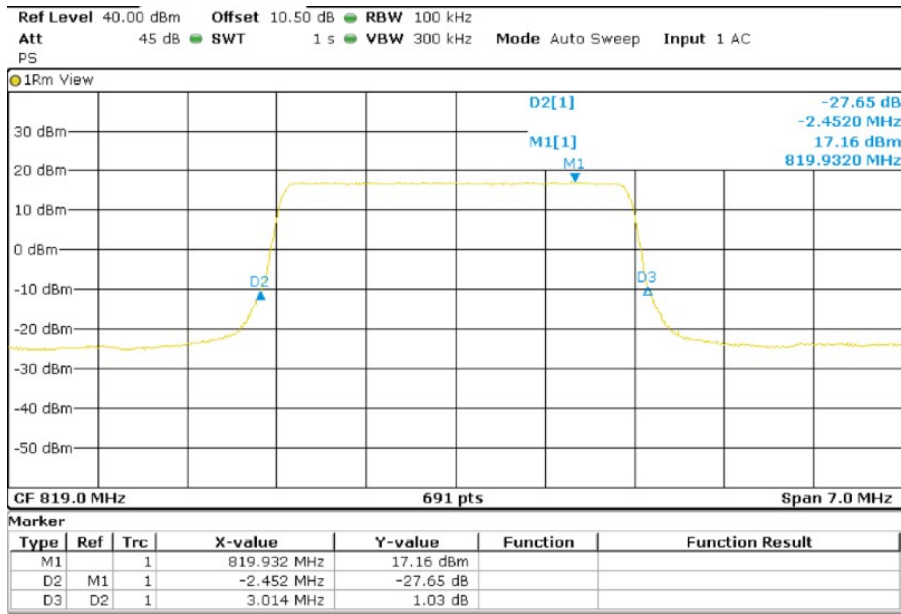

TEST RESULTS (Cont):

Highest Channel 99% Occupied Bandwidth

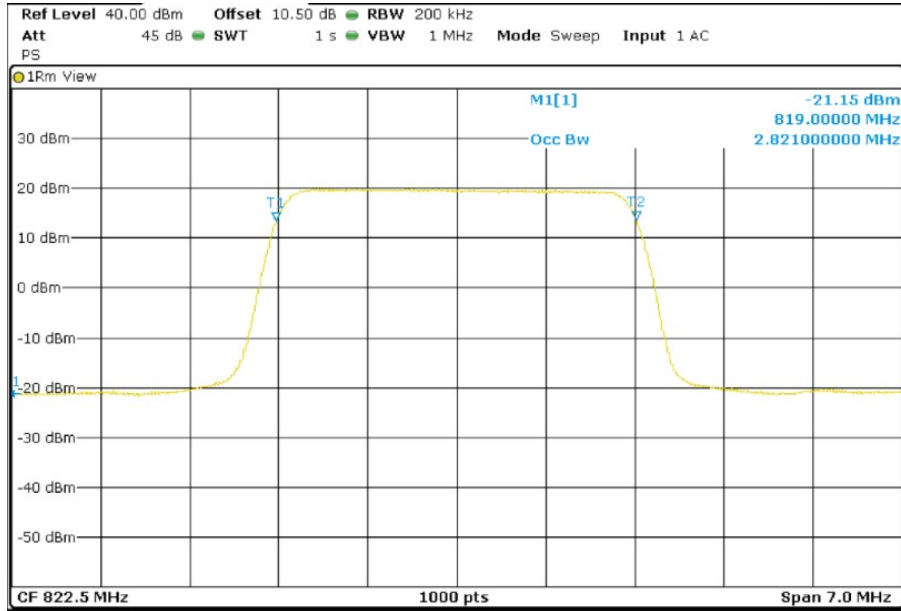

Highest Channel 26dBc Bandwidth kHz

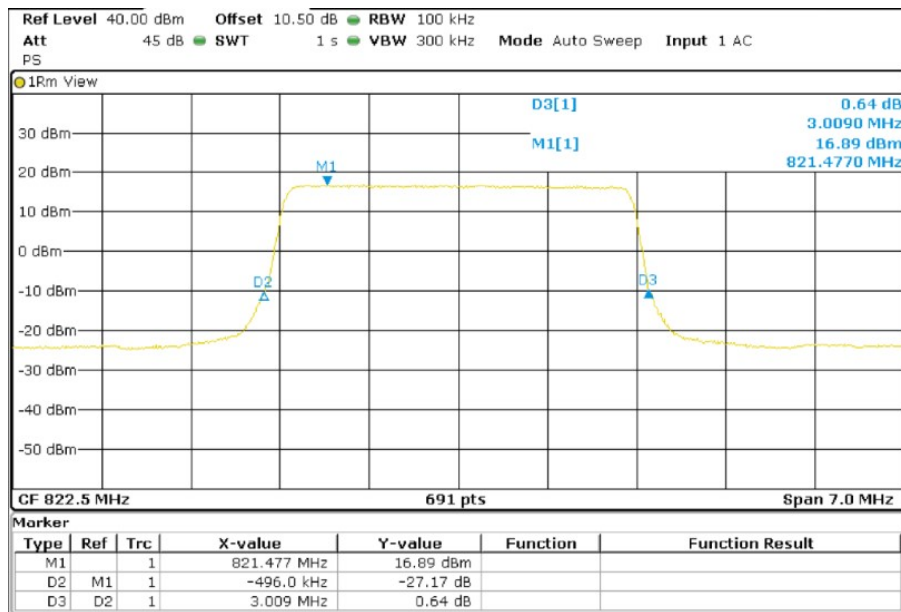

TEST RESULTS (Cont):

LTE 16 QAM MODULATION. BW = 3 MHz
 Lowest Channel 99% Occupied Bandwidth

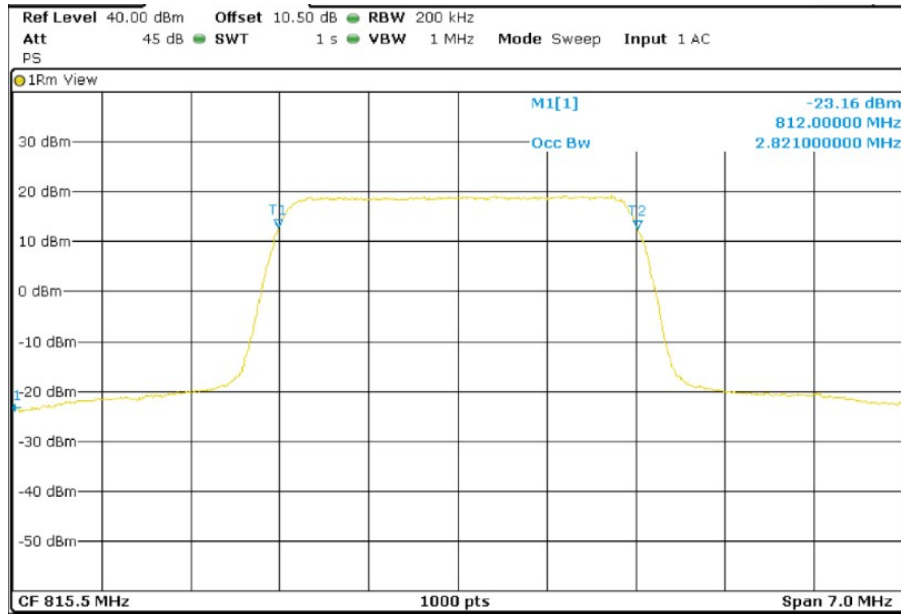

Lowest Channel -26dBc Bandwidth kHz

