



# Test Report

## FCC: 2ANJLNY03

Product Name:	smartwatch
Trademark:	N/A
Model Name :	NY03 NY01, NY02, NY06, NY07, NY08, NY09, NY18, NY58, NY88
Prepared For :	Shenzhen Niyajia Technology Co.,Ltd
Address :	Room 610, waves sino commercial building, Longhua new district, Shenzhen China
Prepared By :	Shenzhen BCTC Testing Co., Ltd.
Address :	BCTC Building & 1-2F, East of B Building, Pengzhou Industrial, Fuyuan 1st Road, Qiaotou Community, Fuyong Street, Bao'an District, Shenzhen, China
Test Date:	Jan. 09, 2019 - Jan. 21, 2019
Date of Report :	Jan. 21, 2019
Report No.:	BCTC-FY190100107E

## TEST RESULT CERTIFICATION

**Applicant's name** ..... : Shenzhen Niyajia Technology Co.,Ltd  
**Address** ..... : Room 610, waves sino commercial building, Longhua new district, Shenzhen China

**Manufacture's Name**..... : Shenzhen Niyajia Technology Co.,Ltd  
**Address** ..... : Room 610, waves sino commercial building, Longhua new district, Shenzhen China

**Product description**

**Product name** ..... : smartwatch  
**Trademark** ..... : N/A  
**Model and/or type reference** : NY03

**Standards** ..... : FCC Part15.247  
ANSI C63.10:2013

This device described above has been tested by BCTC, and the test results show that the equipment under test (EUT) is in compliance with the FCC requirements. And it is applicable only to the tested sample identified in the report.

This report shall not be reproduced except in full, without the written approval of BCTC, this document may be altered or revised by BCTC, personal only, and shall be noted in the revision of the document.

Prepared by(Engineer): Amou Zhang

*Amou Zhang*

Reviewer(Supervisor): Eric Yang

*Eric Yang*

Approved(Manager): Carson Zhang



<b>Table of Contents</b>		<b>Page</b>
<b>1 . SUMMARY OF TEST RESULTS</b>		<b>5</b>
1.1 TEST FACILITY		6
1.2 MEASUREMENT UNCERTAINTY		6
<b>2 . GENERAL INFORMATION</b>		<b>7</b>
2.1 GENERAL DESCRIPTION OF EUT		7
2.2 DESCRIPTION OF TEST MODES		8
2.3 BLOCK DIGRAM SHOWING THE CONFIGURATION OF SYSTEM TESTED		8
2.4 DESCRIPTION OF SUPPORT UNITS(CONDUCTED MODE)		8
2.5 EQUIPMENTS LIST FOR ALL TEST ITEMS		10
<b>3 . EMC EMISSION TEST</b>		<b>11</b>
3.1 CONDUCTED EMISSION MEASUREMENT		11
3.1.1 POWER LINE CONDUCTED EMISSION LIMITS		11
3.1.2 TEST PROCEDURE		11
3.1.3 DEVIATION FROM TEST STANDARD		11
3.1.4 TEST SETUP		12
3.1.5 EUT OPERATING CONDITIONS		12
3.1.6 TEST RESULTS		12
3.2 RADIATED EMISSION MEASUREMENT		15
3.2.1 RADIATED EMISSION LIMITS		15
3.2.2 TEST PROCEDURE		16
3.2.3 DEVIATION FROM TEST STANDARD		16
3.2.4 TEST SETUP		17
3.2.5 EUT OPERATING CONDITIONS		18
3.2.6 TEST RESULTS (BETWEEN 9KHZ – 30 MHZ)		19
3.2.7 TEST RESULTS (BETWEEN 30MHZ – 1GHZ)		20
3.3 RADIATED BAND EMISSION MEASUREMENT		23
3.3.1 TEST REQUIREMENT:		23
3.3.2 TEST PROCEDURE		23
3.3.3 DEVIATION FROM TEST STANDARD		24
3.3.4 TEST SETUP		24
3.3.5 EUT OPERATING CONDITIONS		24
<b>4 . POWER SPECTRAL DENSITY TEST</b>		<b>26</b>
4.1 APPLIED PROCEDURES / LIMIT		26
4.1.1 TEST PROCEDURE		26

	<b>Page</b>
<b>Table of Contents</b>	
4.1.2 DEVIATION FROM STANDARD	26
4.1.3 TEST SETUP	26
4.1.4 EUT OPERATION CONDITIONS	26
4.1.5 TEST RESULTS	27
<b>5 . BANDWIDTH TEST</b>	<b>29</b>
5.1 APPLIED PROCEDURES / LIMIT	29
5.1.1 TEST PROCEDURE	29
5.1.2 DEVIATION FROM STANDARD	29
5.1.3 TEST SETUP	29
5.1.4 EUT OPERATION CONDITIONS	29
5.1.5 TEST RESULTS	30
<b>6 . PEAK OUTPUT POWER TEST</b>	<b>32</b>
6.1 APPLIED PROCEDURES / LIMIT	32
6.1.1 TEST PROCEDURE	32
6.1.2 DEVIATION FROM STANDARD	32
6.1.3 TEST SETUP	32
6.1.4 EUT OPERATION CONDITIONS	32
6.1.5 TEST RESULTS	33
<b>7 . 100 KHZ BANDWIDTH OF FREQUENCY BAND EDGE</b>	<b>34</b>
7.1 APPLICABLE STANDARD	34
7.2 TEST PROCEDURE	34
7.3 DEVIATION FROM STANDARD	34
7.4 TEST SETUP	34
7.5 EUT OPERATION CONDITIONS	34
<b>8 . ANTENNA REQUIREMENT</b>	<b>37</b>
8.1 STANDARD REQUIREMENT	37
8.2 EUT ANTENNA	37
<b>9 . EUT TEST PHOTO</b>	<b>38</b>
<b>10 . EUT PHOTO</b>	<b>40</b>
<b>APPENDIX-PHOTOGRAPHS OF EUT CONSTRUCTIONAL DETAILS</b>	

## 1. SUMMARY OF TEST RESULTS

Test procedures according to the technical standards:

<b>FCC Part15 (15.247) , Subpart C</b>			
Standard Section	Test Item	Judgment	Remark
15.207	Conducted Emission	PASS	
15.247 (a)(2)	6dB Bandwidth	PASS	
15.247 (b)	Peak Output Power	PASS	
15.247 (d)	Radiated Spurious Emission	PASS	
15.247 (e)	Power Spectral Density	PASS	
15.205	Restricted Band of Operation	PASS	
15.247(d)	Band Edge (Out of Band Emissions)	PASS	
15.203	Antenna Requirement	PASS	

**NOTE:**

(1) "N/A" denotes test is not applicable in this Test Report

## 1.1 TEST FACILITY

Shenzhen BCTC Testing Co., Ltd.

Add.: BCTC Building & 1-2F, East of B Building, Pengzhou Industrial, Fuyuan 1st Road, Qiaotou Community, Fuyong Street, Bao'an District, Shenzhen, China

FCC Test Firm Registration Number: 712850

IC Registered No.: 23583

## 1.2 MEASUREMENT UNCERTAINTY

The reported uncertainty of measurement  $y \pm U$ , where expanded uncertainty  $U$  is based on a standard uncertainty multiplied by a coverage factor of  $k=2$ , providing a level of confidence of approximately **95 %**.

No.	Item	Uncertainty
1	3m chamber Radiated spurious emission(30MHz-1GHz)	U=4.3dB
2	3m chamber Radiated spurious emission(1GHz-18GHz)	U=4.5dB
3	3m chamber Radiated spurious emission(18GHz-40GHz)	U=3.34dB
4	Conducted Adjacent channel power	U=1.38dB
5	Conducted output power uncertainty Above 1G	U=1.576dB
6	Conducted output power uncertainty below 1G	U=1.28dB
7	humidity uncertainty	U=5.3%
8	Temperature uncertainty	U=0.59℃
9	Radiated disturbance(30MHz-1000MHz)	U=4.8dB
10	Radiated disturbance(1GHz-6GHz)	U=4.9dB
11	Radiated disturbance(1GHz-18GHz)	U=5.0dB

## 2. GENERAL INFORMATION

### 2.1 GENERAL DESCRIPTION OF EUT

Equipment	smartwatch								
Trade Name	N/A								
Model Name	NY03, NY01, NY02, NY06, NY07, NY08, NY09, NY18, NY58, NY88								
Model Difference	All the model are the same circuit and RF module, except model names.								
Product Description	<table border="1"> <tr> <td>Operation Frequency:</td> <td>2402-2480 MHz</td> </tr> <tr> <td>Modulation Type:</td> <td>GFSK</td> </tr> <tr> <td>Number Of Channel</td> <td>40CH</td> </tr> <tr> <td>Antenna Designation:</td> <td>Please see Note 3.</td> </tr> </table>	Operation Frequency:	2402-2480 MHz	Modulation Type:	GFSK	Number Of Channel	40CH	Antenna Designation:	Please see Note 3.
	Operation Frequency:	2402-2480 MHz							
	Modulation Type:	GFSK							
	Number Of Channel	40CH							
	Antenna Designation:	Please see Note 3.							
Based on the application, features, or specification exhibited in User's Manual, the EUT is considered as an ITE/Computing Device. More details of EUT technical specification, please refer to the User's Manual.									
Channel List	Please refer to the Note 2.								
Power Source	DC 3.7V								
Connecting I/O Port(s)	Please refer to the User's Manual								

Note:

1. For a more detailed features description, please refer to the manufacturer's specifications or the User's Manual.

2.

Channel List					
Channel	Frequency (MHz)	Channel	Frequency (MHz)	Channel	Frequency (MHz)
01	2402	11	2422	21	2442
02	2404	12	2424	22	2444
03	2406	13	2426	23	2446
~	~	~	~	~	~
09	2418	19	2438	39	2478
10	2420	20	2440	40	2480

3.

Table for Filed Antenna

Ant.	Brand	Model Name	Antenna Type	Gain (dBi)	NOTE
1	N/A	N/A	Internal antenna	0	

## 2.2 DESCRIPTION OF TEST MODES

To investigate the maximum EMI emission characteristics generates from EUT, the test system was pre-scanning tested base on the consideration of following EUT operation mode or test configuration mode which possible have effect on EMI emission level. Each of these EUT operation mode(s) or test configuration mode(s) mentioned above was evaluated respectively.

For All Mode	Description	Modulation Type
Mode 1	CH01	GFSK
Mode 2	CH20	
Mode 3	CH40	
Mode 4	Link mode(conducted emission and Radiated emission)	

Note:

- (1) The measurements are performed at the highest, middle, lowest available channels.
- (2) Fully-charged battery is used during the test

## 2.3 BLOCK DIGRAM SHOWING THE CONFIGURATION OF SYSTEM TESTED

Conducted Emission Test

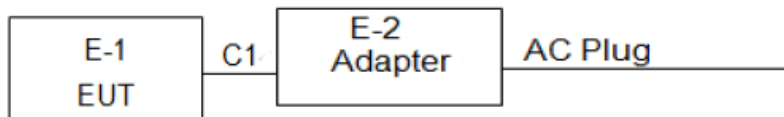

Radiated Spurious Emission Test

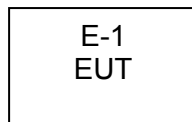

## 2.4 DESCRIPTION OF SUPPORT UNITS(CONDUCTED MODE)

The EUT has been tested as an independent unit together with other necessary accessories or support units. The following support units or accessories were used to form a representative test configuration during the tests.





Item	Equipment	Mfr/Brand	Model/Type No.	Series No.	Note
E-1	smartwatch	N/A	NY03	N/A	EUT

Item	Shielded Type	Ferrite Core	Length	Note

Note:

- (1) The support equipment was authorized by Declaration of Confirmation.
- (2) For detachable type I/O cable should be specified the length in cm in 『Length』 column.

## 2.5 EQUIPMENTS LIST FOR ALL TEST ITEMS

### Radiation Test equipment

Item	Equipment	Manufacturer	Type No.	Serial No.	Last calibration	Calibrated until
1	Spectrum Analyzer (9kHz-26.5GHz)	Agilent	E4407B	MY45109572	2018.06.20	2019.06.20
2	Test Receiver (9kHz-7GHz)	R&S	ESR7	101154	2018.06.20	2019.06.20
3	Bilog Antenna (30MHz-3GHz)	SCHWARZBEC K	VULB9163	VULB9163-942	2018.06.23	2019.06.23
4	Horn Antenna (1GHz-18GHz)	SCHWARZBEC K	BBHA9120D	1541	2018.06.23	2019.06.22
5	Horn Antenna (18GHz-40GHz)	SCHWARZBEC K	BBHA9170	822	2018.08.06	2019.08.06
6	Amplifier (9kHz-6GHz)	SCHWARZBEC K	BBV9744	9744-0037	2018.06.20	2019.06.20
7	Amplifier (0.5GHz-18GHz)	SCHWARZBEC K	BBV9718	9718-309	2018.06.20	2019.06.20
8	Amplifier (18GHz-40GHz)	MITEQ	TTA1840-35-HG	2034381	2018.08.06	2019.08.06
9	Loop Antenna (9kHz-30MHz)	SCHWARZBEC K	FMZB1519B	014	2018.06.23	2019.06.23
10	RF cables1 (9kHz-30MHz)	Huber+Suhnar	9kHz-30MHz	B1702988-0008	2018.02.12	2019.02.12
11	RF cables2 (30MHz-1GHz)	Huber+Suhnar	30MHz-1GHz	1486150	2018.03.27	2019.03.27
12	RF cables3 (1GHz-40GHz)	Huber+Suhnar	1GHz-40GHz	1607106	2018.06.19	2019.06.19
13	Power Metter	Keysight	E4419	\	2018.04.15	2019.04.15
14	Power Sensor (AV)	Keysight	E9 300A	\	2018.04.15	2019.04.15
15	Signal Analyzer 20kHz-26.5GHz	KEYSIGHT	N9020A	MY49100060	2018.08.14	2019.08.13
16	Test Receiver 9kHz-40GHz	R&S	FSP40	100550	2018.06.13	2019.06.12
17	D.C. Power Supply	LongWei	TPR-6405D	\	\	\
18	Software	Frad	EZ-EMC	FA-03A2 RE	\	\

### Conduction Test equipment

Item	Equipment	Manufacturer	Type No.	Serial No.	Last calibration	Calibrated until
1	Test Receiver	R&S	ESR3	102075	2018.06.20	2019.06.20
2	LISN	SCHWARZBEC K	NSLK8127	8127739	2018.06.19	2019.06.19
3	LISN	R&S	ENV216	101375	2018.06.20	2019.06.20
4	RF cables	Huber+Suhnar	9kHz-30MHz	B1702988-0008	2018.02.12	2019.02.12
5	Software	Frad	EZ-EMC	EMC-CON 3A1	\	\

### 3. EMC EMISSION TEST

#### 3.1 CONDUCTED EMISSION MEASUREMENT

##### 3.1.1 POWER LINE CONDUCTED EMISSION Limits (Frequency Range 150KHz-30MHz)

FREQUENCY (MHz)	Limit (dBuV)		Standard
	Quas -peak	Average	
0.15 -0.5	66 - 56 *	56 - 46 *	FCC
0.50 -5.0	56.00	46.00	FCC
5.0 -30.0	60.00	50.00	FCC

Note:

- (1) The tighter limit applies at the band edges.
- (2) The limit of " \* " marked band means the limitation decreases linearly with the logarithm of the frequency in the range.

The following table is the setting of the receiver

Receiver Parameters	Setting
Attenuation	10 dB
Start Frequency	0.15 MHz
Stop Frequency	30 MHz
IF Bandwidth	9 kHz

#### 3.1.2 TEST PROCEDURE

- a. The EUT was placed 0.8 meters from the horizontal ground plane with EUT being connected to the power mains through a line impedance stabilization network (LISN). All other support equipments powered from additional LISN(s). The LISN provide 50 Ohm/ 50uH of coupling impedance for the measuring instrument.
- b. Interconnecting cables that hang closer than 40 cm to the ground plane shall be folded back and forth in the center forming a bundle 30 to 40 cm long.
- c. I/O cables that are not connected to a peripheral shall be bundled in the center. The end of the cable may be terminated, if required, using the correct terminating impedance. The overall length shall not exceed 1 m.
- d. LISN at least 80 cm from nearest part of EUT chassis.
- e. For the actual test configuration, please refer to the related Item –EUT Test Photos.

#### 3.1.3 DEVIATION FROM TEST STANDARD

No deviation

### 3.1.4 TEST SETUP

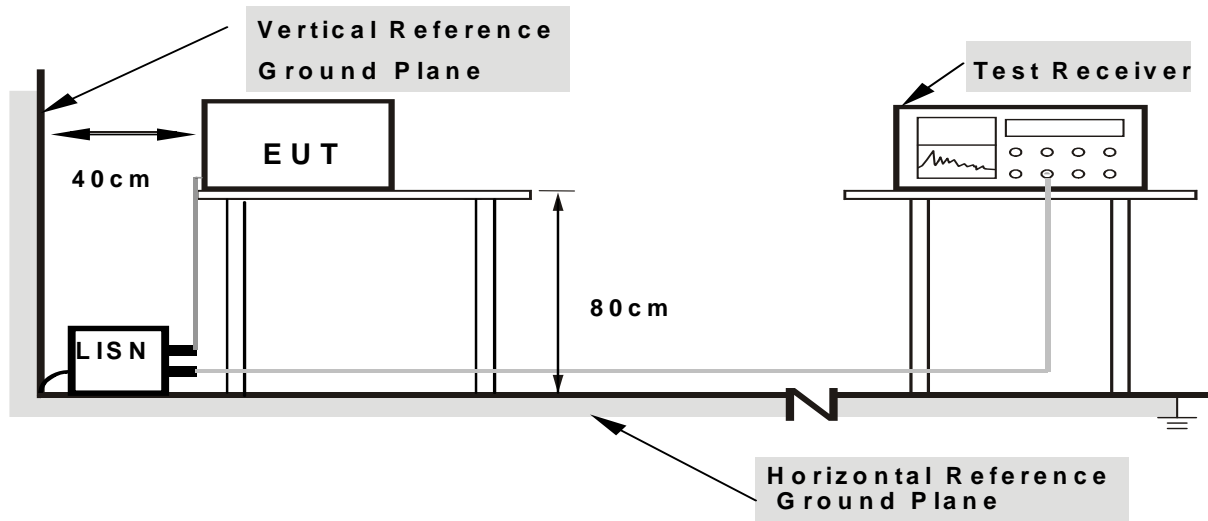

Note: 1.Support units were connected to second LISN.

2.Both of LISNs (AMN) are 80 cm from EUT and at least 80 from other units and other metal planes

### 3.1.5 EUT OPERATING CONDITIONS

The EUT was configured for testing in a typical fashion (as a customer would normally use it). The EUT has been programmed to continuously transmit during test. This operating condition was tested and used to collect the included data.

We pretest AC 120V and AC 240V, the worst voltage was AC 120V and the data recording in the report.

### 3.1.6 TEST RESULTS



Temperature :	25°C	Relative Humidity :	55%
Pressure :	101kPa	Phase :	L
Test Voltage :	DC 5V From adapter	Test Mode :	Mode 4

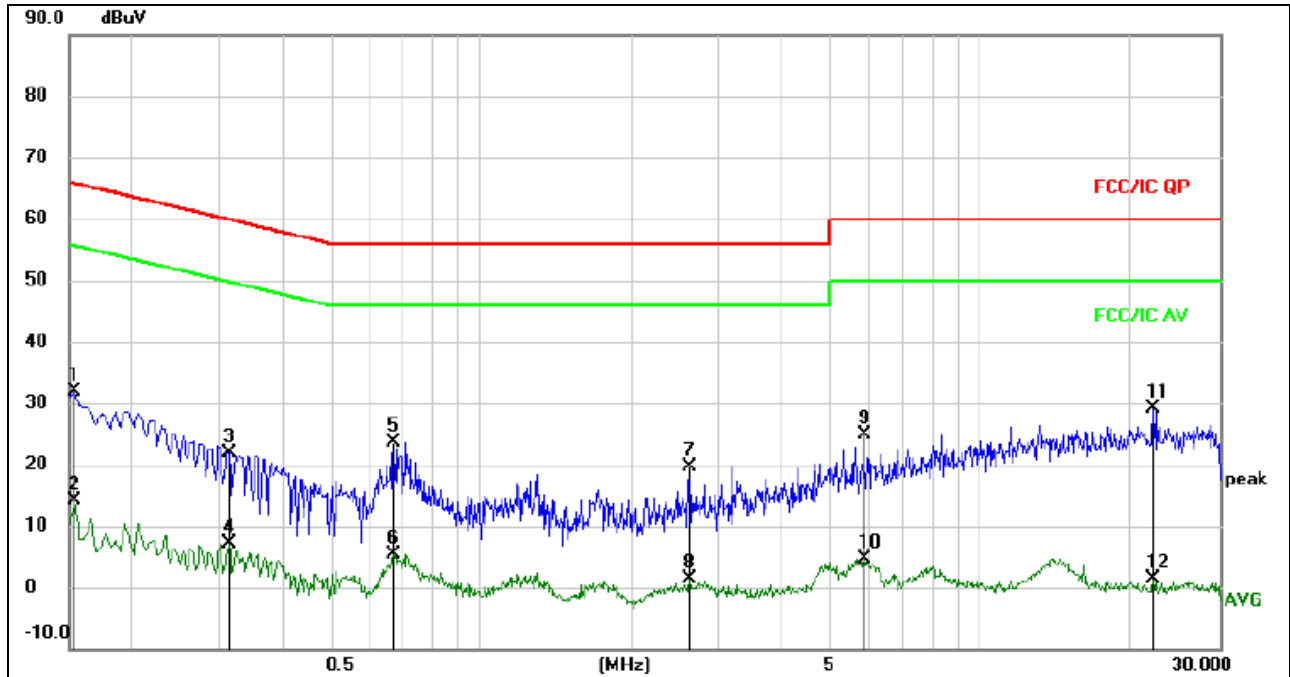

Remark:

1. All readings are Quasi-Peak and Average values.
2. Factor = Insertion Loss + Cable Loss.

No. Mk.	Freq. MHz	Reading Level dBuV	Correct Factor	Measure- ment dBuV	Limit dBuV	Over dB	Detector	Comment
1	0.1539	22.26	9.52	31.78	65.79	-34.01	QP	
2	0.1539	4.60	9.52	14.12	55.79	-41.67	AVG	
3	0.3140	12.40	9.57	21.97	59.86	-37.89	QP	
4	0.3140	-2.42	9.57	7.15	49.86	-42.71	AVG	
5	0.6700	13.96	9.75	23.71	56.00	-32.29	QP	
6	0.6700	-4.37	9.75	5.38	46.00	-40.62	AVG	
7	2.6220	9.88	9.63	19.51	56.00	-36.49	QP	
8	2.6220	-8.35	9.63	1.28	46.00	-44.72	AVG	
9	5.8419	15.16	9.77	24.93	60.00	-35.07	QP	
10	5.8419	-5.18	9.77	4.59	50.00	-45.41	AVG	
11 *	22.0980	19.27	9.77	29.04	60.00	-30.96	QP	
12	22.0980	-8.50	9.77	1.27	50.00	-48.73	AVG	



Temperature :	25°C	Relative Humidity :	55%
Pressure :	101kPa	Phase :	N
Test Voltage :	DC 5V From adapter	Test Mode :	Mode 4

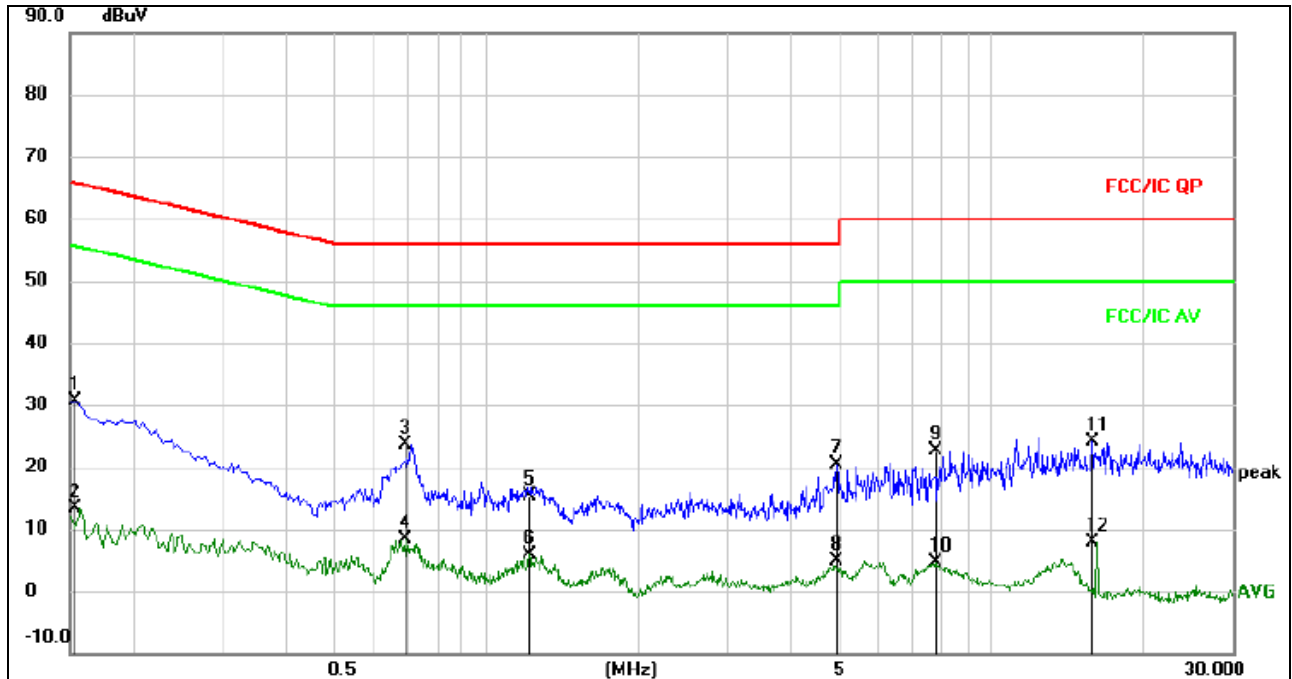

**Remark:**

1. All readings are Quasi-Peak and Average values.
2. Factor = Insertion Loss + Cable Loss.

No.	Mk.	Freq. MHz	Reading Level dBuV	Correct Factor	Measure- ment dBuV	Limit dBuV	Over dB	Detector	Comment
1		0.1539	21.10	9.52	30.62	65.79	-35.17	QP	
2		0.1539	3.89	9.52	13.41	55.79	-42.38	AVG	
3	*	0.6940	13.90	9.67	23.57	56.00	-32.43	QP	
4		0.6940	-1.21	9.67	8.46	46.00	-37.54	AVG	
5		1.2220	5.73	9.57	15.30	56.00	-40.70	QP	
6		1.2220	-3.77	9.57	5.80	46.00	-40.20	AVG	
7		4.9420	10.59	9.80	20.39	56.00	-35.61	QP	
8		4.9420	-4.90	9.80	4.90	46.00	-41.10	AVG	
9		7.7620	12.99	9.71	22.70	60.00	-37.30	QP	
10		7.7620	-5.01	9.71	4.70	50.00	-45.30	AVG	
11		15.8220	14.44	9.71	24.15	60.00	-35.85	QP	
12		15.8220	-1.75	9.71	7.96	50.00	-42.04	AVG	

### 3.2 RADIATED EMISSION MEASUREMENT

#### 3.2.1 RADIATED EMISSION LIMITS (Frequency Range 9kHz-1000MHz)

20dBc in any 100 kHz bandwidth outside the operating frequency band. In case the emission fall within the restricted band specified on 15.205(a), then the 15.209(a) limit in the table below has to be followed.

Frequencies (MHz)	Field Strength (micorvolts/meter)	Measurement Distance (meters)
0.009~0.490	2400/F(KHz)	300
0.490~1.705	24000/F(KHz)	30
1.705~30.0	30	30
30~88	100	3
88~216	150	3
216~960	200	3
Above 960	500	3

#### LIMITS OF RADIATED EMISSION MEASUREMENT (Above 1000MHz)

FREQUENCY (MHz)	Limit (dBuV/m) (at 3M)	
	PEAK	AVERAGE
Above 1000	74	54

Notes:

- (1) The limit for radiated test was performed according to FCC PART 15C.
- (2) The tighter limit applies at the band edges.
- (3) Emission level (dBuV/m)=20log Emission level (uV/m).

#### FREQUENCY RANGE OF RADIATED MEASUREMENT (For unintentional radiators)

Highest frequency generated or Upper frequency of measurement used in the device or on which the device operates or tunes (MHz)	Range (MHz)
Below 1.705	30
1.705 – 108	1000
108 – 500	2000
500 – 1000	5000
Above 1000	5 <sup>th</sup> harmonic of the highest frequency or 40 GHz, whichever is lower

Spectrum Parameter	Setting
Attenuation	Auto
Start Frequency	1000 MHz
Stop Frequency	10th carrier harmonic
RB / VB (emission in restricted band)	1 MHz / 1 MHz for Peak, 1 MHz / 10Hz for Average

Receiver Parameter	Setting
Attenuation	Auto
Start ~ Stop Frequency	9kHz~150kHz / RB 200Hz for QP
Start ~ Stop Frequency	150kHz~30MHz / RB 9kHz for QP
Start ~ Stop Frequency	30MHz~1000MHz / RB 120kHz for QP

### 3.2.2 TEST PROCEDURE

- a. The measuring distance of at 3 m shall be used for measurements at frequency up to 25GHz. For frequencies above 1GHz, any suitable measuring distance may be used.
- b. The EUT was placed on the top of a rotating table 0.8 meters above the ground at a 3 meter semi-chamber test. The table was rotated 360 degrees to determine the position of the highest radiation.
- c. The height of the equipment or of the substitution antenna shall be 0.8m; above 1GHz, the height was 1.5m, the height of the test antenna shall vary between 1 m to 4 m. Both horizontal and vertical polarizations of the antenna are set to make the measurement.
- d. The initial step in collecting conducted emission data is a spectrum analyzer peak detector mode pre-scanning the measurement frequency range. Significant peaks are then marked and then Quasi Peak detector mode re-measured.
- e. If the Peak Mode measured value compliance with and lower than Quasi Peak Mode Limit, the EUT shall be deemed to meet QP Limits and then no additional QP Mode measurement performed.
- f. For the actual test configuration, please refer to the related Item –EUT Test Photos.
- g. For the radiated emission test above 1GHz:  
Place the measurement antenna away from each area of the EUT determined to be a source of emissions at the specified measurement distance, while keeping the measurement antenna aimed at the source of emissions at each frequency of significant emissions, with polarization oriented for maximum response.  
The measurement antenna may have to be higher or lower than the EUT, depending on the radiation pattern of the emission and staying aimed at the emission source for receiving the maximum signal. The final measurement antenna elevation shall be that which maximizes the emissions. The measurement antenna elevation for maximum emissions shall be restricted to a range of heights of from 1 m to 4 m above the ground or reference ground plane.

Note:

Both horizontal and vertical antenna polarities were tested and performed pretest to three orthogonal axis. The worst case emissions were reported

### 3.2.3 DEVIATION FROM TEST STANDARD

No deviation



### 3.2.4 TEST SETUP

(A) Radiated Emission Test-Up Frequency Below 30MHz

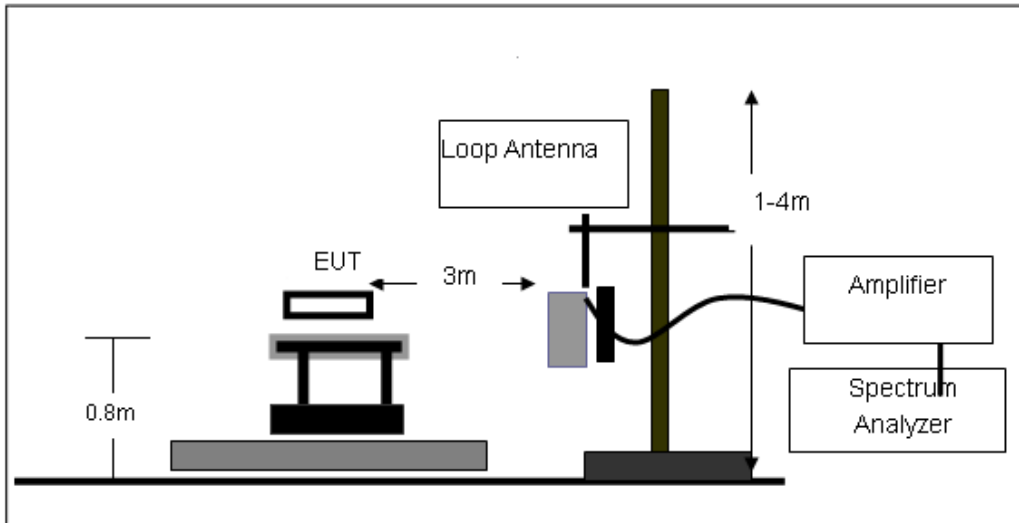

(B) Radiated Emission Test-Up Frequency 30MHz~1GHz

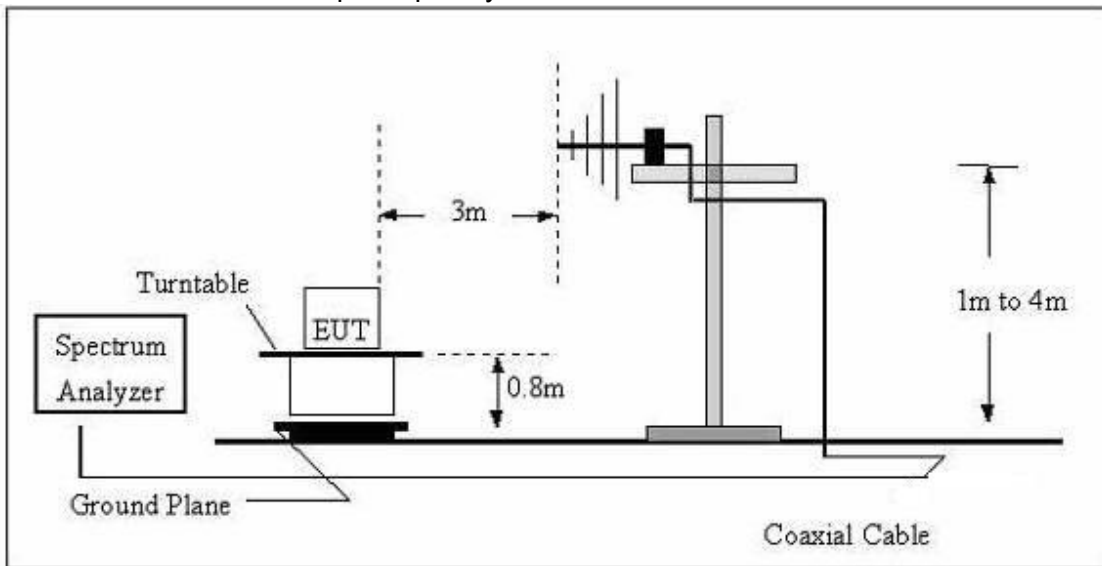

(C) Radiated Emission Test-Up Frequency Above 1GHz

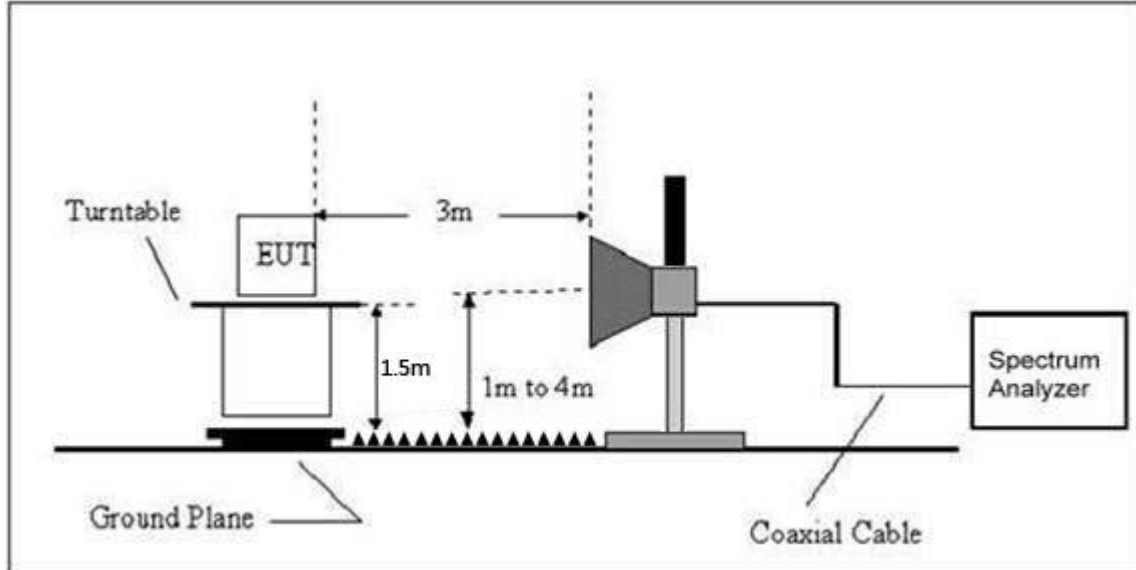

### 3.2.5 EUT OPERATING CONDITIONS

The EUT tested system was configured as the statements of 2.4 Unless otherwise a special operating condition is specified in the follows during the testing.



**3.2.6 TEST RESULTS (BETWEEN 9KHZ – 30 MHZ)**

Temperature:	25℃	Relative Humidity:	55%
Pressure:	101kPa	Test Voltage :	DC 3.7V
Test Mode :	Mode 4	Polarization :	--

Freq.	Reading	Limit	Margin	State
(MHz)	(dBuV/m)	(dBuV/m)	(dB)	P/F
--	--	--	--	PASS
--	--	--	--	PASS

**NOTE:**

The amplitude of spurious emissions which are attenuated by more than 20dB below the permissible value has no need to be reported.

Distance extrapolation factor =  $40 \log(\text{specific distance}/\text{test distance})$ (dB);

Limit line = specific limits(dBuv) + distance extrapolation factor.

**3.2.7 TEST RESULTS (BETWEEN 30MHZ – 1GHZ)**

Temperature :	25°C	Relative Humidity :	55%
Test Voltage :	DC 3.7V	Polarization :	Horizontal
Test Mode :	Mode 4		

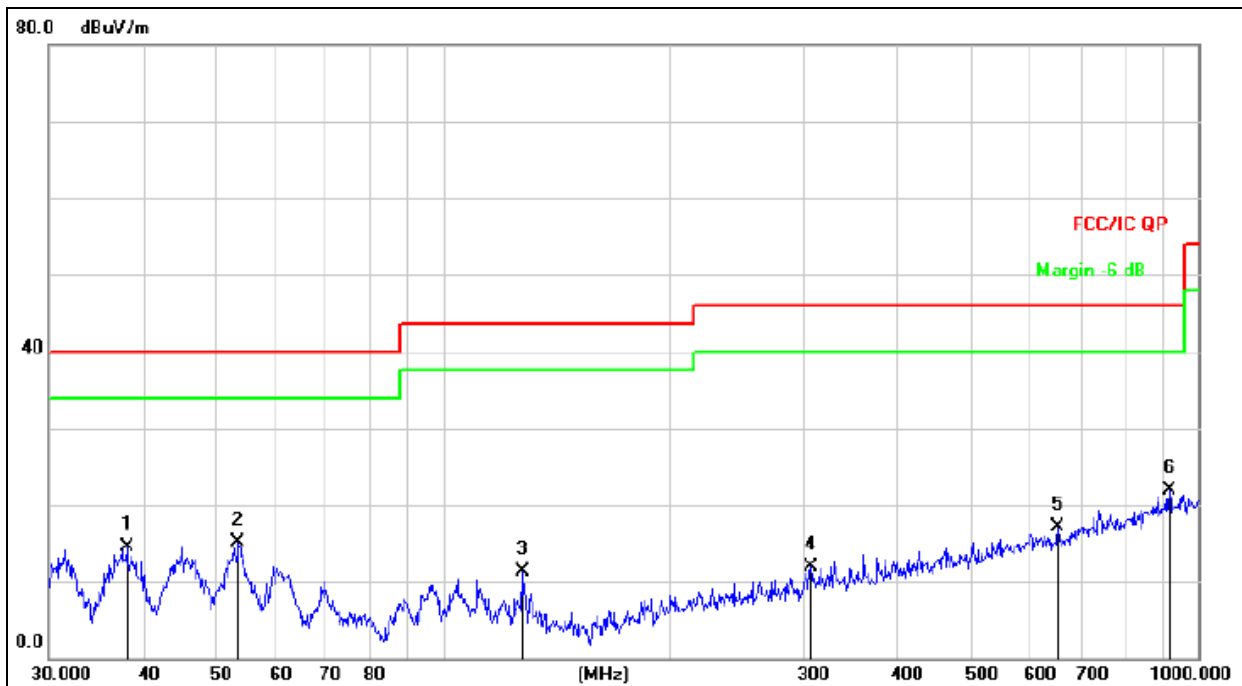

Remark:  
 Factor = Antenna Factor + Cable Loss – Pre-amplifier.

No.	Mk.	Freq.	Reading Level	Correct Factor	Measurement	Limit	Over	
		MHz	dBuV	dB	dBuV/m	dB/m	dB	Detector
1		38.0783	30.20	-15.77	14.43	40.00	-25.57	QP
2		53.5052	30.35	-15.22	15.13	40.00	-24.87	QP
3		127.2176	29.40	-18.03	11.37	43.50	-32.13	QP
4		306.7537	25.31	-13.41	11.90	46.00	-34.10	QP
5		651.9417	23.91	-6.75	17.16	46.00	-28.84	QP
6	*	916.0687	23.31	-1.37	21.94	46.00	-24.06	QP



Temperature :	25°C	Relative Humidity :	55%
Test Voltage :	DC 3.7V	Polarization :	Vertical
Test Mode :	Mode 4		

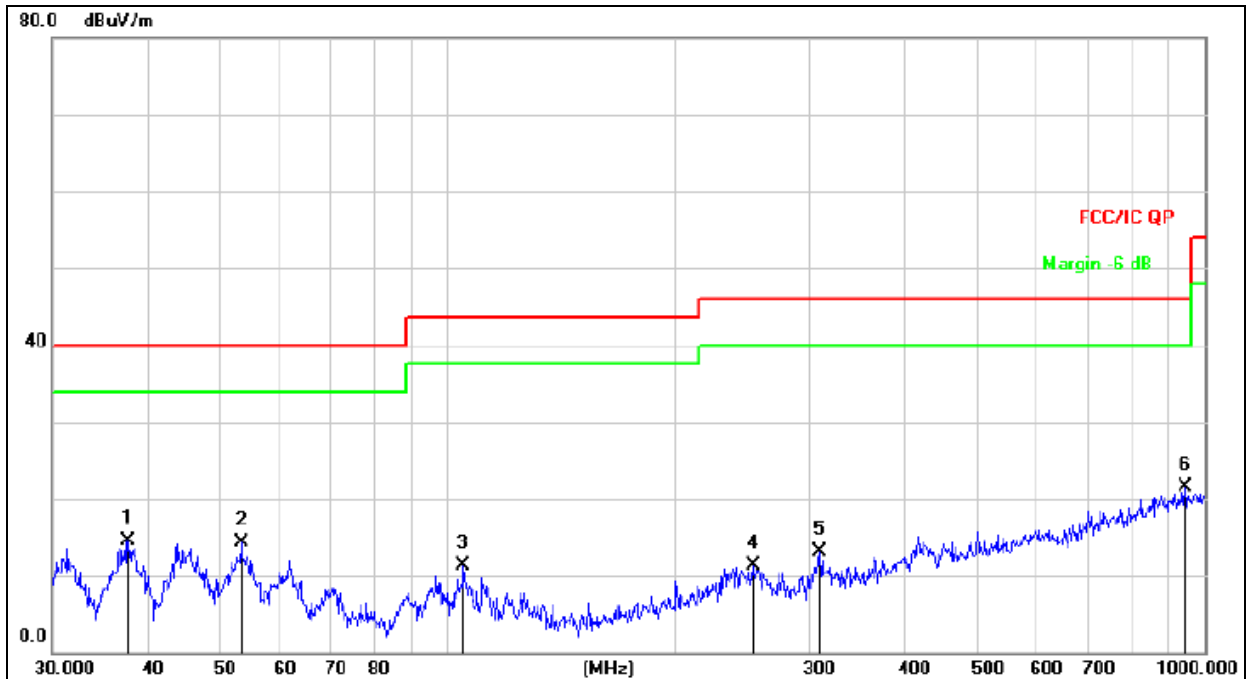

Remark:  
Factor = Antenna Factor + Cable Loss – Pre-amplifier.

No.	Mk.	Freq.	Reading Level	Correct Factor	Measurement	Limit	Over	Detector
		MHz	dBuV	dB	dBuV/m	dB/m	dB	
1		37.8121	30.39	-15.82	14.57	40.00	-25.43	QP
2		53.3179	29.48	-15.20	14.28	40.00	-25.72	QP
3		104.9033	27.81	-16.60	11.21	43.50	-32.29	QP
4		252.9482	26.38	-15.06	11.32	46.00	-34.68	QP
5		309.9977	26.44	-13.33	13.11	46.00	-32.89	QP
6	*	942.1305	22.65	-1.17	21.48	46.00	-24.52	QP

**3.2.8 TEST RESULTS (1GHZ~25GHZ)**
**GFSK**

Polar (H/V)	Frequency	Meter Reading	Pre-amplifier	Cable Loss	Antenna Factor	Emission Level	Limits	Margin	Detector Type
	(MHz)	(dBuV)	(dB)	(dB)	(dB)	(dBuV/m)	(dBuV/m)	(dB)	
<b>Low Channel:2402MHz</b>									
V	4804.00	58.95	39.55	7.77	25.66	52.83	74.00	-21.17	PK
V	4804.00	45.33	39.55	7.77	25.66	39.21	54.00	-14.79	AV
V	7206.00	51.51	38.33	7.3	24.55	45.03	74.00	-28.97	PK
V	7206.00	45.46	38.33	7.3	24.55	38.98	54.00	-15.02	AV
V	15450.00	41.19	35.23	6.6	26.59	39.15	74.00	-34.85	PK
H	4804.00	54.46	39.55	7.77	25.66	48.34	74.00	-25.66	PK
H	4804.00	41.09	39.55	7.77	25.66	34.97	54.00	-19.03	AV
H	7206.00	58.98	38.33	7.3	23.55	51.50	74.00	-22.50	PK
H	7206.00	47.92	38.33	7.3	23.22	40.11	54.00	-13.89	AV
H	15450.00	41.48	35.45	6.6	27.88	40.51	74.00	-33.49	PK

Polar (H/V)	Frequency	Meter Reading	Pre-amplifier	Cable Loss	Antenna Factor	Emission Level	Limits	Margin	Detector Type
	(MHz)	(dBuV)	(dB)	(dB)	(dB)	(dBuV/m)	(dBuV/m)	(dB)	
<b>Middle Channel:2440MHz</b>									
V	4880.00	57.84	38.89	7.57	25.45	51.97	74.00	-22.03	PK
V	4880.00	45.63	38.89	7.57	25.45	39.76	54.00	-14.24	AV
V	7320.00	52.96	38.78	7.35	24.78	46.31	74.00	-27.69	PK
V	7320.00	46.78	38.78	7.35	24.78	40.13	54.00	-13.87	AV
V	15450.00	42.13	35.89	6.42	26.47	39.13	74.00	-34.87	PK
H	4880.00	53.45	38.89	7.57	25.45	47.58	74.00	-26.42	PK
H	4880.00	40.98	38.89	7.57	25.45	35.11	54.00	-18.89	AV
H	7320.00	60.39	38.78	7.35	24.78	53.74	74.00	-20.26	PK
H	7320.00	49.11	38.78	7.35	24.78	42.46	54.00	-11.54	AV
H	15450.00	42.37	36.68	6.42	26.65	38.76	74.00	-35.24	PK

Polar (H/V)	Frequency	Meter Reading	Pre-amplifier	Cable Loss	Antenna Factor	Emission Level	Limits	Margin	Detector Type
	(MHz)	(dBuV)	(dB)	(dB)	(dB)	(dBuV/m)	(dBuV/m)	(dB)	
<b>High Channel: 2480MHz</b>									
V	4960.00	57.99	38.75	7.38	25.45	52.07	74.00	-21.93	PK
V	4960.00	46.31	38.75	7.38	25.45	40.39	54.00	-13.61	AV
V	7440.00	54.30	38.65	7.15	24.78	47.58	74.00	-26.42	PK
V	7440.00	47.99	38.65	7.15	24.78	41.27	54.00	-12.73	AV
V	15450.00	43.41	35.58	6.25	26.47	40.55	74.00	-33.45	PK
H	4960.00	54.82	38.75	7.38	25.45	48.90	74.00	-25.10	PK
H	4960.00	41.09	38.75	7.38	25.45	35.17	54.00	-18.83	AV
H	7440.00	59.14	38.65	7.15	24.78	52.42	74.00	-21.58	PK
H	7440.00	48.83	38.65	7.15	24.78	42.11	54.00	-11.89	AV
H	15450.00	41.72	36.42	6.25	26.65	38.20	74.00	-35.80	PK

Remark:

1. Emission Level = Meter Reading + Antenna Factor + Cable Loss – Pre-amplifier,

Margin= Emission Level - Limit

2. If peak below the average limit, the average emission was no test.

3. The amplitude of spurious emissions which are attenuated by more than 20dB below the permissible value has no need to be reported.

### 3.3 RADIATED BAND EMISSION MEASUREMENT

#### 3.3.1 TEST REQUIREMENT:

FCC Part15 C Section 15.209 and 15.205

LIMITS OF RADIATED EMISSION MEASUREMENT (Above 1000MHz)

FREQUENCY (MHz)	Limit (dBuV/m) (at 3M)	
	PEAK	AVERAGE
Above 1000	74	54

Notes:

- (1) The limit for radiated test was performed according to FCC PART 15C.
- (2) The tighter limit applies at the band edges.
- (3) Emission level (dBuV/m)=20log Emission level (uV/m).

Spectrum Parameter	Setting
Attenuation	Auto
Start Frequency	2300MHz
Stop Frequency	2520
RB / VB (emission in restricted band)	1 MHz / 1 MHz for Peak, 1 MHz / 10Hz for Average

#### 3.3.2 TEST PROCEDURE

Above 1GHz test procedure as below:

- a. 1. The EUT was placed on the top of a rotating table 1.5 meters above the ground at a 3 meter camber. The table was rotated 360 degrees to determine the position of the highest radiation.
- b. The EUT was set 3 meters away from the interference-receiving antenna, which was mounted on the top of a variable-height antenna tower.
- c. The antenna height is varied from one meter to four meters above the ground to determine the maximum value of the field strength. Both horizontal and vertical polarizations of the antenna are set to make the measurement.
- d. For each suspected emission, the EUT was arranged to its worst case and then the antenna was tuned to heights from 1 meter to 4 meters and the rota table was turned from 0 degrees to 360 degrees to find the maximum reading.
- e. The test-receiver system was set to Peak Detect Function and Specified Bandwidth with Maximum Hold Mode.
- f. If the emission level of the EUT in peak mode was 10dB lower than the limit specified, then testing could be stopped and the peak values of the EUT would be reported. Otherwise the emissions that did not have 10dB margin would be re-tested one by one using peak, quasi-peak or average method as specified and then reported in a data sheet.
- g. Test the EUT in the lowest channel, the Highest channel

Note:

Both horizontal and vertical antenna polarities were tested and performed pretest to three orthogonal axis. The worst case emissions were reported

### 3.3.3 DEVIATION FROM TEST STANDARD

No deviation

### 3.3.4 TEST SETUP

Radiated Emission Test-Up Frequency Above 1GHz

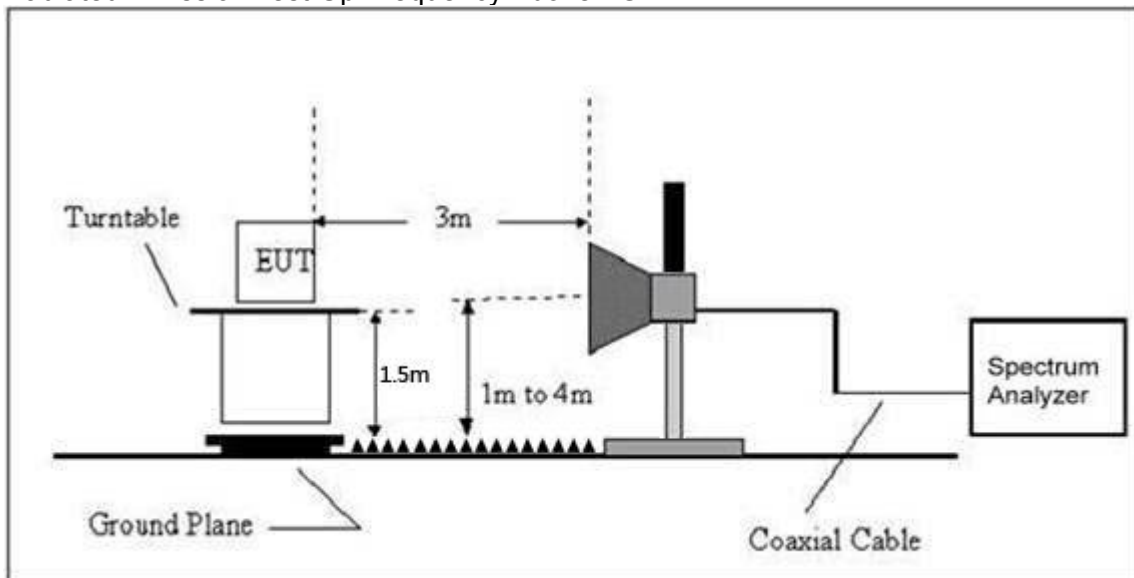

### 3.3.5 EUT OPERATING CONDITIONS

The EUT tested system was configured as the statements of 2.3 Unless otherwise a special operating condition is specified in the follows during the testing.





3.3.6 TEST RESULT

	Polar (H/V)	Frequency (MHz)	Meter Reading (dBuV)	Pre-amplifier (dB)	Cable Loss (dB)	Antenna Factor (dB/m)	Emission level (dBuV/m)	Limits (dBuV/m)		Result
							PK	PK	AV	
GFSK	<b>Low Channel 2402MHz</b>									
	H	2390.00	55.17	38.06	7.42	20.15	44.68	74.00	54.00	PASS
	H	2400.00	55.13	38.06	7.42	20.15	44.64	74.00	54.00	PASS
	V	2390.00	51.91	38.06	7.42	20.15	41.42	74.00	54.00	PASS
	V	2400.00	54.93	38.06	7.42	20.15	44.44	74.00	54.00	PASS
	<b>High Channel 2480MHz</b>									
	H	2483.50	52.00	38.17	7.45	20.54	41.82	74.00	54.00	PASS
	H	2485.50	54.66	38.17	7.45	20.54	44.48	74.00	54.00	PASS
	V	2483.50	52.30	38.2	7.45	20.54	42.09	74.00	54.00	PASS
	V	2485.50	53.00	38.2	7.45	20.54	42.79	74.00	54.00	PASS
<b>Remark:</b>										
1. Emission Level = Meter Reading + Antenna Factor + Cable Loss – Pre-amplifier, Margin= Emission Level - Limit										
2. If the PK measured levels comply with average limit, then the average level were deemed to comply with average limit.										

## 4. POWER SPECTRAL DENSITY TEST

### 4.1 APPLIED PROCEDURES / LIMIT

FCC Part15 (15.247) , Subpart C				
Section	Test Item	Limit	Frequency Range (MHz)	Result
15.247	Power Spectral Density	8 dBm (in any 3KHz)	2400-2483.5	PASS

#### 4.1.1 TEST PROCEDURE

1. Set analyzer center frequency to DTS channel center frequency.
2. Set the span to 1.5 times the DTS bandwidth.
3. Set the RBW to:  $3 \text{ kHz} \leq \text{RBW} \leq 100 \text{ kHz}$ .
4. Set the VBW  $\geq 3 \times \text{RBW}$ .
5. Detector = peak.
6. Sweep time = auto couple.
7. Trace mode = max hold.
8. Allow trace to fully stabilize.
9. Use the peak marker function to determine the maximum amplitude level within the RBW.
10. If measured value exceeds limit, reduce RBW (no less than 3 kHz) and repeat.

#### 4.1.2 DEVIATION FROM STANDARD

No deviation.

#### 4.1.3 TEST SETUP



#### 4.1.4 EUT OPERATION CONDITIONS

The EUT tested system was configured as the statements of 2.1 Unless otherwise a special operating condition is specified in the follows during the testing.

Note: Power Spectral Density(dBm)=Reading+Cable Loss

#### 4.1.5 TEST RESULTS

Temperature :	25°C	Relative Humidity :	55%
Test Mode :	GFSK	Test Voltage :	DC 3.7V

Frequency	Power Spectral Density(dBm)	Limit (dBm)	Result
2402 MHz	-20.057	8	PASS
2440 MHz	-19.546	8	PASS
2480 MHz	-19.187	8	PASS

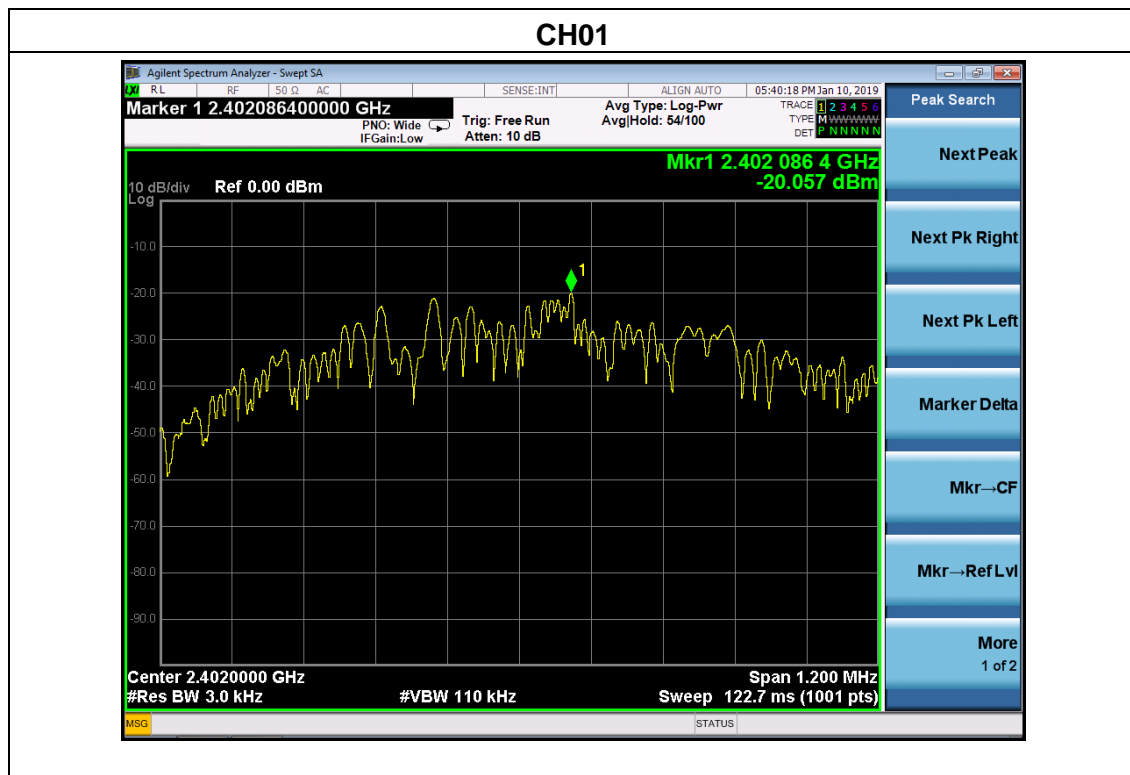



### CH20



### CH40

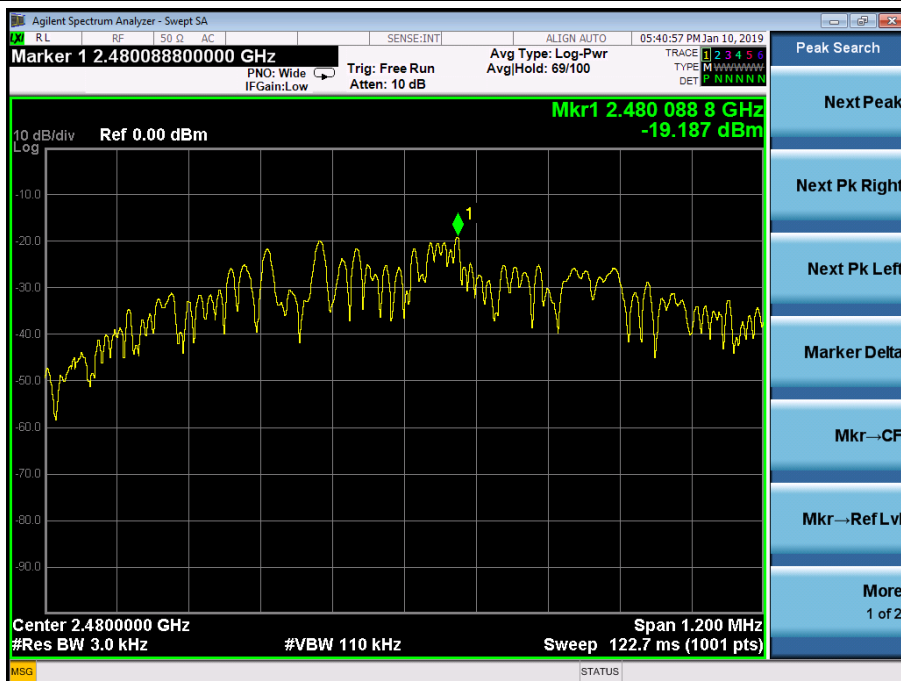

## 5. BANDWIDTH TEST

### 5.1 APPLIED PROCEDURES / LIMIT

FCC Part15 (15.247) , Subpart C				
Section	Test Item	Limit	Frequency Range (MHz)	Result
15.247(a)(2)	Bandwidth	$\geq 500\text{KHz}$ (6dB bandwidth)	2400-2483.5	PASS

#### 5.1.1 TEST PROCEDURE

1. Set RBW = 100 kHz.
2. Set the video bandwidth (VBW)  $\geq 3 \times$  RBW.
3. Detector = Peak.
4. Trace mode = max hold.
5. Sweep = auto couple.
6. Allow the trace to stabilize.
7. Measure the maximum width of the emission that is constrained by the frequencies associated with the two outermost amplitude points (upper and lower frequencies) that are attenuated by 6 dB relative to the maximum level measured in the fundamental emission.

#### 5.1.2 DEVIATION FROM STANDARD

No deviation.

#### 5.1.3 TEST SETUP

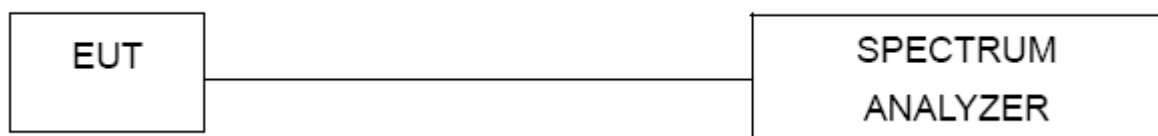

#### 5.1.4 EUT OPERATION CONDITIONS

The EUT tested system was configured as the statements of 2.4 Unless otherwise a special operating condition is specified in the follows during the testing.

**5.1.5 TEST RESULTS**

Temperature :	25°C	Relative Humidity :	55%
Test Mode :	GFSK	Test Voltage :	DC 3.7V

Frequency (MHz)	6dB bandwidth (MHz)	Limit (kHz)	Result
2402	0.692	500	Pass
2440	0.693	500	Pass
2480	0.691	500	Pass

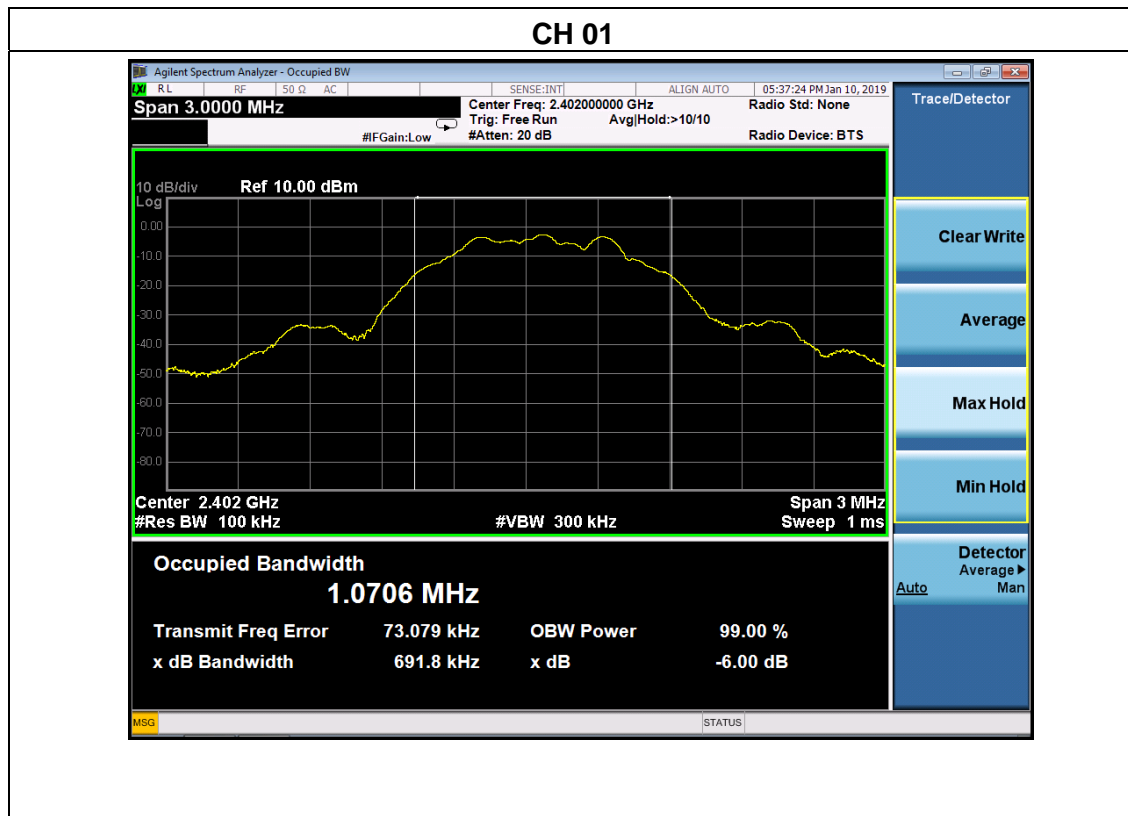



### CH20

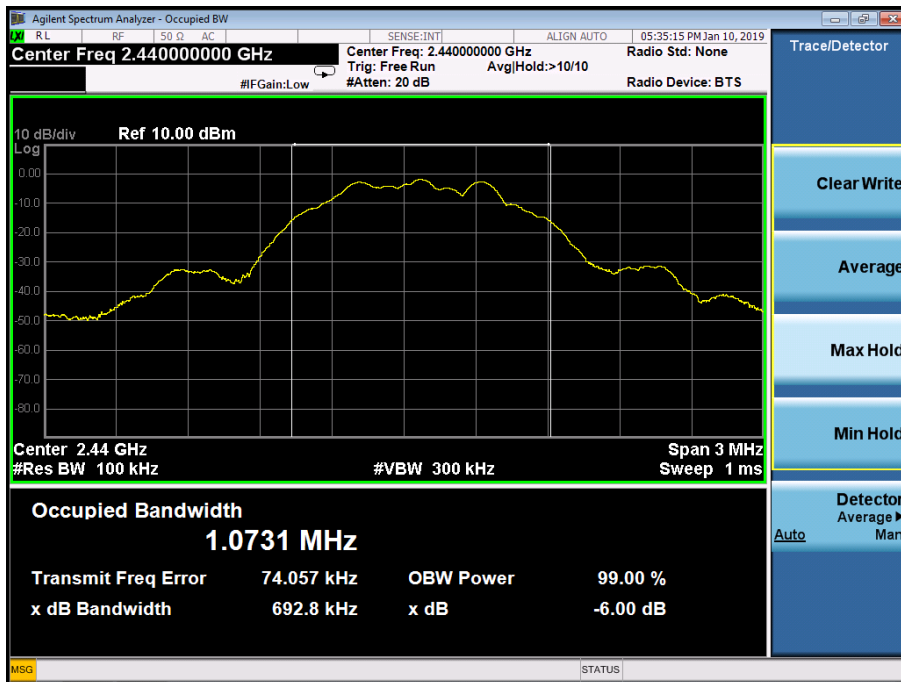

### CH40

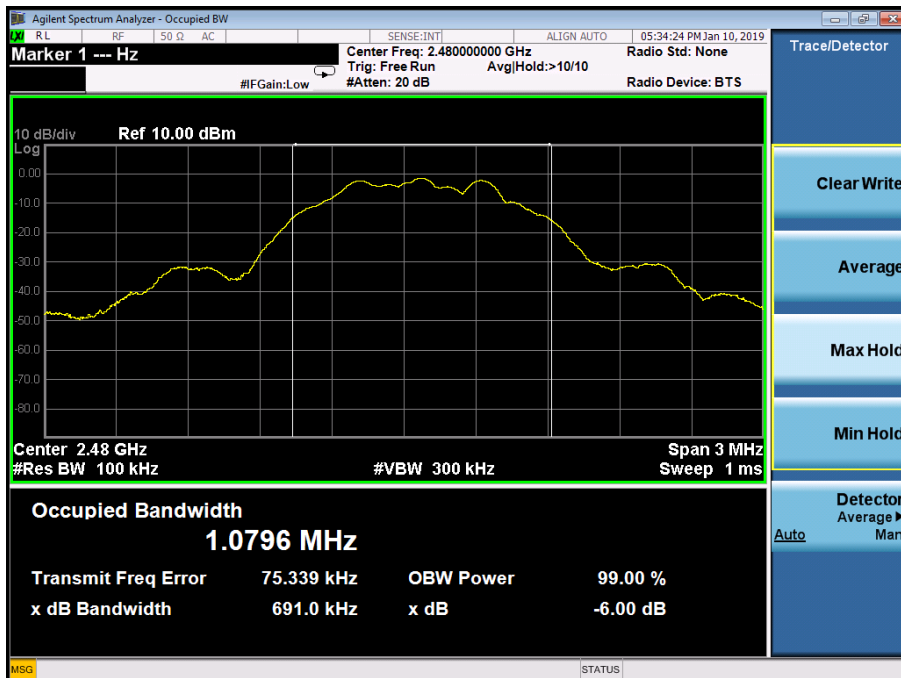

## 6. PEAK OUTPUT POWER TEST

### 6.1 APPLIED PROCEDURES / LIMIT

FCC Part15 (15.247) , Subpart C				
Section	Test Item	Limit	Frequency Range (MHz)	Result
15.247(b)(3)	Peak Output Power	1 watt or 30dBm	2400-2483.5	PASS

#### 6.1.1 TEST PROCEDURE

- a. The EUT was directly connected to the Power meter

#### 6.1.2 DEVIATION FROM STANDARD

No deviation.

#### 6.1.3 TEST SETUP



#### 6.1.4 EUT OPERATION CONDITIONS

The EUT tested system was configured as the statements of 2.4 Unless otherwise a special operating condition is specified in the follows during the testing.





### 6.1.5 TEST RESULTS

Temperature :	25°C	Relative Humidity :	55%
Test Voltage :	DC 3.7V		

	Frequency	Maximum Conducted Output Power(PK)	Conducted Output Power Limit
	(MHz)	(dBm)	dBm
GFSK	2402	-2.58	30
	2440	-1.93	30
	2480	-1.46	30

## 7. 100 KHZ BANDWIDTH OF FREQUENCY BAND EDGE

### 7.1 APPLICABLE STANDARD

In any 100 kHz bandwidth outside the frequency band in which the spread spectrum intentional radiator is operating, the radio frequency power that is produced by the intentional radiator shall be at least 20 dB below that in the 100 kHz bandwidth within the band that contains the highest level of the desired power, based on either an RF conducted or a radiated measurement.

### 7.2 TEST PROCEDURE

Using the following spectrum analyzer setting:

- a) Set the RBW = 100KHz.
- b) Set the VBW = 300KHz.
- c) Sweep time = auto couple.
- d) Detector function = peak.
- e) Trace mode = max hold.
- f) Allow trace to fully stabilize.

### 7.3 DEVIATION FROM STANDARD

No deviation.

### 7.4 TEST SETUP



### 7.5 EUT OPERATION CONDITIONS

The EUT tested system was configured as the statements of 2.4 Unless otherwise a special operating condition is specified in the follows during the testing.

### 7.6 TEST RESULTS



GFSK: Band Edge, Left Side

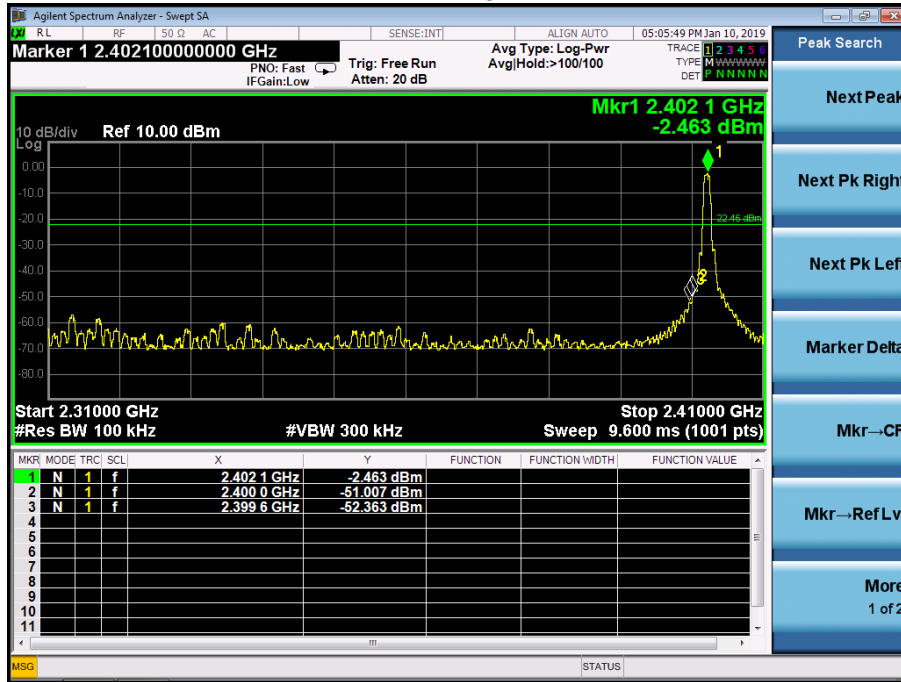

GFSK: Band Edge, Right Side

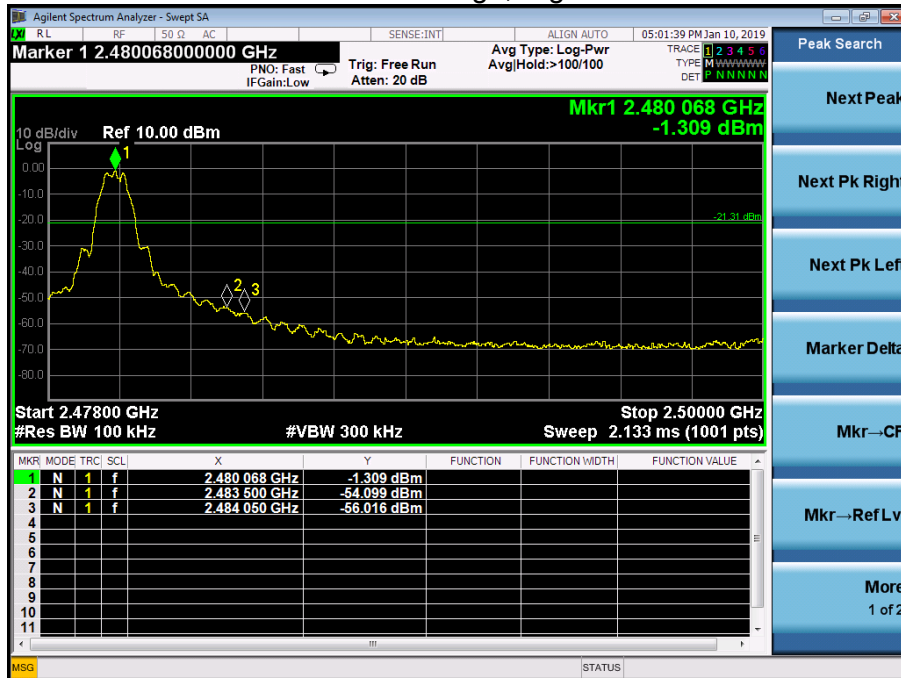



### CONDUCTED EMISSION MEASUREMENT

GFSK

Low Channel 2402MHz

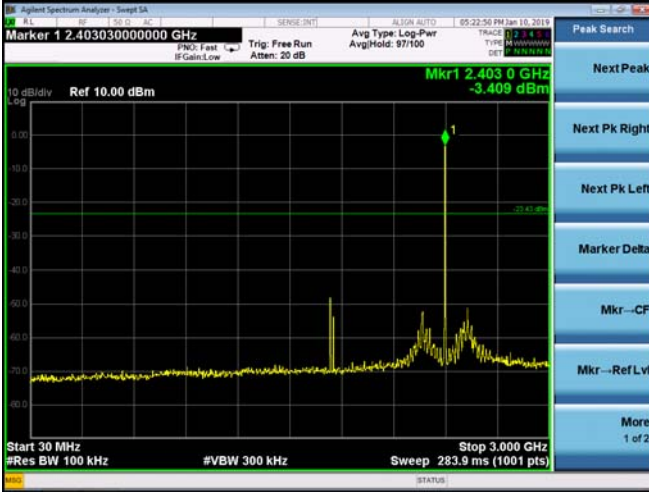

Middle Channel 2440MHz

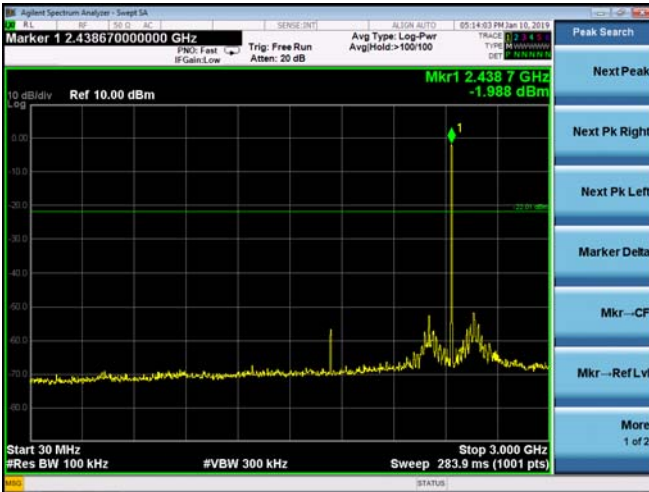

High Channel 2480MHz

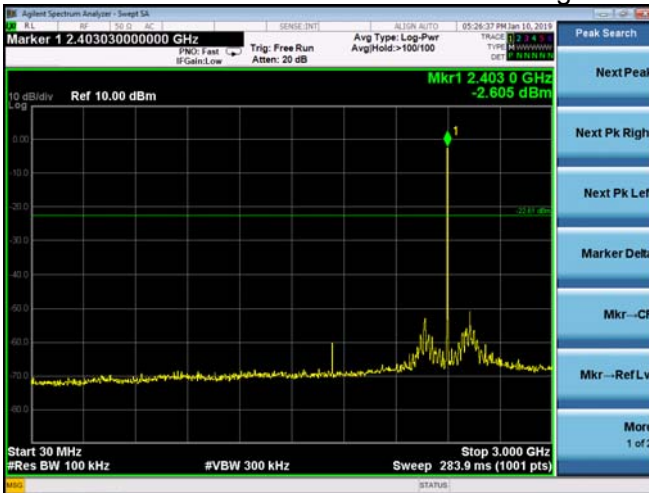



## 8. ANTENNA REQUIREMENT

### 8.1 STANDARD REQUIREMENT

15.203 requirement: For intentional device, according to 15.203: an intentional radiator shall be designed to ensure that no antenna other than that furnished by the responsible party shall be used with the device.

### 8.2 EUT ANTENNA

The EUT antenna is Internal antenna, fulfill the requirement of this section.



## 9. EUT TEST PHOTO

### Conducted emissions





### Radiated Measurement Photos

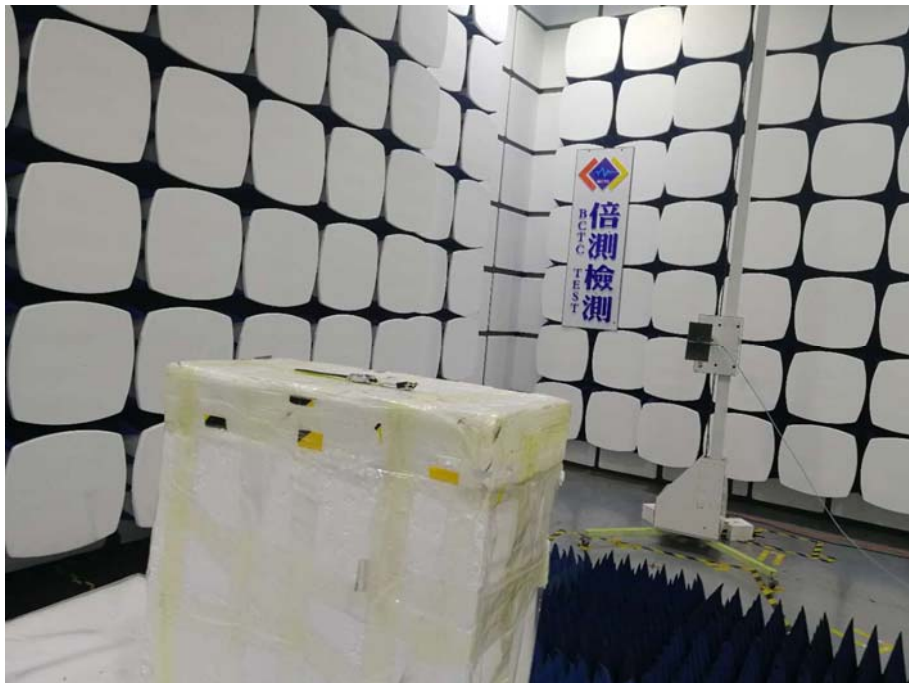



## 10. EUT PHOTO

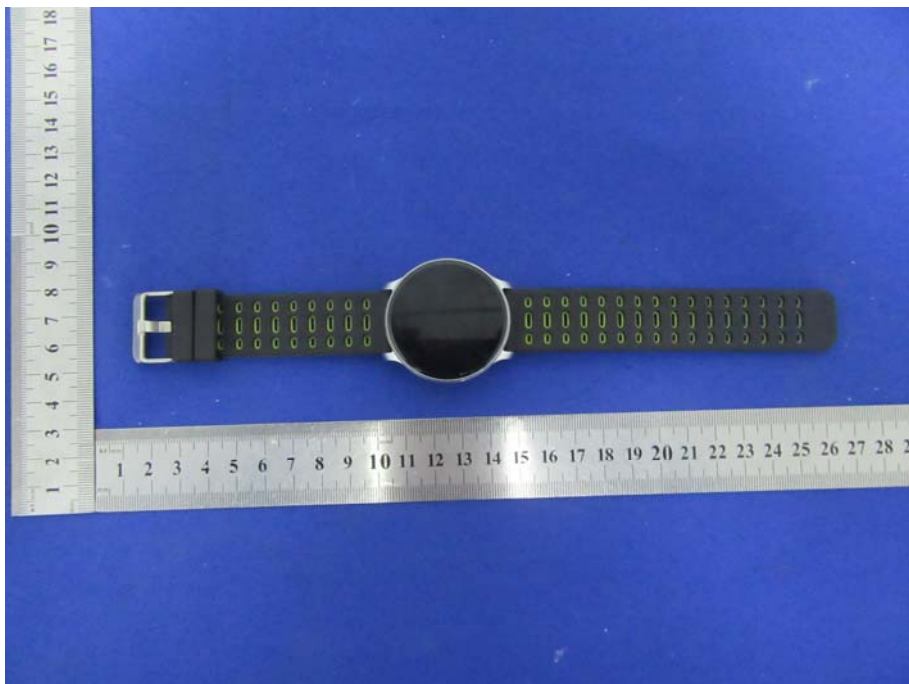





\*\*\*\*\* END OF REPORT \*\*\*\*\*