

INSTRUCTIONS

Smart Dimmer Light Switch

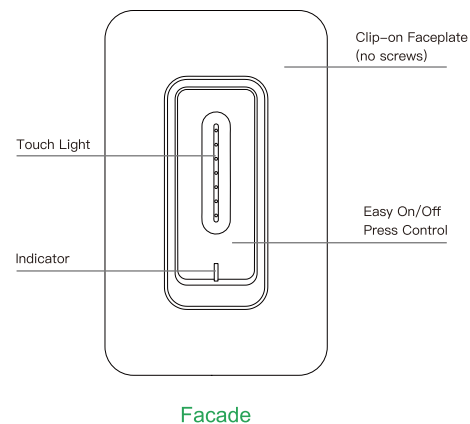

Product description



Requirements

- Neutral wire required
 - Replaces single pole switch only.
 - Not compatible with 3-way (multi-location control) switches
- Note1: If you're not familiar with basic electrical work, please don't install switch by yourself, and call a professional electrician to help you.
- Note2: Do not try to do it without neutral wires and be careful not

to reverse the live and load wires; otherwise, nothing will work. Note3: If you really can't find out a Neutral Line in your Powerline socket, please contact professional electrician to reform your socket powerline, or you can't install our WT03S.

For a better connection, we recommend you don't forget to twine wire nuts to make sure the copper conductors fully concealed.

Installation

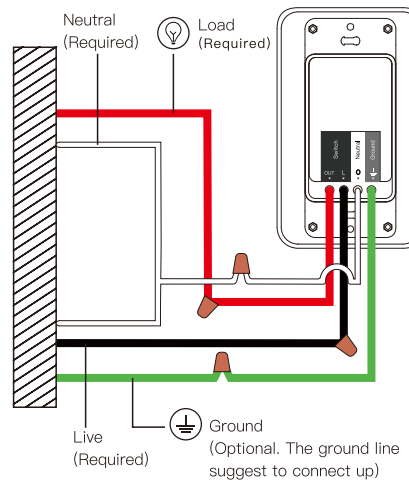

Product Features

- Works with Amazon Alexa, commanded by your voice.
- You can simply turn it on/off by directly pressing.
- Control your home with your smartphones app or tablets from anywhere at anytime.
- Timing switch to turn ON/OFF your lights and appliances automatically.
- Refined appearance and made of fire resistant material, safe and Durable.
- The Smart Switch blends well with any room décor with its elegant and minimal design.
- Dim your home lighting by utilizing the touch sensitive dimmer slider bar.

Specifications

Type	Smart Dimmer Light Switch
Model	WT03S
Rated Current	3A
Rated Voltage	120V/60HZ
Rated Power	400W
Wireless Frequency	2.4GHZ
Wireless Standard	IEEE802.11 b/g/n
Max Output	400W INC
	150W CFL
	150W LED

1. Add device

1.1 Download Smart Life APP



Please scan the QR Code, or get Smart Life to download on App Store or Google play.

1.2 Download & Registration

- Scan the QR code to download " Smart Life " Application
- Enter the register/login interface, input the phone number for getting verification code to register .

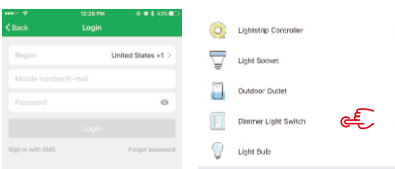

1.3 Easy Mode(Recommend)

Preparation: Device has connected with electricity, long press on/off button for 5 seconds until red indicator light quickly flashes, the application already shows "My Device" interface.

- Phone has connected to Wifi router and been able to connect to Internet.
- Tap the icon "+" on the top right corner of "My Device", choose your device type, enter into "Add Device"
- Make sure the red indicator light is flashing quickly, then tap the related button in application.
- Choose the local Wifi and enter the correct password, tap "Next".
- Wait for configuring successfully, then tap "Complete".

Attention: there is no Internet connected while the red light flashing slowly.

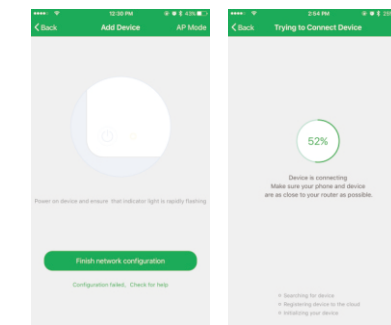

2. Set your Echo speaker by Alexa APP

1. If have you finished to install " Smart Life " App", then open your Amazon alexa App and sign in your Alexa account and type password.
2. Click the menu on the left corner - click "settings", choose "set up a new device"(choose a device, like Echo) P.S.When the below page appears, long press the small dot on your Echo device until the light turns to yellow. Then click Continue on App.

Attention: at this moment, the mobile phone can not open a variety of VPN software.

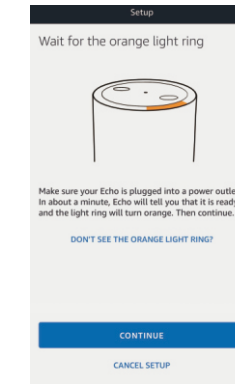

3. Choose your own wifi and wait for a few minutes. After an introduction video, click next step, it will go to Home page automatically. Now the Echo is connected to Wi-Fi successfully.

3. Enable Smart Life skill in Alexa APP

Choose "Skills" in the options bar, and then search " Smart Life " in the input box.

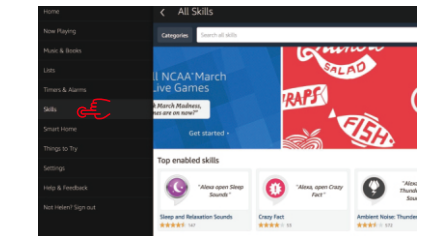

Select Smart Life in the search results, and then click "Enable Skill".

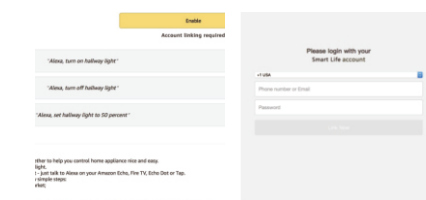

Then input the user name and password of Smart Life App that you had previously registered. Only support the account in the United States.

4.Control the Dimmer Switch by Voice

After complete the above operations, you can control the Dimmer Switch via Echo.

4.1 Discover devices

Firstly, you need to speak to Echo: Echo(or Alexa), discover my devices.

Echo will start to find the devices that has added in Smart Life APP, which will take about 20 seconds, then it will tell you the result.

You can also click "Discover devices" in Alexa APP, then it will show the devices that found successfully.

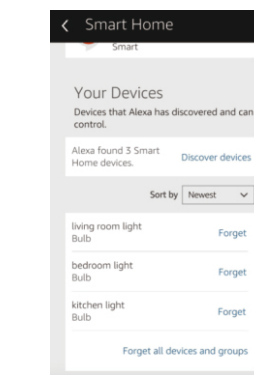

4.2 Control devices by voice

Attention: The name of the device must be consistent with the addition of Smart Life app.

You can also group the Smart Switch and give instructions to control them together.

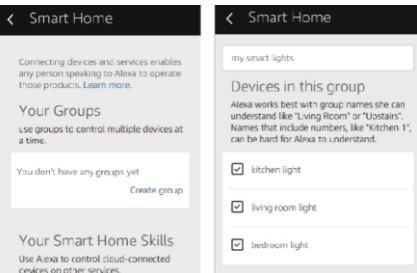

Attention: Echo is one of the wake-up names, which can be any of these three names(Settings): Alexa, Echo, Amazon

4.3 Support Skill list

You can control devices by instructions like these:

-) Alexa(or echo), turn on the Smart Switch
 -) Alexa(or echo), turn off the Smart Switch
 -) Alexa(or Echo), set light switch brightness to 50 percent.
 -) Alexa(or Echo), increase light switch brightness to 50 percent.
 -) Alexa(or Echo), decrease light switch brightness to 50 percent.
- P.S Device can be renamed with a simple name that you remember it easily.

5. Google Assistant - Activate Smart Life in Google Home App

5.1 Preparation:

- Have downloaded the Google Home app – Compatible with Android (4.2 and higher) or IOS (8.0 and higher) smartphones or tablet.
- Have registered your Google Account (only support US account).
- Have paired Smart Switch with Smart Life APP and named it with simply and easily recognizable name.
- Have finished setting up Google Home

Step 1.

Open Google Home App, tap "≡" in upper left corner, select "More settings" to go into next interface.

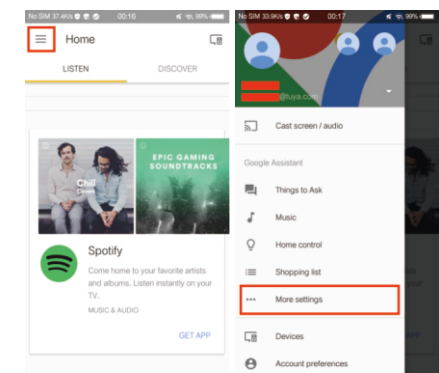

Step 2.

Choose "Services" in the options bar and select "Smart Life" to enter the next interface.

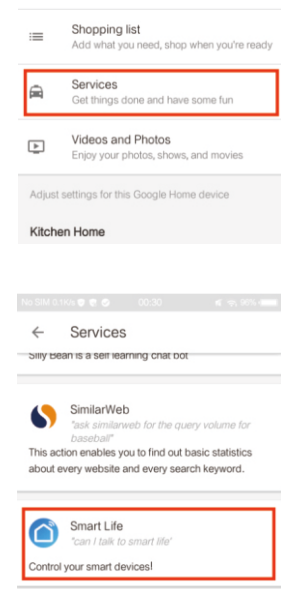

Step 3.

Tap "LINK ACCOUNT", then sign in your Smart Life account. (Only support US account)

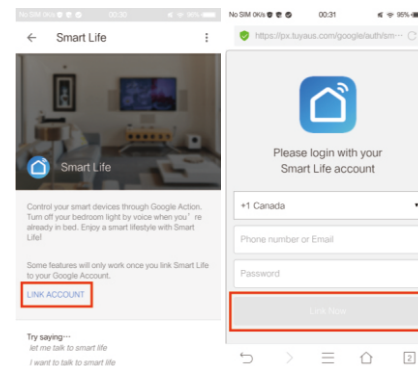

Step 4.

Tap "Link Now". After your Smart Life account has linked to Google Assistant, the smart devices will automatically appear.

5.2 Command the Device through Your Voice

After complete the above operations, you can control the device via Google Home. Firstly, you need to say "Ok Google, talk to Smart Life" to wake up the Smart Life. Then you can control devices by instructions like these:

-) Turn on Smart Switch
-) Turn off Smart Switch

Attention: after Smart Life has been waken up, you can say "Cancel" or "Stop" to exit Smart Life or say "nothing" when you hear "What can I do for you". Then says again " Ok Google, talk to Smart Life " to start voice control.

6. IFTTT - Setup and Usage

Get Started: How to connect Smart product to IFTTT?

Step 1.

Visit the IFTTT official website on your PC and sign in with your IFTTT account.

Note: You can also use IFTTT app and follow similar steps to connect your device to the IFTTT. In this FAQ we take the website setting method for example.

Step 2.

"Search" for "Smart Life", and then click "Smart Life" service.

Step 3.

Click "Connect", then login your Smart Life ID and then tap "Link Now".

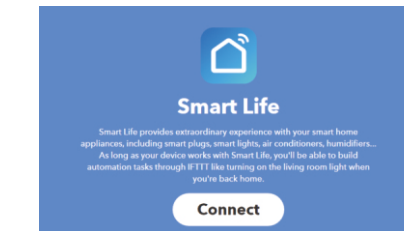

Step 4.

Successfully connect your IFTTT account to your Smart Life ID. You are ready to enjoy the IFTTT service of products now.

Instructions: 2 methods to use IFTTT with Smart products.

Method 1: On Smart Life service page, choose an existing Applet you need, turn on it and then finish the configuration.

Method 2: Create a new Applet on your own. Click "My Applets" at the top and then click "New Applet" at the right top corner of the webpage to create a new Applet.

Step 1. Create a Trigger.

Tap "this" to choose a Trigger. You can search for "Weather Underground" to choose a Trigger.

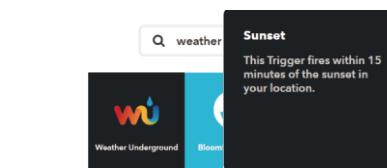

We select "Sunset" as the Trigger.

Step 2. Create an Action.

Tap "that" to choose an Action. You can search for "smart life" to choose a Smart Life Action.



We select "Turn on" of Light Switch as the Action in this case.

Step 3.

New Applet "If sunset, then turn on Light Switch" is created as a result.

Note: The Smart Life service can only works when create an action. You can't use the "Smart Life" as a Trigger.

FCC Caution:

Any Changes or modifications not expressly approved by the party responsible for compliance could void the user's authority to operate the equipment.

This device complies with part 15 of the FCC Rules. Operation is subject to the following two conditions: (1) This device may not cause harmful interference, and (2) this device must accept any interference received, including interference that may cause undesired operation.

Note: This equipment has been tested and found to comply with the limits for a Class B digital device, pursuant to part 15 of the FCC Rules. These limits are designed to provide reasonable protection against harmful interference in a residential installation. This equipment generates, uses and can radiate radio frequency energy and, if not installed and used in accordance with the instructions, may cause harmful interference to radio communications. However, there is no guarantee that interference will not occur in a particular installation. If this equipment does cause harmful interference to radio or television reception, which can be determined by turning the equipment off and on, the user is encouraged to try to correct the interference by one or more of the following measures:

-Reorient or relocate the receiving antenna.

-Increase the separation between the equipment and receiver.

-Connect the equipment into an outlet on a circuit different from that to which the receiver is connected.

-Consult the dealer or an experienced radio/TV technician for help.

FCC Radiation Exposure Statement:

This equipment complies with FCC radiation exposure limits set forth for an uncontrolled environment. This equipment should be installed and operated with minimum distance 20cm between the radiator & your body.