

FCC RADIO TEST REPORT

FCC ID: 2ANIE-V3SA

Sample : Smart Watch

Trade Mark : FITUP,WoFit,cavo,CAVOSMART

Main Model : V3SA

Additional Model : V3B, V30B, V36, V5, V50, V5S, V50S, V3SB

Report No. : 23061516ER-62

Prepared for

WO-SMART TECHNOLOGIES(SHENZHEN)CO.,LTD

2C, AB Block, Tianji Building, Tian'an Cyber Park, Chegongmiao,
Futian District, Shenzhen, China

Prepared by

Global United Technology Services Co. Ltd.

No. 123-128, Tower A, Jinyuan Business Building, No.2, Laodong Industrial
Zone, Xixiang Road, Baoan District, Shenzhen, Guangdong, China 518102

TEST RESULT CERTIFICATION

Applicant : WO-SMART TECHNOLOGIES(SHENZHEN)CO.,LTD
 Address : 2C, AB Block, Tianji Building, Tian'an Cyber Park, Chegongmiao, Futian District, Shenzhen, China
Manufacturer : WO-SMART TECHNOLOGIES(SHENZHEN)CO.,LTD
 Address : 2C, AB Block, Tianji Building, Tian'an Cyber Park, Chegongmiao, Futian District, Shenzhen, China

Product description

Product..... : Smart Watch
 Trade Mark : FITUP,WoFit,cavo,CAVOSMART
 Model Name : V3SA, V3B, V30B, V36, V5, V50, V5S, V50S, V3SB

Test Methods..... : FCC Rules and Regulations Part 15 Subpart C Section 15.249, ANSI C63.10: 2013

This device described above has been tested by Global United Technology Services Co. Ltd., and the test results show that the equipment under test (EUT) is in compliance with the FCC requirements. And it is applicable only to the tested sample identified in the report. This report shall not be reproduced except in full, without the written approval of UNI, this document may be altered or revised by Global United Technology Services Co. Ltd., personnel only, and shall be noted in the revision of the document.

Date of Test

Date (s) of performance of tests..... : Jun. 16, 2023 ~ Jun. 26, 2023
 Date of Issue..... : Jul. 13, 2023
 Test Result..... : Pass



Prepared By:	 <hr/> Project Engineer	Date:	<hr/> 2023-7-13
Check By:	 <hr/> Reviewer	Date:	<hr/> 2023-7-13

Table of Contents	Pages
1 TEST SUMMARY	4
1.1 TEST PROCEDURES AND RESULTS	4
1.2 TEST FACILITY	5
1.3 MEASUREMENT UNCERTAINTY	6
1.4 ENVIRONMENTAL CONDITIONS	6
2 GENERAL INFORMATION	7
2.1 GENERAL DESCRIPTION OF EUT	7
2.2 CARRIER FREQUENCY OF CHANNELS	8
2.3 DESCRIPTION OF TEST MODES	8
2.4 TEST SETUP	8
2.5 EQUIPMENT USED IN TESTED SYSTEM	9
2.6 MEASUREMENT INSTRUMENTS LIST	10
3 CONDUCTED EMISSION	13
3.1 TEST LIMIT	13
3.2 TEST SETUP	13
3.3 TEST PROCEDURE	14
3.4 TEST RESULT	14
4 RADIATED EMISSION	17
4.1 TEST LIMIT	17
4.2 TEST SETUP	18
4.3 TEST PROCEDURE	19
4.4 TEST RESULT	19
5 BAND EDGE	29
5.1 TEST LIMIT	29
5.2 TEST SETUP	29
5.3 MEASUREMENT EQUIPMENT USED	29
5.4 TEST PROCEDURE	29
5.5 TEST RESULT	29
6 20dB Bandwidth	34
6.1 TEST SETUP (BLOCK DIAGRAM OF CONFIGURATION)	34
6.2 MEASUREMENT EQUIPMENT USED	34
6.3 TEST PROCEDURE	34
6.4 TEST RESULT	34
7 ANTENNA REQUIREMENT	39
8 PHOTO OF TEST	40

1 TEST SUMMARY

1.1 TEST PROCEDURES AND RESULTS

Item	FCC Rules	Description Of Test	Result
1	FCC Part 15.207	Conducted Emission	Pass
2	FCC Part 15.209/15.249	Radiated Emission	Pass
3	FCC Part 15.249/15.205	Band Edge	Pass
4	FCC Part 15.215	20dB Bandwidth	Pass
5	FCC Part 15.203	Antenna Requirement	Pass

Note:

“N/A” denotes test is not applicable in this Test Report.

1.2 TEST FACILITY

Test Firm : Global United Technology Services Co. Ltd.
Address : No. 123-128, Tower A, Jinyuan Business Building, No.2, Laodong Industrial Zone, Xixiang Road, Baoan District, Shenzhen, Guangdong, China 518102

The test facility is recognized, certified, or accredited by the following organizations:

- **FCC—Registration No.: 381383**

Designation Number: CN5029

Global United Technology Services Co., Ltd., Shenzhen EMC Laboratory has been registered and fully

described in a report filed with the (FCC) Federal Communications Commission. The acceptance letter

from the FCC is maintained in files.

- **IC —Registration No.: 9079A**

CAB identifier: CN0091

The 3m Semi-anechoic chamber of Global United Technology Services Co., Ltd. has been registered

by Certification and Engineering Bureau of Industry Canada for radio equipment testing

- **NVLAP (LAB CODE:600179-0)**

Global United Technology Services Co., Ltd., is accredited by the National Voluntary Laboratory Accreditation Program (NVLAP).

1.3 MEASUREMENT UNCERTAINTY

The reported uncertainty of measurement $y \pm U$, where expanded uncertainty U is based on a standard uncertainty multiplied by a coverage factor of $k=2$, providing a level of confidence of approximately 95 %.

A. Conducted Measurement:

Test Site	Method	Measurement Frequency Range	U, (dB)	NOTE
UNI	ANSI	9kHz ~ 150kHz	2.96	
		150kHz ~ 30MHz	2.44	

B. Radiated Measurement:

Test Site	Method	Measurement Frequency Range	U, (dB)	NOTE
UNI	ANSI	9kHz ~ 30MHz	2.50	
		30MHz ~ 1000MHz	4.80	
		Above 1000MHz	4.13	

C. RF Conducted Method:

Item	Measurement Uncertainty
Uncertainty of total RF power, conducted	$U_c = \pm 0.8$ dB
Uncertainty of RF power density, conducted	$U_c = \pm 2.6$ dB
Uncertainty of spurious emissions, conducted	$U_c = \pm 2$ %
Uncertainty of Occupied Channel Bandwidth	$U_c = \pm 2$ %

1.4 ENVIRONMENTAL CONDITIONS

During the measurement the environmental conditions were within the listed ranges:

	NORMAL CONDITIONS	EXTREME CONDITIONS
Temperature range (°C)	15 - 35	-20 - 50
Relative humidity range	20 % - 75 %	20 % - 75 %
Pressure range (kPa)	86 - 106	86 - 106
Note: The Extreme Temperature and Extreme Voltages declared by the manufacturer.		

2 GENERAL INFORMATION

2.1 GENERAL DESCRIPTION OF EUT

Product:	Smart Watch
Trade Mark:	FITUP,WoFit,cavo,CAVOSMART
Main Model:	V3SA
Additional Model:	V3B, V30B, V36, V5, V50, V5S, V50S, V3SB
Model Difference:	All model's the function, software and electric circuit are the same, only with a product color and model named different. Test sample model: V3SA.
FCC ID:	2ANIE-V3SA
Operation Frequency:	2402MHz~2480MHz
Number of Channels:	40CH
Field Strength of Fundamental:	BLE 1M: 95.76dBuV/m BLE 2M: 95.73dBuV/m
Modulation Type:	GFSK
Antenna Type:	Internal Antenna
Antenna Gain:	-1dBi
Battery:	DC 3.7V, 250mAh
Adapter:	N/A
Power Source:	DC 5.0V from adapter or DC 3.7V from Li-battery

2.2 CARRIER FREQUENCY OF CHANNELS

Channel List							
Channel	Frequency (MHz)	Channel	Frequency (MHz)	Channel	Frequency (MHz)	Channel	Frequency (MHz)
00	2402	10	2422	20	2442	30	2462
01	2404	11	2424	21	2444	31	2464
02	2406	12	2426	22	2446	32	2466
03	2408	13	2428	23	2448	33	2468
04	2410	14	2430	24	2450	34	2470
05	2412	15	2432	25	2452	35	2472
06	2414	16	2434	26	2454	36	2474
07	2416	17	2436	27	2456	37	2476
08	2418	18	2438	28	2458	38	2478
09	2420	19	2440	29	2460	39	2480

2.3 DESCRIPTION OF TEST MODES

No.	Test Mode Description
1	Low channel TX
2	Middle channel TX
3	High channel TX

Note: 1. For Radiated Emission, 3axis were chosen for testing for each applicable mode.
2.For Conducted Test method,at emporary antenna connector is provided by the manufacture.

2.4 TEST SETUP

Operation of EUT during Radiation testing:

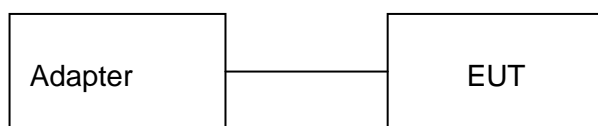

Operation of EUT during RF Conducted testing:

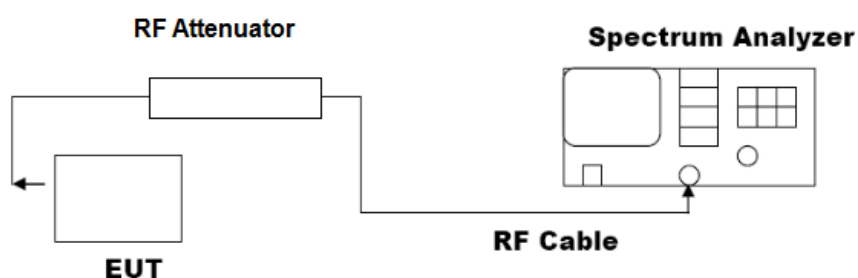

2.5 EQUIPMENT USED IN TESTED SYSTEM

Item	Equipment	Model No.	Cable Length(cm)	Remark
1	Smart Watch	V3SA	--	EUT

Note:1. The support equipment was authorized by Declaration of Confirmation.

2. All the above equipment/cables were placed in worse case positions to maximize emission signals during emission test.

2.6 MEASUREMENT INSTRUMENTS LIST

Radiated Emission:						
Item	Test Equipment	Manufacturer	Model No.	Inventory No.	Cal.Date (mm-dd-yy)	Cal.Due date (mm-dd-yy)
1	3m Semi- Anechoic Chamber	ZhongYu Electron	9.2(L)*6.2(W)* 6.4(H)	GTS250	June 23, 2021	June 22, 2024
2	Control Room	ZhongYu Electron	6.2(L)*2.5(W)* 2.4(H)	GTS251	N/A	N/A
3	EMI Test Receiver	Rohde & Schwarz	ESU26	GTS203	April 14, 2023	April 13, 2024
4	BiConiLog Antenna	SCHWARZBECK MESS-ELEKTRONIK	VULB9168	GTS640	March 19, 2023	March 18, 2025
5	Double -ridged waveguide horn	SCHWARZBECK MESS-ELEKTRONIK	BBHA 9120 D	GTS208	April 17, 2023	April 16, 2025
6	EMI Test Software	AUDIX	E3	N/A	N/A	N/A
7	Coaxial Cable	GTS	N/A	GTS213	April 21, 2023	April 20, 2024
8	Coaxial Cable	GTS	N/A	GTS211	April 21, 2023	April 20, 2024
9	Coaxial cable	GTS	N/A	GTS210	April 21, 2023	April 20, 2024
10	Coaxial Cable	GTS	N/A	GTS212	April 21, 2023	April 20, 2024
11	Wideband Radio Communication Tester	Rohde & Schwarz	CMW500	GTS575	April 14, 2023	April 13, 2024
12	Loop Antenna	ZHINAN	ZN30900A	GTS534	Nov. 29, 2022	Nov. 28, 2023
13	Broadband Preamplifier	SCHWARZBECK	BBV9718	GTS535	April 14, 2023	April 13, 2024
14	Amplifier(1GHz-26.5GHz)	HP	8449B	GTS601	April 14, 2023	April 13, 2024
15	Horn Antenna (18-26.5GHz)	/	UG-598A/U	GTS664	Oct. 30, 2022	Oct. 29, 2023
16	Horn Antenna (26.5-40GHz)	A.H Systems	SAS-573	GTS665	Oct. 30, 2022	Oct. 29, 2023
17	FSV-Signal Analyzer (10Hz-40GHz)	Keysight	FSV-40-N	GTS666	March 13, 2023	March 12, 2024
18	Amplifier	/	LNA-1000-30S	GTS650	April 14, 2023	April 13, 2024
19	CDNE M2+M3-16A	HCT	30MHz-300MHz	GTS668	Dec. 20,2022	Dec.19,2023

Conducted Emission						
Item	Test Equipment	Manufacturer	Model No.	Inventory No.	Cal.Date (mm-dd-yy)	Cal.Due date (mm-dd-yy)
1	Shielding Room	ZhongYu Electron	7.3(L)x3.1(W)x2.9(H)	GTS252	May 14, 2022	May 13, 2025
2	EMI Test Receiver	R&S	ESCI 7	GTS552	April 23, 2023	April 22, 2024
3	Coaxial Switch	ANRITSU CORP	MP59B	GTS225	June 22, 2023	June 21, 2024
4	ENV216 2-L-V-NETZNACHB.DE	ROHDE&SCHWARZ	ENV216	GTS226	April 21, 2023	April 20, 2024
5	Coaxial Cable	GTS	N/A	GTS227	N/A	N/A
6	EMI Test Software	AUDIX	E3	N/A	N/A	N/A
7	Thermo meter	JINCHUANG	GSP-8A	GTS639	April 27, 2023	April 26, 2024
8	Absorbing clamp	Elektronik-Feinmechanik	MDS21	GTS229	April 14, 2023	April 13, 2024
9	ISN	SCHWARZBECK	NTFM 8158	GTS565	April 21, 2023	April 20, 2024
10	High voltage probe	SCHWARZBECK	TK9420	GTS537	April 21, 2023	April 20, 2024

RF Conducted Test:						
Item	Test Equipment	Manufacturer	Model No.	Serial No.	Cal.Date (mm-dd-yy)	Cal.Due date (mm-dd-yy)
1	MXA Signal Analyzer	Agilent	N9020A	GTS566	April 21, 2023	April 20, 2024
2	EMI Test Receiver	R&S	ESCI 7	GTS552	April 21, 2023	April 20, 2024
3	Spectrum Analyzer	Agilent	E4440A	GTS536	April 21, 2023	April 20, 2024
4	MXG vector Signal Generator	Agilent	N5182A	GTS567	April 21, 2023	April 20, 2024
5	ESG Analog Signal Generator	Agilent	E4428C	GTS568	April 21, 2023	April 20, 2024
6	USB RF Power Sensor	DARE	RPR3006W	GTS569	April 21, 2023	April 20, 2024
7	RF Switch Box	Shongyi	RFSW3003328	GTS571	April 21, 2023	April 20, 2024
8	Programmable Constant Temp & Humi Test Chamber	WEWON	WHTH-150L-40-880	GTS572	April 21, 2023	April 20, 2024

General used equipment:						
Item	Test Equipment	Manufacturer	Model No.	Inventory No.	Cal.Date (mm-dd-yy)	Cal.Due date (mm-dd-yy)
1	Humidity/ Temperature Indicator	KTJ	TA328	GTS243	April 24, 2023	April 23, 2024
2	Barometer	KUMAO	SF132	GTS647	July 26, 2022	July 25, 2023

3 CONDUCTED EMISSION

3.1 TEST LIMIT

For unintentional device, according to § 15.207(a) Line Conducted Emission Limits is as following

Frequency (MHz)	Maximum RF Line Voltage (dB V)			
	CLASS A		CLASS B	
	Q.P.	Ave.	Q.P.	Ave.
0.15~0.50	79	66	66~56*	56~46*
0.50~5.00	73	60	56	46
5.00~30.0	73	60	60	50

* Decreasing linearly with the logarithm of the frequency.

For intentional device, according to §15.207(a) Line Conducted Emission Limit is same as above table.

3.2 TEST SETUP

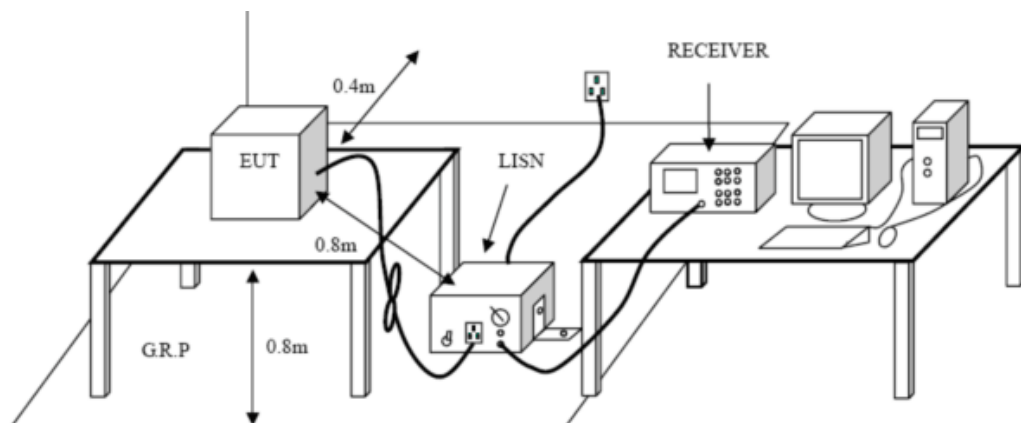

3.3 TEST PROCEDURE

1. The equipment was set up as per the test configuration to simulate typical actual usage per the user's manual. The EUT is placed on a wooden table with a height of 0.8 meters is used and is placed on the ground plane as per ANSI C63.10.
2. Support equipment, if needed, was placed as per ANSI C63.10.
3. All I/O cables were positioned to simulate typical actual usage as per ANSI C63.10.
4. If a EUT received DC power from the USB Port of Notebook PC, the PC's adapter received AC120V/60Hz power through a Line Impedance Stabilization Network (LISN) which supplied power source and was grounded to the ground plane.
5. All support equipments received AC power from a second LISN, if any.
6. The EUT test program was started. Emissions were measured on each current carrying line of the EUT using a spectrum Analyzer / Receiver connected to the LISN powering the EUT. The LISN has two monitoring points: Line 1 (Hot Side) and Line 2 (Neutral Side). Two scans were taken: one with Line 1 connected to Analyzer / Receiver and Line 2 connected to a 50 ohm load; the second scan had Line 1 connected to a 50 ohm load and Line 2 connected to the Analyzer / Receiver.
7. Analyzer / Receiver scanned from 150 kHz to 30MHz for emissions in each of the test modes.

3.4 TEST RESULT

PASS

Remark:

1. All modes were tested at AC 120V and 240V, only the worst result of AC 120V was reported.
2. All modes were test at Low, Middle, and High channel, only the worst result of BLE 1M GFSK Low Channel was reported.

Temperature:	24°C	Relative Humidity:	48%
Test Date:	Jun. 19, 2022	Pressure:	1010hPa
Test Voltage:	AC 120V, 60Hz	Phase:	Line
Test Mode:	Transmitting mode of BLE 1M GFSK 2402MHz		

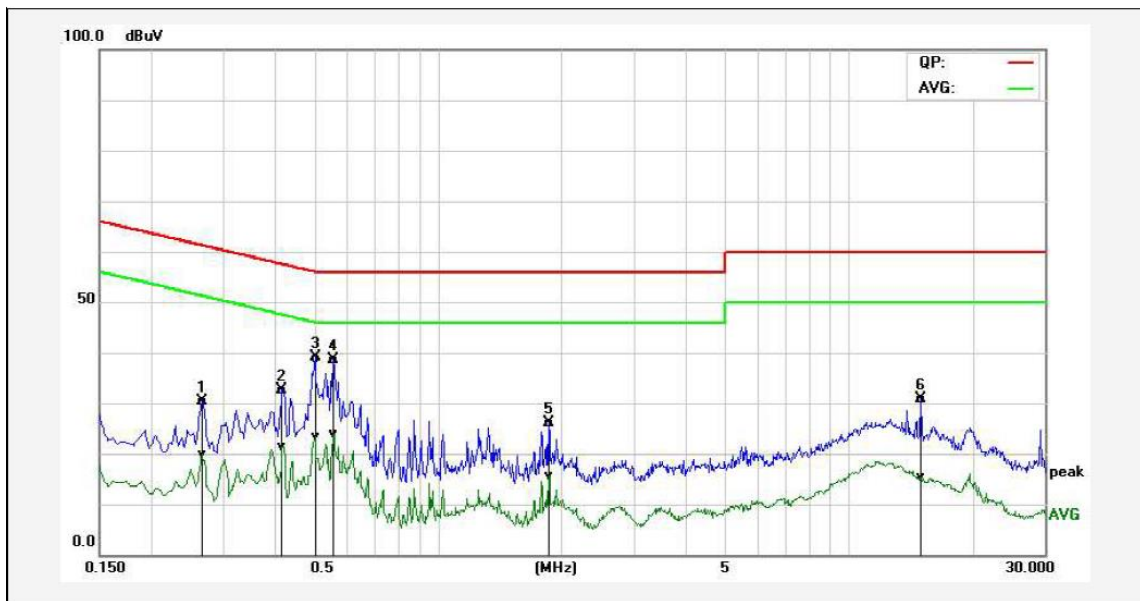

No.	Frequency (MHz)	QuasiPeak reading (dBuV)	Average reading (dBuV)	Correction factor (dB)	QuasiPeak result (dBuV)	Average result (dBuV)	QuasiPeak limit (dBuV)	Average limit (dBuV)	QuasiPeak margin (dB)	Average margin (dB)	Remark
1P	0.2660	20.29	9.71	10.11	30.40	19.82	61.24	51.24	-30.84	-31.42	Pass
2P	0.4180	22.51	11.17	10.11	32.62	21.28	57.49	47.49	-24.87	-26.21	Pass
3*	0.5020	28.88	13.32	10.12	39.00	23.44	56.00	46.00	-17.00	-22.56	Pass
4P	0.5580	28.47	13.80	10.11	38.58	23.91	56.00	46.00	-17.42	-22.09	Pass
5P	1.8660	16.09	5.42	10.11	26.20	15.53	56.00	46.00	-29.80	-30.47	Pass
6P	14.9380	20.61	5.07	10.24	30.85	15.31	60.00	50.00	-29.15	-34.69	Pass

Remark: Factor = Insertion Loss + Cable Loss, Result = Reading + Factor, Margin = Result – Limit.

Temperature:	24°C	Relative Humidity:	48%
Test Date:	Jun. 19, 2022	Pressure:	1010hPa
Test Voltage:	AC 120V, 60Hz	Phase:	Neutral
Test Mode:	Transmitting mode of BLE 1M GFSK 2402MHz		

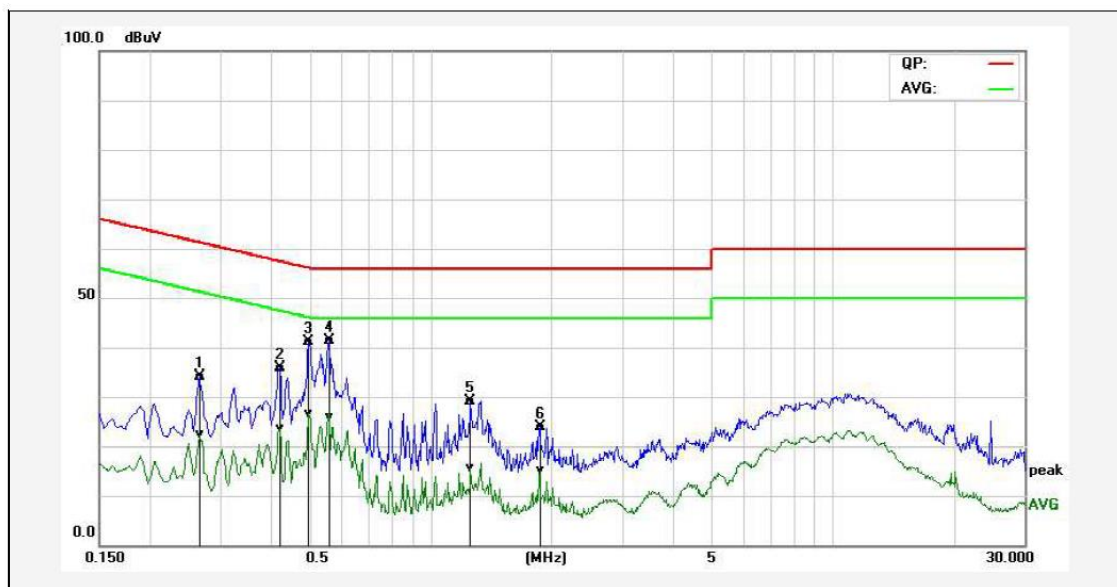

No.	Frequency (MHz)	QuasiPeak reading (dBuV)	Average reading (dBuV)	Correction factor (dB)	QuasiPeak result (dBuV)	Average result (dBuV)	QuasiPeak limit (dBuV)	Average limit (dBuV)	QuasiPeak margin (dB)	Average margin (dB)	Remark
1P	0.2660	24.25	12.37	10.00	34.25	22.37	61.24	51.24	-26.99	-28.87	Pass
2P	0.4220	25.80	13.61	10.00	35.80	23.61	57.41	47.41	-21.61	-23.80	Pass
3P	0.4980	31.00	16.52	10.01	41.01	26.53	56.03	46.03	-15.02	-19.50	Pass
4P	0.5620	31.35	15.92	9.99	41.34	25.91	56.00	46.00	-14.66	-20.09	Pass
5P	1.2579	19.09	5.71	10.01	29.10	15.72	56.00	46.00	-26.90	-30.28	Pass
6P	1.8700	13.92	5.06	10.02	23.94	15.08	56.00	46.00	-32.06	-30.92	Pass

Remark: Factor = Insertion Loss + Cable Loss, Result = Reading + Factor, Margin = Result – Limit.

4 RADIATED EMISSION

4.1 TEST LIMIT

For unintentional device, according to § 15.209(a), except for Class B digital devices, the field strength of radiated emissions from unintentional radiators at a distance of 3 meters shall not exceed the following values:

Frequency	Field strength (microvolt/meter)	Limit (dBuV/m)	Remark	Measurement distance (m)
0.009MHz-0.490MHz	2400/F (kHz)	-	Quasi-peak	300
0.490MHz-1.705MHz	24000/F (kHz)	-	Quasi-peak	30
1.705MHz-30MHz	30	-	Quasi-peak	30
30MHz-88MHz	100	40.0	Quasi-peak	3
88MHz-216MHz	150	43.5	Quasi-peak	3
216MHz-960MHz	200	46.0	Quasi-peak	3
960MHz-1GHz	500	54.0	Quasi-peak	3
Above 1GHz	500	54.0	Average	3
		74.0	Peak	3

For intentional device, according to § 15.209(a), the general requirement of field strength of radiated emissions from intentional radiators at a distance of 3 meters shall not exceed the above table.

Limit: (Field strength of the fundamental signal)

Frequency	Limit (dBuV/m @3m)	Remark
2400MHz-2483.5MHz	94.0	Average Value
	114.0	Peak Value

4.2 TEST SETUP

1. Radiated Emission Test-Up Frequency Below 30MHz

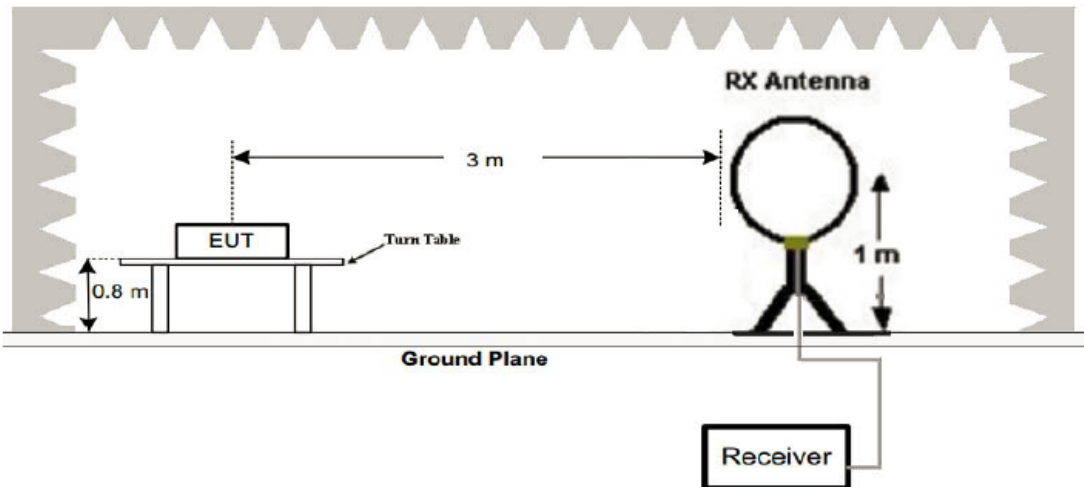

2. Radiated Emission Test-Up Frequency 30MHz~1GHz

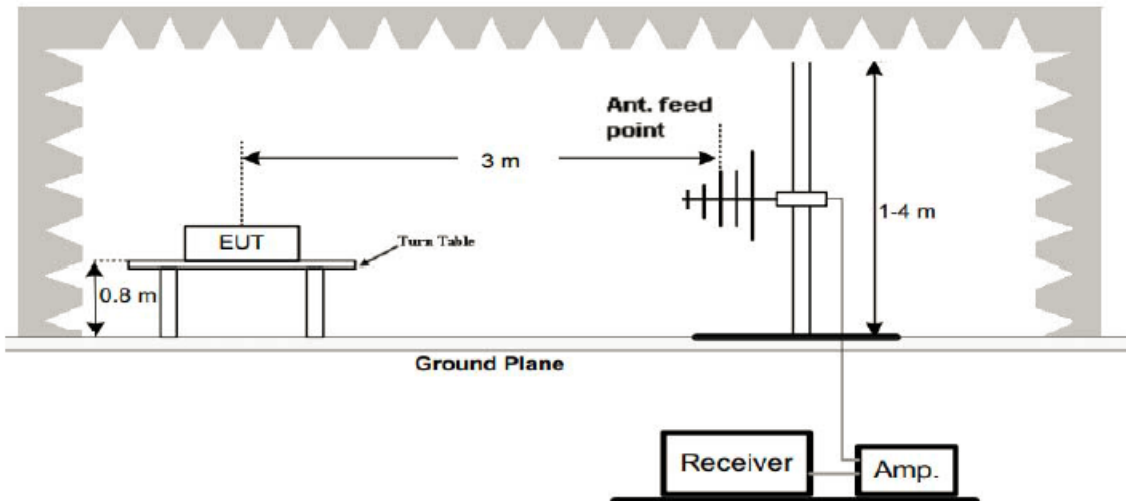

3. Radiated Emission Test-Up Frequency Above 1GHz

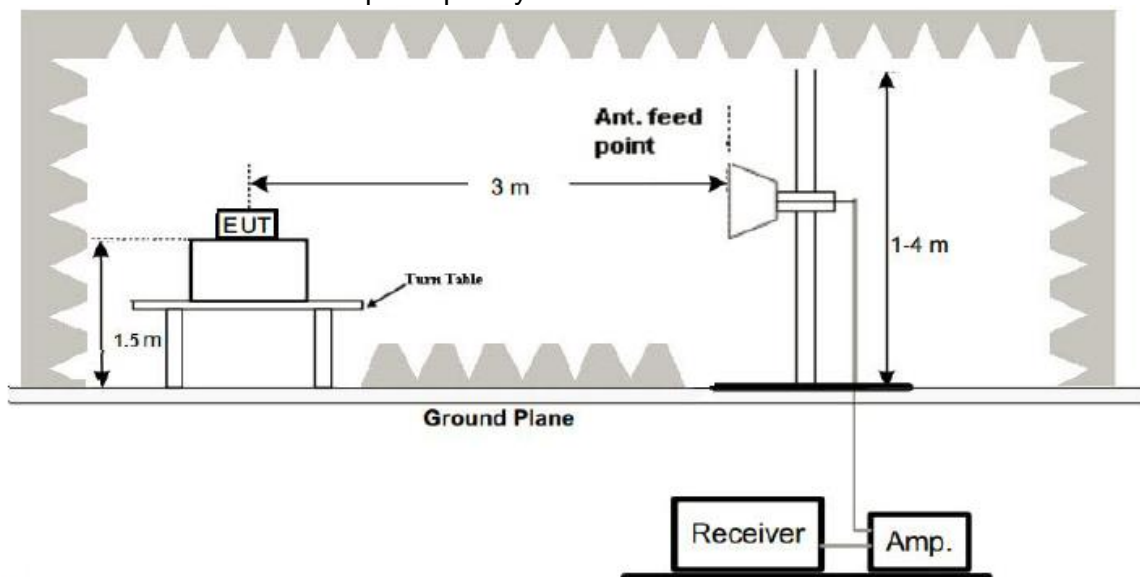

4.3 TEST PROCEDURE

1. Below 1GHz measurement the EUT is placed on turntable which is 0.8m above ground plane. And above 1GHz measurement EUT was placed on low permittivity and low tangent turn table which is 1.5m above ground plane.
2. The turntable shall be rotated for 360 degrees to determine the position of maximum emission level.
3. EUT is set 3m away from the receiving antenna, which is varied from 1m to 4m to find out the highest emissions.
4. Maximum procedure was performed on the six highest emissions to ensure EUT compliance.
5. And also, each emission was to be maximized by changing the polarization of receiving antenna both horizontal and vertical.
6. Repeat above procedures until the measurements for all frequencies are complete.
7. The test frequency range from 9kHz to 25GHz per FCC PART 15.33(a).

Note: For battery operated equipment, the equipment tests shall be performed using a new battery.

4.4 TEST RESULT

PASS

Remark:

1. All modes were test at Low, Middle, and High channel, only the worst result of BLE 1M GFSK Low Channel was reported for below 1GHz test.
2. By preliminary testing and verifying three axis (X, Y and Z) position of EUT transmitted status, it was found that "X axis" position was the worst, and test data recorded in this report.
3. Radiated emission test from 9kHz to 10th harmonic of fundamental was verified, and no emission found except system noise floor in 9kHz to 30MHz and not recorded in this report.

Below 1GHz Test Results:

Temperature:	24°C	Relative Humidity:	48%
Test Date:	Jun. 19, 2022	Pressure:	1010hPa
Test Voltage:	AC 120V, 60Hz	Phase:	Horizontal
Test Mode:	Transmitting mode of BLE 1M GFSK 2402MHz		

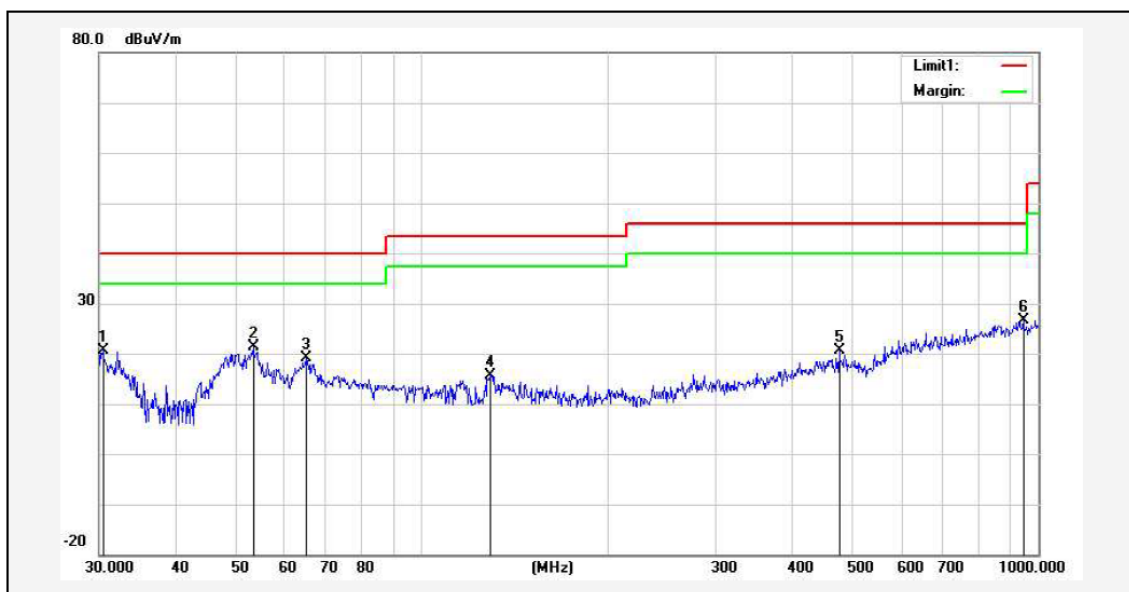

No.	Frequency (MHz)	Reading (dBuV)	Correction factor(dB/m)	Result (dBuV/m)	Limit (dBuV/m)	Margin (dB)	Degree (deg.)	Height (cm)	Remark
1	30.4238	27.59	-6.94	20.65	40.00	-19.35	117	100	peak
2*	53.3179	41.57	-20.14	21.43	40.00	-18.57	255	100	peak
3	64.8865	39.68	-20.53	19.15	40.00	-20.85	213	100	peak
4	129.0146	30.55	-14.89	15.66	43.50	-27.84	105	100	peak
5	475.4991	29.44	-8.92	20.52	46.00	-25.48	68	100	peak
6	945.4399	28.45	-1.74	26.71	46.00	-19.29	188	100	peak

Remark: Result = Reading Level + Factor, Margin = Result – Limit
 Factor = Ant. Factor + Cable Loss – Pre-amplifier

Temperature:	24°C	Relative Humidity:	48%
Test Date:	Jun. 19, 2022	Pressure:	1010hPa
Test Voltage:	AC 120V, 60Hz	Phase:	Vertical
Test Mode:	Transmitting mode of BLE 1M GFSK 2402MHz		

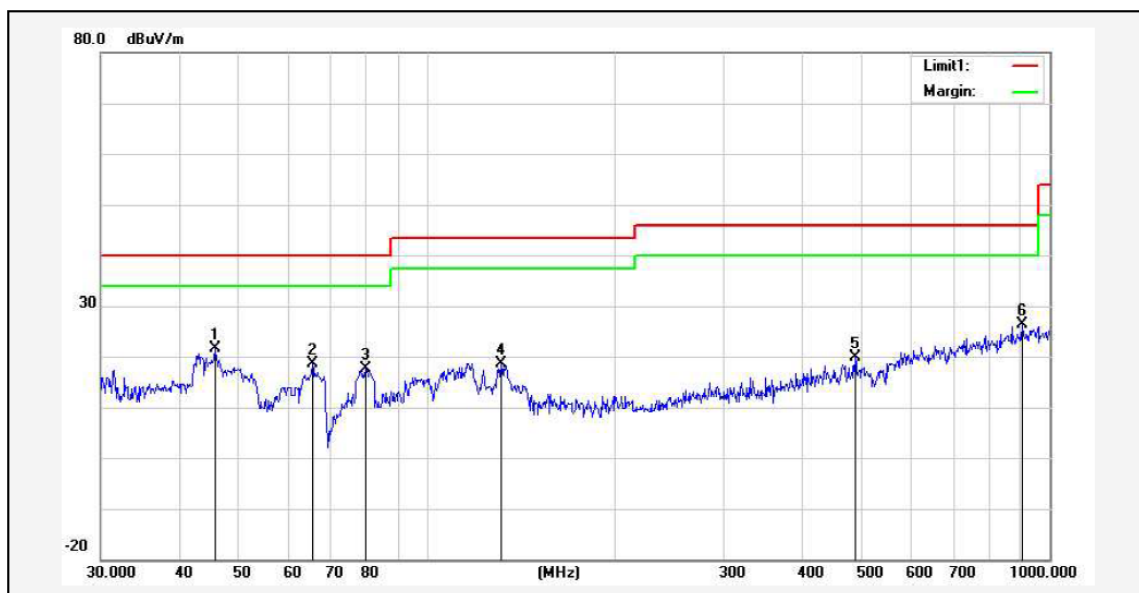

No.	Frequency (MHz)	Reading (dBuV)	Correction factor(dB/m)	Result (dBuV/m)	Limit (dBuV/m)	Margin (dB)	Degree (deg.)	Height (cm)	Remark
1*	45.6948	39.48	-17.81	21.67	40.00	-18.33	143	100	peak
2	65.5727	39.03	-20.45	18.58	40.00	-21.42	93	100	peak
3	79.8003	37.51	-19.93	17.58	40.00	-22.42	74	100	peak
4	131.7577	33.56	-14.85	18.71	43.50	-24.79	110	100	peak
5	487.3151	28.87	-9.09	19.78	46.00	-26.22	234	100	peak
6	903.3094	28.08	-1.76	26.32	46.00	-19.68	138	100	peak

Remark: Result = Reading Level + Factor, Margin = Result – Limit
Factor = Ant. Factor + Cable Loss – Pre-amplifier

Remark:

1. Measuring frequencies from 9 kHz to the 1 GHz, Radiated emission test from 9kHz to 30MHz was verified, and no any emission was found except system noise floor.
2. * denotes emission frequency which appearing within the Restricted Bands specified in provision of 15.205, then the general radiated emission limits in 15.209 apply.
3. The IF bandwidth of EMI Test Receiver between 30MHz to 1GHz was 120kHz, 1 MHz for measuring above 1 GHz, below 30MHz was 10kHz.

Above 1 GHz Test Results:

BLE 1M:

CH00 (2402MHz)

Horizontal:

Frequency (MHz)	Reading Result (dB μ V)	Factor (dB)	Emission Level (dB μ V/m)	Limits (dB μ V/m)	Margin (dB)	Detector Type
2402	101.6	-5.84	95.76	114	-18.24	PK
2402	72.56	-5.84	66.72	94	-27.28	AV
4804	51.44	-3.64	47.8	74	-26.2	PK
4804	38.62	-3.64	34.98	54	-19.02	AV
7206	46.37	-0.95	45.42	74	-28.58	PK
7206	35.15	-0.95	34.2	54	-19.8	AV
Remark: Factor = Antenna Factor + Cable Loss – Pre-amplifier. Margin = Emission Level – Limit						

Vertical:

Frequency (MHz)	Reading Result (dB μ V)	Factor (dB)	Emission Level (dB μ V/m)	Limits (dB μ V/m)	Margin (dB)	Detector Type
2402	98.66	-5.84	92.82	114	-21.18	PK
2402	72.43	-5.84	66.59	94	-27.41	AV
4804	51.22	-3.64	47.58	74	-26.42	PK
4804	39.16	-3.64	35.52	54	-18.48	AV
7206	46.75	-0.95	45.8	74	-28.2	PK
7206	36.54	-0.95	35.59	54	-18.41	AV
Remark: Factor = Antenna Factor + Cable Loss – Pre-amplifier. Margin = Emission Level – Limit						

CH19 (2440MHz)

Horizontal:

Frequency (MHz)	Reading Result (dB μ V)	Factor (dB)	Emission Level (dB μ V/m)	Limits (dB μ V/m)	Margin (dB)	Detector Type
2440	99.55	-5.71	93.84	114	-20.16	PK
2440	72.42	-5.71	66.71	94	-27.29	AV
4880	49.26	-3.51	45.75	74	-28.25	PK
4880	39.18	-3.51	35.67	54	-18.33	AV
7320	46.93	-0.82	46.11	74	-27.89	PK
7320	36.34	-0.82	35.52	54	-18.48	AV
Remark: Factor = Antenna Factor + Cable Loss – Pre-amplifier. Margin = Emission Level – Limit						

Vertical:

Frequency (MHz)	Reading Result (dB μ V)	Factor (dB)	Emission Level (dB μ V/m)	Limits (dB μ V/m)	Margin (dB)	Detector Type
2440	98.41	-5.71	92.7	114	-21.3	PK
2440	73.24	-5.71	67.53	94	-26.47	AV
4880	50.17	-3.51	46.66	74	-27.34	PK
4880	39.22	-3.51	35.71	54	-18.29	AV
7320	46.66	-0.82	45.84	74	-28.16	PK
7320	35.91	-0.82	35.09	54	-18.91	AV
Remark: Factor = Antenna Factor + Cable Loss – Pre-amplifier. Margin = Emission Level – Limit						

CH39 (2480MHz)

Horizontal:

Frequency	Reading Result	Factor	Emission Level	Limits	Margin	Detector Type
(MHz)	(dB μ V)	(dB)	(dB μ V/m)	(dB μ V/m)	(dB)	
2480	97.43	-5.65	91.78	114	-22.22	PK
2480	72.15	-5.65	66.5	94	-27.5	AV
4960	49.34	-3.43	45.91	74	-28.09	PK
4960	39.35	-3.43	35.92	54	-18.08	AV
7440	46.48	-0.75	45.73	74	-28.27	PK
7440	36.33	-0.75	35.58	54	-18.42	AV
Remark: Factor = Antenna Factor + Cable Loss – Pre-amplifier. Margin = Emission Level – Limit						

Vertical:

Frequency	Reading Result	Factor	Emission Level	Limits	Margin	Detector Type
(MHz)	(dB μ V)	(dB)	(dB μ V/m)	(dB μ V/m)	(dB)	
2480	96.55	-5.63	90.92	114	-23.08	PK
2480	71.63	-5.65	65.98	94	-28.02	AV
4960	49.37	-3.43	45.94	74	-28.06	PK
4960	38.22	-3.43	34.79	54	-19.21	AV
7440	46.36	-0.75	45.61	74	-28.39	PK
7440	36.31	-0.75	35.56	54	-18.44	AV
Remark: Factor = Antenna Factor + Cable Loss – Pre-amplifier. Margin = Emission Level – Limit						

BLE 2M:
CH00 (2402MHz)

Horizontal:

Frequency (MHz)	Reading Result (dB μ V)	Factor (dB)	Emission Level (dB μ V/m)	Limits (dB μ V/m)	Margin (dB)	Detector Type
2402	101.57	-5.84	95.73	114	-18.27	PK
2402	72.46	-5.84	66.62	94	-27.38	AV
4804	51.35	-3.64	47.71	74	-26.29	PK
4804	38.43	-3.64	34.79	54	-19.21	AV
7206	46.25	-0.95	45.3	74	-28.7	PK
7206	35.11	-0.95	34.16	54	-19.84	AV
Remark: Factor = Antenna Factor + Cable Loss – Pre-amplifier. Margin = Emission Level – Limit						

Vertical:

Frequency (MHz)	Reading Result (dB μ V)	Factor (dB)	Emission Level (dB μ V/m)	Limits (dB μ V/m)	Margin (dB)	Detector Type
2402	98.23	-5.84	92.39	114	-21.61	PK
2402	72.41	-5.84	66.57	94	-27.43	AV
4804	51.52	-3.64	47.88	74	-26.12	PK
4804	38.12	-3.64	34.48	54	-19.52	AV
7206	45.76	-0.95	44.81	74	-29.19	PK
7206	36.13	-0.95	35.18	54	-18.82	AV
Remark: Factor = Antenna Factor + Cable Loss – Pre-amplifier. Margin = Emission Level – Limit						

CH19 (2440MHz)

Horizontal:

Frequency (MHz)	Reading Result (dB μ V)	Factor (dB)	Emission Level (dB μ V/m)	Limits (dB μ V/m)	Margin (dB)	Detector Type
2440	98.96	-5.71	93.25	114	-20.75	PK
2440	72.21	-5.71	66.5	94	-27.5	AV
4880	49.21	-3.51	45.7	74	-28.3	PK
4880	39.17	-3.51	35.66	54	-18.34	AV
7320	46.86	-0.82	46.04	74	-27.96	PK
7320	36.23	-0.82	35.41	54	-18.59	AV
Remark: Factor = Antenna Factor + Cable Loss – Pre-amplifier. Margin = Emission Level – Limit						

Vertical:

Frequency (MHz)	Reading Result (dB μ V)	Factor (dB)	Emission Level (dB μ V/m)	Limits (dB μ V/m)	Margin (dB)	Detector Type
2440	98.24	-5.71	92.53	114	-21.47	PK
2440	73.13	-5.71	67.42	94	-26.58	AV
4880	50.76	-3.51	47.25	74	-26.75	PK
4880	39.25	-3.51	35.74	54	-18.26	AV
7320	46.49	-0.82	45.67	74	-28.33	PK
7320	34.88	-0.82	34.06	54	-19.94	AV
Remark: Factor = Antenna Factor + Cable Loss – Pre-amplifier. Margin = Emission Level – Limit						

CH39 (2480MHz)

Horizontal:

Frequency	Reading Result	Factor	Emission Level	Limits	Margin	Detector Type
(MHz)	(dB μ V)	(dB)	(dB μ V/m)	(dB μ V/m)	(dB)	
2480	97.08	-5.65	91.43	114	-22.57	PK
2480	71.25	-5.65	65.6	94	-28.4	AV
4960	48.06	-3.43	44.63	74	-29.37	PK
4960	39.86	-3.43	36.43	54	-17.57	AV
7440	46.73	-0.75	45.98	74	-28.02	PK
7440	36.18	-0.75	35.43	54	-18.57	AV
Remark: Factor = Antenna Factor + Cable Loss – Pre-amplifier. Margin = Emission Level – Limit						

Vertical:

Frequency	Reading Result	Factor	Emission Level	Limits	Margin	Detector Type
(MHz)	(dB μ V)	(dB)	(dB μ V/m)	(dB μ V/m)	(dB)	
2480	95.86	-5.63	90.23	114	-23.77	PK
2480	71.61	-5.65	65.96	94	-28.04	AV
4960	49.34	-3.43	45.91	74	-28.09	PK
4960	34.53	-3.43	31.1	54	-22.9	AV
7440	46.32	-0.75	45.57	74	-28.43	PK
7440	36.36	-0.75	35.61	54	-18.39	AV
Remark: Factor = Antenna Factor + Cable Loss – Pre-amplifier. Margin = Emission Level – Limit						

Remark:

1. Measuring frequencies from 1 GHz to the 25 GHz.
2. "F" denotes fundamental frequency; "H" denotes spurious frequency. "E" denotes band edge frequency.
3. * denotes emission frequency which appearing within the Restricted Bands specified in provision of 15.205, then the general radiated emission limits in 15.209 apply.
4. Data of measurement within this frequency range shown "---" in the table above means the reading of emissions are attenuated more than 20dB below the permissible limits or the field strength is too small to be measured.
5. The IF bandwidth of EMI Test Receiver between 30MHz to 1GHz was 120kHz, 1 MHz for measuring above 1 GHz, below 30MHz was 10kHz. The resolution bandwidth of test receiver/spectrum analyzer is 1MHz and video bandwidth is 3MHz for peak measurement with peak detector at frequency above 1GHz. The resolution bandwidth of test receiver/spectrum analyzer is 1MHz and video bandwidth is 10Hz for Average measurement with peak detection at frequency above 1GHz.
6. When the test results of Peak Detected below the limits of Average Detected, the Average Detected is not need completed. For example: Top Channel at Fundamental 73.16dBuV/m(PK Value) <93.98(AV Limit), at harmonic 53.20 dBuV/m(PK Value) <54 dBuV/m(AV Limit), the Average Detected not need to completed.
7. For fundamental frequency, RBW >20dB BW, VBW>=3XRBW, PK detector for PK value, AV detector for AV value.

5 BAND EDGE

5.1 TEST LIMIT

FCC PART 15.249(d) Emissions radiated outside of the specified frequency bands, except for harmonics, shall be attenuated by at least 50 dB below the level of the fundamental or to the general radiated emission limits in §15.209, whichever is the lesser attenuation.

5.2 TEST SETUP

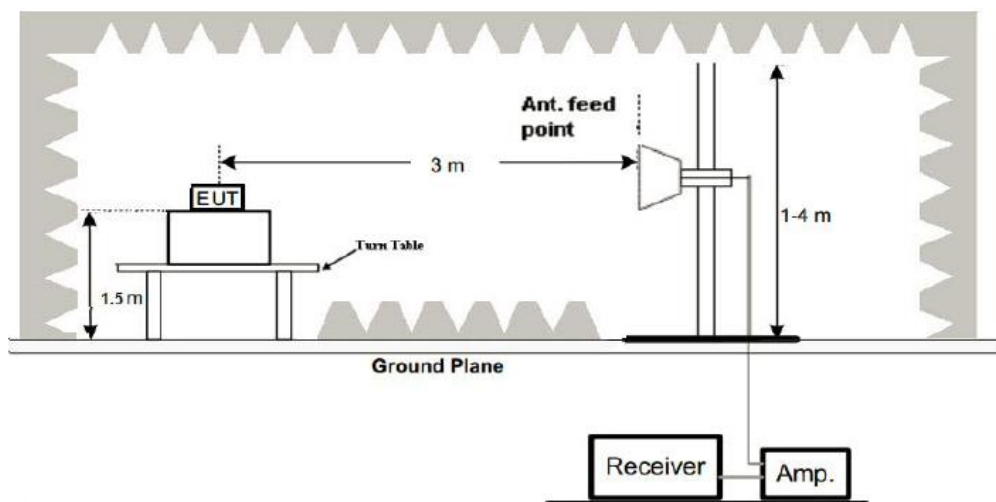

5.3 MEASUREMENT EQUIPMENT USED

Refer to Section 3.3.

5.4 TEST PROCEDURE

1. The EUT operates at transmitting mode. The operate channel is tested to verify the largest transmission and spurious emissions power at the continuous transmission mode. The band edge compliance of RF radiated emission should be measured by following the guidance in ANSI C63.10 with respect to maximizing the emission by rotating the EUT, measuring the emission while the EUT is situated in three orthogonal planes (if appropriate), adjusting the measurement antenna height and polarization etc.
2. Set the spectrum analyzer in the following setting in order to capture the lower and upper band-edges of the emission:
 - (a) PEAK: RBW=1MHz, VBW=3MHz / Sweep=AUTO
 - (b) AVERAGE: RBW=1MHz ; VBW=3MHz / Sweep=AUTO

5.5 TEST RESULT

PASS

BLE 1M:

Operation Mode: TX CH00 (2402MHz)

Horizontal:

Frequency (MHz)	Reading Result (dB μ V)	Factor (dB)	Emission Level (dB μ V/m)	Limits (dB μ V/m)	Margin (dB)	Detector Type
2310	57.55	-5.81	51.74	74	-22.26	PK
2310	/	-5.81	/	54	/	AV
2390	57.68	-5.84	51.84	74	-22.16	PK
2390	/	-5.84	/	54	/	AV
2400	57.36	-5.84	51.52	74	-22.48	PK
2400	/	-5.84	/	54	/	AV

Remark: Factor = Antenna Factor + Cable Loss – Pre-amplifier.

Vertical:

Frequency (MHz)	Reading Result (dB μ V)	Factor (dB)	Emission Level (dB μ V/m)	Limits (dB μ V/m)	Margin (dB)	Detector Type
2310	57.24	-5.81	51.43	74	-22.57	PK
2310	/	-5.81	/	54	/	AV
2390	57.31	-5.84	51.47	74	-22.53	PK
2390	/	-5.84	/	54	/	AV
2400	57.59	-5.84	51.75	74	-22.25	PK
2400	/	-5.84	/	54	/	AV

Remark: Factor = Antenna Factor + Cable Loss – Pre-amplifier.

Operation Mode: TX CH39 (2480MHz)

Horizontal:

Frequency (MHz)	Reading Result (dB μ V)	Factor (dB)	Emission Level (dB μ V/m)	Limits (dB μ V/m)	Margin (dB)	Detector Type
2483.5	56.16	-5.65	50.51	74	-23.49	PK
2483.5	/	-5.65	/	54	/	AV
2500	57.23	-5.72	51.51	74	-22.49	PK
2500	/	-5.72	/	54	/	AV
Remark: Factor = Antenna Factor + Cable Loss – Pre-amplifier.						

Vertical:

Frequency (MHz)	Reading Result (dB μ V)	Factor (dB)	Emission Level (dB μ V/m)	Limits (dB μ V/m)	Margin (dB)	Detector Type
2483.5	57.62	-5.65	51.97	74	-22.03	PK
2483.5	/	-5.65	/	54	/	AV
2500	57.17	-5.72	51.45	74	-22.55	PK
2500	/	-5.72	/	54	/	AV
Remark: Factor = Antenna Factor + Cable Loss – Pre-amplifier.						

BLE 2M:

Operation Mode: TX CH00 (2402MHz)

Horizontal:

Frequency (MHz)	Reading Result (dB μ V)	Factor (dB)	Emission Level (dB μ V/m)	Limits (dB μ V/m)	Margin (dB)	Detector Type
2310	57.73	-5.81	51.92	74	-22.08	PK
2310	/	-5.81	/	54	/	AV
2390	57.45	-5.84	51.61	74	-22.39	PK
2390	/	-5.84	/	54	/	AV
2400	57.47	-5.84	51.63	74	-22.37	PK
2400	/	-5.84	/	54	/	AV

Remark: Factor = Antenna Factor + Cable Loss – Pre-amplifier.

Vertical:

Frequency (MHz)	Reading Result (dB μ V)	Factor (dB)	Emission Level (dB μ V/m)	Limits (dB μ V/m)	Margin (dB)	Detector Type
2310	57.28	-5.81	51.47	74	-22.53	PK
2310	/	-5.81	/	54	/	AV
2390	57.39	-5.84	51.55	74	-22.45	PK
2390	/	-5.84	/	54	/	AV
2400	57.24	-5.84	51.4	74	-22.6	PK
2400	/	-5.84	/	54	/	AV

Remark: Factor = Antenna Factor + Cable Loss – Pre-amplifier.

Operation Mode: TX CH39 (2480MHz)

Horizontal:

Frequency (MHz)	Reading Result (dB μ V)	Factor (dB)	Emission Level (dB μ V/m)	Limits (dB μ V/m)	Margin (dB)	Detector Type
2483.5	56.35	-5.65	50.7	74	-23.3	PK
2483.5	/	-5.65	/	54	/	AV
2500	57.39	-5.72	51.67	74	-22.33	PK
2500	/	-5.72	/	54	/	AV
Remark: Factor = Antenna Factor + Cable Loss – Pre-amplifier.						

Vertical:

Frequency (MHz)	Reading Result (dB μ V)	Factor (dB)	Emission Level (dB μ V/m)	Limits (dB μ V/m)	Margin (dB)	Detector Type
2483.5	57.51	-5.65	51.86	74	-22.14	PK
2483.5	/	-5.65	/	54	/	AV
2500	57.14	-5.72	51.42	74	-22.58	PK
2500	/	-5.72	/	54	/	AV
Remark: Factor = Antenna Factor + Cable Loss – Pre-amplifier.						

6 20dB Bandwidth

6.1 TEST SETUP (BLOCK DIAGRAM OF CONFIGURATION)

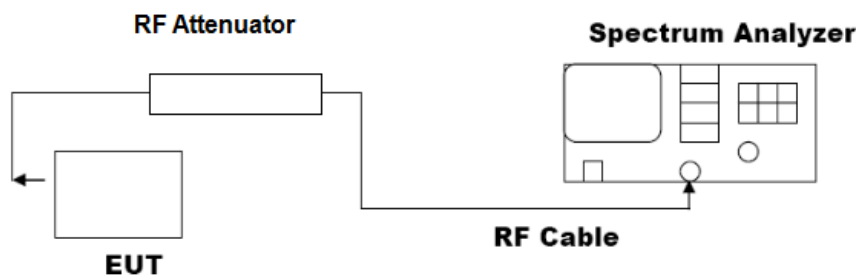

6.2 MEASUREMENT EQUIPMENT USED

Refer to Section 3.3.

6.3 TEST PROCEDURE

1. The RF output of EUT was connected to the spectrum analyzer by RF cable and attenuator. The path loss was compensated to the results for each measurement.
2. Set to the maximum power setting and enable the EUT transmit continuously.
3. Make the measurement with the spectrum analyzer's resolution bandwidth (RBW) = 30 kHz. Set the Video bandwidth (VBW) = 100 kHz. In order to make an accurate measurement.
4. For 20dB Bandwidth Measurement, the spectrum analyzer's resolution bandwidth (RBW) is set 1-5% of the emission bandwidth and set the Video bandwidth (VBW) $\geq 3 * RBW$.
5. Measure and record the results in the test report.

6.4 TEST RESULT

PASS

BLE 1M:
GFSK Modulation:

Channel	Frequency (MHz)	20dB Bandwidth (MHz)	Result
CH00	2402	1.206	PASS
CH19	2440	1.174	PASS
CH39	2480	1.197	PASS

CH00: 2402MHz

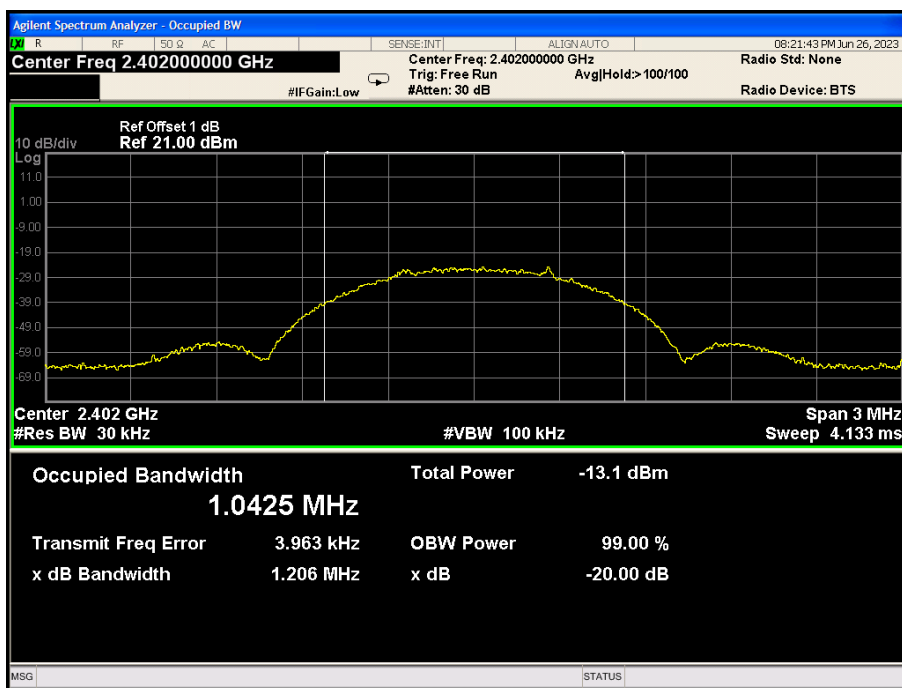

CH19: 2440MHz

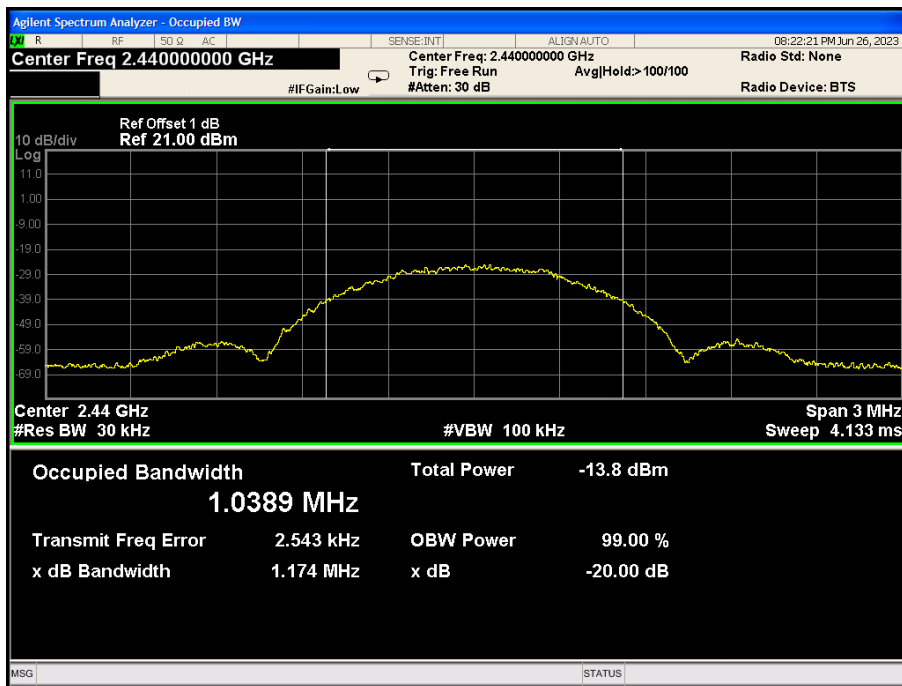

CH39: 2480MHz

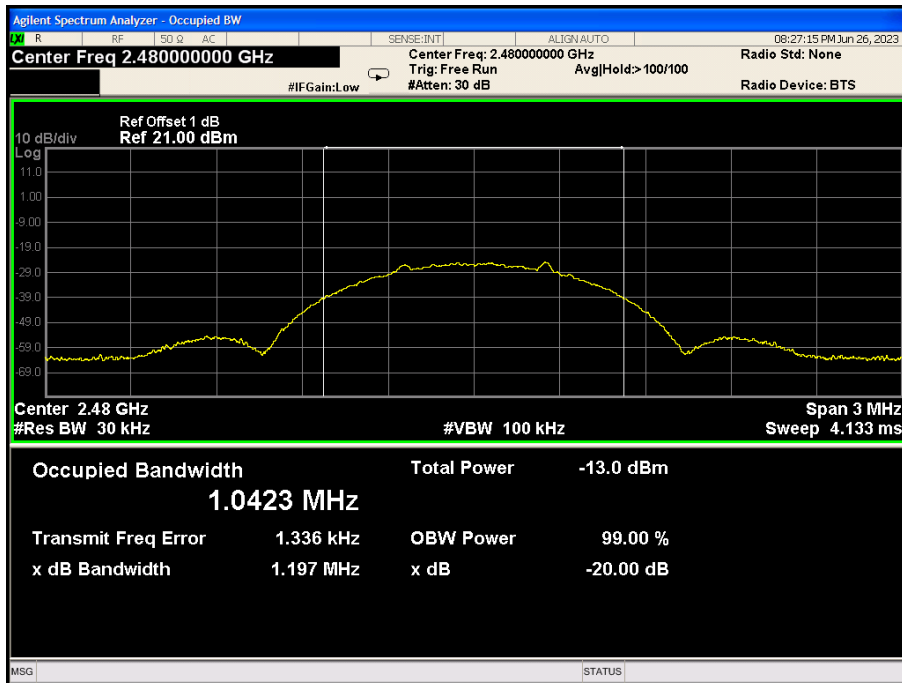

BLE 2M:
GFSK Modulation:

Channel	Frequency (MHz)	20dB Bandwidth (MHz)	Result
CH00	2402	2.337	PASS
CH19	2440	2.354	PASS
CH39	2480	2.349	PASS

CH00: 2402MHz

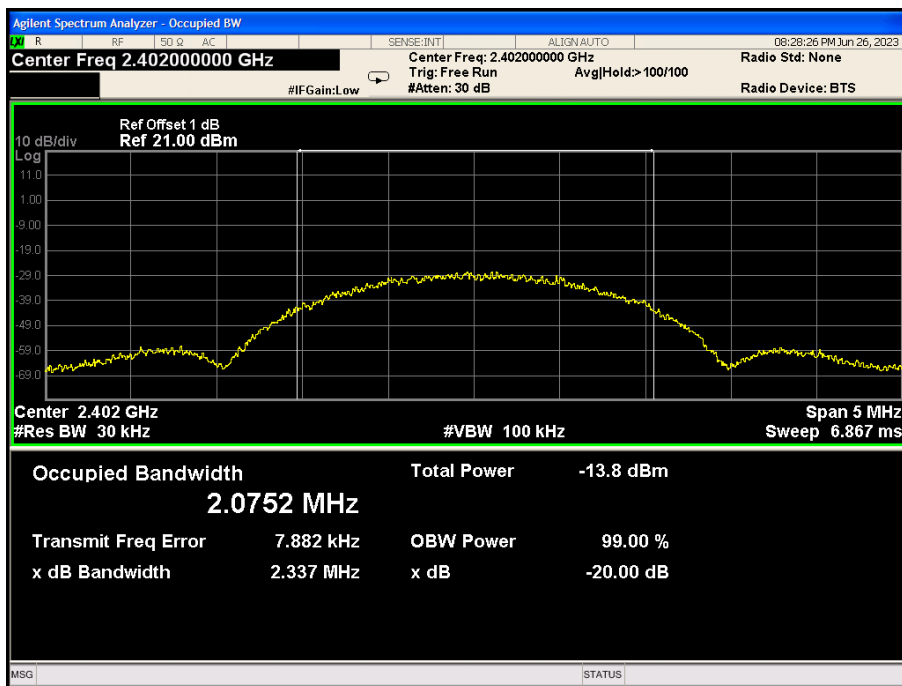

CH19: 2440MHz

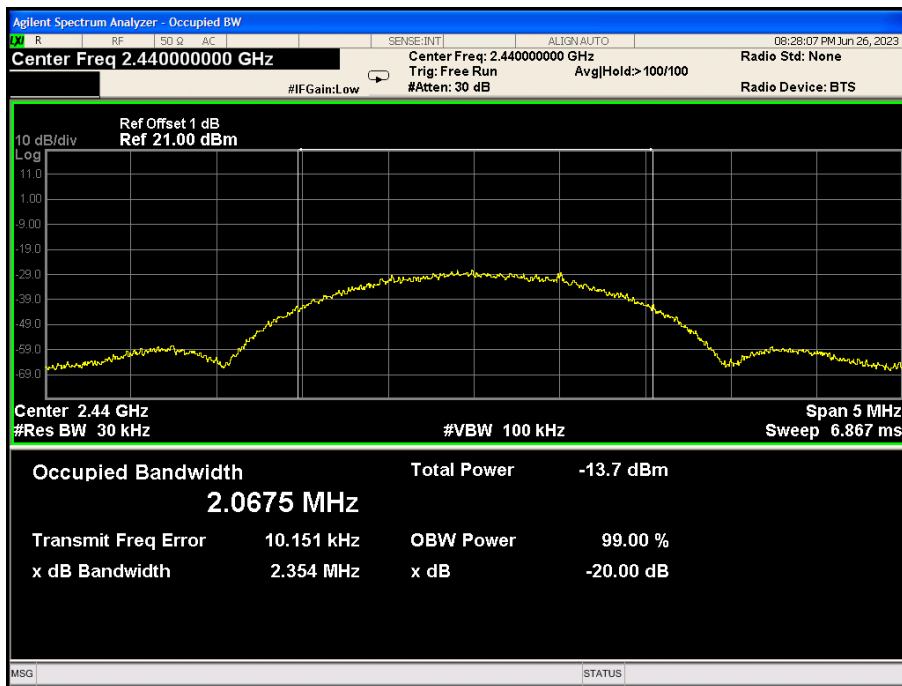

CH39: 2480MHz

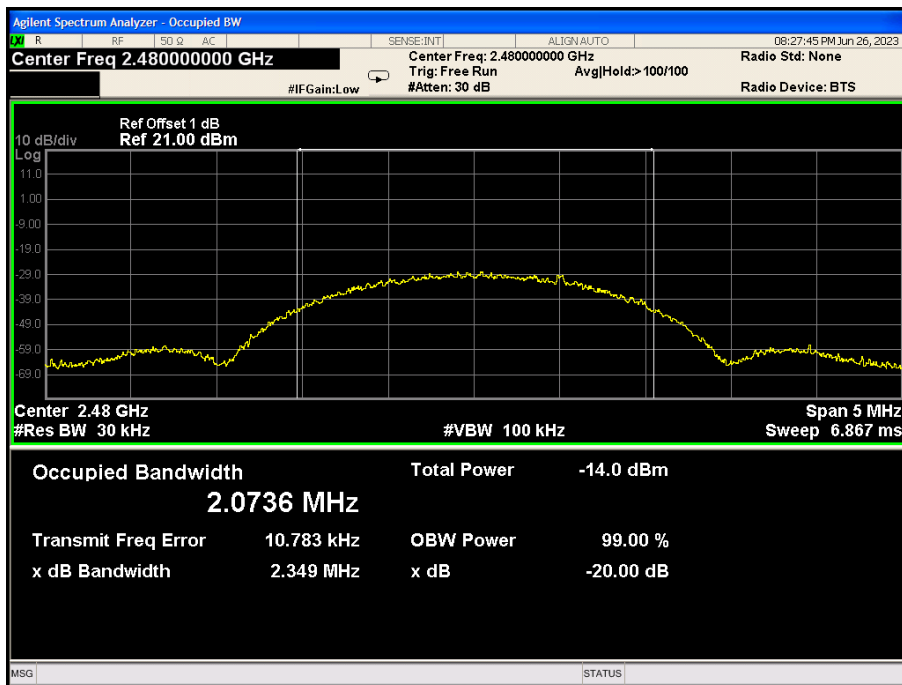

7 ANTENNA REQUIREMENT

Standard Applicable:

For intentional device, according to FCC 47 CFR Section 15.203, an intentional radiator shall be designed to ensure that no antenna other than that furnished by the responsible party shall be used with the device.

Antenna Connected Construction

The antenna used in this product is an Internal Antenna.

ANTENNA:

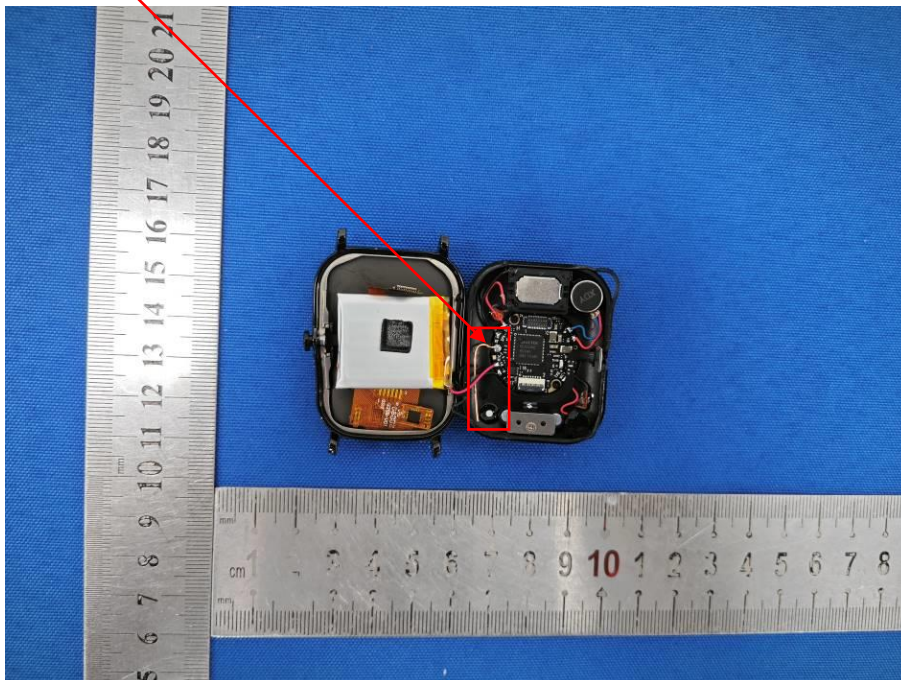

**8 PHOTO OF TEST
RADIATED EMISSION**

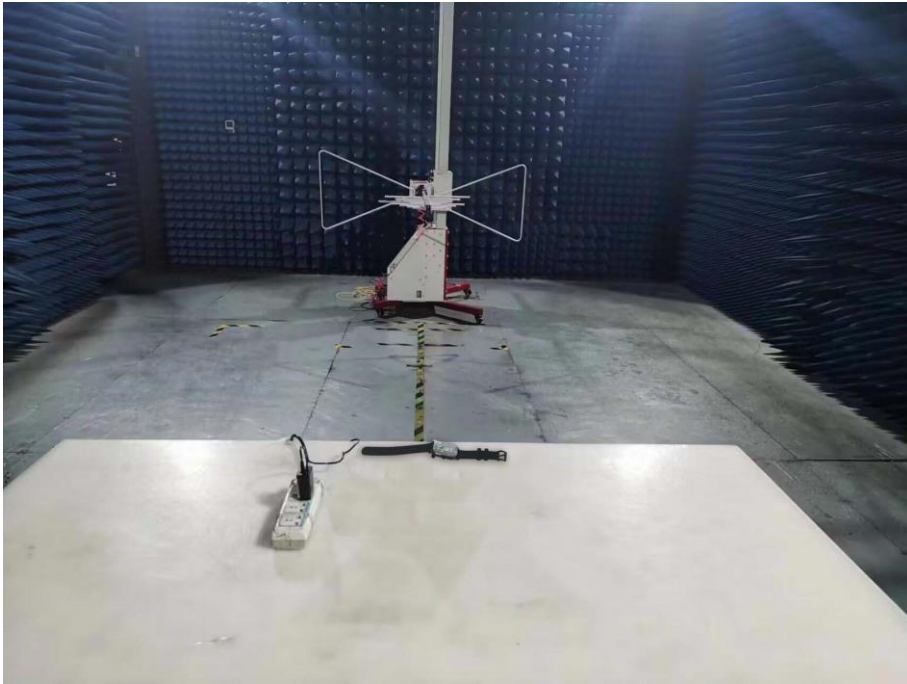

30MHz-1000MHz

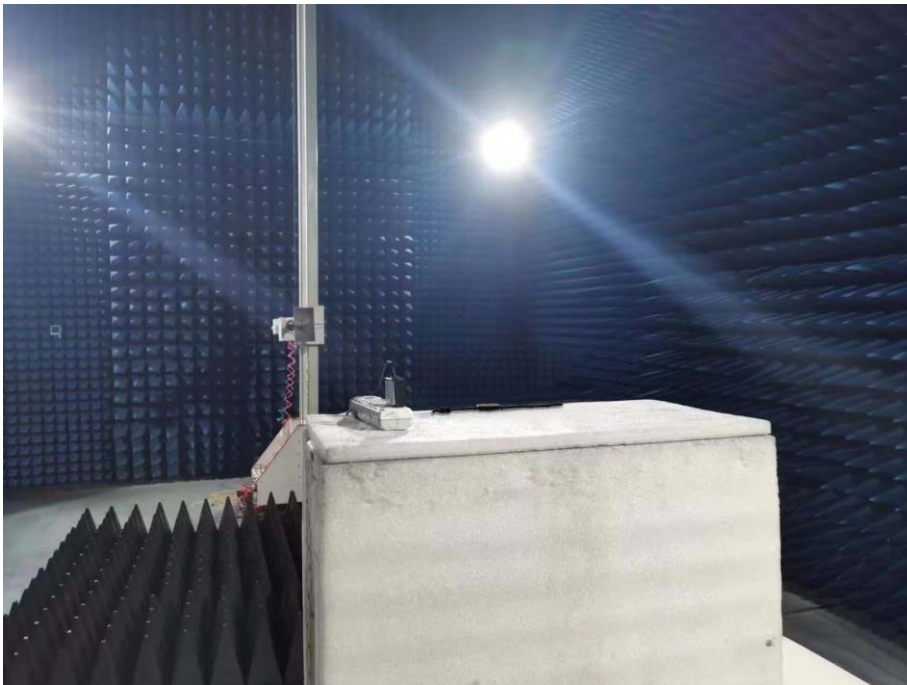

Above 1GHz

CONDUCTED EMISSION

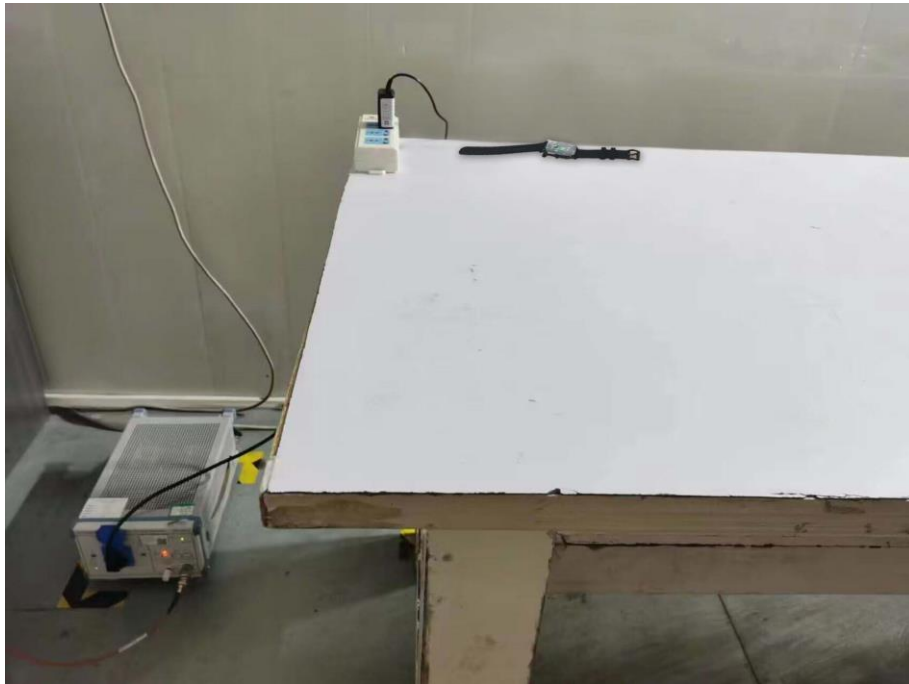

RF CONDUCTED

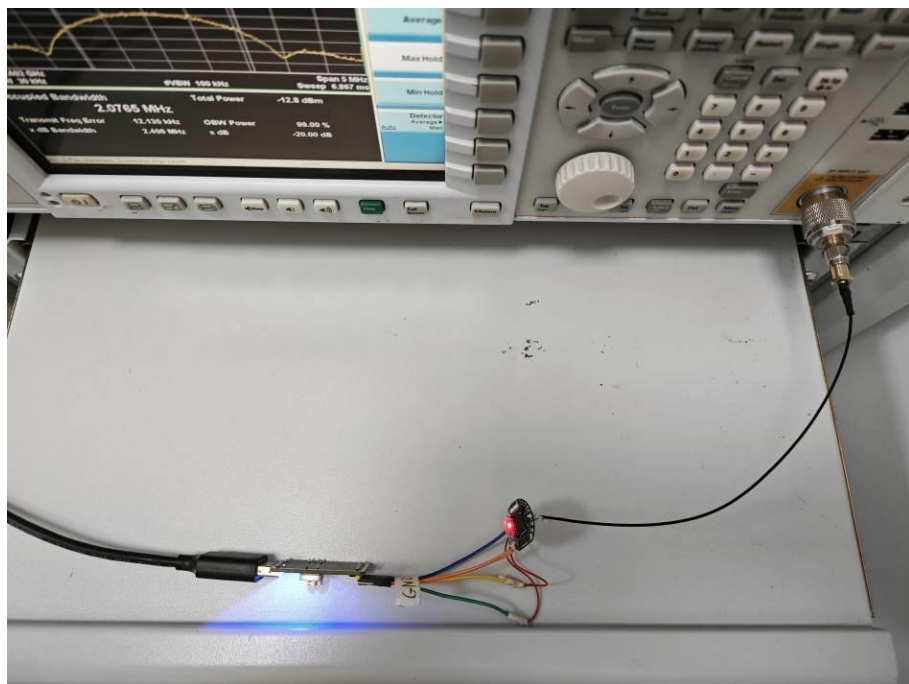

End of Report