

RF TEST REPORT

FCC / ISED

APPLICANT

Safetrust Inc

MODEL NAME

SA500

FCC ID

2ANI5SA500

ISED ID

23133-SA500

REPORT NUMBER

HA221021-SFT-005-R04

TEST REPORT

Date of Issue
November 2, 2022

Test Site
Hyundai C-Tech, Inc. dba HCT America, Inc.
1726 Ringwood Ave, San Jose, CA 95131, USA

Applicant	Safetrust Inc
Applicant Address	8116 Mill Creek Rd, Fremont, CA 94539, U.S.A.
FCC ID	2ANI5SA500
ISED ID	23133-SA500
Model Name	SA500
EUT Type	IoT Sensor
Modulation Type	OFDM
FCC Classification	Unlicensed National Information Infrastructure (NII)
FCC Rule Part(s)	Part 15.407
ISED Rule Part(s)	RSS-247 Issue 2 (February 2017) RSS-Gen Issue 5 Amd 2 (February 2021)
Test Procedure	ANSI C63.10-2013, KDB 789033 D02 v02r01, KDB 662911 D01

The device bearing the trade name and model specified above, has been shown to comply with the applicable technical standards as indicated in the measurement report and was tested in accordance with the measurement procedures required. The results of testing in this report apply only to the product which was tested. Other similar equipment will not necessarily produce the same results due to production tolerance and measurement uncertainties.

I attest to the accuracy of data. All measurements reported herein were performed by me or were made under my supervision and are correct to the best of my knowledge and belief. I assume full responsibility for the completeness of these measurements and vouch for the qualifications of all persons taking them.

Hyundai C-Tech, Inc. dba HCT America, Inc. certifies that no party to application has been denied the FCC benefits pursuant to Section 5301 of the Anti-Drug Abuse Act of 1988, 21 U.S.C 862

Tested By

Yongsoo Park

Test Engineer

Reviewed By

Sunwoo Kim

Technical Manager

REVISION HISTORY

The revision history for this document is shown in table.

TEST REPORT NO.	DATE	DESCRIPTION
HA221021-SFT-005-R04	November 2, 2022	Initial Issue

TABLE OF CONTENTS

1. GENERAL INFORMATION	4
2. METHODOLOGY	7
3. INSTRUMENT CALIBRATION	7
4. FACILITIES AND ACCREDITATIONS	8
5. ANTENNA REQUIREMENTS	9
6. MEASUREMENT UNCERTAINTY	10
7. DESCRIPTION OF TESTS	11
8. SUMMARY OF TEST RESULTS	25
9. TEST RESULT	30
9.1 6 dB BANDWIDTH / 26 dB BANDWIDTH / 99% BANDWIDTH	30
9.2 OUTPUT POWER	34
9.3 POWER SPECTRAL DENSITY	36
9.4 FREQUENCY STABILITY	38
9.5 RADIATED SPURIOUS EMISSIONS	39
9.6 RADIATED RESTRICTED BAND EDGES	45
9.7 RECEIVER SPURIOUS EMISSIONS	49
9.8 POWERLINE CONDUCTED EMISSIONS	52
10. LIST OF TEST EQUIPMENT	54
APPENDIX A. TEST SETUP PHOTOS	55
APPENDIX B. PHOTOGRAPHS OF EUT	56

1. GENERAL INFORMATION

EUT DESCRIPTION

Model	SA500
EUT Type	IoT Sensor
Serial Number	Radiated : SN1 Conducted : SN4
Power Supply	12 V d.c.
RF Specification	WIFI 5 GHz (U-NII 3) : 802.11a/n(HT20/40)/ ac(VHT20/40/80) Bluetooth LE MCU (1Mbps) Bluetooth LE MESH (1Mbps) RFID (LF/HF)
Transmitter Chain	5 GHz : SISO Bluetooth LE : SISO
Operating Environment	Indoor and outdoor
Operating Temperature	-20 °C ~ 50 °C

RF SPECIFICATION SUBJECT TO THE REPORT

RF Specification	IEEE 802.11a/n(HT20/40)/ac(VHT20/40/80)	
Transmitter Chain	1 (SISO)	
Frequency Range	U-NII 3	20 MHz BW : 5745 MHz – 5825 MHz 40 MHz BW : 5755 MHz – 5795 MHz 80 MHz BW : 5775 MHz
Max. RF Output Power	7.26 dBm (5.32 mW)	
Modulation Type	OFDM	
Antenna Specification ¹⁾	Antenna Type : Chip Antenna Peak Gain : 6.2 dBi	
Firmware Version ²⁾	BLE MCU/RFID (LF/HF) : 1.52.1009 BLE MESH : 1.52.167 WIFI : 1.0.344	
Hardware Version ²⁾	V4	
Date(s) of Tests	May 9, 2022 ~ June 28, 2022	

Note :

1. Antenna information is based on the document provided.
2. Firmware and Hardware Version are as received by the client.

ANTENNA CONFIGURATION

The device employs SISO technologies with possible configurations below.

Frequency	Configuration	ANT
5 GHz	802.11a	O
	802.11n (HT20/40)	O
	802.11ac (VHT20/40/80)	O

ANTENNA DIRECTIONAL GAIN

Antenna Type		RF Technology	Frequency	Gain (Ant)
Chip	Monopole	BLE (MCU)	2.4 GHz	2.0 dBi
Chip	Monopole	BLE (MESH)	2.4 GHz	2.0 dBi
Chip	Monopole	WIFI	5 GHz	6.2 dBi

OPERATING FREQUENCY CHANNELS

Band	Frequency (MHz)	Channel	802.11a	802.11n HT20	802.11ac VHT20
U-NII 3	5745	149	0	0	0
	5765	153	0	0	0
	5785	157	0	0	0
	5805	161	0	0	0
	5825	165	0	0	0

Band	Frequency (MHz)	Channel	802.11n HT40	802.11ac VHT40
U-NII 3	5755	151	0	0
	5795	159	0	0

Band	Frequency (MHz)	Channel	802.11ac VHT80
U-NII 3	5775	155	0

2. METHODOLOGY

The measurement procedure described in FCC KDB 789033 D02 General UNII Test Procedures New Rules v02r01 dated December 14, 2017 entitled "Guidelines for Compliance Testing of Unlicensed National Information Infrastructure (UNII) Devices Part15, Subpart E" and ANSI C63.10(Version : 2013) 'the American National Standard of Procedures for Compliance Testing of Unlicensed Wireless Devices' were used in the measurement.

EUT CONFIGURATION

The EUT configuration for testing is installed on RF field strength measurement to meet the Commissions requirement and operating in a manner that intends to maximize its emission characteristics in a continuous normal application.

EUT EXERCISE

The EUT was operated in the engineering mode to fix the Tx frequency that was for the purpose of the measurements. According to its specifications, the EUT must comply with the requirements of the Section 15.207, 15.209 and 15.407 under the FCC Rules Part 15 Subpart E. / RSS-Gen issue 5, RSS-247 issue 2.

GENERAL TEST PROCEDURES

Conducted Emissions

The EUT is placed on the turntable, which is 0.8 m above ground plane. According to the requirements in Section 6.2 of ANSI C63.10. (Version :2013) Conducted emissions from the EUT measured in the frequency range between 0.15 MHz and 30MHz using CISPR Quasi-peak and average detector modes.

Radiated Emissions

The EUT is placed on a turn table, which is 0.8 m above ground plane below 1GHz. Above 1GHz with 1.5m using absorbers between the EUT and receive antenna. The turntable shall rotate 360 degrees to determine the position of maximum emission level. EUT is set 3 m away from the receiving antenna, which varied from 1 m to 4 m to find out the highest emission. Also, each emission was to be maximized by changing the polarization of receiving antenna both horizontal and vertical. In order to find out the maximum emission, the relative positions of this hand-held transmitter (EUT) were rotated through three orthogonal axes according to the requirements in Section 8 of ANSI C63.10. (Version: 2013)

DESCRIPTION OF TEST MODES

The EUT has been tested at 5 GHz WLAN test mode. Each radio mode, channel, and output power were controlled by entering RF command through Tera term. The EUT was set to transmit continuously for each 802.11a/n(HT20/40) / ac(VHT20/40/80) modes.

3. INSTRUMENT CALIBRATION

The measuring equipment, which was utilized in performing the tests documented herein, has been calibrated in accordance with the manufacturer's recommendations for utilizing calibration equipment's, which is traceable to recognized national standards. Especially, all antenna for measurement is calibrated in accordance with the requirements of C63.5 (Version : 2017).

4. FACILITIES AND ACCREDITATIONS

FACILITIES

The SAC (Semi-Anechoic Chamber) and conducted measurement facility used to collect the radiated data are located at 1726 Ringwood Avenue, San Jose, California 95131, USA.

The site is constructed in conformance with the requirements of ANSI C63.4. (Version :2014) and CISPR Publication 22.



EQUIPMENT

Radiated emissions are measured with one or more of the following types of Linearly polarized antennas: tuned dipole, bi-conical, log periodic, bi-log, and/or ridged waveguide, horn. Spectrum analyzers with pre-selectors and quasi-peak detectors are used to perform radiated measurements.

Conducted emissions are measured with Line Impedance Stabilization Networks and EMI Test Receivers. Calibrated wideband preamplifiers, coaxial cables, and coaxial attenuators are also used for making measurements.

All receiving equipment conforms to CISPR Publication 16-1, "Radio Interference Measuring Apparatus and Measurement Methods."

5. ANTENNA REQUIREMENTS

According to FCC 47 CFR §15.203:

“An intentional radiator antenna shall be designed to ensure that no antenna other than that furnished by the responsible party can be used with the device. The use of a permanently attached antenna or of an antenna that uses a unique coupling to the intentional radiator shall be considered sufficient to comply with the provisions of this section.”

- (1) The antenna of this E.U.T is permanently attached and there is no provision for connection to an external antenna.
- (2) The E.U.T Complies with the requirement of §15.203

According to RSS-Gen Issue 5 (Section 6.8) :

The applicant for equipment certification shall provide a list of all antenna types that may be used with the transmitter, where applicable (i.e. for transmitters with detachable antenna), indicating the maximum permissible antenna gain (in dBi) and the required impedance for each antenna. The test report shall demonstrate the compliance of the transmitter with the limit for maximum equivalent isotropically radiated power (e.i.r.p.) specified in the applicable RSS, when the transmitter is equipped with any antenna type, selected from this list.

For expediting the testing, measurements may be performed using only the antenna with highest gain of each combination of transmitter and antenna type, with the transmitter output power set at the maximum level. However, the transmitter shall comply with the applicable requirements under all operational conditions and when in combination with any type of antenna from the list provided in the test report (and in the notice to be included in the user manual, provided below).

When measurements at the antenna port are used to determine the RF output power, the effective gain of the device's antenna shall be stated, based on a measurement or on data from the antenna's manufacturer.

The test report shall state the RF power, output power setting and spurious emission measurements with each antenna type that is used with the transmitter being tested.

6. MEASUREMENT UNCERTAINTY

The measurement uncertainties shown below were calculated in accordance with the requirements of ANSI C63.10-2013.

All measurement uncertainty values are shown with a coverage factor of $k = 2$ to indicate a 95 % level of confidence. The measurement data shown herein meets or exceeds the U_{CISPR} measurement uncertainty values specified in CISPR 16-4-2 and, thus, can be compared directly to specified limits to determine compliance.

Parameter	Expanded Uncertainty
Output Power, Conducted	± 0.35 dB
Occupied Bandwidth	± 12.4 kHz
Unwanted Emissions, Conducted	± 0.46 dB
Radiated Emissions (below 1 GHz)	± 6.09 dB
Radiated Emissions (Above 1 GHz)	± 5.23 dB

7. DESCRIPTION OF TESTS

7.1. DUTY CYCLE

TEST SETUP

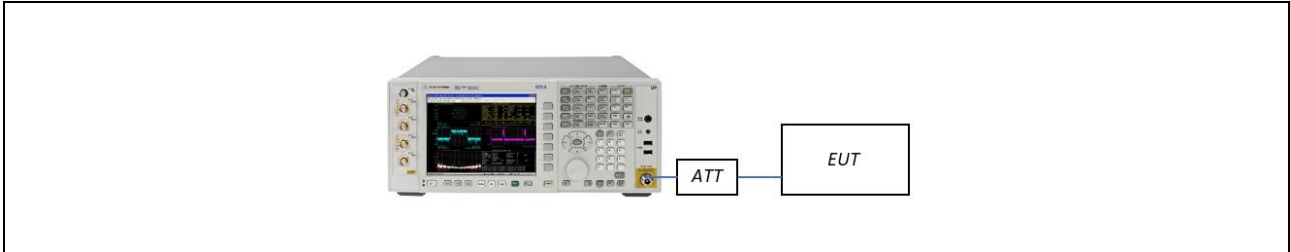

TEST PROCEDURE

The transmitter output is connected to the Spectrum Analyzer.
Measurement is performed in accordance with the section B.2 in KDB 789033 D02 v02r01.

The largest available value of RBW is 8 MHz and VBW is 50 MHz.

The zero-span method of measuring duty cycle shall not be used if $T \leq 6.25$ microseconds. ($50/6.25 = 8$)

The zero-span method was used because all measured T data are > 6.25 microseconds and both RBW and VBW are $> 50/T$.

- RBW = 8 MHz (the largest available value)
- VBW = 8 MHz (\geq RBW)
- SPAN = 0 Hz
- Detector = Peak
- Number of points in sweep > 100
- Trace mode = Clear write
- Measure T_{total} and T_{on}
- Calculate Duty Cycle = T_{on} / T_{total} and Duty Cycle Factor = $10 * \log(1/\text{Duty Cycle})$

7.2. 6 dB BANDWIDTH / 26 dB BANDWIDTH / 99 % OCCUPIED BANDWIDTH

LIMIT

Emission bandwidth was measured to define the minimum frequency range which the spectrum is integrated for maximum conducted output power measurement.

Within the 5.725-5.85 GHz band, the minimum 6 dB bandwidth of U-NII devices shall be at least 500 kHz.

TEST SETUP

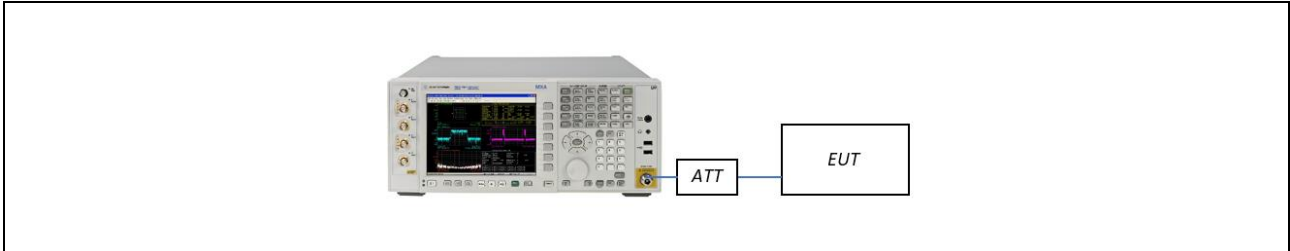

TEST PROCEDURE (26 dB Bandwidth)

Testing was performed according to the section C.1 in KDB 789033 D02 v02r01.
The transmitter output is connected to the spectrum analyzer.

- RBW = Approximately 1 % of the emission bandwidth
- VBW > RBW
- Detector = Peak
- Trace mode = max hold
- Sweep = auto couple
- Measure the maximum width of the emission that is 26 dB down from the maximum of the emission. Compare this with the RBW setting of the analyzer. Readjust RBW and repeat measurement as needed until the RBW/EBW ratio is approximately 1 %.

TEST PROCEDURE (6 dB Bandwidth)

Testing was performed according to the procedure C.1 in KDB 789033 D02 v02r01.
The transmitter output is connected to the Spectrum Analyzer.

- RBW = 100 kHz
- VBW $\geq 3 \times$ RBW
- Detector = Peak
- Trace mode = Max hold
- Allow the trace to stabilize
- Measure the maximum width of the emission that is constrained by the frequencies associated with the two outermost amplitude points (upper and lower frequencies) that are attenuated by 6 dB relative to the maximum level measured in the fundamental emission.

Note:

1. The bandwidth measurement function from the spectrum analyzer is used to measure X dB bandwidth.
2. 26 dB bandwidth is used to determine the conducted power limits.

TEST PROCEDURE (99% Bandwidth)

Testing was performed according to the section D in KDB 789033 D02 v02r01.
The transmitter output is connected to the spectrum analyzer.

- RBW = 1% ~ 5% of the occupied bandwidth
- VBW \cong 3 x RBW
- Detector = Peak
- Trace mode = max hold
- Sweep = auto couple
- Allow the trace to stabilize

7.3. OUTPUT POWER

LIMIT

Band	47 CFR §15.407(a)(3)(i)	RSS-247, 6.2.4.1
U-NII 3	≤ 1 W (30 dBm)	≤ 1 W (30 dBm)

If transmitting antennas of directional gain greater than 6 dBi are used, the maximum conducted output power shall be reduced by the amount in dB that the directional gain of the antenna exceeds 6 dBi.

TEST SETUP

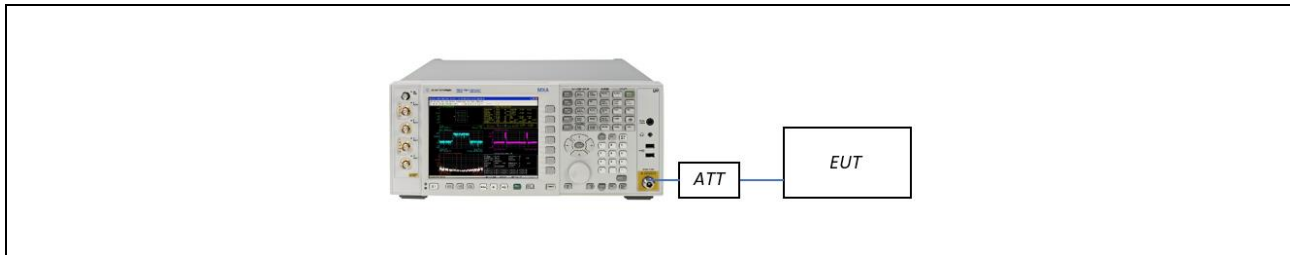

TEST PROCEDURE

Refer to the section E.2.d) in KDB 789033 D02 v02r01

The transmitter output is connected to the Spectrum Analyzer.

Spectrum analyzer's integrated band power measurement function was used.

- Measure the duty cycle.
- Set span to encompass the 26 dB EBW or 99 % OBW of the signal.
- RBW = 1 MHz
- VBW ≥ 3 MHz
- Number of points in sweep ≥ 2*span/RBW.
- Sweep time = auto.
- Detector = RMS.
- Do not use sweep triggering. Allow the sweep to "free run".
- Trace average at least 100 traces in power averaging (RMS) mode
- Integrated bandwidth = EBW

Add $10\log(1/x)$, where x is the duty cycle, to the measured power in order to compute the average power during the actual transmission times

Sample Calculation

- Conducted Output Power (Average) = Reading Value + ATT loss + Cable loss + Duty Cycle Factor

7.4. POWER SPECTRAL DENSITY

LIMIT

Band	47 CFR §15.407(a)(3)(i)	RSS-247, 6.2.4.1
U-NII 3	≤ 30 dBm/500 kHz	≤ 30 dBm/500 kHz

If transmitting antennas of directional gain greater than 6 dBi are used, both the maximum power spectral density shall be reduced by the amount in dB that the directional gain of the antenna exceeds 6 dBi.

TEST SETUP

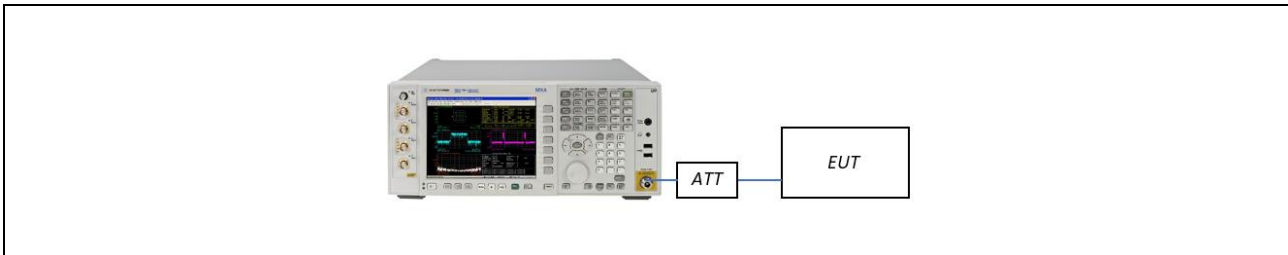

TEST PROCEDURE

Refer to the section F in KDB 789033 D02 v02r01.

- Set span to encompass the entire emission bandwidth (EBW) of the signal.
- RBW = 510 kHz
- VBW ≥ 3 MHz
- Number of points in sweep ≥ 2*span/RBW.
- Sweep time = auto.
- Detector = RMS (i.e., power averaging), if available. Otherwise, use sample detector mode.
- Do not use sweep triggering. Allow the sweep to “free run”.
- Trace average at least 100 traces in power averaging (RMS) mode
- Use the peak search function on the spectrum analyzer to find the peak of the spectrum.
- If Method SA-2 was used, add $10 \log(1/x)$, where x is the duty cycle, to the peak of the spectrum.

Sample Calculation

Total PSD (Average) = Reading Value + ATT loss + Cable loss + Duty Cycle Factor

7.5. FREQUENCY STABILITY

LIMIT

§15.407(g) / RSS-Gen, 8.11

Fundamental emissions of the radio devices should be kept within at least the central 80% of its permitted operating frequency band to minimize the possibility of out of band operation.

TEST SETUP

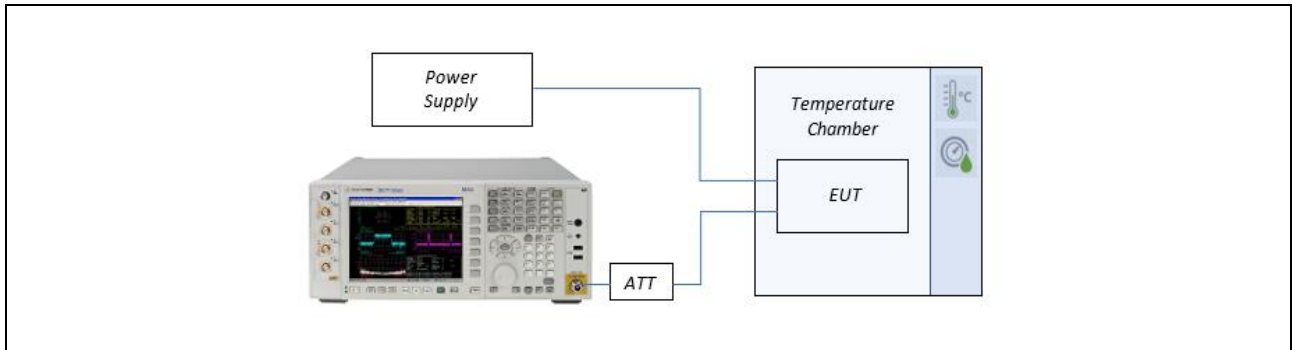

TEST PROCEDURE

- The EUT was placed inside an environmental chamber as the temperature in the chamber was varied between -30 °C and 50 °C.
- The temperature was incremented by 10 °C intervals and the unit was allowed to stabilize at each temperature before each measurement. The center frequency of the transmitting channel was evaluated at each temperature and the frequency deviation from the channel's center frequency was recorded.
- The primary supply voltage is varied from 85% to 115% of the nominal value for non-hand carried battery and AC powered equipment. For hand-carried, battery-powered equipment, primary supply voltage is reduced to the battery operating end point which shall be specified by the manufacturer.
- While maintaining a constant temperature inside the environmental chamber, turn the EUT ON and record the operating frequency at startup, and at 2 minutes, 5 minutes, and 10 minutes after the EUT is energized. Four measurements in total are made.

7.6. UNDESIRABLE EMISSION

LIMIT

Frequency Band	47 CFR § 15.407(b)(4) / RSS-247, 6.2.4.2
U-NII 3	In accordance with 47 CFR § 15.407(b)(4) / RSS-247, 6.2.4.2 All emissions shall be limited to a level of -27 dBm/MHz at 75 MHz or more above or below the band edge increasing linearly to 10 dBm/MHz at 25 MHz above or below the band edge, and from 25 MHz above or below the band edge increasing linearly to a level of 15.6 dBm/MHz at 5 MHz above or below the band edge, and from 5 MHz above or below the band edge increasing linearly to a level of 27 dBm/MHz at the band edge.

7.7. RADIATED EMISSIONS

RADIATION EMISSION LIMIT

FCC : 47 CFR § 15.209		
Frequency (MHz)	Field Strength (uV/m)	Measurement Distance (m)
0.009 – 0.490	2400/F(kHz)	300
0.490 – 1.705	24000/F(kHz)	30
1.705 – 30	30	30
30-88	100	3
88-216	150	3
216-960	200	3
Above 960	500	3

ISED : RSS-GEN Section 8.9		
Frequency (MHz)	Field Strength (uV/m)	Measurement Distance (m)
0.009 – 0.490	6.37/F(kHz)	300
0.490 – 1.705	63.7/F(kHz)	30
1.705 – 30	0.08	30
30-88	100	3
88-216	150	3
216-960	200	3
Above 960	500	3

RECEIVER RADIATED EMISSION LIMIT

ISED : RSS-GEN Section 7.3		
Frequency (MHz)	Field Strength (uV/m)	Measurement Distance (m)
30-88	100	3
88-216	150	3
216-960	200	3
Above 960	500	3

RESTRICTED BANDS OF OPERATION

FCC : 47 CFR § 15.205(a)				
Frequency (MHz)	Frequency (MHz)	Frequency (MHz)	Frequency (MHz)	Frequency (MHz)
0.090 - 0.110	12.29 - 12.293	149.9 - 150.05	1660.0 - 1710.0	8025 - 8500
0.495 - 0.505	12.51975 - 12.52025	156.52475 - 156.52525	1718.8 - 1722.2	9000 - 9200
2.1735 - 2.1905	12.57675 - 12.57725	156.7 - 156.9	2200.0 - 2300.0	9300 - 9500
4.125 - 4.128	13.36 - 13.41	162.0125 - 167.17	2310.0 - 2390.0	10600 - 12700
4.17725 - 4.17775	16.42 - 16.423	167.72 - 173.2	2483.5 - 2500.0	13250 - 13400
4.20725 - 4.20775	16.69475 - 16.69525	240.0 - 285.0	2690.0 - 2900.0	14470 - 14500
6.215 - 6.218	16.80425 - 16.80475	322.0 - 335.4	3260.0 - 3267.0	15350 - 16200
6.26775 - 6.26825	25.5 - 25.67	399.9 - 410.0	3332.0 - 3339.0	17700 - 21400
6.31175 - 6.31225	37.5 - 38.25	608.0 - 614.0	3345.8 - 3358.0	22010 - 23120
8.291 - 8.294	73 - 74.6	960.0 - 1240.0	3600.0 - 4400.0	23600 - 24000
8.362 - 8.366	74.8 - 75.2	1300.0 - 1427.0	4500.0 - 5150.0	31200 - 31800
8.37625 - 8.38675	108 - 121.94	1435.0 - 1626.5	5350.0 - 5460.0	36430 - 36500
8.41425 - 8.41475	123 - 138	1645.5 - 1646.5	7250.0 - 7750.0	Above 38600

ISED : RSS-GEN Section 8.10				
Frequency (MHz)	Frequency (MHz)	Frequency (MHz)	Frequency (MHz)	Frequency (MHz)
0.090 - 0.110	8.37625 - 8.38675	108 - 138	1660 - 1710	8025 - 8500
0.495 - 0.505	8.41425 - 8.41475	149.9 - 150.05	1718.8 - 1722.2	9000 - 9200
2.1735 - 2.1905	12.29 - 12.293	156.52475 - 156.52525	2200 - 2300	9300 - 9500
3.020 - 3.026	12.51975 - 12.52025	156.7 - 156.9	2310 - 2390	10600 - 12700
4.125 - 4.128	12.57675 - 12.57725	162.0125 - 167.17	2483.5 - 2500	13250 - 13400
4.17725 - 4.17775	13.36 - 13.41	167.72 - 173.2	2655 - 2900	14470 - 14500
4.20725 - 4.20775	16.42 - 16.423	240 - 285	3260 - 3267	15350 - 16200
5.677 - 5.683	16.69475 - 16.69525	322 - 335.4	3332 - 3339	17700 - 21400
6.215 - 6.218	16.80425 - 16.80475	399.9 - 410	3345.8 - 3358	22010 - 23120
6.26775 - 6.26825	25.5 - 25.67	608 - 614	3500 - 4400	23600 - 24000
6.31175 - 6.31225	37.5 - 38.25	960 - 1427	4500 - 5150	31200 - 31800
8.291 - 8.294	73 - 74.6	1435 - 1626.5	5350 - 5460	36430 - 36500
8.362 - 8.366	74.8 - 75.2	1645.5 - 1646.5	7250 - 7750	Above 38600

TEST SETUP

Below 30 MHz

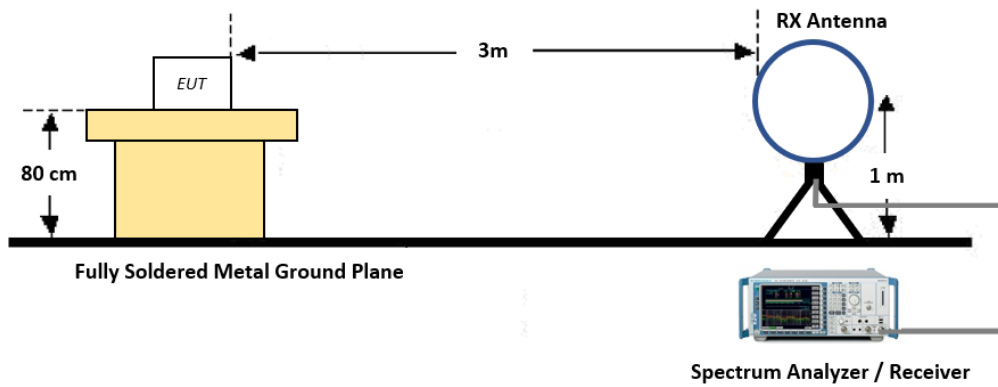

30 MHz - 1 GHz

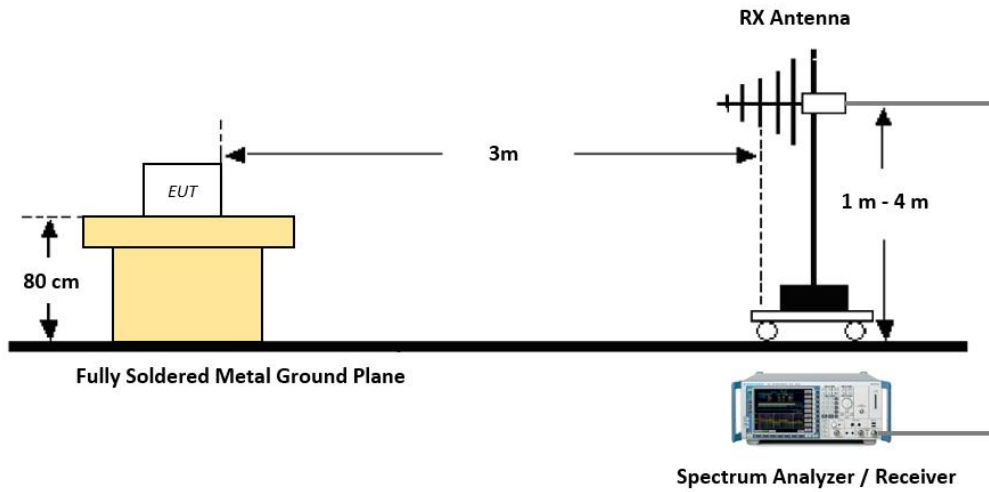

Above 1 GHz

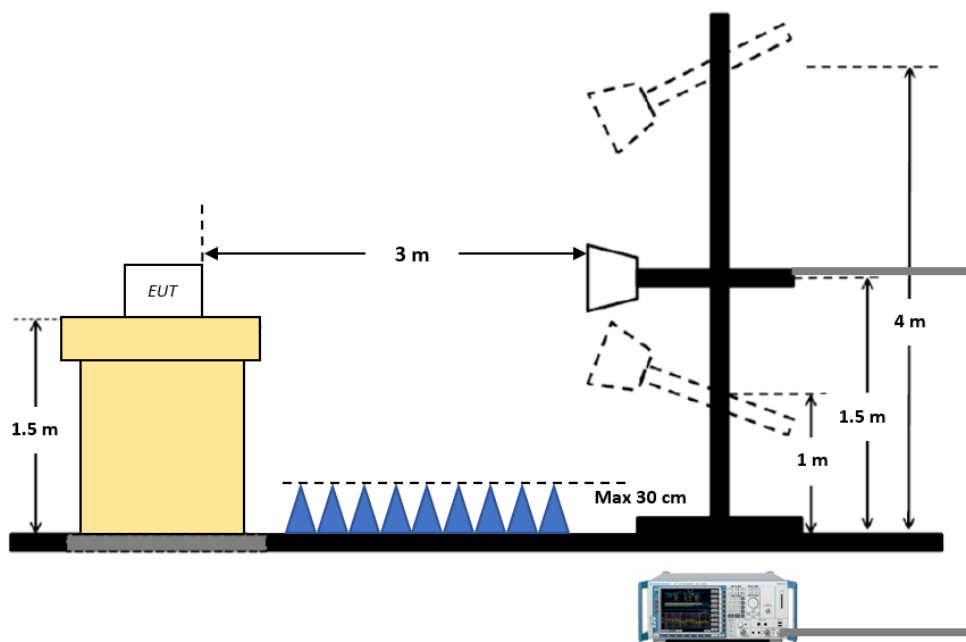

TEST PROCEDURE OF RADIATED SPURIOUS EMISSION (BELOW 30 MHz)

1. The EUT was placed on a non-conductive table located on semi-anechoic chamber.
2. The loop antenna was placed at a location 3m from the EUT
3. The EUT is placed on a turntable, which is 0.8m above ground plane.
4. We have done x, y, z planes in EUT and horizontal and vertical polarization in detecting antenna.
5. The turntable shall be rotated for 360 degrees to determine the position of maximum emission level.
6. Distance Correction Factor (0.009 MHz – 0.490 MHz) = $40 \cdot \log(3 \text{ m}/300 \text{ m}) = - 80 \text{ dB}$
Measurement Distance: 3 m
7. Distance Correction Factor (0.490 MHz – 30 MHz) = $40 \cdot \log(3 \text{ m}/30 \text{ m}) = - 40 \text{ dB}$
Measurement Distance: 3 m
8. Spectrum Setting
 - Frequency Range = 9 kHz ~ 30 MHz
 - Detector = Peak
 - Trace = Max hold
 - RBW = 9 kHz
 - VBW $\geq 3 \cdot \text{RBW}$
9. Total = Reading Value + Antenna Factor (A.F) + Cable Loss (C.L)
10. There is a comparison data both open-field test site and alternative test site – semi-Anechoic chamber according to 414788 D01. And the results are properly calibrated.

TEST PROCEDURE OF RADIATED SPURIOUS EMISSION (30 MHz – 1 GHz)

1. The EUT was placed on a non-conductive table located on semi-anechoic chamber.
2. The EUT is placed on a turntable, which is 0.8 m above ground plane.
3. We have done x, y, z planes in EUT and horizontal and vertical polarization in detecting antenna.
4. The turntable shall be rotated for 360 degrees to determine the position of maximum emission level.
5. Spectrum Setting
 - (1) Measurement Type (Peak):
 - Measured Frequency Range: 30 MHz – 1 GHz
 - Detector = Peak
 - Trace = Max hold
 - RBW = 100 kHz
 - VBW $\geq 3 \cdot \text{RBW}$
 - (2) Measurement Type(Quasi-peak):
 - Measured Frequency Range: 30 MHz – 1 GHz
 - Detector = Quasi-Peak
 - RBW = 120 kHz
6. Total = Reading Value + Antenna Factor (A.F) + Cable Loss (C.L)

TEST PROCEDURE OF RADIATED SPURIOUS EMISSION (ABOVE 1 GHz)

1. The EUT is placed on a turntable, which is 1.5 m above ground plane.
2. We have done x, y, z planes in EUT and horizontal and vertical polarization in detecting antenna.
3. The turntable shall be rotated for 360 degrees to determine the position of maximum emission level.
4. EUT is set 3 m away from the receiving antenna, which is varied from 1m to 4m to find out the highest emissions.
5. Maximum procedure was performed on the six highest emissions to ensure EUT compliance.
6. Each emission was to be maximized by changing the polarization of receiving antenna both horizontal and vertical.
7. The unit was tested with its standard battery.
8. Spectrum Setting

(1) Measurement Type(Peak, G.5 in KDB 789033 v02r01):

- RBW = 1 MHz
- VBW \geq 3 MHz
- Detector = Peak
- Sweep Time = auto
- Trace mode = Max hold
- Allow sweeps to continue until the trace stabilizes.
- Note that if the transmission is not continuous, the time required for the trace to stabilize will increase by a factor of approximately $1/x$, where x is the duty cycle.

(2) Measurement Type(Average, G.6.d in KDB 789033 v02r01):

- RBW = 1 MHz
- VBW(Duty cycle \geq 98 percent) = $VBW \leq RBW/100$ (i.e., 10 kHz) but not less than 10 Hz.
- VBW(Duty cycle is < 98 percent) = $VBW \geq 1/T$, where T is the minimum transmission duration.
- The analyzer is set to linear detector mode.
- Detector = Peak.
- Sweep time = auto.
- Trace mode = Max hold.
- Allow max hold to run for at least 50 traces if the transmitted signal is continuous or has at least 98 percent duty cycle. For lower duty cycles, increase the minimum number of traces by a factor of $1/x$, where x is the duty cycle.

9. Measurement value only up to 6 maximum emissions noted or would be lesser if no specific emissions from the EUT are recorded (i.e.: margin > 20 dB from the applicable limit) and considered that's already beyond the background noise floor

10. Measuring frequencies from 1 GHz to the 10th harmonic of highest fundamental frequency (or 40 GHz whichever comes first)

11. Sample Calculation

(1) Total (Peak) = Reading Value + Antenna Factor(A.F) + Cable Loss(C.L) - Amp Gain(G)

(2) Total (Average, Duty \geq 98%) = Reading Value + Antenna Factor(A.F) + Cable Loss(C.L) - Amp Gain(G)

(3) Total (Average, Duty < 98%) = Reading Value + Antenna Factor(A.F) + Cable Loss(C.L) - Amp Gain(G) + Duty Cycle Factor

TEST PROCEDURE OF RADIATED RESTRICTED BAND EDGE

1. Radiated test is performed with hopping off (if there is any)
2. The EUT is placed on a turntable, which is 1.5 m above ground plane.
3. We have done x, y, z planes in EUT and horizontal and vertical polarization in detecting antenna.
4. The turntable shall be rotated for 360 degrees to determine the position of maximum emission level.
5. EUT is set 3 m away from the receiving antenna, which is varied from 1m to 4m to find out the highest emissions.
6. Each emission was to be maximized by changing the polarization of receiving antenna both horizontal and vertical.
7. The unit was tested with its standard battery.
8. Spectrum Setting

(1) Measurement Type(Peak, G.5 in KDB 789033 v02r01):

- RBW = 1 MHz
- VBW \geq 3 MHz
- Detector = Peak
- Sweep Time = auto
- Trace mode = Max hold
- Allow sweeps to continue until the trace stabilizes.
- Note that if the transmission is not continuous, the time required for the trace to stabilize will increase by a factor of approximately $1/x$, where x is the duty cycle.

(2) Measurement Type(Average, G.6.d in KDB 789033 v02r01):

- RBW = 1 MHz
- VBW(Duty cycle \geq 98 percent) = $VBW \leq RBW/100$ (i.e., 10 kHz) but not less than 10 Hz.
- VBW(Duty cycle is < 98 percent) = $VBW \geq 1/T$, where T is the minimum transmission duration.
- The analyzer is set to linear detector mode.
- Detector = Peak.
- Sweep time = auto.
- Trace mode = Max hold.
- Allow max hold to run for at least 50 traces if the transmitted signal is continuous or has at least 98 percent duty cycle. For lower duty cycles, increase the minimum number of traces by a factor of $1/x$, where x is the duty cycle.

9. Sample Calculation

(1) Total (Peak) = Reading Value + Antenna Factor(A.F) + Cable Loss(C.L)

(2) Total (Average, Duty \geq 98%) = Reading Value + Antenna Factor(A.F) + Cable Loss(C.L) - Amp Gain(G)

(3) Total (Average, Duty < 98%) = Reading Value + Antenna Factor(A.F) + Cable Loss(C.L) - Amp Gain(G) + Duty Cycle Factor

7.8. AC POWER LINE CONDUCTED EMISSIONS

LIMIT

47 CFR § 15.207 / RSS-GEN Section 8.8

For an intentional radiator that is designed to be connected to the public utility (AC) power line, the radio frequency voltage that is conducted back onto the AC power line on any frequency or frequencies, within the band 150 kHz to 30 MHz, shall not exceed the limits in the following table, as measured using a 50 μ H/50 ohms line impedance stabilization network (LISN).

Frequency Range (MHz)	Limits (dB μ V)	
	Quasi-peak	Average
0.15 to 0.50	66 to 56*	56 to 46*
0.50 to 5	56	46
5 to 30	60	50

*Decreases with the logarithm of the frequency.

Compliance with this provision shall be based on the measurement of the radio frequency voltage between each power line (LINE and NEUTRAL) and ground at the power terminals.

TEST SETUP

See test photographs attached in Annex A for the actual connections between EUT and support equipment.

TEST PROCEDURE

1. The EUT is placed on a wooden table 80 cm above the reference ground plane.
2. The EUT is connected via LISN to a test power supply.
3. The measurement results are obtained as described below:
4. Detectors : Quasi Peak and Average Detector.

According to FCC KDB 174176 D01 Line Conducted FAQ v01r01 :

Devices Operating Above 30 MHz

For a device with a permanent or detachable antenna operating above 30 MHz, measurements must be performed with the antenna connected as specified in clause 6.2 of ANSI C63.10-2013.

Devices Operating Below 30 MHz

For a device with a permanent or detachable antenna operating at or below 30 MHz, the FCC will accept measurements performed with a suitable dummy load in lieu of the antenna under the following conditions:

- (1) Perform the AC power-line conducted tests with the antenna connected to determine compliance with Section 15.207 limits outside the transmitter's fundamental emission band;
- (2) Retest with a dummy load in lieu of the antenna to determine compliance with Section 15.207 limits within the transmitter's fundamental emission band. For a detachable antenna, remove the antenna and connect a suitable dummy load to the antenna connector. For a permanent antenna, remove the antenna and terminate the RF output with a dummy load or network which simulates the antenna in the fundamental frequency band. All measurements must be performed as specified in clause 6.2 of ANSI C63.10-2013.

Sample Calculation

Quasi-peak(Final Result) = Reading Value + Correction Factor

8. SUMMARY OF TEST RESULTS

Test Description	FCC Part Section(s)	ISED Part Section(s)	Test Limit	Test Condition	Test Result
26 dB Bandwidth	§15.407	-	N/A (For power measurement)	Conducted	-
6 dB Bandwidth	§15.407(e)	RSS-247, 6.2.4.1	≥ 500 kHz		PASS
Occupied bandwidth	-	RSS-Gen, 6.7	N/A		-
Maximum Conducted Output Power	§15.407(a)(3)(i)	RSS-247, 6.2.4.1	≤ 1 W		PASS
Power Spectral Density	§15.407(a)(3)(i)	RSS-247, 6.2.4.1	≤ 30 dBm/500 kHz		PASS
Frequency Stability	§15.407(g) §2.1055	RSS-Gen, 8.11	Maintained within the band		PASS
AC Power line Conducted Emissions	§15.207 §15.407(b)(9)	RSS-Gen, 8.8	cf. Section 7.8		PASS
Undesirable Emissions	§15.407(b)(4)	RSS-247, 6.2.4.2	cf. Section 7.6	Radiated	PASS
Radiated Spurious Emissions	§15.209 §15.407(b)(9)	RSS-Gen, 8.9	cf. Section 7.7		PASS
Radiated Restricted Band Edge	§15.407(b)(7) §15.205(a)	RSS-Gen, 8.10	cf. Section 7.7		PASS
Receiver Spurious Emissions	-	RSS-Gen, 7.3	cf. Section 7.7		PASS

Note(s) :

According to the comparative measurement data in the Evaluation Report, all measurement data from the reference FCC ID below were reused for this report.

FCC ID : 2ANI5SA530

WORST CASE CONFIGURATION

RADIATED TEST

1. EUT Axis

- All X, Y, and Z positions for horizontal / vertical antenna polarization were investigated to find the worst-case position.
- Y position was selected for the final evaluation.

2. Operations with all the data rates available were investigated for each different channel BW mode. Lowest data rate was selected as the worst case.

3. Radiated test modes

- Radiated band edge test was conducted for each different mode and bandwidth. 802.11a/n(HT20/40)/ac(VHT80) modes were reported as the worst case
- Radiated spurious emission test was performed for each different bandwidth. 802.11a, 802.11n HT40 modes were reported as the worst-case spurious emission.
- Receiver spurious emission test was performed for each mode and reported 802.11a mode as the worst case.

CONDUCTED TEST

1. AC line conducted emission test was performed at the worst case transmission mode.

WORST CASE DATA RATE

Mode	Worst Case Data Rate
802.11a	6 Mbps
802.11n	MCS0
802.11ac	MCS0

CHANNEL UNDER TEST

Mode (U-NII 3)	Bandwidth (MHz)	Low Channel (MHz)	Mid Channel (MHz)	High Channel (MHz)
802.11a	20	5745	5785	5825
802.11n	20	5745	5785	5825
	40	5755	-	5795
802.11ac	80	5775		

SUMMARY OF OUTPUT POWER

Bandwidth	Mode	Max Output Power (dBm)	Max Output Power (mW)	Channel Frequency (MHz)
20 MHz	802.11a	7.25	5.31	5745
	802.11n HT20	7.26	5.32	5745
40 MHz	802.11n HT40	7.20	5.25	5755
80 MHz	802.11ac VHT80	6.95	4.95	5775

SUMMARY OF POWER LEVEL SETTING

U-NII 3 Band (20 MHz)		Power Level Setting / Chain		
Frequency (MHz)	Channel	802.11a	802.11n HT20	802.11ac VHT20
5745	149	64	64	64
5765	153	64	64	64
5785	157	64	64	64
5805	161	64	64	64
5825	165	64	64	64

U-NII 3 Band (40 MHz)		Power Level Setting / Chain	
Frequency (MHz)	Channel	802.11n HT40	802.11ac VHT40
5755	151	64	64
5795	159	64	64

U-NII 3 Band (80 MHz)		Power Level Setting / Chain
Frequency (MHz)	Channel	802.11ac VHT80
5775	155	64

TEST CONFIGURATION

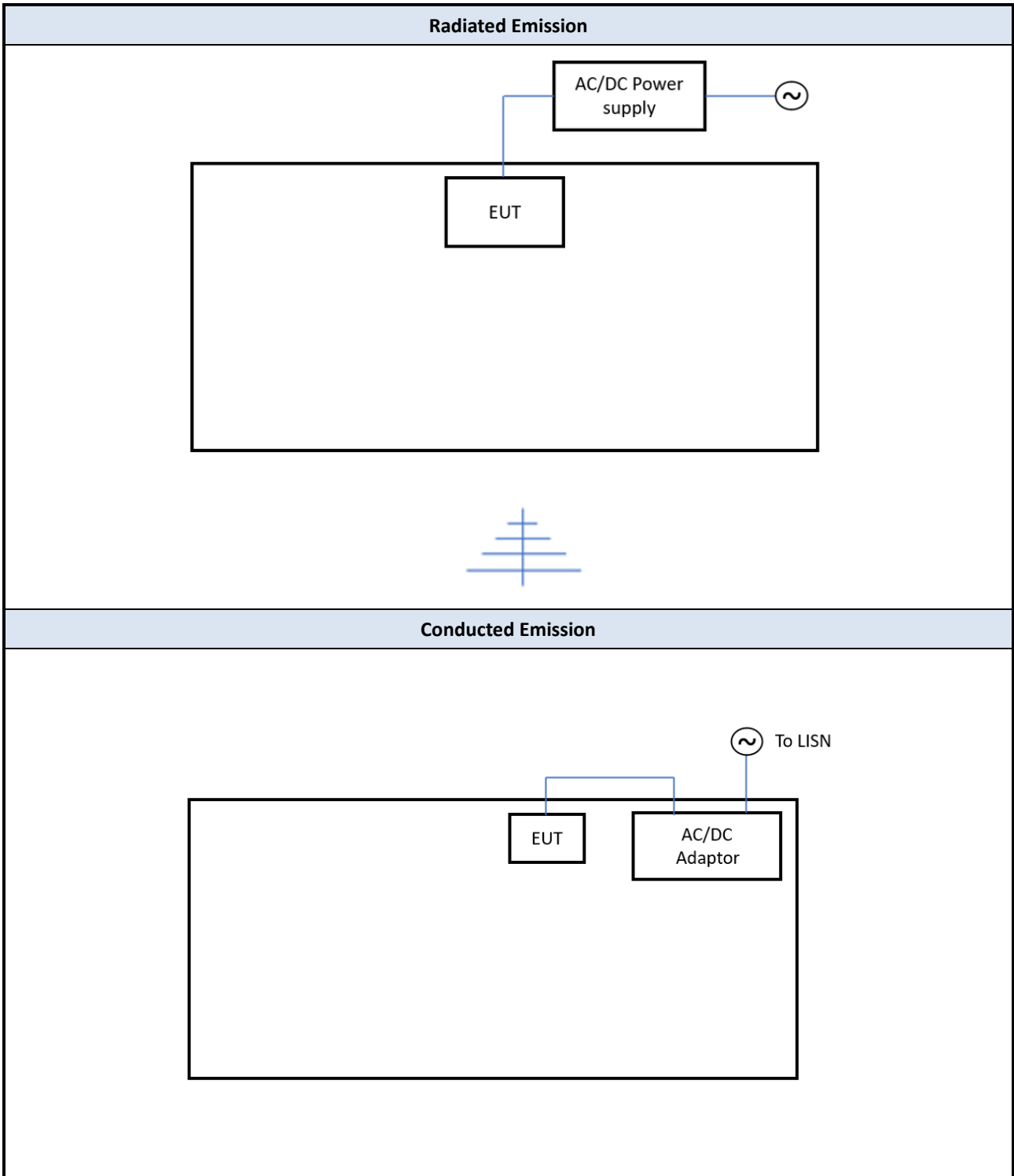

LIST OF SUPPORT EQUIPMENT

Equipment Type	Model No.	Serial Number	Manufacturer	Qty	Note
AC/DC Adaptor (For AC line conducted Emission)	MU18-D120150-A1	DP8C231701641	LEADER ELECTRONICS	1	Input: 100-240 V~, 0.6 A, 50/60 Hz Output: 12 V d.c., 1.5 A

9. TEST RESULT

9.1 6 dB BANDWIDTH / 26 dB BANDWIDTH / 99% BANDWIDTH

U-NII 3 Band (20 MHz)			99% Bandwidth (MHz)	26 dB Bandwidth (MHz)
Mode	Frequency (MHz)	Channel	Chain 0	Chain 0
802.11a	5745	149	18.860	33.661
	5785	157	17.970	32.710
	5825	165	18.607	32.457
802.11n HT20	5745	149	19.006	34.785
	5785	157	18.800	33.651
	5825	165	19.100	34.523

U-NII 3 Band (40 MHz)			99% Bandwidth (MHz)	26 dB Bandwidth (MHz)
Mode	Frequency (MHz)	Channel	Chain 0	Chain 0
802.11n HT40	5755	151	39.961	78.806
	5795	159	38.244	77.337

U-NII 3 Band (80 MHz)			99% Bandwidth (MHz)	26 dB Bandwidth (MHz)
Mode	Frequency (MHz)	Channel	Chain 0	Chain 0
802.11ac VHT80	5775	155	76.717	120.000

U-NII 3 Band (20 MHz)			6 dB Bandwidth (MHz)	
Mode	Frequency (MHz)	Channel	Chain 0	Limit
802.11a	5745	149	16.354	≥ 0.5
	5785	157	16.347	
	5825	165	16.379	
802.11n HT20	5745	149	17.602	≥ 0.5
	5785	157	17.606	
	5825	165	17.581	

U-NII 3 Band (40 MHz)			6 dB Bandwidth (MHz)	
Mode	Frequency (MHz)	Channel	Chain 0	Limit
802.11n HT40	5755	151	36.353	≥ 0.5
	5795	159	35.780	

U-NII 3 Band (80 MHz)			6 dB Bandwidth (MHz)	
Mode	Frequency (MHz)	Channel	Chain 0	Limit
802.11ac VHT80	5775	155	75.322	≥ 0.5

TEST PLOTS

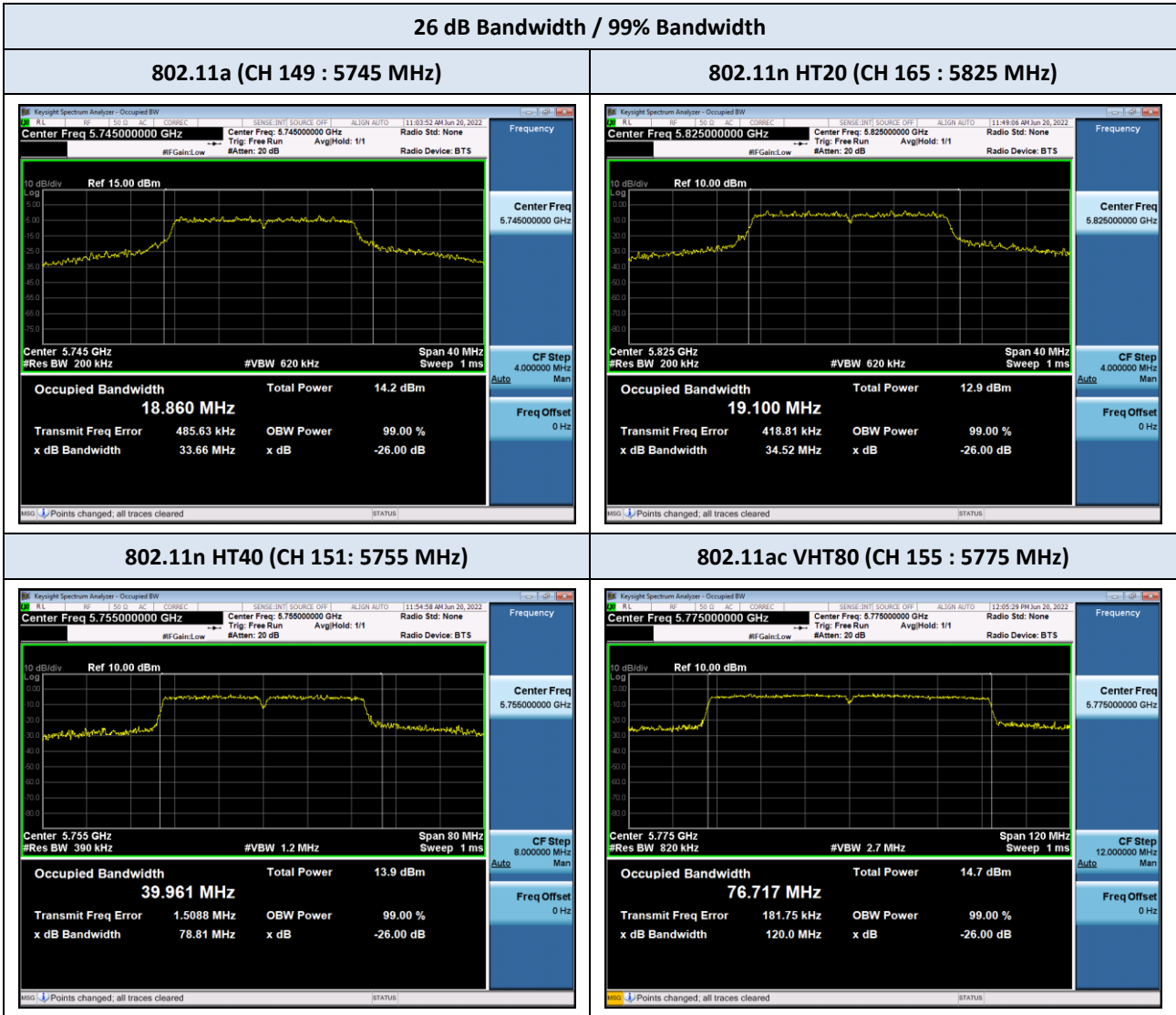

Note :
The worst plots are reported for each bandwidth mode.

TEST PLOTS

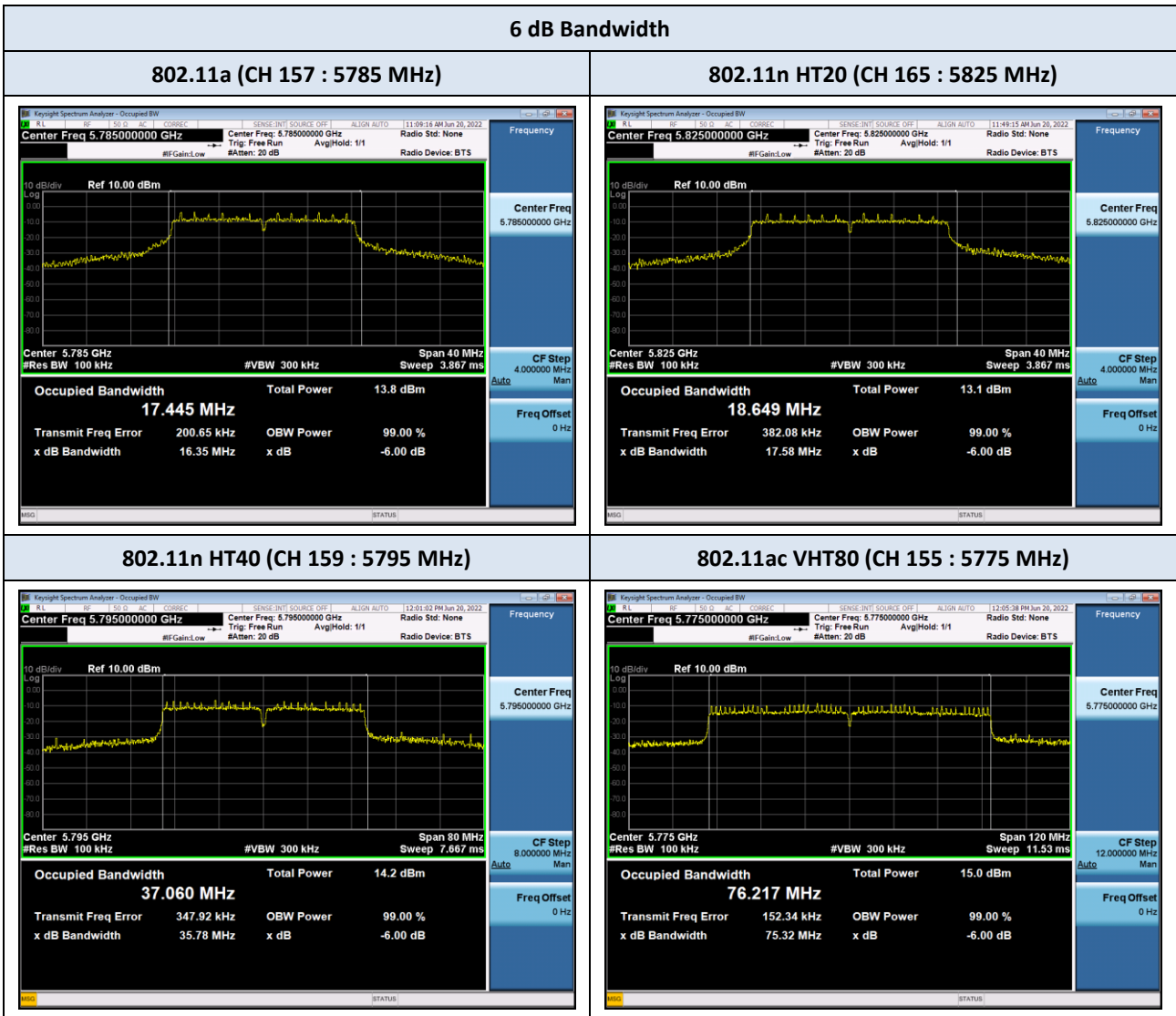

Note :
The worst plots are reported for each bandwidth mode.

9.2 OUTPUT POWER

U-NII 3 Band (20 MHz)				Test Result			
Mode	Frequency (MHz)	Channel	Data Rate	Measured Power (dBm)	Duty Factor (dB) ²⁾	Total Power (dBm)	Limit (dBm) ³⁾
				Chain 0		Chain 0	
802.11a	5745	149	6 Mbps	7.25	-	7.25	29.8
	5785	157	6 Mbps	6.78	-	6.78	29.8
	5825	165	6 Mbps	6.20	-	6.20	29.8
802.11n HT20	5745	149	MCS0	7.26	-	7.26	29.8
	5785	157	MCS0	6.80	-	6.80	29.8
	5825	165	MCS0	6.08	-	6.08	29.8

U-NII 3 Band (40 MHz)				Test Result			
Mode	Frequency (MHz)	Channel	Data Rate	Measured Power (dBm)	Duty Factor (dB) ²⁾	Total Power (dBm)	Limit (dBm) ³⁾
				Chain 0		Chain 0	
802.11n HT40	5755	151	MCS0	7.20	-	7.20	29.8
	5795	159	MCS0	6.69	-	6.69	29.8

U-NII 3 Band (80 MHz)				Test Result			
Mode	Frequency (MHz)	Channel	Data Rate	Measured Power (dBm)	Duty Factor (dB) ²⁾	Total Power (dBm)	Limit (dBm) ³⁾
				Chain 0		Chain 0	
802.11ac VHT80	5775	155	MCS0	6.95	-	6.95	29.8

Note(s) :

1. The output power results in the table include the spectrum offset, which is a combination loss of the attenuator and the cable used for testing.
2. The EUT was set to transmit 100 % duty during the test.
3. The antenna gain exceeds 6 dBi, reducing the maximum conducted output power.
Limit (dBm) : 30 (dBm) - [6.2 (dBi) - 6 (dBi)] = 29.8 (dBm)

TEST PLOTS

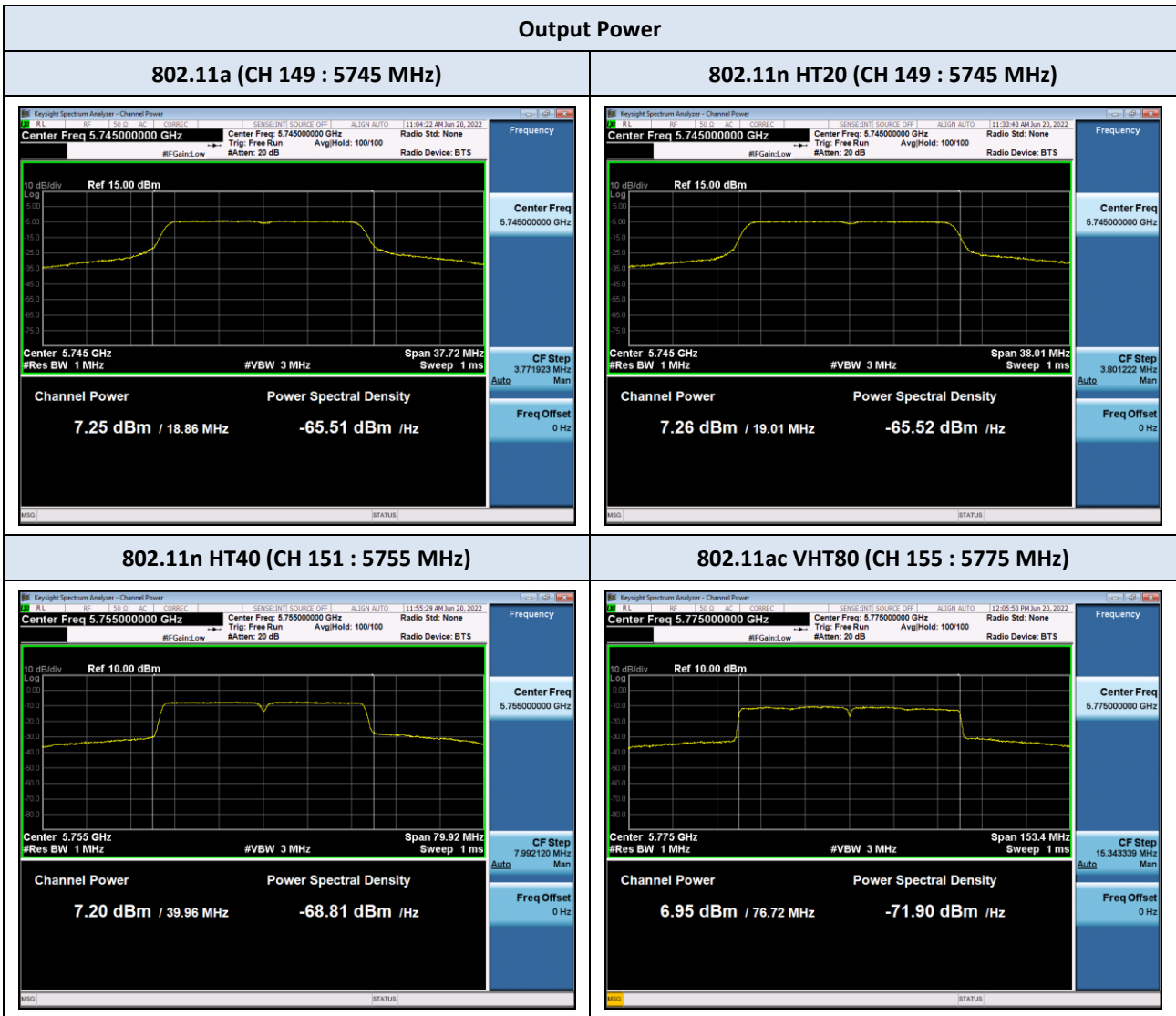

Note :
 The worst plots are reported for each bandwidth mode.

9.3 POWER SPECTRAL DENSITY

U-NII 3 Band (20 MHz)				Test Result			
Mode	Frequency (MHz)	Channel	Data Rate	Measured PSD (dBm/500kHz)	Duty Factor (dB) ²⁾	Total PSD (dBm/500kHz)	Limit (dBm/500kHz) ³⁾
				Chain 0		Chain 0	
802.11a	5745	149	6 Mbps	-6.98	-	-6.98	29.8
	5785	157	6 Mbps	-7.18	-	-7.18	29.8
	5825	165	6 Mbps	-7.79	-	-7.79	29.8
802.11n HT20	5745	149	MCS0	-7.17	-	-7.17	29.8
	5785	157	MCS0	-7.53	-	-7.53	29.8
	5825	165	MCS0	-8.45	-	-8.45	29.8

U-NII 3 Band (40 MHz)				Test Result			
Mode	Frequency (MHz)	Channel	Data Rate	Measured PSD (dBm/500kHz)	Duty Factor (dB) ²⁾	Total PSD (dBm/500kHz)	Limit (dBm/500kHz) ³⁾
				Chain 0		Chain 0	
802.11n HT40	5755	151	MCS0	-10.24	-	-10.24	29.8
	5795	159	MCS0	-10.51	-	-10.51	29.8

U-NII 3 Band (80 MHz)				Test Result			
Mode	Frequency (MHz)	Channel	Data Rate	Measured PSD (dBm/500kHz)	Duty Factor (dB) ²⁾	Total PSD (dBm/500kHz)	Limit (dBm/500kHz) ³⁾
				Chain 0		Chain 0	
802.11ac VHT80	5775	155	MCS0	-13.10	-	-13.10	29.8

Note :

1. The output power results in the table include the spectrum offset, which is a combination loss of the attenuator and the cable used for testing.
2. The EUT was set to transmit 100 % duty during the test.
3. The antenna gain exceeds 6 dBi, reducing the maximum power spectral density.
Limit (dBm) : 30 (dBm) - [6.2 (dBi) - 6 (dBi)] = 29.8 (dBm)

TEST PLOTS

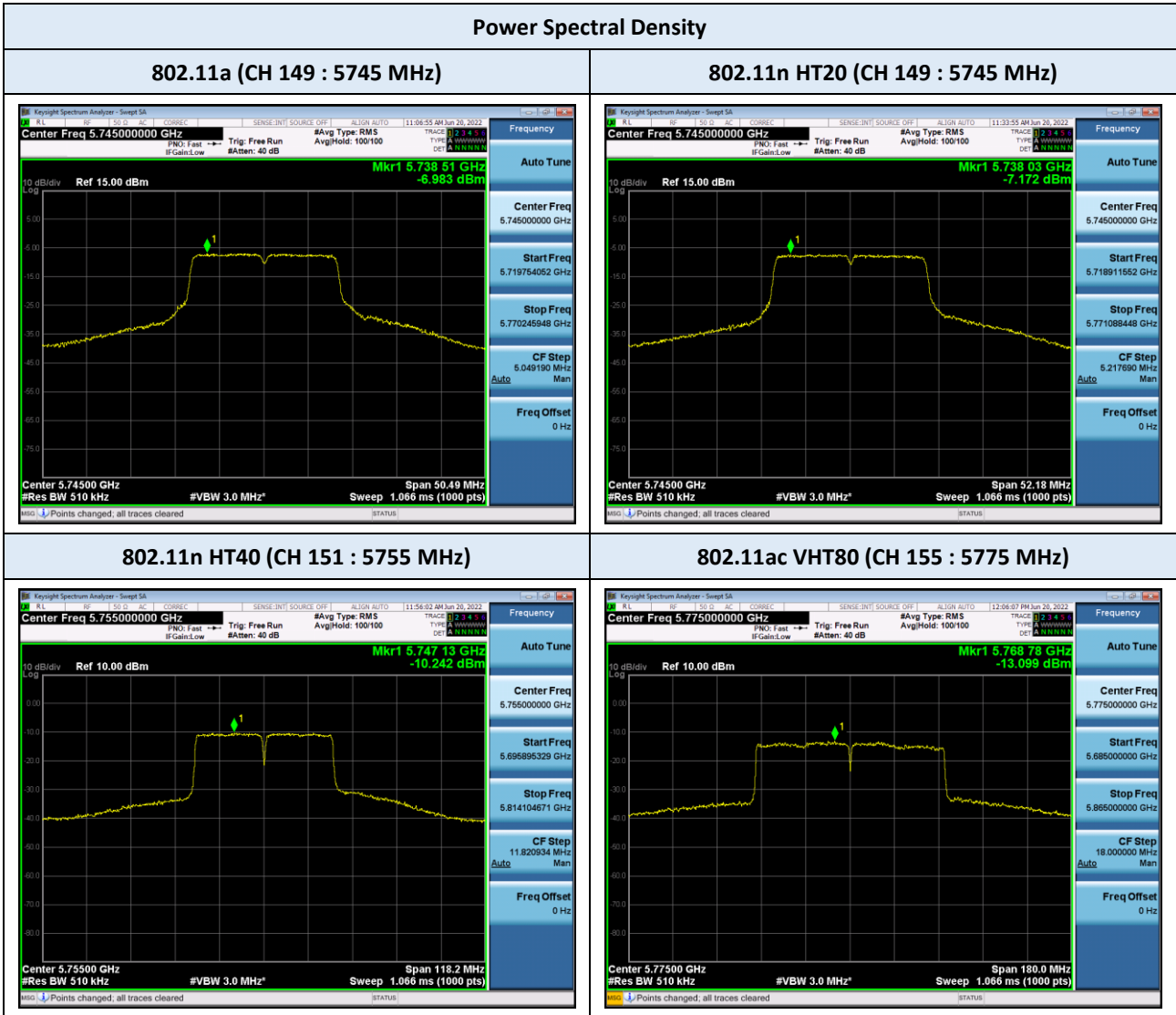

Note :
The worst plots are reported for each bandwidth mode.

9.4 FREQUENCY STABILITY

Operating Band : U-NII Band 3
 Operating Frequency : 5,745,000,000 Hz (CH 149)
 Reference Voltage : 12 V d.c.

Voltage (%)	Power (V d.c.)	Temp (°C)	Frequency error (ppm)			
			0 minutes	2 minutes	5 minutes	10 minutes
100%	12.0	+20 (Ref)	2.14	2.11	2.11	2.11
100%		-30	10.98	10.99	11.01	11.03
100%		-20	10.48	10.50	10.52	10.54
100%		-10	8.75	8.73	8.69	8.69
100%		0	6.59	6.60	6.62	6.62
100%		+10	4.09	4.13	4.14	4.15
100%		+30	2.09	2.05	2.05	2.03
100%		+40	2.10	2.10	2.10	2.09
100%		+50	4.88	4.85	4.85	4.85
115%	13.8	+20	2.11	2.10	2.11	2.13
85%	10.2	+20	2.10	2.10	2.10	2.11

Note:

According to the results of the frequency stability test above, the frequency deviation measured are very small. The channels at the band edge should remain in-band when the maximum measured frequency error noted during the frequency stability tests is applied. Therefore, the Radio frequency should remain in-band during operation over the temperature and voltage range as tested.

9.5 RADIATED SPURIOUS EMISSIONS

Frequency Range : Below 1 GHz

Test Mode 802.11a : TX mode
 Operating Frequency 5745 MHz (CH 149)

Frequency (MHz)	Polarization	Reading (dBuV)	Corr. ¹⁾ (dB)	Total (dBuV/m)	Limit (dBuV/m)	Margin (dB)	Measurement Type
43.976	V	43.9	-18.7	25.2	40	14.8	QP
192.021	V	46.5	-17.9	28.6	43.5	14.9	QP
415.447	V	44.0	-12.6	31.4	46	14.6	QP
681.722	H	43.5	-7.3	36.2	46	9.8	QP

Test Mode 802.11a : TX mode
 Operating Frequency 5785 MHz (CH 157)

Frequency (MHz)	Polarization	Reading (dBuV)	Corr. ¹⁾ (dB)	Total (dBuV/m)	Limit (dBuV/m)	Margin (dB)	Measurement Type
43.014	V	43.4	-18.1	25.3	40	14.7	QP
192.027	V	45.8	-17.9	27.9	43.5	15.6	QP
412.881	V	43.0	-12.6	30.4	46	15.6	QP
683.154	H	42.9	-7.3	35.6	46	10.4	QP

Test Mode 802.11a : TX mode
 Operating Frequency 5825 MHz (CH 165)

Frequency (MHz)	Polarization	Reading (dBuV)	Corr. ¹⁾ (dB)	Total (dBuV/m)	Limit (dBuV/m)	Margin (dB)	Measurement Type
44.021	V	43.9	-18.7	25.2	40	14.8	QP
192.040	V	45.6	-17.9	27.7	43.5	15.8	QP
413.062	V	43.3	-12.6	30.7	46	15.3	QP
682.781	H	43.3	-7.3	36.0	46	10.0	QP

Note(s) :

1. Correction Factor: Antenna Factor + Cable loss + Pre-amplifier Gain

Frequency Range : Above 1 GHz

Test Mode 802.11a : TX mode
 Operating Frequency 5745 MHz (CH 149)

Frequency (MHz)	Polarization	Reading (dBuV)		Factor (dB)		Level (dBuV/m)		Limit (dBuV/m)		Margin (dB)	
		AV	PK	Corr. ¹⁾	Duty	AV	PK	AV	PK	AV	PK
No major peak found											

Test Mode 802.11a : TX mode
 Operating Frequency 5785 MHz (CH 157)

Frequency (MHz)	Polarization	Reading (dBuV)		Factor (dB)		Level (dBuV/m)		Limit (dBuV/m)		Margin (dB)	
		AV	PK	Corr. ¹⁾	Duty	AV	PK	AV	PK	AV	PK
No major peak found											

Test Mode 802.11a : TX mode
 Operating Frequency 5825 MHz (CH 165)

Frequency (MHz)	Polarization	Reading (dBuV)		Factor (dB)		Level (dBuV/m)		Limit (dBuV/m)		Margin (dB)	
		AV	PK	Corr. ¹⁾	Duty	AV	PK	AV	PK	AV	PK
No major peak found											

Note(s) :

1. Correction Factor: Antenna Factor + Cable loss + Preamplifier Gain

Frequency Range : Above 1 GHz (Continued)

Test Mode 802.11n HT40 : TX mode
 Operating Frequency 5755 MHz (CH 151)

Frequency (MHz)	Polarization	Reading (dBuV)		Factor (dB)		Level (dBuV/m)		Limit (dBuV/m)		Margin (dB)	
		AV	PK	Corr. ¹⁾	Duty	AV	PK	AV	PK	AV	PK
No major peak found											

Test Mode 802.11n HT40 : TX mode
 Operating Frequency 5795 MHz (CH 159)

Frequency (MHz)	Polarization	Reading (dBuV)		Factor (dB)		Level (dBuV/m)		Limit (dBuV/m)		Margin (dB)	
		AV	PK	Corr. ¹⁾	Duty	AV	PK	AV	PK	AV	PK
No major peak found											

Test Mode 802.11ac VHT80 : TX mode
 Operating Frequency 5775 MHz (CH 155)

Frequency (MHz)	Polarization	Reading (dBuV)		Factor (dB)		Level (dBuV/m)		Limit (dBuV/m)		Margin (dB)	
		AV	PK	Corr. ¹⁾	Duty	AV	PK	AV	PK	AV	PK
No major peak found											

Note(s) :

1. Correction Factor: Antenna Factor + Cable loss + Preamplifier Gain

▣ TEST PLOTS

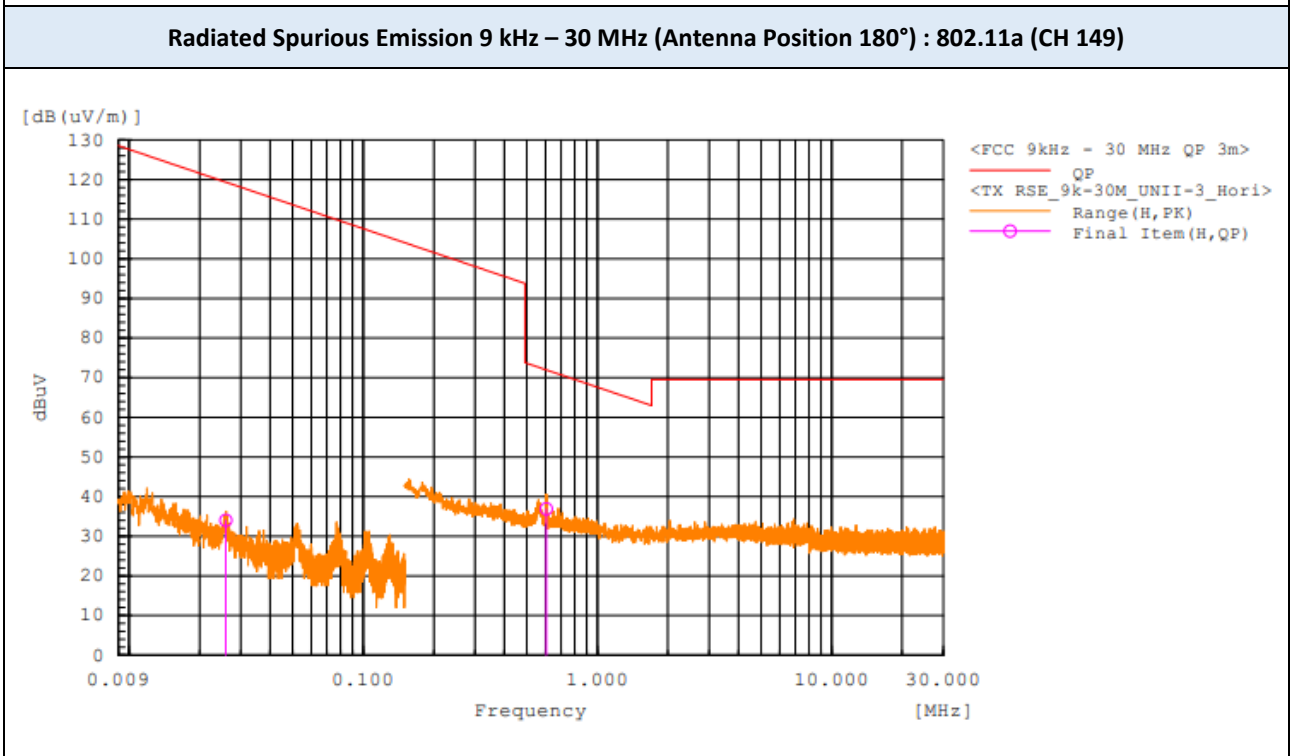
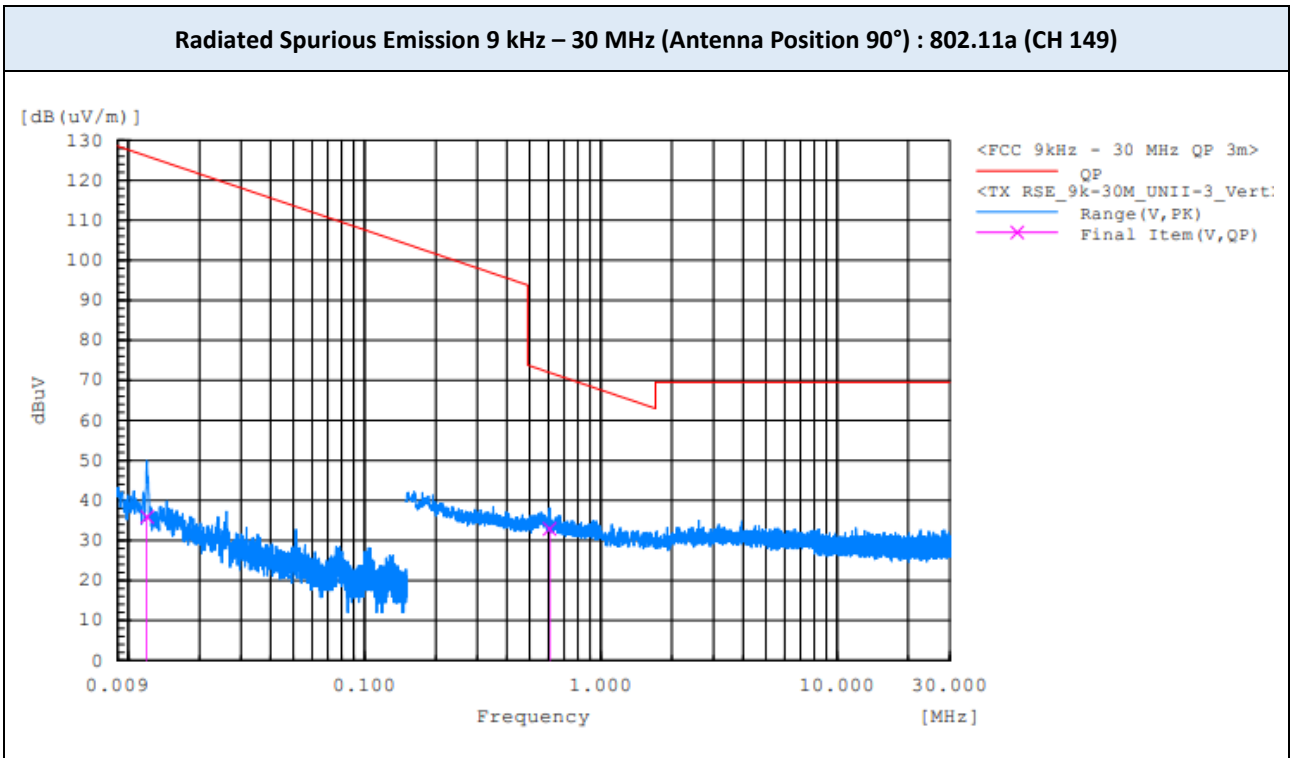

Note:

The worst-case plots are included in this report.

▣ TEST PLOTS (Continued)

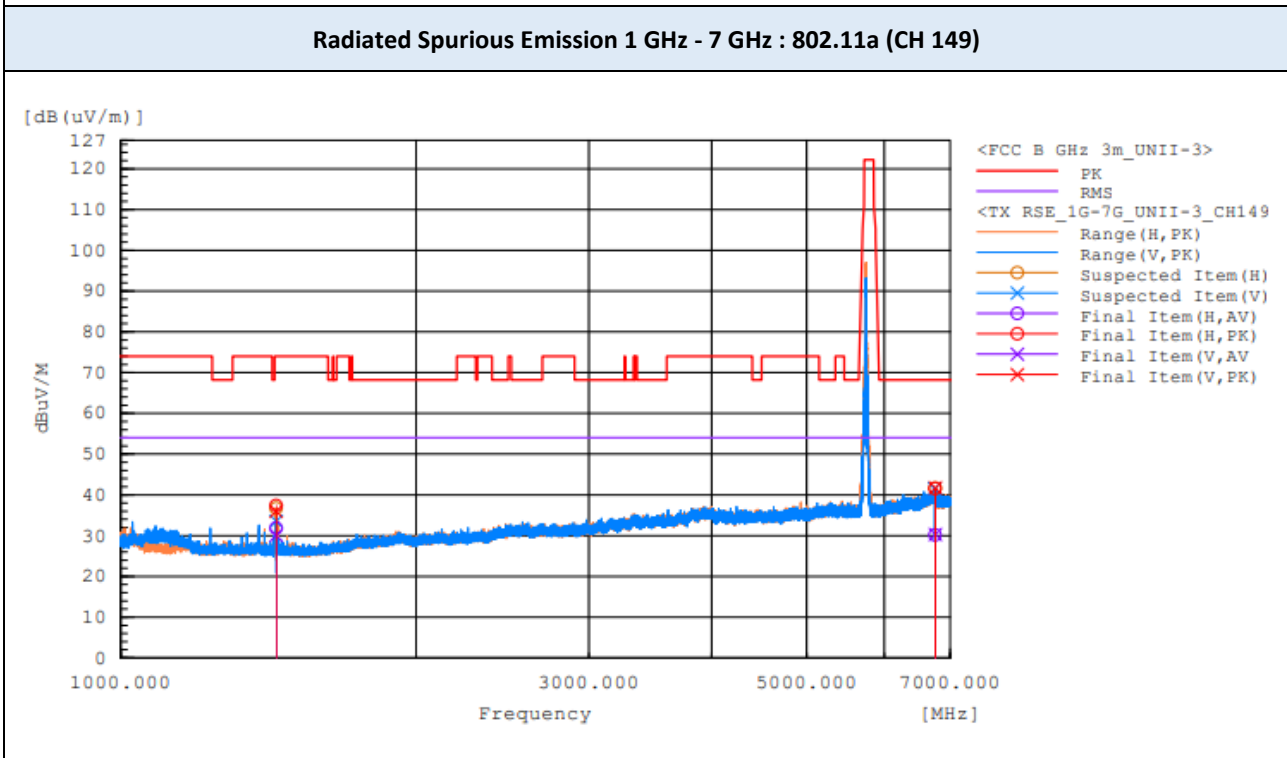
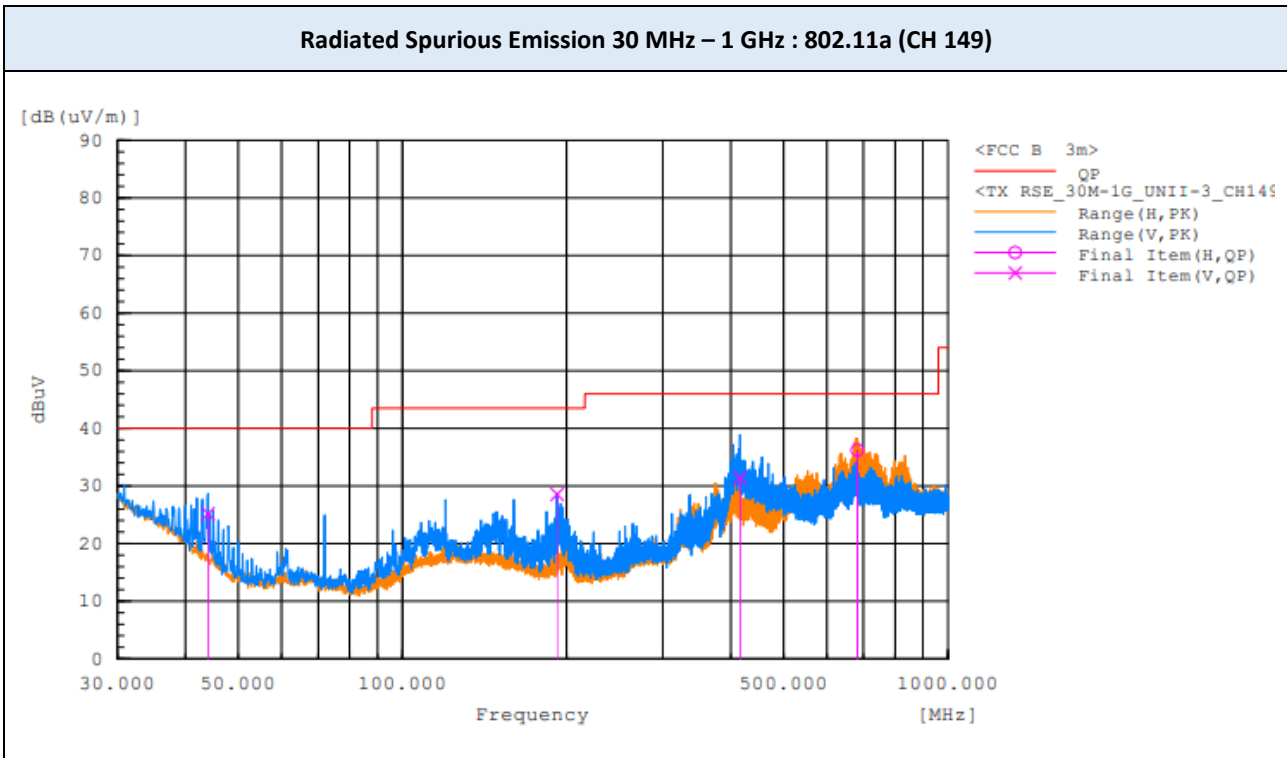

▣ TEST PLOTS (Continued)

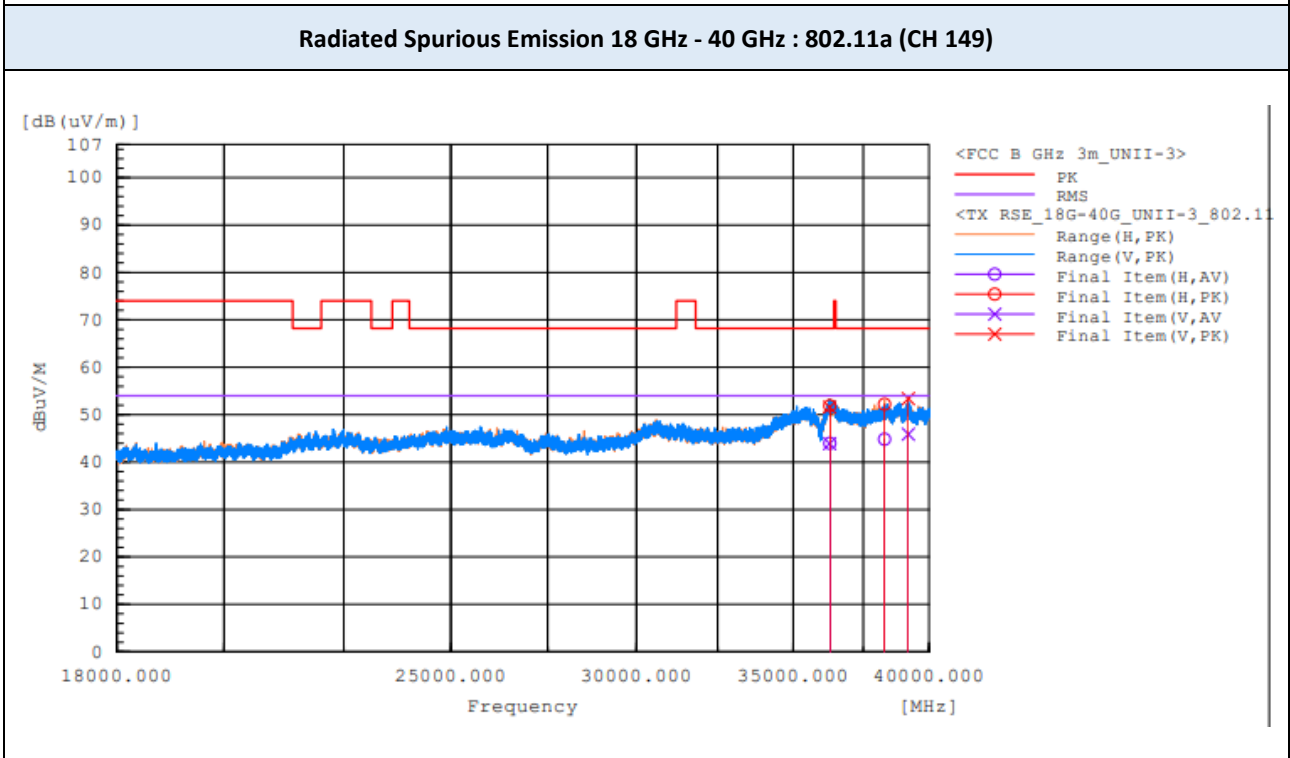
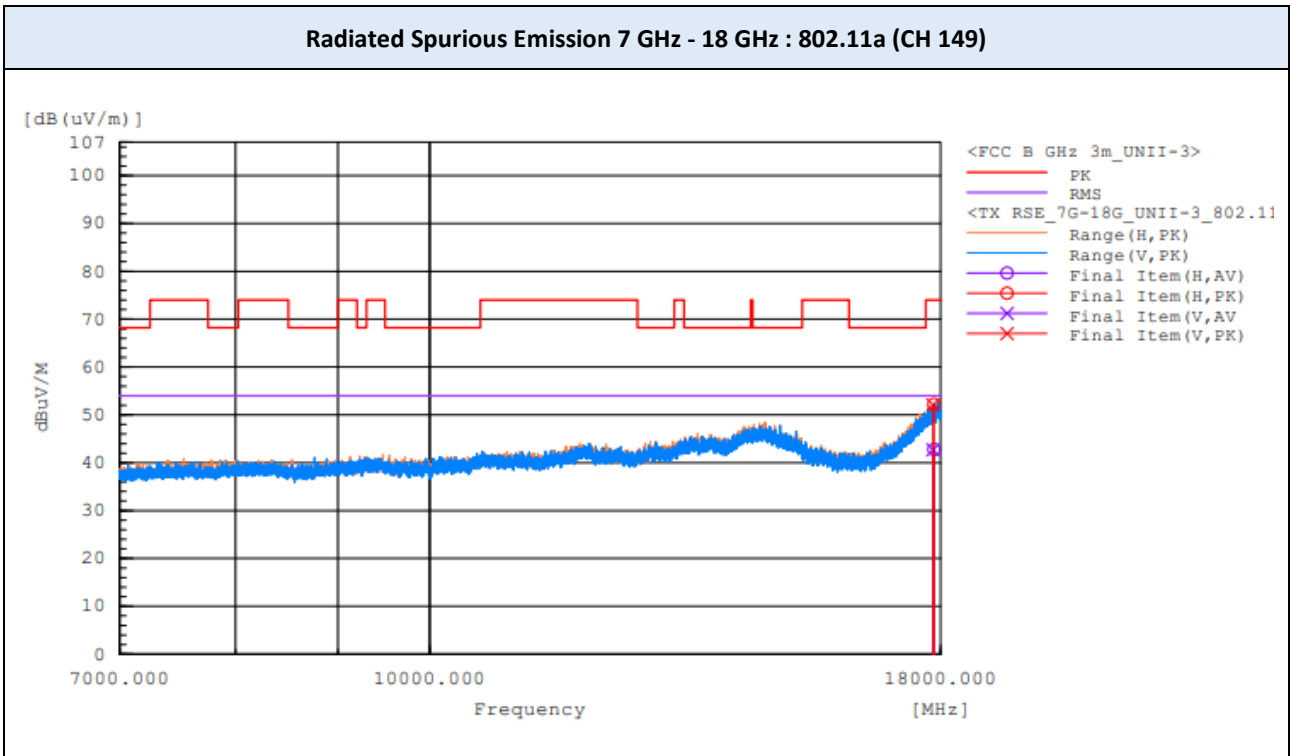

Note:
The worst-case plots are included in this report.

9.6 RADIATED RESTRICTED BAND EDGES

Test Mode 802.11a : TX mode
 Operating Frequency 5745 MHz (CH 149)

Frequency (MHz)	Polarization	Reading (dBuV)	Factor (dB)	Level (dBuV/m)	Limit (dBuV/m)	Margin (dB)
		PK	Corr. ¹⁾	PK	PK	PK
5645.856	V	41.2	-3.3	37.9	68.2	30.3
5652.851	H	41.3	-3.3	38.0	68.2	30.2

Test Mode 802.11a : TX mode
 Operating Frequency 5825 MHz (CH 165)

Frequency (MHz)	Polarization	Reading (dBuV)	Factor (dB)	Level (dBuV/m)	Limit (dBuV/m)	Margin (dB)
		PK	Corr. ¹⁾	PK	PK	PK
5927.580	H	41.8	-2.7	39.1	68.2	29.1
5928.020	V	41.1	-2.7	38.4	68.2	29.8

Notes:

1. Correction Factor: Antenna Factor + Cable loss

TEST PLOTS

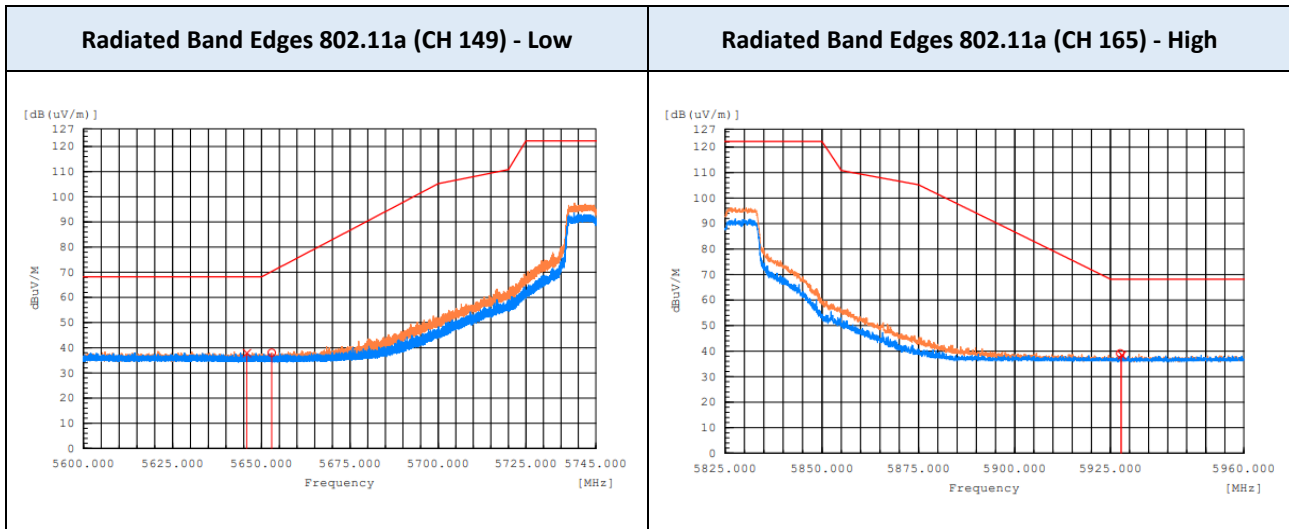

Test Mode 802.11n HT20 : TX mode
 Operating Frequency 5745 MHz (CH 149)

Frequency (MHz)	Polarization	Reading (dBuV)	Factor (dB)	Level (dBuV/m)	Limit (dBuV/m)	Margin (dB)
		PK	Corr. ¹⁾	PK	PK	PK
5636.995	H	41.8	-3.2	38.6	68.2	29.6
5644.977	V	41.9	-3.3	38.6	68.2	29.6

Test Mode 802.11n HT20 : TX mode
 Operating Frequency 5825 MHz (CH 165)

Frequency (MHz)	Polarization	Reading (dBuV)	Factor (dB)	Level (dBuV/m)	Limit (dBuV/m)	Margin (dB)
		PK	Corr. ¹⁾	PK	PK	PK
5930.405	V	41.2	-2.7	38.5	68.2	29.7
5934.617	H	41.7	-2.7	39.0	68.2	29.2

Notes:

1. Correction Factor: Antenna Factor + Cable loss

TEST PLOTS

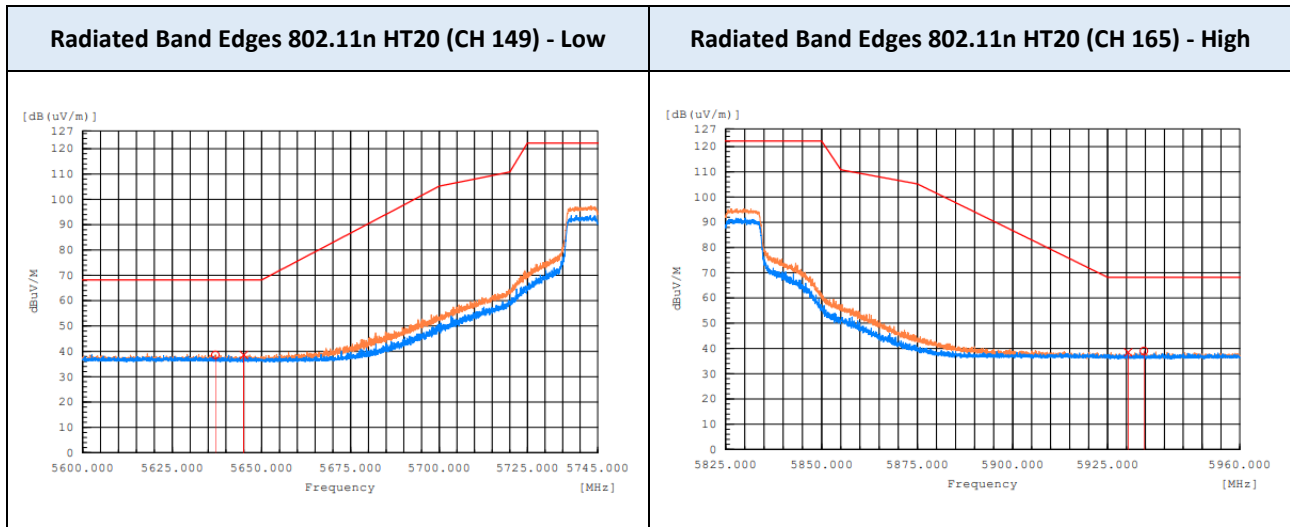

Test Mode 802.11n HT40 : TX mode
 Operating Frequency 5755 MHz (CH 151)

Frequency (MHz)	Polarization	Reading (dBuV)	Factor (dB)	Level (dBuV/m)	Limit (dBuV/m)	Margin (dB)
		PK	Corr. ¹⁾	PK	PK	PK
5647.548	V	47.5	-3.3	44.2	68.2	24.0
5649.767	H	52.0	-3.3	48.7	68.2	19.5

Test Mode 802.11n HT40 : TX mode
 Operating Frequency 5795 MHz (CH 159)

Frequency (MHz)	Polarization	Reading (dBuV)	Factor (dB)	Level (dBuV/m)	Limit (dBuV/m)	Margin (dB)
		PK	Corr. ¹⁾	PK	PK	PK
5928.084	H	42.4	-2.7	39.7	68.2	28.5
5940.102	V	41.1	-2.6	38.5	68.2	29.7

Notes:

1. Correction Factor: Antenna Factor + Cable loss

TEST PLOTS

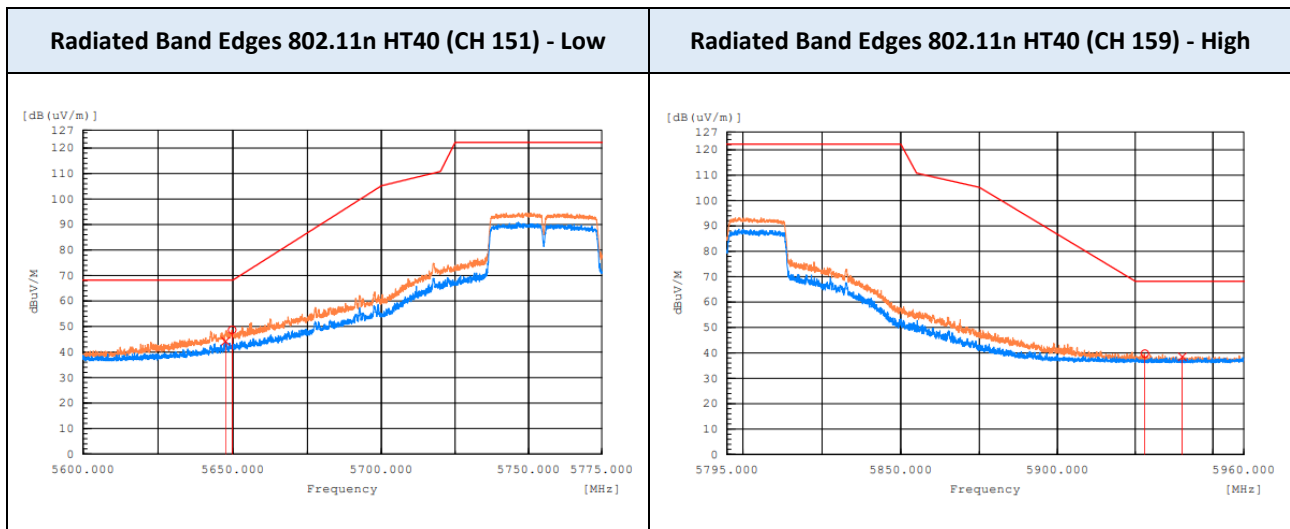

Test Mode 802.11ac VHT80 : TX mode
 Operating Frequency 5775 MHz (CH 155)

Frequency (MHz)	Polarization	Reading (dBuV)	Factor (dB)	Level (dBuV/m)	Limit (dBuV/m)	Margin (dB)
		PK	Corr. ¹⁾	PK	PK	PK
5646.808	H	60.1	-3.3	56.8	68.2	11.4
5647.052	V	54.8	-3.3	51.5	68.2	16.7
5925.548	H	50.0	-2.7	47.3	68.2	20.9
5931.236	V	45.9	-2.7	47.3	68.2	20.9

Notes:

1. Correction Factor: Antenna Factor + Cable loss

TEST PLOTS

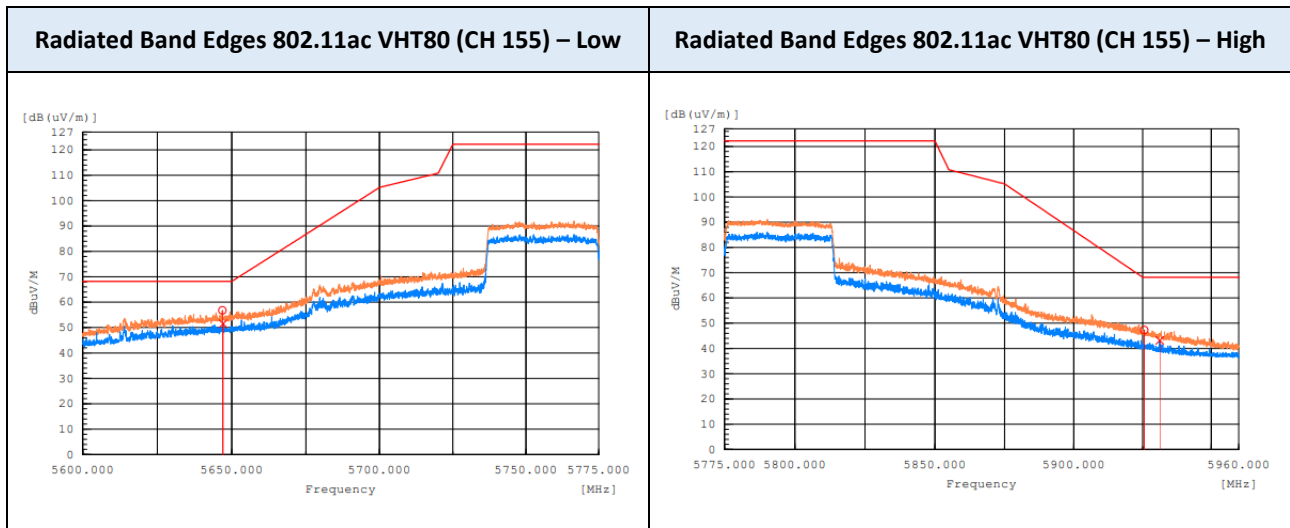

9.7 RECEIVER SPURIOUS EMISSIONS

Frequency Range : Below 1 GHz

Test Mode 802.11a : TX mode
 Operating Frequency 5745 MHz (CH 149)

Frequency (MHz)	Polarization	Reading (dBuV)	Corr. ¹⁾ (dB)	Total (dBuV/m)	Limit (dBuV/m)	Margin (dB)	Measurement Type
43.989	V	44.4	-18.7	25.7	40	14.3	QP
192.008	V	46.9	-17.9	29.0	43.5	14.5	QP
410.219	V	43.2	-12.7	30.5	46	15.5	QP
682.136	H	43.7	-7.3	36.4	46	9.6	QP
816.207	H	35.6	-5.1	30.5	46	15.5	QP

Frequency Range : Above 1 GHz

Test Mode 802.11a : TX mode
 Operating Frequency 5745 MHz (CH 149)

Frequency (MHz)	Polarization	Reading (dBuV)	Corr. ¹⁾ (dB)	Total (dBuV/m)	Limit (dBuV/m)	Margin (dB)	Measurement Type
1439.883	V	45.1	-13.7	31.4	54	22.6	RMS
1440.027	H	47.3	-13.7	33.6	54	20.4	RMS

Note:

1. Correction Factor: Antenna Factor + Cable loss + Pre-amplifier

▣ TEST PLOTS

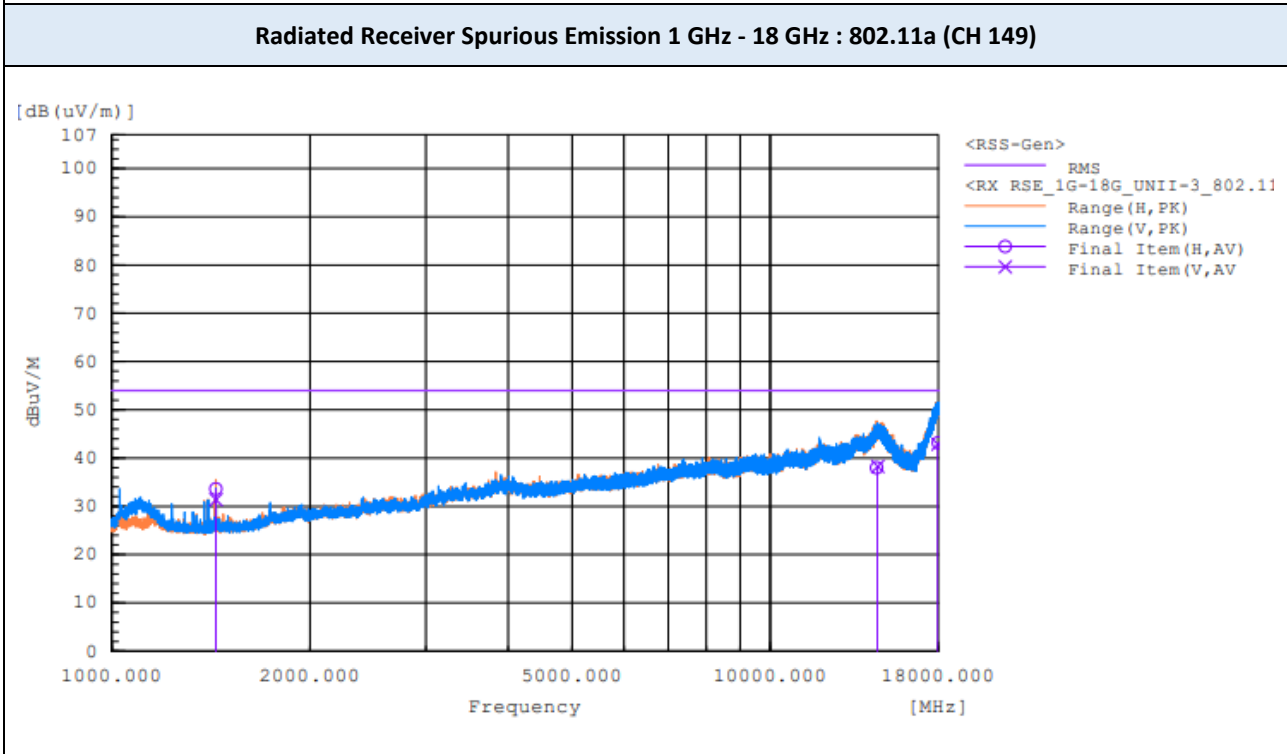
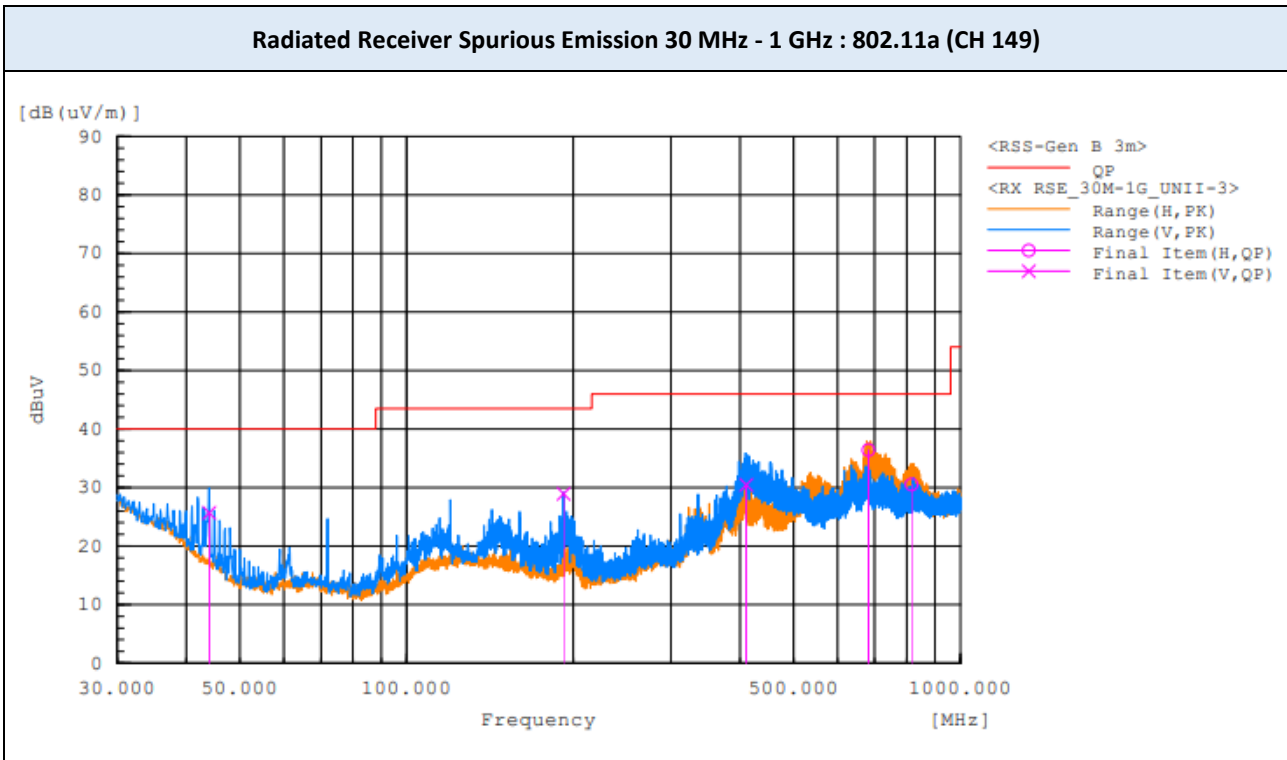

Note:
The worst-case plots are included in this report.

▣ TEST PLOTS

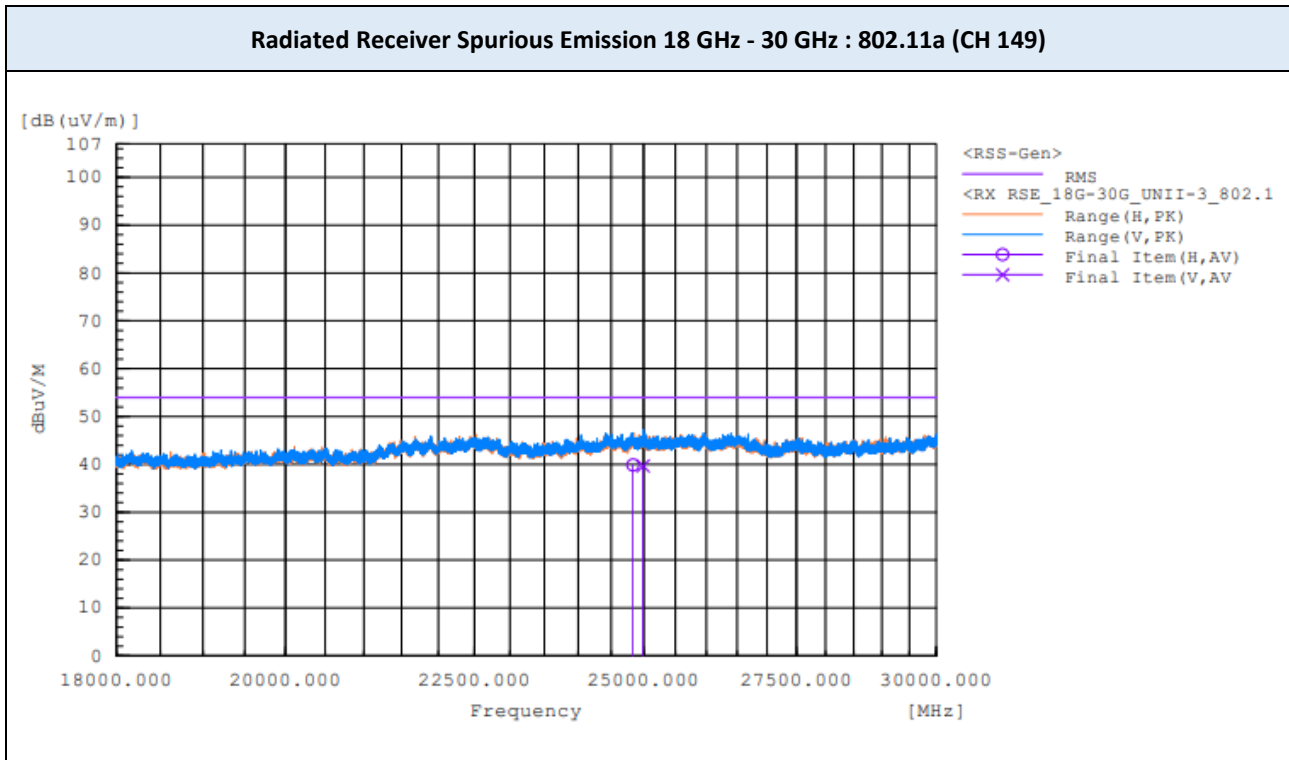

Note:

The worst-case plots are included in this report.

9.8 POWERLINE CONDUCTED EMISSIONS

Frequency (MHz)	Line	Reading (dBµV)		Corr. ¹⁾ (dB)	Level (dBµV)		Limit (dBµV)		Margin (dB)	
		QP	CAV		QP	CAV	QP	CAV	QP	CAV
0.172	L1	40.7	26.8	9.7	50.4	36.5	64.9	54.9	14.5	18.4
0.220	L1	36.1	21.6	9.7	45.8	31.3	62.8	52.8	17.0	21.5
0.555	L1	15.4	7.7	9.6	25.0	17.3	56	46	31.0	28.7
2.831	L1	10.8	3.1	9.7	20.5	12.8	56	46	35.5	33.2
15.193	L1	16.3	11.1	10.2	26.5	21.3	60	50	33.5	28.7
29.501	L1	7.5	5.9	10.5	18.0	16.4	60	50	42.0	33.6

Frequency (MHz)	Line	Reading (dBµV)		Corr. ¹⁾ (dB)	Level (dBµV)		Limit (dBµV)		Margin (dB)	
		QP	CAV		QP	CAV	QP	CAV	QP	CAV
0.175	N	42.0	30.7	9.7	51.7	40.4	64.7	54.7	13.0	14.3
0.219	N	37.2	25.1	9.7	46.9	34.8	62.9	52.9	16.0	18.1
0.561	N	25.6	20.1	9.6	35.2	29.7	56	46	20.8	16.3
0.708	N	15.1	9.8	9.6	24.7	19.4	56	46	31.3	26.6
16.040	N	15.1	9.8	10.1	25.2	19.9	60	50	34.8	30.1
29.001	N	8.1	6.0	10.5	18.6	16.5	60	50	41.4	33.5

Note(s) :

1. Quasi-peak(Final Result) = Reading Value + Correction Factor

▣ TEST PLOTS

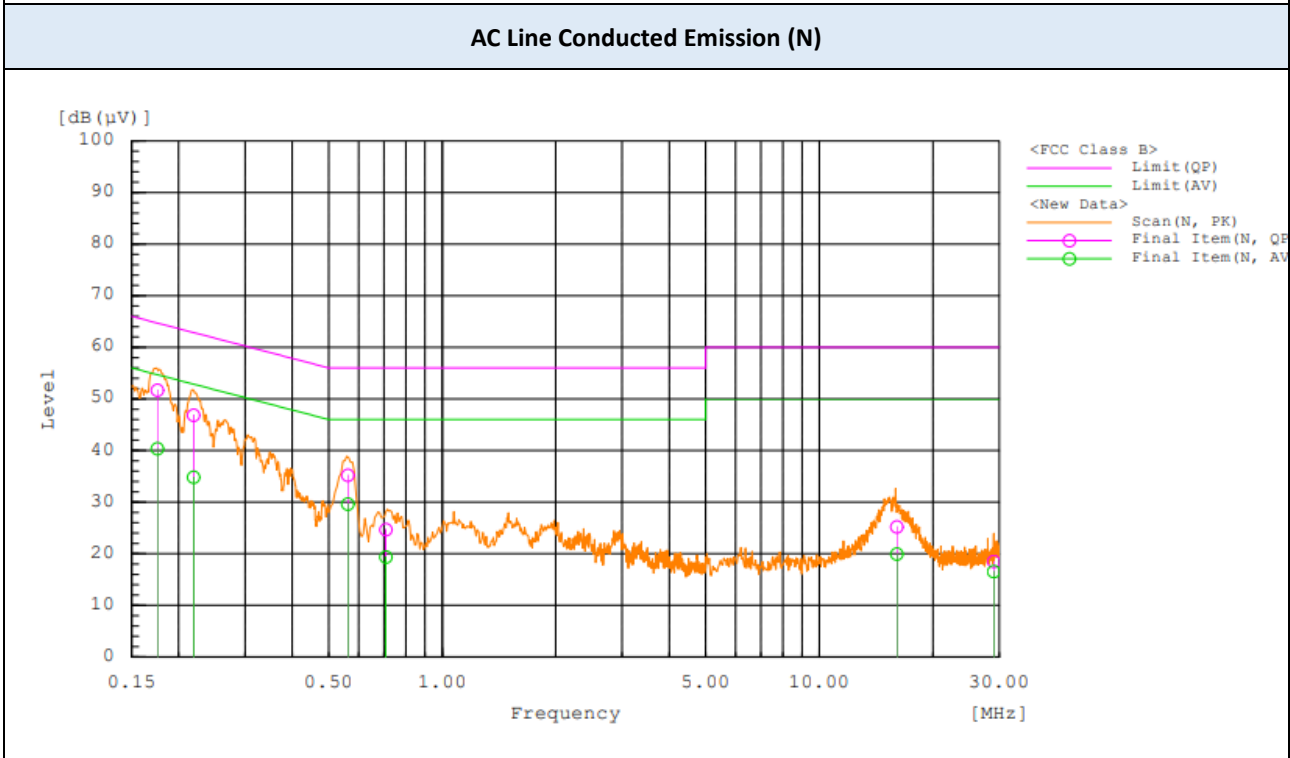
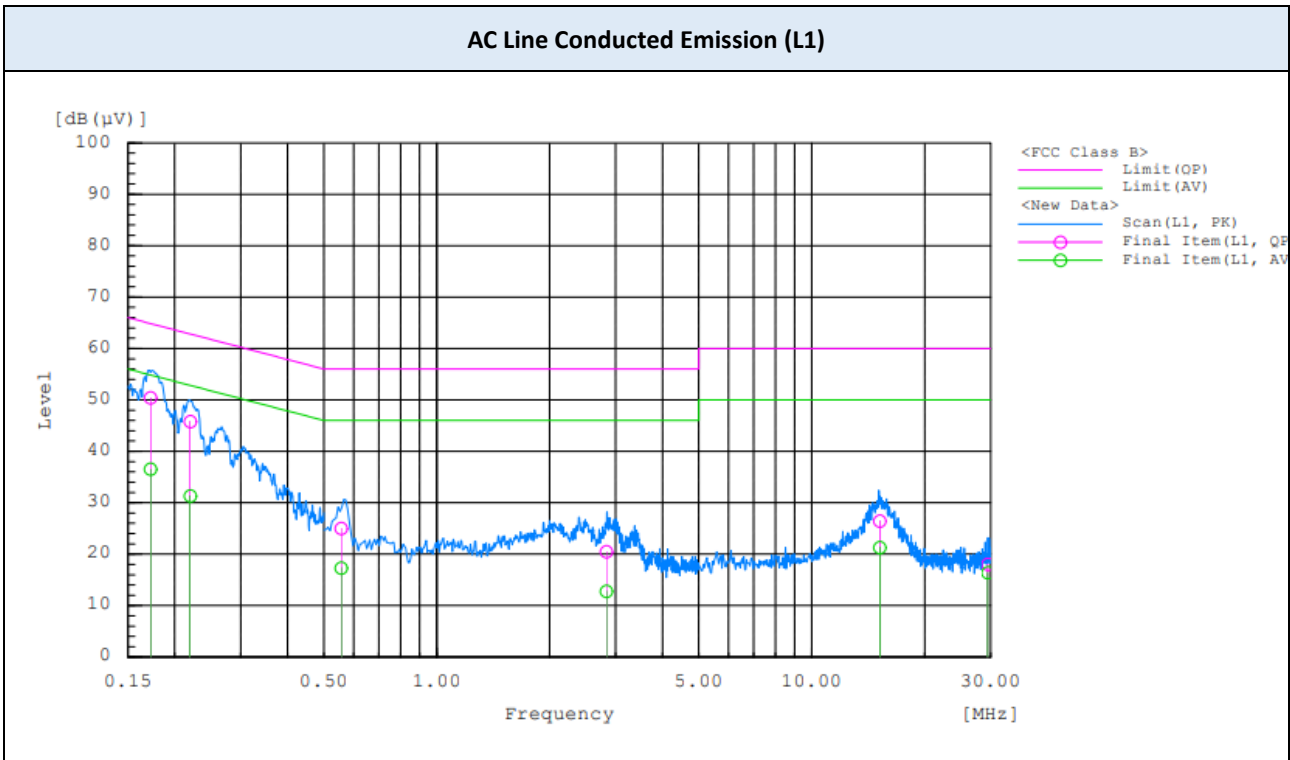

10. LIST OF TEST EQUIPMENT

No.	Instrument	Model No.	Calibration Due (mm/dd/yy)	Manufacture	Serial No.
<input checked="" type="checkbox"/>	Signal Analyzer (20 Hz ~ 40.0 GHz)	ESU40	12/03/2022	Rohde & Schwarz	100529
<input checked="" type="checkbox"/>	Signal Analyzer (1 Hz ~ 40.0 GHz)	ESW44	10/25/2022	Rohde & Schwarz	102015
<input checked="" type="checkbox"/>	Signal Analyzer (10 Hz ~ 26.5 GHz)	N9020A	02/22/2023	Keysight	MY48011929
<input type="checkbox"/>	Attenuator (20 dB, DC ~ 26.5 GHz)	CFADC262002	01/13/2023	CERNEX	-
<input checked="" type="checkbox"/>	Attenuator (10 dB, DC ~ 26.5 GHz)	CFADC261002	01/13/2023	CERNEX	-
<input checked="" type="checkbox"/>	Loop Antenna (0.009 ~ 30 MHz)	HLA 6121	09/15/2023	TESEQ	43964
<input checked="" type="checkbox"/>	BI-LOG Antenna (30 MHz ~ 6 GHz)	JB1	04/16/2023	Sunol	A061416
<input checked="" type="checkbox"/>	LNA (30 MHz ~ 1GHz)	PAM-103	04/14/2023	Com-Power	18020254
<input checked="" type="checkbox"/>	Horn Antenna (1 GHz ~ 18 GHz)	DRH-118	10/21/2022	Sunol	A070516
<input checked="" type="checkbox"/>	LNA (1 GHz ~ 18 GHz)	PAM-118A	07/06/2022	Com-Power	18040074
<input checked="" type="checkbox"/>	Horn Antenna (18 GHz ~ 40 GHz)	DRH-1840	02/16/2023	Sunol	17121
<input checked="" type="checkbox"/>	LNA (18 GHz ~ 40 GHz)	CBL18405045-01	02/10/2023	CERNEX, Inc.	27973
<input type="checkbox"/>	High Pass Filter	WHK10-2520-3000-18000-40EF	01/13/2023	Wainwright	9
<input checked="" type="checkbox"/>	High Pass Filter	WHKX8-6090-7000-18000-40SS	01/13/2023	Wainwright	23
<input checked="" type="checkbox"/>	EMI Test Receiver	ESR3	12/03/2022	Rohde & Schwarz	102363
<input checked="" type="checkbox"/>	LISN	ENV216	01/19/2023	Rohde & Schwarz	101349
<input checked="" type="checkbox"/>	DC Power Supply	PAB 18-1A	01/13/2023	Kikusui	1350582

Note(s) :

1. Equipment listed above that calibrated during the testing period was set for test after the calibration.
2. Equipment listed above that has a calibration due date during the testing period, the testing is completed before equipment expiration date.

APPENDIX A. TEST SETUP PHOTOS

The setup photos are provided as a separate document.

APPENDIX B. PHOTOGRAPHS OF EUT

B.1. EXTERNAL PHOTOS

The external photos are provided as a separate document.

B.2. INTERNAL PHOTOS

The internal photos are provided as a separate document.

END OF TEST REPORT