

RF TEST REPORT

FCC / ISED

APPLICANT

Safetrust Inc

MODEL NAME

SA350

FCC ID

2ANI5SA350

ISED ID

23133-SA350

REPORT NUMBER

HA200512-SFT-001-R06

TEST REPORT

Date of Issue
October 28, 2022

Test Site
Hyundai C-Tech, Inc. dba HCT America, Inc.
1726 Ringwood Ave, San Jose, CA 95131, USA

Applicant	Safetrust Inc
Applicant Address	8116 Mill Creek Rd, Fremont, CA 94539, U.S.A.
FCC ID	2ANI5SA350
ISED ID	23133-SA350
Model Name	SA350
EUT Type	SABRE RELAY
Modulation Type	DSSS / CCK, OFDM, GFSK
FCC Classification	Digital Transmission System (DTS)
FCC Rule Part(s)	Part 15.247, Part 15.209
ISED Rule Part(s)	RSS-247 Issue 2 (February 2017) RSS-Gen Issue 5 Amd 2 (February 2021)
Test Procedure	ANSI C63.10-2013, KDB 558074 D01 v05r02

The device bearing the trade name and model specified above, has been shown to comply with the applicable technical standards as indicated in the measurement report and was tested in accordance with the measurement procedures required. The results of testing in this report apply only to the product which was tested. Other similar equipment will not necessarily produce the same results due to production tolerance and measurement uncertainties.

I attest to the accuracy of data. All measurements reported herein were performed by me or were made under my supervision and are correct to the best of my knowledge and belief. I assume full responsibility for the completeness of these measurements and vouch for the qualifications of all persons taking them.

Hyundai C-Tech, Inc. dba HCT America, Inc. certifies that no party to application has been denied the FCC benefits pursuant to Section 5301 of the Anti-Drug Abuse Act of 1988, 21 U.S.C 862

Tested By



Yongsoo Park

Test Engineer

Reviewed By



Sunwoo Kim

Technical Manager

REVISION HISTORY

The revision history for this document is shown in table.

TEST REPORT NO.	DATE	DESCRIPTION
HA200512-SFT-001-R06	October 28, 2022	Initial Issue

TABLE OF CONTENTS

1. GENERAL INFORMATION	4
2. METHODOLOGY	5
3. INSTRUMENT CALIBRATION	5
4. FACILITIES AND ACCREDITATIONS	6
5. ANTENNA REQUIREMENTS	7
6. MEASUREMENT UNCERTAINTY	8
7. DESCRIPTION OF TESTS	9
8. SUMMARY OF TEST RESULTS	15
9. TEST RESULT	17
9.1 RADIATED SPURIOUS EMISSIONS	17
10. LIST OF TEST EQUIPMENT	21
APPENDIX A. TEST SETUP PHOTOS	22
APPENDIX B. PHOTOGRAPHS OF EUT	23

1. GENERAL INFORMATION

EUT DESCRIPTION

Base Model	SA350	
EUT Type	SABRE RELAY	
Serial Number	Radiated : SN1 Conducted : SN3	
Power Supply	7 – 25 V d.c.	
RF Specification	WIFI 2.4 GHz	IEEE 802.11b/g/n (HT20/40) : ESP32
	BLE (MCU)	1 Mbps : nRF52840
	BLE (MESH)	1 Mbps : nRF52832
Transmitter Chain	WIFI 2.4 GHz : SISO Bluetooth LE : SISO	
Operating Environment	Indoor and outdoor	
Operating Temperature	-35 °C ~ 65 °C	

RF SPECIFICATION SUBJECT TO THE REPORT

Max. RF Output Power	WIFI 2.4 GHz	6.59 dBm (4.56 mW)
	BLE MCU	0.55 dBm (1.14 mW)
	BLE MESH	-1.66 dBm (0.69 mW)
Modulation Type	WIFI 2.4 GHz	DSSS/CCK, OFDM
	BLE MCU	GFSK
	BLE MESH	GFSK
Antenna Specification ¹⁾	Antenna Type : Chip Antenna Antenna Gain : 2.0 dBi (Peak Gain)	
Firmware Version ²⁾	STF 591	
Hardware Version ²⁾	BRD52-4 RELAY REV 02	
Date(s) of Tests	October 22, 2022	

Note :

1. Antenna information is based on the document provided.
2. Firmware and Hardware Version are as received by the client.

2. METHODOLOGY

FCC KDB 558074 D01 DTS Measurement Guidance v05r02 dated April 2nd, 2019 entitled "Guidance for Performing Compliance Measurements on Digital Transmission Systems (DTS) and the measurement procedure described in ANSI C63.10(Version : 2013) 'the American National Standard of Procedures for Compliance Testing of Unlicensed Wireless Devices'.

EUT CONFIGURATION

The EUT configuration for testing is installed on RF field strength measurement to meet the Commissions requirement and operating in a manner that intends to maximize its emission characteristics in a continuous normal application.

EUT EXERCISE

The EUT was operated in the engineering mode to fix the Tx frequency that was for the purpose of the measurements. According to its specifications, the EUT must comply with the requirements of the Section 15.207, 15.209, and 15.247 under the FCC Rules Part 15 Subpart C / RSS-Gen issue 5 Amd 2, RSS-247 issue 2.

GENERAL TEST PROCEDURES

Radiated Emissions

The EUT is placed on a turn table, which is 0.8 m above ground plane below 1GHz. Above 1GHz with 1.5m using absorbers between the EUT and receive antenna. The turntable shall rotate 360 degrees to determine the position of maximum emission level. EUT is set 3 m away from the receiving antenna, which varied from 1 m to 4 m to find out the highest emission. Also, each emission was to be maximized by changing the polarization of the receiving antenna both horizontal and vertical. In order to find out the maximum emission, the relative positions of this hand-held transmitter (EUT) were rotated through three orthogonal axes according to the requirements in Section 8 of ANSI C63.10. (Version: 2013)

DESCRIPTION OF TEST MODES

The EUT has been tested at WIFI and BLE operating simultaneously. 'ESP RF Test Tool v.24' was used to control data rates, channels, output power level and to change between continuous TX and normal RX mode for WIFI. Tera term was used to control BLE data rate, channel, power setting.

3. INSTRUMENT CALIBRATION

The measuring equipment, which was utilized in performing the tests documented herein, has been calibrated in accordance with the manufacturer's recommendations for utilizing calibration equipment's, which is traceable to recognized national standards. Especially, all antenna for measurement is calibrated in accordance with the requirements of C63.5 (Version : 2017).

4. FACILITIES AND ACCREDITATIONS

FACILITIES

The SAC (Semi-Anechoic Chamber) and conducted measurement facility used to collect the radiated data are located at 1726 Ringwood Avenue, San Jose, California 95131, USA.

The site is constructed in conformance with the requirements of ANSI C63.4. (Version :2014) and CISPR Publication 22.



EQUIPMENT

Radiated emissions are measured with one or more of the following types of Linearly polarized antennas: tuned dipole, bi-conical, log periodic, bi-log, and/or ridged waveguide, horn. Spectrum analyzers with pre-selectors and quasi-peak detectors are used to perform radiated measurements.

Conducted emissions are measured with Line Impedance Stabilization Networks and EMI Test Receivers. Calibrated wideband preamplifiers, coaxial cables, and coaxial attenuators are also used for making measurements.

All receiving equipment conforms to CISPR Publication 16-1, "Radio Interference Measuring Apparatus and Measurement Methods."

5. ANTENNA REQUIREMENTS

According to FCC 47 CFR §15.203:

“An intentional radiator antenna shall be designed to ensure that no antenna other than that furnished by the responsible party can be used with the device. The use of a permanently attached antenna or of an antenna that uses a unique coupling to the intentional radiator shall be considered sufficient to comply with the provisions of this section.”

- (1) The antenna of this E.U.T is permanently attached and there is no provision for connection to an external antenna.
- (2) The E.U.T Complies with the requirement of §15.203

According to RSS-Gen Issue 5 (Section 6.8) :

The applicant for equipment certification shall provide a list of all antenna types that may be used with the transmitter, where applicable (i.e. for transmitters with detachable antenna), indicating the maximum permissible antenna gain (in dBi) and the required impedance for each antenna. The test report shall demonstrate the compliance of the transmitter with the limit for maximum equivalent isotropically radiated power (e.i.r.p.) specified in the applicable RSS, when the transmitter is equipped with any antenna type, selected from this list.

For expediting the testing, measurements may be performed using only the antenna with highest gain of each combination of transmitter and antenna type, with the transmitter output power set at the maximum level. However, the transmitter shall comply with the applicable requirements under all operational conditions and when in combination with any type of antenna from the list provided in the test report (and in the notice to be included in the user manual, provided below).

When measurements at the antenna port are used to determine the RF output power, the effective gain of the device's antenna shall be stated, based on a measurement or on data from the antenna's manufacturer.

The test report shall state the RF power, output power setting and spurious emission measurements with each antenna type that is used with the transmitter being tested.

6. MEASUREMENT UNCERTAINTY

The measurement uncertainties shown below were calculated in accordance with the requirements of ANSI C63.10-2013.

All measurement uncertainty values are shown with a coverage factor of $k = 2$ to indicate a 95 % level of confidence. The measurement data shown herein meets or exceeds the U_{CISPR} measurement uncertainty values specified in CISPR 16-4-2 and, thus, can be compared directly to specified limits to determine compliance.

Parameter	Expanded Uncertainty (\pm dB)
Radiated Emissions (below 1 GHz)	6.09 dB
Radiated Emissions (Above 1 GHz)	5.23 dB

7. DESCRIPTION OF TESTS

7.1. RADIATED EMISSIONS

RADIATION EMISSION LIMIT

FCC : 47 CFR § 15.209		
Frequency (MHz)	Field Strength (uV/m)	Measurement Distance (m)
0.009 – 0.490	2400/F(kHz)	300
0.490 – 1.705	24000/F(kHz)	30
1.705 – 30	30	30
30-88	100	3
88-216	150	3
216-960	200	3
Above 960	500	3

ISED : RSS-GEN Section 8.9		
Frequency (MHz)	Field Strength (uV/m)	Measurement Distance (m)
0.009 – 0.490	6.37/F(kHz)	300
0.490 – 1.705	63.7/F(kHz)	30
1.705 – 30	0.08	30
30-88	100	3
88-216	150	3
216-960	200	3
Above 960	500	3

RESTRICTED BANDS OF OPERATION

FCC : 47 CFR § 15.205(a)				
Frequency (MHz)	Frequency (MHz)	Frequency (MHz)	Frequency (MHz)	Frequency (MHz)
0.090 - 0.110	12.29 - 12.293	149.9 - 150.05	1660.0 - 1710.0	8025 - 8500
0.495 - 0.505	12.51975 - 12.52025	156.52475 - 156.52525	1718.8 - 1722.2	9000 - 9200
2.1735 - 2.1905	12.57675 - 12.57725	156.7 - 156.9	2200.0 - 2300.0	9300 - 9500
4.125 - 4.128	13.36 - 13.41	162.0125 - 167.17	2310.0 - 2390.0	10600 - 12700
4.17725 - 4.17775	16.42 - 16.423	167.72 - 173.2	2483.5 - 2500.0	13250 - 13400
4.20725 - 4.20775	16.69475 - 16.69525	240.0 - 285.0	2690.0 - 2900.0	14470 - 14500
6.215 - 6.218	16.80425 - 16.80475	322.0 - 335.4	3260.0 - 3267.0	15350 - 16200
6.26775 - 6.26825	25.5 - 25.67	399.9 - 410.0	3332.0 - 3339.0	17700 - 21400
6.31175 - 6.31225	37.5 - 38.25	608.0 - 614.0	3345.8 - 3358.0	22010 - 23120
8.291 - 8.294	73 - 74.6	960.0 - 1240.0	3600.0 - 4400.0	23600 - 24000
8.362 - 8.366	74.8 - 75.2	1300.0 - 1427.0	4500.0 - 5150.0	31200 - 31800
8.37625 - 8.38675	108 - 121.94	1435.0 - 1626.5	5350.0 - 5460.0	36430 - 36500
8.41425 - 8.41475	123 - 138	1645.5 - 1646.5	7250.0 - 7750.0	Above 38600

ISED : RSS-GEN Section 8.10				
Frequency (MHz)	Frequency (MHz)	Frequency (MHz)	Frequency (MHz)	Frequency (MHz)
0.090 - 0.110	8.37625 - 8.38675	108 - 138	1660 - 1710	8025 - 8500
0.495 - 0.505	8.41425 - 8.41475	149.9 - 150.05	1718.8 - 1722.2	9000 - 9200
2.1735 - 2.1905	12.29 - 12.293	156.52475 - 156.52525	2200 - 2300	9300 - 9500
3.020 - 3.026	12.51975 - 12.52025	156.7 - 156.9	2310 - 2390	10600 - 12700
4.125 - 4.128	12.57675 - 12.57725	162.0125 - 167.17	2483.5 - 2500	13250 - 13400
4.17725 - 4.17775	13.36 - 13.41	167.72 - 173.2	2655 - 2900	14470 - 14500
4.20725 - 4.20775	16.42 - 16.423	240 - 285	3260 - 3267	15350 - 16200
5.677 - 5.683	16.69475 - 16.69525	322 - 335.4	3332 - 3339	17700 - 21400
6.215 - 6.218	16.80425 - 16.80475	399.9 - 410	3345.8 - 3358	22010 - 23120
6.26775 - 6.26825	25.5 - 25.67	608 - 614	3500 - 4400	23600 - 24000
6.31175 - 6.31225	37.5 - 38.25	960 - 1427	4500 - 5150	31200 - 31800
8.291 - 8.294	73 - 74.6	1435 - 1626.5	5350 - 5460	36430 - 36500
8.362 - 8.366	74.8 - 75.2	1645.5 - 1646.5	7250 - 7750	Above 38600

TEST SETUP

Below 30 MHz

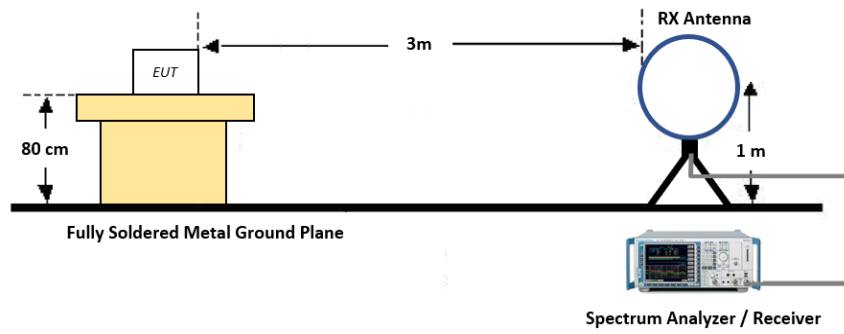

30 MHz - 1 GHz

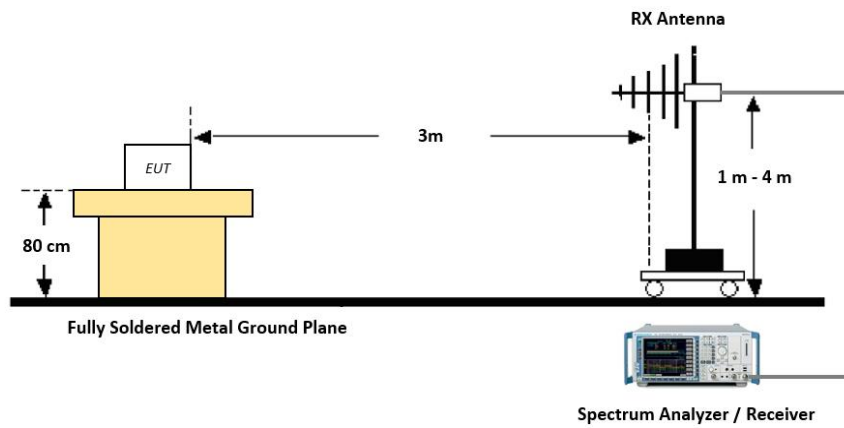

Above 1 GHz

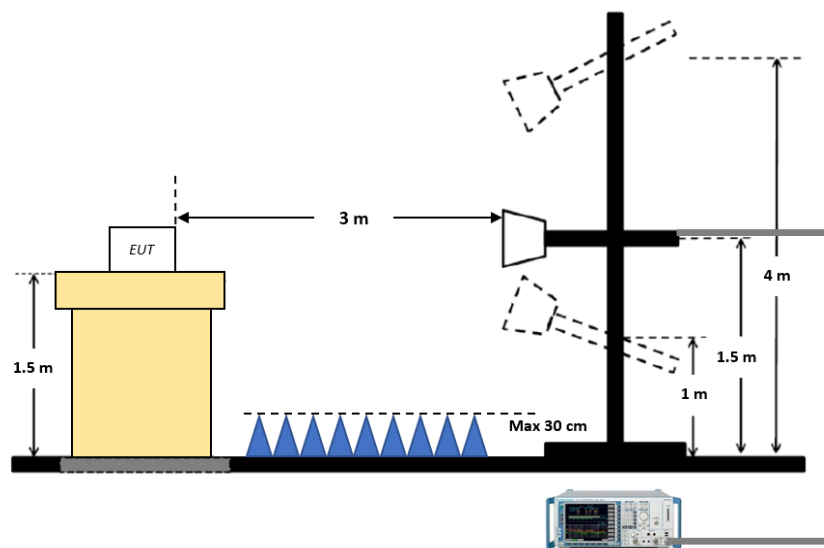

TEST PROCEDURE OF RADIATED SPURIOUS EMISSION (BELOW 30 MHz)

1. The EUT was placed on a non-conductive table located on semi-anechoic chamber.
2. The loop antenna was placed at a location 3m from the EUT
3. The EUT is placed on a turntable, which is 0.8m above ground plane.
4. We have done x, y, z planes in EUT and horizontal and vertical polarization in detecting antenna.
5. The turntable shall be rotated for 360 degrees to determine the position of maximum emission level.
6. Distance Correction Factor (0.009 MHz – 0.490 MHz) = $40 \cdot \log(3 \text{ m}/300 \text{ m}) = - 80 \text{ dB}$
Measurement Distance: 3 m
7. Distance Correction Factor (0.490 MHz – 30 MHz) = $40 \cdot \log(3 \text{ m}/30 \text{ m}) = - 40 \text{ dB}$
Measurement Distance: 3 m
8. Spectrum Setting
 - Frequency Range = 9 kHz ~ 30 MHz
 - Detector = Peak
 - Trace = Max hold
 - RBW = 9 kHz
 - VBW $\geq 3 \cdot \text{RBW}$
9. Total = Reading Value + Antenna Factor (A.F) + Cable Loss (C.L)
10. There is a comparison data both open-field test site and alternative test site – semi-Anechoic chamber according to 414788 D01. And the results are properly calibrated.

TEST PROCEDURE OF RADIATED SPURIOUS EMISSION (30 MHz – 1 GHz)

1. The EUT was placed on a non-conductive table located on semi-anechoic chamber.
2. The EUT is placed on a turntable, which is 0.8 m above ground plane.
3. We have done x, y, z planes in EUT and horizontal and vertical polarization in detecting antenna.
4. The turntable shall be rotated for 360 degrees to determine the position of maximum emission level.
5. Spectrum Setting
 - (1) Measurement Type (Peak):
 - Measured Frequency Range: 30 MHz – 1 GHz
 - Detector = Peak
 - Trace = Max hold
 - RBW = 100 kHz
 - VBW $\geq 3 \cdot \text{RBW}$
 - (2) Measurement Type(Quasi-peak):
 - Measured Frequency Range: 30 MHz – 1 GHz
 - Detector = Quasi-Peak
 - RBW = 120 kHz
6. Total = Reading Value + Antenna Factor (A.F) + Cable Loss (C.L)

TEST PROCEDURE OF RADIATED SPURIOUS EMISSION (ABOVE 1 GHz)

1. The EUT is placed on a turntable, which is 1.5 m above ground plane.
2. We have done x, y, z planes in EUT and horizontal and vertical polarization in detecting antenna.
3. The turntable shall be rotated for 360 degrees to determine the position of maximum emission level.
4. EUT is set 3 m away from the receiving antenna, which is varied from 1m to 4m to find out the highest emissions.
5. Maximum procedure was performed on the six highest emissions to ensure EUT compliance.
6. Each emission was to be maximized by changing the polarization of receiving antenna both horizontal and vertical.
7. The unit was tested with its standard battery.
8. Spectrum Setting

(1) Measurement Type(Peak, G.5 in KDB 789033 v02r01):

- RBW = 1 MHz
- VBW \geq 3 MHz
- Detector = Peak
- Sweep Time = auto
- Trace mode = Max hold
- Allow sweeps to continue until the trace stabilizes.
- Note that if the transmission is not continuous, the time required for the trace to stabilize will increase by a factor of approximately $1/x$, where x is the duty cycle.

(2) Measurement Type(Average, G.6.d in KDB 789033 v02r01):

- RBW = 1 MHz
- VBW(Duty cycle \geq 98 percent) = $VBW \leq RBW/100$ (i.e., 10 kHz) but not less than 10 Hz.
- VBW(Duty cycle is < 98 percent) = $VBW \geq 1/T$, where T is the minimum transmission duration.
- The analyzer is set to linear detector mode.
- Detector = Peak.
- Sweep time = auto.
- Trace mode = Max hold.
- Allow max hold to run for at least 50 traces if the transmitted signal is continuous or has at least 98 percent duty cycle. For lower duty cycles, increase the minimum number of traces by a factor of $1/x$, where x is the duty cycle.

9. Measurement value only up to 6 maximum emissions noted or would be lesser if no specific emissions from the EUT are recorded (i.e.: margin > 20 dB from the applicable limit) and considered that's already beyond the background noise floor
10. Measuring frequencies from 1 GHz to the 10th harmonic of highest fundamental frequency (or 40 GHz whichever comes first)
11. Sample Calculation

(1) Total (Peak) = Reading Value + Antenna Factor(A.F) + Cable Loss(C.L) - Amp Gain(G)

(2) Total (Average, Duty \geq 98%) = Reading Value + Antenna Factor(A.F) + Cable Loss(C.L) - Amp Gain(G)

(3) Total (Average, Duty < 98%) = Reading Value + Antenna Factor(A.F) + Cable Loss(C.L) - Amp Gain(G) + Duty Cycle Factor

TEST PROCEDURE OF RADIATED RESTRICTED BAND EDGE

1. Radiated test is performed with hopping off (if there is any)
2. The EUT is placed on a turntable, which is 1.5 m above ground plane.
3. We have done x, y, z planes in EUT and horizontal and vertical polarization in detecting antenna.
4. The turntable shall be rotated for 360 degrees to determine the position of maximum emission level.
5. EUT is set 3 m away from the receiving antenna, which is varied from 1m to 4m to find out the highest emissions.
6. Each emission was to be maximized by changing the polarization of receiving antenna both horizontal and vertical.
7. The unit was tested with its standard battery.
8. Spectrum Setting

(1) Measurement Type(Peak, G.5 in KDB 789033 v02r01):

- RBW = 1 MHz
- VBW \geq 3 MHz
- Detector = Peak
- Sweep Time = auto
- Trace mode = Max hold
- Allow sweeps to continue until the trace stabilizes.
- Note that if the transmission is not continuous, the time required for the trace to stabilize will increase by a factor of approximately $1/x$, where x is the duty cycle.

(2) Measurement Type(Average, G.6.d in KDB 789033 v02r01):

- RBW = 1 MHz
- VBW(Duty cycle \geq 98 percent) = VBW \leq RBW/100(i.e., 10 kHz) but not less than 10 Hz.
- VBW(Duty cycle is < 98 percent) = VBW \geq $1/T$, where T is the minimum transmission duration.
- The analyzer is set to linear detector mode.
- Detector = Peak.
- Sweep time = auto.
- Trace mode = Max hold.
- Allow max hold to run for at least 50 traces if the transmitted signal is continuous or has at least 98 percent duty cycle. For lower duty cycles, increase the minimum number of traces by a factor of $1/x$, where x is the duty cycle.

9. Sample Calculation

(1) Total (Peak) = Reading Value + Antenna Factor(A.F) + Cable Loss(C.L)

(2) Total (Average, Duty \geq 98%) = Reading Value + Antenna Factor(A.F) + Cable Loss(C.L) - Amp Gain(G)

(3) Total (Average, Duty < 98%) = Reading Value + Antenna Factor(A.F) + Cable Loss(C.L) - Amp Gain(G) + Duty Cycle Factor

8. SUMMARY OF TEST RESULTS

Test Description	FCC Part Section(s)	ISED Part Section(s)	Test Limit	Test Condition	Test Result
Radiated Spurious Emissions	§15.209	RSS-Gen, 8.9	cf. Section 7.1	Radiated	PASS

Note :

Per comparative test results in the evaluation report, all measurement data were reused on this report from the original FCC ID below.

FCC ID : 2ANI5SA300

WORST CASE CONFIGURATION

TEST MODE

Mode	Frequency (MHz)	Channel	Data Rate	PLS
WIFI 2.4 GHz	2412	1	1 Mbps	ATT 0
BLE (MCU)	2460	29	1 Mbps	4
BLE (MESH)	2474	36	1 Mbps	4

Note :

1. The selected channels are set as the maximum power for each modes
2. WIFI 2.4 GHz, BLE MCU and BLE MESH transmit simultaneously.

TEST CONFIGURATION

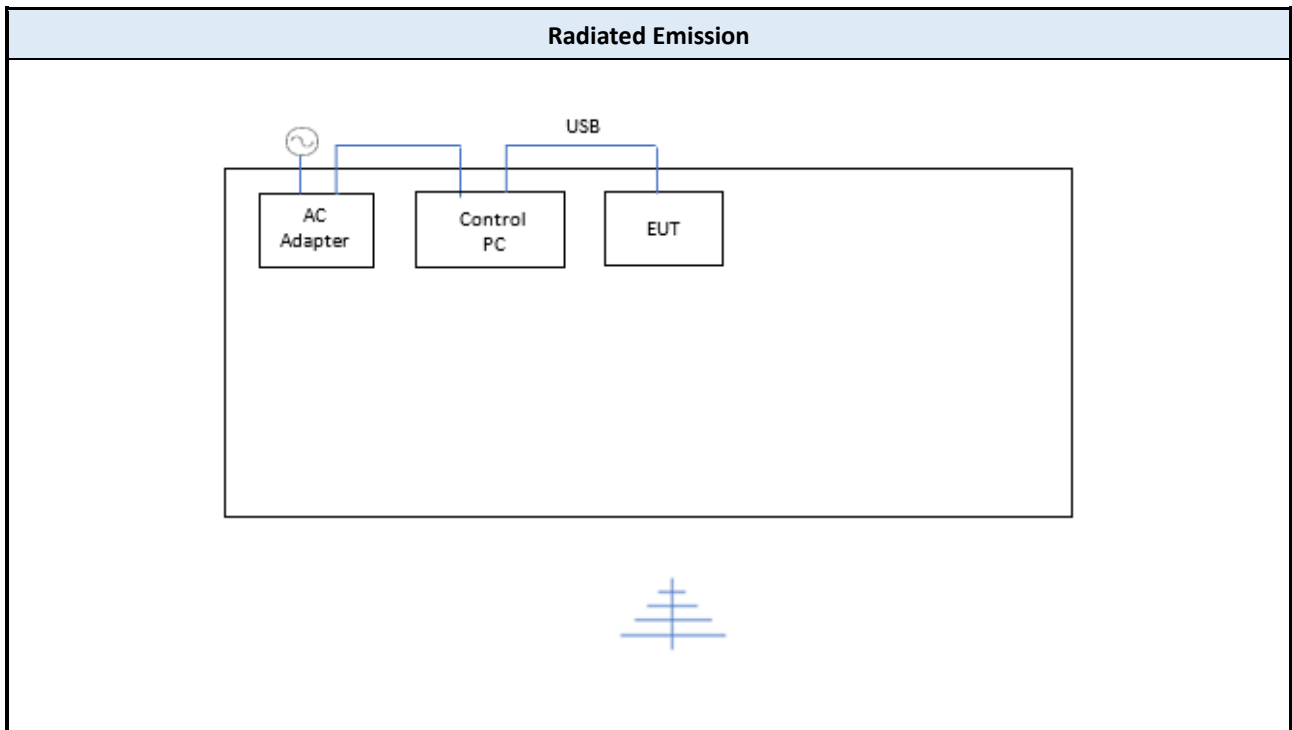

LIST OF SUPPORT EQUIPMENT

Equipment Type	Model No.	Serial Number	Manufacturer	Qty	Note
Laptop	T450	TA181240	Lenovo	1	-
AC Adapter	ADLX65SDC2A	36200350	Delta	1	100-240 VAC, 1.5A 50-60Hz (20 VDC)

9. TEST RESULT

9.1 RADIATED SPURIOUS EMISSIONS

Test Mode 802.11b + BLE 1M (MCU) + BLE 1M (MESH)
 Operating Frequency 2412 MHz (CH 1) + 2460 MHz (CH 29) + 2474 MHz (CH 36)

Frequency Range : Below 1 GHz

Frequency (MHz)	Polarization	Reading (dBuV)	Corr. ¹⁾ (dB)	Total (dBuV/m)	Limit (dBuV/m)	Margin (dB)	Measurement Type
35.902	V	38.5	-3.9	34.6	40	5.4	QP
48.078	V	45.7	-12.2	33.5	40	6.5	QP
59.847	V	51.9	-13.1	38.8	40	1.2	QP
72.179	V	46.3	-12.5	33.8	40	6.2	QP
95.765	H	44.3	-11.5	32.8	43.5	10.7	QP
432.802	H	41.0	-3.5	37.5	46	8.5	QP
432.802	V	41.1	-3.5	37.6	46	8.4	QP

Frequency Range : Above 1 GHz

Frequency (MHz)	Polarization	Reading (dBuV)		Factor (dB)		Level (dBuV/m)		Limit (dBuV/m)		Margin (dB)	
		AV	PK	Corr. ¹⁾	Duty	AV	PK	AV	PK	AV	PK
1596.140	V	37.1	66.0	-14.0	-	23.1	52.0	54	74	30.9	22.0
1597.510	H	36.6	65.0	-14.0	-	22.6	51.0	54	74	31.4	23.0
2349.939	V	45.7	61.6	-11.5	3.1	37.3	50.1	54	74	16.7	23.9
2350.000	H	45.9	61.8	-11.5	3.1	37.5	50.3	54	74	16.5	23.7
3215.943	H	54.9	57.5	-9.0	-	45.9	48.5	54	74	8.1	25.5
3215.961	V	54.9	57.5	-9.0	-	45.9	48.5	54	74	8.1	25.5
4824.006	V	50.2	67.5	-6.1	3.1	47.2	61.4	54	74	6.8	12.6
4824.012	H	50.0	67.6	-6.1	3.1	47.0	61.5	54	74	7.0	12.5
4920.164	V	47.4	59.6	-5.7	- ³⁾	41.7	53.9	54	74	12.3	20.1
4920.664	H	47.5	60.8	-5.7	- ³⁾	41.8	55.1	54	74	12.2	18.9
7379.692	V	40.0	51.7	-0.2	- ³⁾	39.8	51.5	54	74	14.2	22.5
7380.780	H	39.7	50.9	-0.2	- ³⁾	39.5	50.7	54	74	14.5	23.3
7421.687	V	41.6	53.8	-0.2	- ³⁾	41.4	53.6	54	74	12.6	20.4
7421.908	H	41.6	54.0	-0.2	- ³⁾	41.4	53.8	54	74	12.6	20.2

Note :

1. Correction Factor: Antenna Factor + Cable loss + Pre-amplifier Gain
2. AV Level = Measured Power(dBm) + Correction Factor(dB) + Duty Cycle Factor(dB).
3. BLE is set to transmit continuously with 100 % duty cycle.

▣ TEST PLOTS

Radiated Spurious Emission 9 kHz – 30 MHz (Antenna Position 90°)

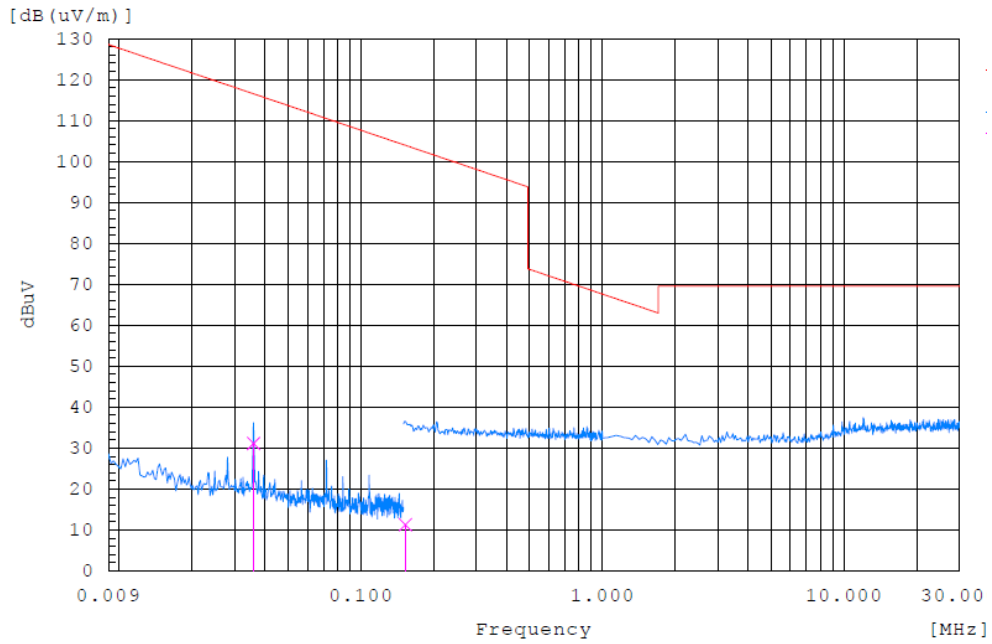

Radiated Spurious Emission 9 kHz – 30 MHz (Antenna Position 180°)

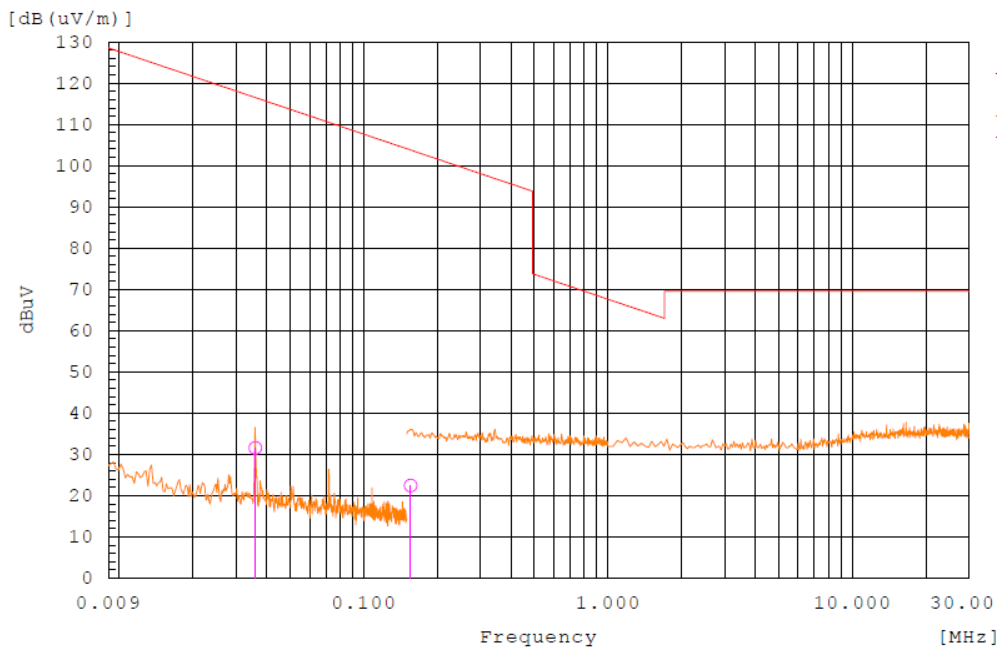

▣ TEST PLOTS (Continued)

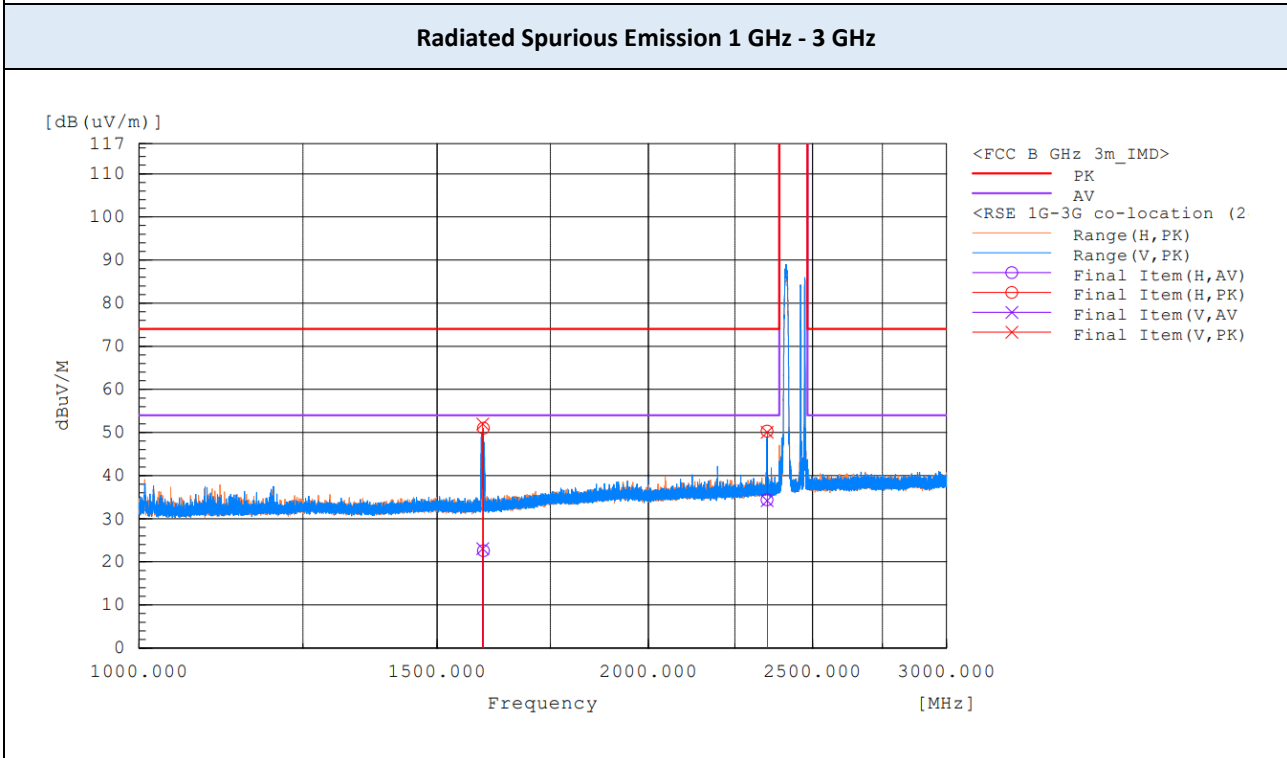
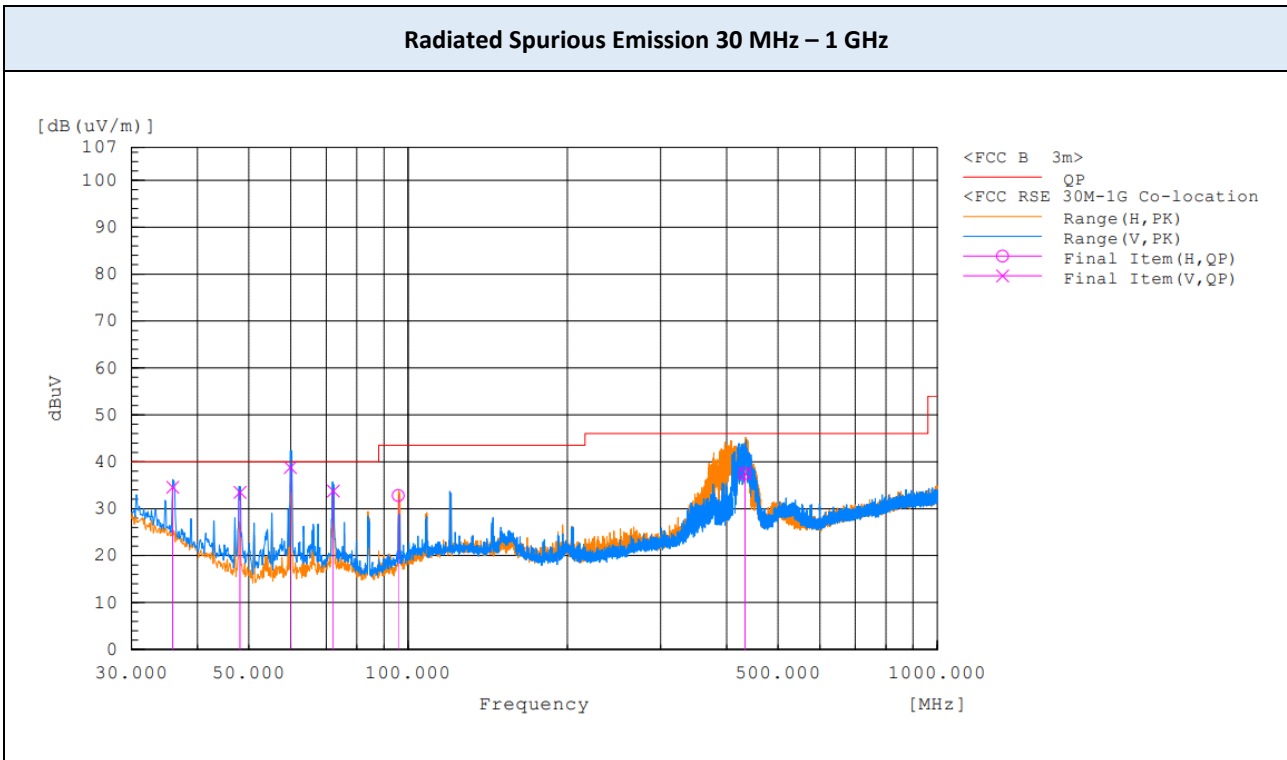

▣ TEST PLOTS (Continued)

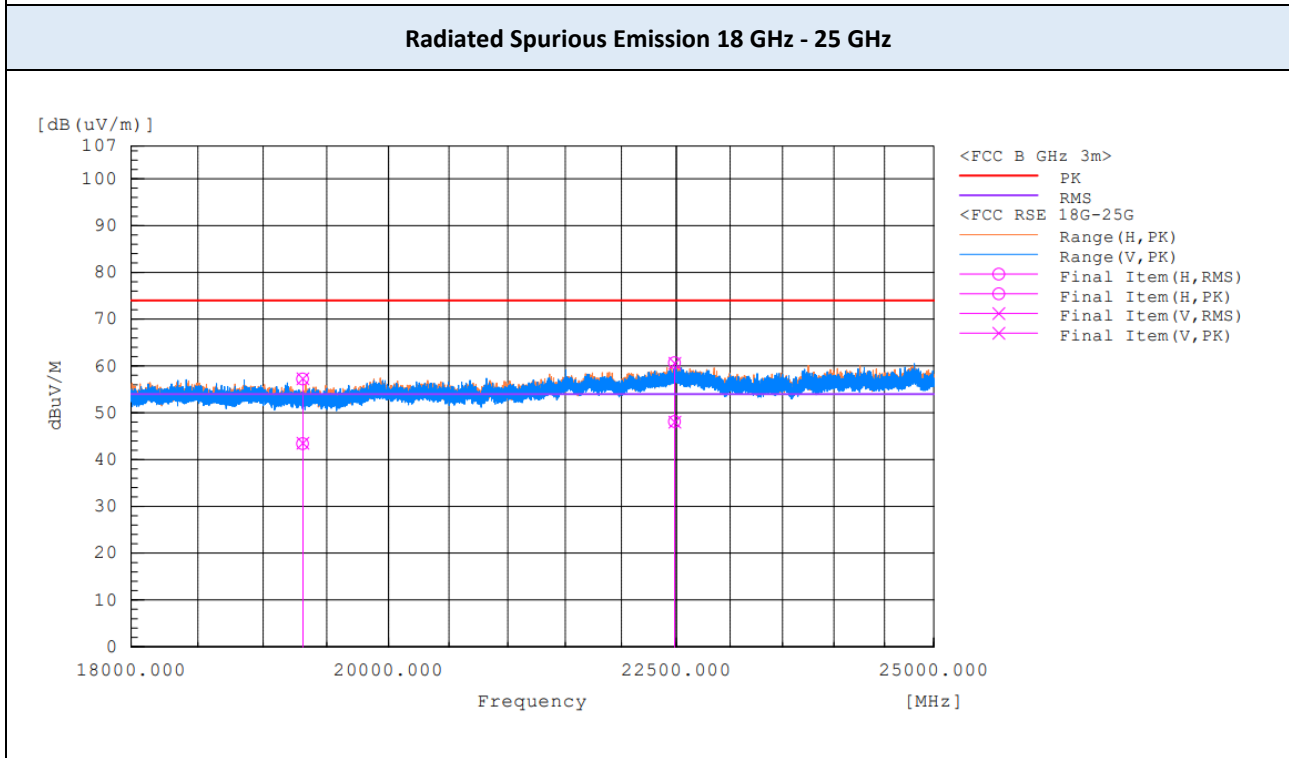
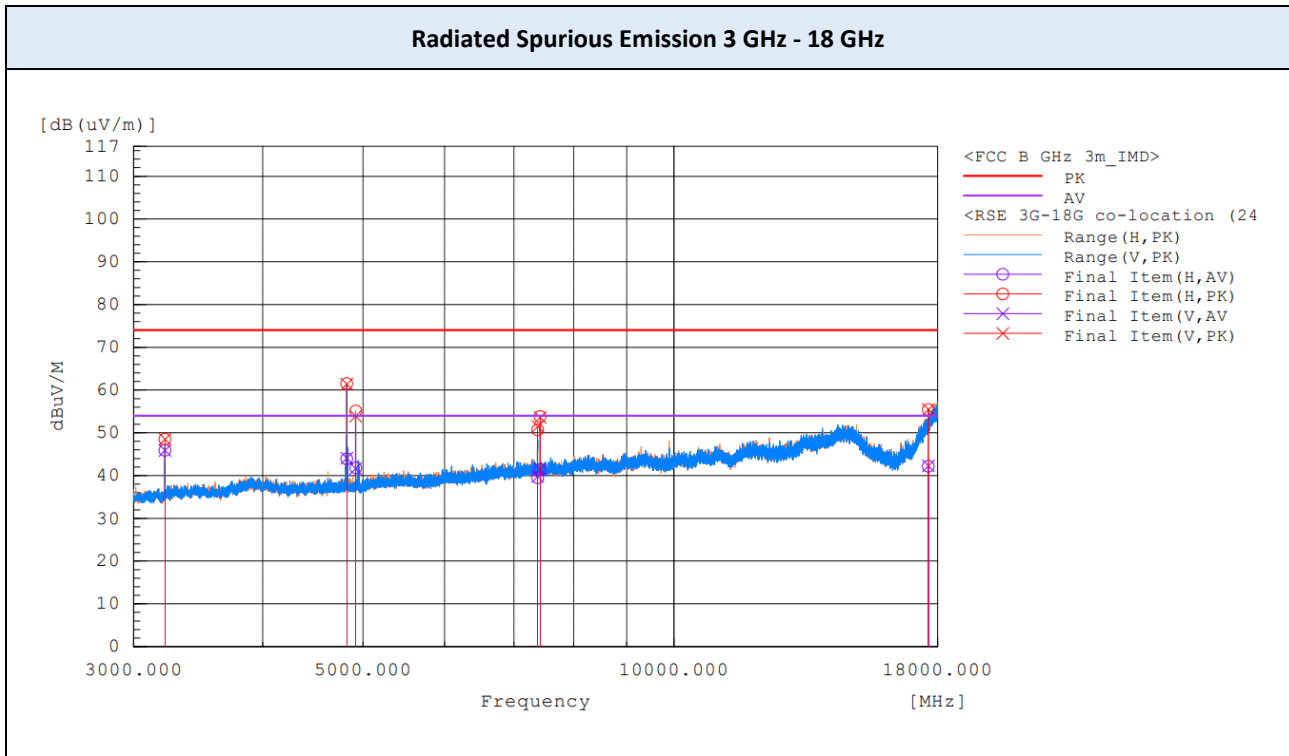

10. LIST OF TEST EQUIPMENT

No.	Instrument	Model No.	Calibration Due (mm/dd/yy)	Manufacture	Serial No.
<input checked="" type="checkbox"/>	Signal Analyzer (20 Hz ~ 40.0 GHz)	ESU40	12/03/2022	Rohde & Schwarz	100529
<input checked="" type="checkbox"/>	Signal Analyzer (1 Hz ~ 40.0 GHz)	ESW44	10/25/2023	Rohde & Schwarz	102015
<input type="checkbox"/>	Signal Analyzer (10 Hz ~ 26.5 GHz)	N9020A	11/04/2022	Keysight	MY52091291
<input checked="" type="checkbox"/>	Loop Antenna (0.009 ~ 30 MHz)	HLA 6121	09/15/2023	TESEQ	43964
<input checked="" type="checkbox"/>	BI-LOG Antenna (30 MHz ~ 2 GHz)	JB1	04/16/2023	Sunol	A061416
<input checked="" type="checkbox"/>	LNA (30 MHz ~ 1GHz)	PAM-103	04/14/2023	Com-Power	18020254
<input checked="" type="checkbox"/>	Horn Antenna (1 GHz ~ 18 GHz)	DRH-118	10/21/2022	Sunol	A070516
<input checked="" type="checkbox"/>	LNA (1 GHz ~ 18 GHz)	PAM-118A	06/21/2023	Com-Power	18040074
<input checked="" type="checkbox"/>	Horn Antenna (18 GHz ~ 40 GHz)	DRH-1840	02/16/2023	Sunol	17121
<input checked="" type="checkbox"/>	LNA (18 GHz ~ 40 GHz)	CBL18405045-01	02/10/2023	CERNEX, Inc.	27973
<input checked="" type="checkbox"/>	High Pass Filter	WHK10-2520-3000-18000-40EF	01/13/2023	Wainwright	9
<input type="checkbox"/>	High Pass Filter	WHKX8-6090-7000-18000-40SS	01/13/2023	Wainwright	23
<input type="checkbox"/>	EMI Test Receiver	ESR3	12/03/2022	Rohde & Schwarz	102363
<input type="checkbox"/>	LISN	ENV216	01/19/2023	Rohde & Schwarz	101349

Note :

1. All the equipment listed above was properly calibrated before using for the test. Any equipment which is past due on calibration is used after calibration is completed or the equipment is used before calibration due.

APPENDIX A. TEST SETUP PHOTOS

The setup photos are provided as a separate document.

APPENDIX B. PHOTOGRAPHS OF EUT

B.1. EXTERNAL PHOTOS

The external photos are provided as a separate document.

B.2. INTERNAL PHOTOS

The internal photos are provided as a separate document.

END OF TEST REPORT